



FCC 47 CFR PART 15 SUBPART E

UNII

CERTIFICATION TEST REPORT

FOR

GSM/WCDMA/LTE Phone + BT/BLE, DTS/UNII a/b/g/n/ac and ANT+

MODEL NUMBER : SM-A505G/DS, SM-A505G

FCC ID: A3LSMA505G

REPORT NUMBER: 4788805370-E5V2

ISSUE DATE: FEB 13, 2019

Prepared for
SAMSUNG ELECTRONICS CO., LTD.
129 SAMSUNG-RO, YEONGTONG-GU, SUWON-SI,
GYEONGGI-DO, 16677, KOREA

Prepared by
UL Korea, Ltd.
26th floor, 152, Teheran-ro, Gangnam-gu Seoul, 06236, Korea

Suwon Test Site: UL Korea, Ltd. Suwon Laboratory
218 Maeyeong-ro, Yeongtong-gu,
Suwon-si, Gyeonggi-do, 16675, Korea
TEL: (031) 337-9902
FAX: (031) 213-5433



ACCREDITED*

Testing
Laboratory

TL-637

Revision History

<u>Rev.</u>	<u>Issue Date</u>	<u>Revisions</u>	<u>Revised By</u>
V1	02/08/19	Initial issue	Hoonpyo Lee
V2	02/13/19	Updated to address TCB's question	Hoonpyo Lee

TABLE OF CONTENTS

1. ATTESTATION OF TEST RESULTS	6
2. TEST METHODOLOGY	9
3. FACILITIES AND ACCREDITATION	9
4. CALIBRATION AND UNCERTAINTY	9
4.1. MEASURING INSTRUMENT CALIBRATION	9
4.2. SAMPLE CALCULATION	9
4.3. MEASUREMENT UNCERTAINTY.....	10
5. EQUIPMENT UNDER TEST	11
5.1. DESCRIPTION OF EUT	11
5.1. MAXIMUM OUTPUT POWER.....	11
5.2. DESCRIPTION OF AVAILABLE ANTENNAS	12
5.3. WORST-CASE CONFIGURATION AND MODE.....	12
5.4. DESCRIPTION OF TEST SETUP.....	13
6. TEST AND MEASUREMENT EQUIPMENT	15
7. SUMMARY TABLE	16
8. MEASUREMENT METHODS	17
9. REFERENCE MEASUREMENTS RESULTS	18
9.1. ON TIME AND DUTY CYCLE RESULTS.....	18
9.2. DUTY CYCLE PLOTS	18
9.3. 26 dB BANDWIDTH.....	20
9.3.1. 802.11a MODE IN THE 5.2 GHz BAND.....	21
9.3.2. 802.11n HT20 MODE IN THE 5.2 GHz BAND	21
9.3.3. 802.11n HT40 MODE IN THE 5.2 GHz BAND	21
9.3.4. 802.11ac VHT80 MODE IN THE 5.2 GHz BAND	21
9.3.5. 802.11a MODE IN THE 5.3 GHz BAND.....	22
9.3.6. 802.11n HT20 MODE IN THE 5.3 GHz BAND	22
9.3.7. 802.11n HT40 MODE IN THE 5.3 GHz BAND	22
9.3.8. 802.11ac VHT80 MODE IN THE 5.3 GHz BAND	22
9.3.9. 802.11a MODE IN THE 5.5 GHz BAND.....	23
9.3.10. 802.11n HT20 MODE IN THE 5.5 GHz BAND	23
9.3.11. 802.11n HT40 MODE IN THE 5.5 GHz BAND	23
9.3.12. 802.11ac VHT80 MODE IN THE 5.5 GHz BAND	23
9.3.13. 802.11a MODE IN THE 5.8 GHz BAND.....	24
9.3.14. 802.11n HT20 MODE IN THE 5.8 GHz BAND	24
9.3.15. 802.11n HT40 MODE IN THE 5.8 GHz BAND	24
9.3.1. 802.11ac VHT80 MODE IN THE 5.8 GHz BAND	24

9.3.2.	26 dB BANDWIDTH PLOTS	25
9.4.	99% BANDWIDTH.....	38
9.4.1.	802.11a MODE IN THE 5.2 GHz BAND.....	39
9.4.2.	802.11n HT20 MODE IN THE 5.2 GHz BAND	39
9.4.3.	802.11n HT40 MODE IN THE 5.2 GHz BAND	39
9.4.4.	802.11ac VHT80 MODE IN THE 5.2 GHz BAND	39
9.4.5.	802.11a MODE IN THE 5.3 GHz BAND	40
9.4.6.	802.11n HT20 MODE IN THE 5.3 GHz BAND	40
9.4.7.	802.11n HT40 MODE IN THE 5.3 GHz BAND	40
9.4.8.	802.11ac VHT80 MODE IN THE 5.3 GHz BAND	40
9.4.9.	802.11a MODE IN THE 5.5 GHz BAND.....	41
9.4.10.	802.11n HT20 MODE IN THE 5.5 GHz BAND	41
9.4.11.	802.11n HT40 MODE IN THE 5.5 GHz BAND	41
9.4.12.	802.11ac VHT80 MODE IN THE 5.5 GHz BAND	41
9.4.13.	802.11a MODE IN THE 5.8 GHz BAND.....	42
9.4.14.	802.11n HT20 MODE IN THE 5.8 GHz BAND	42
9.4.15.	802.11n HT40 MODE IN THE 5.8 GHz BAND	42
9.4.16.	802.11ac VHT80 MODE IN THE 5.8 GHz BAND	42
9.4.17.	99% BANDWIDTH PLOTS	43
10.	ANTENNA PORT TEST RESULTS	56
10.1.	6 dB BANDWIDTH	56
10.1.1.	802.11a MODE IN THE 5.8 GHz BAND.....	57
10.1.2.	802.11n HT20 MODE IN THE 5.8 GHz BAND	57
10.1.3.	802.11n HT40 MODE IN THE 5.8 GHz BAND	57
10.1.4.	802.11ac VHT80 MODE IN THE 5.8 GHz BAND	57
10.1.5.	6 dB BANDWIDTH PLOTS	58
10.2.	OUTPUT POWER AND PPSD	62
10.2.1.	802.11a MODE IN THE 5.2 GHz BAND.....	63
10.2.2.	802.11n HT20 MODE IN THE 5.2 GHz BAND	64
10.2.3.	802.11n HT40 MODE IN THE 5.2 GHz BAND	65
10.2.4.	802.11ac VHT80 MODE IN THE 5.2 GHz BAND	66
10.2.5.	802.11a MODE IN THE 5.3 GHz BAND.....	67
10.2.6.	802.11n HT20 MODE IN THE 5.3 GHz BAND	68
10.2.7.	802.11n HT40 MODE IN THE 5.3 GHz BAND	69
10.2.8.	802.11ac VHT80 MODE IN THE 5.3 GHz BAND	70
10.2.9.	802.11a MODE IN THE 5.5 GHz BAND.....	71
10.2.10.	802.11n HT20 MODE IN THE 5.5 GHz BAND	72
10.2.11.	802.11n HT40 MODE IN THE 5.5 GHz BAND	73
10.2.12.	802.11ac VHT40 MODE IN THE 5.5 GHz BAND	74
10.2.13.	802.11a MODE IN THE 5.8 GHz BAND.....	75
10.2.14.	802.11n HT20 MODE IN THE 5.8 GHz BAND	76
10.2.15.	802.11n HT40 MODE IN THE 5.8 GHz BAND	77
10.2.16.	802.11ac VHT80 MODE IN THE 5.8 GHz BAND	78
10.2.17.	802.11a MODE IN THE Straddle Channel	79
10.2.18.	802.11n HT20 MODE IN THE 5.8 GHz BAND	80
10.2.19.	802.11n HT40 MODE IN THE 5.8 GHz BAND	81
10.2.20.	802.11ac VHT80 MODE IN THE 5.8 GHz BAND	82
10.2.21.	OUTPUT POWER AND PPSD PLOTS	62

11. TRANSMITTER ABOVE 1 GHz.....	99
11.1. 5.2 GHz.....	101
11.1.1. TX Above 1GHz 802.11a MODE IN THE 5.2GHz BAND	101
11.1.2. TX Above 1GHz 802.11n HT20 MODE IN THE 5.2GHz BAND.....	109
11.1.3. TX Above 1GHz 802.11n HT40 MODE IN THE 5.2GHz BAND.....	117
11.1.4. TX Above 1GHz 802.11ac VHT80 MODE IN THE 5.2GHz BAND.....	123
11.2. 5.3 GHz.....	127
11.2.1. TX ABOVE 1 GHz 802.11a MODE IN THE 5.3 GHz BAND	127
11.2.2. TX ABOVE 1GHz 802.11n HT20 MODE IN THE 5.3GHz BAND.....	135
11.2.3. TX ABOVE 1GHz 802.11n HT40 MODE IN THE 5.3GHz BAND.....	143
11.2.4. TX Above 1GHz 802.11ac VHT80 MODE IN THE 5.3GHz BAND.....	149
11.3. 5.5-5.6 GHz.....	153
11.3.1. TX ABOVE 1 GHz 802.11a MODE IN THE 5.5 GHz BAND	153
11.3.2. TX ABOVE 1GHz 802.11n HT20 MODE IN THE 5.5GHz BAND.....	163
11.3.3. TX ABOVE 1GHz 802.11n HT40 MODE IN THE 5.5GHz BAND.....	173
11.3.4. TX ABOVE 1GHz 802.11ac VHT80 MODE IN THE 5.5GHz BAND.....	183
11.4. 5.8 GHz.....	191
11.4.1. TX ABOVE 1GHz 802.11a MODE IN THE 5.8GHz BAND	191
11.4.2. TX ABOVE 1GHz 802.11n HT20 MODE IN THE 5.8GHz BAND.....	201
11.4.3. TX ABOVE 1GHz 802.11n HT40 MODE IN THE 5.8GHz BAND.....	211
11.4.1. TX ABOVE 1GHz 802.11ac VHT80 MODE IN THE 5.8GHz BAND.....	219
12. WORST-CASE BELOW 1 GHz	225
13. AC POWER LINE CONDUCTED EMISSIONS.....	227
14. DYNAMIC FREQUENCY SELECTION.....	230
14.1. OVERVIEW.....	230
14.1.1. LIMITS.....	230
14.1.1. TEST AND MEASUREMENT SYSTEM.....	234
14.1.2. DESCRIPTION OF EUT	238
14.2. RESULTS FOR 20 MHz BANDWIDTH.....	239
14.2.1. TEST CHANNEL	239
14.2.2. RADAR WAVEFORM AND TRAFFIC.....	239
14.2.3. MOVE AND CLOSING TIME	241
14.3. RESULTS FOR 40 MHz BANDWIDTH.....	244
14.3.1. TEST CHANNEL	244
14.3.2. RADAR WAVEFORM AND TRAFFIC.....	244
14.3.3. OVERLAPPING CHANNEL TESTS.....	246
14.3.4. MOVE AND CLOSING TIME	246
14.4. RESULTS FOR 80 MHz BANDWIDTH.....	249
14.4.1. TEST CHANNEL	249
14.4.2. RADAR WAVEFORM AND TRAFFIC.....	249
14.4.3. OVERLAPPING CHANNEL TESTS.....	251
14.4.4. MOVE AND CLOSING TIME	251
15. SETUP PHOTOS.....	254

1. ATTESTATION OF TEST RESULTS

COMPANY NAME: SAMSUNG ELECTRONICS CO., LTD.
EUT DESCRIPTION: GSM/WCDMA/LTE Phone + BT/BLE, DTS/UNII a/b/g/n/ac and ANT+
MODEL NUMBER: SM-A505G/DS, SM-A505G
SERIAL NUMBER: R38KB0HB4SW, R38KB0HB56L (RADIATED, Original);
R38KB0HB5BP (CONDUCTED, Original)
R38KC05XLSN (RADIATED, Spot check)
DATE TESTED: JAN 17, 2019 - FEB 07, 2019 (Original)
JAN 30, 2019 – FEB 07, 2019 (Spot check)

APPLICABLE STANDARDS	
STANDARD	TEST RESULTS
CFR 47 Part 15 Subpart E	Pass

UL Korea, Ltd. tested the above equipment in accordance with the requirements set forth in the above standards. All indications of Pass/Fail in this report are opinions expressed by UL Korea, Ltd. based on interpretations and/or observations of test results. Measurement Uncertainties were not taken into account and are published for informational purposes only. The test results show that the equipment tested is capable of demonstrating compliance with the requirements as documented in this report.

Note: The results documented in this report apply only to the tested sample, under the conditions and modes of operation as described herein. This document may not be altered or revised in any way unless done so by UL Korea, Ltd. and all revisions are duly noted in the revisions section. Any alteration of this document not carried out by UL Korea, Ltd. will constitute fraud and shall nullify the document. This report must not be used by the client to claim product certification, approval, or endorsement by IAS, any agency of the Federal Government, or any agency of any government.

Approved & Released For
UL Korea, Ltd. By:

Tested By:



SungGil Park
Suwon Lab Engineer
UL Korea, Ltd.

Hoonpyo Lee
Suwon Lab Engineer
UL Korea, Ltd.

1.1. INTRODUCTION OF TEST DATA REUSE

This report referenced from the FCC ID: A3LSMA505GN NII WLAN(FCC CFR 47 Part 15). And the applicant takes full responsibility that the test data as referenced in this report represent compliance for this FCC ID.

1.2. DIFFERENCE

The FCC ID: A3LSMA505G shares the same enclosure and circuit board as FCC ID: A3LSMA505GN. The WLAN antennas and surrounding circuitry and layout are identical between these two units for re-used bands.

After confirming through preliminary radiated emissions that the performance of the FCC ID: A3LSMA505GN remains representative of FCC ID: A3LSMA505G. The test data of FCC ID: A3LSMA505GN being submitted for this application to cover WLAN features.

1.3. SPOT CHECK VERIFICATION DATA

Band	Test Item	Mode	Frequency	Test Limit	Original model	Spot check model	Deviation	Remark
					SM-A505GN/DS	SM-A505G/DS		
					FCC ID : A3LSMA505GN	FCC ID : A3LSMA505G		
UNII WLAN (5GHz)	Band Edge	802.11a	5180 MHz	54 dBuV/m	50.19 dBuV/m	50.85 dBuV/m	0.66 dB	
	RSE	802.11a	5200 MHz	68.2 dBuV/m	47.46 dBuV/m	45.74 dBuV/m	-1.72 dB	Noise Floor
	Band Edge	802.11n HT20	5320 MHz	54 dBuV/m	50.63 dBuV/m	48.68 dBuV/m	-1.95 dB	
	RSE	802.11ac VHT80	5290 MHz	68.2 dBuV/m	42.19 dBuV/m	40.95 dBuV/m	-1.24 dB	Noise Floor
	Band Edge	802.11ac VHT80	5530 MHz	68.2 dBuV/m	50.59 dBuV/m	49.07 dBuV/m	-1.52 dB	
	RSE	802.11n HT20	5500 MHz	68.2 dBuV/m	62.56 dBuV/m	61.23 dBuV/m	-1.33 dB	
	Band Edge	802.11n HT20	5825 MHz	-27 dBm	-31.70 dBm	-38.99 dBm	-7.29 dB	
	RSE	802.11ac VHT80	5775 MHz	68.2 dBuV/m	63.25 dBuV/m	61.47 dBuV/m	-1.78 dB	

Comparison of two models, upper deviation is within 3dB range and all test results are under FCC Technical Limits. Output power verification was performed for the spot check model, all conducted power test results were in the tune up tolerance range. Also deviation for maximum output power result is within upper 0.5dB range.

1.4. REFERENCE DETAIL

Reference application that contains the reused reference data.

Equipment Class	Reference FCC ID	Type Grant/Permissive Change	Reference Application	Folder Test/RF Exposure	Report Title / Section
PCE	A3LSMA505GN	Grant	4788805413-E1	Test	FCC Report WWAN / All sections
DTS	A3LSMA505GN	Grant	4788805413-E2	Test	FCC Report DTS WLAN / All sections
			4788805413-E3	Test	FCC Report BLE All sections
DSS	A3LSMA505GN	Grant	4788805413-E4	Test	FCC Report BT / All sections
NII	A3LSMA505GN	Grant	4788805413-E5	Test	FCC Report UNII WLAN / All sections
DXX	A3LSMA505GN	Grant	4788805413-E6	Test	FCC Report ANT+ / All sections

2. TEST METHODOLOGY

The tests documented in this report were performed in accordance with following methods.

1. FCC CFR 47 Part 2.
2. FCC CFR 47 Part 15.
3. KDB 789033 D02 General UNII Test Procedures New Rules v02r01
4. KDB 905462 D02 UNII DFS Compliance Procedures New Rules v02
5. KDB 905462 D03 UNII Clients Without Radar Detection New Rules v01r02
6. KDB 484596 D01 v01
7. ANSI C63.10-2013.

3. FACILITIES AND ACCREDITATION

The test sites and measurement facilities used to collect data are located at 218 Maeyeong-ro, Yeongtong-gu, Suwon-si, Gyeonggi-do, 16675, Korea. Line conducted emissions are measured only at the 218 address. The following table identifies which facilities were utilized for radiated emission measurements documented in this report. Specific facilities are also identified in the test results sections.

218 Maeyeong-ro	
<input checked="" type="checkbox"/>	Chamber 1
<input checked="" type="checkbox"/>	Chamber 2
<input type="checkbox"/>	Chamber 3

UL Korea, Ltd. is accredited by IAS, Laboratory Code TL-637. The full scope of accreditation can be viewed at <http://www.iasonline.org/PDF/TL/TL-637.pdf>.

4. CALIBRATION AND UNCERTAINTY

4.1. MEASURING INSTRUMENT CALIBRATION

The measuring equipment utilized to perform the tests documented in this report has been calibrated in accordance with the manufacturer's recommendations, and is traceable to recognized national standards.

4.2. SAMPLE CALCULATION

Where relevant, the following sample calculation is provided:

$$\begin{aligned} \text{Field Strength (dBuV/m)} &= \text{Measured Voltage (dBuV)} + \text{Antenna Factor (dB/m)} + \\ &\text{Cable Loss (dB)} - \text{Preamp Gain (dB)} \\ 36.5 \text{ dBuV} + 18.7 \text{ dB/m} + 0.6 \text{ dB} - 26.9 \text{ dB} &= 28.9 \text{ dBuV/m} \end{aligned}$$

4.3. MEASUREMENT UNCERTAINTY

Where relevant, the following measurement uncertainty levels have been estimated for tests performed on the apparatus:

PARAMETER	UNCERTAINTY
Conducted Disturbance, 0.15 to 30 MHz	2.32 dB
Radiated Disturbance, Below 1GHz	3.86 dB
Radiated Disturbance, Above 1 GHz	5.97 dB

Uncertainty figures are valid to a confidence level of 95%.

5. EQUIPMENT UNDER TEST

5.1. DESCRIPTION OF EUT

GSM/WCDMA/LTE Phone + BT/BLE, DTS/UNII a/b/g/n/ac and ANT+.
 This test report addresses the NII (UNII) operational mode.

5.1. MAXIMUM OUTPUT POWER

The transmitter has a maximum total conducted average output power as follows:

Frequency Range [MHz]	Mode	Output Power [dBm]	Output Power [mW]
5180 - 5240	802.11a	14.78	30.06
	802.11n HT20	15.15	32.73
5190 - 5230	802.11n HT40	11.62	14.52
5210	802.11ac VHT80	10.45	11.09
5260 - 5320	802.11a	10.01	10.02
	802.11n HT20	9.73	9.40
5270 - 5310	802.11n HT40	8.06	6.40
5290	802.11ac VHT80	7.20	5.25
5500 - 5720	802.11a	13.15	20.65
	802.11n HT20	12.83	19.19
5510 - 5710	802.11n HT40	10.14	10.33
5530 - 5690	802.11ac VHT80	8.85	7.67
5745 - 5825	802.11a	15.40	34.67
	802.11n HT20	14.70	29.51
5755 - 5795	802.11n HT40	13.88	24.43
5775	802.11ac VHT80	12.70	18.62

5.2. DESCRIPTION OF AVAILABLE ANTENNAS

The radio utilizes an internal antenna, with a maximum gain of:

Frequency Range [MHz]	Antenna Gain [dBi]
UNII 1 5150 – 5250	-3.57
UNII 2A 5250 – 5350	-2.01
UNII 2C 5470 – 5725	-1.41
UNII 3 5725 – 5850	-1.88

5.3. WORST-CASE CONFIGURATION AND MODE

Radiated emission below 1GHz and power line conducted emission were performed with the EUT set to transmit at the channel with highest output power as worst-case scenario.

Radiated emission above 1GHz was performed with the EUT set to transmit low/mid/high channels.

The fundamental of the EUT was investigated in three orthogonal orientations X,Y,Z, it was determined that the Y orientation was worst-case orientation; therefore, all final radiated testing was performed with the EUT in the Y orientation.

Based on the baseline scan, the worst-case data rates were:

802.11a mode: 6 Mbps

802.11n HT20 mode: MCS0

802.11n HT40 mode: MCS0

802.11ac VHT80mode: MCS0

Note : All radiated and power line conducted tests were performed connected with earphone and charger for evaluation of worst case mode.

5.4. DESCRIPTION OF TEST SETUP

SUPPORT EQUIPMENT

Support Equipment List				
Description	Manufacturer	Model	Serial Number	FCC ID
Charger	SAMSUNG	EP-TA200	R37KC3B01G0RC3	N/A
Data Cable	SAMSUNG	EP-D140AWE	N/A	N/A
Earphone	SAMSUNG	EHS61ASFWE	N/A	N/A

I/O CABLES

I/O Cable List						
Cable No	Port	# of identical ports	Connector Type	Cable Type	Cable Length (m)	Remarks
1	DC Power	1	Mini-USB	Shielded	1.2m	N/A
2	Audio	2	Mini-Jack	Unshielded	1.2m	N/A

TEST SETUP

The EUT is a stand-alone unit during the tests.
 Test software in hidden menu exercised the EUT to enable NII mode.

SETUP DIAGRAM FOR TESTS (CONDUCTED TEST SETUP)

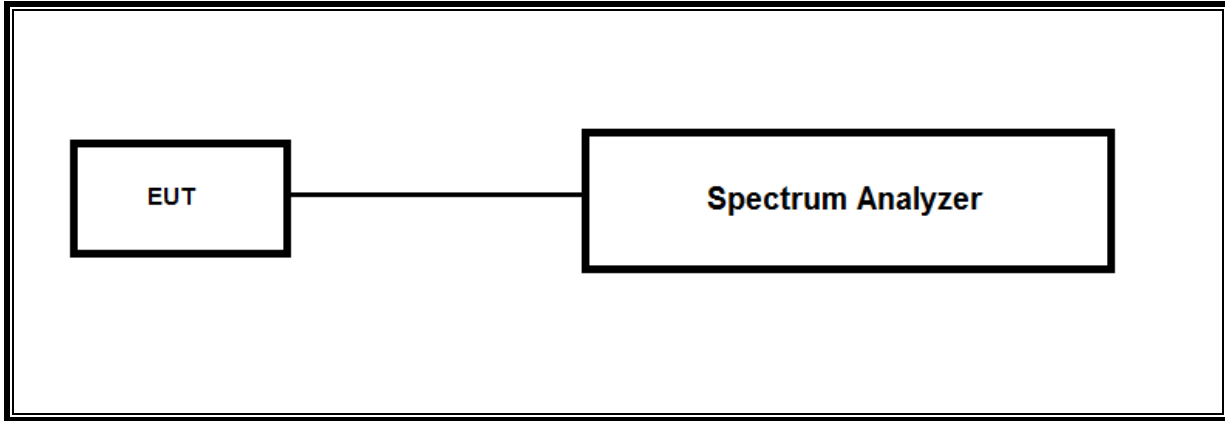

SETUP DIAGRAM FOR TESTS (RADIATED TEST SETUP)

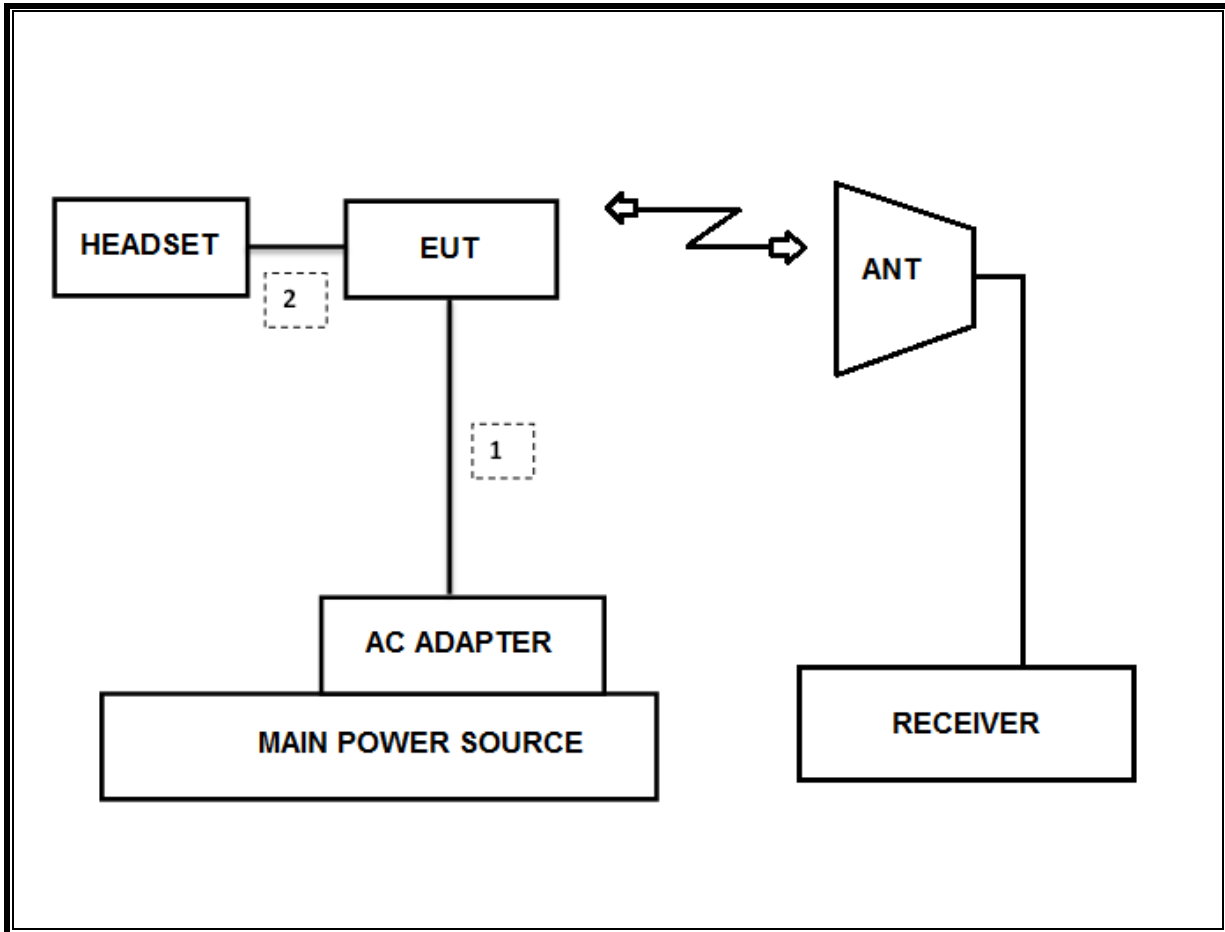

6. TEST AND MEASUREMENT EQUIPMENT

The following test and measurement equipment was utilized for the tests documented in this report:

Test Equipment List				
Description	Manufacturer	Model	S/N	New Cal Due
Antenna, Bilog, 30MHz-1GHz	SCHWARZBECK	VULB9163	750	08-04-20
Antenna, Bilog, 30MHz-1GHz	SCHWARZBECK	VULB9163	749	08-04-20
Antenna, Bilog, 30MHz-1GHz	SCHWARZBECK	VULB9163	845	08-04-20
Antenna, Horn, 18 GHz	ETS	3115	00167211	08-04-20
Antenna, Horn, 18 GHz	ETS	3115	00161451	08-04-20
Antenna, Horn, 18 GHz	ETS	3117	00168724	08-04-20
Antenna, Horn, 18 GHz	ETS	3117	00168717	08-04-20
Antenna, Horn, 18 GHz	ETS	3117	00205959	08-04-20
Antenna, Horn, 40 GHz	ETS	3116C	00166155	12-04-19
Antenna, Horn, 40 GHz	ETS	3116C	00168645	12-04-19
Antenna, Horn, 40 GHz	ETS	3116C-PA	00168841	08-09-19
Preamplifier, 1000 MHz	Sonoma	310N	341282	08-07-19
Preamplifier, 1000 MHz	Sonoma	310N	351741	08-07-19
Preamplifier, 1000 MHz	Sonoma	310N	370599	08-06-19
Preamplifier, 18 GHz	Miteq	AFS42-00101800-25-S-42	1876511	08-07-19
Preamplifier, 18 GHz	Miteq	AFS42-00101800-25-S-42	1896138	08-07-19
Preamplifier, 18 GHz	Miteq	AFS42-00101800-25-S-42	2029169	08-07-19
Spectrum Analyzer, 44 GHz	Agilent / HP	N9030A	MY54170614	08-07-19
Spectrum Analyzer, 44 GHz	Agilent / HP	N9030A	MY54490312	08-06-19
Spectrum Analyzer, 43.5 GHz	R&S	FSW43	104089	08-06-19
Average Power Sensor	Agilent / HP	U2000	MY54270007	08-07-19
Attenuator	PASTERNAK	PE7087-10	A001	08-08-19
Attenuator	PASTERNAK	PE7087-10	A008	08-08-19
Attenuator	PASTERNAK	PE7004-10	2	08-07-19
Attenuator	PASTERNAK	PE7087-10	A009	08-08-19
EMI Test Receive, 40 GHz	R&S	ESU40	100439	08-06-19
EMI Test Receive, 40 GHz	R&S	ESU40	100457	08-06-19
EMI Test Receive, 44 GHz	R&S	ESW44	101590	08-06-19
EMI Test Receive, 3 GHz	R&S	ESR3	101832	08-06-19
Low Pass Filter 5GHz	Micro-Tronics	LPS17541	009	08-07-19
Low Pass Filter 5GHz	Micro-Tronics	LPS17541	015	08-07-19
Low Pass Filter 5GHz	Micro-Tronics	LPS17541	020	08-06-19
High Pass Filter 3GHz	Micro-Tronics	HPM17543	010	08-07-19
High Pass Filter 3GHz	Micro-Tronics	HPM17543	015	08-07-19
High Pass Filter 3GHz	Micro-Tronics	HPM17543	020	08-06-19
High Pass Filter 6GHz	Micro-Tronics	HPS17542	009	08-07-19
High Pass Filter 6GHz	Micro-Tronics	HPS17542	016	08-07-19
High Pass Filter 6GHz	Micro-Tronics	HPS17542	021	08-06-19
Antenna, Loop, 9kHz-30MHz	R&S	HFH2-Z2	100418	10-26-19
LISN	R&S	ENV-216	101837	08-09-19
UL Software				
Description	Manufacturer	Model	Version	
Radiated software	UL	UL EMC	Ver 9.5	
AC Line Conducted software	UL	UL EMC	Ver 9.5	

7. SUMMARY TABLE

FCC Part Section	Test Description	Test Limit	Test Condition	Test Result
15.407(e)	6dB Band width (5.8Ghz)	500KHz	Condcuted	PASS
15.407 (a)(2)	TX Cond. Power 5.15-2.25, 5.25-5.35 & 5.47-5.725	<24dBm or 11+10Log(OBW)		PASS
15.407 (a)(3)	TX Cond. Power 5.725-5.825	< 30dBm or 17+10Log(OBW)		PASS
15.407 (a)(5)	PSD (5.2,5.3,5.5GHz)	<11dBm		PASS
15.407 (a)(5)	PSD (5.8GHz)	30dBm per 500kHz		PASS
15.207 (a)	AC Power Line conducted emissions	Section 10	Radiated	PASS
15.407 (b) & 15.209	Radiated Spurious Emission	< 54dBuV/m		PASS
15.407 (h)(2)	Dynamic Frequency Selection	N/A	Condcuted	PASS

8. MEASUREMENT METHODS

On-Time and Duty Cycle : KDB 789033 D02 v02r01, Section B.

6dB Emission BW : KDB 789033 D02 v02r01, Section C.2.

26dB Emission BW : KDB 789033 D02 v02r01, Section C.1.

99% Occupied BW : KDB 789033 D02 v02r01, Section D.

Conducted Output Power : KDB 789033 D02 v02r01, Section E.3.a(Method PM)

Power Spectral Density : KDB 789033 D02 v02r01, Section F.

Unwanted emissions in restricted bands : KDB 789033 D02 v02r01, Section G.

Unwanted emissions in non-restricted bands : KDB 789033 D02 v02r01, Section G.

AC Power Line Conducted Emission : ANSI C63.10-2013, Section 6.2.

9. REFERENCE MEASUREMENTS RESULTS

LIMITS

None; for reporting purposes only.

PROCEDURE

KDB 789033 D02 v02r01 Zero-Span Spectrum Analyzer Method.

9.1. ON TIME AND DUTY CYCLE RESULTS

Mode	ON Time B [msec]	Period [msec]	Duty Cycle x [linear]	Duty Cycle [%]	Duty Cycle Correction Factor [dB]	1/T Minimum VBW [kHz]
802.11a	2.736	2.800	0.977	97.7%	0.10	0.365
802.11n HT20	2.544	2.608	0.975	97.5%	0.11	0.393
802.11n HT40	1.244	1.335	0.932	93.2%	0.31	0.804
802.11ac VHT80	0.600	0.701	0.856	85.6%	0.67	1.666

9.2. DUTY CYCLE PLOTS

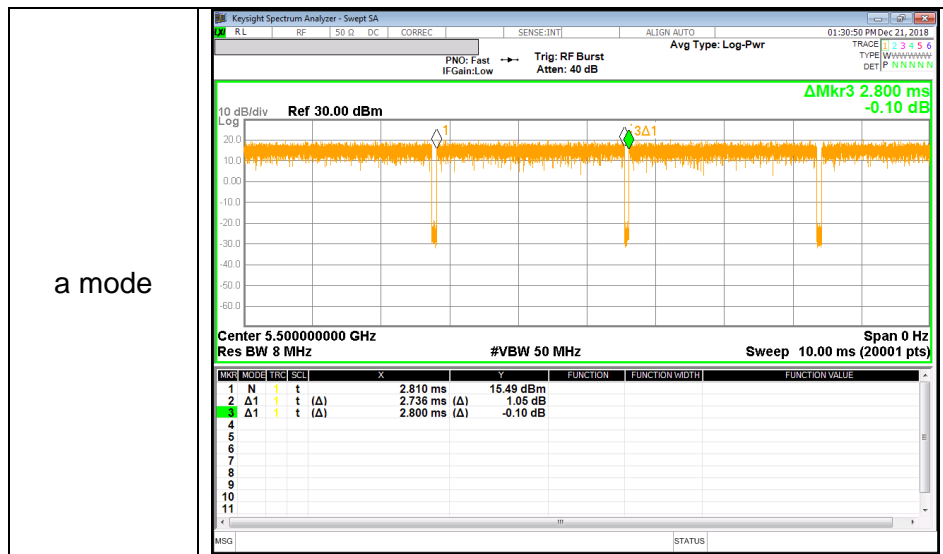

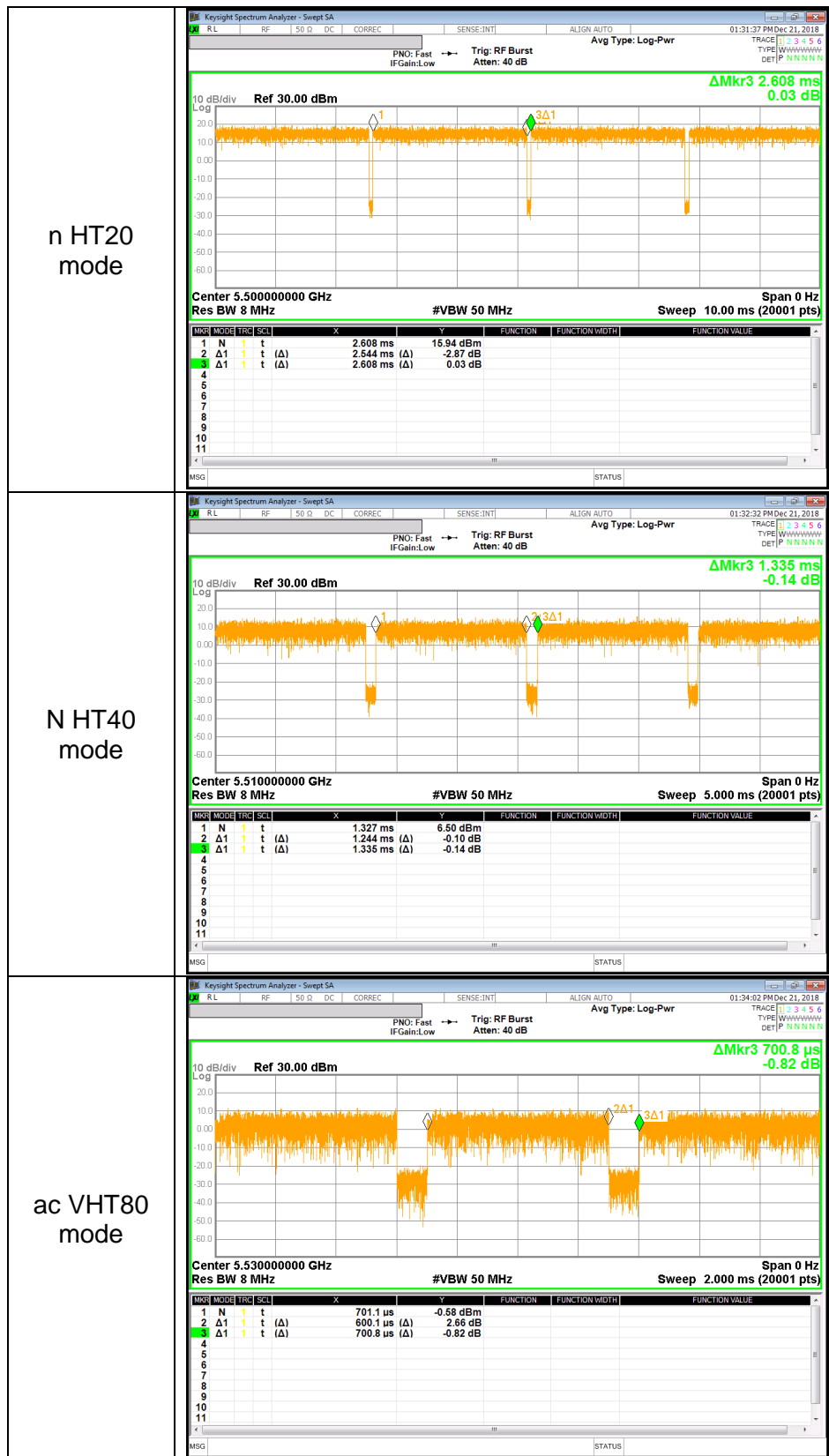

9.3. 26 dB BANDWIDTH

LIMITS

None; for reporting purposes only.

TEST PROCEDURE

Reference to 789033 D02 General UNII Test Procedures New Rules v01r03: The transmitter output is connected to a spectrum analyzer with the RBW set to approximately 1% of EBW, the VBW > RBW, peak detector and max hold.

NOTE

- Calculation for 26dB Bandwidth of UNII-2C and UNII-3 Straddle Channel
 - ex) Fundamental frequency : 5720MHz
 - 26dB BW : 20.58MHz
 - Turning Frequency : 5725MHz
 - 26dB Bandwidth of UNII-2C band Portion
= $(5725 - (5720 - (20.58 / 2))) = 15.29$ MHz
 - 26dB Bandwidth of UNII-3 band Portion
= $(5720 + (20.58 / 2) - 5725) = 5.29$ MHz

RESULTS

9.3.1. 802.11a MODE IN THE 5.2 GHz BAND

Channel	Frequency [MHz]	26 dB Bandwidth [MHz]
Low	5180	23.83
Mid	5200	23.27
High	5240	24.22
Worst		24.22

9.3.2. 802.11n HT20 MODE IN THE 5.2 GHz BAND

Channel	Frequency [MHz]	26 dB Bandwidth [MHz]
Low	5180	24.76
Mid	5200	21.70
High	5240	23.51
Worst		24.76

9.3.3. 802.11n HT40 MODE IN THE 5.2 GHz BAND

Channel	Frequency [MHz]	26 dB Bandwidth [MHz]
Low	5190	38.49
High	5230	39.17
Worst		39.17

9.3.4. 802.11ac VHT80 MODE IN THE 5.2 GHz BAND

Channel	Frequency [MHz]	26 dB Bandwidth [MHz]
Middle	5210	77.23
Worst		77.23

9.3.5. 802.11a MODE IN THE 5.3 GHz BAND

Channel	Frequency [MHz]	26 dB Bandwidth [MHz]
Low	5260	17.69
Mid	5300	18.04
High	5320	18.36
Worst		18.36

9.3.6. 802.11n HT20 MODE IN THE 5.3 GHz BAND

Channel	Frequency [MHz]	26 dB Bandwidth [MHz]
Low	5260	18.71
Mid	5300	18.68
High	5320	18.76
Worst		18.76

9.3.7. 802.11n HT40 MODE IN THE 5.3 GHz BAND

Channel	Frequency [MHz]	26 dB Bandwidth [MHz]
Low	5270	38.39
High	5310	38.35
Worst		38.39

9.3.8. 802.11ac VHT80 MODE IN THE 5.3 GHz BAND

Channel	Frequency [MHz]	26 dB Bandwidth [MHz]
Middle	5290	76.85
Worst		76.85

9.3.9. 802.11a MODE IN THE 5.5 GHz BAND

Channel	Frequency [MHz]	26 dB Bandwidth [MHz]
Low	5500	34.15
Mid	5580	34.09
High	5700	32.23
Straddle	5720	18.38
Worst		34.15

9.3.10. 802.11n HT20 MODE IN THE 5.5 GHz BAND

Channel	Frequency [MHz]	26 dB Bandwidth [MHz]
Low	5500	33.78
Mid	5580	33.62
High	5700	29.73
Straddle	5720	19.33
Worst		33.78

9.3.11. 802.11n HT40 MODE IN THE 5.5 GHz BAND

Channel	Frequency [MHz]	26 dB Bandwidth [MHz]
Low	5510	75.46
Mid	5590	44.17
High	5670	39.22
Straddle	5710	34.55
Worst		75.46

9.3.12. 802.11ac VHT80 MODE IN THE 5.5 GHz BAND

Channel	Frequency [MHz]	26 dB Bandwidth [MHz]
Low	5530	77.07
High	5610	76.88
Straddle	5690	73.45
Worst		77.07

9.3.13. 802.11a MODE IN THE 5.8 GHz BAND

Channel	Frequency [MHz]	26 dB Bandwidth [MHz]
Straddle	5720	8.38
Low	5745	35.05
Mid	5785	32.82
High	5825	31.28
Worst		35.05

9.3.14. 802.11n HT20 MODE IN THE 5.8 GHz BAND

Channel	Frequency [MHz]	26 dB Bandwidth [MHz]
Straddle	5720	9.33
Low	5745	34.65
Mid	5785	33.36
High	5825	30.72
Worst		34.65

9.3.15. 802.11n HT40 MODE IN THE 5.8 GHz BAND

Channel	Frequency [MHz]	26 dB Bandwidth [MHz]
Straddle	5710	4.55
Low	5755	74.30
High	5795	71.10
Worst		74.30

9.3.1. 802.11ac VHT80 MODE IN THE 5.8 GHz BAND

Channel	Frequency [MHz]	26 dB Bandwidth [MHz]
Straddle	5690	3.45
Middle	5775	120.40
Worst		120.40

9.3.2. 26 dB BANDWIDTH PLOTS

UNII 5.2 GHz IEEE 802.11a mode

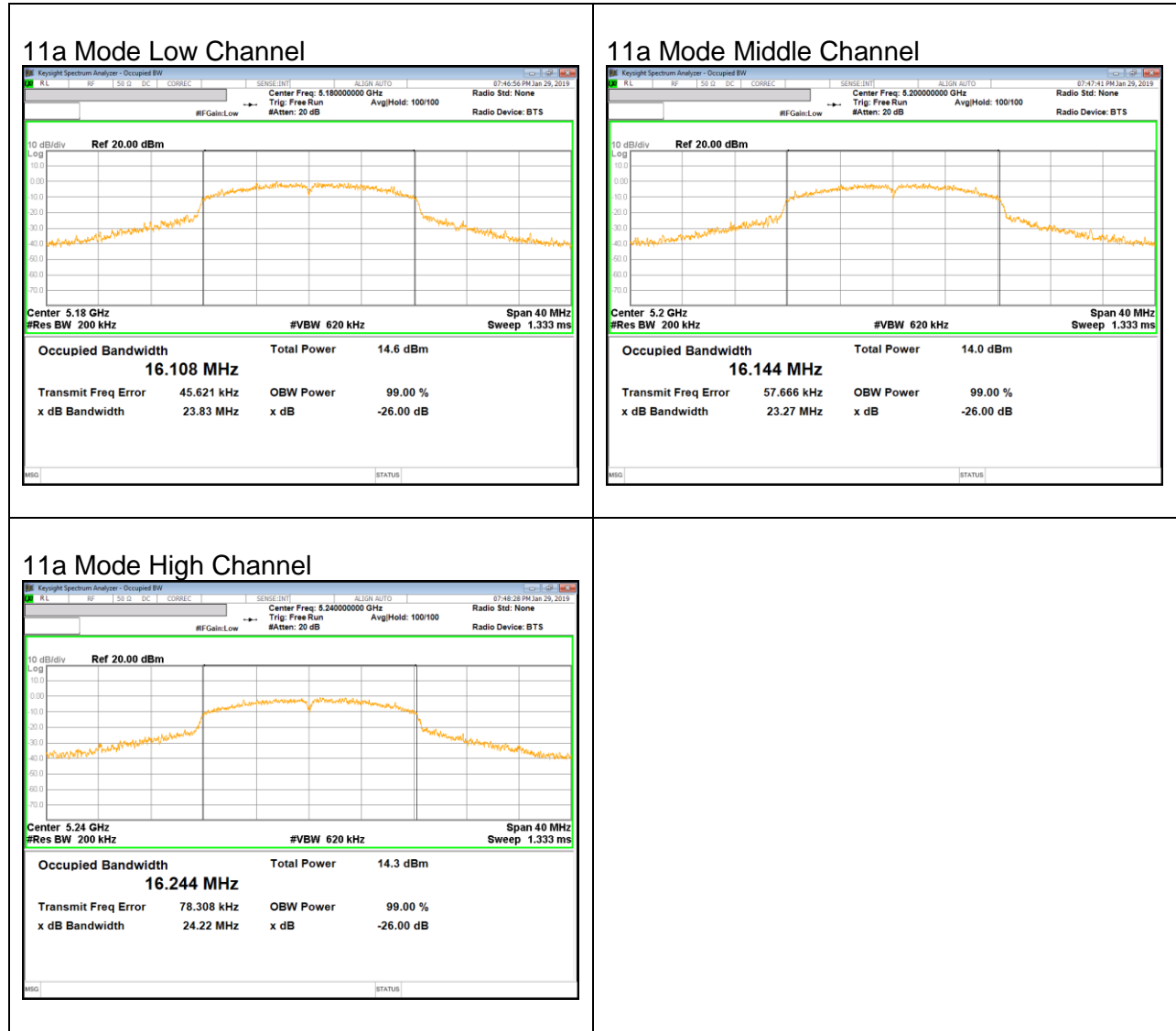

UNII 5.2 GHz IEEE 802.11n HT20 mode

11n HT20 Mode Low Channel

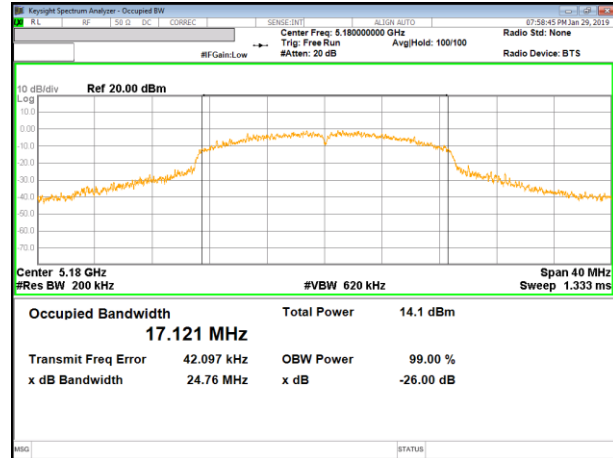

11n HT20 Mode Middle Channel

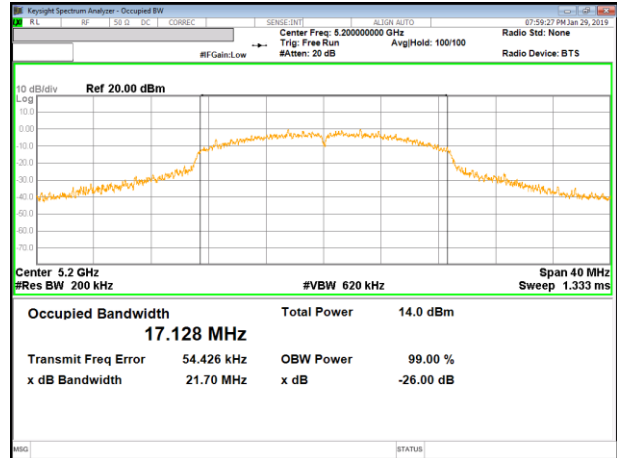

11n HT20 Mode High Channel

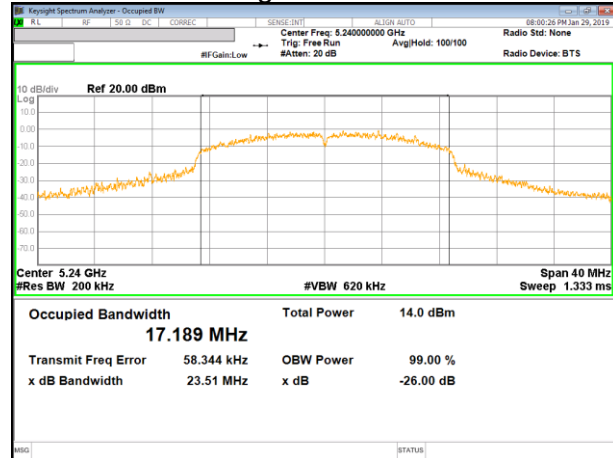

UNII 5.2 GHz IEEE 802.11n HT40 mode

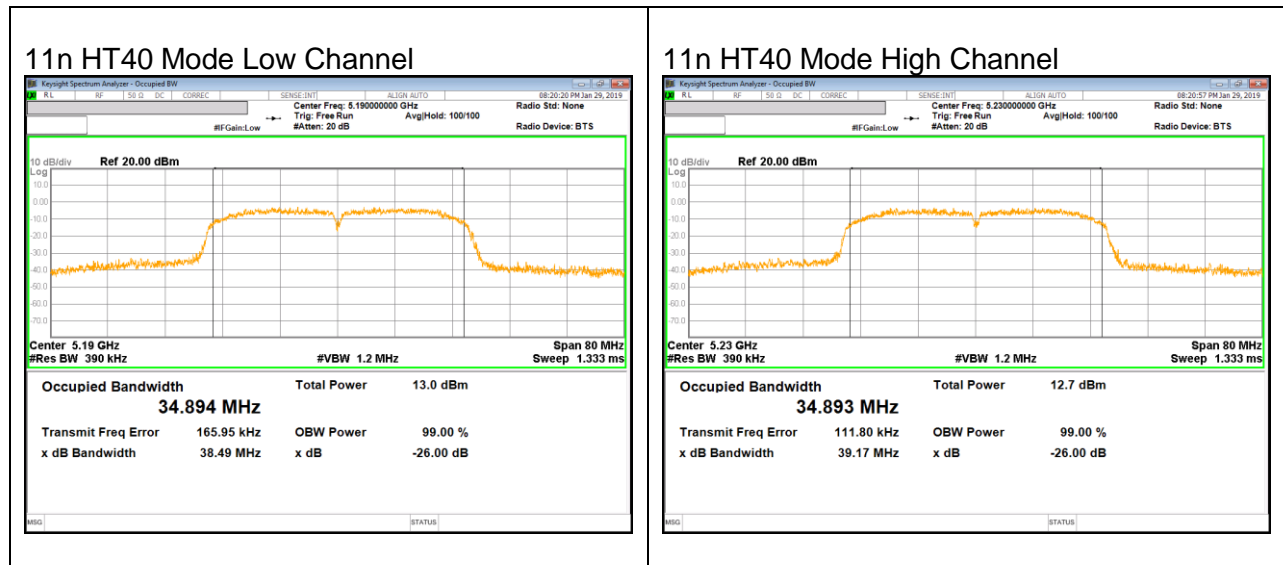

UNII 5.2 GHz IEEE 802.11ac VHT80 mode

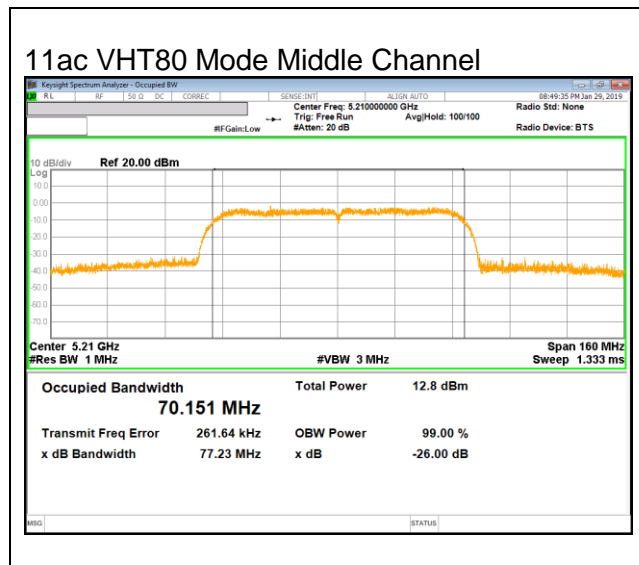

UNII 5.3 GHz IEEE 802.11a mode

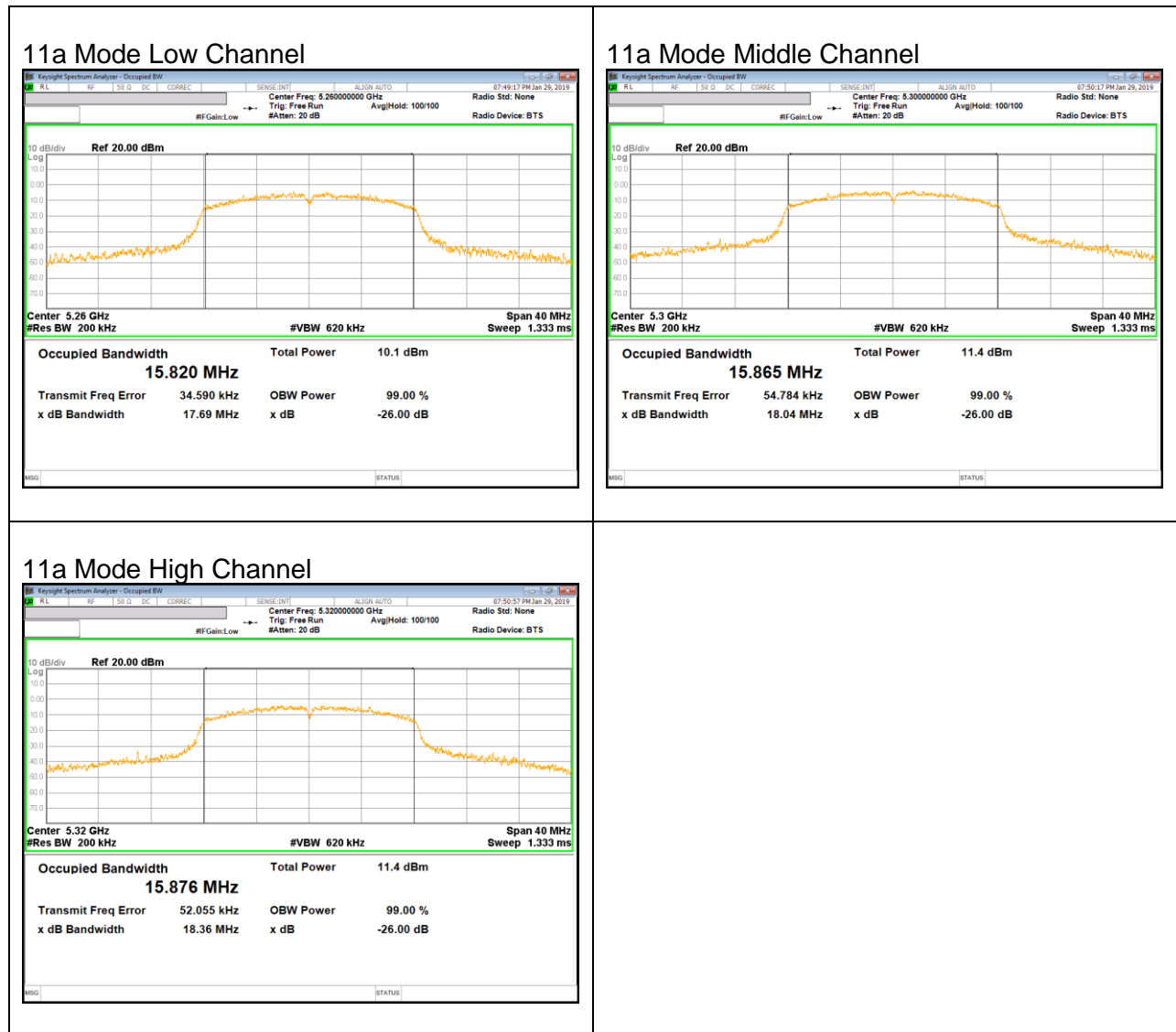

UNII 5.3 GHz IEEE 802.11n HT20 mode

11n HT20 Mode Low Channel

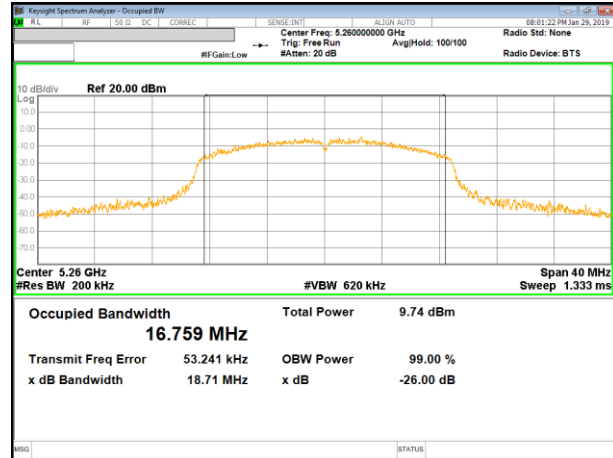

11n HT20 Mode Middle Channel

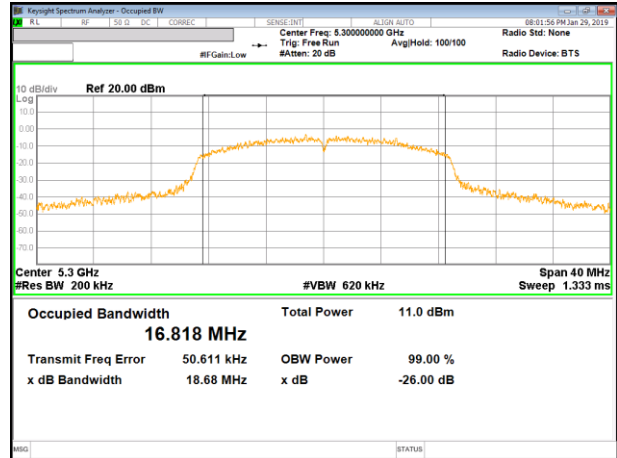

11n HT20 Mode High Channel

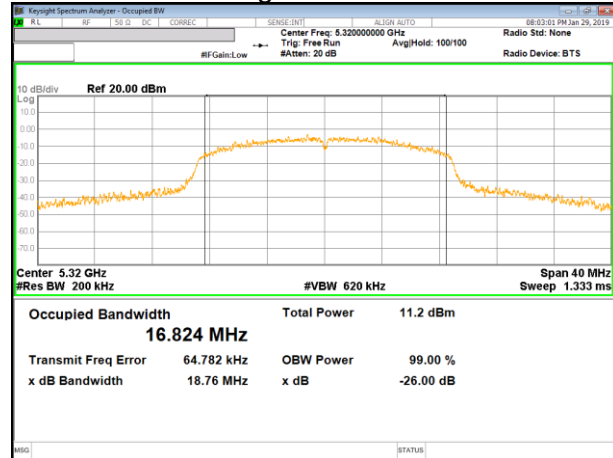

UNII 5.3 GHz IEEE 802.11n HT40 mode

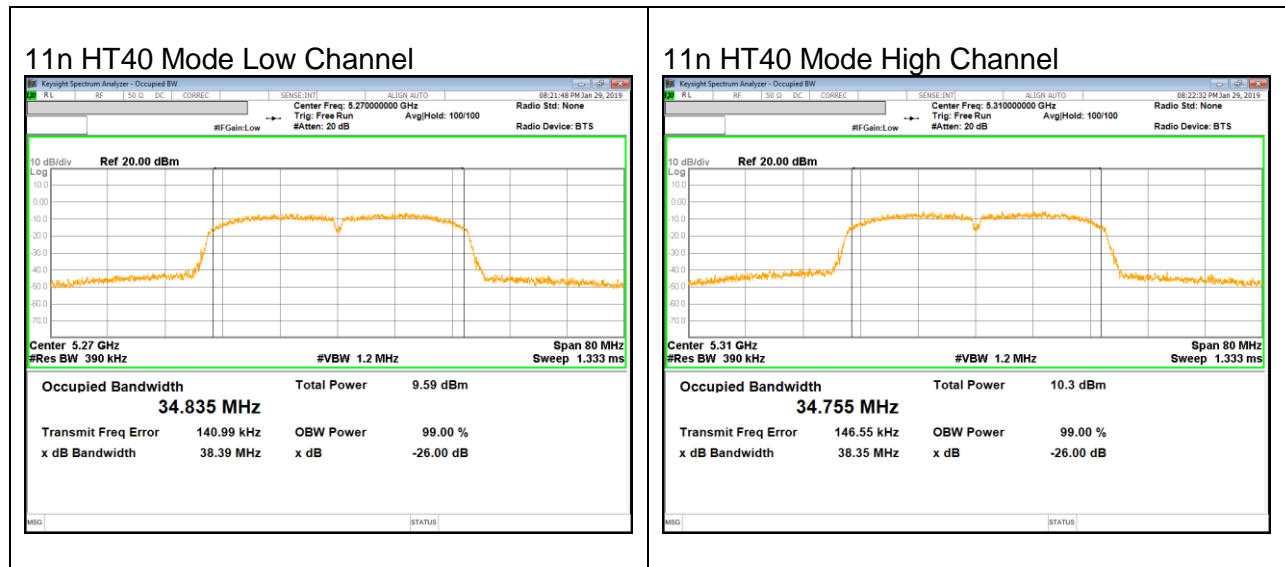

UNII 5.3 GHz IEEE 802.11ac VHT80 mode

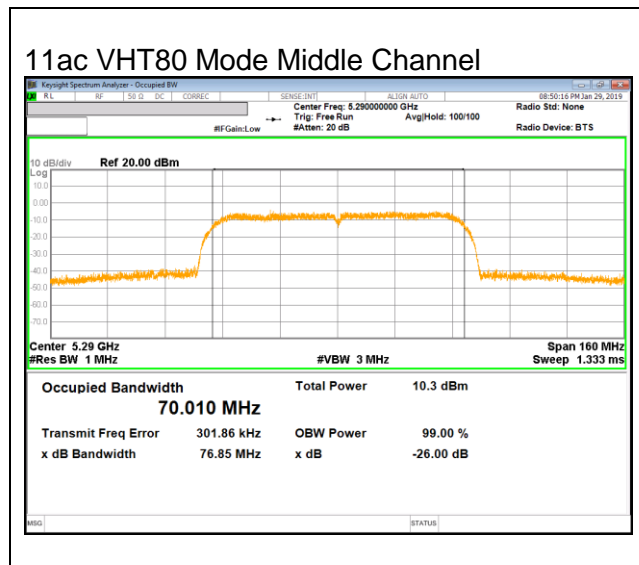

UNII 5.5 GHz IEEE 802.11a mode



UNII 5.5 GHz IEEE 802.11n HT20 mode

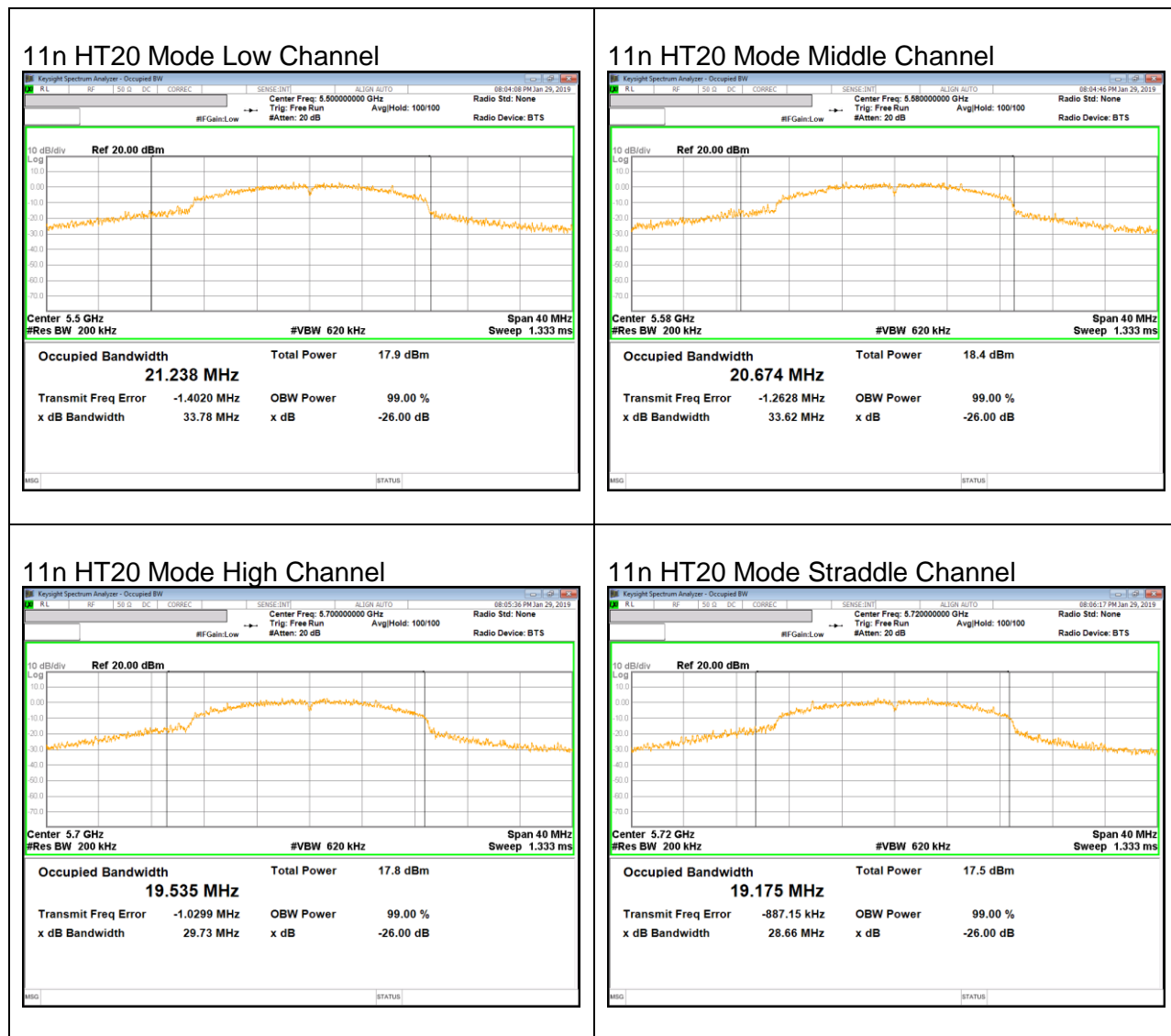

UNII 5.5 GHz IEEE 802.11n HT40 mode

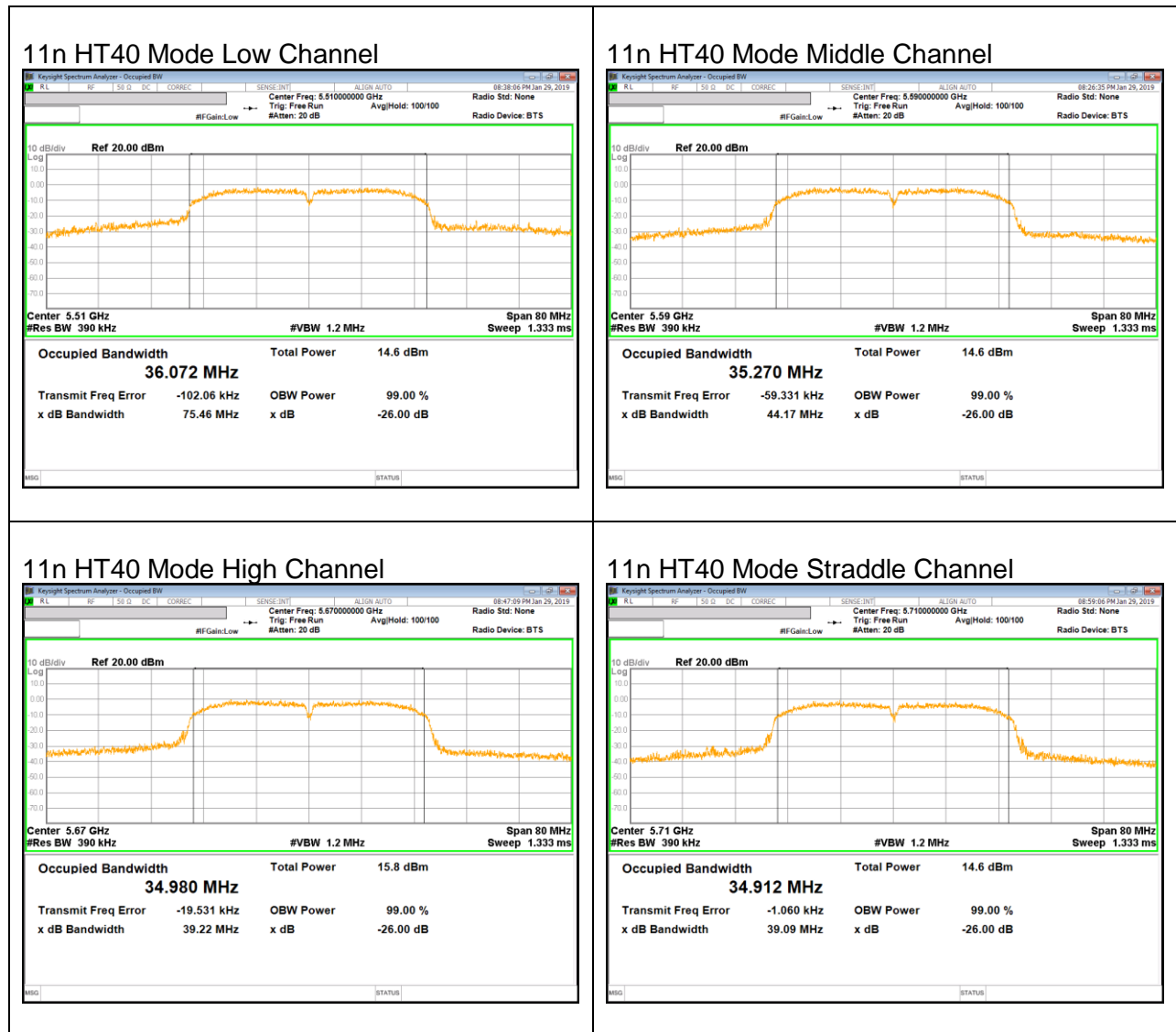

UNII 5.5 GHz IEEE 802.11ac VHT80 mode

11ac VHT80 Mode Low Channel

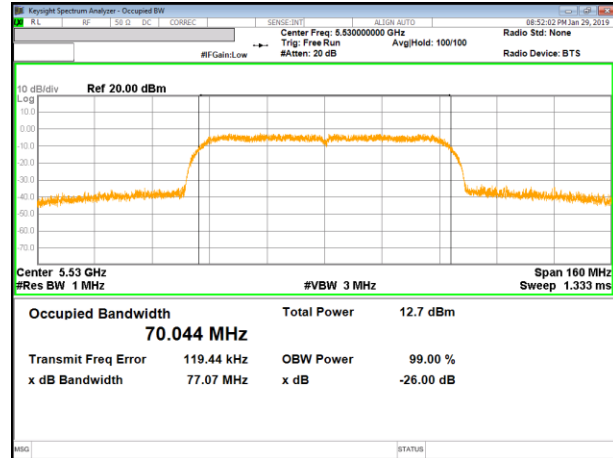

11ac VHT80 Mode High Channel

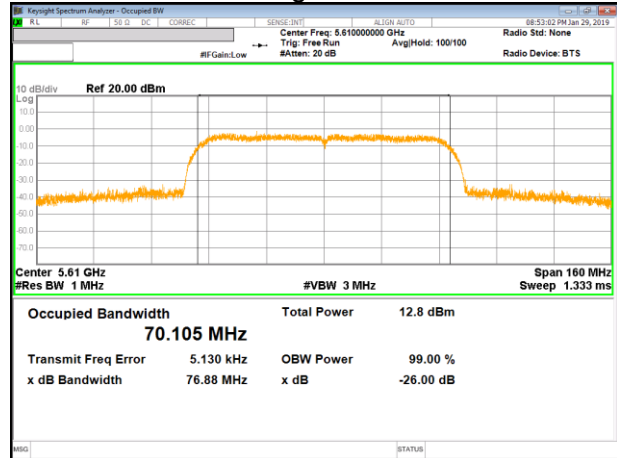

11ac VHT80 Mode Straddle Channel

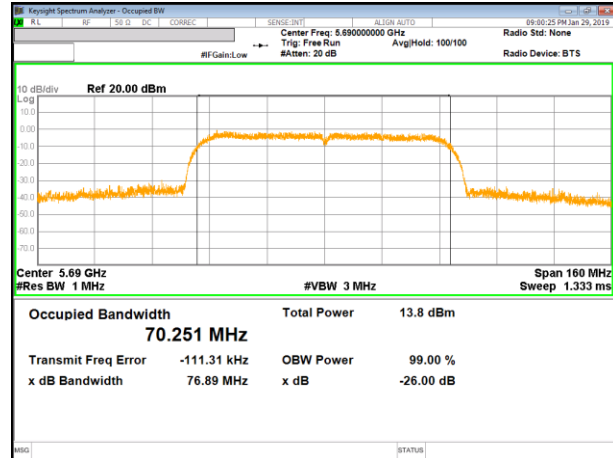

UNII 5.8 GHz IEEE 802.11a mode

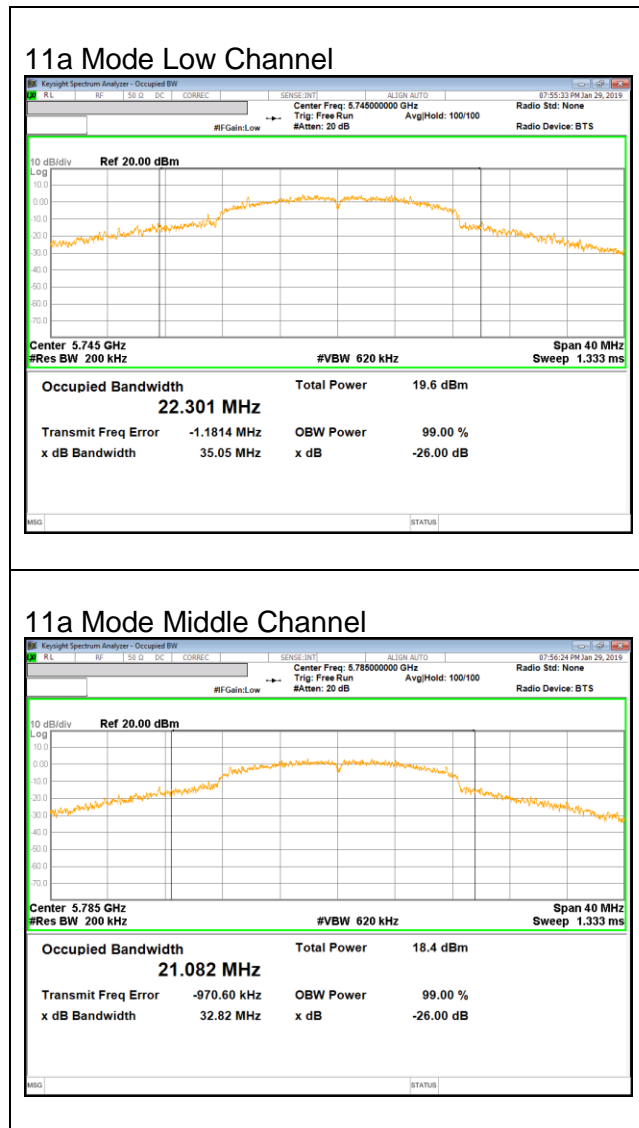

UNII 5.8 GHz IEEE 802.11n HT20 mode

11n HT20 Mode Low Channel

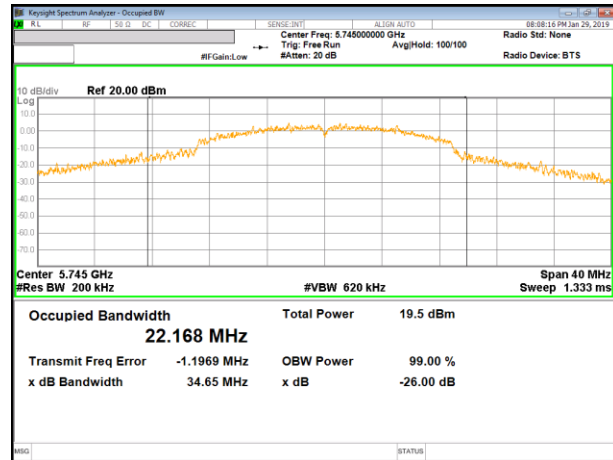

11n HT20 Mode Middle Channel

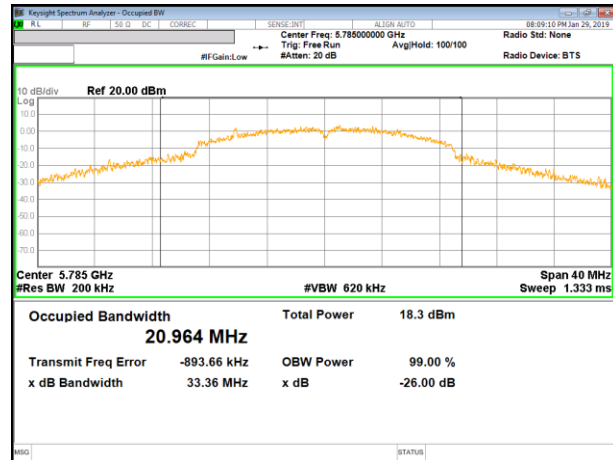

11n HT20 Mode High Channel

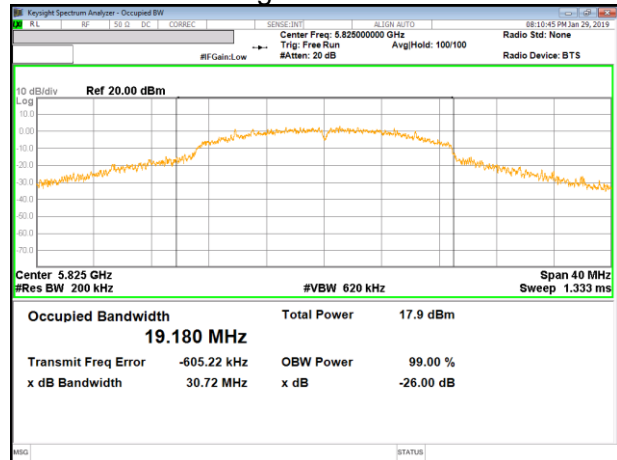

UNII 5.8 GHz IEEE 802.11n HT40 mode

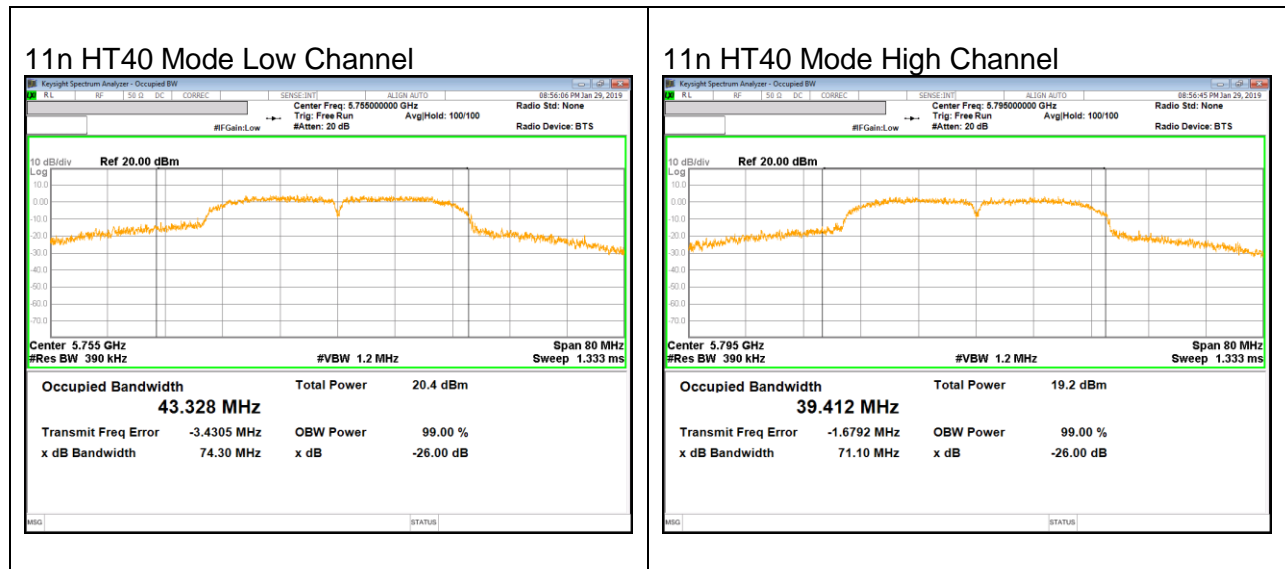

UNII 5.8 GHz IEEE 802.11ac VHT80 mode

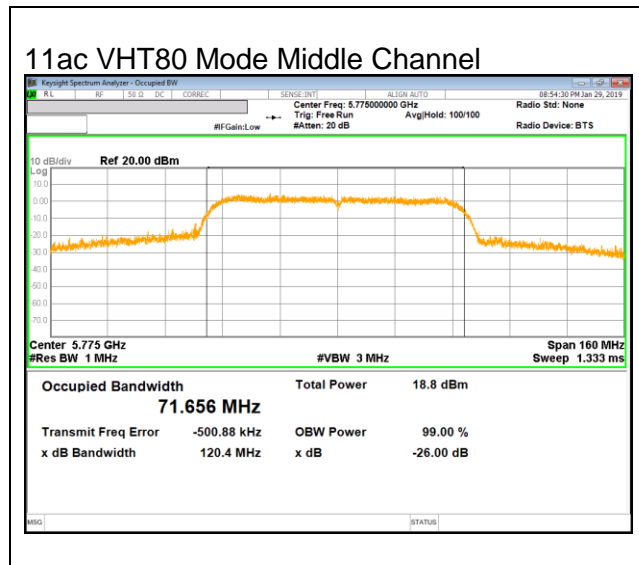

9.4. 99% BANDWIDTH

LIMITS

None; for reporting purposes only.

TEST PROCEDURE

Reference to 789033 D02 General UNII Test Procedures New Rules v01r02: The transmitter output is connected to a spectrum analyzer with the RBW set to approximately 1% to 5% of OBW, the VBW $\geq 3 \times$ RBW, single sweep.

RESULTS

9.4.1. 802.11a MODE IN THE 5.2 GHz BAND

Channel	Frequency [MHz]	99% Bandwidth [MHz]
Low	5180	16.02
Mid	5200	16.10
High	5240	16.09
Worst		16.10

9.4.2. 802.11n HT20 MODE IN THE 5.2 GHz BAND

Channel	Frequency [MHz]	99% Bandwidth [MHz]
Low	5180	17.09
Mid	5200	17.13
High	5240	17.11
Worst		17.13

9.4.3. 802.11n HT40 MODE IN THE 5.2 GHz BAND

Channel	Frequency [MHz]	99% Bandwidth [MHz]
Low	5190	34.82
High	5230	34.79
Worst		34.82

9.4.4. 802.11ac VHT80 MODE IN THE 5.2 GHz BAND

Channel	Frequency [MHz]	99% Bandwidth [MHz]
Middle	5210	70.16
Worst		70.16

9.4.5. 802.11a MODE IN THE 5.3 GHz BAND

Channel	Frequency [MHz]	99% Bandwidth [MHz]
Low	5260	15.86
Mid	5300	15.91
High	5320	15.94
Worst		15.94

9.4.6. 802.11n HT20 MODE IN THE 5.3 GHz BAND

Channel	Frequency [MHz]	99% Bandwidth [MHz]
Low	5260	16.77
Mid	5300	16.88
High	5320	16.88
Worst		16.88

9.4.7. 802.11n HT40 MODE IN THE 5.3 GHz BAND

Channel	Frequency [MHz]	99% Bandwidth [MHz]
Low	5270	34.80
High	5310	34.79
Worst		34.80

9.4.8. 802.11ac VHT80 MODE IN THE 5.3 GHz BAND

Channel	Frequency [MHz]	99% Bandwidth [MHz]
Middle	5290	70.09
Worst		70.09

9.4.9. 802.11a MODE IN THE 5.5 GHz BAND

Channel	Frequency [MHz]	99% Bandwidth [MHz]
Low	5500	17.82
Mid	5580	17.04
High	5700	16.69
Straddle	5720	13.22
Worst		17.82

9.4.10. 802.11n HT20 MODE IN THE 5.5 GHz BAND

Channel	Frequency [MHz]	99% Bandwidth [MHz]
Low	5500	18.49
Mid	5580	17.71
High	5700	17.55
Straddle	5720	13.71
Worst		18.49

9.4.11. 802.11n HT40 MODE IN THE 5.5 GHz BAND

Channel	Frequency [MHz]	99% Bandwidth [MHz]
Low	5510	35.45
Mid	5590	34.94
High	5670	34.88
Straddle	5710	32.43
Worst		35.45

9.4.12. 802.11ac VHT80 MODE IN THE 5.5 GHz BAND

Channel	Frequency [MHz]	99% Bandwidth [MHz]
Low	5530	70.02
High	5610	70.05
Straddle	5690	70.07
Worst		70.07

9.4.13. 802.11a MODE IN THE 5.8 GHz BAND

Channel	Frequency [MHz]	99% Bandwidth [MHz]
Straddle	5720	3.22
Low	5745	18.15
Mid	5785	17.31
High	5825	16.57
Worst		18.15

9.4.14. 802.11n HT20 MODE IN THE 5.8 GHz BAND

Channel	Frequency [MHz]	99% Bandwidth [MHz]
Straddle	5720	3.71
Low	5745	18.63
Mid	5785	17.82
High	5825	17.48
Worst		18.63

9.4.15. 802.11n HT40 MODE IN THE 5.8 GHz BAND

Channel	Frequency [MHz]	99% Bandwidth [MHz]
Straddle	5710	2.43
Low	5755	36.37
High	5795	35.62
Worst		36.37

9.4.16. 802.11ac VHT80 MODE IN THE 5.8 GHz BAND

Channel	Frequency [MHz]	99% Bandwidth [MHz]
Straddle	5690	0.07
Middle	5775	70.91
Worst		70.91

9.4.17. 99% BANDWIDTH PLOTS

UNII 5.2 GHz IEEE 802.11a mode

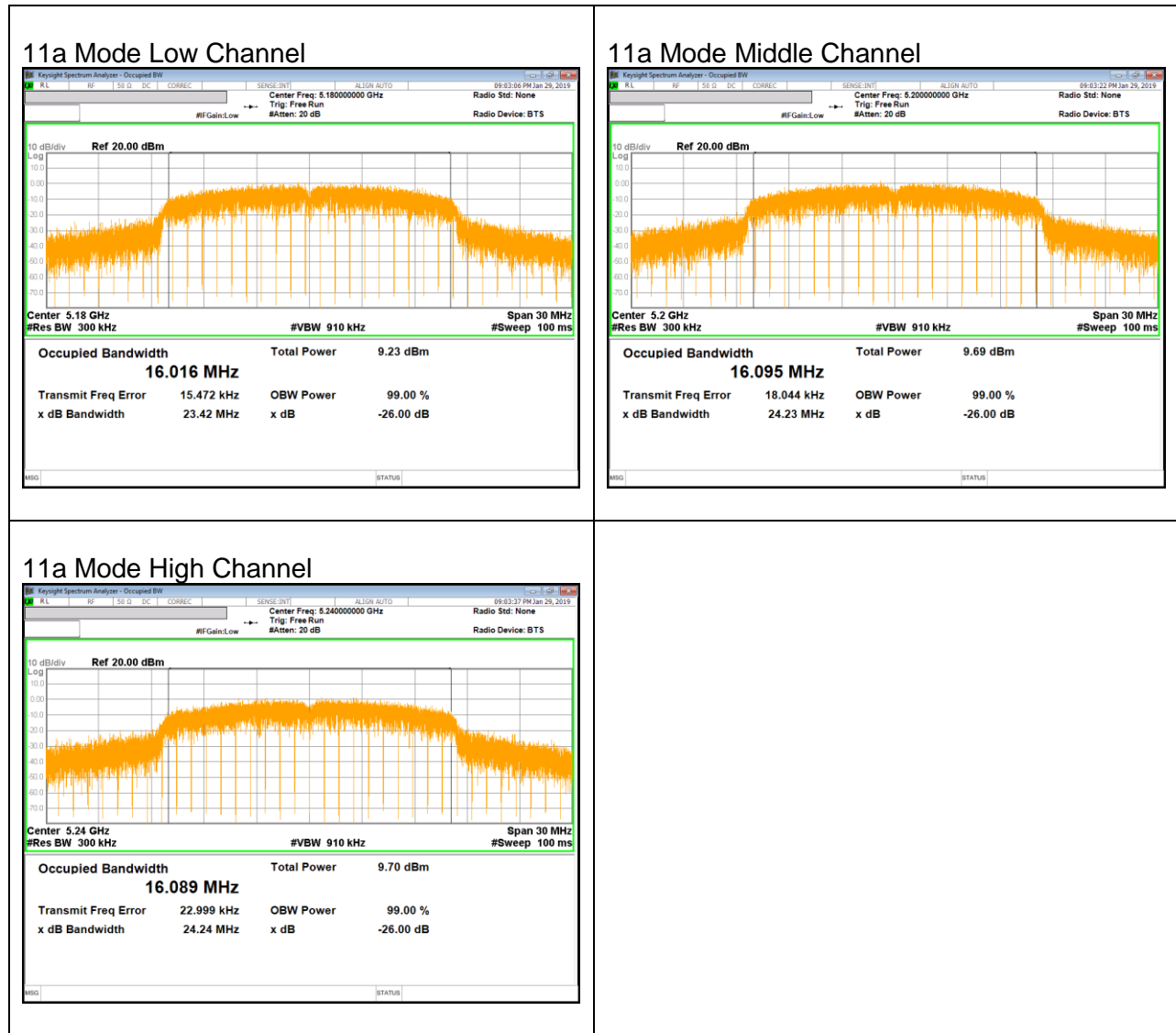

UNII 5.2 GHz IEEE 802.11n HT20 mode

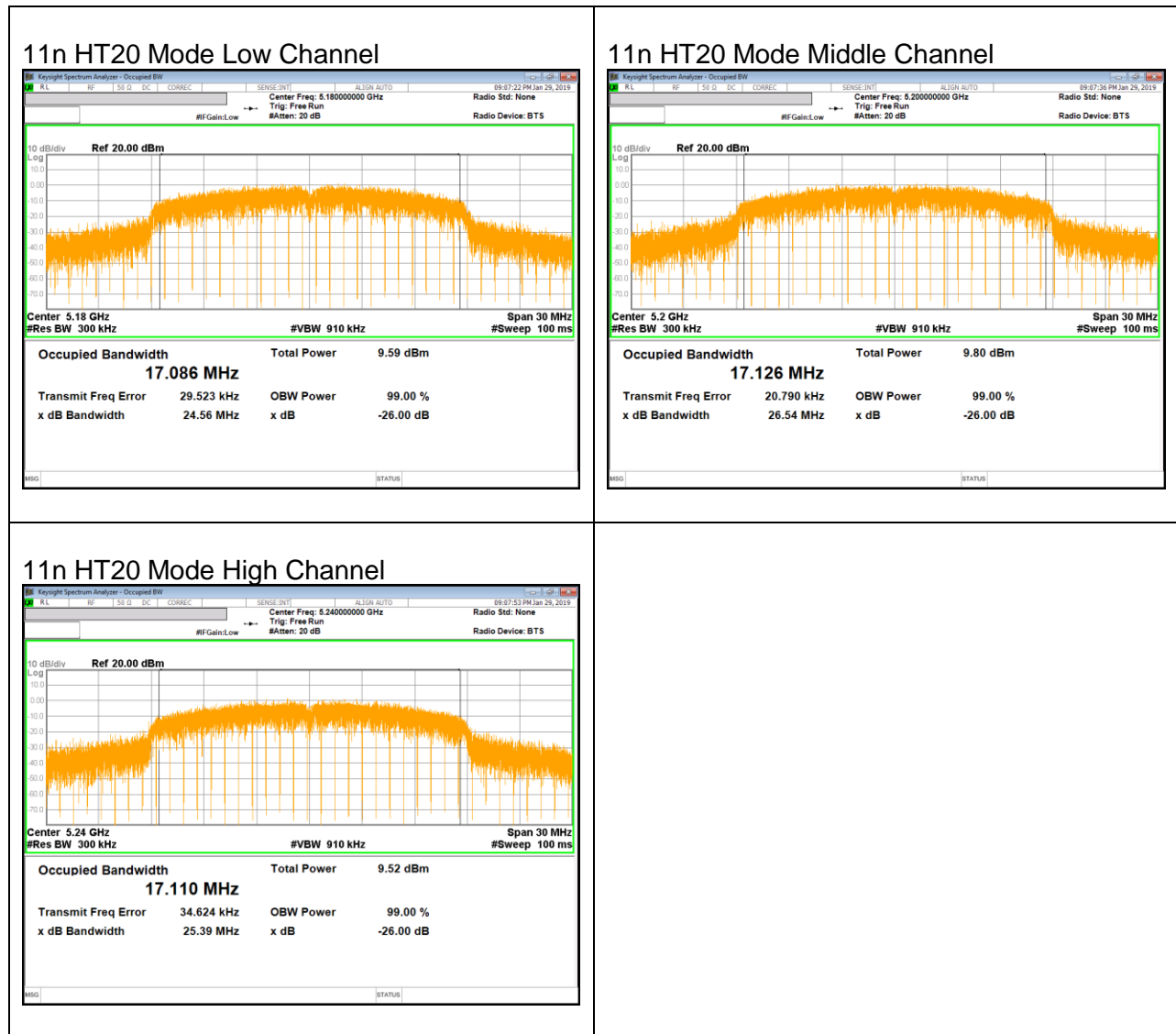

UNII 5.2 GHz IEEE 802.11n HT40 mode

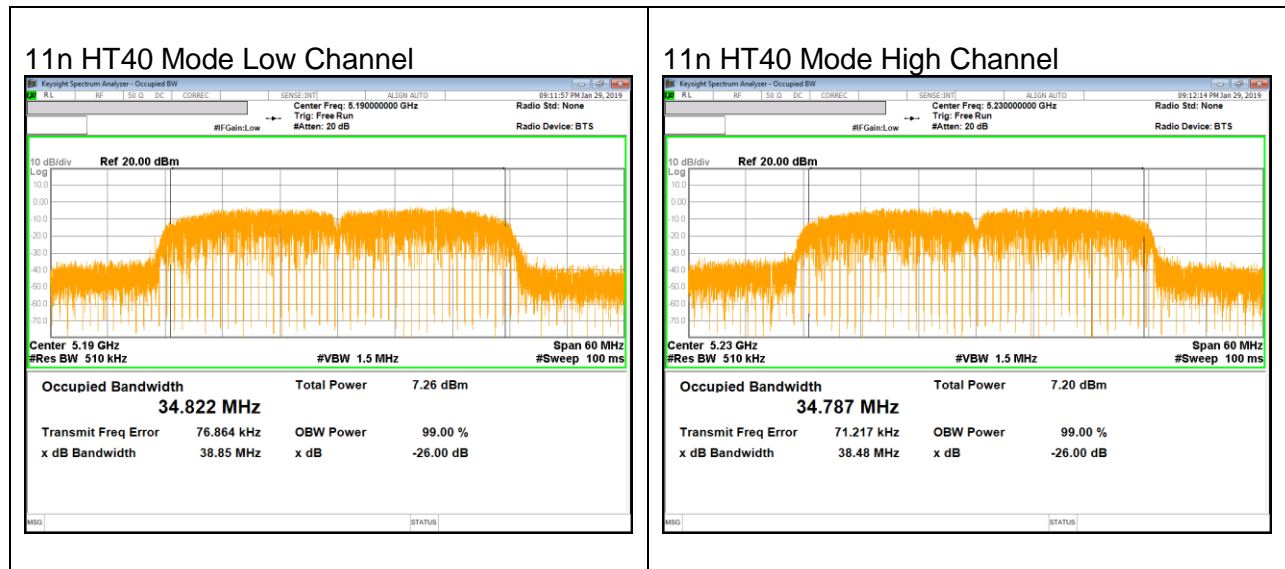

UNII 5.2 GHz IEEE 802.11ac VHT80 mode

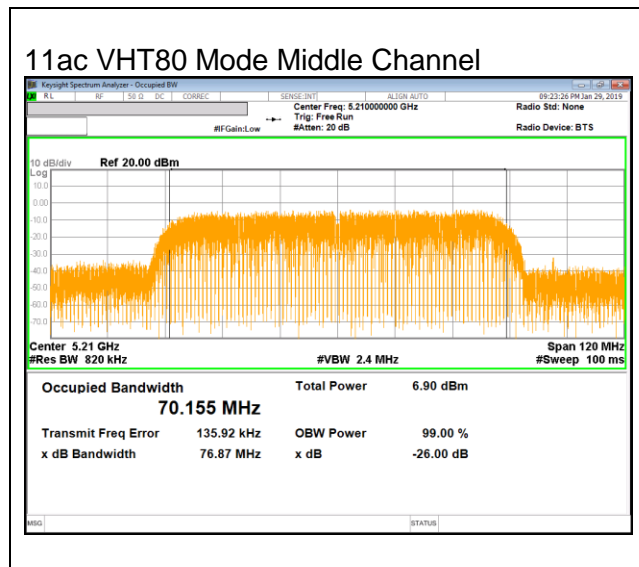

UNII 5.3 GHz IEEE 802.11a mode

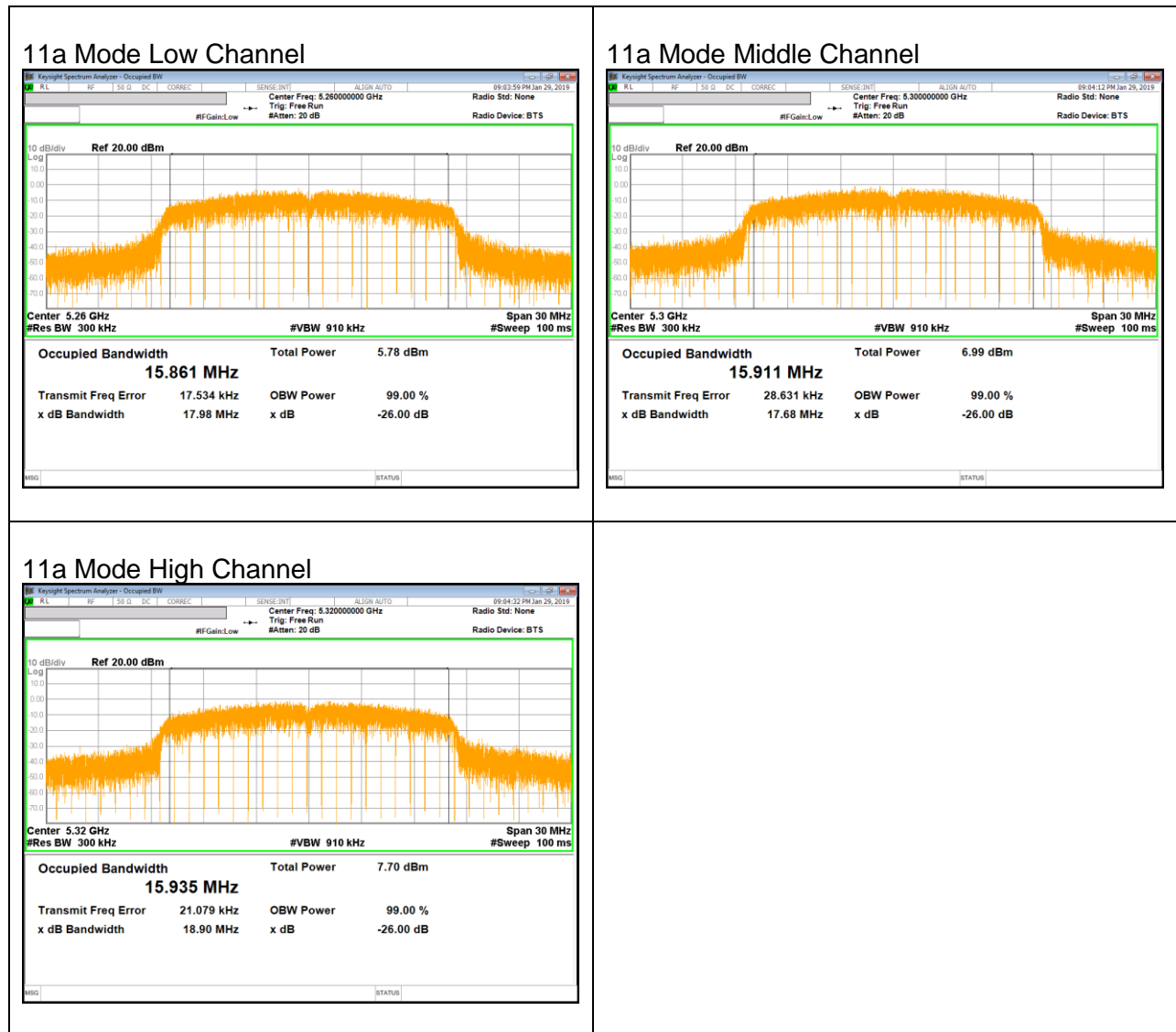

UNII 5.3 GHz IEEE 802.11n HT20 mode

11n HT20 Mode Low Channel

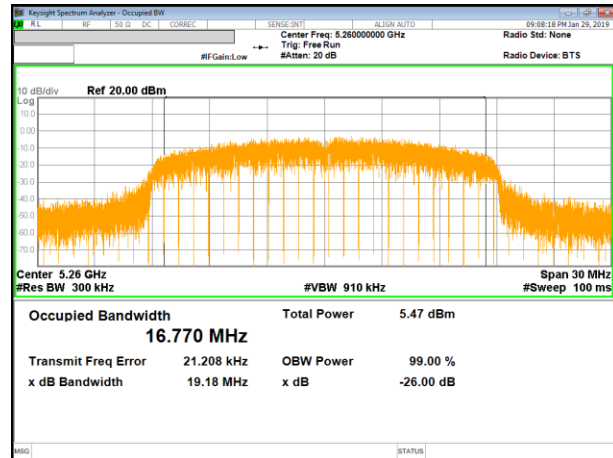

11n HT20 Mode Middle Channel

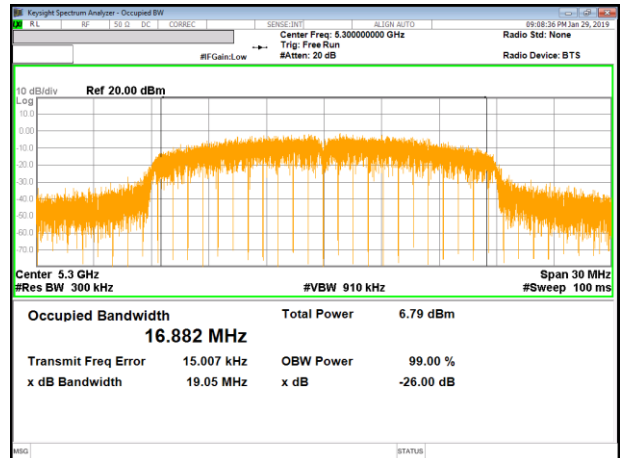

11n HT20 Mode High Channel

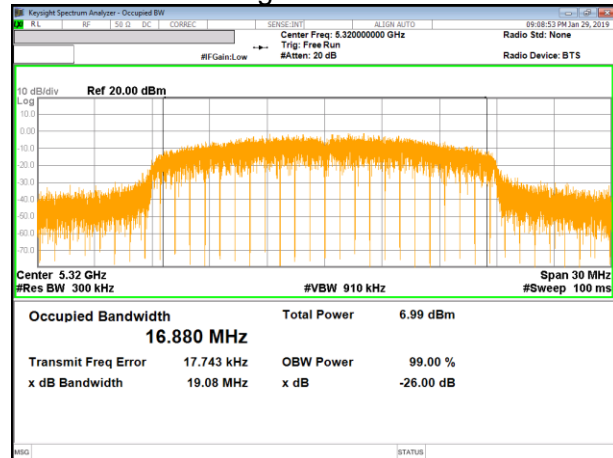

UNII 5.3 GHz IEEE 802.11n HT40 mode

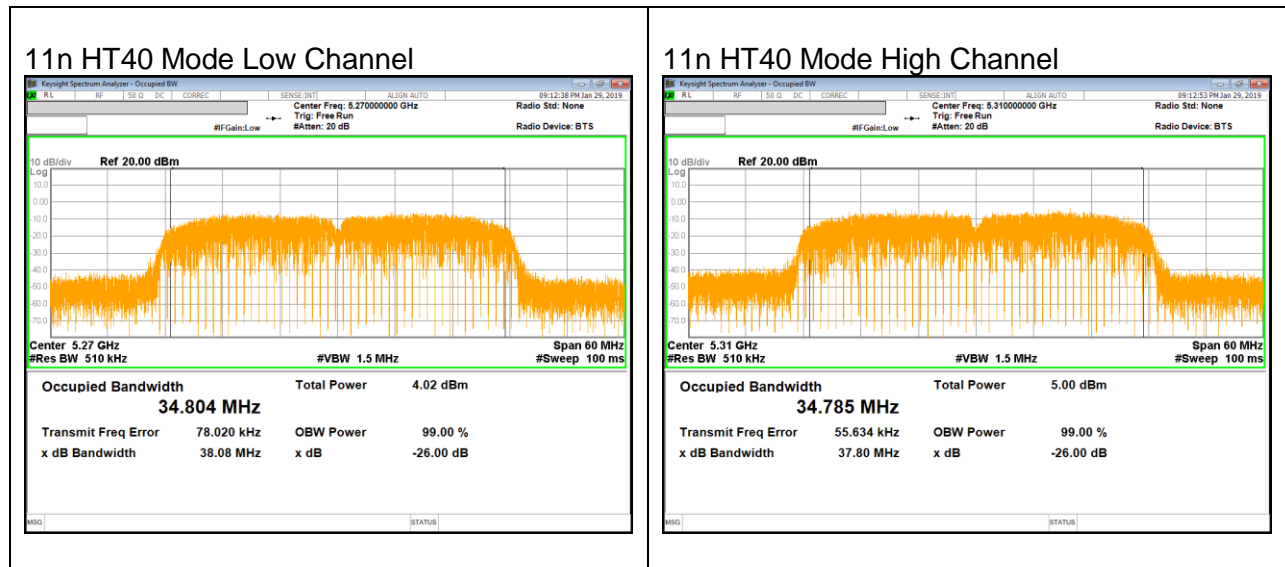

UNII 5.3 GHz IEEE 802.11ac VHT80 mode

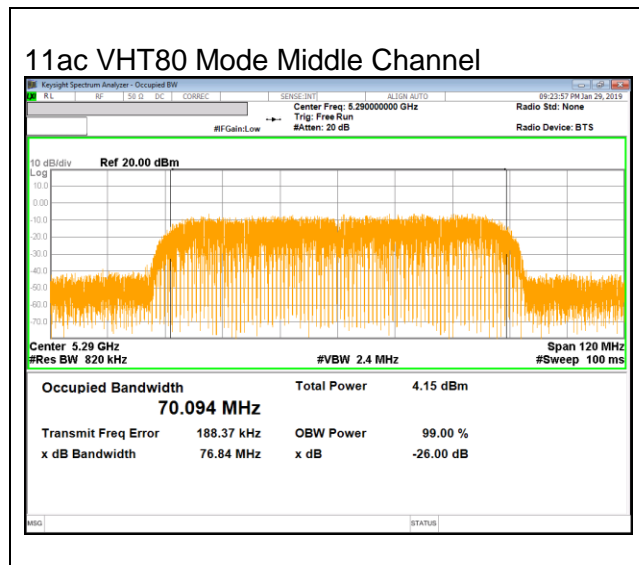

UNII 5.5 GHz IEEE 802.11a mode

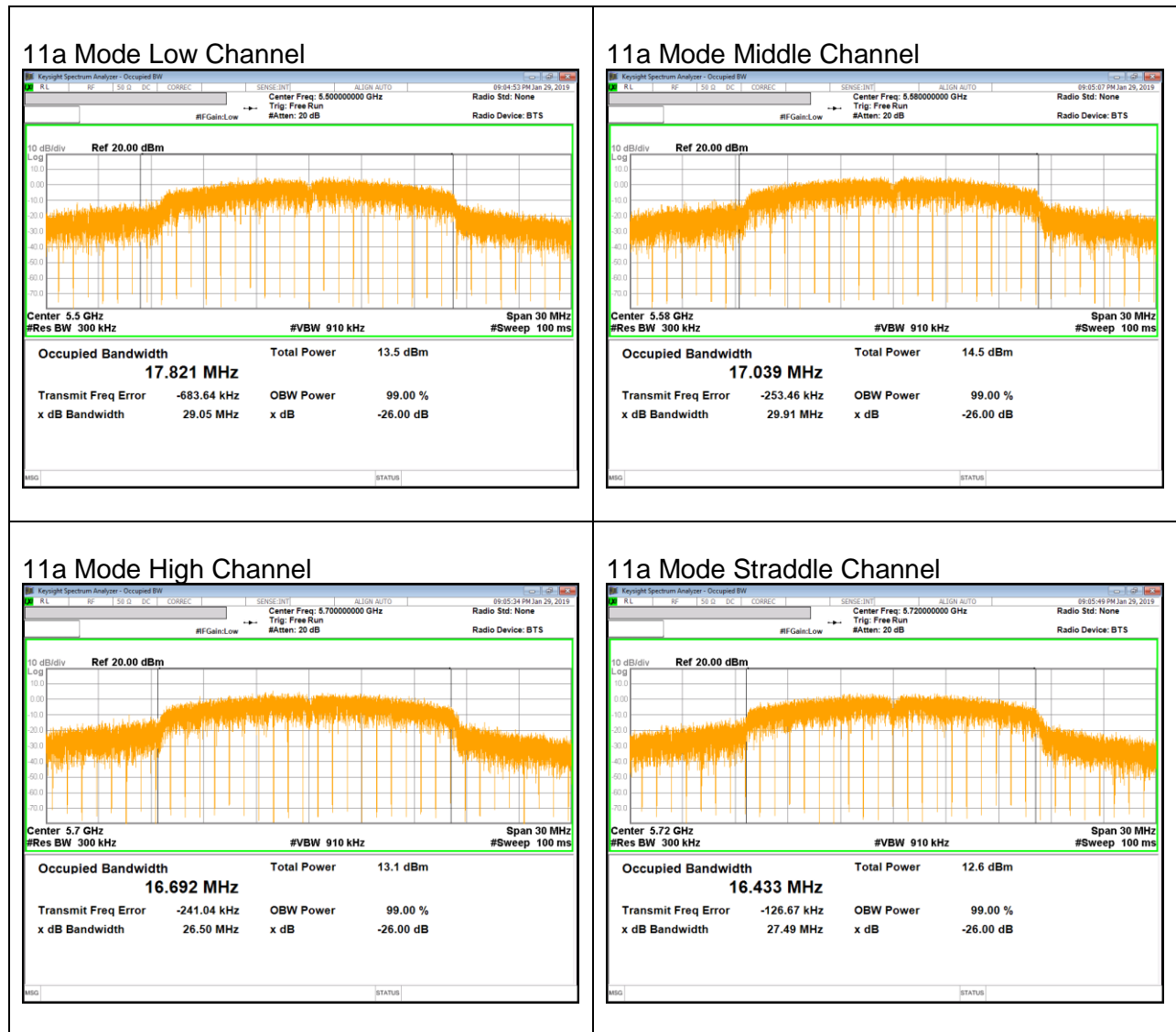

UNII 5.5 GHz IEEE 802.11n HT20 mode

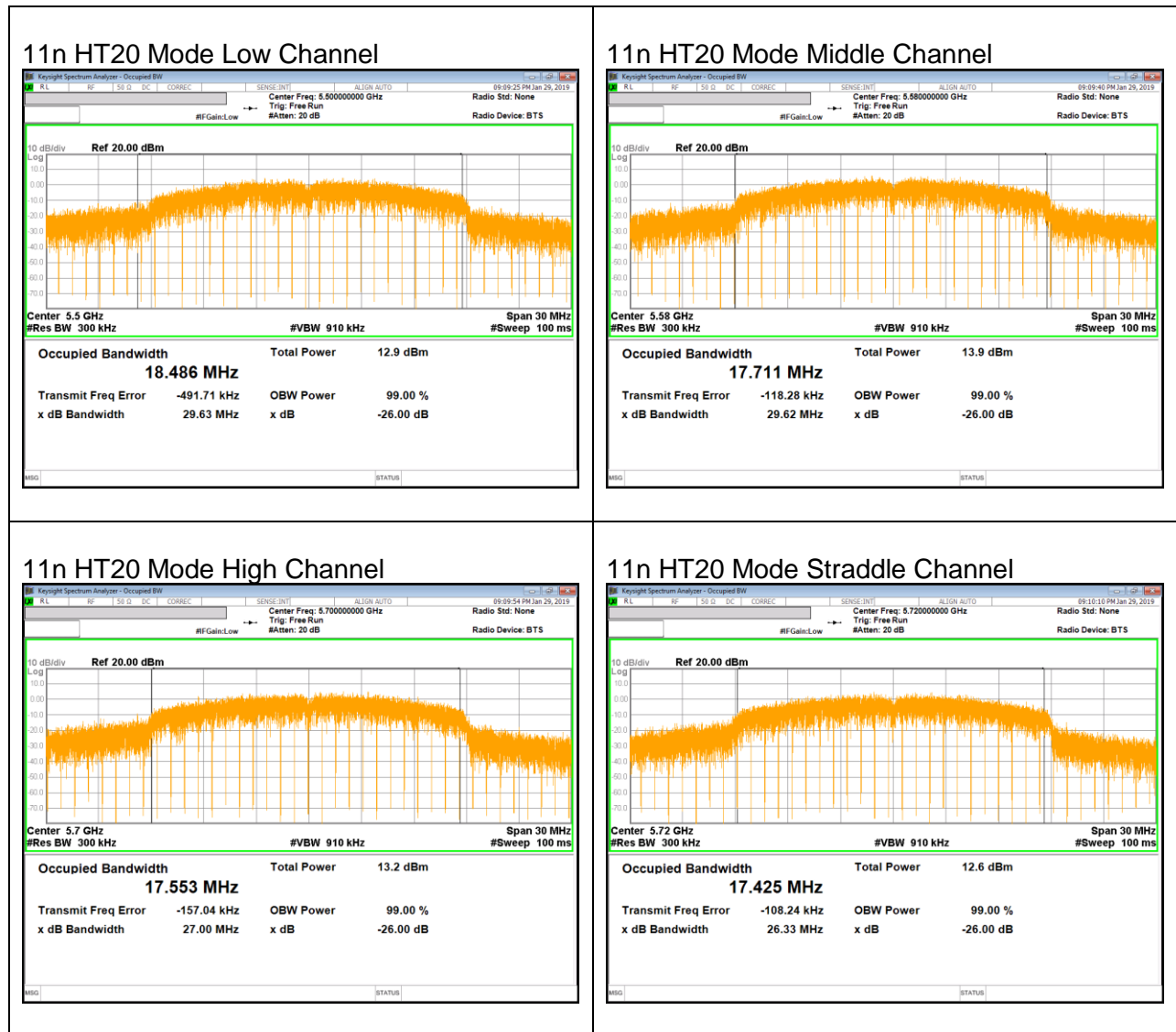

UNII 5.5 GHz IEEE 802.11n HT40 mode

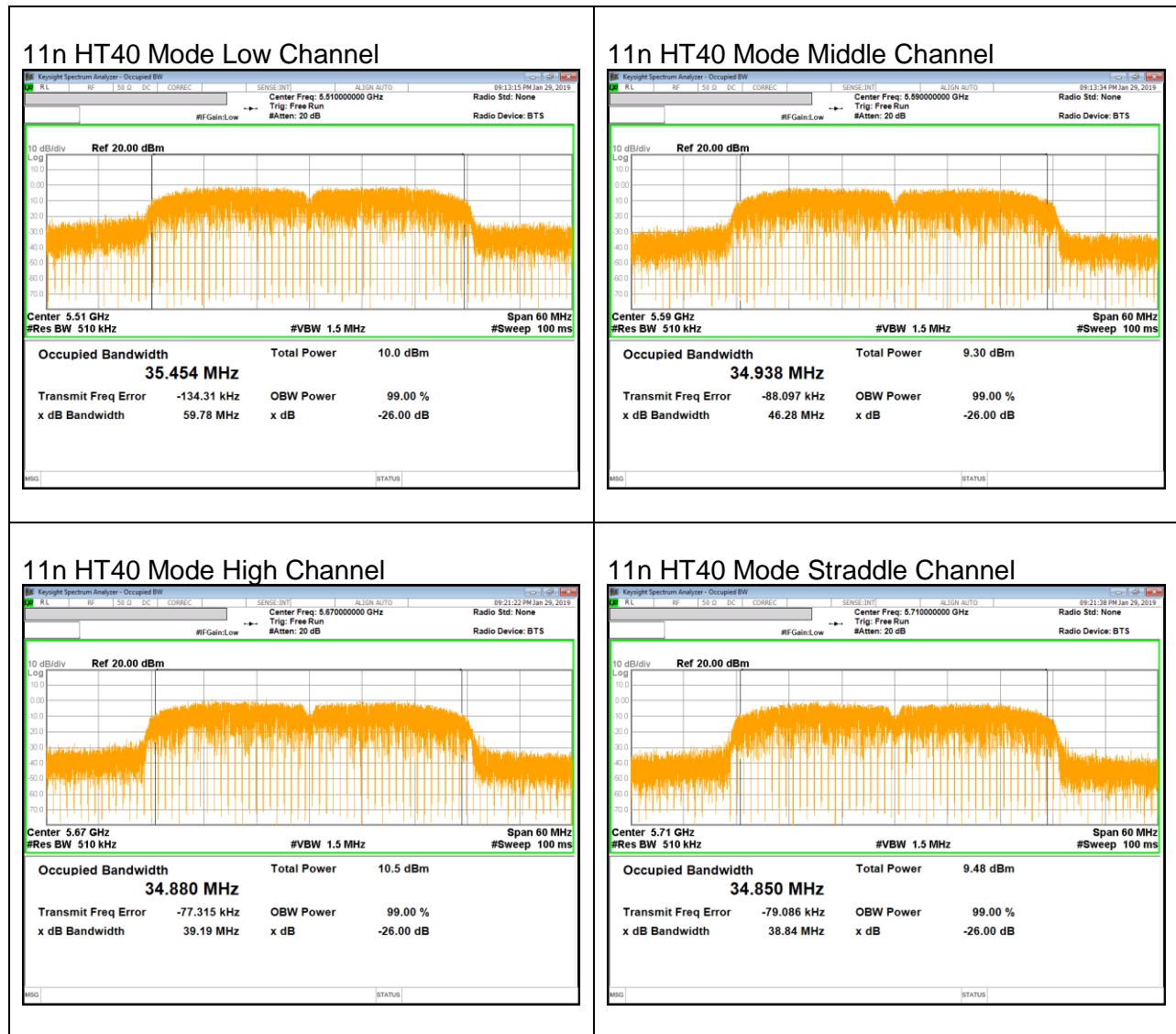

UNII 5.5 GHz IEEE 802.11ac VHT80 mode

