



FCC CFR47 PART 22 SUBPART H
FCC CFR47 PART 24 SUBPART E
FCC CFR47 PART 27 SUBPART M

WWAN

CERTIFICATION TEST REPORT

FOR

GSM/WCDMA/LTE Phone + BT/BLE, DTS/UNII a/b/g/n/ac, ANT+ and NFC

MODEL NUMBER : SM-A505FM/DS

FCC ID: A3LSMA505FM

REPORT NUMBER: 4788862444-E1V1

ISSUE DATE: FEB 19, 2019

Prepared for
SAMSUNG ELECTRONICS CO., LTD.
129 SAMSUNG-RO, YEONGTONG-GU, SUWON-SI,
GYEONGGI-DO, 16677, KOREA

Prepared by
UL Korea, Ltd.
26th floor, 152, Teheran-ro, Gangnam-gu Seoul, 06236, Korea
Suwon Test Site: UL Korea, Ltd. Suwon Laboratory
218 Maeyeong-ro, Yeongtong-gu,
Suwon-si, Gyeonggi-do, 16675, Korea
TEL: (031) 337-9902
FAX: (031) 213-5433



ACCREDITED*

Testing
Laboratory

TL-637

Revision History

<u>Rev.</u>	<u>Issue Date</u>	<u>Revisions</u>	<u>Revised By</u>
V1	02/19/19	Initial issue	Junwhan Lee

TABLE OF CONTENTS

1. ATTESTATION OF TEST RESULTS	5
1.1. INTRODUCTION OF TEST DATA REUSE	6
1.2. DIFFERENCE	6
1.3. SPOT CHECK VERIFICATION DATA.....	6
1.4. REFERENCE DETAIL.....	7
2. TEST METHODOLOGY	8
3. FACILITIES AND ACCREDITATION	8
4. CALIBRATION AND UNCERTAINTY	9
4.1. MEASURING INSTRUMENT CALIBRATION.....	9
4.2. SAMPLE CALCULATION.....	9
4.3. MEASUREMENT UNCERTAINTY	9
5. EQUIPMENT UNDER TEST	10
5.1. DESCRIPTION OF EUT.....	10
5.2. MAXIMUM OUTPUT POWER.....	10
5.3. DESCRIPTION OF AVAILABLE ANTENNAS	12
5.4. WORST-CASE ORIENTATION.....	12
5.5. DESCRIPTION OF TEST SETUP.....	14
6. TEST AND MEASUREMENT EQUIPMENT	16
7. SUMMARY TABLE.....	17
8. PEAK TO AVERAGE RATIO	18
8.1. CONDUCTED PEAK TO AVERAGE RESULT	19
9. LIMITS AND CONDUCTED RESULTS	23
9.1. OCCUPIED BANDWIDTH.....	23
9.1.1. OCCUPIED BANDWIDTH RESULTS	24
9.2. BAND EDGE EMISSIONS	36
9.2.1. BAND EDGE RESULT.....	38
9.2.2. EMISSION MASK RESULT	44
9.3. OUT OF BAND EMISSIONS.....	48
9.3.1. OUT OF BAND EMISSIONS RESULT.....	49
9.4. FREQUENCY STABILITY.....	55
9.4.1. FREQUENCY STABILITY RESULTS	56
10. RADIATED TEST RESULTS	59

10.1.	<i>RADIATED POWER (ERP & EIRP)</i>	59
10.1.1.	ERP/EIRP Results	60
10.1.2.	ERP/EIRP DATA	64
10.2.	<i>FIELD STRENGTH OF SPURIOUS RADIATION</i>	76
10.2.1.	SPURIOUS RADIATION PLOTS.....	77
11.	Appendix A: SETUP PHOTOS	83

Appendix B : Cellular receiver Part 15B test results

1. ATTESTATION OF TEST RESULTS

COMPANY NAME: SAMSUNG ELECTRONICS CO., LTD.

EUT DESCRIPTION: GSM/WCDMA/LTE Phone + BT/BLE, DTS/UNII a/b/g/n/ac, ANT+ and NFC

MODEL NUMBER: SM-A505FM/DS

SERIAL NUMBER: R38KB0HB44X, ce107c48830b7e2b (CONDUCTED, Original);
R38KB0HB2HX, R38KB0HB8AF, R38M108FNGZ (RADIATED, Original);
R38M109EB9D (RADIATED, Spot check)

DATE TESTED: DEC 20, 2018 – JAN 31, 2019 (Original);
JAN 31, 2019 (Spot check)

APPLICABLE STANDARDS	
STANDARD	TEST RESULTS
FCC PART 22H, 24E and 27M	Pass

UL Korea, Ltd. tested the above equipment in accordance with the requirements set forth in the above standards. All indications of Pass/Fail in this report are opinions expressed by UL Korea, Ltd. based on interpretations and/or observations of test results. Measurement Uncertainties were not taken into account and are published for informational purposes only. The test results show that the equipment tested is capable of demonstrating compliance with the requirements as documented in this report.

Note: The results documented in this report apply only to the tested sample, under the conditions and modes of operation as described herein. This document may not be altered or revised in any way unless done so by UL Korea, Ltd. and all revisions are duly noted in the revisions section. Any alteration of this document not carried out by UL Korea, Ltd. will constitute fraud and shall nullify the document. This report must not be used by the client to claim product certification, approval, or endorsement by IAS, any agency of the Federal Government, or any agency of any government.

Approved & Released For
UL Korea, Ltd. By:



SungGil Park
Suwon Lab Engineer
UL Korea, Ltd.

Tested By:



Junwhan Lee
Suwon Lab Engineer
UL Korea, Ltd.

1.1. INTRODUCTION OF TEST DATA REUSE

This report referenced from the FCC ID: A3LSMA505FN WWAN(FCC CFR 47 Part 22/24/27). And the applicant takes full responsibility that the test data as referenced in this report represent compliance for this FCC ID.

1.2. DIFFERENCE

The FCC ID: A3LSMA505FM shares the same enclosure and circuit board as FCC ID: A3LSMA505FN. The WWAN antennas and surrounding circuitry and layout are identical between these two units for re-used bands.

After confirming through preliminary radiated emissions that the performance of the FCC ID: A3LSMA505FN remains representative of FCC ID: A3LSMA505FM. The test data of FCC ID: A3LSMA505FN being submitted for this application to cover WWAN features.

- Re-use bands - All bands

1.3. SPOT CHECK VERIFICATION DATA

Band	Test Item	Worst Mode	Frequency	Test Limit	Original model	Spot check model	Deviation	Remark
					SM-A505FN/DS Results	SM-A505FM/DS Results		
					FCC ID : A3LSMA505FN	FCC ID : A3LSMA505FM		
GSM 850	EIRP	GPRS	848.8 MHz	38.50 dBm	27.98 dBm	27.73 dBm	-0.25 dB	
	RSE	GPRS	2472.6 MHz	-13.00 dBm	-46.90 dBm	-45.50 dBm	1.40 dB	
GSM 1900	EIRP	GPRS	1909.8 MHz	33.00 dBm	30.36 dBm	30.68 dBm	0.32 dB	
	RSE	GPRS	7520.0 MHz	-13.00 dBm	-46.20 dBm	-46.00 dBm	0.20 dB	Noise Floor
WCDMA Band 2	EIRP	REL99	1907.6 MHz	33.00 dBm	23.85 dBm	23.21 dBm	-0.64 dB	
	RSE	REL99	7630.4 MHz	-13.00 dBm	-47.20 dBm	-46.40 dBm	0.80 dB	Noise Floor
WCDMA Band 5	EIRP	REL99	846.6 MHz	38.50 dBm	18.33 dBm	18.30 dBm	-0.03 dB	
	RSE	REL99	3346.4 MHz	-13.00 dBm	-52.50 dBm	-53.50 dBm	-1.00 dB	Noise Floor
LTE Band 5	ERP	5M QPSK	831.5 MHz	38.50 dBm	18.43 dBm	18.04 dBm	-0.39 dB	
	RSE	1.4M QPSK	2509.5 MHz	-13.00 dBm	-47.50 dBm	-52.10 dBm	-4.60 dB	Noise Floor
LTE Band 41	EIRP	20M QPSK	2503.5 MHz	33.00 dBm	24.33 dBm	23.01 dBm	-1.32 dB	
	RSE	10M QPSK	15021.0 MHz	-25.00 dBm	-31.40 dBm	-31.60 dBm	-0.20 dB	

Comparison of two models, upper deviation is within 3dB range and all test results are under FCC Technical Limits.

1.4. REFERENCE DETAIL

Reference application that contains the reused reference data.

Equipment Class	Reference FCC ID	Type Grant/Permissive Change	Reference Application	Folder Test/RF Exposure	Report Tittle / Section
PCE	A3LSMA505FN	Grant	4788805437-E1	Test	FCC Report WWAN / All sections
DTS	A3LSMA505FN	Grant	4788805437-E2	Test	FCC Report DTS WLAN / All sections
			4788805437-E3	Test	FCC Report BLE All sections
DSS	A3LSMA505FN	Grant	4788805437-E4	Test	FCC Report BT / All sections
NII	A3LSMA505FN	Grant	4788805437-E5	Test	FCC Report UNII WLAN / All sections
DXX	A3LSMA505FN	Grant	4788805437-E6	Test	FCC Report ANT+ / All sections
	A3LSMA505FN	Grant	4788805437-E7	Test	FCC Report NFC / All sections

2. TEST METHODOLOGY

The tests documented in this report were performed in accordance with following methods.

1. FCC CFR 47 Part 2.
2. FCC CFR 47 Part 22.
3. FCC CFR 47 Part 24.
4. FCC CFR 47 Part 27.
5. ANSI TIA-603-E, 2016
6. KDB 971168 D01 Power Meas License Digital Systems v03r01

3. FACILITIES AND ACCREDITATION

The test sites and measurement facilities used to collect data are located at 218 Maeyeong-ro, Yeongtong-gu, Suwon-si, Gyeonggi-do, 16675, Korea. Line conducted emissions are measured only at the 218 address. The following table identifies which facilities were utilized for radiated emission measurements documented in this report. Specific facilities are also identified in the test results sections.

218 Maeyeong-ro	
<input checked="" type="checkbox"/>	Chamber 1
<input checked="" type="checkbox"/>	Chamber 2
<input type="checkbox"/>	Chamber 3

UL Korea, Ltd. is accredited by IAS, Laboratory Code TL-637. The full scope of accreditation can be viewed at <http://www.iasonline.org/PDF/TL/TL-637.pdf>.

4. CALIBRATION AND UNCERTAINTY

4.1. MEASURING INSTRUMENT CALIBRATION

The measuring equipment utilized to perform the tests documented in this report has been calibrated in accordance with the manufacturer's recommendations, and is traceable to recognized national standards.

4.2. SAMPLE CALCULATION

Where relevant, the following sample calculation is provided:

$EIRP = \text{PSA reading with EUT worst orientation (dBm)} + \text{Path loss (dB)} - \text{cable loss (between the SG and substitution antenna)} + \text{Substitution Antenna Factor (dBi)}$

$ERP = \text{PSA reading with EUT worst orientation (dBm)} + \text{Path loss (dB)} - \text{cable loss (between the SG and substitution antenna)}$

(Path loss = Signal generator output – PSA reading with substitution antenna)

4.3. MEASUREMENT UNCERTAINTY

Where relevant, the following measurement uncertainty levels have been estimated for tests performed on the apparatus:

PARAMETER	UNCERTAINTY
Conducted Disturbance, 0.15 to 30 MHz	2.32 dB
Radiated Disturbance, Below 1GHz	3.86 dB
Radiated Disturbance, Above 1 GHz	5.97 dB

Uncertainty figures are valid to a confidence level of 95%.

5. EQUIPMENT UNDER TEST

5.1. DESCRIPTION OF EUT

The EUT is a GSM/WCDMA/LTE Phone + BT/BLE, DTS/UNII a/b/g/n/ac, ANT+ and NFC.
 This test report addresses the WWAN operational mode.

5.2. MAXIMUM OUTPUT POWER

The transmitter has a maximum average radiated ERP / EIRP output powers as follows:

GSM

FCC Part 22/24				
Band	Frequency Range	Modulation	Radiated	
	[MHz]		Avg [dBm]	Avg [mW]
GSM850	824~849	GPRS	27.98	628.06
		EGPRS	22.85	192.75
GSM1900	1850~1910	GPRS	30.36	1086.43
		EGPRS	28.86	769.13

WCDMA

FCC Part 22/24				
Band	Frequency Range	Modulation	Radiated	
	[MHz]		Avg [dBm]	Avg [mW]
Band 5	824~849	REL99	18.33	68.08
		HSDPA	18.16	65.46
Band 2	1850~1910	REL99	23.85	242.66
		HSDPA	23.50	223.87

LTE Band 5

FCC Part 22					
Band	Frequency Range [MHz]	BandWidth [MHz]	Modulation	Radiated	
				Avg [dBm]	Avg [mW]
Band 5	824 ~ 849	10	QPSK	17.99	62.95
			16QAM	17.04	50.58
		5	QPSK	18.43	69.66
			16QAM	16.98	49.89
		3	QPSK	18.10	64.57
			16QAM	17.20	52.48
		1.4	QPSK	18.08	64.27
			16QAM	16.99	50.00

LTE Band 41

FCC Part 27					
Band	Frequency Range [MHz]	BandWidth [MHz]	Modulation	Radiated	
				Avg [dBm]	Avg [mW]
Band 41	2496 - 2690	20	QPSK	24.33	271.02
			16QAM	23.29	213.30
		15	QPSK	24.11	257.63
			16QAM	22.96	197.70
		10	QPSK	24.08	255.86
			16QAM	24.08	255.86
		5	QPSK	23.77	238.23
			16QAM	23.15	206.54

5.3. DESCRIPTION OF AVAILABLE ANTENNAS

The radio utilizes a internal antenna for the [List the bands supported] with a maximum peak gain as follow:

Frequency (MHz)	Peak Gain (dBi)
WCDMA Band 5 / LTE Band 5 / GSM850 824 ~ 849 MHz	-2.44
WCDMA Band 2 / GSM1900 1850 ~ 1910 MHz	-3.92
LTE Band 41 2496 ~ 2690 MHz	-2.67

5.4. WORST-CASE ORIENTATION

Following modes should be considered as worst-case scenario for all other measurements.

- GSM GPRS/EGPRS
- UMTS REL 99/HSDPA

For all LTE Bands, the worst-case scenario for all measurements is based on the average conducted output power measurement investigation. The out of band emissions and spurious radiation were only performed on bandwidth and RB offset(with RB size 1) with the highest power in QPSK.

Highest power setting for each bands				
LTE Band	Frequency (MHz)	Bandwidth (MHz)	RB size	RB offset
5	824.7	1.4	1	3
	836.5		1	0
	848.3		1	0
41	2501.0	10	1	0
	2593.0		1	0
	2685.0		1	49

- ERP/EIRP

For GSM1900 / WCDMA B2 / LTE B41, the fundamental of the EUT was investigated in three orthogonal orientations X, Y and Z it was determined that X orientation was worst-case orientation.

For GSM850 / WCDMA B5 / LTE B5, the fundamental of the EUT was investigated in three orthogonal orientations X, Y and Z it was determined that Z orientation was worst-case orientation.

- Radiated spurious emissions

For GSM850 / GSM1900 / WCDMA B5 / WCDMA B2, the spurious emissions was investigated in three orthogonal orientations X, Y and Z it was determined that X orientation was worst-case orientation.

For LTE B41, the spurious emissions was investigated in three orthogonal orientations X, Y and Z it was determined that Y orientation was worst-case orientation.

For LTE B5, the spurious emissions was investigated in three orthogonal orientations X, Y and Z it was determined that Z orientation was worst-case orientation.

Note : All radiated spurious tests were performed connected with earphone and charger for evaluation of worst case mode.(For erp/eirp tests, the EUT didn't connected with earphone and charger)

For check the Part15B receiver mode(Appendix B):

For GSM850 / WCDMA B5 / LTE B5, the emissions was investigated in three orthogonal orientations X, Y and Z it was determined that Z orientation was worst-case orientation.

5.5. DESCRIPTION OF TEST SETUP

SUPPORT EQUIPMENT

Support Equipment List				
Description	Manufacturer	Model	Serial Number	FCC ID
Charger	SAMSUNG	EP-TA200	R37KC3B01GORC3	N/A
Data Cable	SAMSUNG	EP-D140AWE	N/A	N/A
Earphone	SAMSUNG	EHS61ASFWE	N/A	N/A

I/O CABLE

I/O Cable List						
Cable No	Port	# of identical ports	Connector Type	Cable Type	Cable Length (m)	Remarks
1	DC Power	1	C Type	Shielded	1.1m	N/A
2	Audio	2	Mini-Jack	Unshielded	1.2m	N/A

TEST SETUP

The EUT is continuously communicated to the call box during the tests.

SETUP DIAGRAM FOR TESTS (CONDUCTED TEST SETUP)

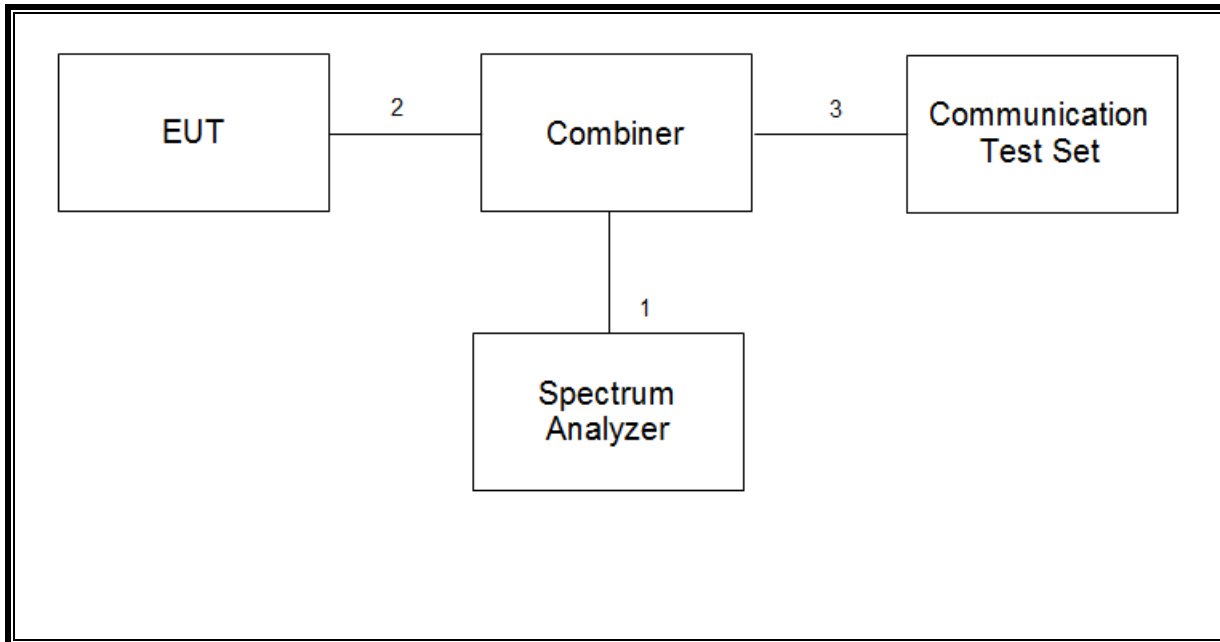

SETUP DIAGRAM FOR TESTS (RADIATED TEST SETUP)

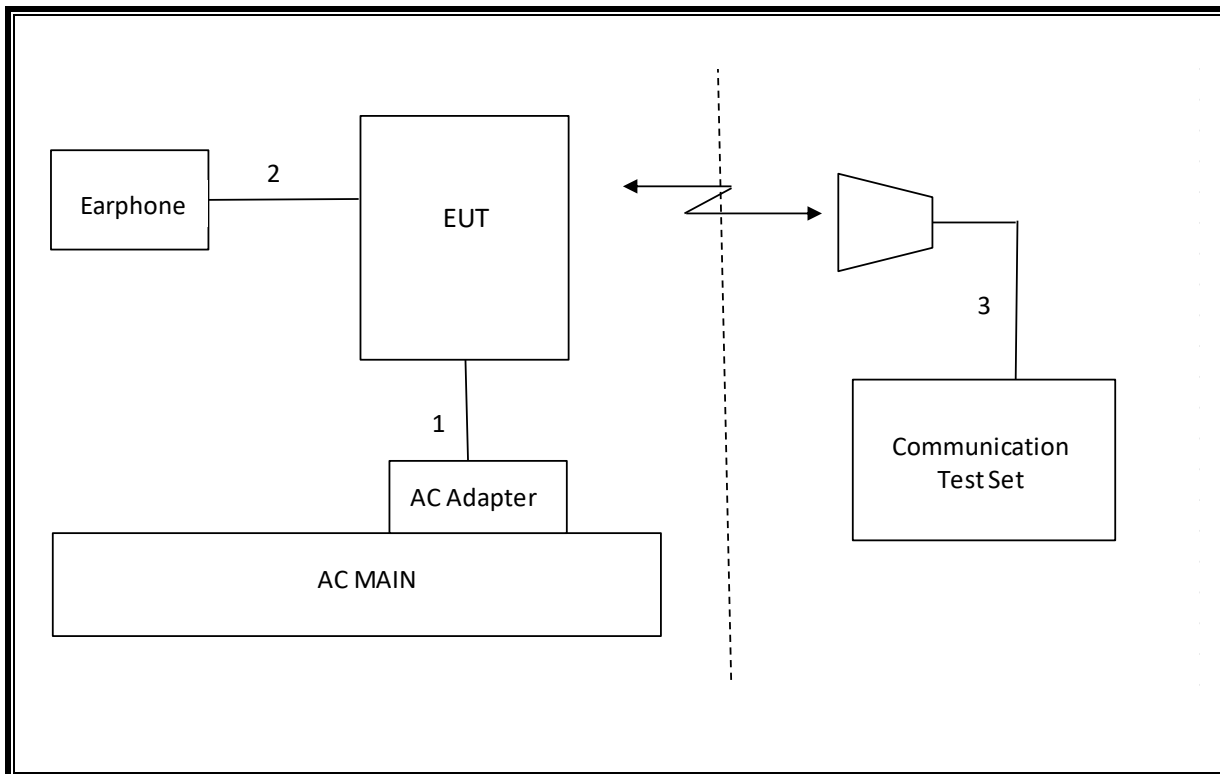

6. TEST AND MEASUREMENT EQUIPMENT

The following test and measurement equipment was utilized for the tests documented in this report:

Test Equipment List				
Description	Manufacturer	Model	S/N	Cal Due
Antenna, Tuned Dipole 400~1000 MHz	ETS	3121D DB4	00164753	06-30-19
Antenna, Horn, 40 GHz	ETS	3116C	00166155	12-04-19
Preamplifier	ETS	3116C-PA	00168841	08-09-19
Antenna, Horn, 40 GHz	ETS	3116C	00168645	12-04-19
Antenna, Bilog, 30MHz-1GHz	SCHWARZBECK	VULB9163	750	08-04-20
Antenna, Bilog, 30MHz-1GHz	SCHWARZBECK	VULB9163	845	08-04-20
Antenna, Bilog, 30MHz-1GHz	SCHWARZBECK	VULB9163	749	08-04-20
Antenna, Horn, 18 GHz	ETS	3115	00167211	08-04-20
Antenna, Horn, 18 GHz	ETS	3115	00161451	08-04-20
Antenna, Horn, 18 GHz	ETS	3117	00168724	08-04-20
Antenna, Horn, 18 GHz	ETS	3117	00205959	08-04-20
Antenna, Horn, 18 GHz	ETS	3117	00168717	08-04-20
Combiner	WEINSCHTEL	1575	2152	08-08-19
Communications Test Set	R&S	CMW500	115331	08-07-19
DC Power Supply	Agilent / HP	E3640A	MY54226395	08-06-19
Preamplifier, 1000 MHz	Sonoma	310N	341282	08-07-19
Preamplifier, 1000 MHz	Sonoma	310N	370599	08-06-19
Preamplifier, 1000 MHz	Sonoma	310N	351741	08-07-19
Preamplifier, 18 GHz	Miteq	AFS42-00101800-25-S-42	1876511	08-07-19
Preamplifier, 18 GHz	Miteq	AFS42-00101800-25-S-42	2029169	08-07-19
Preamplifier, 18 GHz	Miteq	AFS42-00101800-25-S-42	1896138	08-07-19
Spectrum Analyzer, 44 GHz	Agilent / HP	N9030A	MY54490312	08-06-19
EMI Test Receive, 40 GHz	R&S	ESU40	100439	08-06-19
EMI Test Receive, 40 GHz	R&S	ESU40	100457	08-06-19
EMI Test Receive, 44 GHz	R&S	ESW40	101590	08-06-19
High Pass Filter 1.2GHz	Micro-Tronics	HPM50108-02	G005	08-08-19
High Pass Filter 1.2GHz	Micro-Tronics	HPM50108-02	G006	08-08-19
High Pass Filter 2.8GHz	Micro-Tronics	HPM50111-02	010	08-08-19
High Pass Filter 2.8GHz	Micro-Tronics	HPM50111-02	011	08-08-19
High Pass Filter 4GHz	Micro-Tronics	HPM50118-02	G001	08-08-19
High Pass Filter 4GHz	Micro-Tronics	HPM50118-02	G002	08-08-19
Attenuator	PASTERNAK	PE7087-10	A009	08-08-19
Attenuator	PASTERNAK	PE7087-10	A001	08-08-19
Attenuator	PASTERNAK	PE7087-10	A008	08-08-19
Attenuator	PASTERNAK	PE7087-10	2	08-07-19
Attenuator	PASTERNAK	PE7395-10	A011	08-08-19
Antenna, Loop, 9kHz-30MHz	R&S	HFH2-Z2	100418	10-26-19
Temperature Chamber	ESPEC	SH-642	93001109	08-06-19
UL Software				
Description	Manufacturer	Model	Version	
Antenna port test software	UL	CLT	Ver 2.5	

7. SUMMARY TABLE

FCC Part Section	Test Description	Test Limit	Test Condition	Test Result
2.1049	Occupied Band width (99%)	N/A	Conducted	Pass
22.917(a) 24.238(a)	Band Edge / Conducted Spurious Emission	-13dBm		Pass
27.53(m)	Conducted Spurious Emission	-25 dBm		Pass
27.53(m)	Emission mask	Section 9.2.2		Pass
2.1046	Conducted output power	N/A		See the RF exposure test report. (4788805451-S1 FCC Report SAR)
22.355 24.235 27.54	Frequency Stability	2.5PPM		Pass
22.913(a)(5)	Effective Radiated Power	38.5 dBm	Radiated	Pass
24.232(c) 27.50(h)(2)	Equivalent Isotropic Radiated Power	33dBm		Pass
22.917(a) 24.238(a)	Radiated Spurious Emission	-13dBm		Pass
27.53 (m)		-25dBm		Pass

8. PEAK TO AVERAGE RATIO

Test Procedure

Per KDB 971168 D01 Power Meas License Digital Systems v03r01;

The transmitter output was connected to a CMW500 Test Set and configured to operate at maximum power. The PAR were measured on the Spectrum Analyzer.

Test Spec

In addition, when the transmitter power is measured in terms of average value, the peak-to-average ratio of the power shall not exceed 13 dB.

RESULTS

8.1. CONDUCTED PEAK TO AVERAGE RESULT

GSM

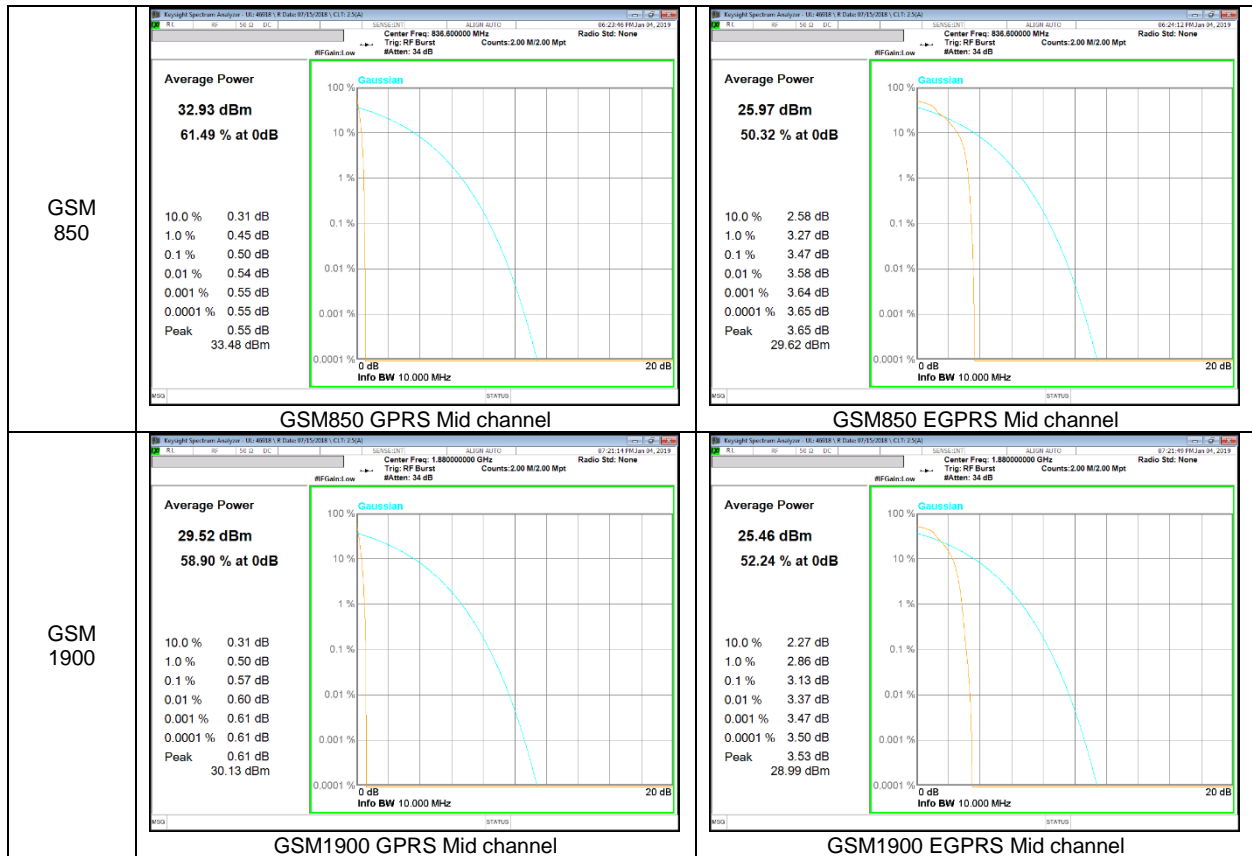

WCDMA

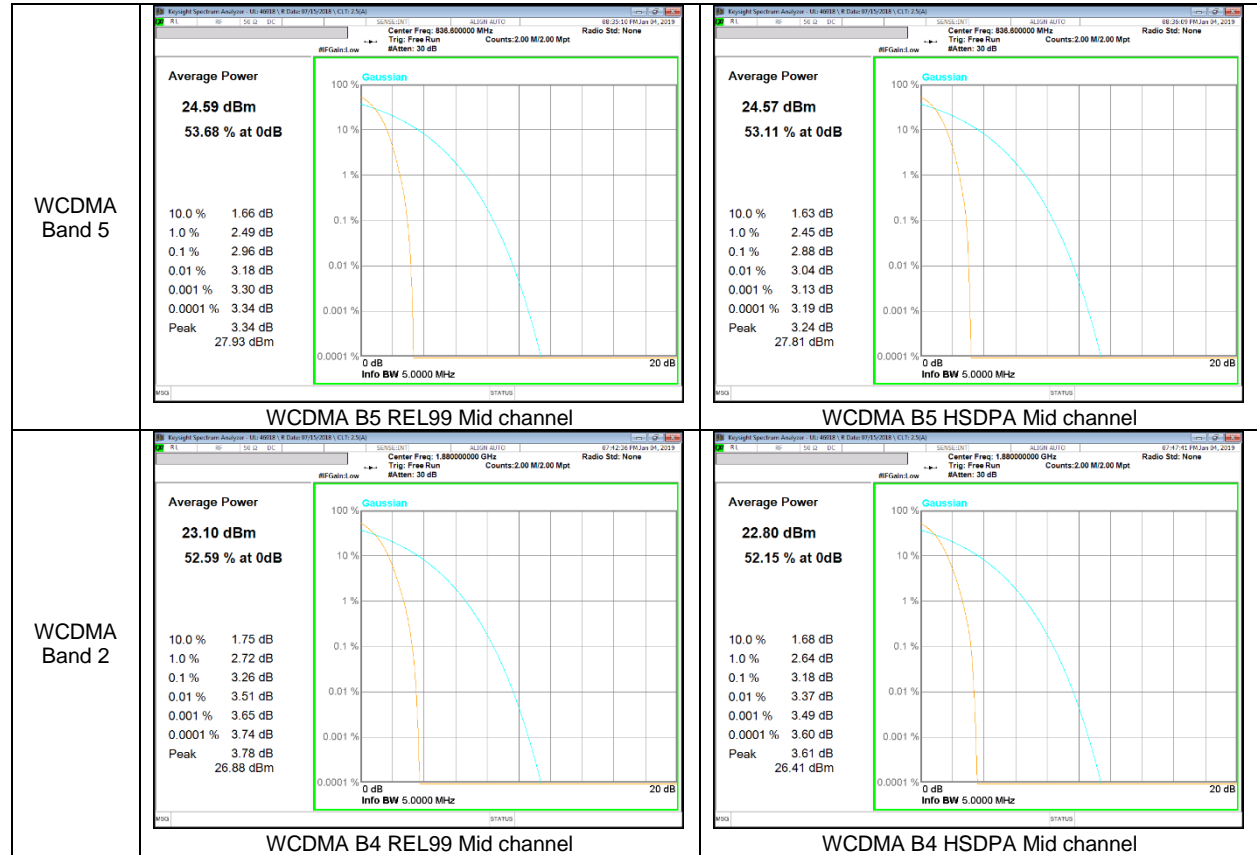

LTE Band 5

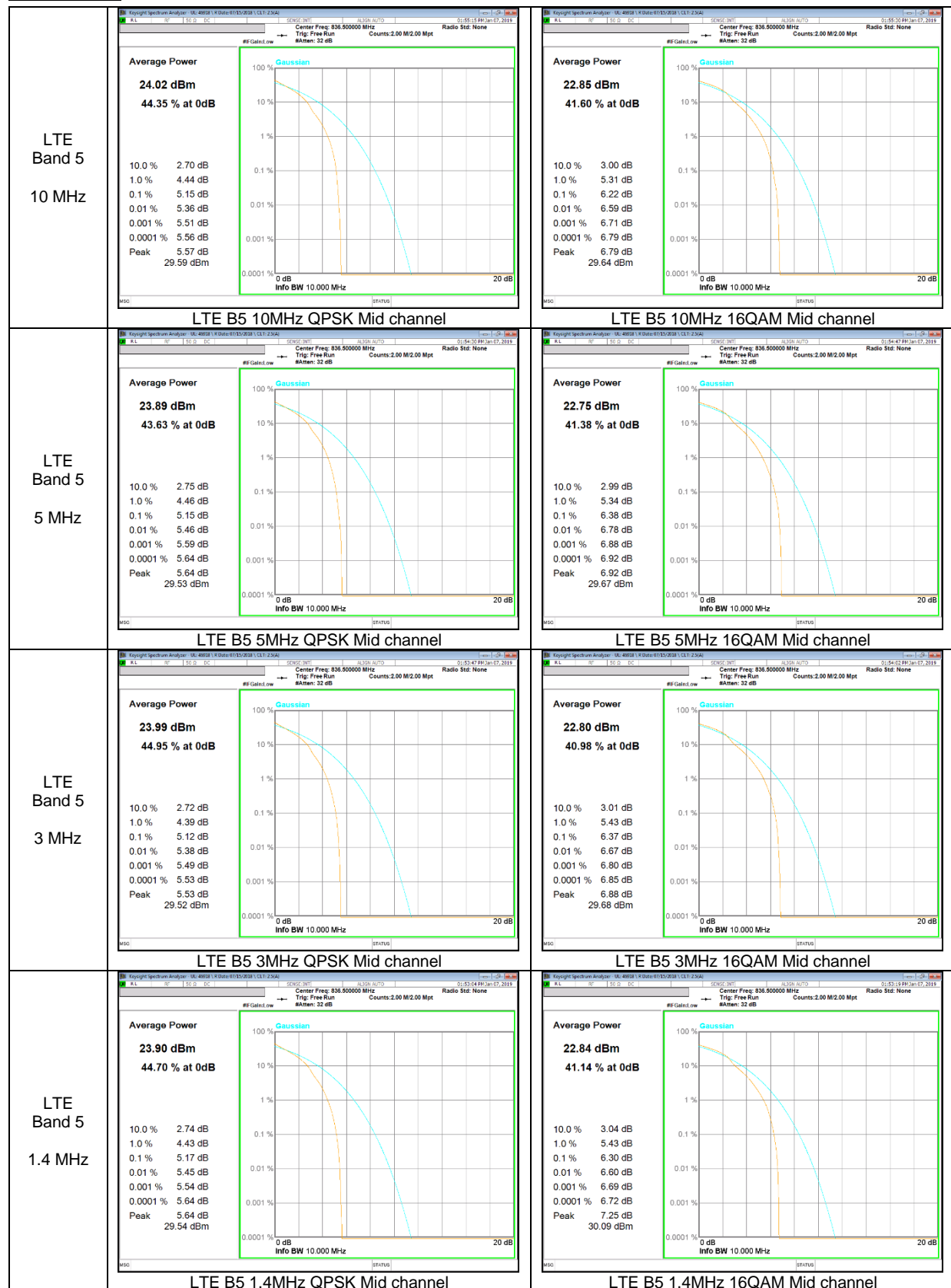

LTE Band 41

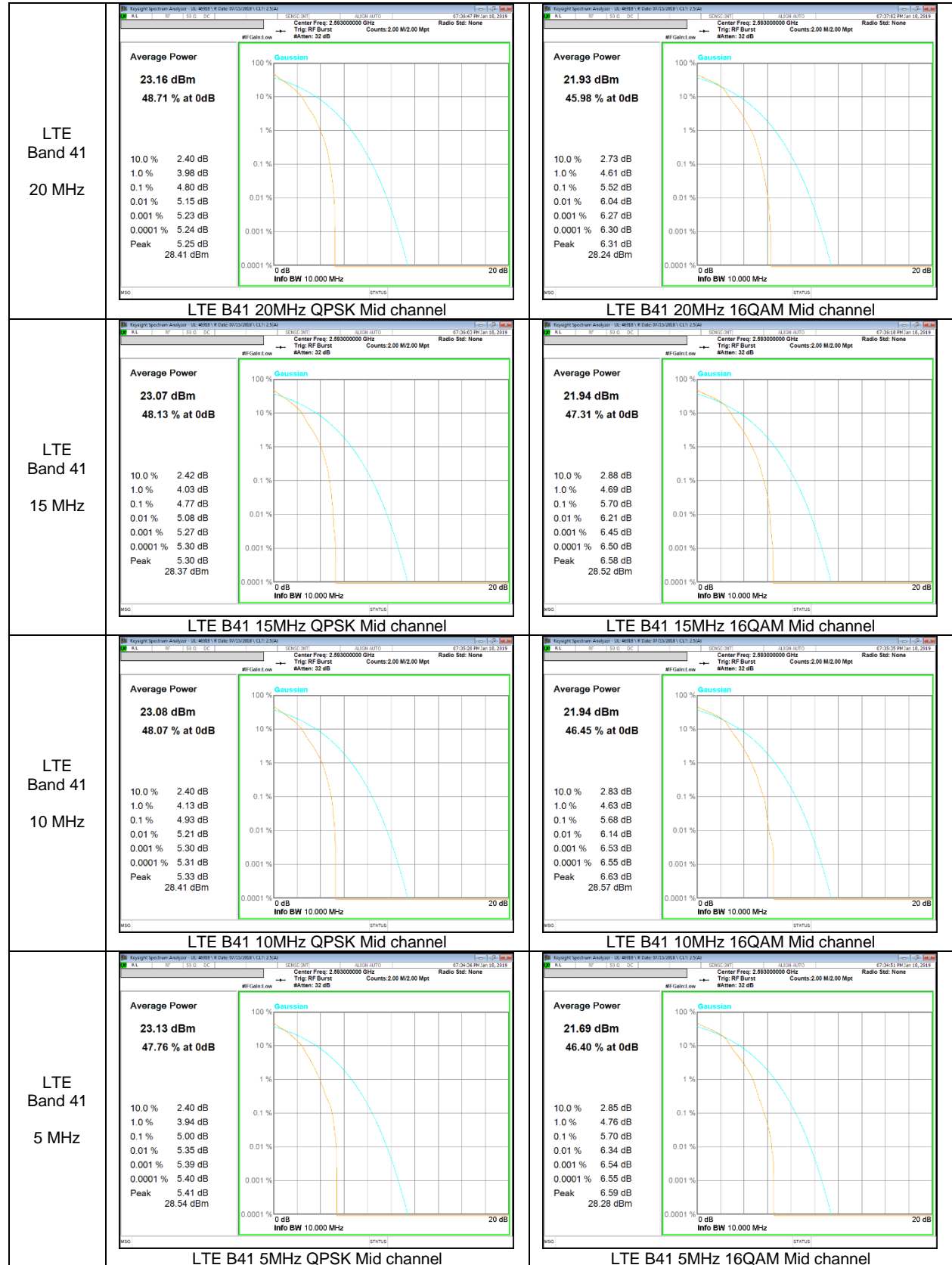

9. LIMITS AND CONDUCTED RESULTS

9.1. OCCUPIED BANDWIDTH

RULE PART(S)

FCC: §2.1049

LIMITS

For reporting purposes only

TEST PROCEDURE

The transmitter output was connected to a calibrated coaxial cable and coupler, the other end of which was connected to a spectrum analyzer. The occupied bandwidth was measured with the spectrum analyzer at the low, middle and high channel in each band. The -26dB bandwidth was also measured and recorded.

(KDB 971168 D01 Power Meas License Digital Systems v03r01)

RESULTS

See the following pages.

9.1.1. OCCUPIED BANDWIDTH RESULTS

GSM 850



GSM 1900



WCDMA Band 5

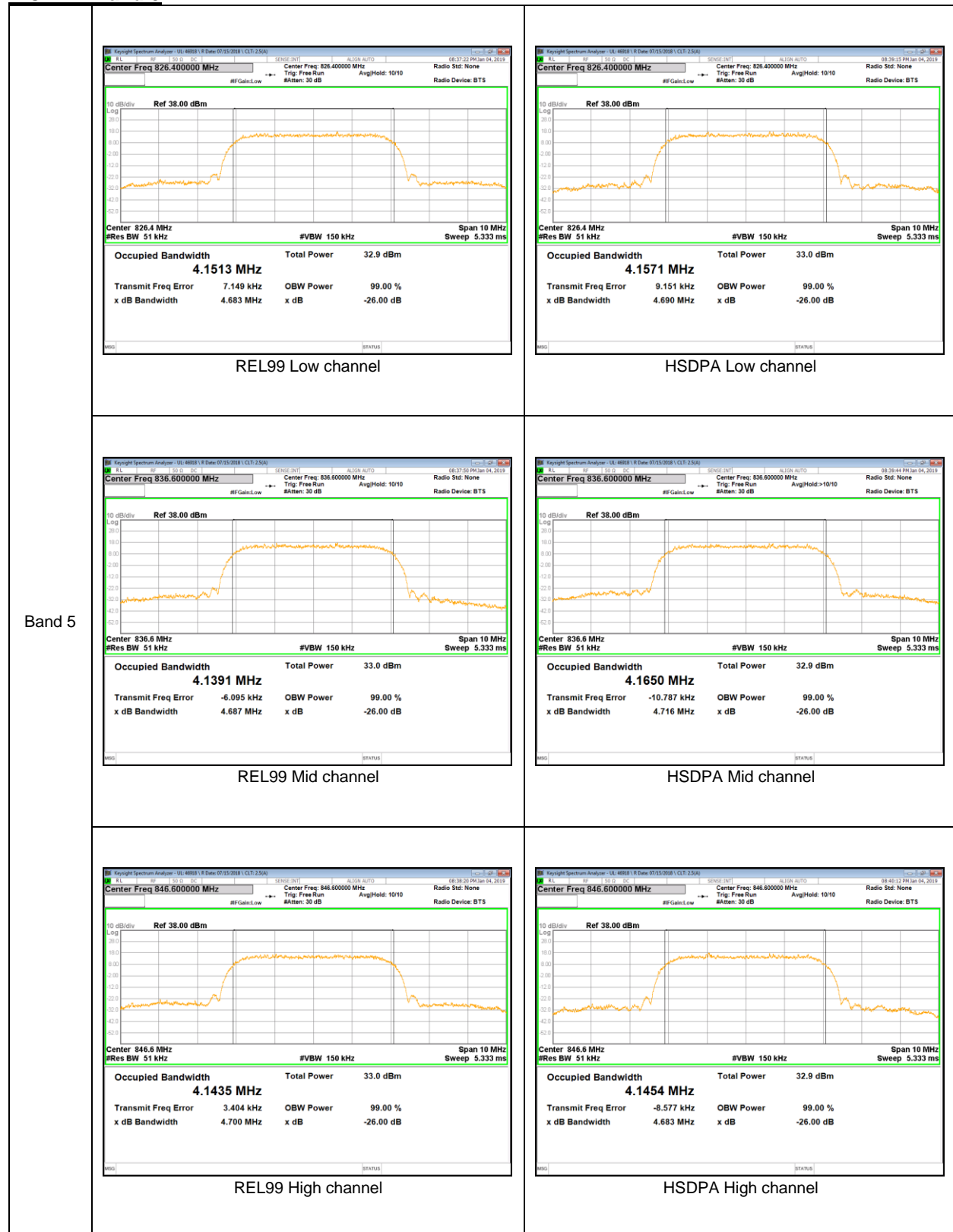

WCDMA Band 2

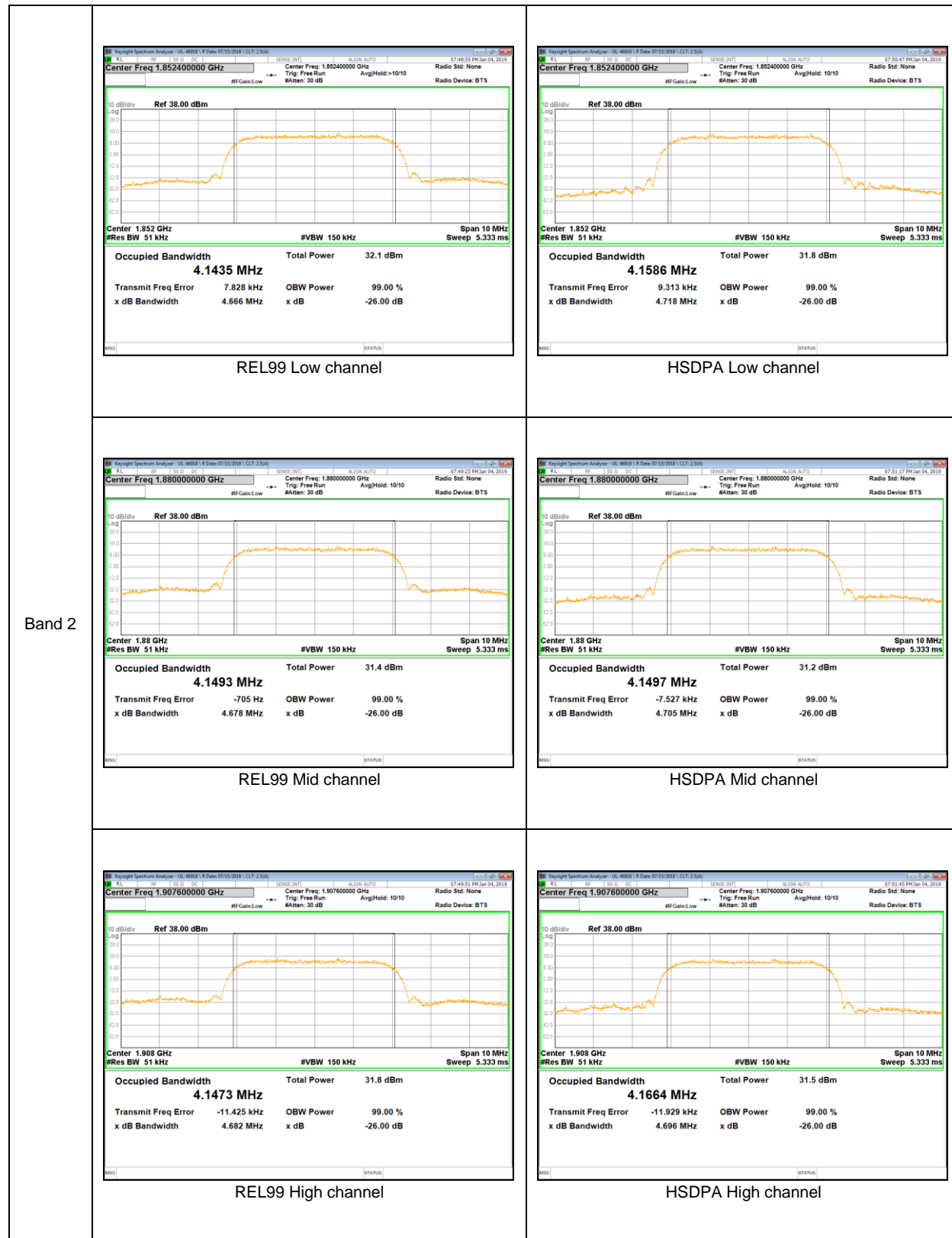

LTE Band 5

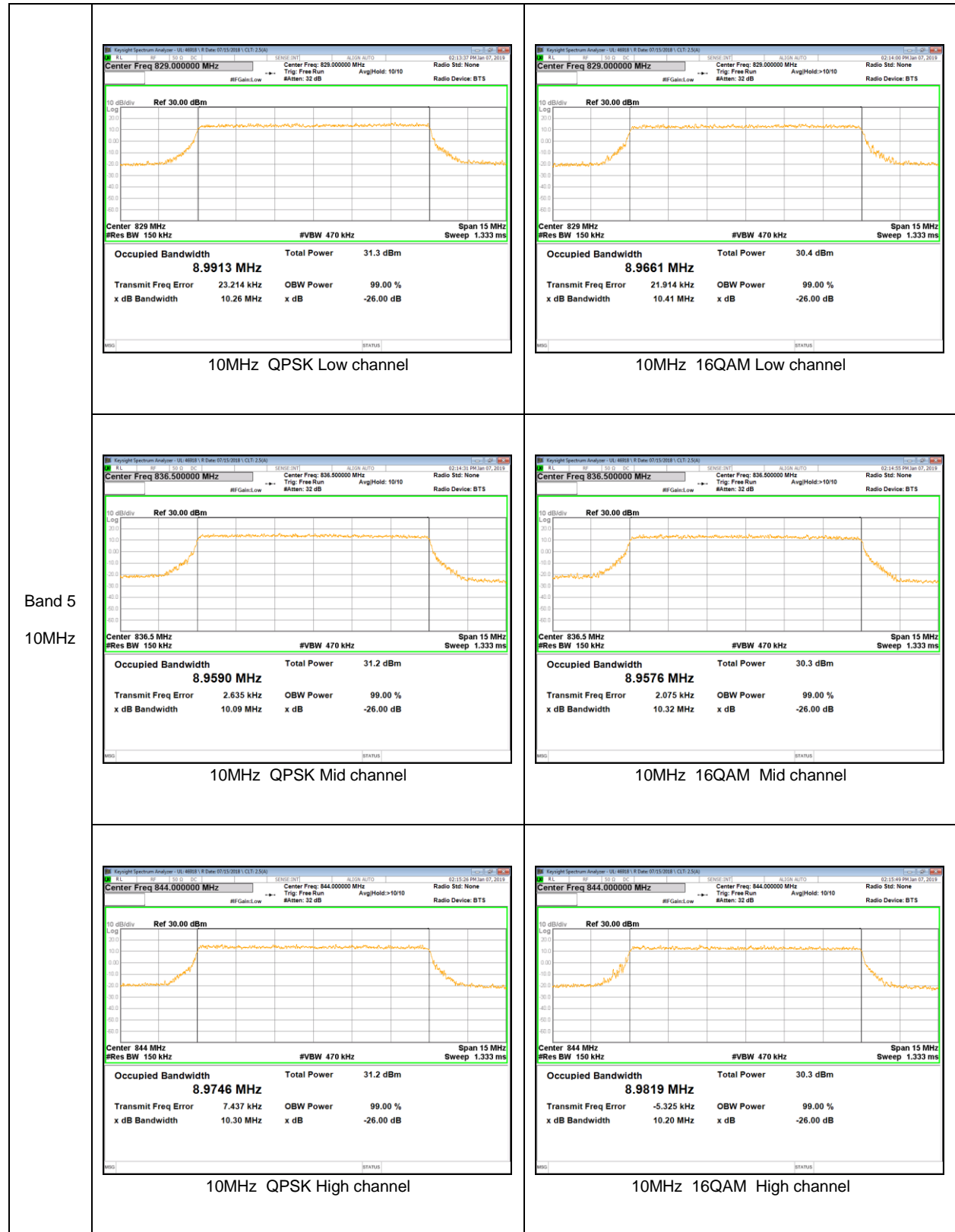

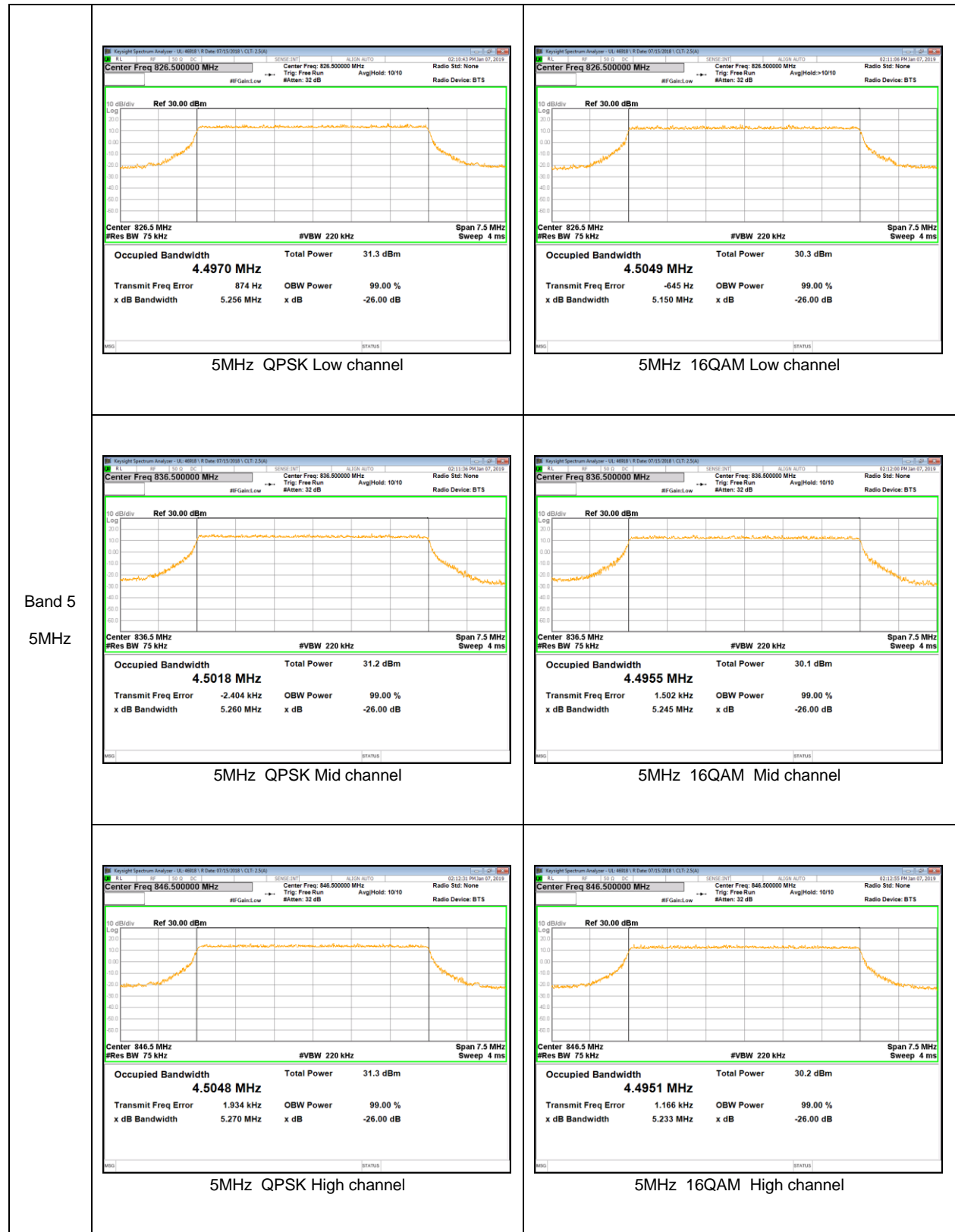



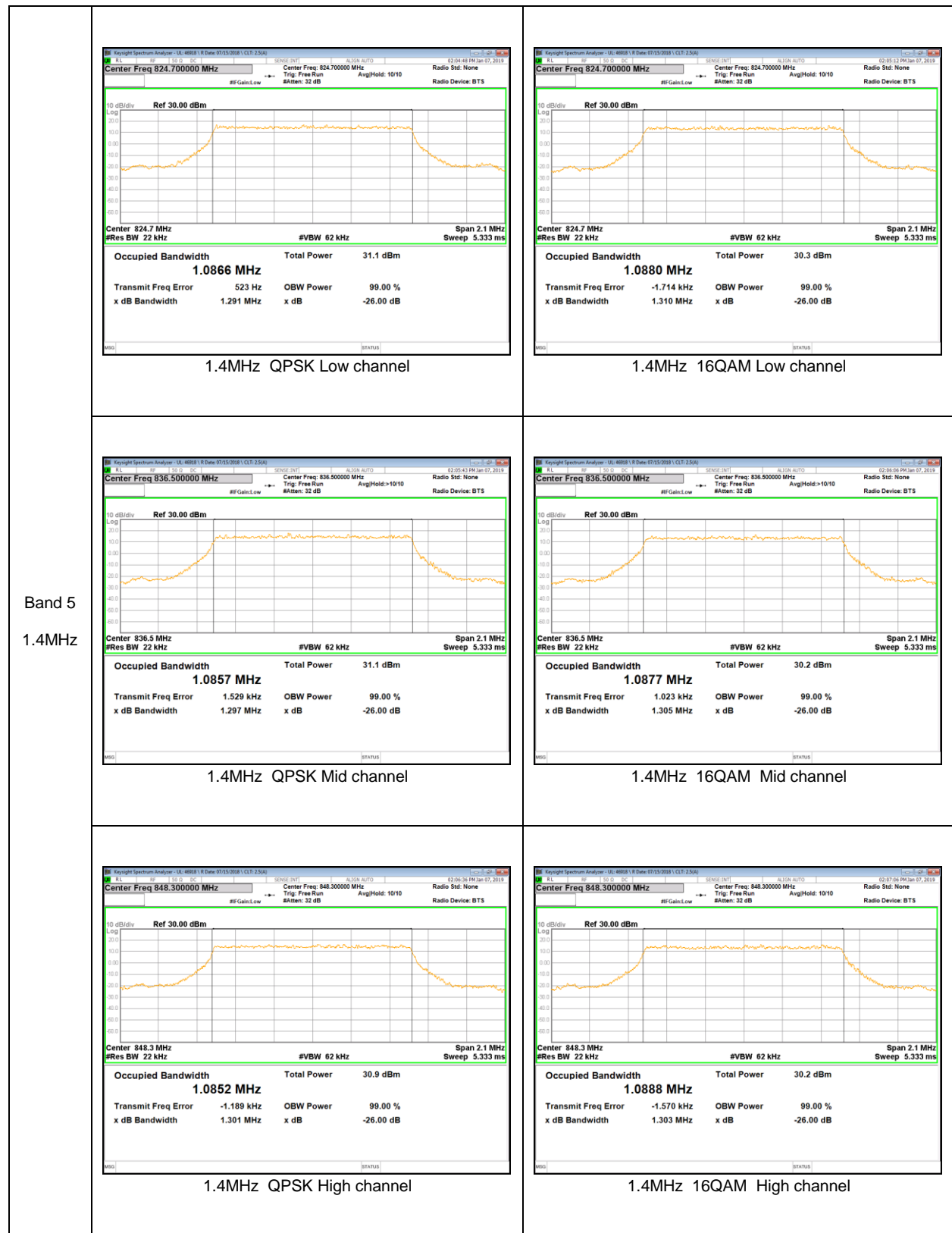

LTE Band 41

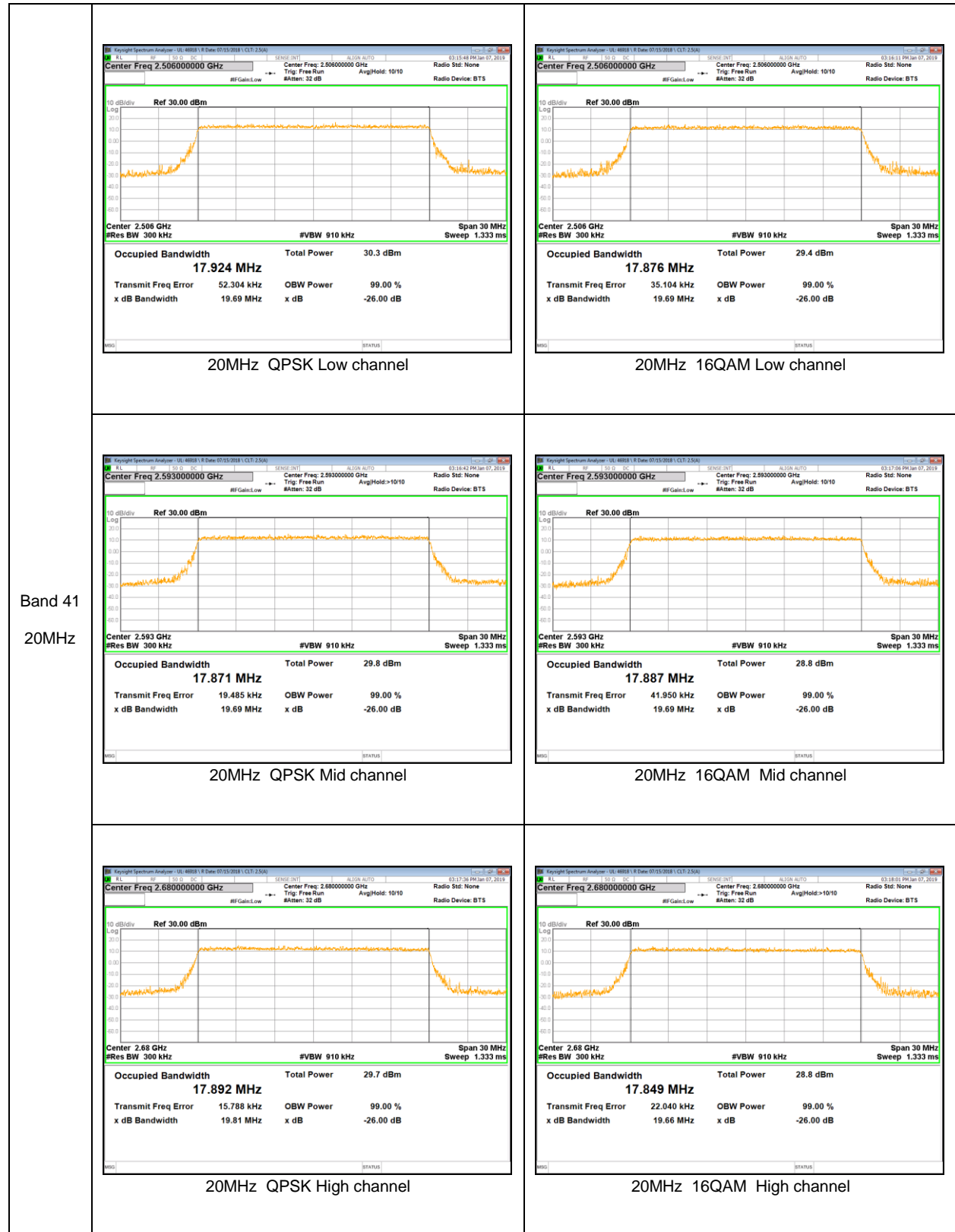

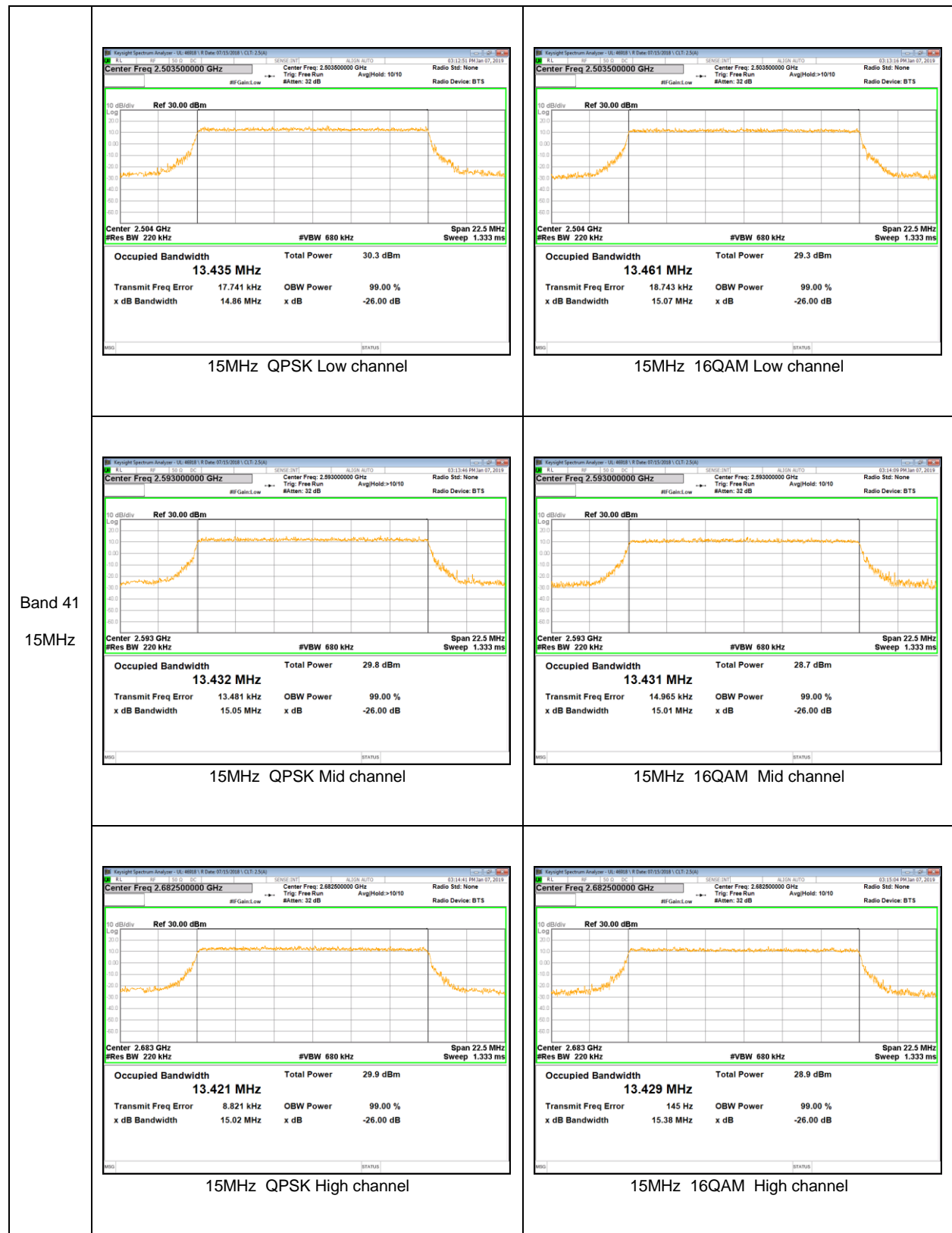

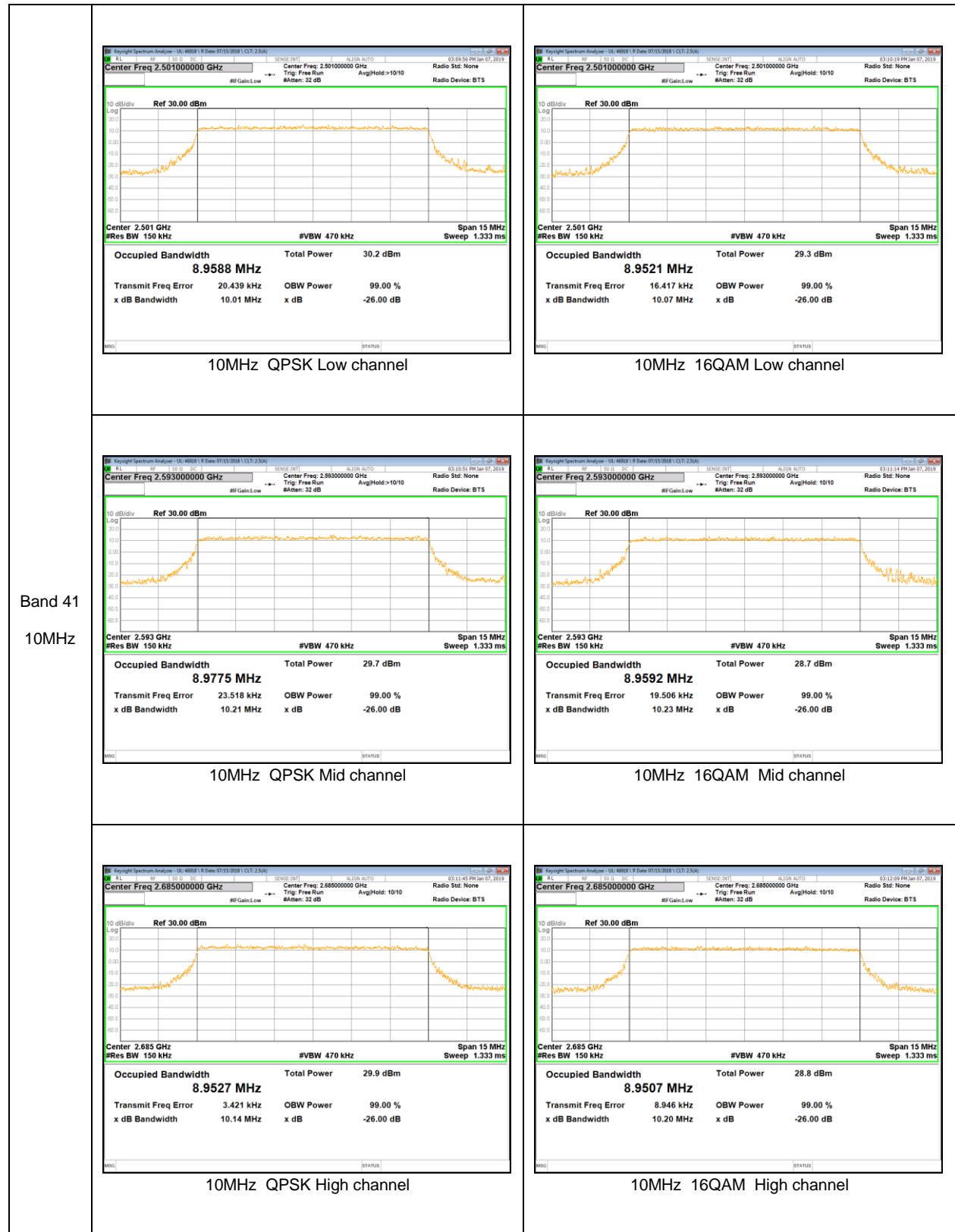

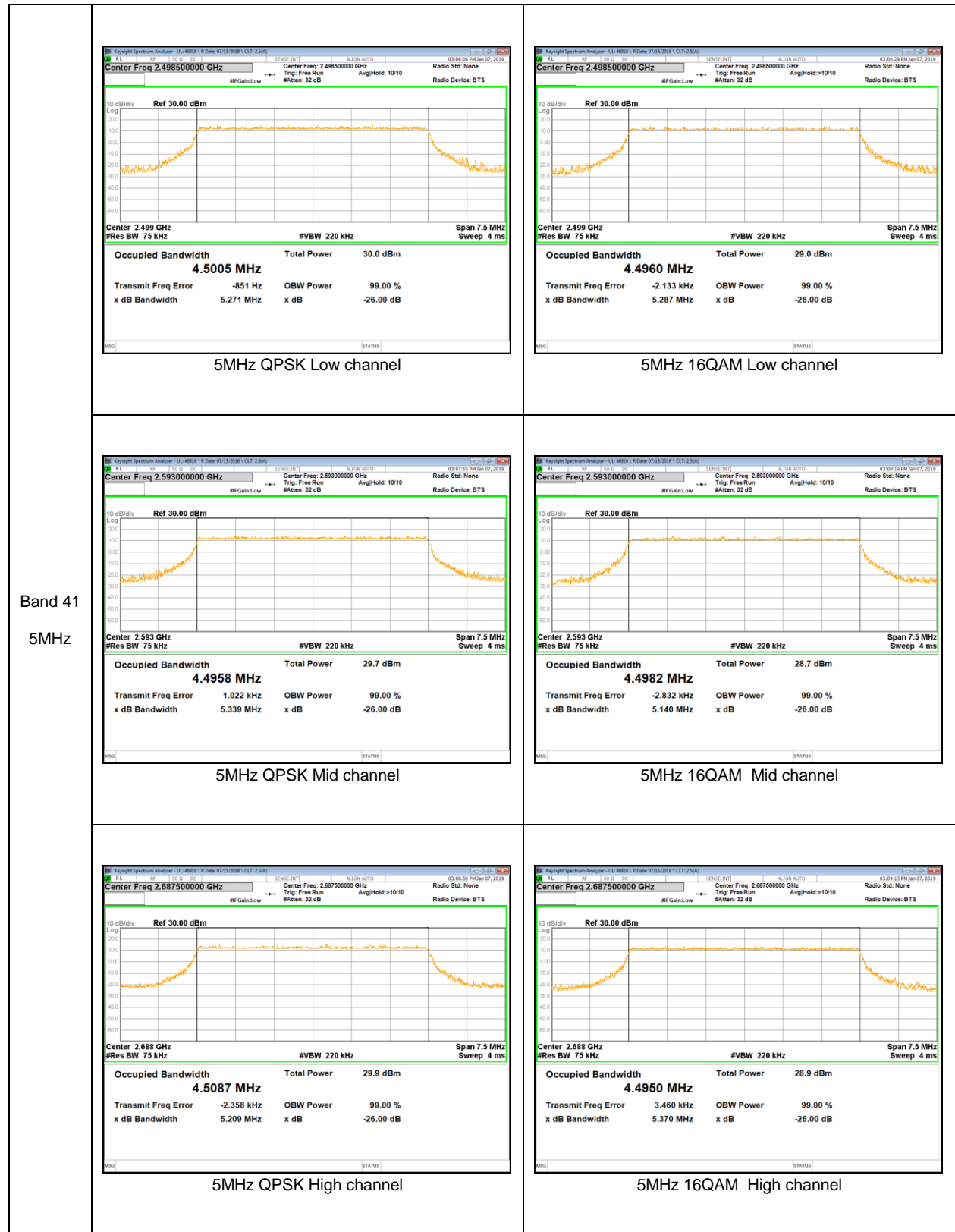

9.2. BAND EDGE EMISSIONS

RULE PART(S)

FCC: §22.359, §22.917, §24.238 and §27.53

LIMITS

The power of any emission outside of the authorized operating frequency ranges must be attenuated below the transmitting power (P) by a factor of at least $43 + 10 \log (P)$ dB.

27.53(m) (4) For mobile digital stations, the attenuation factor shall be not less than $40 + 10 \log (P)$ dB on all frequencies between the channel edge and 5 megahertz from the channel edge, $43 + 10 \log (P)$ dB on all frequencies between 5 megahertz and X megahertz from the channel edge, and $55 + 10 \log (P)$ dB on all frequencies more than X megahertz from the channel edge, where X is the greater of 6 megahertz or the actual emission bandwidth as defined in paragraph (m)(6) of this section. In addition, the attenuation factor shall not be less than $43 + 10 \log (P)$ dB on all frequencies between 2490.5 MHz and 2496 MHz and $55 + 10 \log (P)$ dB at or below 2490.5 MHz. Mobile Satellite Service licensees operating on frequencies below 2495 MHz may also submit a documented interference complaint against BRS licensees operating on channel BRS Channel 1 on the same terms and conditions as adjacent channel BRS or EBS licensees.

TEST PROCEDURE

Per KDB 971168 D01 Power Meas License Digital Systems v03r01

The transmitter output was connected to a CMW500 Test Set and configured to operate at maximum power. The band edge emissions were measured at the required operating frequencies in each band on the Spectrum Analyzer.

GSM

- a) Set the RBW = 1 ~ 5% of OBW(GSM850 – 8.2KHz, GSM1900 – 9.1KHz)
- b) Set VBW $\geq 3 \times$ RBW;
- c) Set span ≥ 1.5 times the OBW;
- d) Sweep time = 1S ;
- e) Detector = RMS;
- f) Ensure that the number of measurement points $\geq 2 \times$ Span/RBW;
- g) Trace mode = Average(100);
- h) Add duty cycle correction factor (9dB)

WCDMA/LTE

- a) Set the RBW = 1 ~ 1.5 % of OBW(Typically limited to a minimum RBW of 1% of the OBW)
- b) Set VBW $\geq 3 \times$ RBW;
- c) Set span ≥ 1.5 times the OBW;
- d) Sweep time = Auto;
- e) Detector = RMS;
- f) Ensure that the number of measurement points $\geq 2 \times$ Span/RBW;
- g) Trace mode = Average (100);

NOTE1

LTE Band 41 - Duty cycle correction factor(2.25dB) already applied on the plot.

RESULTS

See the following pages.