



FCC CFR47 PART 15 SUBPART C

Bluetooth

CERTIFICATION TEST REPORT

FOR

GSM/WCDMA/LTE Phone + BT/BLE, DTS/UNII a/b/g/n/ac, ANT+ and NFC

MODEL NUMBER : SM-A405FN/DS

FCC ID: A3LSMA405FN

REPORT NUMBER: 4788874100-E4V1

ISSUE DATE: FEB 28, 2019

Prepared for
SAMSUNG ELECTRONICS CO., LTD.
129 SAMSUNG-RO, YEONGTONG-GU, SUWON-SI,
GYEONGGI-DO, 16677, KOREA

Prepared by
UL Korea, Ltd.
26th floor, 152, Teheran-ro, Gangnam-gu Seoul, 06236, Korea

Suwon Test Site: UL Korea, Ltd. Suwon Laboratory
218 Maeyeong-ro, Yeongtong-gu,
Suwon-si, Gyeonggi-do, 16675, Korea
TEL: (031) 337-9902
FAX: (031) 213-5433



ACCREDITED*

Testing
Laboratory

TL-637

Revision History

<u>Rev.</u>	<u>Issue Date</u>	<u>Revisions</u>	<u>Revised By</u>
V1	02/28/19	Initial issue	Junwhan Lee

TABLE OF CONTENTS

1. ATTESTATION OF TEST RESULTS	5
2. TEST METHODOLOGY	6
3. FACILITIES AND ACCREDITATION	6
4. CALIBRATION AND UNCERTAINTY	6
4.1. MEASURING INSTRUMENT CALIBRATION.....	6
4.2. SAMPLE CALCULATION.....	6
4.3. MEASUREMENT UNCERTAINTY	6
5. EQUIPMENT UNDER TEST	7
5.1. DESCRIPTION OF EUT.....	7
5.1. MAXIMUM OUTPUT POWER.....	7
5.2. DESCRIPTION OF AVAILABLE ANTENNAS	7
5.3. WORST-CASE CONFIGURATION AND MODE	7
5.4. DESCRIPTION OF TEST SETUP	8
6. MEASUREMENT METHODS	10
7. TEST AND MEASUREMENT EQUIPMENT	11
8. REFERENCE MEASUREMENT RESULTS.....	12
8.1. ON TIME AND DUTY CYCLE RESULTS.....	12
8.2. 20 dB AND 99% BANDWIDTH.....	13
8.2.1. BASIC DATA RATE GFSK MODULATION.....	13
8.2.2. ENHANCED DATA RATE Pi/4-DQPSK MODULATION.....	13
8.2.3. ENHANCED DATA RATE 8PSK MODULATION	13
8.2.4. 20 dB AND 99% BANDWIDTH PLOTS.....	14
9. SUMMARY TABLE	17
10. ANTENNA PORT TEST RESULTS	18
10.1. HOPPING FREQUENCY SEPARATION	18
10.2. NUMBER OF HOPPING CHANNELS.....	19
10.3. AVERAGE TIME OF OCCUPANCY.....	23
10.4. OUTPUT POWER.....	31
10.4.1. BASIC DATA RATE GFSK MODULATION.....	31
10.4.2. ENHANCED DATA RATE Pi/4-DPSK MODULATION	31
10.4.3. ENHANCED DATA RATE 8PSK MODULATION	31
10.4.4. OUTPUT POWER PLOTS.....	32
10.5. AVERAGE POWER.....	35

10.5.1.	BASIC DATA RATE GFSK MODULATION.....	35
10.5.2.	DATA RATE PI/4-DQPSK MODULATION	35
10.5.3.	ENHANCED DATA RATE 8PSK MODULATION	35
10.6.	CONDUCTED SPURIOUS EMISSIONS.....	36
10.6.1.	BASIC DATA RATE GFSK MODULATION.....	37
11.	RADIATED TEST RESULTS	49
11.1.	LIMITS AND PROCEDURE	49
11.1.	TRANSMITTER ABOVE 1 GHz	51
11.1.1.	BASIC DATA RATE GFSK MODULATION.....	51
11.1.2.	ENHANCED DATA RATE 8PSK MODULATION	61
11.2.	WORST-CASE BELOW 1 GHz.....	71
12.	AC POWER LINE CONDUCTED EMISSIONS	73
13.	SETUP PHOTOS	78

1. ATTESTATION OF TEST RESULTS

COMPANY NAME: SAMSUNG ELECTRONICS CO., LTD.
EUT DESCRIPTION: GSM/WCDMA/LTE Phone + BT/BLE, DTS/UNII a/b/g/n/ac, ANT+ and NFC
MODEL NUMBER: SM-A405FN/DS
SERIAL NUMBER: R38M10DYWWJ (CONDUCTED)
R38M10DYWJA, R38M10DYX2A (RADIATED);
DATE TESTED: FEB 22, 2019 – FEB 28, 2019;

APPLICABLE STANDARDS	
STANDARD	TEST RESULTS
CFR 47 Part 15 Subpart C	Pass

UL Korea, Ltd. tested the above equipment in accordance with the requirements set forth in the above standards. All indications of Pass/Fail in this report are opinions expressed by UL Korea, Ltd. based on interpretations and/or observations of test results. Measurement Uncertainties were not taken into account and are published for informational purposes only. The test results show that the equipment tested is capable of demonstrating compliance with the requirements as documented in this report.

Note: The results documented in this report apply only to the tested sample, under the conditions and modes of operation as described herein. This document JUN not be altered or revised in any way unless done so by UL Korea, Ltd. and all revisions are duly noted in the revisions section. Any alteration of this document not carried out by UL Korea, Ltd. will constitute fraud and shall nullify the document. This report must not be used by the client to claim product certification, approval, or endorsement by IAS, any agency of the Federal Government, or any agency of any government.

Approved & Released For
UL Korea, Ltd. By:

Tested By:



SungGil Park
Suwon Lab Engineer
UL Korea, Ltd.

Junwhan Lee
Suwon Lab Engineer
UL Korea, Ltd.

2. TEST METHODOLOGY

The tests documented in this report were performed in accordance with following methods.

1. FCC CFR 47 Part 2.
2. FCC CFR 47 Part 15.
3. 558074 D01 15.247 Meas Guidance v05r01
4. ANSI C63.10-2013.

3. FACILITIES AND ACCREDITATION

The test sites and measurement facilities used to collect data are located at 218 Maeyeong-ro, Yeongtong-gu, Suwon-si, Gyeonggi-do, 16675, Korea. Line conducted emissions are measured only at the 218 address. The following table identifies which facilities were utilized for radiated emission measurements documented in this report. Specific facilities are also identified in the test results sections.

218 Maeyeong-ro	
<input checked="" type="checkbox"/>	Chamber 1
<input checked="" type="checkbox"/>	Chamber 2
<input type="checkbox"/>	Chamber 3

UL Korea, Ltd. is accredited by IAS, Laboratory Code TL-637. The full scope of accreditation can be viewed at <http://www.iasonline.org/PDF/TL/TL-637.pdf>.

4. CALIBRATION AND UNCERTAINTY

4.1. MEASURING INSTRUMENT CALIBRATION

The measuring equipment utilized to perform the tests documented in this report has been calibrated in accordance with the manufacturer's recommendations, and is traceable to recognized national standards.

4.2. SAMPLE CALCULATION

Where relevant, the following sample calculation is provided:

$$\begin{aligned} \text{Field Strength (dBuV/m)} &= \text{Measured Voltage (dBuV)} + \text{Antenna Factor (dB/m)} + \\ &\text{Cable Loss (dB)} - \text{Preamp Gain (dB)} \\ 36.5 \text{ dBuV} + 18.7 \text{ dB/m} + 0.6 \text{ dB} - 26.9 \text{ dB} &= 28.9 \text{ dBuV/m} \end{aligned}$$

4.3. MEASUREMENT UNCERTAINTY

Where relevant, the following measurement uncertainty levels have been estimated for tests performed on the apparatus:

PARAMETER	UNCERTAINTY
Conducted Disturbance, 0.15 to 30 MHz	2.32 dB
Radiated Disturbance, Below 1GHz	3.86 dB
Radiated Disturbance, Above 1 GHz	5.97 dB

Uncertainty figures are valid to a confidence level of 95%.

5. EQUIPMENT UNDER TEST

5.1.DESCRPTION OF EUT

The EUT is a GSM/WCDMA/LTE Phone + BT/BLE, DTS/UNII a/b/g/n/ac, ANT+ and NFC. This test report addresses the DSS (BT) operational mode.

5.1.MAXIMUM OUTPUT POWER

The transmitter has a maximum conducted output power as follows:

Frequency Range [MHz]	Mode	Power Mode	Output Power [dBm]	Output Power [mW]
2402 - 2480	Basic GFSK	Average	10.036	10.083
		Peak	10.713	11.784
	Enhanced Pi/4-DPSK	Average	8.697	7.408
		Peak	10.915	12.345
	Enhanced 8PSK	Average	8.726	7.458
		Peak	11.548	14.282

5.2.DESCRPTION OF AVAILABLE ANTENNAS

The radio utilizes an internal antenna, with a maximum gain of -2.08 dBi.

5.3.WORST-CASE CONFIGURATION AND MODE

Radiated emission below 1GHz and power line conducted emission were performed with the EUT set to transmit at the channel with highest output power as worst-case scenario.

Radiated emission above 1GHz was performed with the EUT set to transmit low/mid/high channels.

The fundamental of the EUT was investigated in three orthogonal orientations X, Y and Z it was determined that Y orientation was worst-case orientation; therefore, all final radiated testing was performed with the EUT in Y orientation.

Note: GFSK, Pi/4-DQPSK, 8PSK average Power are all investigated, The GFSK & 8PSK Power are the worst case. Testing is based on this mode to showing compliance. For average power data please refer to section 9.5. All radiated and power line conducted tests were performed connected with earphone and charger for evaluation of worst case mode.

5.4.DESCRPTION OF TEST SETUP

SUPPORT EQUIPMENT

Support Equipment List				
Description	Manufacturer	Model	Serial Number	FCC ID
Charger	SAMSUNG	EP-TA200	R37KCHE3W01SE3	N/A
Data Cable	SAMSUNG	EP-D140AWE	N/A	N/A
Earphone	SAMSUNG	EHS61ASFWE	N/A	N/A

I/O CABLE

I/O Cable List						
Cable No	Port	# of identical ports	Connector Type	Cable Type	Cable Length (m)	Remarks
1	DC Power	1	C Type	Shielded	1.1m	N/A
2	Audio	2	Mini-Jack	Unshielded	1.2m	N/A

TEST SETUP

The EUT is continuously communicating to the Bluetooth tester during the tests.
 Test software enable BT communications.

SETUP DIAGRAM FOR TESTS (CONDUCTED TEST SETUP)

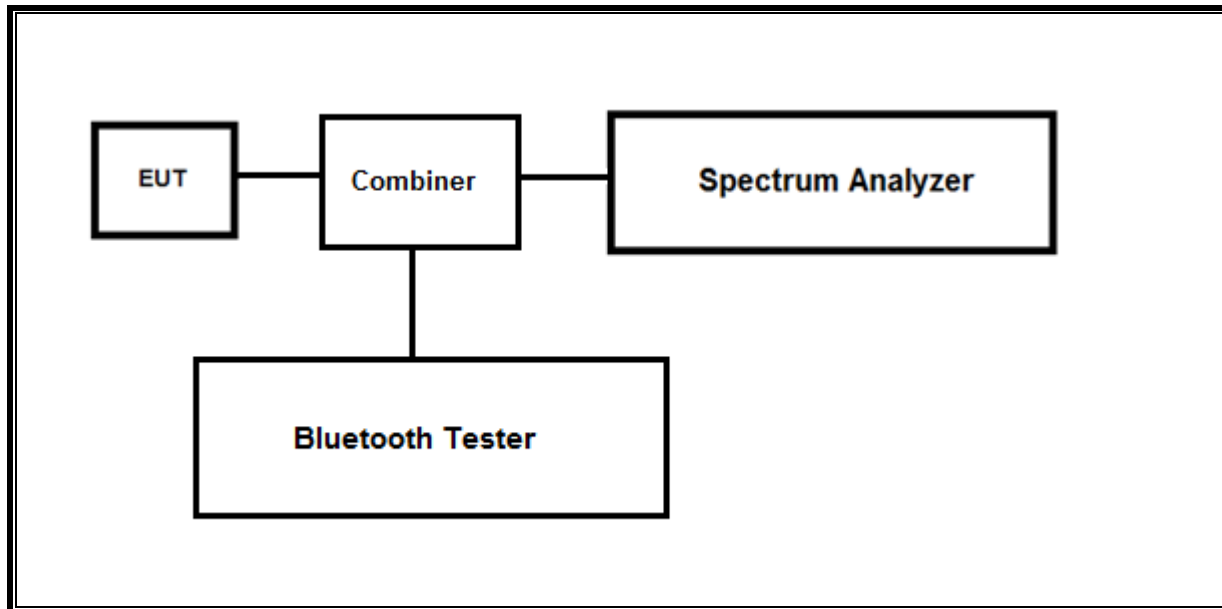

SETUP DIAGRAM FOR TESTS (RADIATED TEST SETUP)

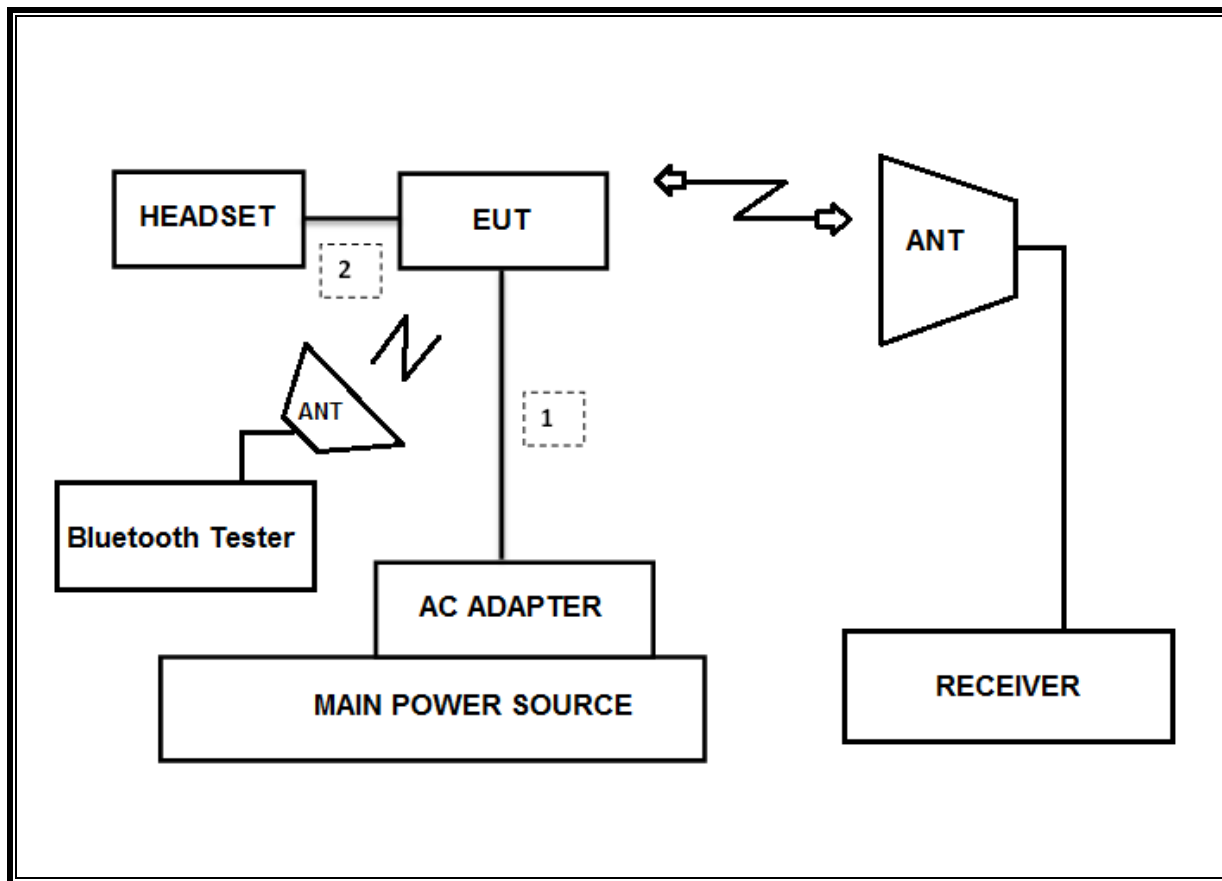

6. MEASUREMENT METHODS

20dB BW : ANSI C63.10, Section 6.9.2

99% BW : ANSI C63.10, Section 6.9.3

HOPPING FREQUENCY SEPARATION : ANSI C63.10, Section 7.8.2

NUMBER OF HOPPING CHANNELS : ANSI C63.10, Section 7.8.3

AVERAGE TIME OF OCCUPANCY : ANSI C63.10, Section 7.8.4

OUTPUT POWER : ANSI C63.10, Section 7.8.5.

Out-of-band EMISSIONS (Conducted) : ANSI C63.10, Section 7.8.6, 7.8.8

Out-of-band EMISSIONS IN NON-RESTRICTED BANDS: ANSI C63.10, Section 6.

Out-of-band EMISSIONS IN RESTRICTED BANDS : ANSI C63.10, Section 6.

AC Power Line Conducted Emission : ANSI C63.10-2013, Section 6.2.

7. TEST AND MEASUREMENT EQUIPMENT

The following test and measurement equipment was utilized for the tests documented in this report:

Test Equipment List				
Description	Manufacturer	Model	S/N	New Cal Due
Antenna, Bilog, 30MHz-1GHz	SCHWARZBECK	VULB9163	750	08-04-20
Antenna, Bilog, 30MHz-1GHz	SCHWARZBECK	VULB9163	749	08-04-20
Antenna, Bilog, 30MHz-1GHz	SCHWARZBECK	VULB9163	845	08-04-20
Antenna, Loop, 9kHz-30MHz	R&S	HFH2-Z2	100418	10-26-19
Antenna, Horn, 18 GHz	ETS	3115	00167211	08-04-20
Antenna, Horn, 18 GHz	ETS	3115	00161451	08-04-20
Antenna, Horn, 18 GHz	ETS	3117	00168724	08-04-20
Antenna, Horn, 18 GHz	ETS	3117	00168717	08-04-20
Antenna, Horn, 18 GHz	ETS	3117	00205959	08-04-20
Antenna, Horn, 40 GHz	ETS	3116C	00166155	12-04-19
Antenna, Horn, 40 GHz	ETS	3116C	00168645	12-04-19
Antenna, Horn, 40 GHz	ETS	3116C-PA	00168841	08-09-19
Preamplifier, 1000 MHz	Sonoma	310N	341282	08-07-19
Preamplifier, 1000 MHz	Sonoma	310N	351741	08-07-19
Preamplifier, 1000 MHz	Sonoma	310N	370599	08-06-19
Preamplifier, 18 GHz	Miteq	AFS42-00101800-25-S-42	1876511	08-07-19
Preamplifier, 18 GHz	Miteq	AFS42-00101800-25-S-42	1896138	08-07-19
Preamplifier, 18 GHz	Miteq	AFS42-00101800-25-S-42	2029169	08-07-19
Spectrum Analyzer, 44 GHz	Agilent / HP	N9030A	MY54170614	08-07-19
Spectrum Analyzer, 44 GHz	Agilent / HP	N9030A	MY54490312	08-06-19
Spectrum Analyzer, 43.5 GHz	R&S	FSW43	104089	08-06-19
Average Power Sensor	Agilent / HP	U2000	MY54270007	08-07-19
Attenuator	PASTERNAK	PE7087-10	A001	08-08-19
Attenuator	PASTERNAK	PE7087-10	A008	08-08-19
Attenuator	PASTERNAK	PE7004-10	2	08-07-19
Attenuator	PASTERNAK	PE7087-10	A009	08-08-19
EMI Test Receive, 40 GHz	R&S	ESU40	100439	08-06-19
EMI Test Receive, 40 GHz	R&S	ESU40	100457	08-06-19
EMI Test Receive, 44 GHz	R&S	ESW44	101590	08-06-19
EMI Test Receive, 3 GHz	R&S	ESR3	101832	08-06-19
Low Pass Filter 5GHz	Micro-Tronics	LPS17541	009	08-07-19
Low Pass Filter 5GHz	Micro-Tronics	LPS17541	015	08-07-19
Low Pass Filter 5GHz	Micro-Tronics	LPS17541	020	08-06-19
High Pass Filter 3GHz	Micro-Tronics	HPM17543	010	08-07-19
High Pass Filter 3GHz	Micro-Tronics	HPM17543	015	08-07-19
High Pass Filter 3GHz	Micro-Tronics	HPM17543	020	08-06-19
High Pass Filter 6GHz	Micro-Tronics	HPS17542	009	08-07-19
High Pass Filter 6GHz	Micro-Tronics	HPS17542	016	08-07-19
High Pass Filter 6GHz	Micro-Tronics	HPS17542	021	08-06-19
LISN	R&S	ENV-216	101837	08-09-19
UL Software				
Description	Manufacturer	Model	Version	
Radiated software	UL	UL EMC	Ver 9.5	
AC Line Conducted software	UL	UL EMC	Ver 9.5	

8. REFERENCE MEASUREMENT RESULTS

8.1.ON TIME AND DUTY CYCLE RESULTS

LIMITS

None: for reporting purposes only.

Mode	ON Time B [msec]	Period [msec]	Duty Cycle x [linear]	Duty Cycle [%]	Duty Cycle Correction Factor [dB]	1/T Minimum VBW [kHz]
2400MHz Bands						
BT	2.879	3.750	0.768	76.8%	1.15	0.347

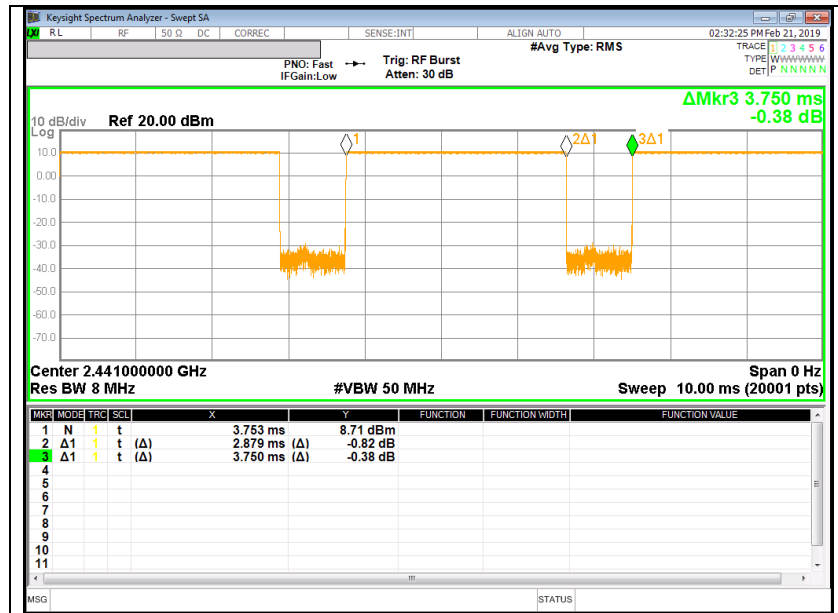

8.2.20 dB AND 99% BANDWIDTH

LIMITS

None; for reporting purposes only.

TEST PROCEDURE

The transmitter output is connected to a spectrum analyzer. The RBW is set to $\geq 1\%$ of the 20 dB bandwidth. The VBW is set to \geq RBW. The sweep time is coupled.

RESULTS

8.2.1. BASIC DATA RATE GFSK MODULATION

Channel	Frequency [MHz]	20 dB Bandwidth [MHz]	99% Bandwidth [kHz]
Low	2402	1.025	901.65
Mid	2441	1.022	897.85
High	2480	1.019	895.45
Worst		1.025	901.65

8.2.2. ENHANCED DATA RATE Pi/4-DQPSK MODULATION

Channel	Frequency [MHz]	20 dB Bandwidth [MHz]	99% Bandwidth [MHz]
Low	2402	1.243	1.166
Mid	2441	1.343	1.194
High	2480	1.349	1.166
Worst		1.349	1.194

8.2.3. ENHANCED DATA RATE 8PSK MODULATION

Channel	Frequency [MHz]	20 dB Bandwidth [MHz]	99% Bandwidth [MHz]
Low	2402	1.290	1.166
Mid	2441	1.273	1.165
High	2480	1.290	1.165
Worst		1.290	1.166

8.2.4. 20 dB AND 99% BANDWIDTH PLOTS

GFSK BANDWIDTH

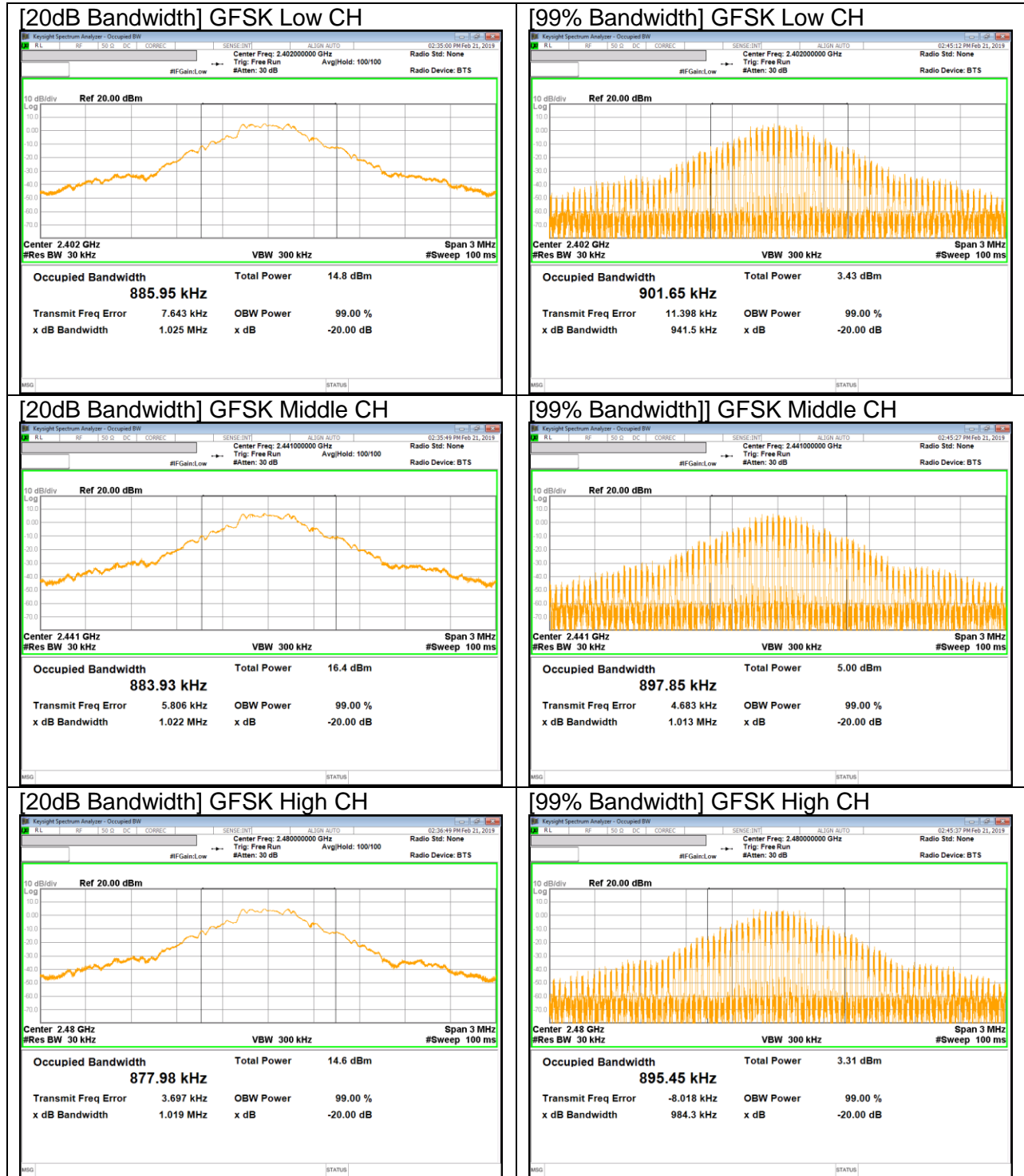

Pi/4-DQPSK BANDWIDTH

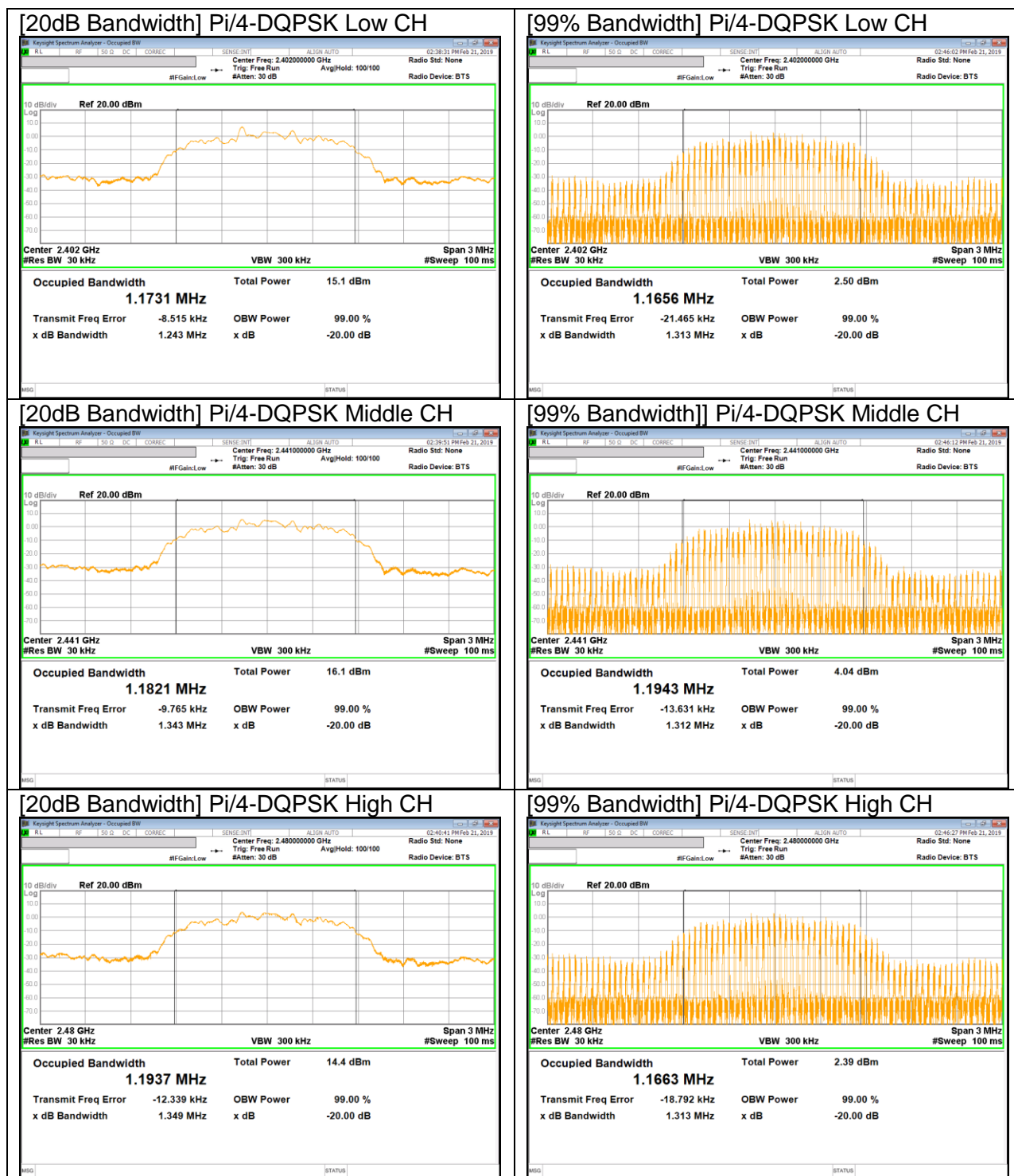

8PSK BANDWIDTH

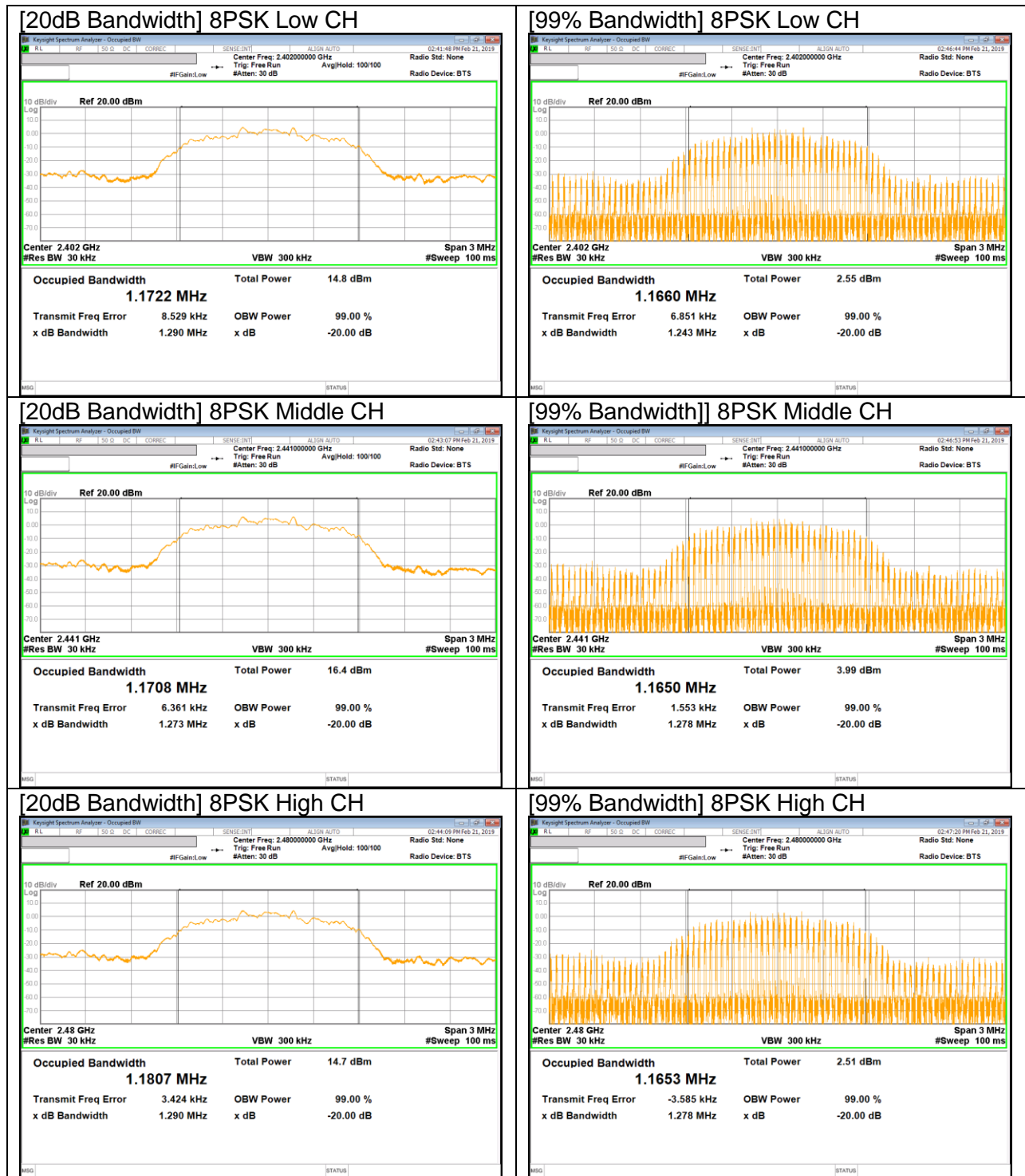

9. SUMMARY TABLE

FCC Part Section	Test Description	Test Limit	Test Condition	Test Result
2.1051, 15.247 (d)	Band Edge / Conducted Spurious Emission	-20dBc	Conducted	Pass
15.247 (b)(1)	TX conducted output power	<30dBm		Pass
15.247 (a)(1)	Hopping frequency separation	> two-thirds of the 20 dB bandwidth		Pass
15.247 (a)(1)(iii)	Number of Hopping channels	More than 15 non-overlapping channels		Pass
15.247 (a)(1)(iii)	Avg Time of Occupancy	< 0.4sec		Pass
15.207 (a)	AC Power Line conducted emissions	Section 10	Power Line conducted	Pass
15.205, 15.209	Radiated Spurious Emission	< 54dBuV/m	Radiated	Pass

10. ANTENNA PORT TEST RESULTS

10.1. HOPPING FREQUENCY SEPARATION

LIMIT

FCC §15.247 (a) (1)

Frequency hopping systems shall have hopping channel carrier frequencies separated by a minimum of 25 kHz or the 20 dB bandwidth of the hopping channel, whichever is greater.

Alternatively, frequency hopping systems operating in the 2400-2483.5 MHz band JUN have hopping channel carrier frequencies that are separated by 25 kHz or two-thirds of the 20 dB bandwidth of the hopping channel, whichever is greater, provided the systems operate with an output power no greater than 125 mW.

TEST PROCEDURE

The transmitter output is connected to a spectrum analyzer. The RBW is set to 300 kHz and the VBW is set to 300 kHz. The sweep time is coupled.

RESULTS

HOPPING FREQUENCY SEPARATION PLOT

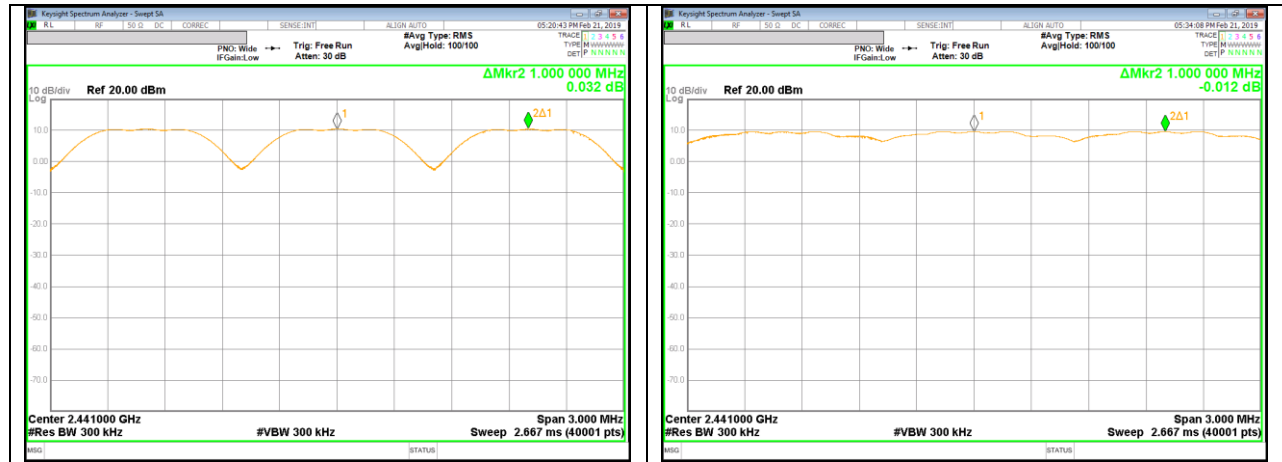

[GFSK]

[8PSK]

10.2. NUMBER OF HOPPING CHANNELS

LIMIT

FCC §15.247 (a) (1) (iii)

Frequency hopping systems in the 2400 – 2483.5 MHz band shall use at least 15 non-overlapping channels.

TEST PROCEDURE

The transmitter output is connected to a spectrum analyzer. The span is set to cover the entire authorized band, in either a single sweep or in multiple contiguous sweeps. The RBW is set to a maximum of 1 % of the span. The analyzer is set to Max Hold.

RESULTS

Normal Mode: 79 Channels observed.

NUMBER OF HOPPING CHANNELS (100 MHZ SPAN)

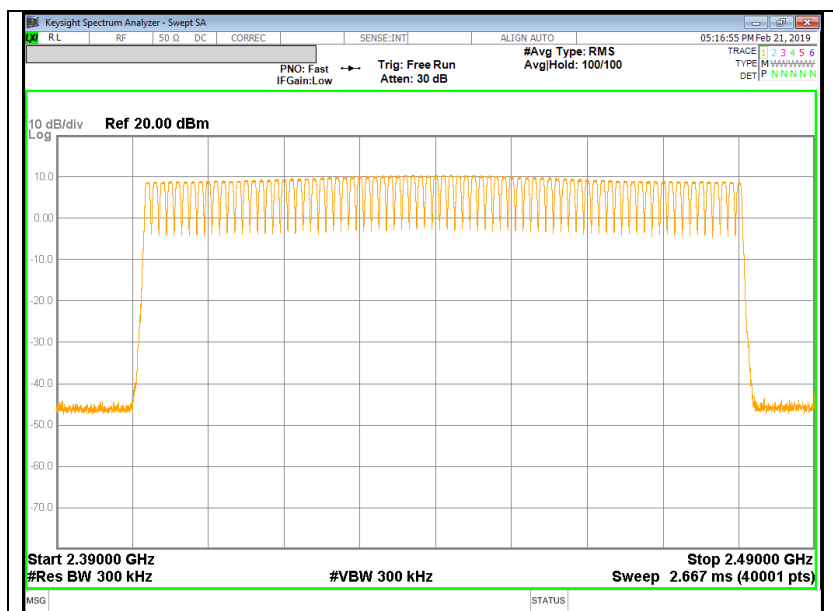

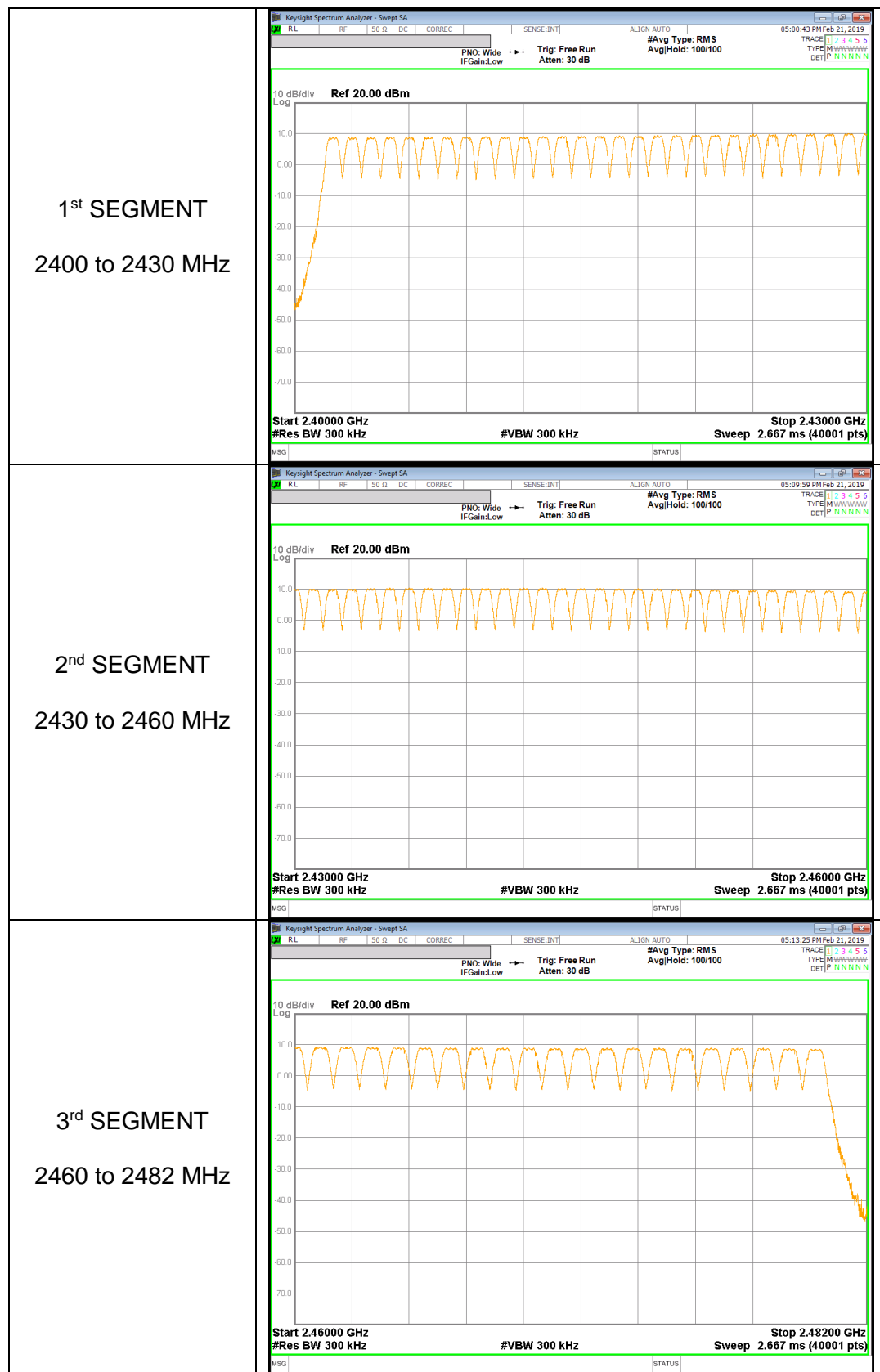

NUMBER OF HOPPING CHANNELS PLOTS[8PSK]

NUMBER OF HOPPING CHANNELS (100 MHZ SPAN)

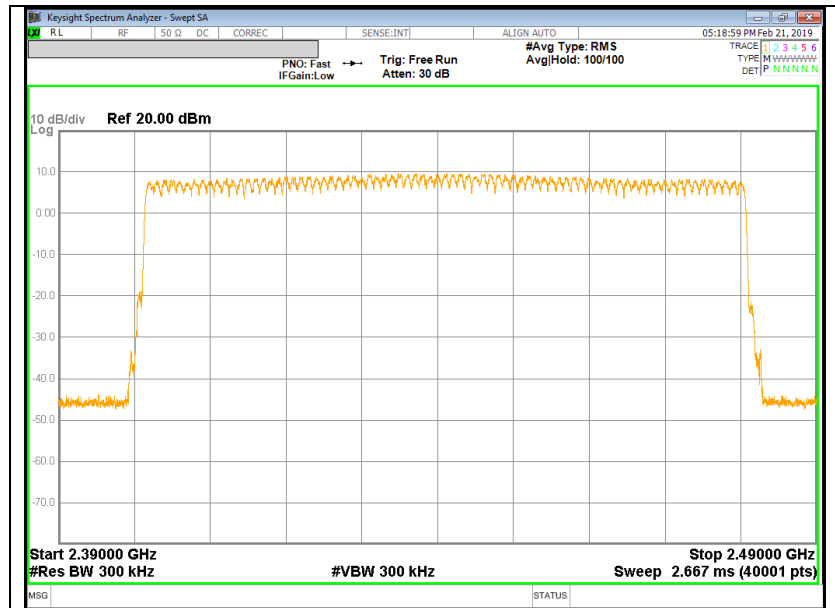

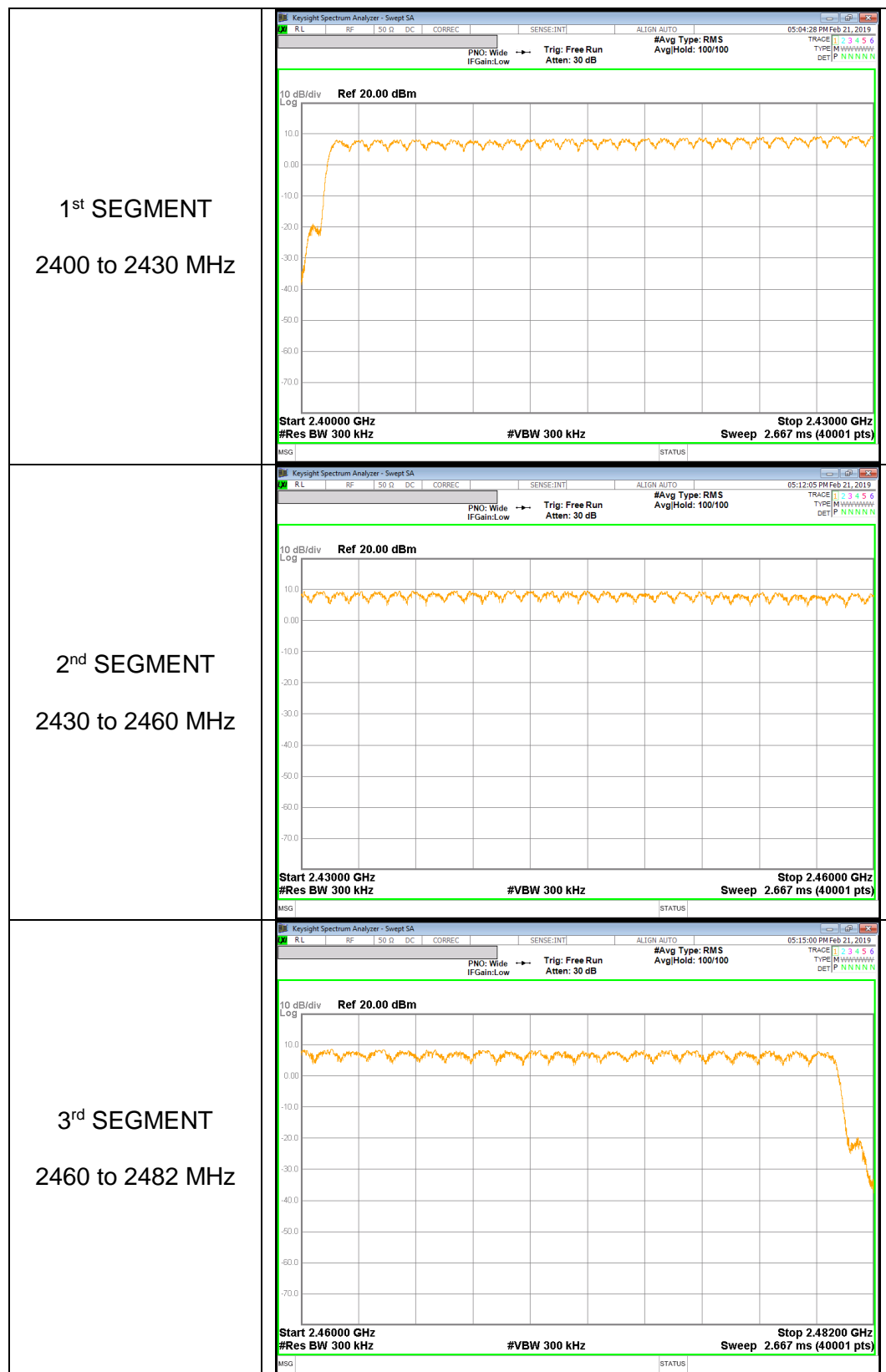

10.3. AVERAGE TIME OF OCCUPANCY

LIMIT

FCC §15.247 (a) (1) (iii)

The average time of occupancy on any channel shall not be greater than 0.4 seconds within a period of 0.4 seconds multiplied by the number of hopping channels employed.

TEST PROCEDURE

The transmitter output is connected to a spectrum analyzer. The span is set to 0 Hz, centered on a single, selected hopping channel. The width of a single pulse is measured in a fast scan. The number of pulses is measured in a 3.16 second scan, to enable resolution of each occurrence.

The average time of occupancy in the specified 31.6 second period (79 channels * 0.4 s) is equal to 10 * (# of pulses in 3.16 s) * pulse width.

For AFH mode, the average time of occupancy in the specified 8 second period (20 channels * 0.4 seconds) is equal to 10 * (# of pulses in 0.8 s) * pulse width.

RESULTS[GFSK]

DH Packet	Pulse Width [msec]	Number of Pulses in 3.16 seconds	Average Time of Occupancy [sec]	Limit [sec]	Margin [sec]
GFSK Normal					
DH1	0.374	32	0.119808	0.4	-0.2802
DH3	1.630	16	0.260800	0.4	-0.1392
DH5	2.878	12	0.345360	0.4	-0.0546
GFSK AFH					
DH Packet	Pulse Width [msec]	Number of Pulses in 0.8 seconds	Average Time of Occupancy [sec]	Limit [sec]	Margin [sec]
DH1	0.374	8	0.029952	0.4	-0.37
DH3	1.630	4	0.065200	0.4	-0.3348
DH5	2.878	3	0.086340	0.4	-0.3137

DH1

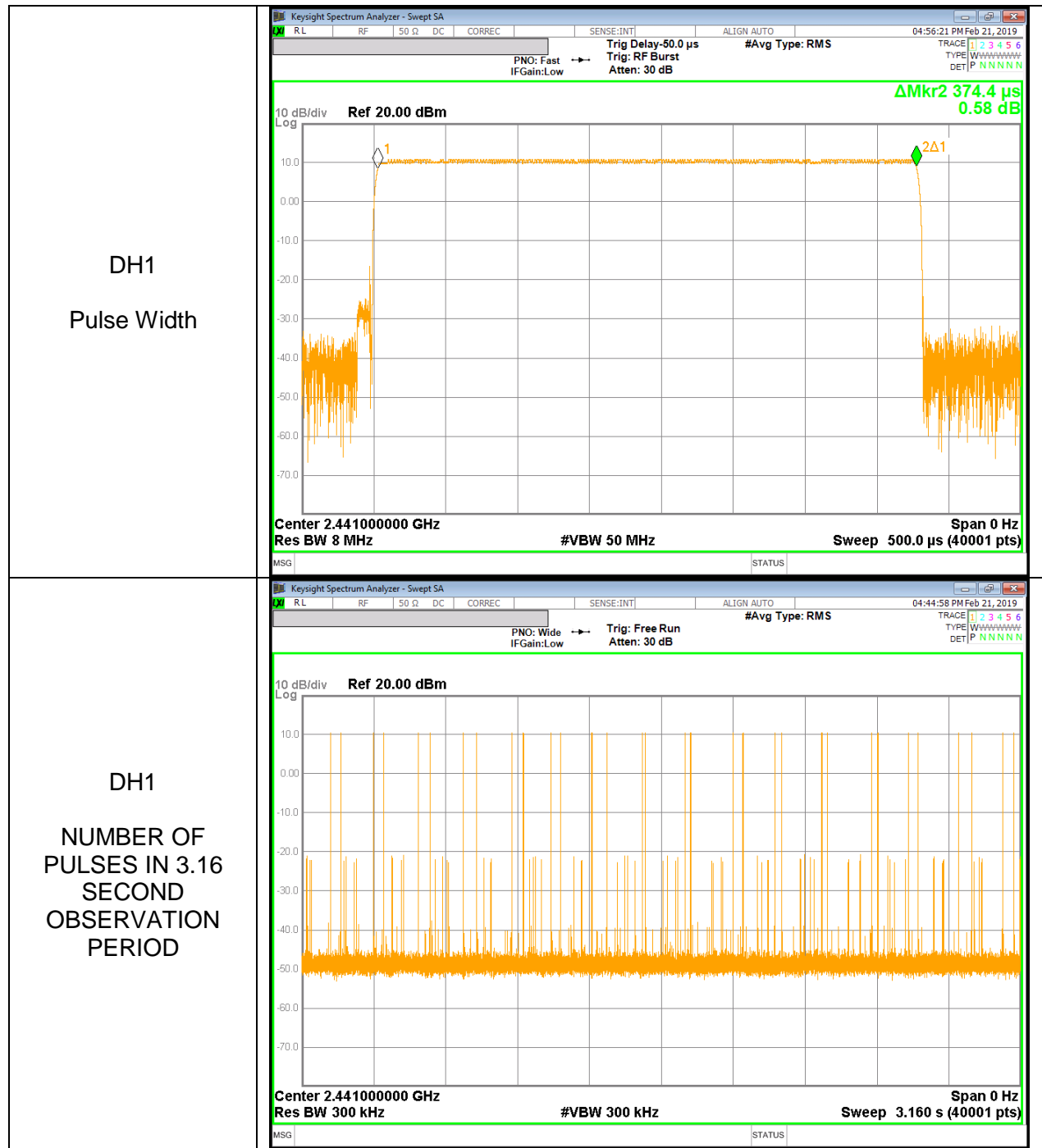

DH3

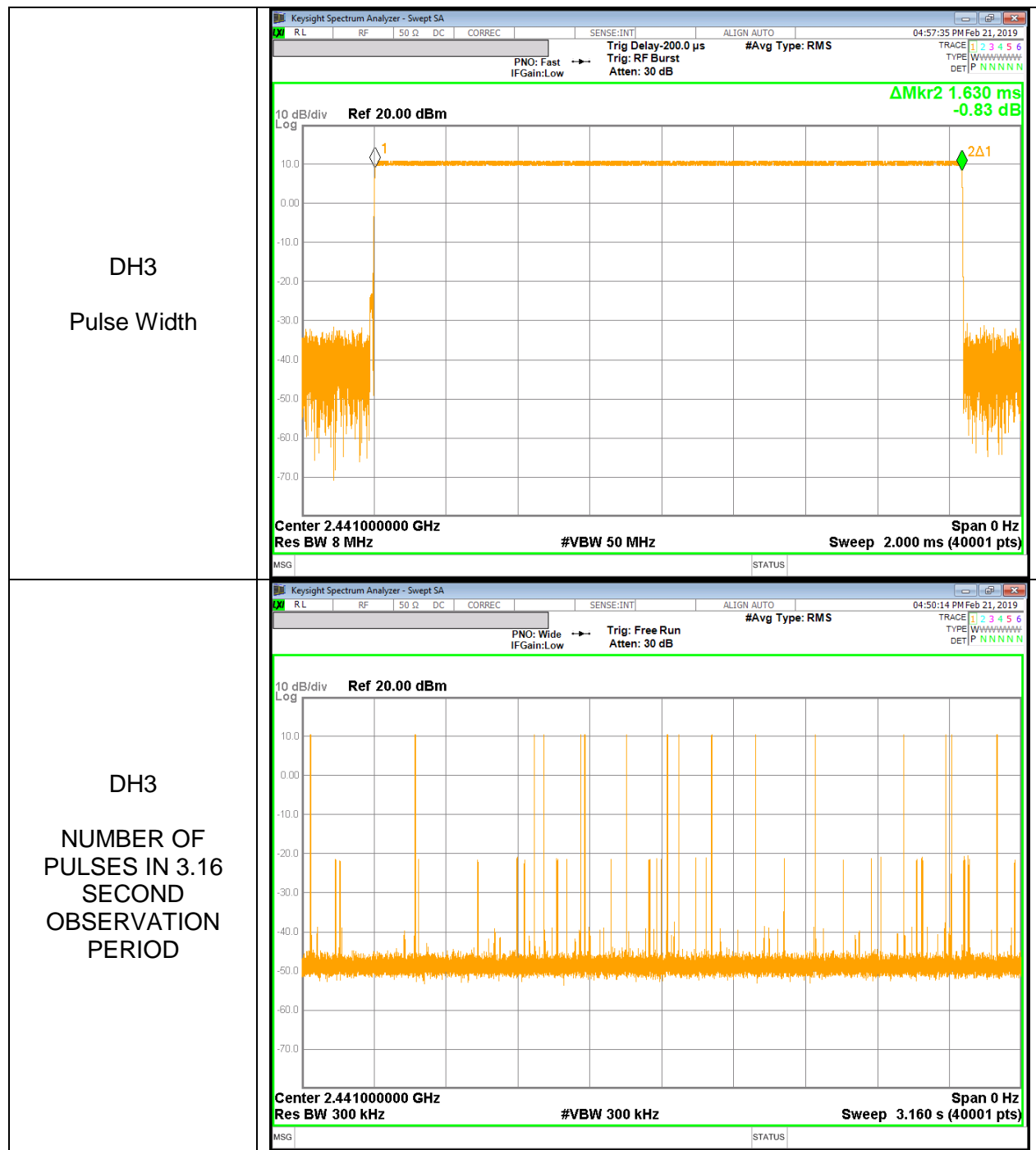

DH5

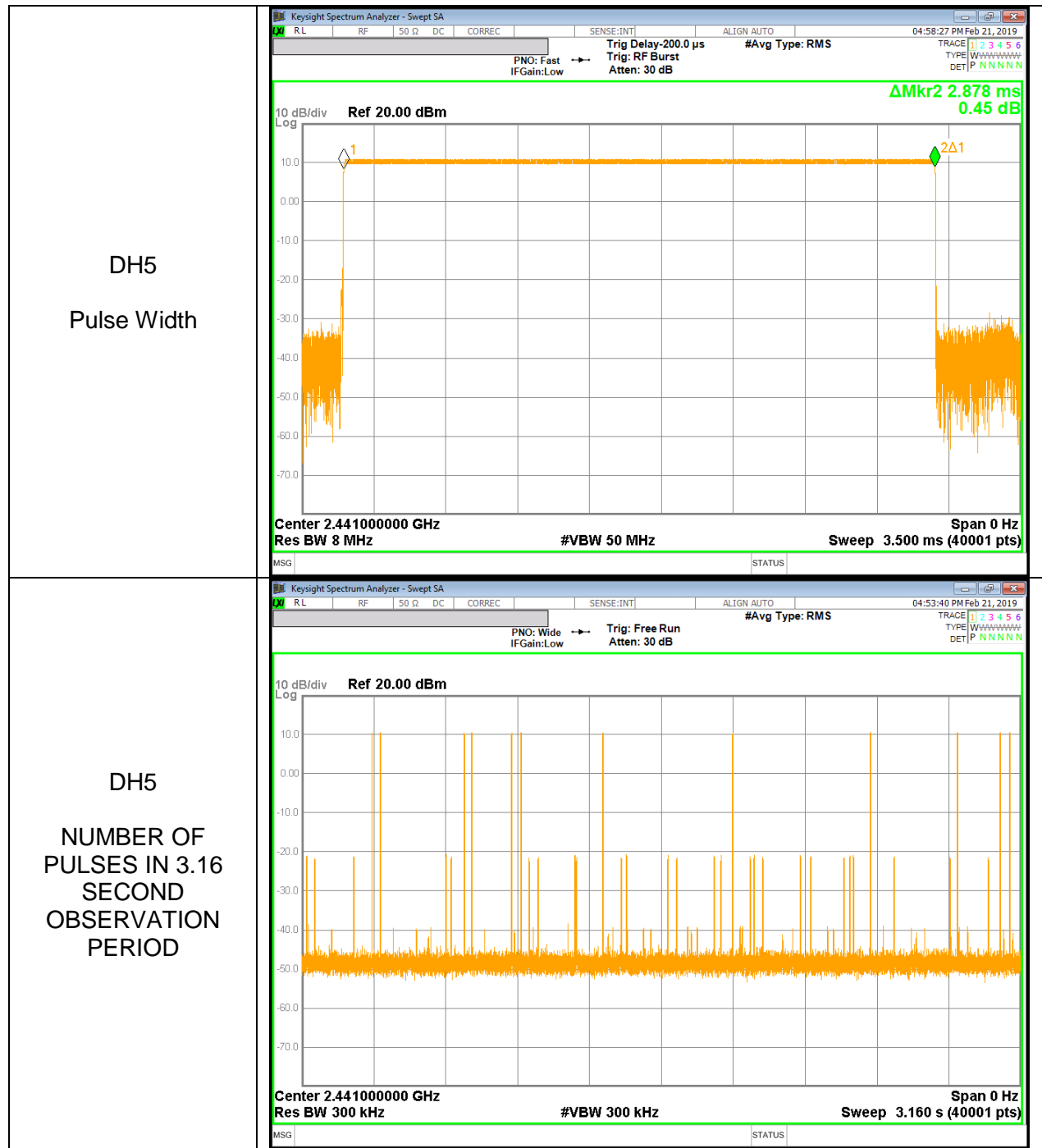

RESULTS[8PSK]

DH Packet	Pulse Width [msec]	Number of Pulses in 3.16 seconds	Average Time of Occupancy [sec]	Limit [sec]	Margin [sec]
GFSK Normal					
DH1	0.386	32	0.123424	0.4	-0.2766
DH3	1.635	16	0.261600	0.4	-0.1384
DH5	2.885	12	0.346200	0.4	-0.0538
GFSK AFH					
DH Packet	Pulse Width [msec]	Number of Pulses in 0.8 seconds	Average Time of Occupancy [sec]	Limit [sec]	Margin [sec]
GFSK AFH					
DH1	0.386	8	0.030856	0.4	-0.3691
DH3	1.635	4	0.065400	0.4	-0.3346
DH5	2.885	3	0.086550	0.4	-0.3135

DH1

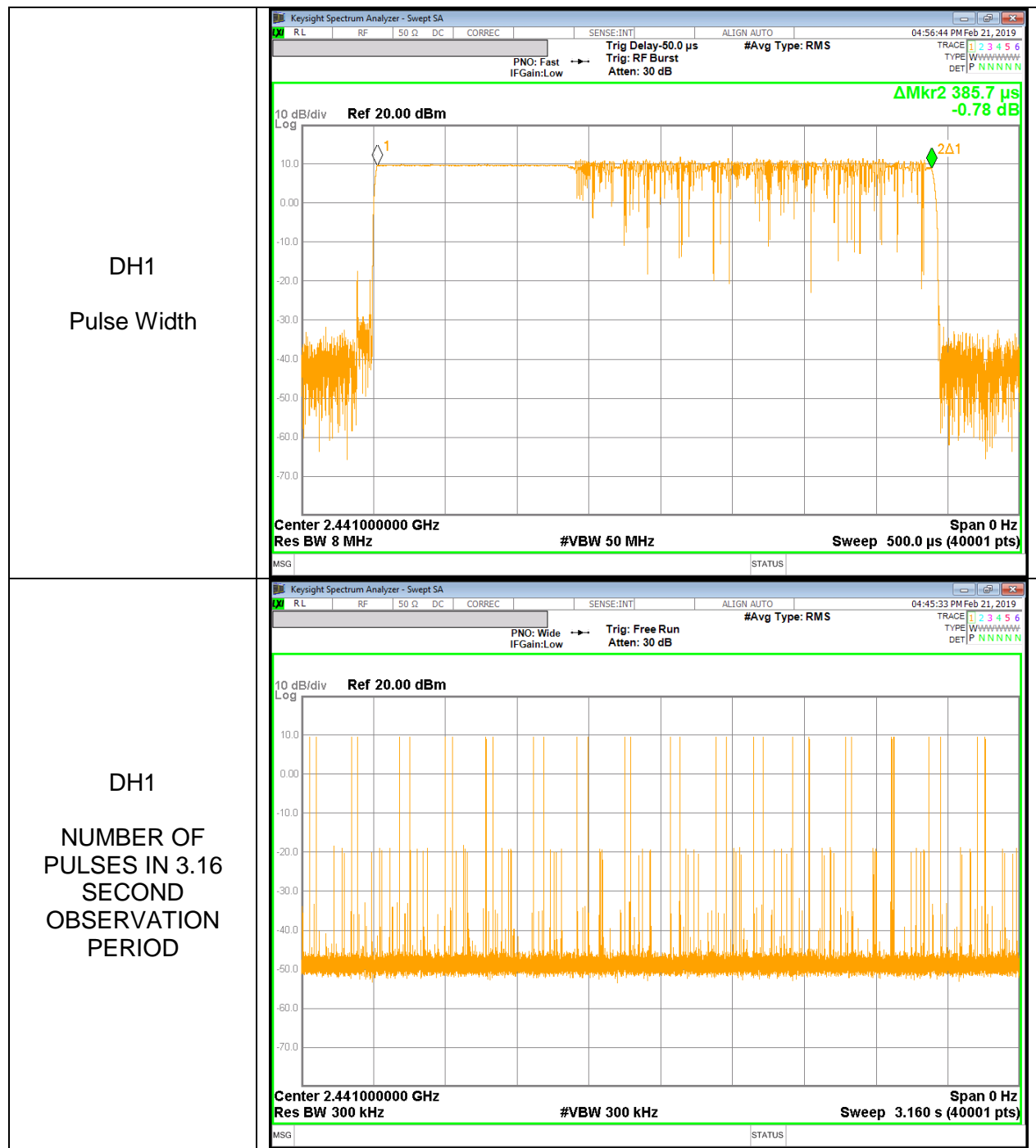

DH3

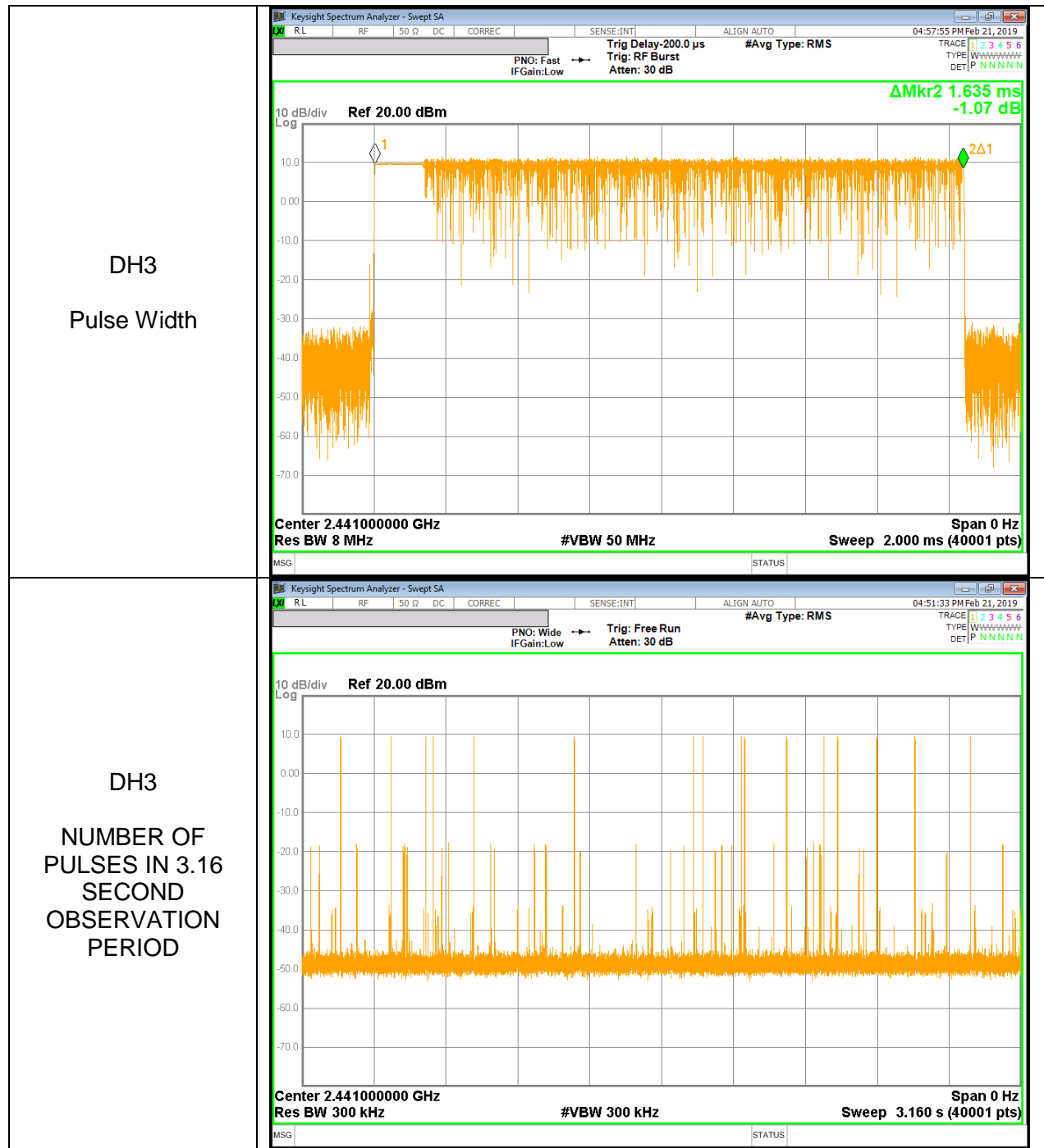

DH5

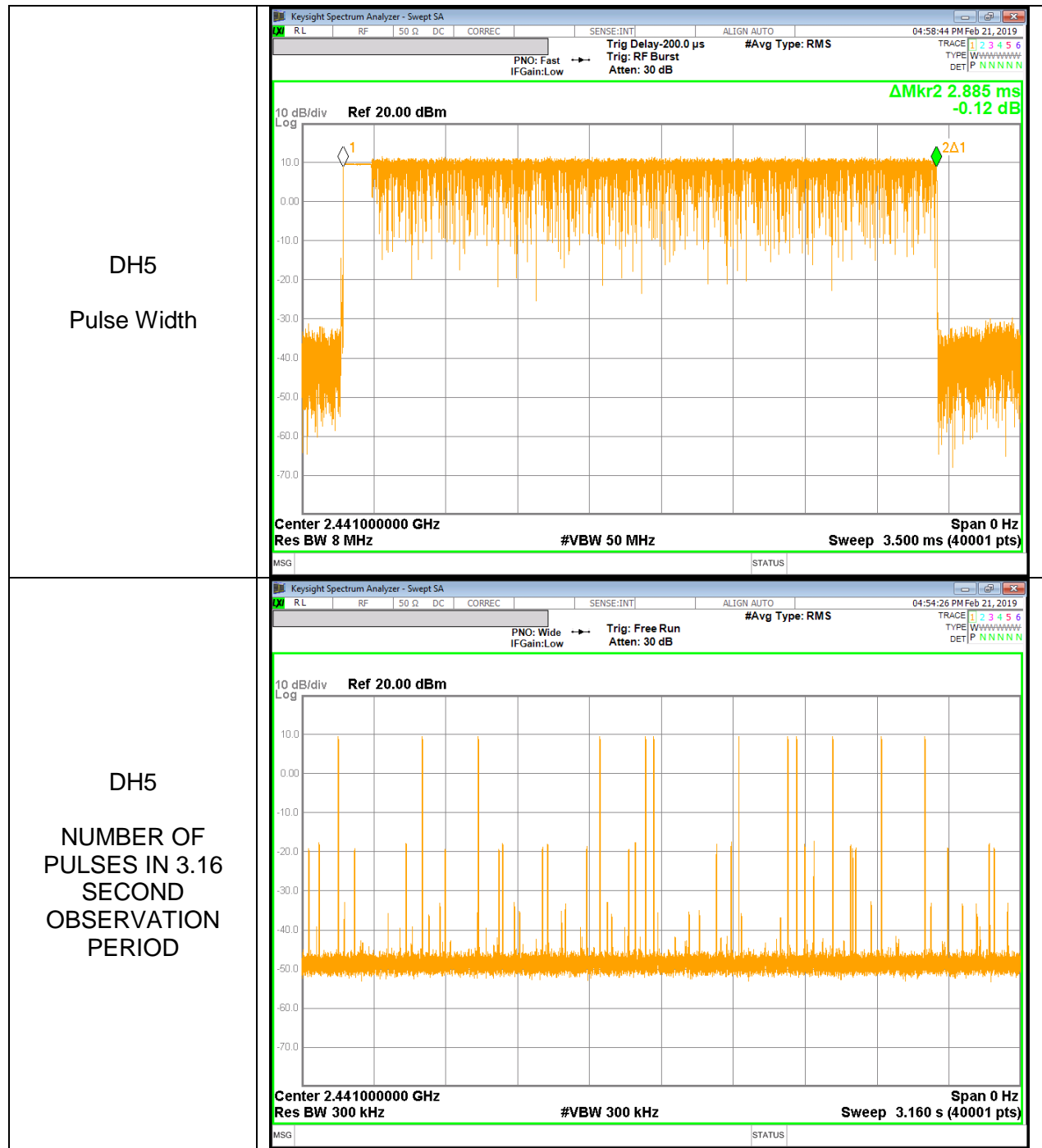

10.4. OUTPUT POWER

LIMIT

§15.247 (b) (1)

The maximum antenna gain is less than 6 dBi, therefore the limit is 21 dBm.

TEST PROCEDURE

The transmitter output is connected to a spectrum analyzer the analyzer bandwidth is set to a value greater than the 20 dB bandwidth of the EUT.

RESULTS

10.4.1. BASIC DATA RATE GFSK MODULATION

Channel	Frequency [MHz]	Output Power [dBm]	Limit [dBm]	Margin [dB]
Low	2402	8.770	21	-12.23
Middle	2441	10.713	21	-10.287
High	2480	9.535	21	-11.465
Worst		10.713	21	-10.287

10.4.2. ENHANCED DATA RATE Pi/4-DPSK MODULATION

Channel	Frequency [MHz]	Output Power [dBm]	Limit [dBm]	Margin [dB]
Low	2402	8.916	21	-12.084
Middle	2441	10.915	21	-10.085
High	2480	9.681	21	-11.319
Worst		10.915	21	-10.085

10.4.3. ENHANCED DATA RATE 8PSK MODULATION

Channel	Frequency [MHz]	Output Power [dBm]	Limit [dBm]	Margin [dB]
Low	2402	9.499	21	-11.501
Middle	2441	11.548	21	-9.452
High	2480	10.308	21	-10.692
Worst		11.548	21	-9.452

10.4.4. OUTPUT POWER PLOTS

GFSK OUTPUT POWER

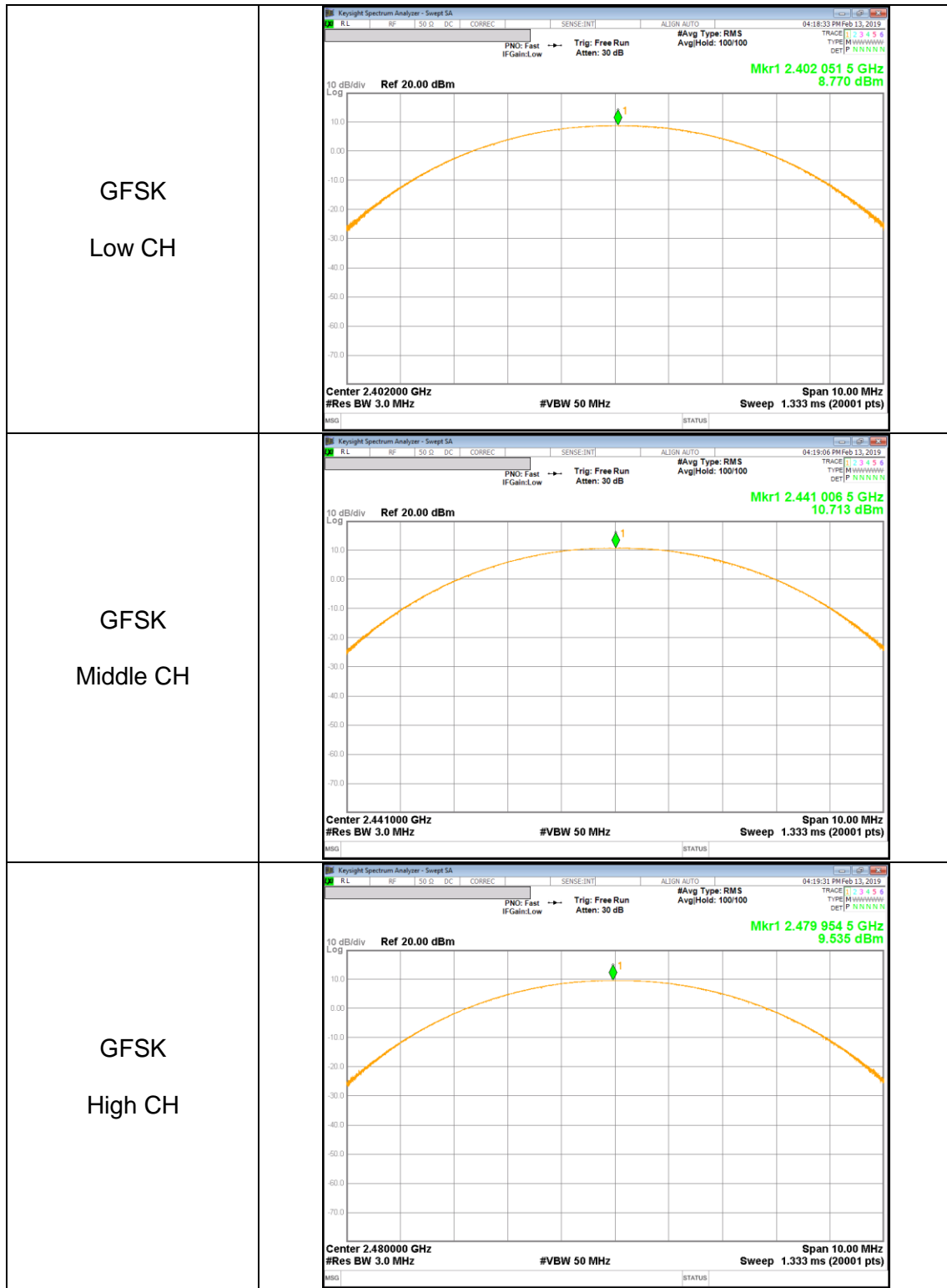

Pi/4-DPSK OUTPUT POWER

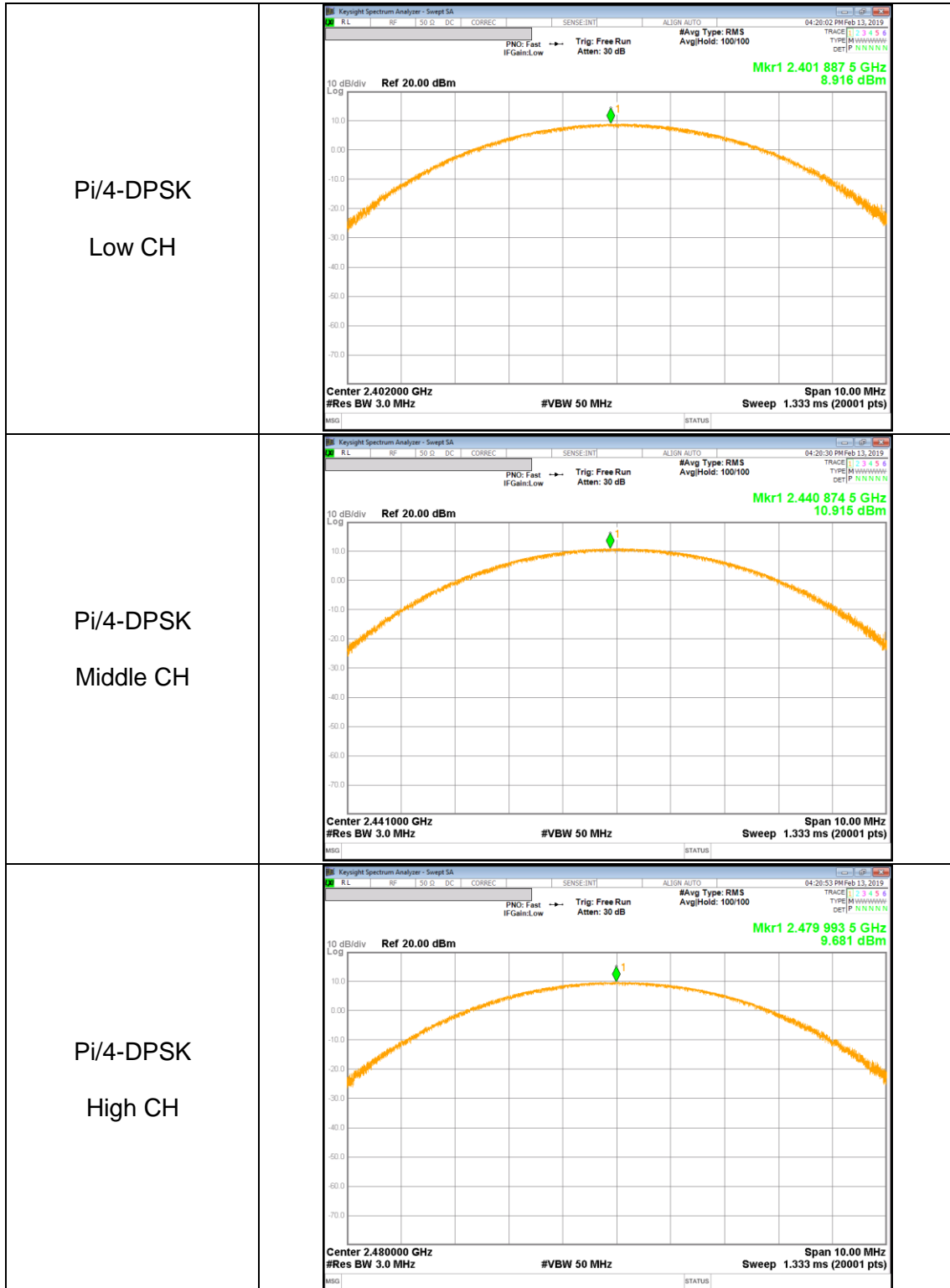

8PSK OUTPUT POWER

<p>8PSK Low CH</p>	<p>KeySight Spectrum Analyzer - Seregi SA 04:21:18 PM Feb 13, 2019 #Avg Type: RMS AvgHold: 100/100 Mkr1 2.402 053 0 GHz 9.499 dBm Ref 20.00 dBm 10 dB/div LOG Center 2.402000 GHz #Res BW 3.0 MHz #VBW 50 MHz Span 10.00 MHz Sweep 1.333 ms (20001 pts)</p>
<p>8PSK Middle CH</p>	<p>KeySight Spectrum Analyzer - Seregi SA 04:22:22 PM Feb 13, 2019 #Avg Type: RMS AvgHold: 100/100 Mkr1 2.441 008 0 GHz 11.548 dBm Ref 20.00 dBm 10 dB/div LOG Center 2.441000 GHz #Res BW 3.0 MHz #VBW 50 MHz Span 10.00 MHz Sweep 1.333 ms (20001 pts)</p>
<p>8PSK High CH</p>	<p>KeySight Spectrum Analyzer - Seregi SA 04:22:46 PM Feb 13, 2019 #Avg Type: RMS AvgHold: 100/100 Mkr1 2.479 972 0 GHz 10.308 dBm Ref 20.00 dBm 10 dB/div LOG Center 2.480000 GHz #Res BW 3.0 MHz #VBW 50 MHz Span 10.00 MHz Sweep 1.333 ms (20001 pts)</p>

10.5. AVERAGE POWER

LIMIT

None; for reporting purposes only.

TEST PROCEDURE

The transmitter output is connected to a power meter.

RESULTS

The cable assembly insertion loss was entered as an offset in the power meter to allow for direct reading of power.

10.5.1. BASIC DATA RATE GFSK MODULATION

Channel	Frequency [MHz]	AV power [dBm]	AV power [mW]
Low	2402	8.062	6.40
Middle	2441	10.036	10.08
High	2480	8.913	7.79

10.5.2. ENHANCED DATA RATE PI/4-DQPSK MODULATION

Channel	Frequency [MHz]	AV power [dBm]	AV power [mW]
Low	2402	6.746	4.73
Middle	2441	8.697	7.41
High	2480	7.668	5.85

10.5.3. ENHANCED DATA RATE 8PSK MODULATION

Channel	Frequency [MHz]	AV power [dBm]	AV power [mW]
Low	2402	6.781	4.77
Middle	2441	8.726	7.46
High	2480	7.693	5.88

10.6. CONDUCTED SPURIOUS EMISSIONS

LIMITS

FCC §15.247 (d)

Limit = -20 dBc

TEST PROCEDURE

The transmitter output is connected to a spectrum analyzer. The resolution bandwidth is set to 100 kHz. The video bandwidth is set to 300 kHz.

The spectrum from 30 MHz to 26 GHz is investigated with the transmitter set to the lowest, middle, and highest channels.

The bandedges at 2.4 and 2.4835 GHz are investigated with the transmitter set to the normal hopping mode.

RESULTS

10.6.1. BASIC DATA RATE GFSK MODULATION

GFSK Mode

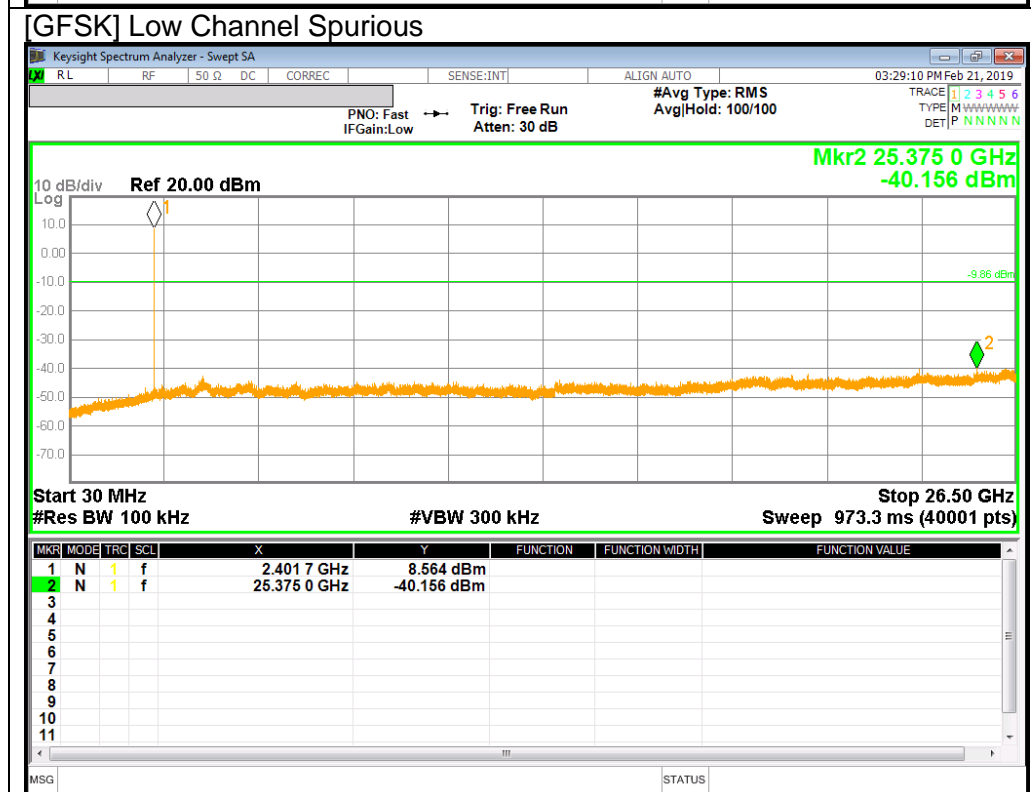
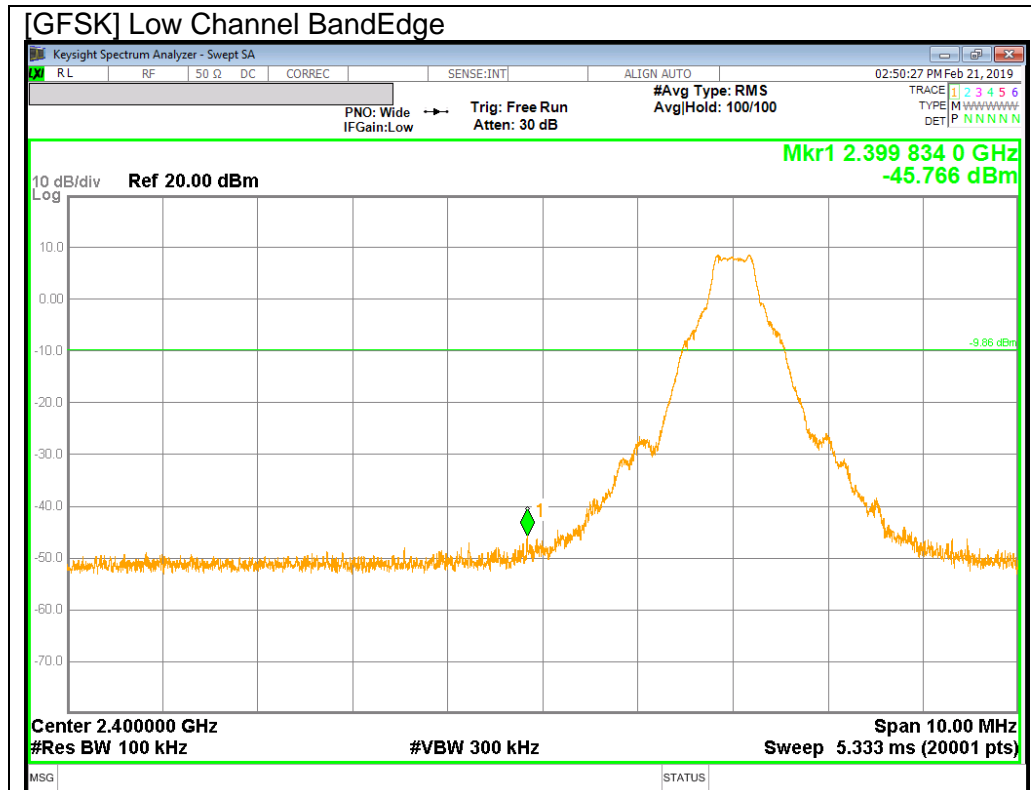

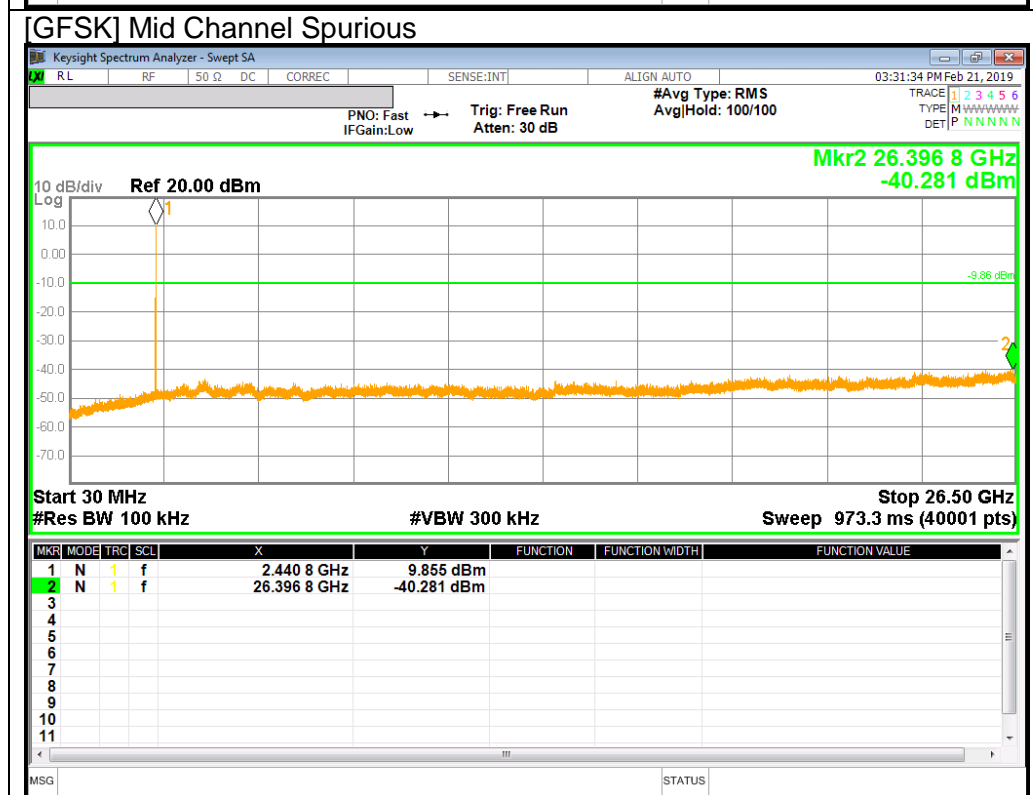
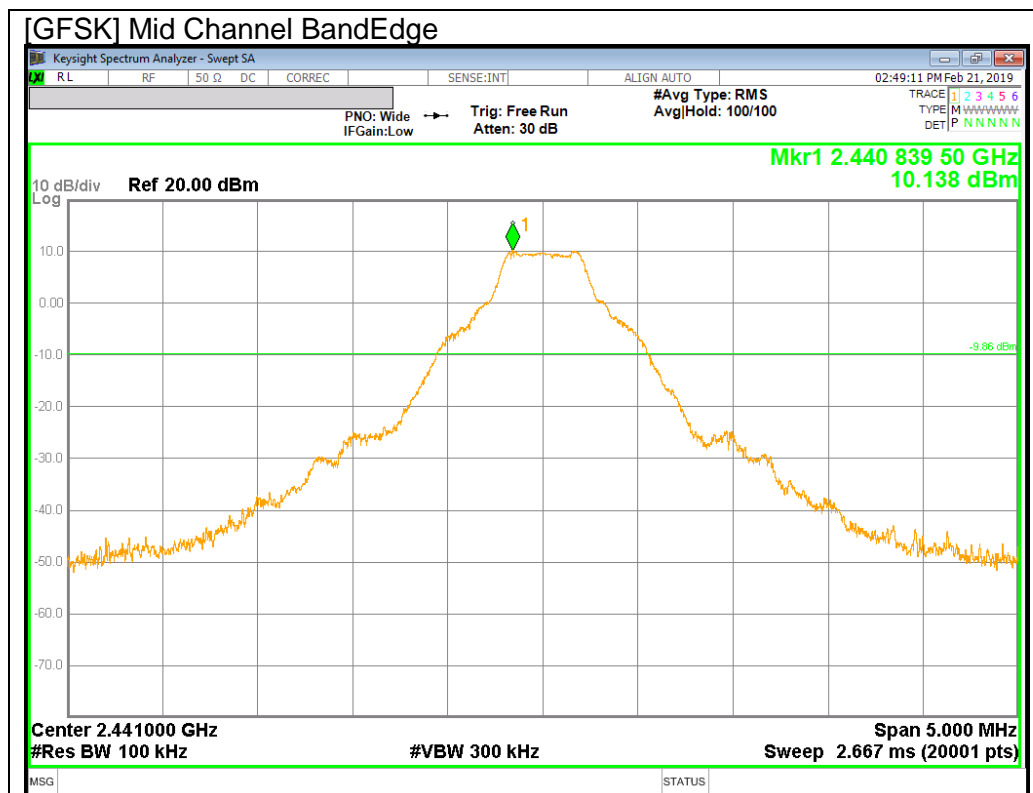

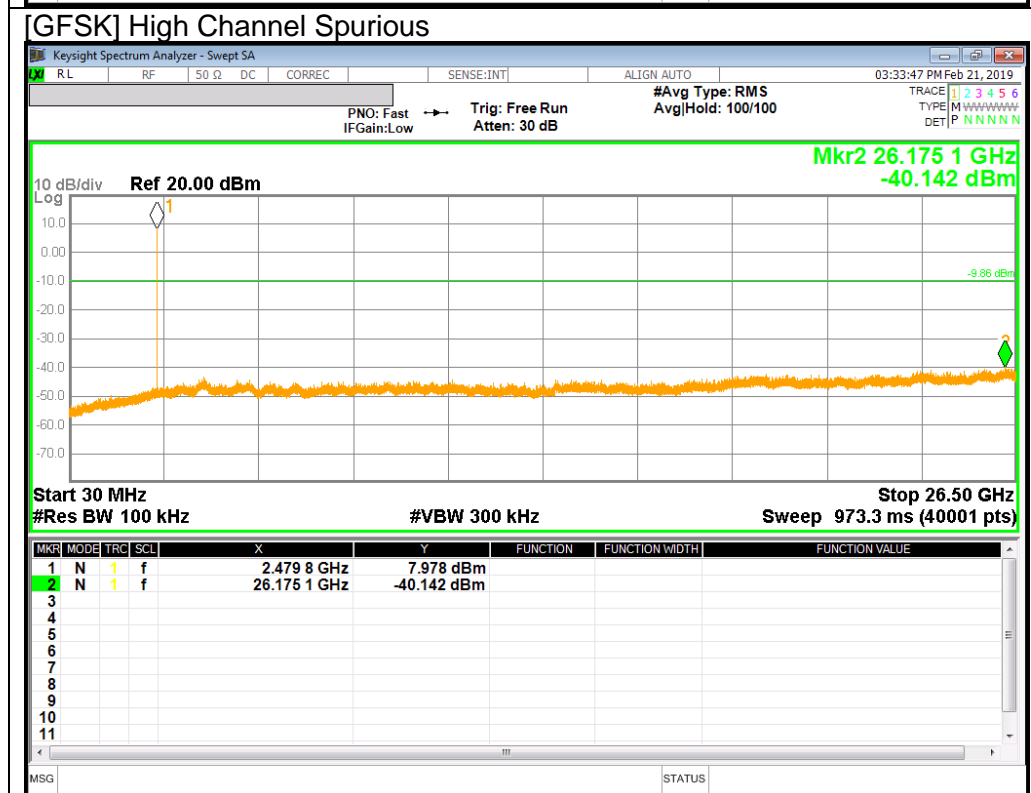
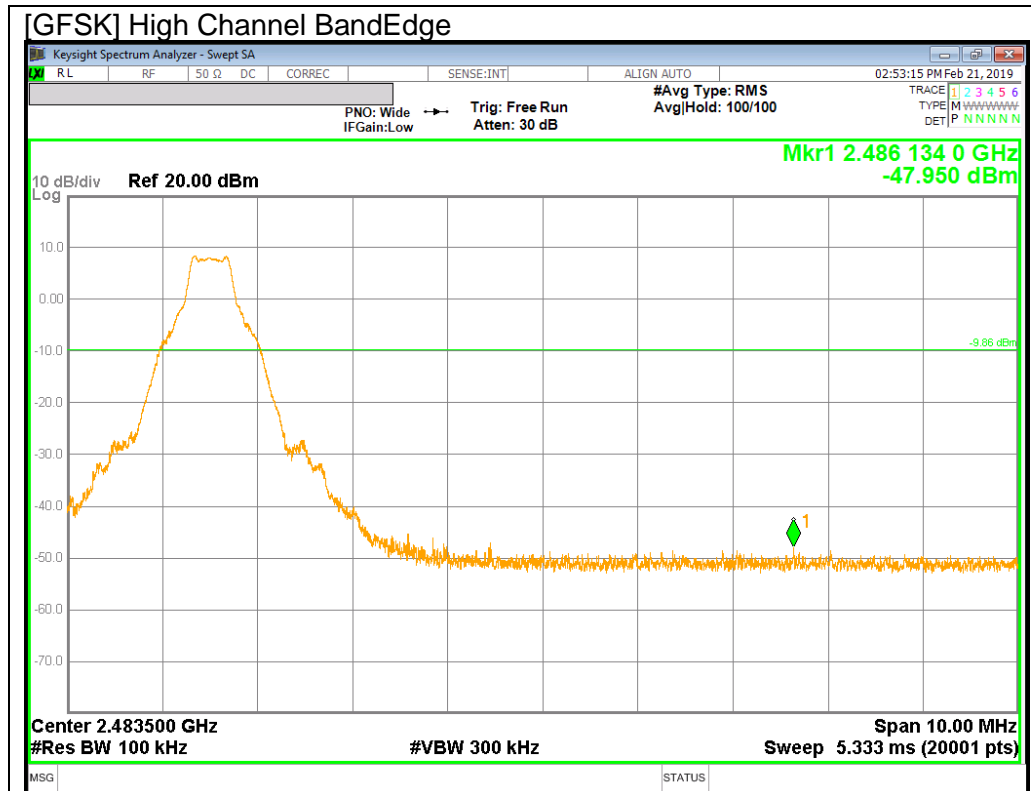

BandEdge Emission at GFSK Hopping Mode

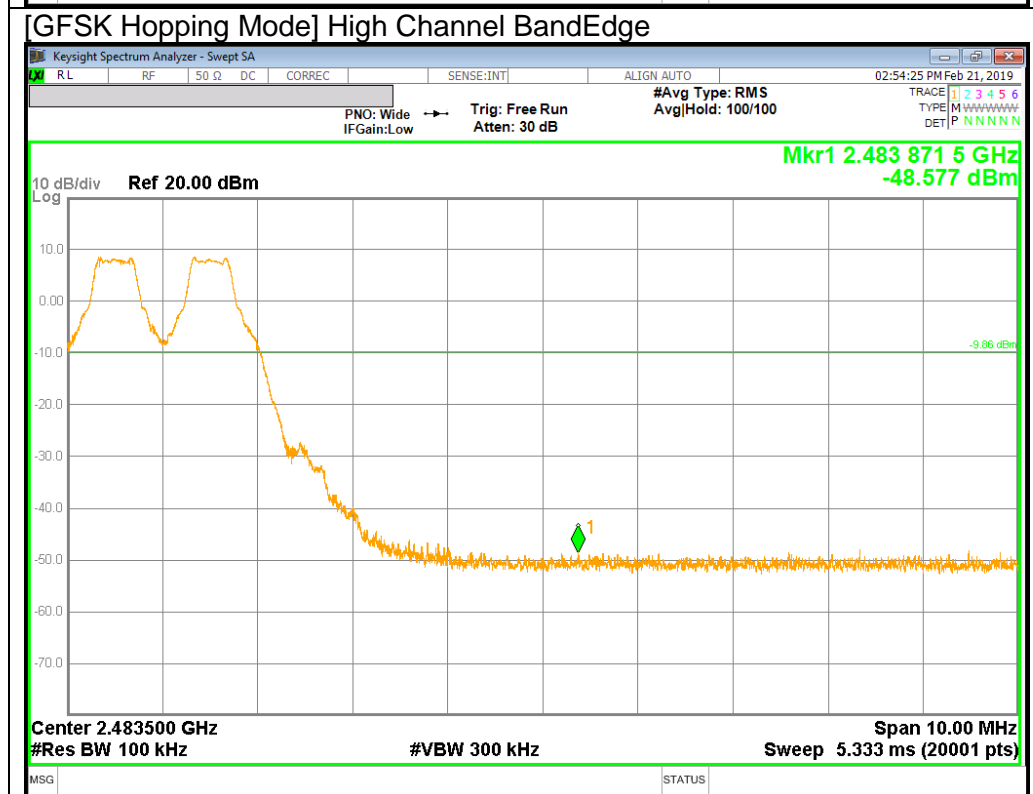
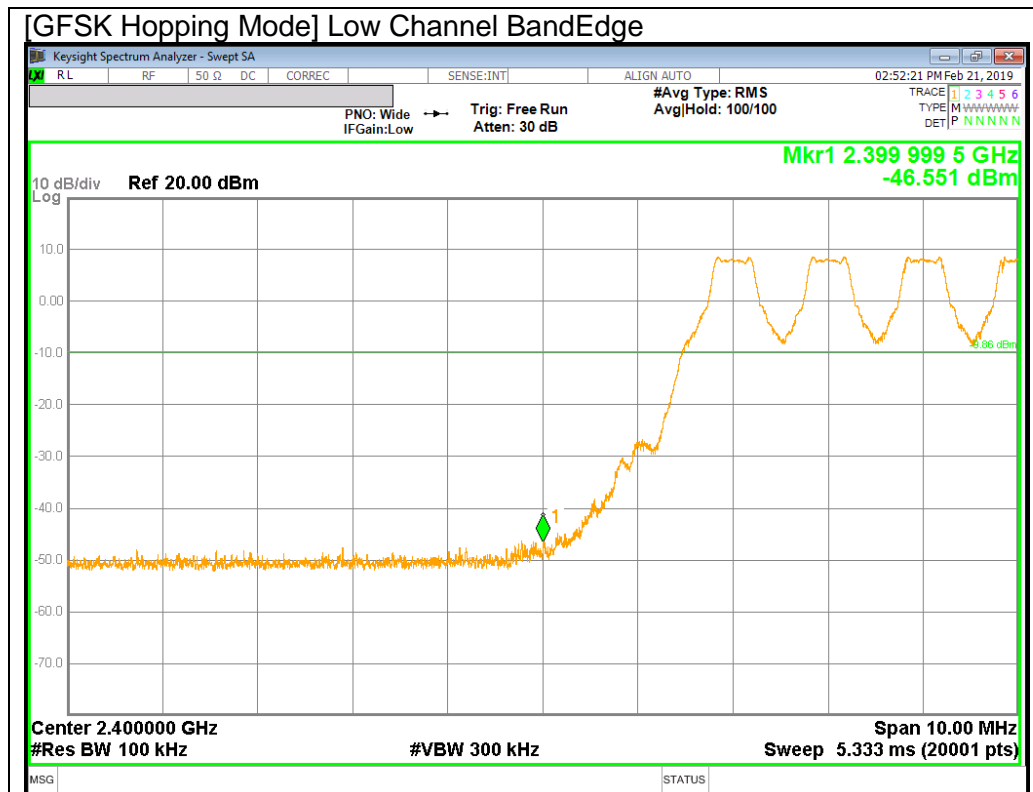

10.6.2. ENHANCED DATA RATE PI/4-DQPSK MODULATION

PI/4-DQPSK Mode



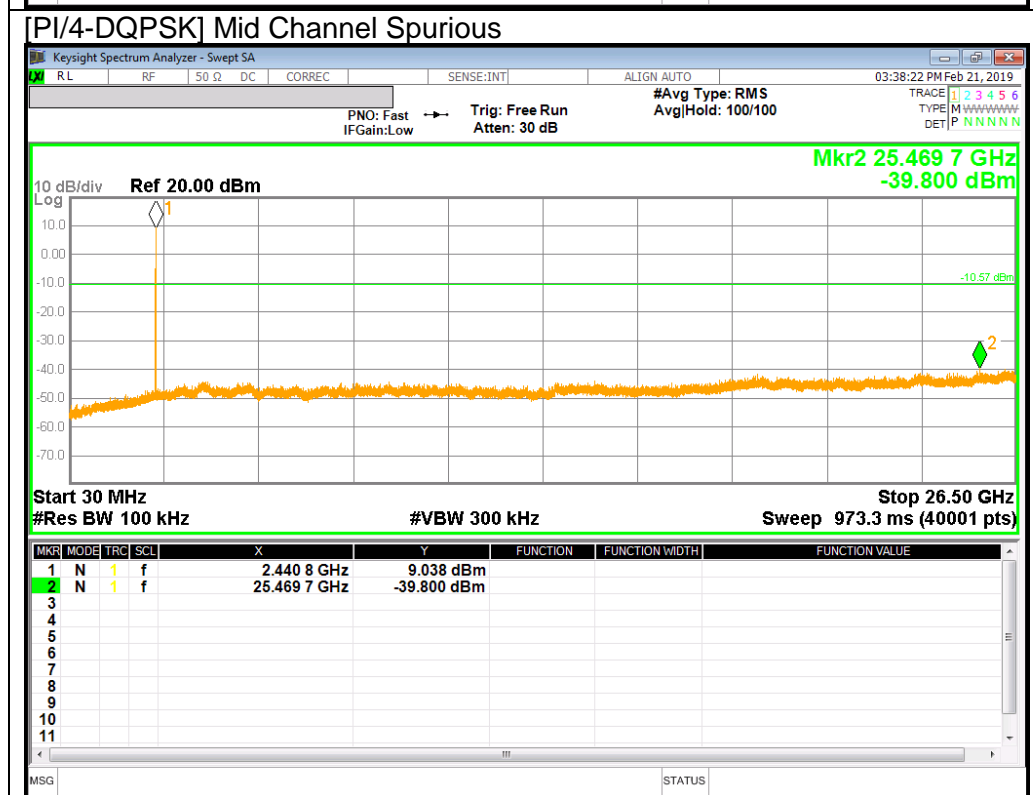
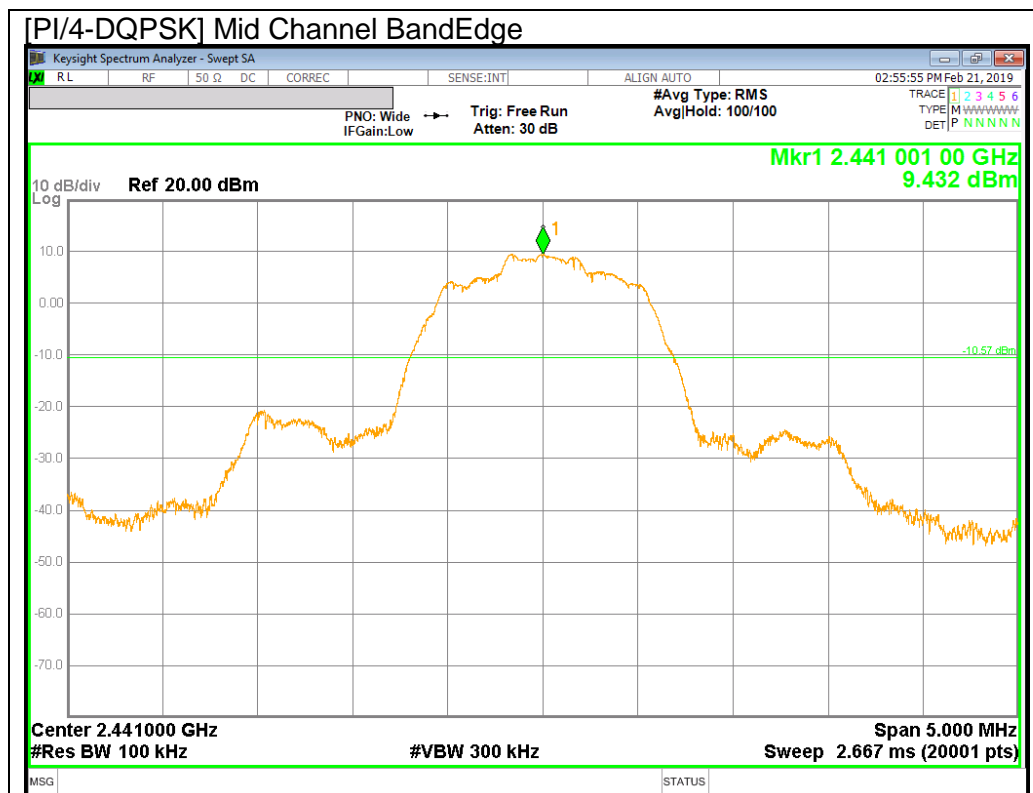

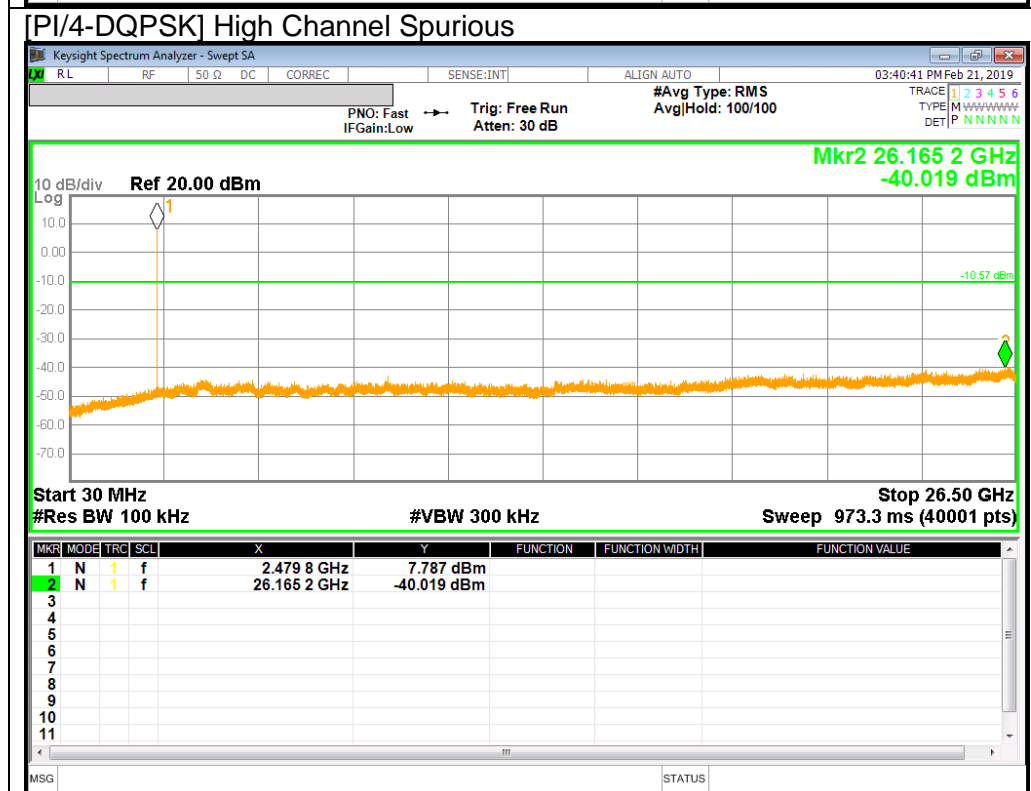
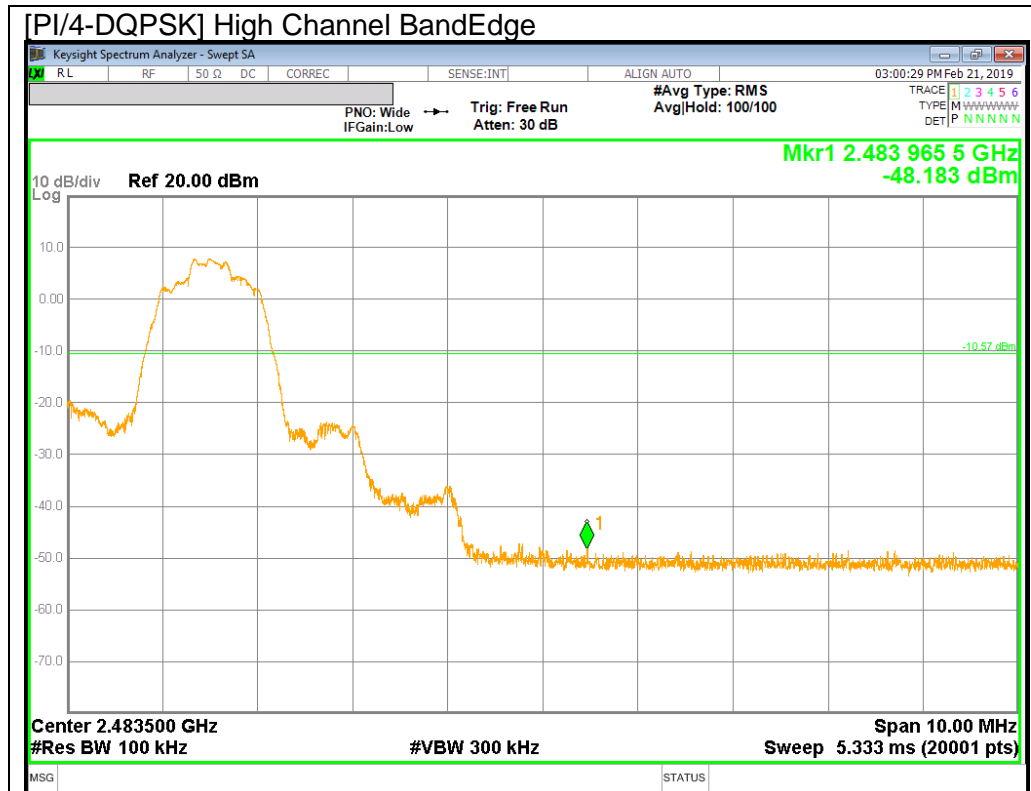

BandEdge Emission at PI/4-DQPSK Hopping Mode

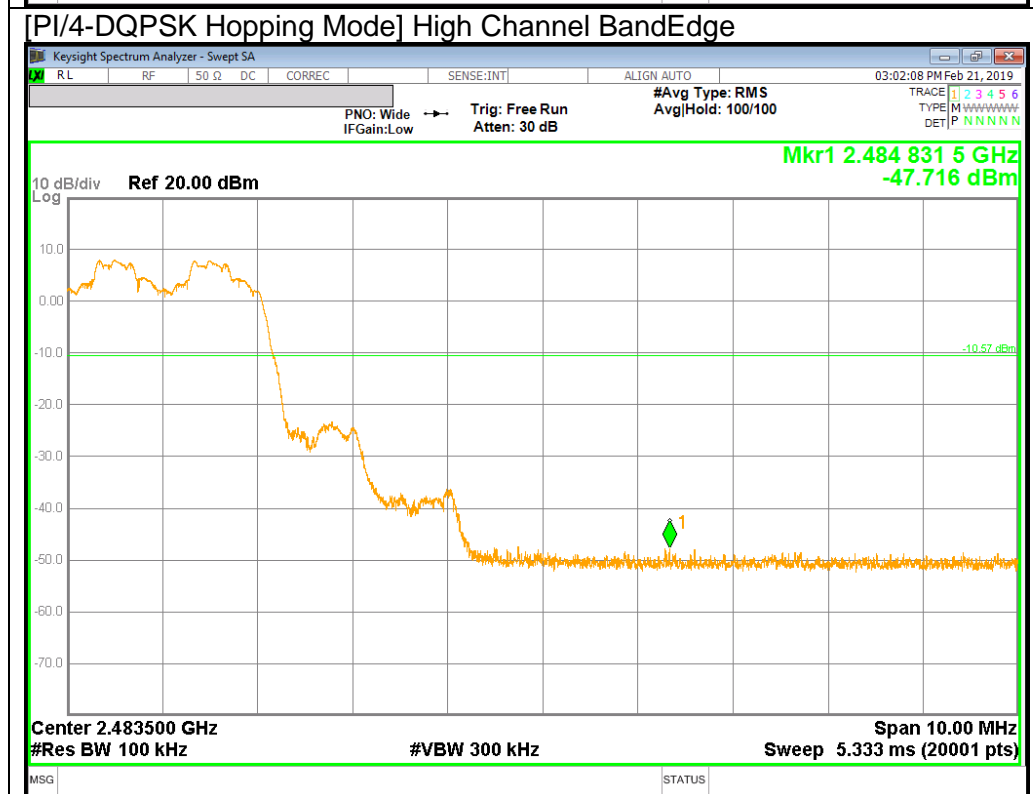
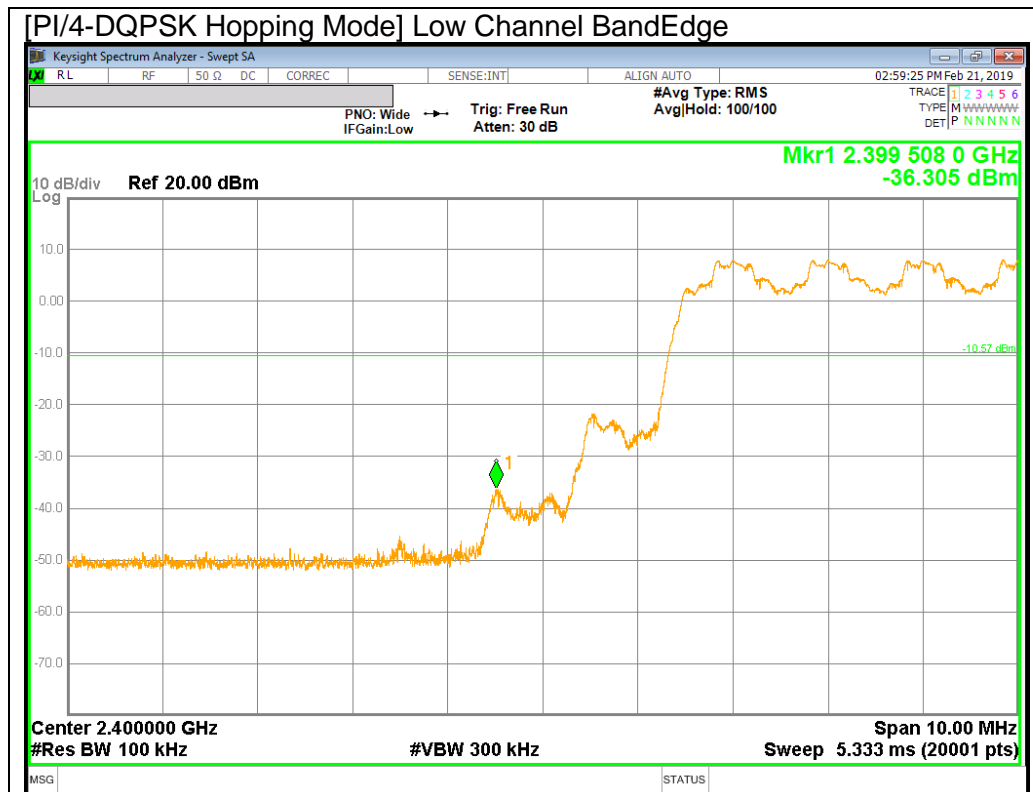

10.6.3. ENHANCED DATA RATE 8PSK MODULATION

8PSK Mode

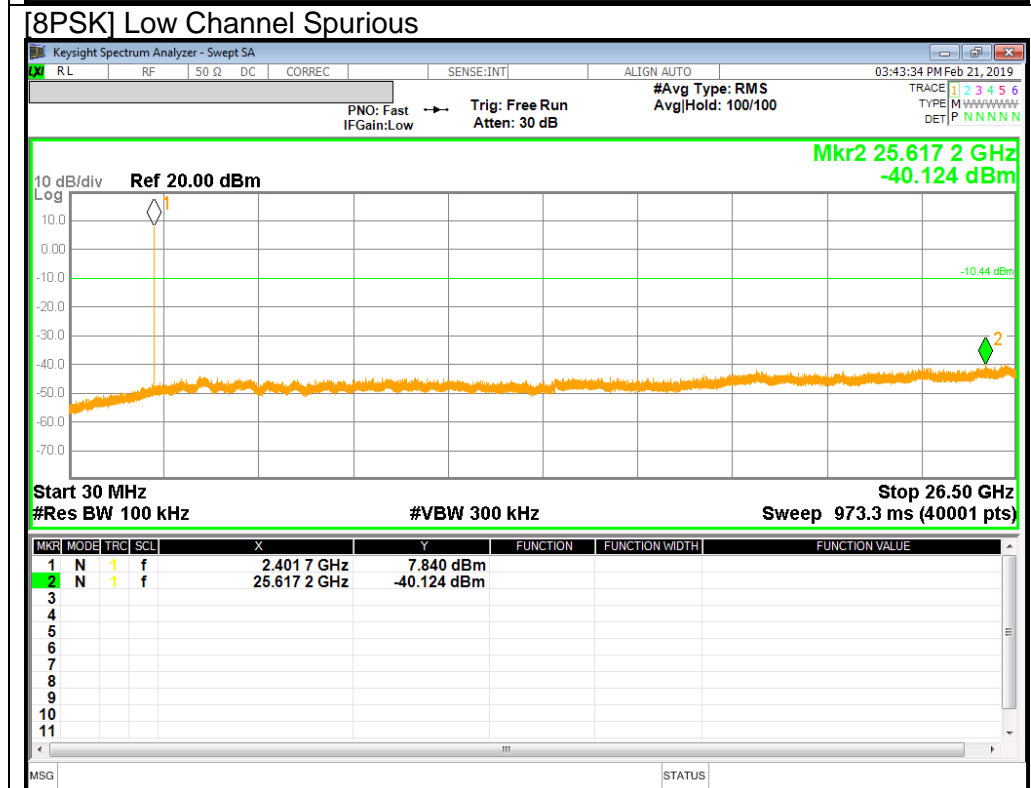
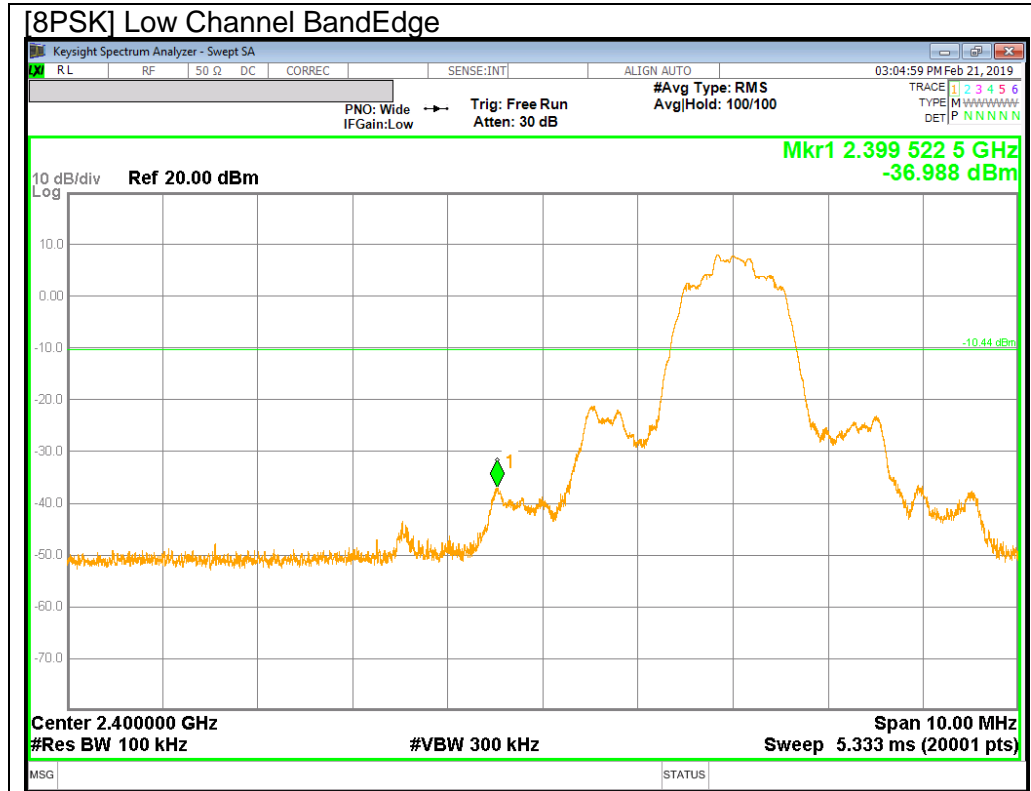

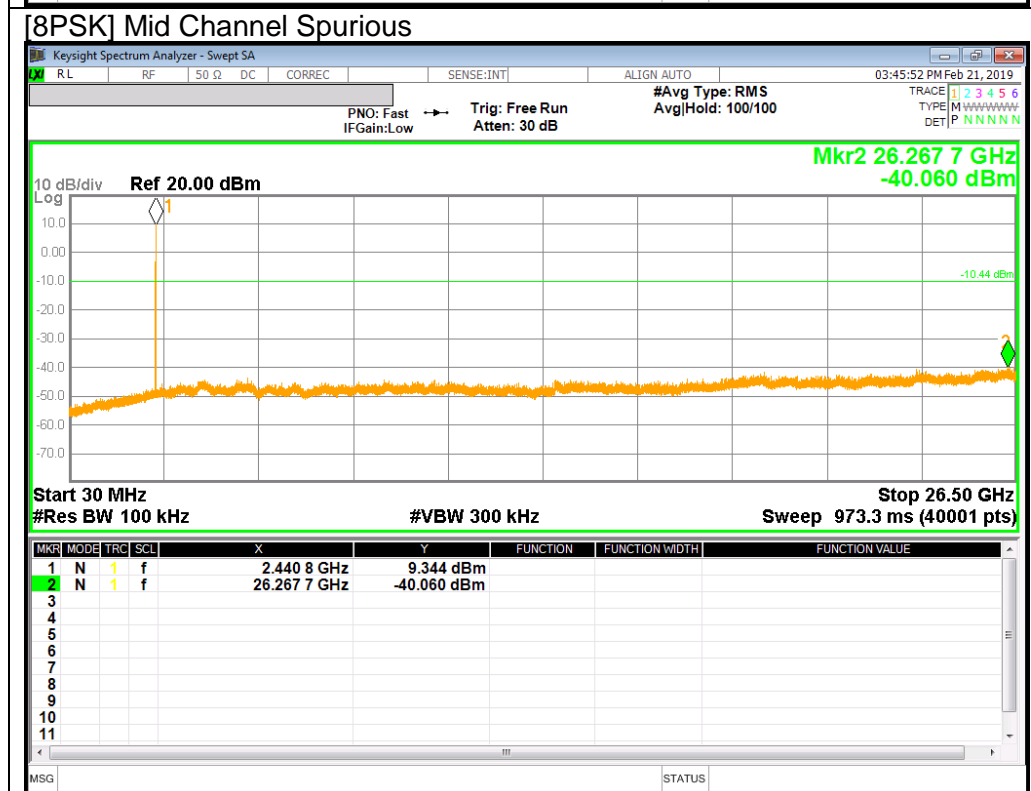
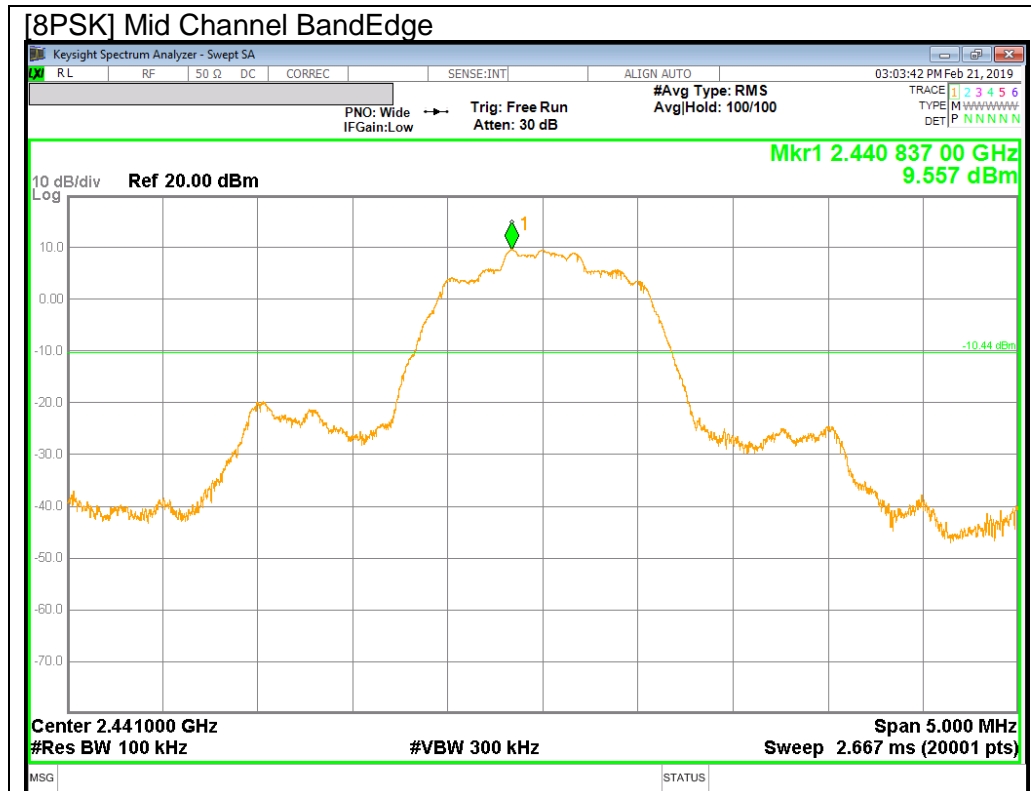

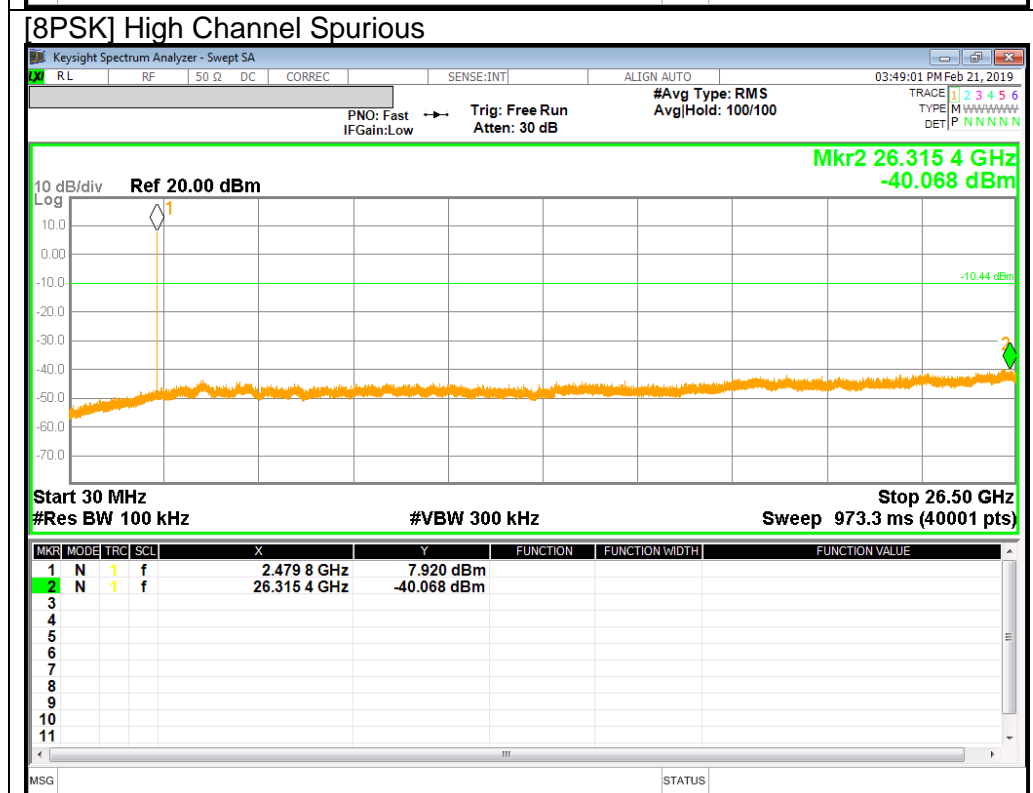
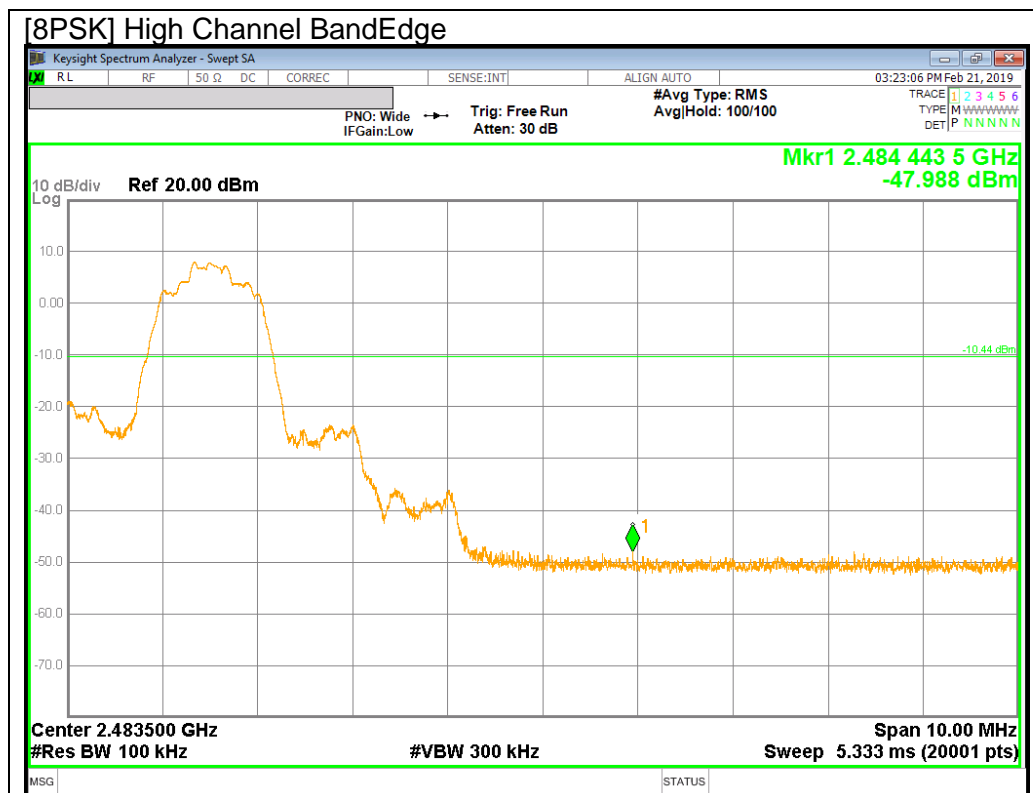

BandEdge Emission at 8PSK Hopping Mode

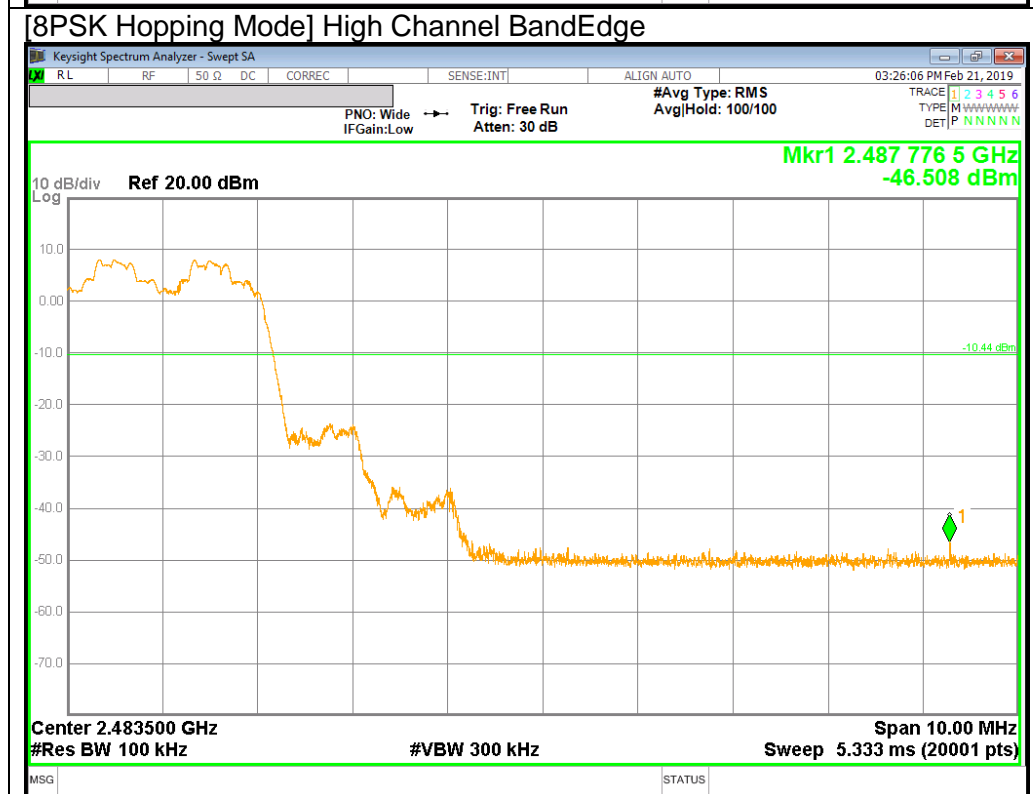
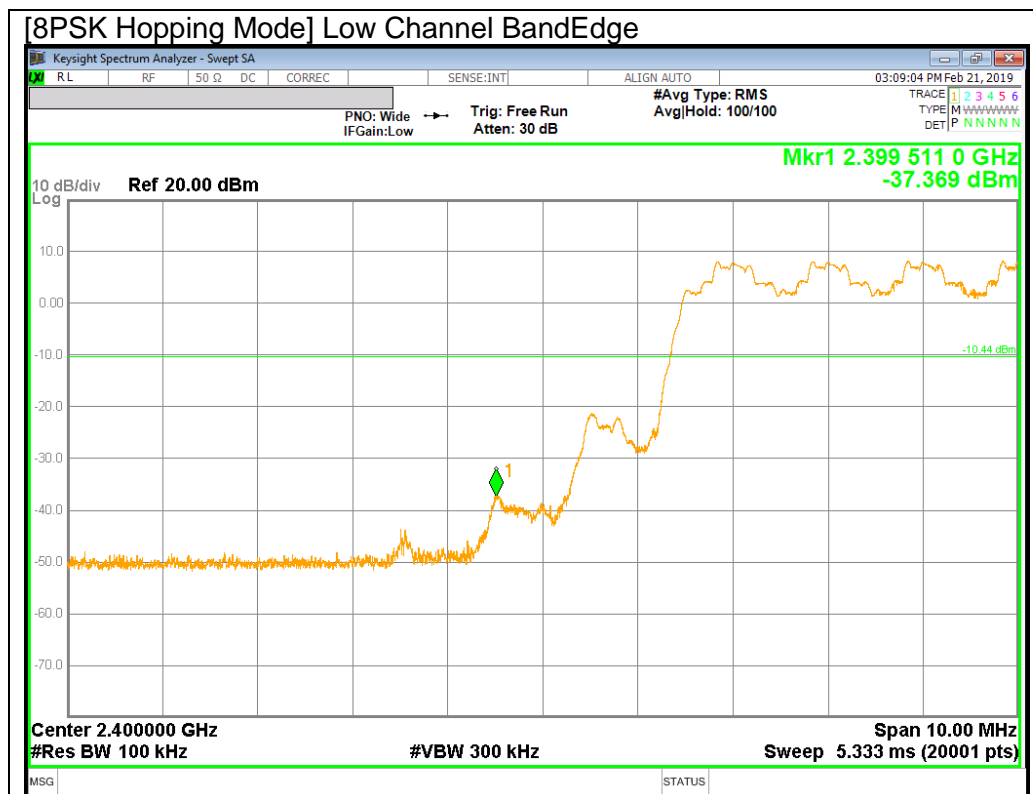

11. RADIATED TEST RESULTS

11.1. LIMITS AND PROCEDURE

LIMITS

FCC §15.205 and §15.209

Limits for radiated disturbance of an intentional radiator		
Frequency range (MHz)	Limits (µV/m)	Measurement Distance (m)
0.009 – 0.490	2400 / F (kHz)	300
0.490 – 1.705	24000 / F (kHz)	30
1.705 – 30.0	30	30
30 – 88	100**	3
88 - 216	150**	3
216 – 960	200**	3
Above 960	500	3

** Except as provided in paragraph (g), fundamental emissions from intentional radiators operating under this section shall not be located in the frequency bands 54-72 MHz, 76-88 MHz, 174-216 MHz or 470-806 MHz. However, operation within these frequency bands is permitted under other sections of this part, e.g. §§ 15.231 and 15.241.

TEST PROCEDURE

The EUT is placed on a non-conducting table 80 cm above the ground plane for below 1GHz and 150 cm for above 1GHz. The EUT is configured in accordance with ANSI C63.10. The EUT is set to transmit in a continuous mode.

For measurements below 1 GHz the resolution bandwidth is set to 100 kHz for peak detection measurements or 120 kHz for quasi-peak detection measurements. Peak detection is used unless otherwise noted as quasi-peak.

For measurements above 1 GHz the resolution bandwidth is set to 1 MHz; the video bandwidth is set to 3 MHz for peak measurements.(Pre-scans to detect harmonic and spurious emissions, the resolution bandwidth is set to 1 MHz; the video bandwidth is set to 30 KHz for peak measurements.)

For band edge measurements above 1 GHz the resolution bandwidth is set to 1 MHz, then the video bandwidth is set to 3 MHz for peak measurements and 1/T (on time) for average measurement.

$$\text{GFSK} = 1/T = 1 / 0.002879\text{S} = 347\text{Hz}.$$

The minimum VBW was 347Hz, but test receiver(ESU40) couldn't set value 347Hz. Due to this reason, testing VBW was set to 500Hz(Worst cases).

The spectrum from 1GHz to 26 GHz is investigated with the transmitter set to the lowest, middle, and highest channels in the 2.4 GHz band.
(From 30MHz to 1GHz, test was performed with the EUT set to transmit at the channel with highest output power)

The frequency range of interest is monitored at a fixed antenna height and EUT azimuth. The EUT is rotated through 360 degrees to maximize emissions received. The antenna is scanned from 1 to 4 meters above the ground plane to further maximize the emission. Measurements are made with the antenna polarized in both the vertical and the horizontal positions.

Note : Emission was pre-scanned from 9KHz to 30MHz; No emissions were detected which was at least 20dB below the specification limit (consider distance correction factor).
Per FCC part 15.31(o), test results were not reported.

Although these tests were performed other than open field test site, adequate comparison measurements were confirmed against 30 m open are test site.
Therefore sufficient tests were made to demonstrate that the alternative site produces results that correlate with the one of tests made in an open field based on KDB 414788.

11.1. TRANSMITTER ABOVE 1 GHz

11.1.1. BASIC DATA RATE GFSK MODULATION

RESTRICTED BANDEDGE (LOW CHANNEL)

HORIZONTAL PEAK AND AVERAGE PLOT

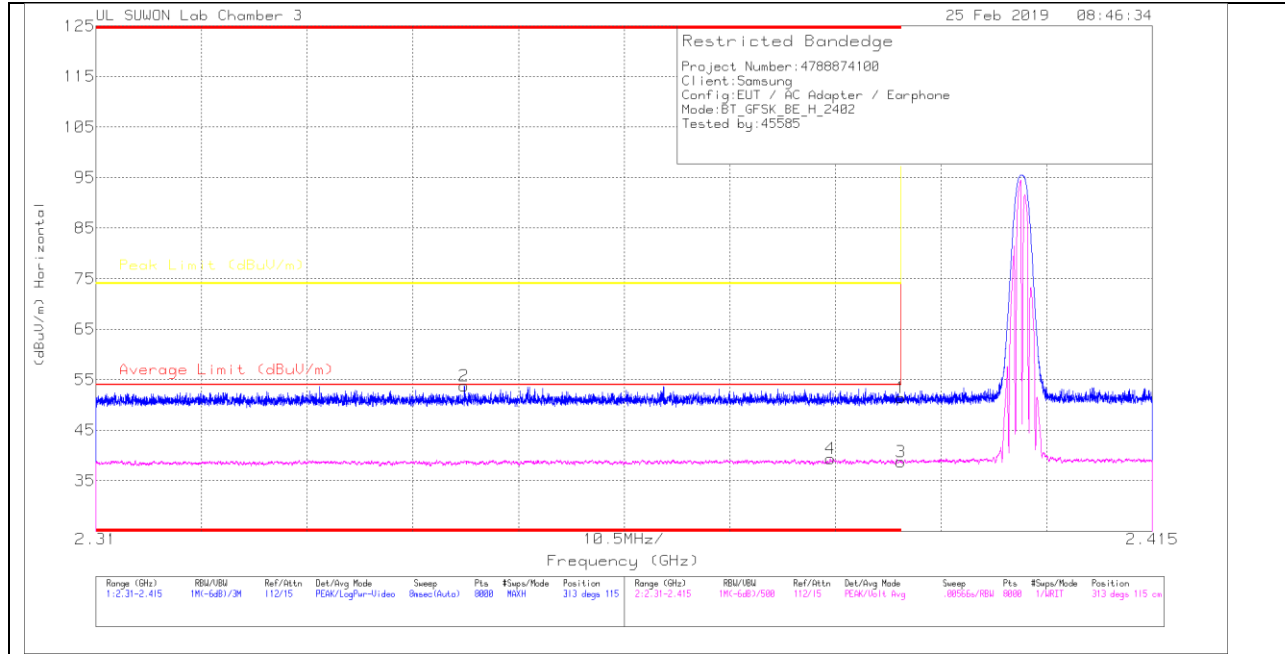

HORIZONTAL DATA

Trace Markers

Marker	Frequency (GHz)	Meter Reading (dBuV)	Det	3117_00205959	10dB(dB)	Corrected Reading (dBuV/m)	Average Limit (dBuV/m)	Margin (dB)	Peak Limit (dBuV/m)	PK Margin (dB)	Azimuth (Degs)	Height (cm)	Polarity
1	* 2.39	43.11	Pk	31.7	-23.4	51.41	-	-	74	-22.59	313	115	H
2	* 2.347	45.59	Pk	31.6	-23.4	53.79	-	-	74	-20.21	313	115	H
3	* 2.39	30.49	VA1T	31.7	-23.4	38.79	54	-15.21	-	-	313	115	H
4	* 2.383	31.01	VA1T	31.7	-23.4	39.31	54	-14.69	-	-	313	115	H

* - indicates frequency in CFR47 Pt 15 / IC RSS-Restricted Band

Pk - Peak detector

VA1T - FHSS: Linear Voltage Average $V_B=1/T_{on}$ where: T_{on} is transmit duration

VERTICAL PEAK AND AVERAGE PLOT

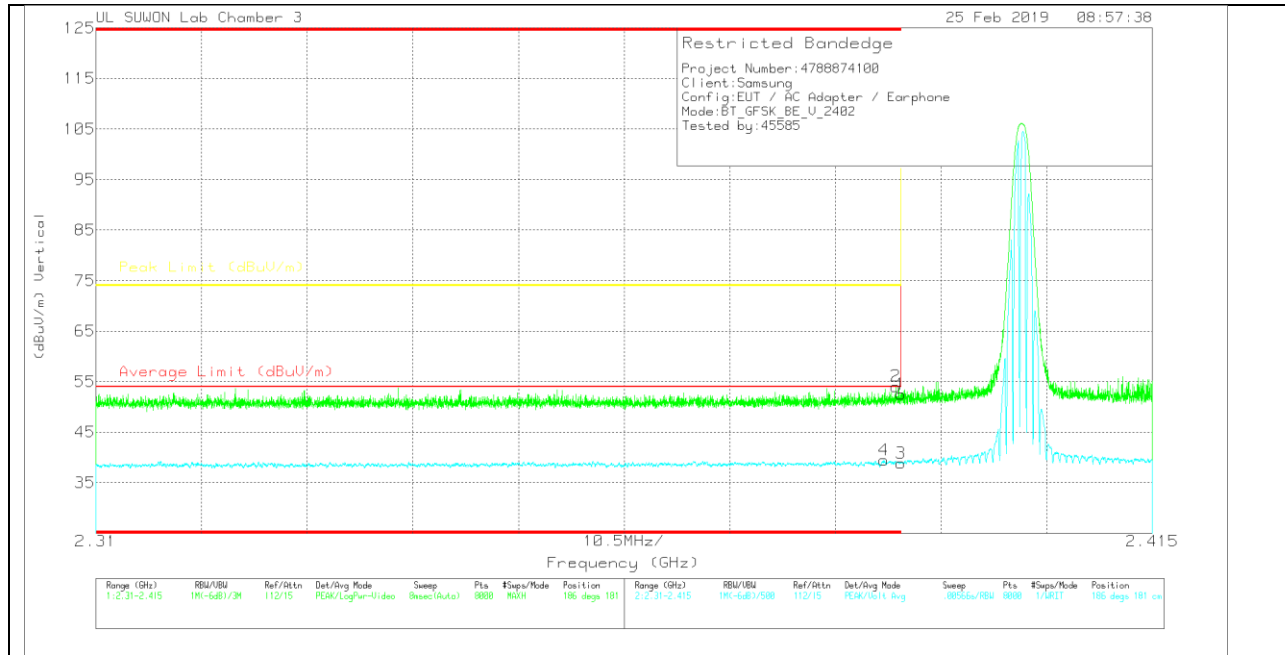

VERTICAL DATA

Trace Markers

Marker	Frequency (GHz)	Meter Reading (dBuV)	Det	3117_00205959	10dB[dB]	Corrected Reading (dBuV/m)	Average Limit (dBuV/m)	Margin (dB)	Peak Limit (dBuV/m)	PK Margin (dB)	Azimuth (Degs)	Height (cm)	Polarity
1	* 2.39	44.25	Pk	31.7	-23.4	52.55	-	-	74	-21.45	186	181	V
2	* 2.39	45.78	Pk	31.7	-23.4	54.08	-	-	74	-19.92	186	181	V
3	* 2.39	30.61	VA1T	31.7	-23.4	38.91	54	-15.09	-	-	186	181	V
4	* 2.388	31.17	VA1T	31.7	-23.4	39.47	54	-14.53	-	-	186	181	V

* - indicates frequency in CFR47 Pt 15 / IC RSS-Restricted Band

Pk - Peak detector

VA1T - FHSS: Linear Voltage Average $V_B=1/T_{on}$ where: T_{on} is transmit duration

AUTHORIZED BANDEDGE (HIGH CHANNEL)

HORIZONTAL PEAK AND AVERAGE PLOT

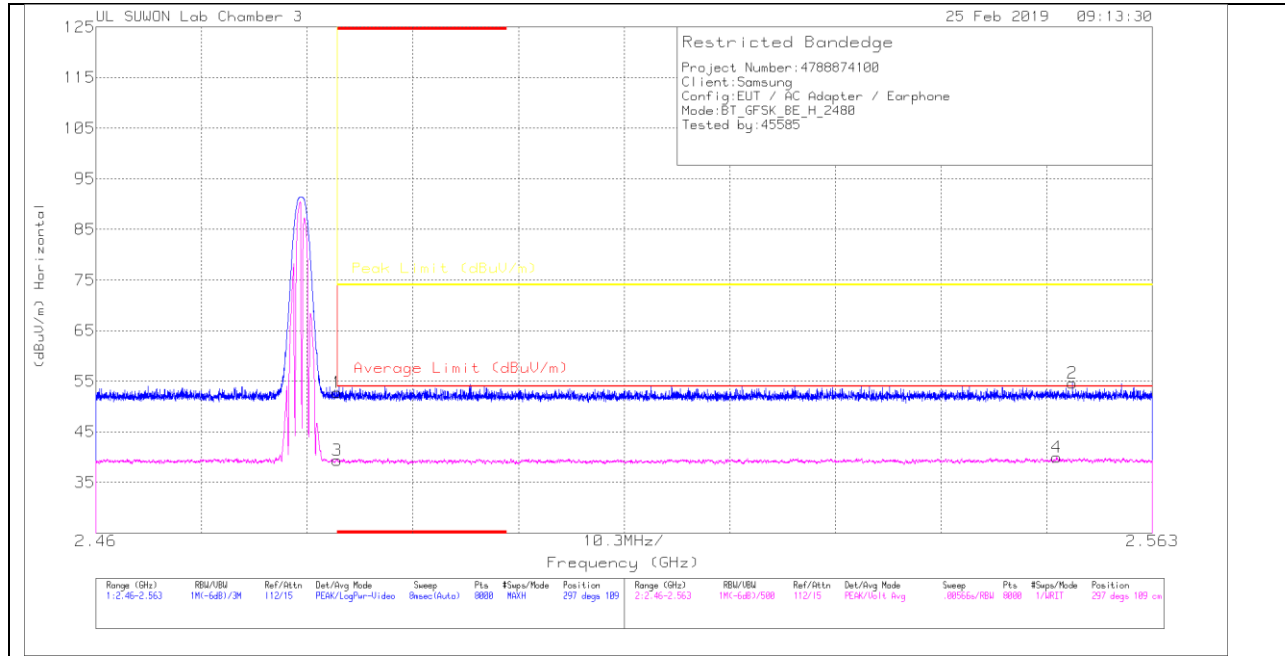

HORIZONTAL DATA

Trace Markers

Marker	Frequency (GHz)	Meter Reading (dBuV)	Det	3117_00205959	10dB[dB]	Corrected Reading (dBuV/m)	Average Limit (dBuV/m)	Margin (dB)	Peak Limit (dBuV/m)	PK Margin (dB)	Azimuth (Degs)	Height (cm)	Polarity
1	* 2.484	44.07	Pk		-23.2	52.77	-	-	74	-21.23	297	109	H
2	2.555	45.69	Pk		-23.1	54.59	-	-	74	-19.41	297	109	H
3	* 2.484	30.72	VA1T		-23.2	39.42	54	-14.58	-	-	297	109	H
4	2.554	30.95	VA1T		-23	39.95	54	-14.05	-	-	297	109	H

* - indicates frequency in CFR47 Pt 15 / IC RSS-Restricted Band

Pk - Peak detector

VA1T - FHSS: Linear Voltage Average $VB=1/Ton$ where: Ton is transmit duration

VERTICAL PEAK AND AVERAGE PLOT

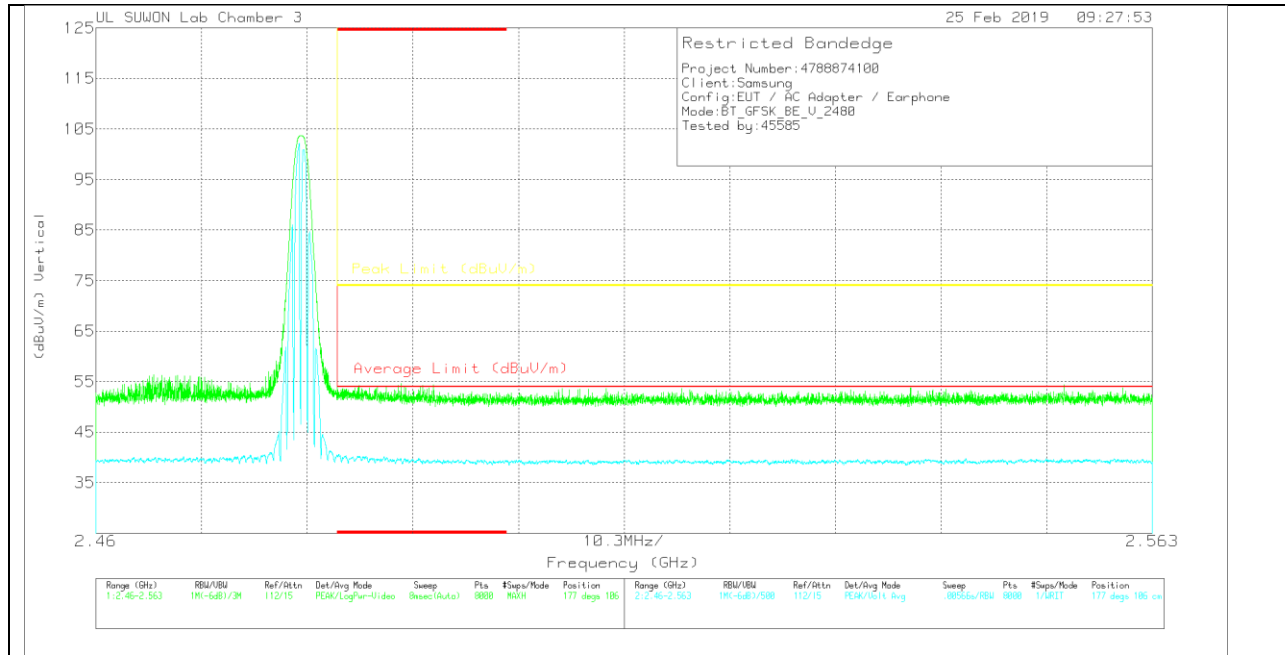

VERTICAL DATA

Trace Markers

Marker	Frequency (GHz)	Meter Reading (dBuV)	Det	3117_00205959	10dB[dB]	Corrected Reading (dBuV/m)	Average Limit (dBuV/m)	Margin (dB)	Peak Limit (dBuV/m)	PK Margin (dB)	Azimuth (Degs)	Height (cm)	Polarity
1	* 2.484	43.87	Pk	31.9	-23.2	52.57	-	-	74	-21.43	177	106	V
2	* 2.49	45.92	Pk	31.9	-23.2	54.62	-	-	74	-19.38	177	106	V
3	* 2.484	31.69	VA1T	31.9	-23.2	40.39	54	-13.61	-	-	177	106	V
4	* 2.484	32.03	VA1T	31.9	-23.3	40.63	54	-13.37	-	-	177	106	V

* - indicates frequency in CFR47 Pt 15 / IC RSS-Restricted Band

Pk - Peak detector

VA1T - FHSS: Linear Voltage Average VB=1/Ton where: Ton is transmit duration

HARMONICS AND SPURIOUS EMISSIONS

LOW CHANNEL HORIZONTAL

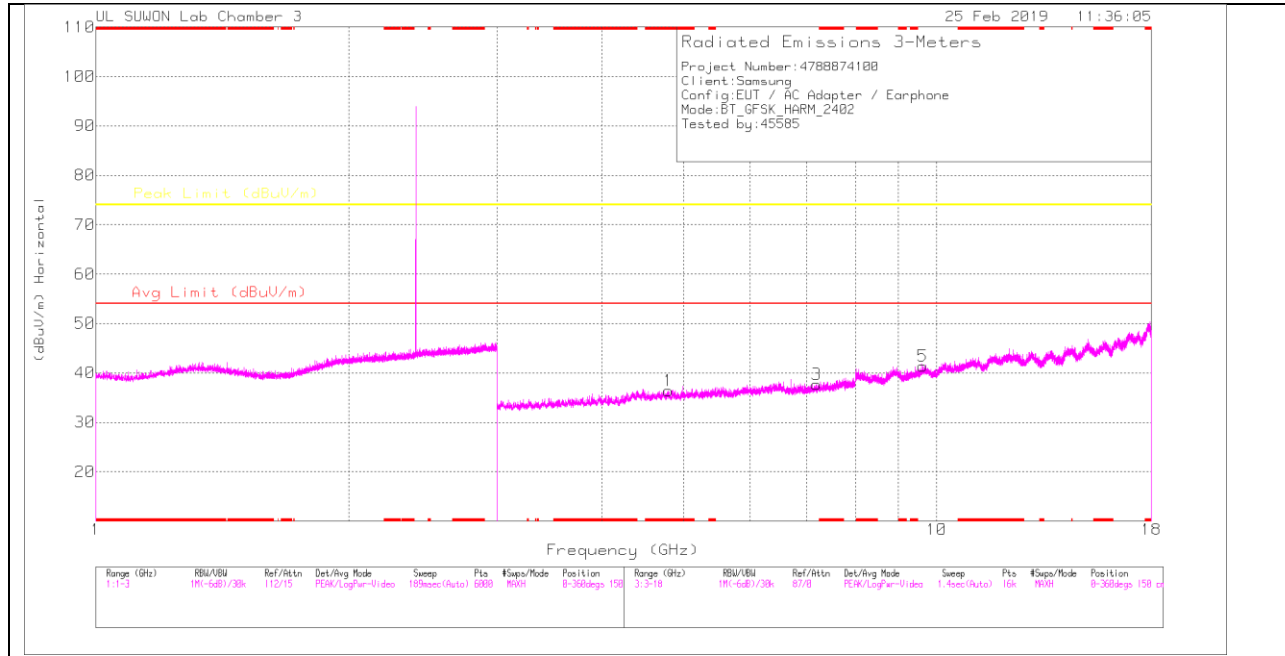

LOW CHANNEL VERTICAL

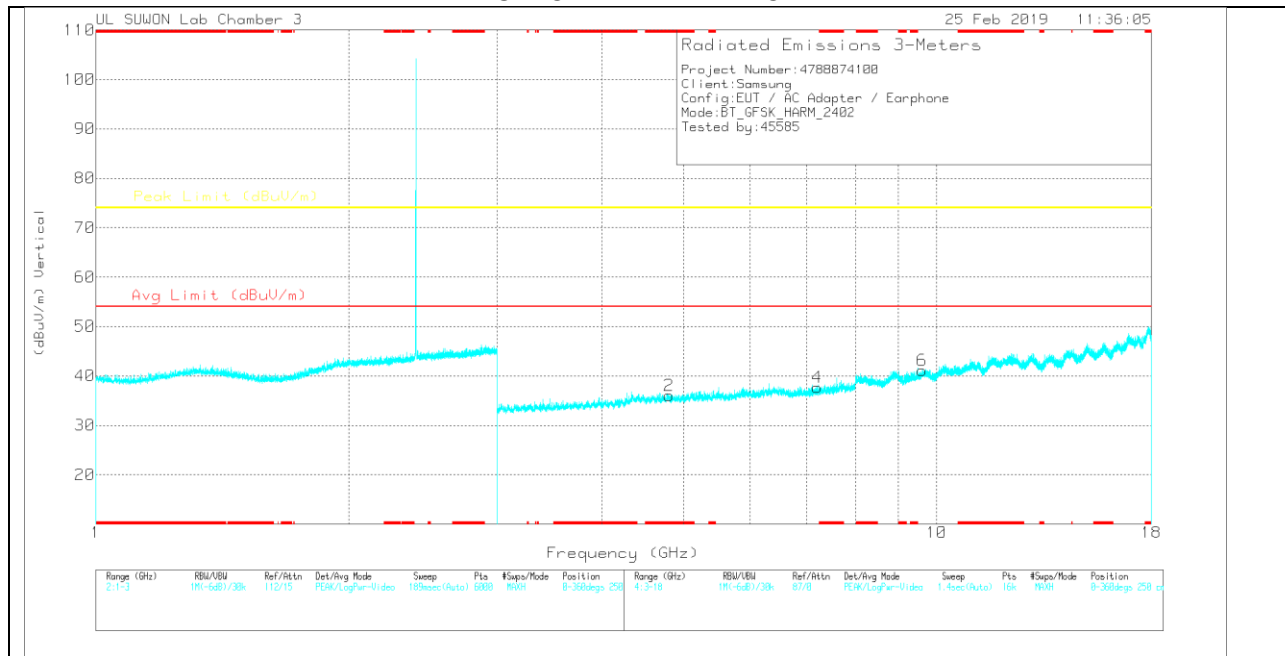

Note: Emission was scanned up to 26GHz; No emissions were detected above the noise floor which was at least 20dB below the specification limit.

LOW CHANNEL DATA

Trace Markers

Marker	Frequency (GHz)	Meter Reading (dBuV)	Det	3117_00205959	3GHz_HP[dB]	Corrected Reading (dBuV/m)	Avg Limit (dBuV/m)	Margin (dB)	Peak Limit (dBuV/m)	Margin (dB)	Azimuth (Degs)	Height (cm)	Polarity
1	* 4.798	30.57	PK	34.2	-28.4	36.37	-	-	74	-37.63	0-360	250	H
3	7.2	26.12	PK	35.8	-24.2	37.72	-	-	74	-36.28	0-360	250	H
5	9.617	24.32	PK	37	-19.9	41.42	-	-	74	-32.58	0-360	250	H
2	* 4.801	30.26	PK	34.2	-28.4	36.06	-	-	74	-37.94	0-360	150	V
4	7.205	26.04	PK	35.8	-24.2	37.64	-	-	74	-36.36	0-360	250	V
6	9.605	24.06	PK	37	-20	41.06	-	-	74	-32.94	0-360	150	V

* - indicates frequency in CFR47 Pt 15 / IC RSS-Restricted Band
 PK – Peak Detector

Note: Only peak measurement was performed. Because peak measurement result of unwanted emission is less than average limit (54dBuV/m).

MID CHANNEL HORIZONTAL

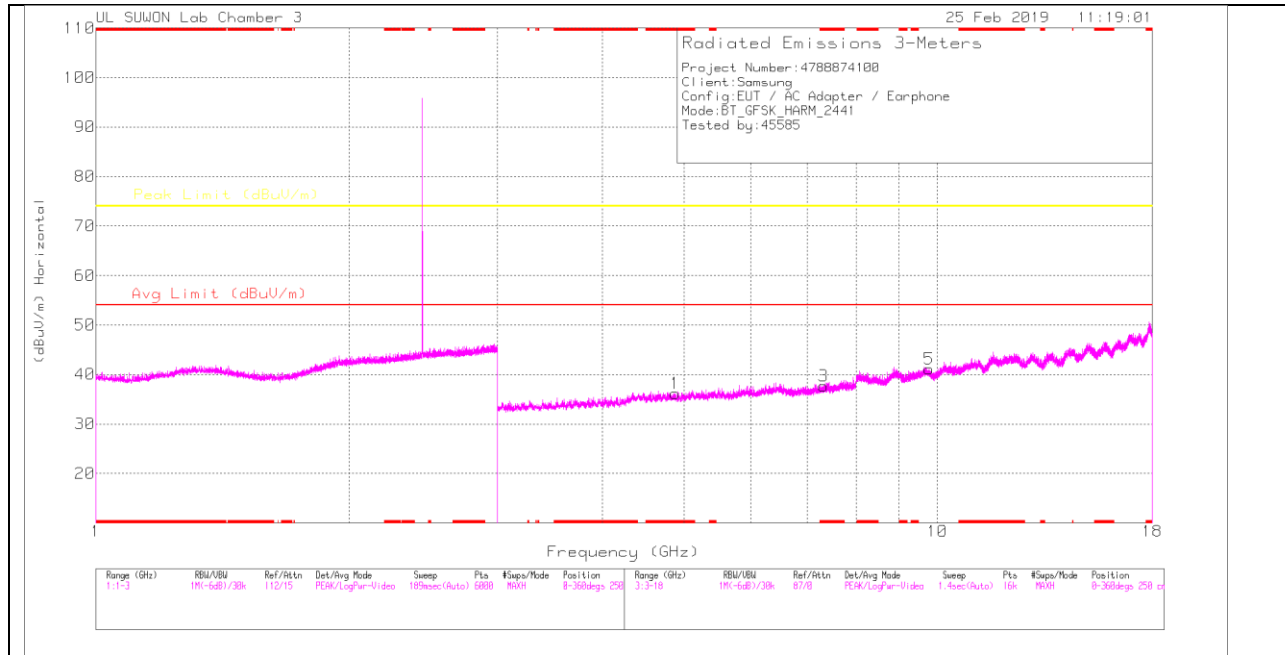

MID CHANNEL VERTICAL

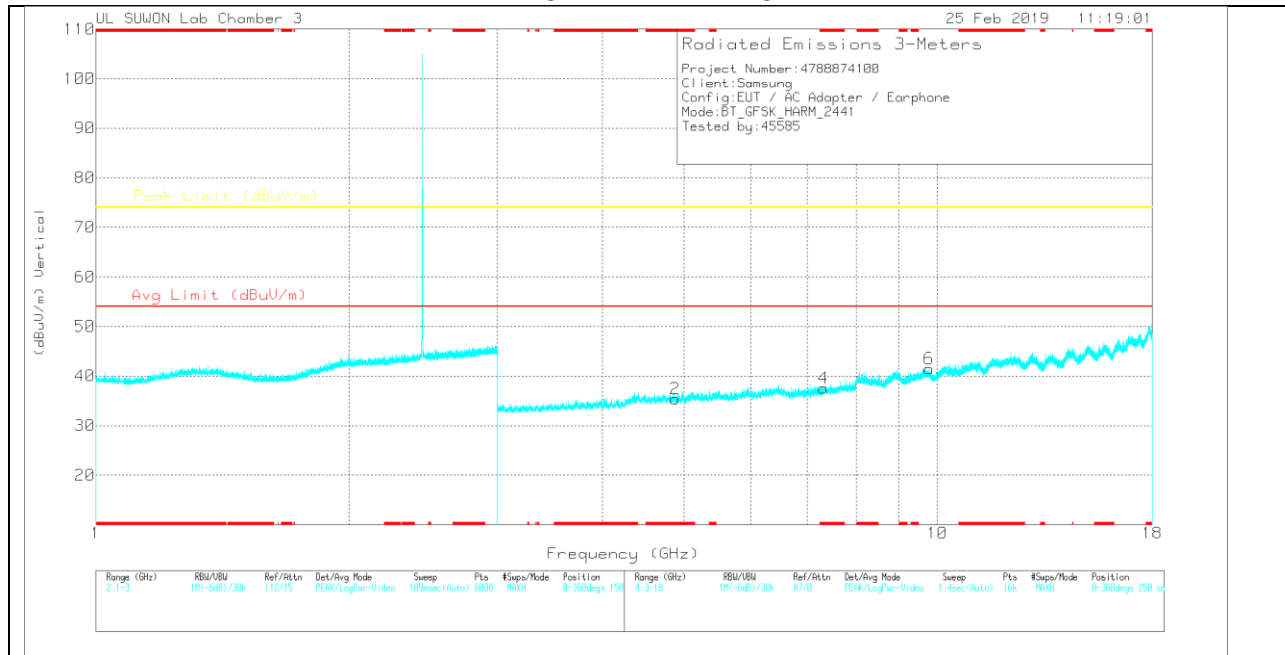

Note: Emission was scanned up to 26GHz; No emissions were detected above the noise floor which was at least 20dB below the specification limit.

MID CHANNEL DATA

Trace Markers

Marker	Frequency (GHz)	Meter Reading (dBuV)	Det	3117_00205959	3GHz_HP[dB]	Corrected Reading (dBuV/m)	Avg Limit (dBuV/m)	Margin (dB)	Peak Limit (dBuV/m)	Margin (dB)	Azimuth (Degs)	Height (cm)	Polarity
1	* 4.876	31.03	PK	34.2	-29.1	36.13	-	-	74	-37.87	0-360	150	H
3	* 7.323	25.46	PK	35.8	-23.6	37.66	-	-	74	-36.34	0-360	150	H
5	9.768	23.4	PK	37.3	-19.6	41.1	-	-	74	-32.9	0-360	150	H
2	* 4.881	30.29	PK	34.2	-29.1	35.39	-	-	74	-38.61	0-360	150	V
4	* 7.328	25.31	PK	35.8	-23.6	37.51	-	-	74	-36.49	0-360	250	V
6	9.771	23.82	PK	37.3	-19.6	41.52	-	-	74	-32.48	0-360	150	V

* - indicates frequency in CFR47 Pt 15 / IC RSS-Restricted Band

PK – Peak Detector

Note: Only peak measurement was performed. Because peak measurement result of unwanted emission is less than average limit (54dBuV/m).

HIGH CHANNEL HORIZONTAL

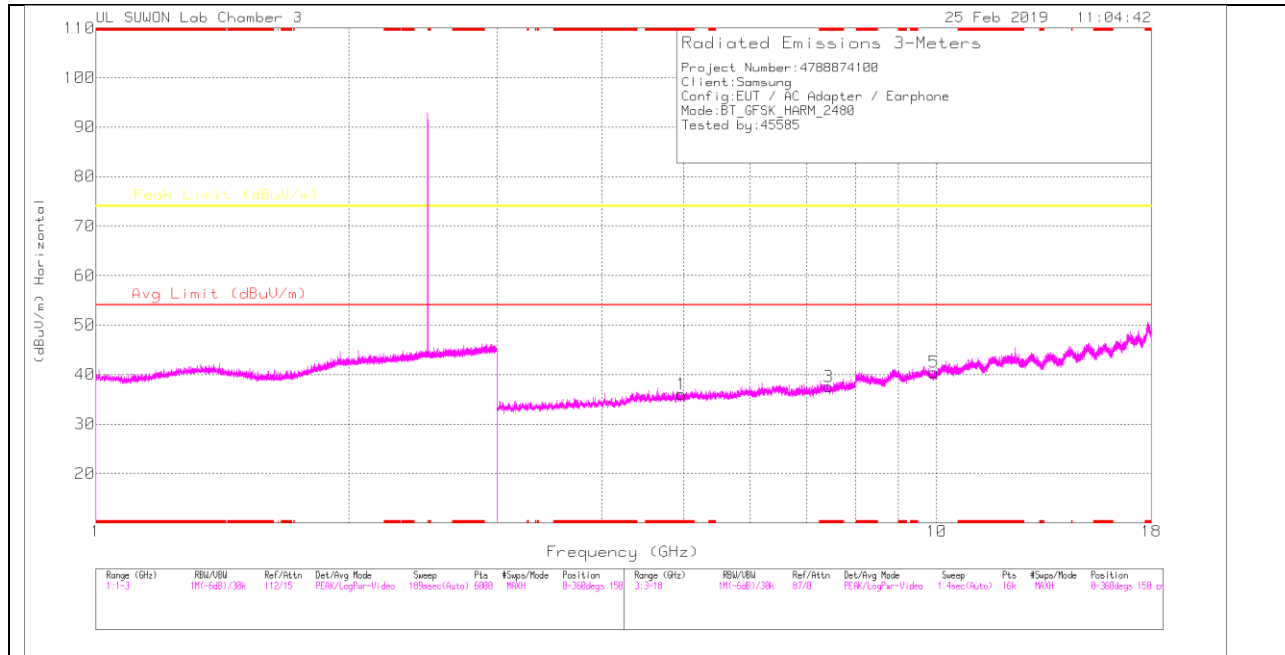

HIGH CHANNEL VERTICAL

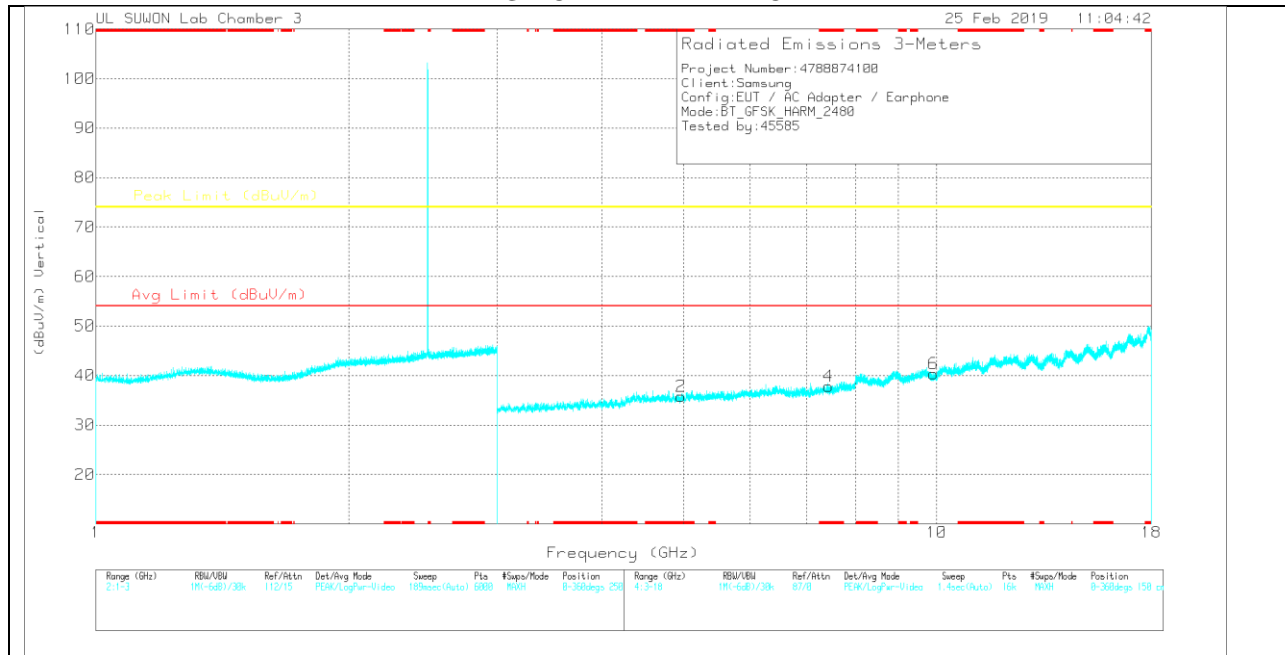

Note: Emission was scanned up to 26GHz; No emissions were detected above the noise floor which was at least 20dB below the specification limit.

HIGH CHANNEL DATA

Trace Markers

Marker	Frequency (GHz)	Meter Reading (dBuV)	Det	3117_00205959	3GHz_HP[dB]	Corrected Reading (dBuV/m)	Avg Limit (dBuV/m)	Margin (dB)	Peak Limit (dBuV/m)	Margin (dB)	Azimuth (Degs)	Height (cm)	Polarity
1	* 4.969	30.55	PK	34.2	-28.7	36.05	-	-	74	-37.95	0-360	150	H
3	* 7.437	25.12	PK	35.8	-23.4	37.52	-	-	74	-36.48	0-360	250	H
5	9.921	22.68	PK	37.5	-19.7	40.48	-	-	74	-33.52	0-360	150	H
2	* 4.96	30.5	PK	34.2	-28.9	35.8	-	-	74	-38.2	0-360	250	V
4	* 7.439	25.39	PK	35.8	-23.4	37.79	-	-	74	-36.21	0-360	250	V
6	9.917	22.51	PK	37.5	-19.7	40.31	-	-	74	-33.69	0-360	250	V

* - indicates frequency in CFR47 Pt 15 / IC RSS-Restricted Band

PK – Peak Detector

Note: Only peak measurement was performed. Because peak measurement result of unwanted emission is less than average limit (54dBuV/m).

11.1.2. ENHANCED DATA RATE 8PSK MODULATION RESTRICTED BANDEDGE (LOW CHANNEL)

HORIZONTAL PEAK AND AVERAGE PLOT

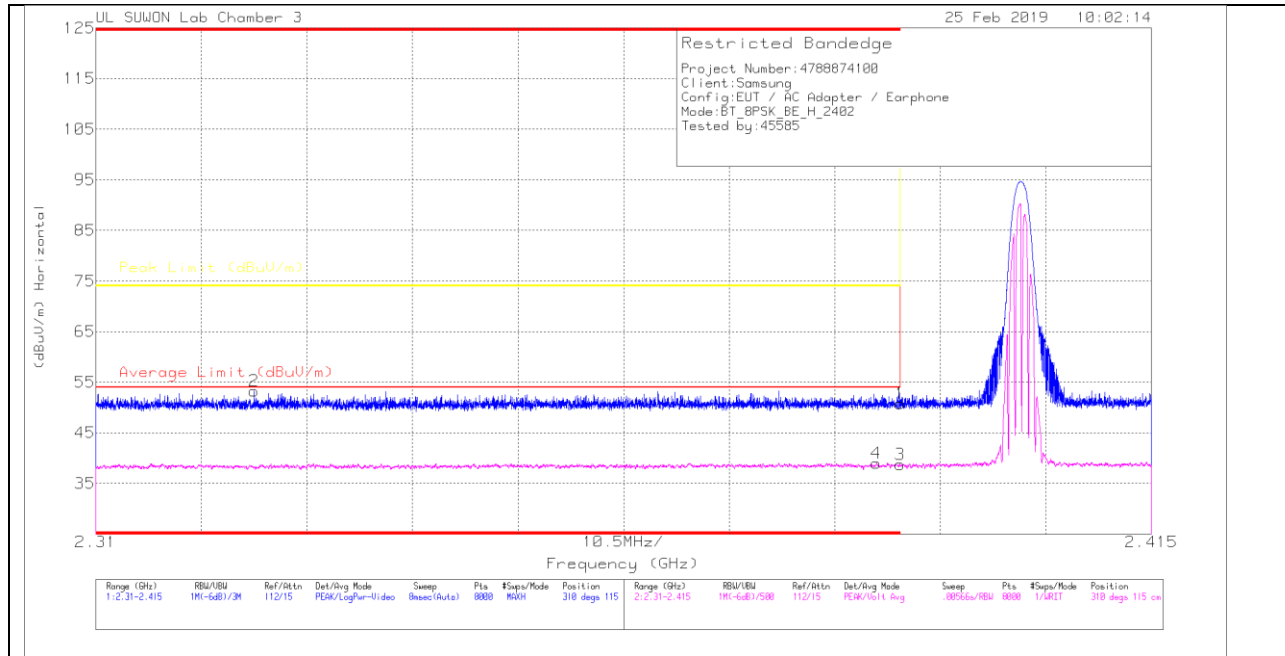

HORIZONTAL DATA

Trace Markers

Marker	Frequency (GHz)	Meter Reading (dBuV)	Det	3117_00205959	10dB(dB)	Corrected Reading (dBuV/m)	Average Limit (dBuV/m)	Margin (dB)	Peak Limit (dBuV/m)	PK Margin (dB)	Azimuth (Degs)	Height (cm)	Polarity
1	* 2.39	42.51	Pk	31.7	-23.4	50.81	-	-	74	-23.19	310	115	H
2	* 2.326	45.17	Pk	31.5	-23.4	53.27	-	-	74	-20.73	310	115	H
3	* 2.39	30.4	VA1T	31.7	-23.4	38.7	54	-15.3	-	-	310	115	H
4	* 2.388	30.75	VA1T	31.7	-23.4	39.05	54	-14.95	-	-	310	115	H

* - indicates frequency in CFR47 Pt 15 / IC RSS-Restricted Band

Pk - Peak detector

VA1T - FHSS: Linear Voltage Average $V_B=1/T_{on}$ where: T_{on} is transmit duration

VERTICAL PEAK AND AVERAGE PLOT

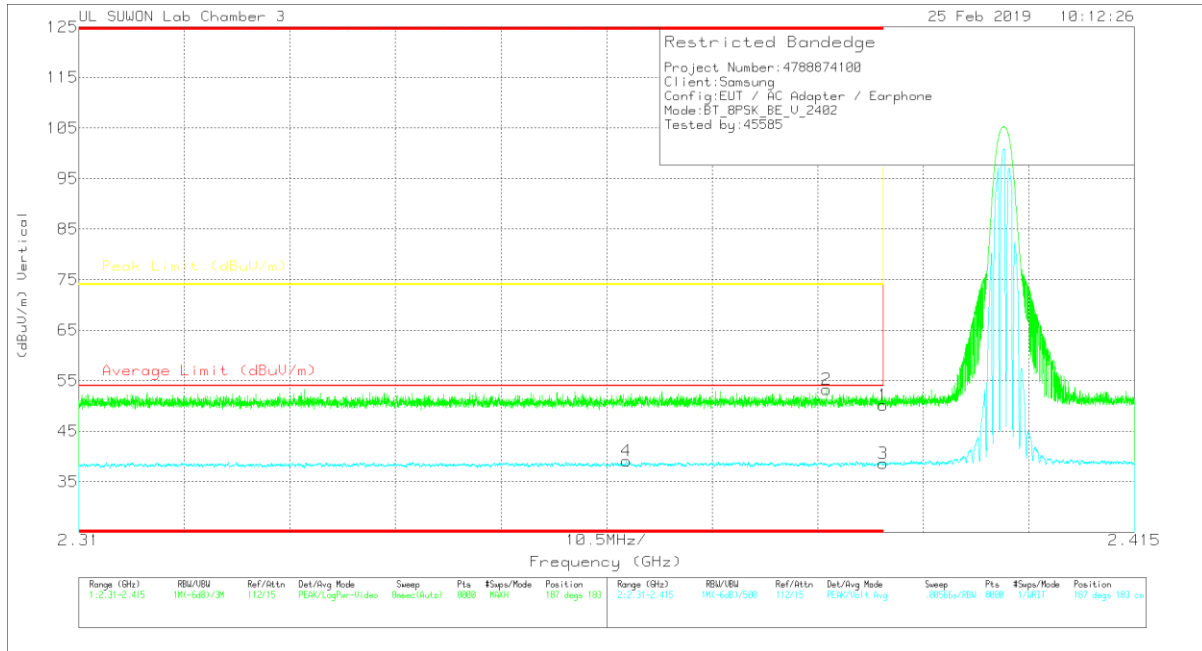

Trace Markers

Marker	Frequency (GHz)	Meter Reading (dBuV)	Det	3117_00205959	10dB[dB]	Corrected Reading (dBuV/m)	Average Limit (dBuV/m)	Margin (dB)	Peak Limit (dBuV/m)	PK Margin (dB)	Azimuth (Degs)	Height (cm)	Polarity
1	* 2.39	41.89	Pk	31.7	-23.4	50.19	-	-	74	-23.81	187	183	V
2	* 2.384	45.01	Pk	31.7	-23.4	53.31	-	-	74	-20.69	187	183	V
3	* 2.39	30.37	VA1T	31.7	-23.4	38.67	54	-15.33	-	-	187	183	V
4	* 2.364	30.89	VA1T	31.6	-23.4	39.09	54	-14.91	-	-	187	183	V

* - indicates frequency in CFR47 Pt 15 / IC RSS-Restricted Band

Pk - Peak detector

VA1T - FHSS: Linear Voltage Average $V_B=1/T_{on}$ where: T_{on} is transmit duration

AUTHORIZED BANDEDGE (HIGH CHANNEL)

HORIZONTAL PEAK AND AVERAGE PLOT

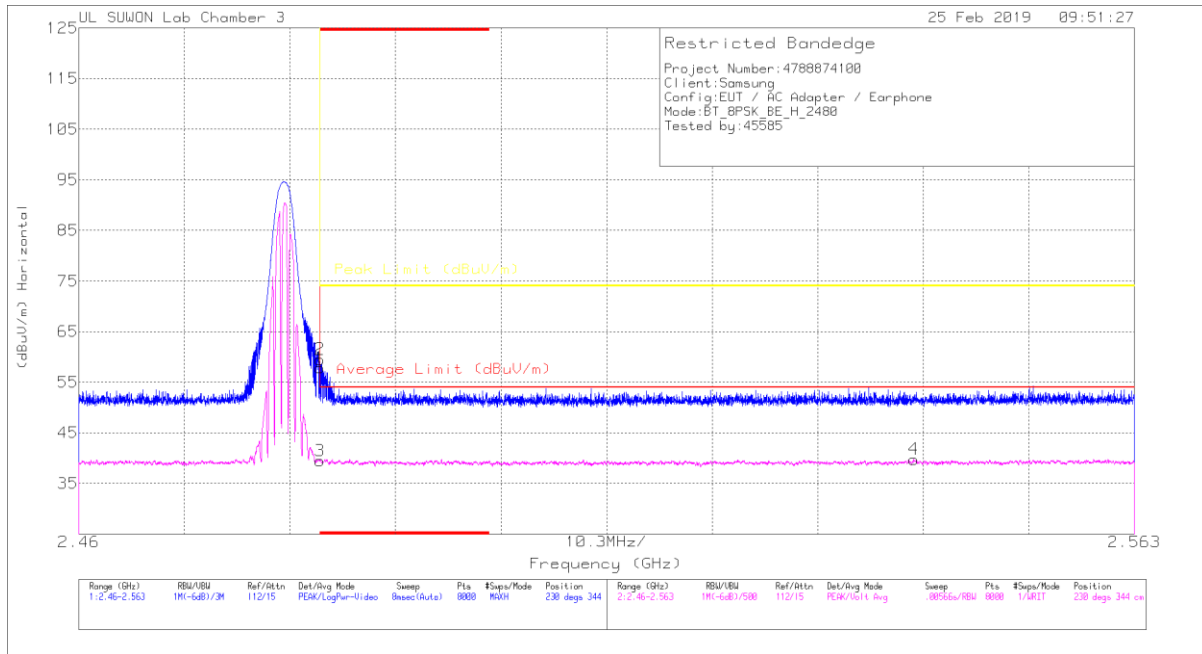

Trace Markers

Marker	Frequency (GHz)	Meter Reading (dBuV)	Det	3117_00205959	10dB(dB)	Corrected Reading (dBuV/m)	Average Limit (dBuV/m)	Margin (dB)	Peak Limit (dBuV/m)	PK Margin (dB)	Azimuth (Degs)	Height (cm)	Polarity
1	* 2.484	49.16	Pk		-23.2	57.86	-	-	74	-16.14	230	344	H
2	* 2.484	50.84	Pk		-23.2	59.54	-	-	74	-14.46	230	344	H
3	* 2.484	30.77	VA1T		-23.2	39.47	54	-14.53	-	-	230	344	H
4	2.541	30.9	VA1T		-23.1	39.8	54	-14.2	-	-	230	344	H

* - indicates frequency in CFR47 Pt 15 / IC RSS-Restricted Band

Pk - Peak detector

VA1T - FHSS: Linear Voltage Average $VB=1/T_{on}$ where: T_{on} is transmit duration

VERTICAL PEAK AND AVERAGE PLOT

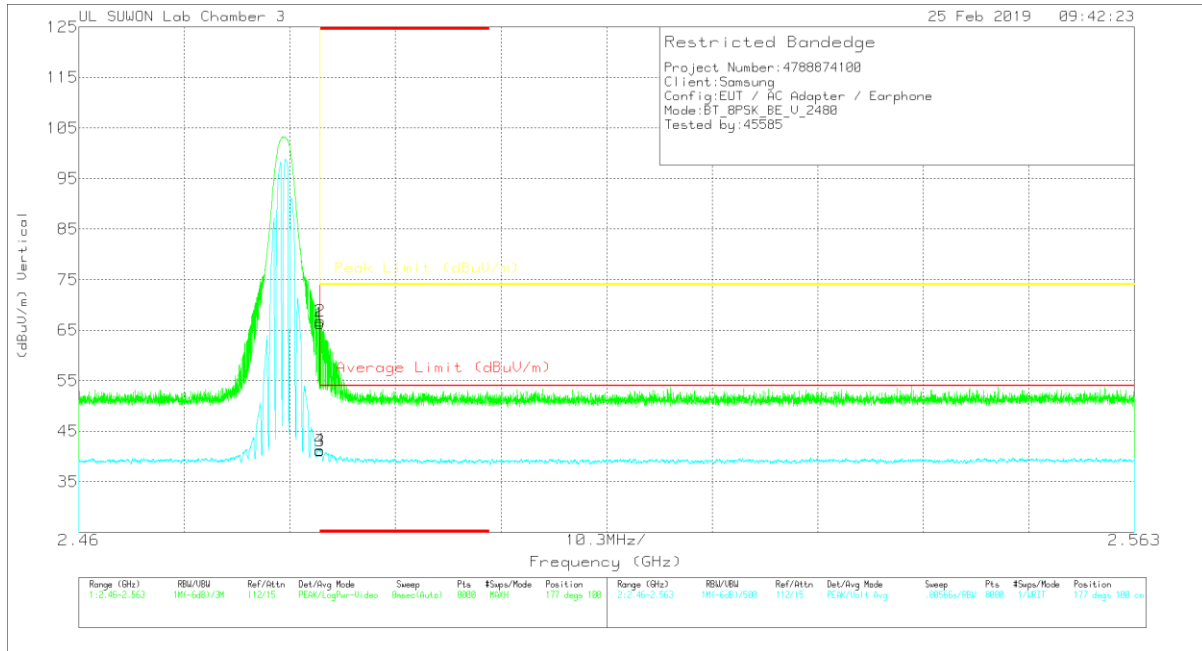

Trace Markers

Marker	Frequency (GHz)	Meter Reading (dBuV)	Det	3117_00205959	10dB[dB]	Corrected Reading (dBuV/m)	Average Limit (dBuV/m)	Margin (dB)	Peak Limit (dBuV/m)	PK Margin (dB)	Azimuth (Degs)	Height (cm)	Polarity
1	* 2.484	57.58	Pk	31.9	-23.2	66.28	-	-	74	-7.72	177	100	V
2	* 2.484	58.07	Pk	31.9	-23.2	66.77	-	-	74	-7.23	177	100	V
3	* 2.484	32.37	VA1T	31.9	-23.2	41.07	54	-12.93	-	-	177	100	V
4	* 2.484	32.59	VA1T	31.9	-23.2	41.29	54	-12.71	-	-	177	100	V

* - indicates frequency in CFR47 Pt 15 / IC RSS-Restricted Band

Pk - Peak detector

VA1T - FHSS: Linear Voltage Average $V_B=1/T_{on}$ where: T_{on} is transmit duration

HARMONICS AND SPURIOUS EMISSIONS

LOW CHANNEL HORIZONTAL

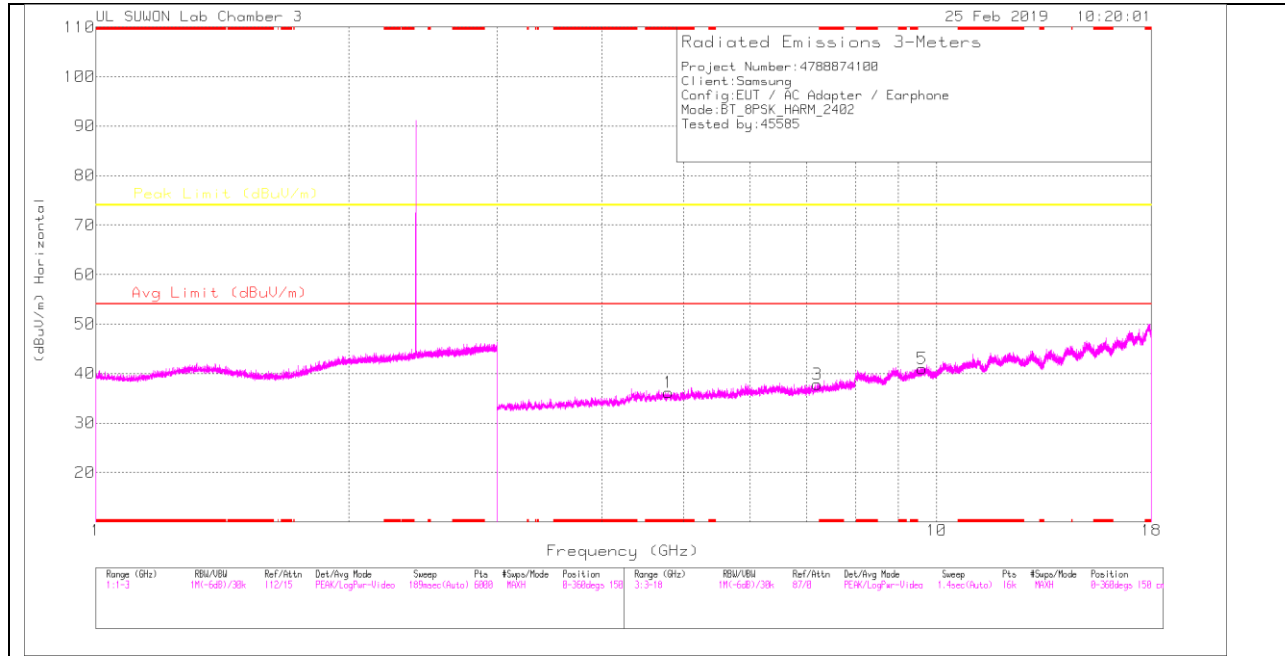

LOW CHANNEL VERTICAL

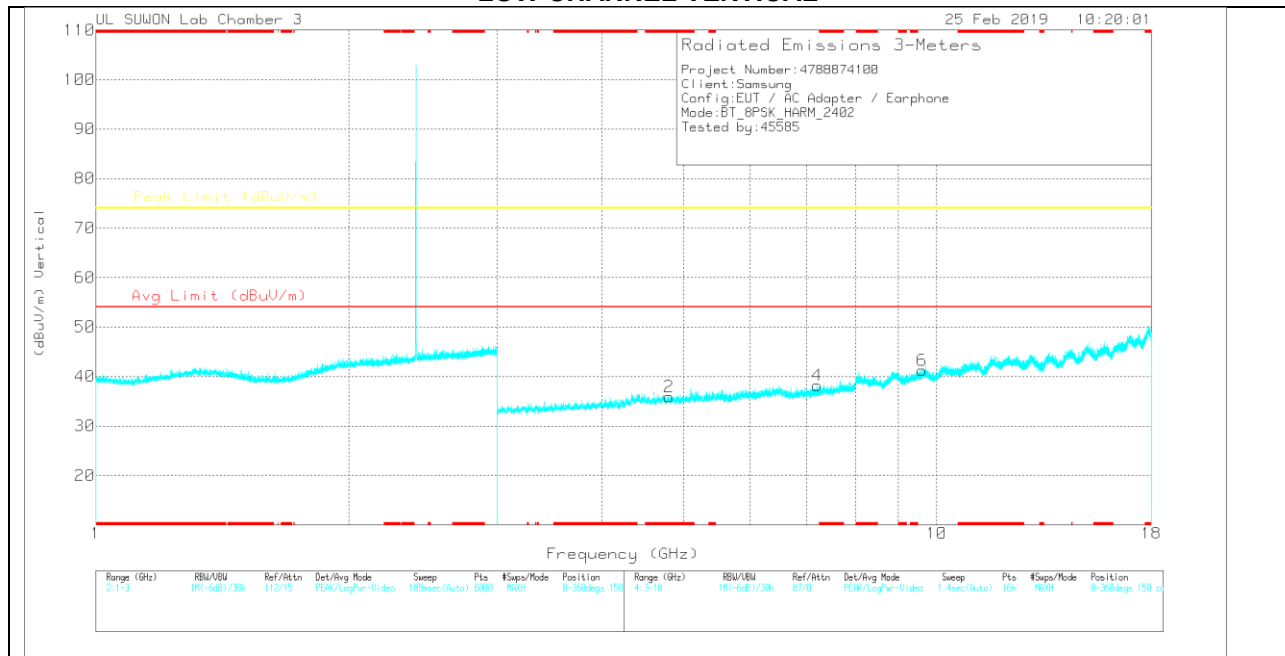

Note: Emission was scanned up to 26GHz; No emissions were detected above the noise floor which was at least 20dB below the specification limit.

LOW CHANNEL DATA

Trace Markers

Marker	Frequency (GHz)	Meter Reading (dBuV)	Det	3117_00205959	3GHz_HP[dB]	Corrected Reading (dBuV/m)	Avg Limit (dBuV/m)	Margin (dB)	Peak Limit (dBuV/m)	Margin (dB)	Azimuth (Degs)	Height (cm)	Polarity
1	* 4.8	30.34	PK	34.2	-28.4	36.14	-	-	74	-37.86	0-360	250	H
3	7.21	26.26	PK	35.8	-24.2	37.86	-	-	74	-36.14	0-360	250	H
5	9.609	23.91	PK	37	-19.9	41.01	-	-	74	-32.99	0-360	250	H
2	* 4.802	30.09	PK	34.2	-28.4	35.89	-	-	74	-38.11	0-360	250	V
4	7.21	26.62	PK	35.8	-24.2	38.22	-	-	74	-35.78	0-360	150	V
6	9.605	24.25	PK	37	-20	41.25	-	-	74	-32.75	0-360	150	V

* - indicates frequency in CFR47 Pt 15 / IC RSS-Restricted Band
 PK – Peak Detector

Note: Only peak measurement was performed. Because peak measurement result of unwanted emission is less than average limit (54dBuV/m).

MID CHANNEL HORIZONTAL

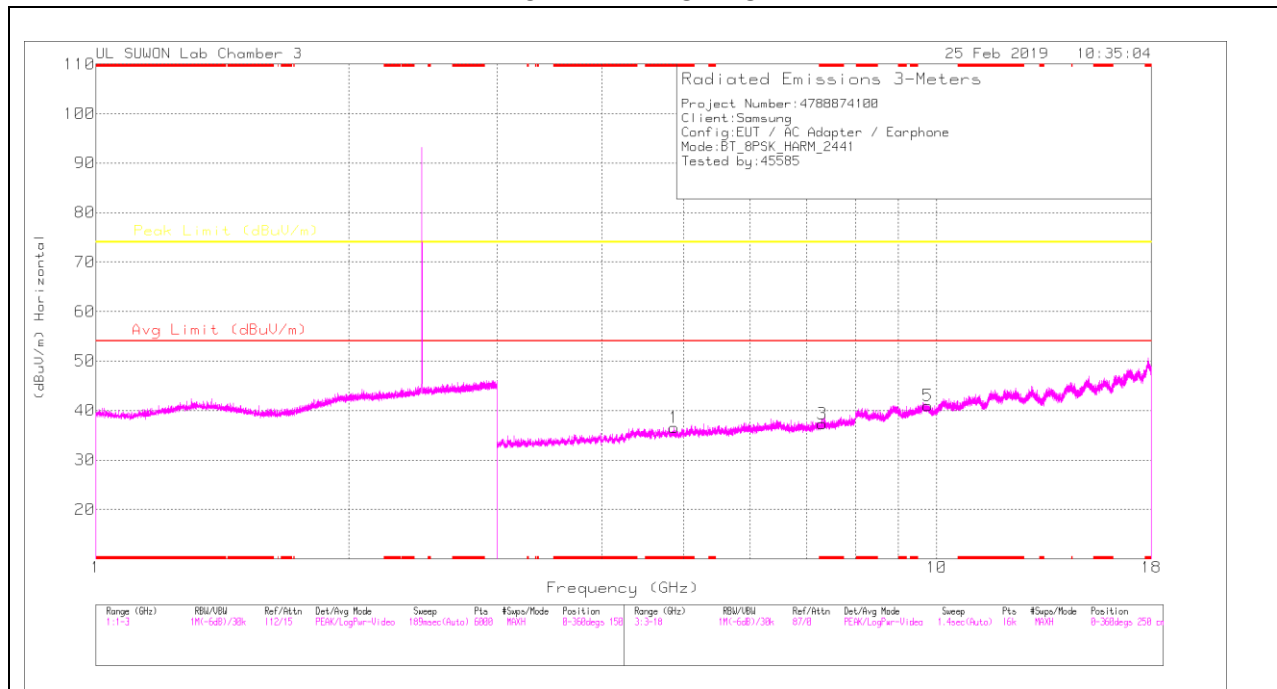

MID CHANNEL VERTICAL

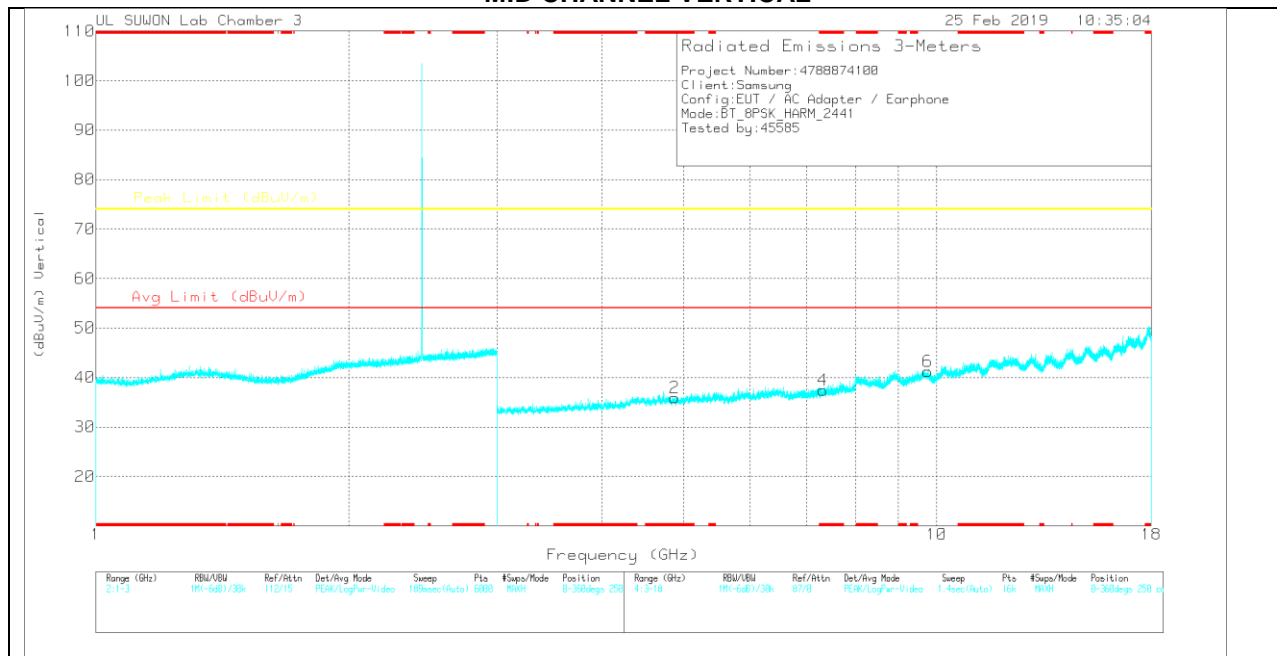

Note: Emission was scanned up to 26GHz; No emissions were detected above the noise floor which was at least 20dB below the specification limit.

MID CHANNEL DATA

Trace Markers

Marker	Frequency (GHz)	Meter Reading (dBuV)	Det	3117_00205959	3GHz_HP[dB]	Corrected Reading (dBuV/m)	Avg Limit (dBuV/m)	Margin (dB)	Peak Limit (dBuV/m)	Margin (dB)	Azimuth (Degs)	Height (cm)	Polarity
1	* 4.874	31.32	PK	34.2	-29	36.52	-	-	74	-37.48	0-360	150	H
3	* 7.315	25.35	PK	35.8	-23.8	37.35	-	-	74	-36.65	0-360	150	H
5	9.758	23.43	PK	37.2	-19.6	41.03	-	-	74	-32.97	0-360	150	H
2	* 4.876	30.81	PK	34.2	-29.1	35.91	-	-	74	-38.09	0-360	150	V
4	* 7.317	25.27	PK	35.8	-23.7	37.37	-	-	74	-36.63	0-360	150	V
6	9.755	23.58	PK	37.2	-19.5	41.28	-	-	74	-32.72	0-360	150	V

* - indicates frequency in CFR47 Pt 15 / IC RSS-Restricted Band

PK – Peak Detector

Note: Only peak measurement was performed. Because peak measurement result of unwanted emission is less than average limit (54dBuV/m).

HIGH CHANNEL HORIZONTAL

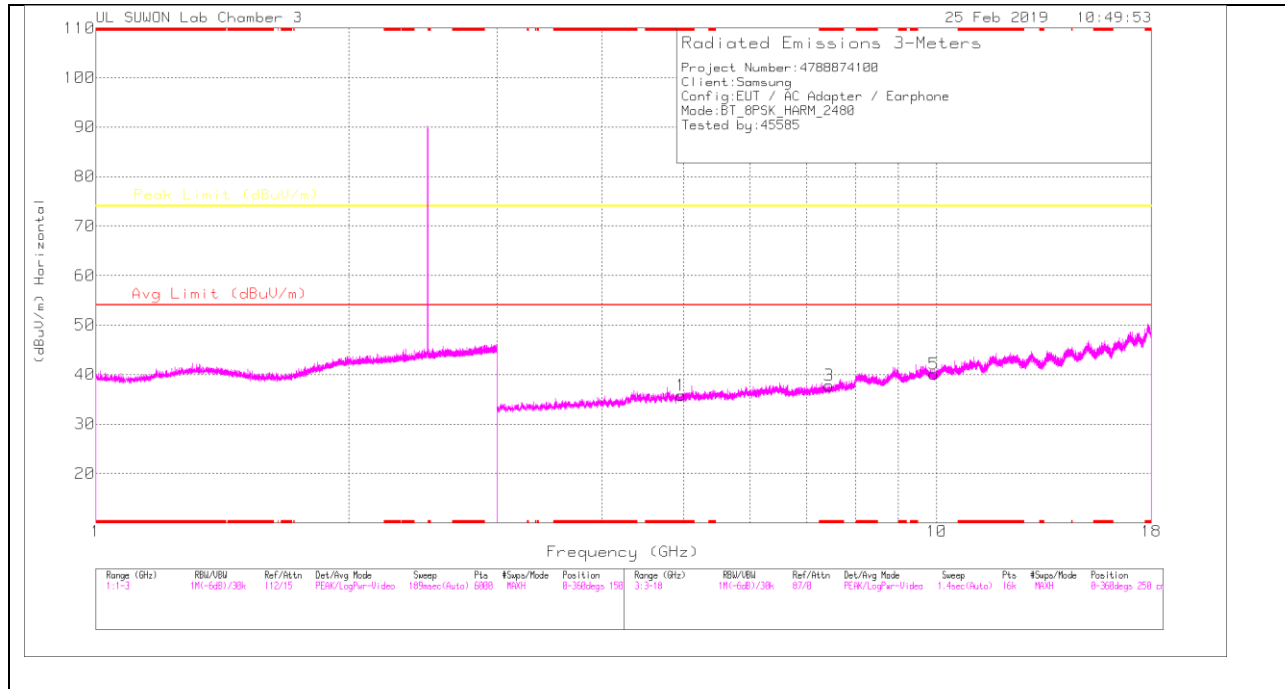

HIGH CHANNEL VERTICAL

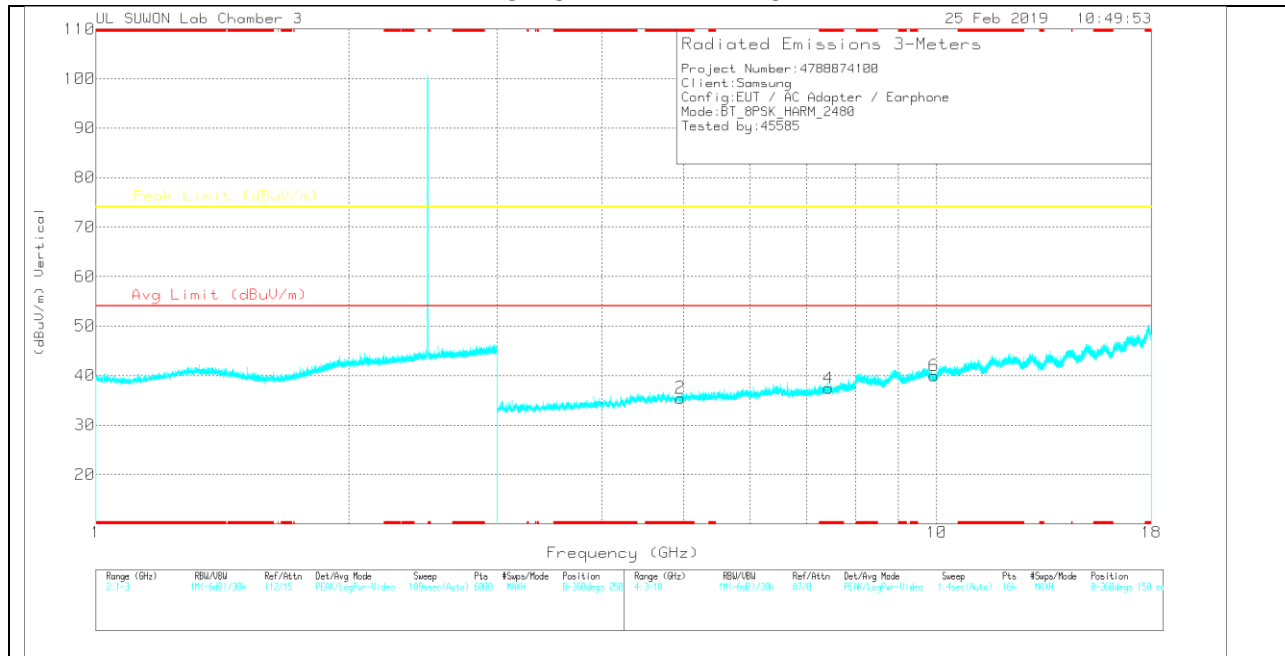

Note: Emission was scanned up to 26GHz; No emissions were detected above the noise floor which was at least 20dB below the specification limit.

HIGH CHANNEL DATA

Trace Markers

Marker	Frequency (GHz)	Meter Reading (dBuV)	Det	3117_00205959	3GHz_HP[dB]	Corrected Reading (dBuV/m)	Avg Limit (dBuV/m)	Margin (dB)	Peak Limit (dBuV/m)	Margin (dB)	Azimuth (Degs)	Height (cm)	Polarity
1	* 4.962	30.42	PK	34.2	-28.9	35.72	-	-	74	-38.28	0-360	150	H
3	* 7.443	25.5	PK	35.8	-23.5	37.8	-	-	74	-36.2	0-360	250	H
5	9.919	22.35	PK	37.5	-19.7	40.15	-	-	74	-33.85	0-360	150	H
2	* 4.959	30.16	PK	34.2	-28.9	35.46	-	-	74	-38.54	0-360	250	V
4	* 7.439	25.02	PK	35.8	-23.4	37.42	-	-	74	-36.58	0-360	150	V
6	9.92	22.14	PK	37.5	-19.7	39.94	-	-	74	-34.06	0-360	150	V

* - indicates frequency in CFR47 Pt 15 / IC RSS-Restricted Band
 PK – Peak Detector

Note: Only peak measurement was performed. Because peak measurement result of unwanted emission is less than average limit (54dBuV/m).