



PART 2 RF EXPOSURE EVALUATION REPORT

Applicant Name:

Samsung Electronics Co., Ltd.
129, Samsung-ro, Maetan dong,
Suwon-Si, Gyeonggi-Do
16677, Korea (Republic Of)

Date of Testing:

12/05/2023 – 12/22/2023

Test Site/Location:

Element, Columbia, MD, USA

Document Serial No.:

1M2310260110-21.A3L

FCC ID:

A3LSMA356E

APPLICANT:

SAMSUNG ELECTRONICS CO., LTD.

DUT Type:

Portable Handset

Application Type:

Certification

FCC Rule Part(s):

CFR §2.1093

Model:

SM-A356E/DS

Additional Model:

SM-A356E

Device Serial Numbers:

Pre-Production Samples [0797M, 0820M]

I attest to the accuracy of data. All measurements reported herein were performed by me or were made under my supervision and are correct to the best of my knowledge and belief. I assume full responsibility for the completeness of these measurements and vouch for the qualifications of all persons taking them. Test results reported herein relate only to the item(s) tested.



RJ Ortanez

Executive Vice President



FCC ID: A3LSMA356E	PART 2 RF EXPOSURE EVALUATION REPORT	Approved by: Technical Manager
Document S/N: 1M2310260110-21.A3L	DUT Type: Portable Handset	Page 1 of 66

T A B L E O F C O N T E N T S

1	DEVICE UNDER TEST	3
2	RF EXPOSURE LIMITS.....	5
3	S.LSI TAS OPERATION	7
4	TIME VARYING TRANSMISSION TEST CASES.....	9
5	FCC MEASUREMENT PROCEDURES (FREQ < 6 GHZ)	11
6	MEASUREMENT TEST SETUP (FREQ < 6 GHZ).....	20
7	TEST CONFIGURATIONS (FREQ < 6 GHZ).....	23
8	CONDUCTED TX CASES (FREQ < 6 GHZ).....	28
9	EQUIPMENT LIST.....	62
10	MEASUREMENT UNCERTAINTIES.....	63
11	CONCLUSION	64
12	REFERENCES.....	65

APPENDIX A: TEST SETUP PHOTOGRAPHS

APPENDIX B: TEST SEQUENCES

FCC ID: A3LSMA356E	PART 2 RF EXPOSURE EVALUATION REPORT	Approved by: Technical Manager
Document S/N: 1M2310260110-21.A3L	DUT Type: Portable Handset	Page 2 of 66

1 DEVICE UNDER TEST

1.1 Device Overview

Band & Mode	Operating Modes	Tx Frequency
GSM/GPRS/EDGE 850	Voice/Data	824.20 - 848.80 MHz
GSM/GPRS/EDGE1900	Voice/Data	1850.20 - 1909.80 MHz
UMTS 850	Voice/Data	826.40 - 846.60 MHz
UMTS 1750	Voice/Data	1712.4 - 1752.6 MHz
UMTS 1900	Voice/Data	1852.4 - 1907.6 MHz
LTE Band 12	Voice/Data	699.7 - 715.3 MHz
LTE Band 17	Voice/Data	706.5 - 713.5 MHz
LTE Band 13	Voice/Data	779.5 - 784.5 MHz
LTE Band 26	Voice/Data	814.7 - 848.3 MHz
LTE Band 5	Voice/Data	824.7 - 848.3 MHz
LTE Band 66	Voice/Data	1710.7 - 1779.3 MHz
LTE Band 4	Voice/Data	1710.7 - 1754.3 MHz
LTE Band 25	Voice/Data	1850.7 - 1914.3 MHz
LTE Band 2	Voice/Data	1850.7 - 1909.3 MHz
LTE Band 41	Voice/Data	2498.5 - 2687.5 MHz
NR Band n5	Voice/Data	826.5 - 846.5 MHz
NR Band n66	Voice/Data	1712.5 - 1777.5 MHz
NR Band n41	Voice/Data	2501.01 - 2685 MHz
NR Band n77	Voice/Data	3455.01 - 3544.98 MHz; 3705 - 3975 MHz
2.4 GHz WIFI	Voice/Data	2412 - 2472 MHz
5 GHz WIFI	Voice/Data	U-NII-1: 5180 - 5240 MHz U-NII-2A: 5260 - 5320 MHz U-NII-2C: 5500 - 5720 MHz U-NII-3: 5745 - 5825 MHz
2.4 GHz Bluetooth	Data	2402 - 2480 MHz
NFC	Data	13.56 MHz

FCC ID: A3LSMA356E	PART 2 RF EXPOSURE EVALUATION REPORT	Approved by: Technical Manager
Document S/N: 1M2310260110-21.A3L	DUT Type: Portable Handset	Page 3 of 66

1.2 Time-Averaging Algorithm for RF Exposure Compliance

This device is enabled with S.LSI TAS features. These features perform their proprietary time averaging algorithms in real time to control and manage transmitting power and ensure the time-average RF exposure is in compliance with FCC requirements at all times. Section 2.1 and 2.2 has additional details regarding the implementation of these TAS algorithms.

1.2.1 Time-Averaging Algorithm for Cellular RF Exposure Compliance

This process of S.LSI TAS validation is to demonstrate the DUT complies with FCC RF exposure compliance requirement under varying Tx power transmission scenarios, thus validating the Samsung S.LSI TAS algorithm feature for FCC equipment authorization of the mobile phone.

The value of P_{limit} used in this report per scenario is determined in Part 0 SAR Report.

FCC RF exposure limits are comprised of SAR (Specific Absorption Rate) limits depending on frequency of operation. SAR regulatory specifications are defined over certain measurement duration allowing for time-averaging. The Samsung S.LSI proprietary TAS (Time Average SAR) algorithm has been designed to meet the compliance limits over the required duration, while still allowing dynamic control of transmit power for meeting system performance.

1.3 Bibliography

Report Type	Report Serial Number
Part 0 SAR Test Report	1M2310260110-19.A3L
Part 1 SAR Test Report	1M2310260110-07.A3L
RF Exposure Compliance Summary	1M2310260110-08.A3L

FCC ID: A3LSMA356E	PART 2 RF EXPOSURE EVALUATION REPORT	Approved by: Technical Manager
Document S/N: 1M2310260110-21.A3L	DUT Type: Portable Handset	Page 4 of 66

2 RF EXPOSURE LIMITS

2.1 Uncontrolled Environment

UNCONTROLLED ENVIRONMENTS are defined as locations where there is the exposure of individuals who have no knowledge or control of their exposure. The general population/uncontrolled exposure limits are applicable to situations in which the general public may be exposed or in which persons who are exposed as a consequence of their employment may not be made fully aware of the potential for exposure or cannot exercise control over their exposure. Members of the general public would come under this category when exposure is not employment-related; for example, in the case of a wireless transmitter that exposes persons in its vicinity.

2.2 Controlled Environment

CONTROLLED ENVIRONMENTS are defined as locations where there is exposure that may be incurred by persons who are aware of the potential for exposure, (i.e. as a result of employment or occupation). In general, occupational/controlled exposure limits are applicable to situations in which persons are exposed as a consequence of their employment, who have been made fully aware of the potential for exposure and can exercise control over their exposure. This exposure category is also applicable when the exposure is of a transient nature due to incidental passage through a location where the exposure levels may be higher than the general population/uncontrolled limits, but the exposed person is fully aware of the potential for exposure and can exercise control over his or her exposure by leaving the area or by some other appropriate means

2.3 RF Exposure Limits for Frequencies Below 6 GHz

Table 2-1
SAR Human Exposure Specified in ANSI/IEEE C95.1-1992 and Health Canada Safety Code 6

HUMAN EXPOSURE LIMITS		
	UNCONTROLLED ENVIRONMENT <i>General Population</i> (W/kg) or (mW/g)	CONTROLLED ENVIRONMENT <i>Occupational</i> (W/kg) or (mW/g)
Peak Spatial Average SAR Head	1.6	8.0
Whole Body SAR	0.08	0.4
Peak Spatial Average SAR Hands, Feet, Ankle, Wrists, etc.	4.0	20

1. The Spatial Peak value of the SAR averaged over any 1 gram of tissue (defined as a tissue volume in the shape of a cube) and over the appropriate averaging time.
2. The Spatial Average value of the SAR averaged over the whole body.
3. The Spatial Peak value of the SAR averaged over any 10 grams of tissue (defined as a tissue volume in the shape of a cube) and over the appropriate averaging time.

FCC ID: A3LSMA356E	PART 2 RF EXPOSURE EVALUATION REPORT	Approved by: Technical Manager
Document S/N: 1M2310260110-21.A3L	DUT Type: Portable Handset	Page 5 of 66

2.4 Time Averaging Windows for FCC Compliance

Per October 2018 TCB Workshop Notes, the below time-averaging windows can be used for assessing time-averaged exposures for devices that are capable of actively monitoring and adjusting power output over time to comply with exposure limits.

Interim Guidance	Frequency (GHz)	Maximum Averaging Time (sec)
SAR	< 3	100
	3 – 6	60
MPE	6 - 10	30
	10 - 16	14
	16 – 24	8
	24 – 42	4
	42 – 95	2

FCC ID: A3LSMA356E	PART 2 RF EXPOSURE EVALUATION REPORT	Approved by: Technical Manager
Document S/N: 1M2310260110-21.A3L	DUT Type: Portable Handset	Page 6 of 66

3 S.LSI TAS OPERATION

3.1 Background

The RF exposure limit is defined based on time-average exposure during a certain amount of time window. Basically, the length of time window is adjustable in current TAS algorithm implementation. As representative values, following time window sizes are introduced in the report. Time window size 60 seconds are used for SAR SAR (0~6GHz). TAS algorithm ensures the DUT can meet the FCC compliance at all times over test duration. Samsung S.LSI proprietary TAS algorithm considers 4G and 5G NR cellular RAT because the DUT should keep the total amount of radiation below the level defined by regulations. To do this, modem controls transmitter power in real time.

At a very high level, the TAS algorithm consists of the following:

- Maximum Tx power limit for a particular RAT is calculated considering SAR compliance using some pre-characterization data.
- Instantaneous Tx power can go over Tx power limit but average value during any measurement window will be maintained below the Tx power limit.
- In a simultaneous multi-RAT scenario, TAS algorithm also has to meet TER (Total Exposure Ratio), which is sum of actual SAR to the compliance limits across all RATs. TER of the DUT will be equal to or less than 1 at all time.
- To preserve the radio link quality and call connection, TAS algorithm provides the concept of priority of each RAT's transmit power. For instance, a certain minimum value of max transmit power limit will be ensured for anchor RAT such as LTE in EN-DC.

3.2 Algorithm Operation

Samsung S.LSI proprietary TAS algorithm operates as follows:

- Define the minimum duration of SAR calculation. This duration is the 'SAR average window' consists of N slots. Any measurement duration or time-averaging duration as specified by FCC for the particular RAT will then consist of M such windows. The product of FCC limit of SAR limit (or equivalently the Tx power for this limit as used in the algorithm) and M is then defined as a SAR budget for such measurement durations.
- For a particular window, calculate the amount of average SAR consumed during the window duration by computing average of instantaneous transmit power value per slot. Because SAR value isn't given directly, Tx power value is used to calculate consumed SAR value.
- Estimates the total SAR consumed during the SAR measurement duration in the past which includes the above window. This value will be the sum of SAR consumed by all windows in the measurement duration.
- Monitor the remaining SAR budget continuously for every window and control the maximum Tx power for the next window to comply with SAR regulation

FCC ID: A3LSMA356E	PART 2 RF EXPOSURE EVALUATION REPORT	Approved by: Technical Manager
Document S/N: 1M2310260110-21.A3L	DUT Type: Portable Handset	Page 7 of 66

3.3 Configurable Parameters

To determine the parameters for the TAS algorithm operation, the terms in Table 3-1 was used.

**Table 3-1
Definitions for TAS algorithm**

Term	Description
P_{max}	Maximum Tx power that can be transmitted physically from RFIC for a given RAT
$SAR_{regulatory_limit}$	SAR value limit specified by FCC
SAR_{design_target}	Target SAR level using in TAS algorithm. This SAR value should be less than above regulatory limit and should be determined after accounting for all uncertainties and other design considerations.
P_{limit}	Power level corresponds to the SAR design target.

$$P_{limit} = P_{max} + 10 \times \log_{10}(SAR_{design_target}/SAR@P_{max})$$

For sub 6GHz and legacy modem, maximum Tx power (P_{max}) and allowable limit power (P_{limit}) has to be defined. The design target value should themselves be determined to ensure that DUT can comply with FCC SAR regulation limit even after accounting all device uncertainties. This is the bare minimum of design target value and additional offset can be considered to have more margin.

$$SAR_{design_target} = SAR_{regulatory_limit} \times 10^{-total_uncertainty_SAR/10}$$

**Table 3-1
Definitions of uncertainty and design target**

Term	Description
$SAR_{regulatory_limit}$	1.6 W/Kg (Body)
$total_uncertainty_SAR$	1.0 dB (Tx power variation, part to part deviation, etc.)
SAR_{design_target}	SAR_{design_target} should be less than 1.2 W/Kg Considering safety margin, 1.0 W/Kg is used as the value of SAR_{design_target}

FCC ID: A3LSMA356E	PART 2 RF EXPOSURE EVALUATION REPORT	Approved by: Technical Manager
Document S/N: 1M2310260110-21.A3L	DUT Type: Portable Handset	Page 8 of 66

4 TIME VARYING TRANSMISSION TEST CASES

4.1 Cellular S.LSI Time-Varying Transmission Cases

To validate the time averaging feature and demonstrate the compliance in Tx varying transmission conditions, the following transmission scenarios are covered in the Part 2 test:

1. During a time-varying Tx power transmission: To prove that the S.LSI TAS feature accounts for Tx power variations in time accurately.
2. During a call disconnect and re-establish scenario: To prove that the S.LSI TAS feature accounts for history of past Tx power transmissions accurately.
3. During a technology/band handover: To prove that the S.LSI TAS feature functions correctly during transitions in technology/band.
4. During an RSI (Radio SAR Index) change: To prove that the S.LSI TAS feature functions correctly during transition from one device state (RSI) to another.
5. During time averaging window change: To prove that the S.LSI TAS feature correctly handles the transition from one time window to another specified by FCC, and maintains the normalized time-averaged RF exposure to be less than normalized FCC limit of 1.0 at all times.

As described in SAR_Char.Report, the RF exposure is proportional to the Tx power for both FR1. Thus, we rely on conducted power measurements (FR1 in each dynamic case to demonstrate that overall RF exposure is within the FCC limit.

The overall procedure for validating the test is summarized below:

1. Measure conducted power (FR1) over time, denoted as $TxPower(t)$, with time index t .
2. Convert measured powers to RF exposure values using linear relationship shown below. In below expression, $P_{limit,FR1}$ would be the measured power at which FR1 technology meets measured SAR level of SAR_design_target as described in SAR_Char Report.

$$SAR(t) = \frac{TxPower(t)}{P_{limit,FR1}} \times SAR_design_target$$

Eqn. (1)

$$PD(t) = \frac{EIRP(t)}{P_{limit,FR2}} \times PD_design_target$$

Eqn. (2)

3. Compute the average RF exposure over the most recent measurement duration which are denoted as $TSAR$ and for FR1 and, respectively. These durations are as specific by FCC. This measurement duration interval is then given by $[t - TSAR, t]$ and for FR1.

FCC ID: A3LSMA356E	PART 2 RF EXPOSURE EVALUATION REPORT	Approved by: Technical Manager
Document S/N: 1M2310260110-21.A3L	DUT Type: Portable Handset	Page 9 of 66

4. Divide the RF exposure for FR1 by corresponding FCC limits and ensure the sum denoted as TER (total exposure ratio) is less than 1 for all t . Please refer to the following equations which describe the calculation of TER and its target restraint. The expressions below are general considering a number of FR1 and radios in general denoted by $LSAR$ and.

For sub6 transmission only:

$$\sum_{ISAR=0}^{LSAR-1} \frac{SAR_{avr, ISAR}}{FCC SAR} \leq 1$$

FCC ID: A3LSMA356E	PART 2 RF EXPOSURE EVALUATION REPORT	Approved by: Technical Manager
Document S/N: 1M2310260110-21.A3L	DUT Type: Portable Handset	Page 10 of 66

5 FCC MEASUREMENT PROCEDURES (FREQ < 6 GHZ)

This chapter provides the test plan and test procedure for validating S.LSI TAS and WLAN FastConnect features for sub-6 transmission. The 100 seconds time window for operating $f < 3\text{GHz}$ is used as an example to detail the test procedures in this chapter. The same test plan and test procedures described in this chapter apply to 60 second time window for operating $f \geq 3\text{GHz}$ and 30 second time-window for operating WLAN.

5.1 Test sequence determination for validation

Following the FCC recommendation, two test sequences having time-variation in Tx power are predefined for sub-6 ($f < 6\text{GHz}$) validation:

- Test sequence A is generated with two power levels. One is maximum power level P_{max} and the other is a lower power level. The lower power level is defined as 3dB lower than the maximum power level. T first, maximum power level is applied for 120 seconds ($1.2 * T_{\text{SAR}}$). After this, the lower power level is used until this test is finished.
- Test sequence B is generated at multiple power levels that are specified in the Appendix as a function of P_{max} and P_{limit} .

5.2 Test configuration selection criteria for validating Cellular S.LSI TAS feature

For validating the S.LSI TAS feature, this section provides the general guidance to select test cases.

5.2.1 Time-varying Tx power transmission

The Samsung S.LSI TAS algorithm is independent of bands, modes, and channels for a given technology. Hence, we can validate using one or two combinations of band/mode/channel per technology. The criteria for selecting these would be based on the relative value of P_{limit} and P_{max} as determined in SAR Char Report Char Report. Essentially, we need to pick the combination such that P_{limit} is less than P_{max} so that the TAS algorithm will enforce power restriction.

5.2.2 Change in call

The criteria to select the technology/band for transition between call setup and call drop is to choose the one with least P_{limit} among all supported technologies/bands. This test is performed with the DUT requested power at maximum power so the Samsung S.LSI TAS feature enforces power restriction for the longest duration. The call change is performed when the DUT is operating with restricted power. One such test is sufficient since behavior is not dependent on band/technology.

5.2.3 Change in technology/band/antenna

The criteria for selecting the test case to demonstrate compliance across tech, band, and antenna are to pick a technology/band corresponding to each tech, band, and antenna such that P_{limit} is less than P_{max} . However, to show the performance of the TAS algorithm in this document, the case of low P_{limit} is considered, which is shown in SAR Char Report Char Report.

5.2.1 Change in RSI

The criteria to select a test configuration for RSI change test is to select technology/band with two RSI states from SAR_Char Report such that P_{limit} is less than P_{max} for both states.

FCC ID: A3LSMA356E	PART 2 RF EXPOSURE EVALUATION REPORT	Approved by: Technical Manager
Document S/N: 1M2310260110-21.A3L	DUT Type: Portable Handset	Page 11 of 66

However, to show the performance of the TAS algorithm in this document, the case of lowest P_{limit} is considered, which is shown in Table 7-3.

5.2.1 SAR exposure switching

The criteria for selecting the test case is to pick an LTE band and an NR band with P_{limit} lower than P_{max} in each case. The test is performed with both RATs connected in an EN-DC scenario. In the first portion of the test, DUT is requested to transmit at maximum power for NR and minimum power for LTE. In the second portion of the test, maximum power is requested for both NR and LTE. In the final portion of the test, minimum power is requested for NR and maximum power is requested for LTE.

5.2.2 TAS to nonTAS

The criteria for selecting the test case to demonstrate compliance across TAS enable and disable are to pick a technology/band corresponding to each tech, band, and antenna such that P_{limit} is less than P_{max} . However, to show the performance of the TAS algorithm in this document, the case of low P_{limit} is considered, which is shown in SAR Char Report Char Report.

5.2.3 Uplink CA

The criteria for selecting this test case is to demonstrate the compliance of the TAS algorithm when an LTE transmission is done over multiple CC. This test shows that the TAS algorithm compliance is independent on the Transmission scenarios (single CC or CA).

5.2.4 Spatial TAS test

The criteria of selecting these tests configuration is to demonstrate the compliance of the TAS algorithm while transmitting on multiple antennas with a coupling factor of 0. This spatial TAS algorithm will show that we can achieve enhanced performance based on the antenna coupling while ensuring compliance with FCC target level.

5.3 Test procedures for validating Cellular S.LSI conducted power measurements

This section provides general conducted power measurement procedures to perform compliance test under dynamic transmission scenarios described in Section 3. In practice, an adjustment can be made in these procedures. The justification/clarification may be provided.

5.3.1 Time-varying Tx power transmission scenario

This test is performed with the two pre-defined test sequences described in Section 5.1 for all the technologies and bands applying to both LTE and NR selected in Section 5.2.1. The purpose of the test is to demonstrate the effectiveness of power limiting enforcement and that the time-averaged SAR (corresponding time-averaged Tx power) does not exceed the FCC limit at all times.

Test procedure

1. Using the P_{max} and P_{limit} obtained in Table 7-3, generate the test sequence of power levels for each selected technology/band. Both test sequences A and B are generated. Maximum power can be changed according to DUT test results.
2. Establish the connection of the DUT to the call box in the selected RAT, with the call box requesting the DUT Tx power to be according to the sequence determined in step 1. An initial value of Tx power will be set to 0dBm for 100s before the desired test sequence starts to help with post-processing of the time-average value with the very first value of the sequence. This is illustrated in the figure below:

FCC ID: A3LSMA356E	PART 2 RF EXPOSURE EVALUATION REPORT	Approved by: Technical Manager
Document S/N: 1M2310260110-21.A3L	DUT Type: Portable Handset	Page 12 of 66

3. Release connection.
4. After completion of the test, prepare one plot with the following information:
 - a. Instantaneous Tx power versus time measured in Step 2
 - b. Requested Tx power versus time used in Step 2
 - c. Time-averaged power over 100s using instantaneous values from Step 2
 - d. Power level P_{limit} which is determined as meeting SAR target in Table 8-1 (P_{max} P_{limit} Table)
5. Make another plot containing:
 - a. Computed time-averaged 1gSAR versus time determined in Step 2
 - b. FCC $1gSAR_{limit}$ of 1.6W/kg

The pass condition is to demonstrate time-averaged 1gSAR versus time shown in Step 5 value versus time does not exceed the FCC limit of 1.6 W/kg throughout the test duration. We would also demonstrate that time-averaged power does not exceed the P_{limit} at any time in the plot in Step 4.

5.3.2 Change in call scenario

This test is to demonstrate that Samsung S.LSI TAS feature accurately accounts for the past Tx powers during time-averaging when a new call is established. The call change has to be carried out when the power limit enforcement is ongoing.

Test procedure

1. Establish radio connection of the DUT with callbox in the selected technology/band.
2. Configure call box to set DUT Tx power to a low value of 0dBm for 100s.
3. Configure call box to send “ALL UP” power control commands and continue transmission from DUT so that maximum power P_{max} is achieved.
4. After 400s of transmission at P_{max} level, release the call from call box.
5. After 10s, re-establish the LTE connection from call box to the DUT and repeat sending “ALL UP” power control command to bring the Tx power to P_{max} level again.
6. Continue LTE transmission at P_{max} level for another 400s.
7. Release the LTE connection.
8. After completion of the test, make one plot containing: (a) instantaneous Tx power versus time, (b) requested power, (c) computed time-averaged power, (d) power level P_{limit} which is is determined as meeting the SAR target
9. Make another plot containing: (a) computed time-averaged 1gSAR versus time, and (b) FCC limit of 1.6 W/kg for 1gSAR.

Pass condition is to demonstrate time-averaged 1gSAR value versus time does not exceed the FCC limit of 1.6 W/kg throughout the test duration. It is required to check if SAR calculation is accounting for call drop and connection. Current TAS algorithm software makes the UE estimate the exact amount of Tx power and average SAR even during call drop and call re-establishment event. The UE stores time information when it goes into a sleep mode and wake-up to calculate Tx power on/off duration.

FCC ID: A3LSMA356E	PART 2 RF EXPOSURE EVALUATION REPORT	Approved by: Technical Manager
Document S/N: 1M2310260110-21.A3L	DUT Type: Portable Handset	Page 13 of 66

5.3.3 Change in technology/band/antenna

This test is to demonstrate that Samsung S.LSI TAS feature can properly handle change of technology/band. Since both P_{limit} can change across tech/band/antenna, we have to use separate equations below for converting Tx power to SAR as well as apply some combined SAR exposure criteria as shown below.

$$SAR_1(t) = \frac{TxPower_1(t)}{P_{limit,1,FR1}} * SAR_design_target_1$$

$$SAR_2(t) = \frac{TxPower_2(t)}{P_{limit,2,FR1}} * SAR_design_target_2$$

Where $P_{limit,1,FR1}$ would correspond to measured power at which first technology/band/antenna meets measured SAR level of $SAR_design_target_1$ as described in Table 7-3 with time-averaging duration of $T_{1,SAR}$. Similarly, the quantities $P_{limit,2,FR1}$, $SAR_design_target_2$, $T_{2,SAR}$ are defined for the second technology/band.

Test procedure

1. Establish radio connection of the DUT with callbox in the selected technology/band.
2. Configure call box to set DUT Tx power to a low value of 0dBm for 100s.
3. Configure call box to send "ALL UP" power control commands and continue transmission from DUT so that maximum power P_{max} is achieved. Continue transmission at the maximum power for at least 400s.
4. Change band from a tech/band/antenna A to another tech/band/antenna B. Continue call in band B with call box requesting maximum power for at least 400s.
5. Release LTE connection
6. After the completion of the test, prepare one plot with the following information for each band: (a) Instantaneous Tx power versus time (b) Time-averaged power for each band according to their averaging duration and (c) P_{limit} corresponding to each band.
7. Make a second plot containing the following information: (a) Computed time-averaged 1gSAR versus time for each band (b) Sum of time-averaged SAR computed according to below equations and (c) FCC 1gSAR limit of 1.6W/kg.

$$SAR_1(t) = \frac{TxPower_1(t)}{P_{limit,1,FR1}} * SAR_design_target_1$$

$$SAR_2(t) = \frac{TxPower_2(t)}{P_{limit,2,FR1}} * SAR_design_target_2$$

Pass condition is to demonstrate total time-averaged 1gSAR value versus time does not exceed the FCC limit of 1.6 W/kg throughout the test duration. It is required to check if power limiting enforcement is operated as expected when band change occurs in-between.

FCC ID: A3LSMA356E	PART 2 RF EXPOSURE EVALUATION REPORT	Approved by: Technical Manager
Document S/N: 1M2310260110-21.A3L	DUT Type: Portable Handset	Page 14 of 66

5.3.4 Change in RSI

Test procedure

1. Establish radio connection of the DUT with callbox in the selected technology/band.
2. Configure call box to set DUT Tx power to a low value of 0dBm for 100s.
3. Configure call box to send “ALL UP” power control commands and continue transmission from DUT so that maximum power Pmax is achieved. Continue transmission at the maximum power for at least 400s.
4. Change band from a tech/band/antenna A to another tech/band/antenna B. Continue call in band B with call box requesting maximum power for at least 400s.
5. Release LTE connection
6. After the completion of the test, prepare one plot with the following information for each band: (a) Instantaneous Tx power versus time (b) Time-average power for each band according to their averaging duration and (c) P_{limit} corresponding to each band.
7. Make a second plot containing the following information: (a) Computed time-averaged 1gSAR versus time for each band (b) Sum of time-averaged SAR computed according to below equations and (c) FCC 1gSAR limit of 1.6W/kg.

$$SAR_1(t) = \frac{TxPower_1(t)}{P_{limit,1,FR1}} * SAR_design_target_1$$

$$SAR_2(t) = \frac{TxPower_2(t)}{P_{limit,2,FR1}} * SAR_design_target_2$$

Pass condition is to demonstrate total time-averaged 1gSAR value versus time does not exceed the FCC limit of 1.6 W/kg throughout the test duration. It is required to check if power limiting enforcement is operated as expected when band change occurs in-between.

5.3.5 SAR exposure switching

This test is to demonstrate that Samsung S.LSI TAS feature can properly handle change of dominant SAR exposure radio in the case of two simultaneous active RATs. It involves changing the required power of both radios such that either one or both of the RATs becomes the dominant contributor to total exposure ratio at different times of the test.

Test procedure:

1. Establish LTE and NR radio connection in NSA case with the callbox.
2. Configure the LTE call box to send “ALL DOWN” power control commands for LTE and configure the NR call box to send “ALL UP” power control commands. This would correspond to NR dominant SAR scenario and continue this stage for about 220s.

FCC ID: A3LSMA356E	PART 2 RF EXPOSURE EVALUATION REPORT	Approved by: Technical Manager
Document S/N: 1M2310260110-21.A3L	DUT Type: Portable Handset	Page 15 of 66

3. In the second part of the test, configure the LTE call box to send “ALL UP” power control commands and all transmissions are continued, resulting in maximum power requested from DUT for both LTE and NR. This stage of the test is continued for another 110s.
4. In the third part of the test, configure the NR call box to send “ALL DOWN” power control commands so that LTE becomes the dominant SAR radio. This stage is continued for another 110s.
5. Finally, both LTE and NR connections are released.
6. After completion of the test, make one plot containing: (a) instantaneous Tx power versus time, (b) requested power, (c) computed time-averaged power, (d) power level P_{limit} which is determined as meeting the SAR target
7. Make another plot containing: (a) computed time-averaged 1gSAR versus time, and (b) FCC limit of 1.6 W/kg for 1gSAR.

Pass condition is to demonstrate total time-averaged 1gSAR value versus time does not exceed the FCC limit of 1.6 W/kg throughout the test duration. It is required to check if power limiting enforcement is operated as expected when band change occurs in-between.

5.3.6 TAS to nonTAS

Test procedure

1. Establish radio connection of the DUT with callbox in LTE connection.
2. Configure call box to set DUT Tx power to a low value of 0dBm for 100s.
3. Configure call box to send “ALL UP” power control commands and continue LTE transmission from DUT so that maximum power P_{max} is achieved. Continue transmission at the maximum power for at least 400s.
4. Change RAT from LTE to WCDMA while disabling TAS and configure call box to send “ALL UP” power control commands in WCDMA.
5. Continue call in WCDMA at maximum power for 400s.
6. Release WCDMA connection.
7. After the completion of the test, prepare one plot with the following information for each RAT (a) Instantaneous Tx power versus time (b) Time-averaged power for each RAT according to the averaging duration and (c) P_{limit} corresponding to each RAT.
8. Make a second plot containing the following information: (a) Computed time-averaged 1gSAR versus time for each band (b) Sum of time-averaged SAR computed according to below equations and (c) FCC 1gSAR limit of 1.6W/kg.

Pass condition is to demonstrate total time-averaged 1gSAR value versus time does not exceed the FCC limit of 1.6 W/kg throughout the test duration. It is required to check if power limiting enforcement is operated as expected when band change occurs in-between.

FCC ID: A3LSMA356E	PART 2 RF EXPOSURE EVALUATION REPORT	Approved by: Technical Manager
Document S/N: 1M2310260110-21.A3L	DUT Type: Portable Handset	Page 16 of 66

5.3.7 Uplink CA

The test is to demonstrate that Samsung S.LSI TAS feature can properly handle the SAR exposure for LTE with the addition and/or removal of another inter-band LTE CC.

Test procedure

1. Establish LTE connection of DUT with call box over Cell 1 E.g. one cell of the inter-band ULCA combo.
2. Configure the call box to send “ALL down” power control commands and continue this stage for about 110s.
3. Configure Call box to send “ALL UP” command for transmission on cell 1 and continue transmission for 110s.
4. Establish LTE connection of DUT with call box over Cell 2 E.g. other cell of the band inter-band ULCA combo.
5. Configure Call box to send “ALL UP” command for transmission on cell 2 and continue transmission for 110s.
6. Release LTE connection for both cells.
7. After completion of the test, make one plot containing: (a) instantaneous Tx power versus time, (b) requested power, (c) computed time-averaged power, (d) power level P_{limit} which is determined as meeting the SAR target
8. Make another plot containing: (a) computed time-averaged 1gSAR versus time, and (b) FCC limit of 1.6 W/kg for 1gSAR.

Pass condition is to demonstrate time-averaged 1gSAR value versus time does not exceed the FCC limit of 1.6 W/kg throughout the test duration.

5.3.8 Spatial TAS test

The criteria of selecting these tests configuration is to demonstrate the compliance of the TAS algorithm while transmitting on multiple antennas with a coupling factor of 0. This spatial TAS algorithm will show that we can achieve enhanced performance based on the antenna coupling while ensuring compliance with FCC target level.

5.3.5.1 Test procedure for LTE Antenna switching with spatial TAS

1. Establish radio connection of DUT with call box e.g. using LTE technology.
2. Configure call box to set DUT Tx power to a low value of 0dBm for 100s.
3. Configure call box to send “ALL UP” power control commands and continue transmission from DUT so that maximum power of P_{max} is achieved for 400s.
4. Change the bands so that the transmitting antenna changes from the first antenna group to the second antenna group and continue transmission for 400s.

FCC ID: A3LSMA356E	PART 2 RF EXPOSURE EVALUATION REPORT	Approved by: Technical Manager
Document S/N: 1M2310260110-21.A3L	DUT Type: Portable Handset	Page 17 of 66

5. Change the bands so that the transmitting antenna changes from the second antenna group to the first antenna group and continue transmission for 400s.
6. Release the LTE connection

5.3.5.2 Test procedure for NR FR1 Antenna switching with spatial TAS

1. Establish radio connection of DUT with call box e.g. using NR FR1 technology.
2. Configure call box to set DUT Tx power to a low value of 0dBm for 100s.
3. Configure call box to send “ALL UP” power control commands and continue transmission from DUT so that maximum power of Pmax is achieved for 400s.
4. Change the bands so that the transmitting antenna changes from the first antenna group to the second antenna group and continue transmission for 400s.
5. Change the bands so that the transmitting antenna changes from the second antenna group to the first antenna group and continue transmission for 400s.
6. Release the NR FR1 connection.

5.3.5.3 Test procedure for NSA with spatial TAS

1. Establish LTE and NR radio connection in NSA case with both call boxes, where LTE and NR are in different antenna groups.
2. Configure the LTE call box to send “ALL Down” power control commands for LTE and configure the NR call box to send “ALL Down” power control commands and continue for 150s.
3. Configure the LTE call box to send “ALL Up” power control commands for LTE while keeping the configuration of the NR call box at “ALL Down” power control commands. This would correspond to LTE dominant SAR scenario and continue this stage for about 150s.
4. Configure the NR call box to send “ALL UP” power control commands and all transmissions are continued, resulting in maximum power requested from DUT for both LTE and NR. This stage of test is continued for another 150s.
5. Configure the LTE call box to send “ALL DOWN” power control commands so that NR becomes the dominant SAR radio and continue transmission till the end of the test.
6. Finally, both LTE and NR connections are released.

5.3.5.4 Test procedure for NSA antenna switching with spatial TAS

1. Establish LTE and NR radio connection in NSA case with both call boxes.

FCC ID: A3LSMA356E	PART 2 RF EXPOSURE EVALUATION REPORT	Approved by: Technical Manager
Document S/N: 1M2310260110-21.A3L	DUT Type: Portable Handset	Page 18 of 66

2. Configure the LTE call box to send “ALL Down” power control commands for LTE and configure the NR call box to send “ALL Down” power control commands and continue for 150s.
3. Configure the LTE call box to send “ALL Up” power control commands for LTE while keeping the configuration of the NR call box at “ALL Down” power control commands. This would correspond to LTE dominant SAR scenario and continue this stage for about 150s.
4. Configure the NR call box to send “ALL UP” power control commands and all transmissions are continued, resulting in maximum power requested from DUT for both LTE and NR. This stage of test is continued for another 150s.
5. Change the NR FR1 band so that the transmitting antenna changes from the first antenna group to the second antenna group and continue transmission at “ALL UP” Tx power for 150s.
6. Configure the LTE call box to send “ALL DOWN” power control commands so that NR becomes the dominant SAR radio and continue transmission for 150s.
7. Release LTE connection

FCC ID: A3LSMA356E	PART 2 RF EXPOSURE EVALUATION REPORT	Approved by: Technical Manager
Document S/N: 1M2310260110-21.A3L	DUT Type: Portable Handset	Page 19 of 66

6 MEASUREMENT TEST SETUP (FREQ < 6 GHZ)

6.1 Cellular Conducted Measurement Test Setup

Legacy test setup

The Rohde & Schwarz CMW500 callbox was used in this test. The test setup schematic is shown in Figure 6-1a (Appendix A – Test Setup Photo 1) for measurements with a single antenna of DUT, and in Figure 6-1b (Appendix A – Test Setup Photo 3 and 5) for measurements involving antenna switch. For single antenna measurement, one port (RF1 COM) of the callbox is connected to the RF port of the DUT using a directional coupler. For technology/band switch measurement, one port (RF1 COM) of the callbox used for signaling two different technologies is connected to a combiner, which is in turn connected to a directional coupler. The other end of the directional coupler is connected to a splitter to connect to two RF ports of the DUT corresponding to the two antennas of interest. In the setups, a power meter is used to tap the directional coupler for measuring the conducted output power of the DUT. For all legacy conducted tests, only RF1 COM port of the callbox is used to communicate with the DUT.

All the path losses from RF port of DUT to the callbox RF COM port and to the power meter are calibrated and automatically entered as offsets in the callbox and the power meter via test scripts on the PC used to control callbox and power meter.

Sub6 NR test setup:

The Anritsu MT8000A callbox was used in this test. The test setup schematic is the same as the Legacy Test Setup shown in Figure 6-1a (Appendix A – Test Setup Photo 2) and Figure 6-1b (Appendix A – Test Setup Photo 6). One port of the callbox is connected to the RF port of the DUT using a directional coupler. In the setup, the power meter is used to tap the directional coupler for measuring the conducted output power of the DUT.

All the path losses from RF port of DUT to the callbox RF COM port and to the power meter are calibrated and automatically entered as offsets in the callbox and the power meter via test scripts on the PC used to control callbox and power meter.

LTE+Sub6 NR test setup:

LTE conducted port and Sub6 NR conducted port are different on this EUT, therefore, the LTE and NR FR1 signals for power meter measurement are performed on separate paths as shown below in Figure 6-1d (Appendix A – Test Setup Photo 4 and 7).

For NSA antenna switching with spatial TAS, LTE conducted port and two NR FR1 conducted ports are different on this EUT, therefore, the LTE and NR FR1 signals for power meter measurement are performed on separate paths with a splitter as shown below in Figure 6-1d (Appendix A – Test Setup Photo 8).

All the path losses from RF port of DUT to the callbox RF COM port and to the power meter are calibrated and automatically entered as offsets in the callbox and the power meter via test scripts on the PC used to control callbox and power meter.

FCC ID: A3LSMA356E	PART 2 RF EXPOSURE EVALUATION REPORT	Approved by: Technical Manager
Document S/N: 1M2310260110-21.A3L	DUT Type: Portable Handset	Page 20 of 66

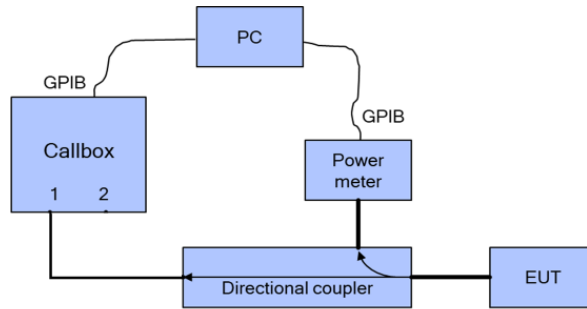

(a) Appendix A – Test Setup Photo 1, 2

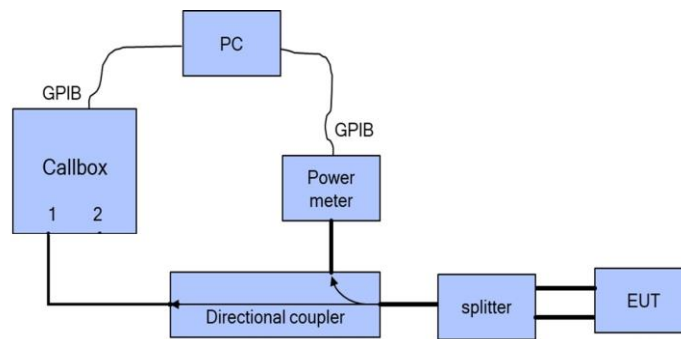

(b) Appendix A – Test Setup Photo 3, 5, 6

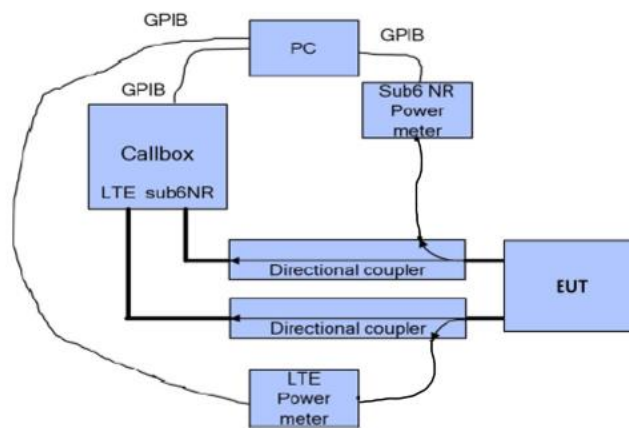

(c) Appendix A – Test Setup Photo 4, 7

FCC ID: A3LSMA356E	PART 2 RF EXPOSURE EVALUATION REPORT	Approved by: Technical Manager
Document S/N: 1M2310260110-21.A3L	DUT Type: Portable Handset	Page 21 of 66

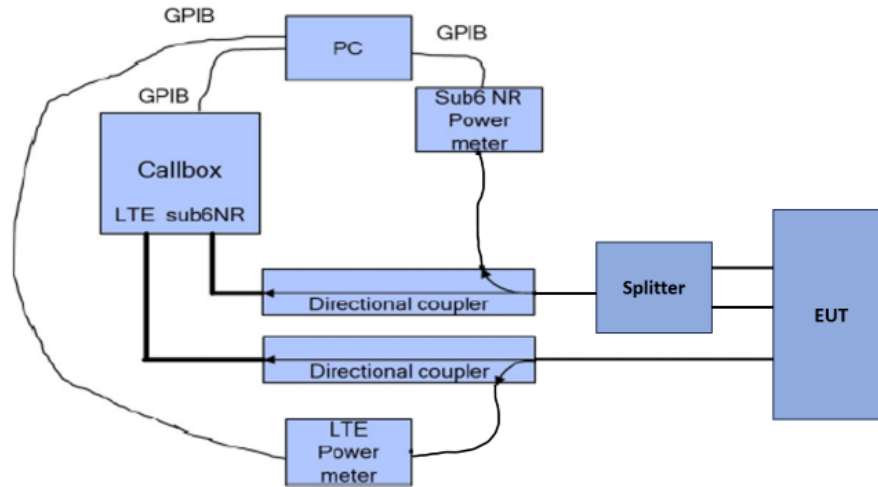

(d) Appendix A – Test Setup Photo 8

**Figure 6-1
Conducted power measurement setup**

Both the callbox and power meter are connected to the PC using GPIB cables. Two test scripts are custom made for automation, and the test duration set in the test scripts is 500 seconds.

For time-varying Tx power measurement, the PC runs the 1st test script to send GPIB commands to control the callbox’s requested power versus time, while at the same time to record the conducted power measured at DUT RF port using the power meter. The commands sent to the callbox to request power are:

- 0dBm for 100 seconds
- test sequence A or test sequence B (defined in Section 4.1 and generated in Section 4.2.1), for 360 seconds.
- stay at the last power level of test sequence 1 or test sequence 2 for the remaining time.

Power meter readings are periodically recorded every 100ms. A running average of this measured Tx power over 100 seconds is performed in the post-data processing to determine the 60s-time averaged power.

For call drop, technology/band/antenna switch, and RSI switch tests, after the call is established, the callbox is set to request the DUT’s Tx power at 0dBm for 100 seconds while simultaneously starting the 2nd test script runs at the same time to start recording the Tx power measured at DUT RF port using the power meter. After the initial 100 seconds since starting the Tx power recording, the callbox is set to request maximum power from the DUT for the rest of the test. Note that the call drop/re-establish, or technology/band/antenna switch or RSI switch is manually performed when the Tx power of DUT is at $P_{reserve}$ level. See Section 4.3 for detailed test procedure of call drop test, technology/band/antenna switch test and RSI switch test.

FCC ID: A3LSMA356E	PART 2 RF EXPOSURE EVALUATION REPORT	Approved by: Technical Manager
Document S/N: 1M2310260110-21.A3L	DUT Type: Portable Handset	Page 22 of 66

7 TEST CONFIGURATIONS (FREQ < 6 GHZ)

7.1 WWAN (sub-6) transmission

The P_{limit} values, corresponding to 1.0 W/kg (1gSAR) and 2.0 W/kg (10gSAR) of SAR_{design_target} , for technologies and bands supported by DUT are derived in Part 0 report and summarized in Table 7-1. Note all P_{limit} power levels entered in Table 7-1 correspond to average power levels after accounting for duty cycle in the case of TDD modulation schemes.

Table 7-1
 P_{limit} for supported technologies and bands (P_{limit} in EFS file)

Exposure Scenario			Maximum Tune-Up Output Power*	Free (Body-Worn, Hotspot, or Phablet)	Head
Averaging Volume				1g/10g	1g
Spacing				10mm, 0mm	0mm
Configuration					
RSI				0	4
Technology/Band	Antenna	Antenna Group	Pmax		
GSM 850	A	AG1	24.3	27.6	31.7
GSM 1900	B	AG1	22.6	19.0	32.4
UMTS 850	A	AG1	24.0	27.3	30.9
UMTS 1750	B	AG1	23.0	20.0	29.9
UMTS 1900	B	AG1	23.0	20.0	30.4
LTE Band 12/17	A	AG1	24.5	27.9	31.9
LTE Band 13	A	AG1	24.5	28.1	31.7
LTE Band 26/5	A	AG1	24.5	28.1	32.3
LTE Band 66/4	B	AG1	23.0	18.5	31.5
LTE Band 66/4	F	AG2	22.5	18.5	18.5
LTE Band 25/2	B	AG1	23.0	18.5	31.3
LTE Band 25/2	F	AG2	22.5	18.5	18.5
LTE Band 41	B	AG1	22.0	17.5	33.8
LTE Band 41	F	AG2	20.0	17.5	17.5
NR Band n5	A	AG1	24.5	27.5	31.7
NR Band n66	B	AG1	23.0	18.5	31.3
NR Band n66	F	AG2	22.5	18.5	18.5
NR Band n41 PC3	B	AG1	24.0	16.5	33.6
NR Band n41 PC3	F	AG2	19.0	16.5	16.5
NR Band n41 PC3	I	AG2	21.0	20.0	20.0
NR Band n41 PC3	E	AG2	21.0	19.0	19.0
NR Band n77 PC3	G	AG2	24.0	16.5	15.5
NR Band n77 PC2	G	AG2	25.0	16.5	15.5

FCC ID: A3LSMA356E	PART 2 RF EXPOSURE EVALUATION REPORT	Approved by: Technical Manager
Document S/N: 1M2310260110-21.A3L	DUT Type: Portable Handset	Page 23 of 66

* Maximum tune up target power, P_{max} , is configured in DUT to limit maximum transmitting power. This power is converted into peak power for TDD schemes. The DUT maximum allowed output power is equal to $P_{max} + 1$ dB device uncertainty.

Based on selection criteria described in Section 5.2, the selected technologies/bands for testing time-varying test sequences are highlighted in yellow in Table 7-1.

The radio configurations used in Part 2 test for selected technologies, bands, RSIs and antennas are listed in Table 7-2. The corresponding worst-case radio configuration 1gSAR values for selected technology/band/RSI are extracted from Part 1 report and are listed in Table 7-2.

It is clear that Part 2 testing outcome is normalized quantity, which implies that it can be applied to any radio configuration within a selected technology/band/RSI. Therefore, there may be some differences between the radio configuration selected for Part 2 testing and the radio configuration associated with worst-case SAR obtained in the Part 1 evaluation.

The measured P_{limit} for all the selected radio configurations is listed below Table 7-2. P_{max} was also measured for radio configurations selected for testing time-varying Tx power transmission scenarios in order to generate test sequences following the test procedures in Section 4.1 and Section 5.1.

FCC ID: A3LSMA356E	PART 2 RF EXPOSURE EVALUATION REPORT	Approved by: Technical Manager
Document S/N: 1M2310260110-21.A3L	DUT Type: Portable Handset	Page 24 of 66

Table 7-2
Radio configurations selected for Part 2 test

Test Case #	Test Scenario	Tech	Band	Antenna	Antenna Group	RSI	Channel	Frequency [MHz]	Test Configurations	SAR Exposure Scenario	Part 1 Worst Case Measured SAR at Plimit (W/kg)	EFS Plimit [dBm]	Tune-up Pmax [dBm]	Measured Plimit [dBm]	Measured Pmax [dBm]
1	Test Sequence A	GSM	1900	B	AG1	0	661	1880	GPRS 4Tx Slots	Back Side, 10mm	0.272	19.0	22.3	18.53	22.14
	Test Sequence B														
2	Test Sequence A	WCDMA	4	B	AG1	0	1312	1712.4	RMC	Bottom Edge, 10mm	0.252	20.0	23.0	19.15	22.55
	Test Sequence B														
3	Test Sequence A	WCDMA	2	B	AG1	0	9262	1852.4	RMC	Back Side, 10mm	0.295	20.0	23.0	19.49	23.10
	Test Sequence B														
4	Test Sequence A	LTE	66	B	AG1	0	132322	1745	QPSK 1/50/20 MHz BW	Bottom Edge, 10mm	0.198	18.5	23.0	17.91	22.75
	Test Sequence B														
5	Test Sequence A	LTE	41 PC3	B	AG1	0	40620	2593	QPSK 1/50/20 MHz BW	Bottom Edge, 10mm	0.119	17.5	22.0	17.68	22.25
	Test Sequence B														
6	Test Sequence A	NR	n66 NSA	B	AG1	0	349000	1745	DFT-s-OFDM, QPSK 1/1/40 MHz BW	Bottom Edge, 10mm	0.267	18.5	23.0	18.23	23.03
	Test Sequence B														
7	Test Sequence A	NR	n41 PC3	B	AG1	0	518598	2593	DFT-s-OFDM, QPSK 1/138/100 MHz BW	Back Side, 10mm	0.089	16.5	24.0	16.27	23.27
	Test Sequence B														
8	Change in Call	NR	n41 PC3	B	AG1	0	518598	2593	DFT-s-OFDM, QPSK 1/138/100 MHz BW	Back Side, 10mm	0.089	16.5	24.0	16.27	23.27
9	Change in Technology / Band / Reselection	LTE	66	B	AG1	0	132322	1745	QPSK 1/50/20 MHz BW	Bottom Edge, 10mm	0.198	18.5	23.0	17.91	22.75
		WCDMA	2	B	AG1	0	9262	1852.4	RMC	Back Side, 10mm	0.295	20.0	23.0	19.49	23.10
10	Change in Antenna	LTE	5	A	AG1	0	20525	836.5	QPSK 1/25/10 MHz BW	Back Side, 10mm	0.409	28.1	24.5	24.78	24.78
			66	B	AG1	0	132322	1745	QPSK 1/50/20 MHz BW	Bottom Edge, 10mm	0.198	18.5	23.0	17.91	22.75
11	Change in Radio SAR Index (RSI)	LTE	25	B	AG1	0	26365	1882.5	QPSK 1/50/20 MHz BW	Bottom Edge, 10mm	0.219	18.5	23.0	18.21	23.02
						4				Left, Cheek	0.147	32.3	23.0	23.02	23.02
12	SAR Exposure Switching EN-DC	LTE	5	A	AG1	0	20525	836.5	QPSK 1/25/10 MHz BW	Back Side, 10mm	0.409	28.1	24.5	24.78	24.78
		Sub6 NR	n66 NSA	B	AG1	0	349000	1745	DFT-s-OFDM, QPSK 1/1/40 MHz BW	Bottom Edge, 10mm	0.267	18.5	23.0	18.23	23.03
13	TAS to nonTAS H.O	LTE	66	B	AG1	0	132322	1745	QPSK 1/50/20 MHz BW	Bottom Edge, 10mm	0.198	18.5	23.0	17.91	22.75
		WCDMA	4	B	AG1	4	1312	1712.4	RMC	Right, Cheek	0.179	29.9	23.0	22.55	22.55
14	LTE ULCA	LTE	66	B	AG1	0	132322	1745	QPSK 1/50/20 MHz BW	Bottom Edge, 10mm	0.198	18.5	23.0	17.91	22.75
			5	A	AG1	0	20525	836.5	QPSK 1/25/10 MHz BW	Back Side, 10mm	0.409	28.1	24.5	24.78	24.78
15	LTE Antenna Switching with Spatial TAS	LTE	25	B	AG1	0	26365	1882.5	QPSK 1/50/20 MHz BW	Bottom Edge, 10mm	0.219	18.5	23.0	18.21	23.02
			66	F	AG2	0	132322	1745	QPSK 1/50/20 MHz BW	Right, Tilt	0.418	18.5	22.5	18.07	22.22
16	FR1 SA Antenna Switching with Spatial TAS	NR	n41 PC3	B	AG1	0	518598	2593	DFT-s-OFDM, QPSK 1/138/100 MHz BW	Back Side, 10mm	0.089	16.5	24.0	16.27	23.27
			n77 PC3	G	AG2	0	650000	3750	DFT-s-OFDM, QPSK 1/138/100 MHz BW	Left Edge, 10mm	0.614	16.5	24.0	16.59	24.08
17	NSA with Spatial TAS	LTE	66	B	AG1	0	132322	1745	QPSK 1/50/20 MHz BW	Bottom Edge, 10mm	0.198	18.5	23.0	17.91	22.75
		Sub6 NR NSA	n77 PC3	G	AG2	0	650000	3750	DFT-s-OFDM, QPSK 1/138/100 MHz BW	Left Edge, 10mm	0.614	16.5	24.0	16.59	24.08
18	NSA Antenna Switching with Spatial TAS	LTE	12	A	AG1	0	23094	707.5	QPSK 1/0/10 MHz BW	Right Edge, 10mm	0.309	27.9	24.5	24.75	24.75
		Sub6 NR NSA	n41 PC3	B	AG1	0	518598	2593	DFT-s-OFDM, QPSK 1/138/100 MHz BW	Back Side, 10mm	0.089	16.5	24.0	16.27	23.27
		Sub6 NR NSA	n77	G	AG2	0	650000	3750	DFT-s-OFDM, QPSK 1/138/100 MHz BW	Left Edge, 10mm	0.614	16.5	24.0	16.59	24.08

Note: The above P_{max}, P_{lim} values for GPRS1900 are for 4 Tx Slots.

FCC ID: A3LSMA356E	PART 2 RF EXPOSURE EVALUATION REPORT	Approved by: Technical Manager
Document S/N: 1M2310260110-21.A3L	DUT Type: Portable Handset	Page 25 of 66

**Table 7-3
RSI and Corresponding Exposure Scenarios**

Scenario	Description	SAR Test Cases
Head (RSI =4)	<ul style="list-style-type: none"> ▪ RSI = RCV ▪ Device positioned next to head ▪ Receiver Active 	<i>Head SAR per KDB Publication 648474 D04</i>
Hotspot mode (RSI =3)	<ul style="list-style-type: none"> ▪ RSI = Hotspot ▪ Device transmits in hotspot mode near body ▪ Hotspot Mode Active 	<i>Hotspot SAR per KDB Publication 941225 D06</i>
Phablet (RSI = 0)	<ul style="list-style-type: none"> ▪ RSI = Free ▪ Device is held with hand 	<i>Phablet SAR per KDB Publication 648474 D04 & KDB Publication 616217 D04</i>
Body-worn (RSI = 0)	<ul style="list-style-type: none"> ▪ RSI = Free ▪ Device being used with a body-worn accessory 	<i>Body-worn SAR per KDB Publication 648474 D04</i>

Based on the selection criteria described in Section 6.2 and Section 6.4, the radio configurations for the Tx varying transmission test cases listed in Section 3 are:

1. Technologies and bands for time-varying Tx power transmission: The test case 1~7 listed in Table 7-3 are selected to test with the test sequences defined in Section 4.1 and Section 5.1 in time-varying conducted power measurement.
2. Technology and band for change in call test: NR n41, antenna B having the lowest P_{limit} among all technologies and bands (test case 8 in Table 7-3), is selected for performing the call drop test in conducted power setup.
3. Technologies and bands for change in technology/band test: Test case 9 in Table 7-3 is selected for handover test from a technology/band (LTE Band 66, ant B), to a technology/band in the same RSI within another technology group (WCDMA Band 2, ant B) in conducted power setup.
4. Technologies and bands for change in antenna: For a given RSI, test case 10 in Table 7-3 is selected for antenna switch between antenna A (LTE Band 5) and antenna B (LTE Band 66) in conducted power setup.
5. Technologies and bands for change in RSI: Test case 11 in Table 7-3 is selected for change from a RSI to another RSI within the same technology/band/antenna (LTE Band 25, ant B, RSI = 0 to LTE Band 66, ant B, RSI = 4) in the in conducted power setup.
6. Technologies and bands for switch in SAR exposure: Test case 12 in Table 7-3 is selected for SAR exposure switching test in one of the supported simultaneous WWAN transmission scenario, i.e., LTE + Sub6 NR active in conducted power setup.
7. Technologies and bands for TAS to nonTAS switching: For a given RSI, test case 13 in Table 7-3 is selected for a switch between LTE Band 66, antenna B, TAS ON to WCDMA Band 4, antenna B, TAS OFF in conducted power setup
8. Technologies and bands for LTE ULCA: For a given RSI, test case 14 in Table 7-3 is selected for LTE ULCA in conducted power setup.

FCC ID: A3LSMA356E	PART 2 RF EXPOSURE EVALUATION REPORT	Approved by: Technical Manager
Document S/N: 1M2310260110-21.A3L	DUT Type: Portable Handset	Page 26 of 66

9. Technologies and bands for Spatial TAS: Test case 15, 16, 17, and 18 in Table 7-3 are selected for SAR exposure switching with spatial TAS. Four antennas (A, B, F, G) with two antenna groups (AG1, AG2) are considered where each antenna group consists of one/multiple antenna and one/multiple bands.

Note: Test cases #9 - #14 were done with modes/bands within the same antenna group.

Note: This device only supports 60s time window for all frequencies. Thus, a change in time window is not required.

FCC ID: A3LSMA356E	PART 2 RF EXPOSURE EVALUATION REPORT	Approved by: Technical Manager
Document S/N: 1M2310260110-21.A3L	DUT Type: Portable Handset	Page 27 of 66

8 CONDUCTED TX CASES (FREQ < 6 GHZ)

8.1 Time-varying Tx Power Case

Following the test procedure in Section 5.3.1, the conducted Tx power measurement results for all selected test cases are listed in this section. In all conducted Tx power plots, the blue line shows the measured instantaneous power using the power meter, the red line shows the time-averaged Tx power and the yellow line shows the P_{limit} value corresponding to the design target. In all SAR plots, the dotted blue line shows the time-averaged 1g SAR while the red line shows the corresponding FCC limit of 1.6 W/kg.

Time-varying Tx power measurements were conducted on test cases #1 ~ #7 in Table 7-3, by generating test sequence A and test sequence B given in APPENDIX B: using measured P_{limit} and measured P_{max} (last two columns of Table 7-3) for each of these test cases. Measurement results for test cases #1 ~ #7 are given in Sections 8.1.1-8.1.7.

FCC ID: A3LSMA356E	PART 2 RF EXPOSURE EVALUATION REPORT	Approved by: Technical Manager
Document S/N: 1M2310260110-21.A3L	DUT Type: Portable Handset	Page 28 of 66

8.1.1 GPRS Band 1900, Ant B

Test result for test sequence A:

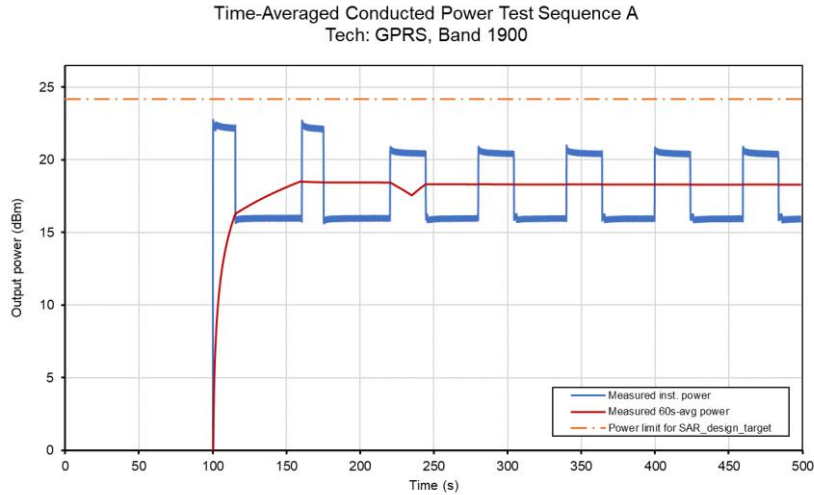

Time-averaged conducted Tx power is converted/calculated into time-averaged 1gSAR and is plotted below to demonstrate that the time-averaged 1gSAR versus time does not exceed the FCC limit of 1.6 W/kg for 1gSAR:

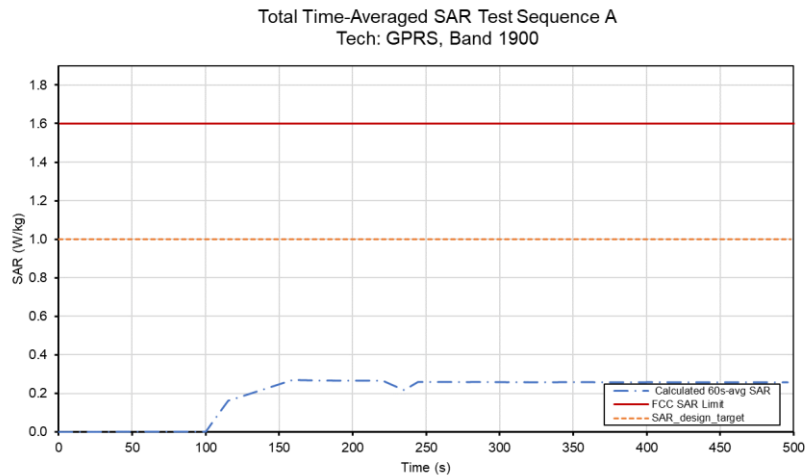

	(W/kg)
FCC 1gSAR limit	1.6
Max 60s-time averaged 1gSAR (blue curve)	0.272
Validated: Max time averaged SAR (blue curve) is within 1 dB device uncertainty of measured SAR at P_{limit} (worst case SAR column in Table 7-3).	

FCC ID: A3LSMA356E	PART 2 RF EXPOSURE EVALUATION REPORT	Approved by: Technical Manager
Document S/N: 1M2310260110-21.A3L	DUT Type: Portable Handset	Page 29 of 66

Test result for test sequence B:

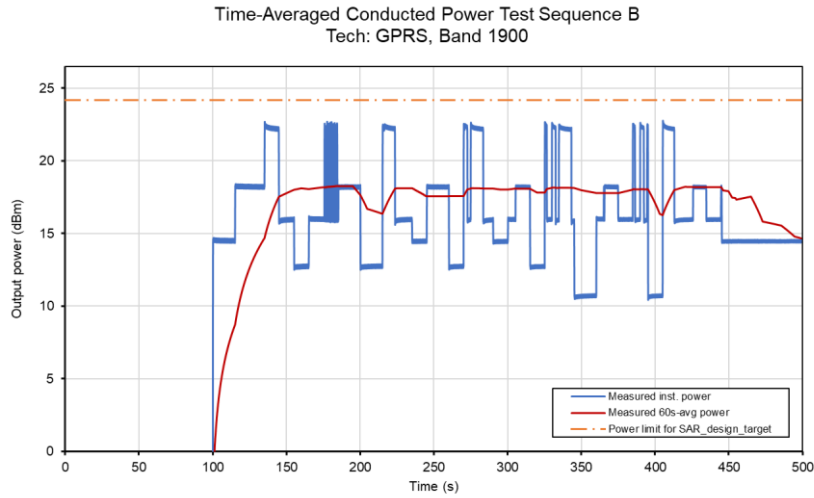

Time-averaged conducted Tx power is converted/calculated into time-averaged 1gSAR and is plotted below to demonstrate that the time-averaged 1gSAR versus time does not exceed the FCC limit of 1.6 W/kg for 1gSAR:

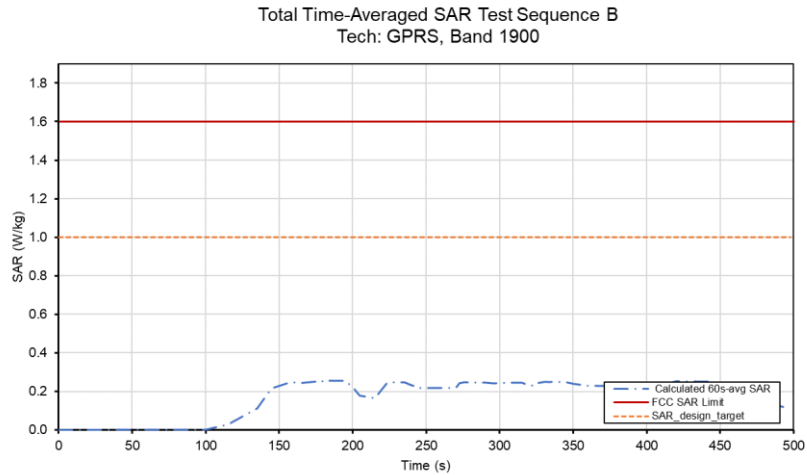

	(W/kg)
FCC 1gSAR limit	1.6
Max 60s-time averaged 1gSAR (blue curve)	0.257
Validated: Max time averaged SAR (blue curve) is within 1 dB device uncertainty of measured SAR at P_{limit} (worst case SAR column in Table 7-3).	

FCC ID: A3LSMA356E	PART 2 RF EXPOSURE EVALUATION REPORT	Approved by: Technical Manager
Document S/N: 1M2310260110-21.A3L	DUT Type: Portable Handset	Page 30 of 66

8.1.2 WCDMA Band 4, Ant B

Test result for test sequence A:

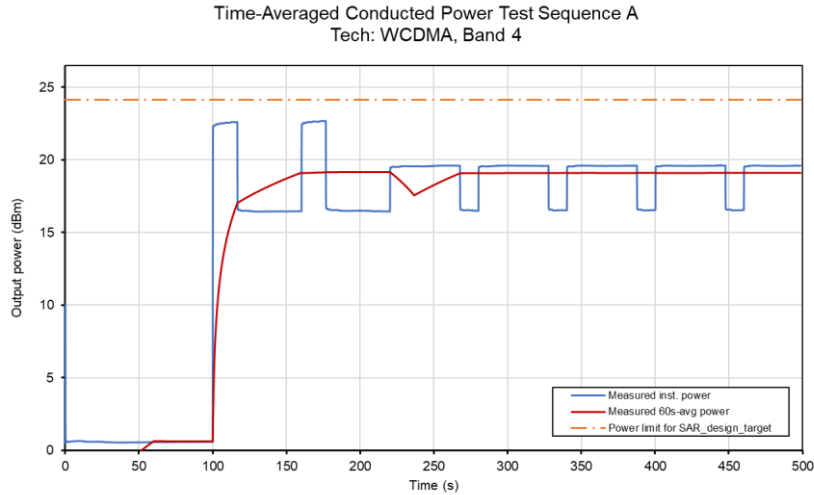

Time-averaged conducted Tx power is converted/calculated into time-averaged 1gSAR and is plotted below to demonstrate that the time-averaged 1gSAR versus time does not exceed the FCC limit of 1.6 W/kg for 1gSAR:

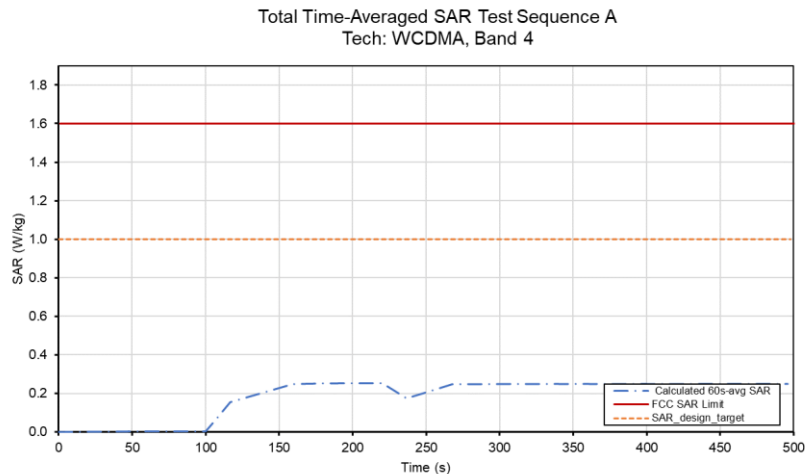

	(W/kg)
FCC 1gSAR limit	1.6
Max 60s-time averaged 1gSAR (blue curve)	0.253
Validated: Max time averaged SAR (blue curve) is within 1 dB device uncertainty of measured SAR at P_{limit} (worst case SAR column in Table 7-3).	

FCC ID: A3LSMA356E	PART 2 RF EXPOSURE EVALUATION REPORT	Approved by: Technical Manager
Document S/N: 1M2310260110-21.A3L	DUT Type: Portable Handset	Page 31 of 66

Test result for test sequence B:

Time-Averaged Conducted Power Test Sequence B
Tech: WCDMA, Band 4

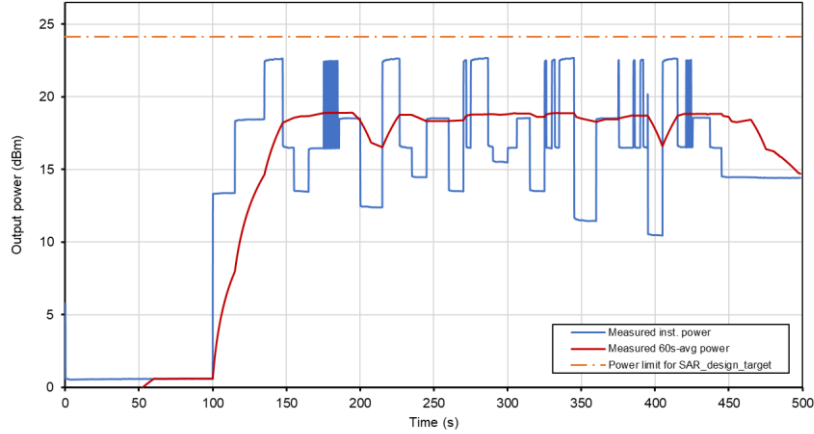

Time-averaged conducted Tx power is converted/calculated into time-averaged 1gSAR and is plotted below to demonstrate that the time-averaged 1gSAR versus time does not exceed the FCC limit of 1.6 W/kg for 1gSAR:

Total Time-Averaged SAR Test Sequence B
Tech: WCDMA, Band 4

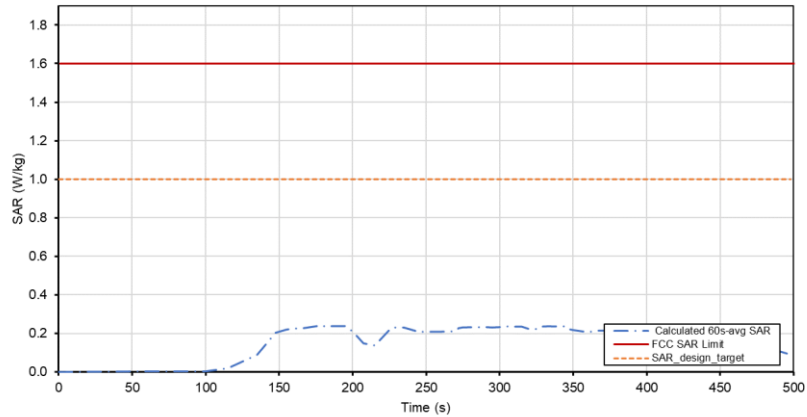

	(W/kg)
FCC 1gSAR limit	1.6
Max 60s-time averaged 1gSAR (blue curve)	0.239
Validated: Max time averaged SAR (blue curve) is within 1 dB device uncertainty of measured SAR at P_{limit} (worst case SAR column in Table 7-3).	

FCC ID: A3LSMA356E	PART 2 RF EXPOSURE EVALUATION REPORT	Approved by: Technical Manager
Document S/N: 1M2310260110-21.A3L	DUT Type: Portable Handset	Page 32 of 66

8.1.3 WCDMA Band 2, Ant B

Test result for test sequence A:

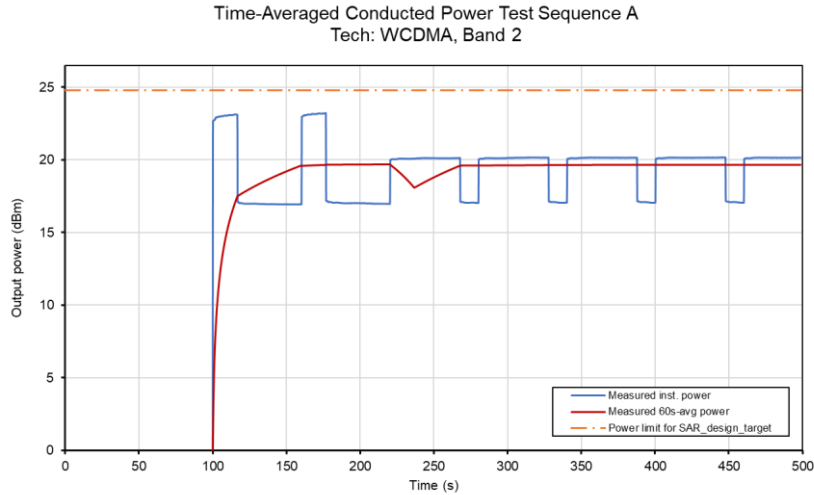

Time-averaged conducted Tx power is converted/calculated into time-averaged 1gSAR and is plotted below to demonstrate that the time-averaged 1gSAR versus time does not exceed the FCC limit of 1.6 W/kg for 1gSAR:

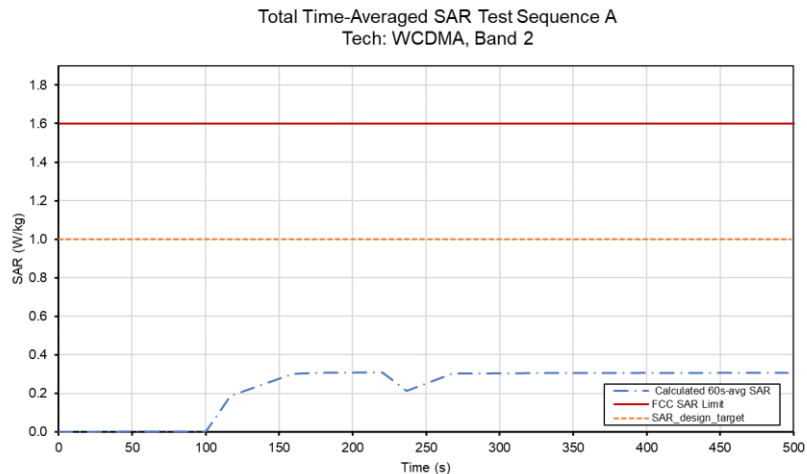

	(W/kg)
FCC 1gSAR limit	1.6
Max 60s-time averaged 1gSAR (blue curve)	0.309
Validated: Max time averaged SAR (blue curve) is within 1 dB device uncertainty of measured SAR at P_{limit} (worst case SAR column in Table 7-3).	

FCC ID: A3LSMA356E	PART 2 RF EXPOSURE EVALUATION REPORT	Approved by: Technical Manager
Document S/N: 1M2310260110-21.A3L	DUT Type: Portable Handset	Page 33 of 66

Test result for test sequence B:

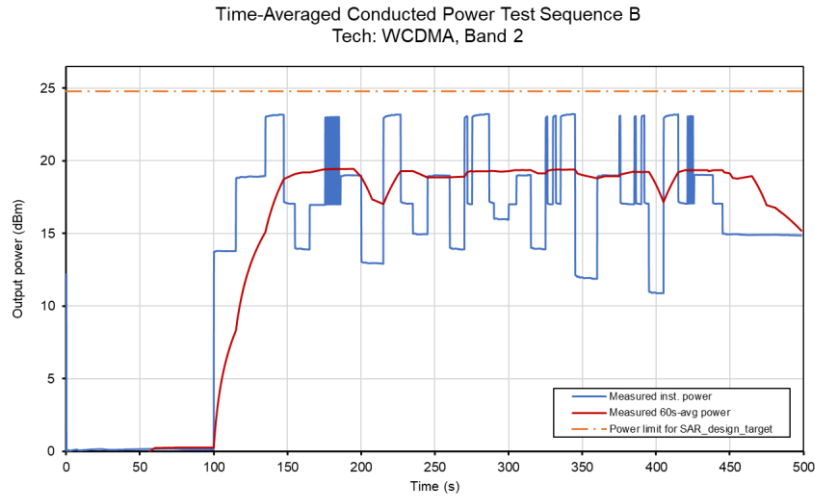

Time-averaged conducted Tx power is converted/calculated into time-averaged 1gSAR and is plotted below to demonstrate that the time-averaged 1gSAR versus time does not exceed the FCC limit of 1.6 W/kg for 1gSAR:

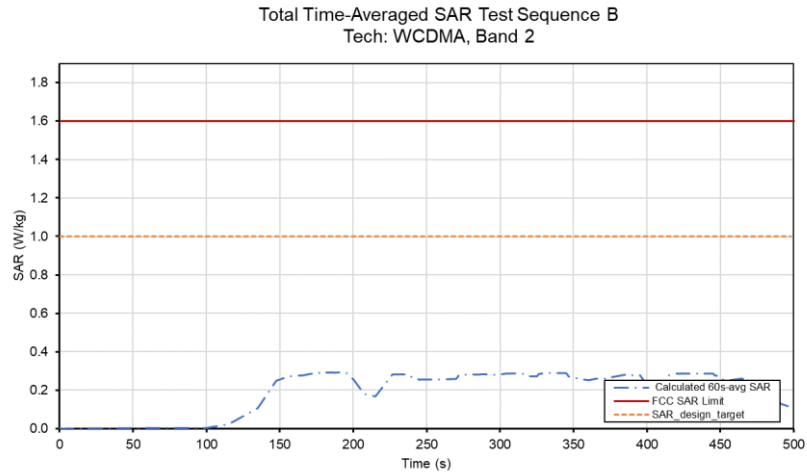

	(W/kg)
FCC 1gSAR limit	1.6
Max 60s-time averaged 1gSAR (blue curve)	0.293
<p>Validated: Max time averaged SAR (blue curve) is within 1 dB device uncertainty of measured SAR at P_{limit} (worst case SAR column in Table 7-3).</p>	

FCC ID: A3LSMA356E	PART 2 RF EXPOSURE EVALUATION REPORT	Approved by: Technical Manager
Document S/N: 1M2310260110-21.A3L	DUT Type: Portable Handset	Page 34 of 66

8.1.4 LTE Band 66, Ant B

Test result for test sequence A:

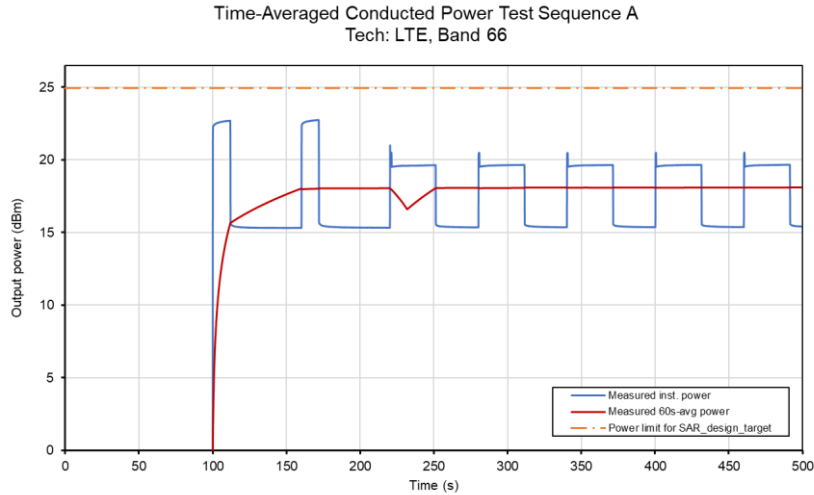

Time-averaged conducted Tx power is converted/calculated into time-averaged 1gSAR and is plotted below to demonstrate that the time-averaged 1gSAR versus time does not exceed the FCC limit of 1.6 W/kg for 1gSAR:

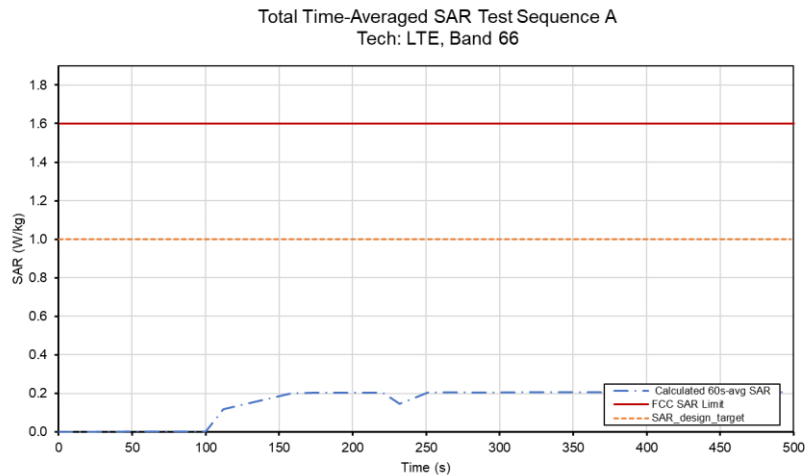

	(W/kg)
FCC 1gSAR limit	1.6
Max 60s-time averaged 1gSAR (blue curve)	0.207
<p>Validated: Max time averaged SAR (blue curve) is within 1 dB device uncertainty of measured SAR at P_{limit} (worst case SAR column in Table 7-3).</p>	

FCC ID: A3LSMA356E	PART 2 RF EXPOSURE EVALUATION REPORT	Approved by: Technical Manager
Document S/N: 1M2310260110-21.A3L	DUT Type: Portable Handset	Page 35 of 66

Test result for test sequence B:

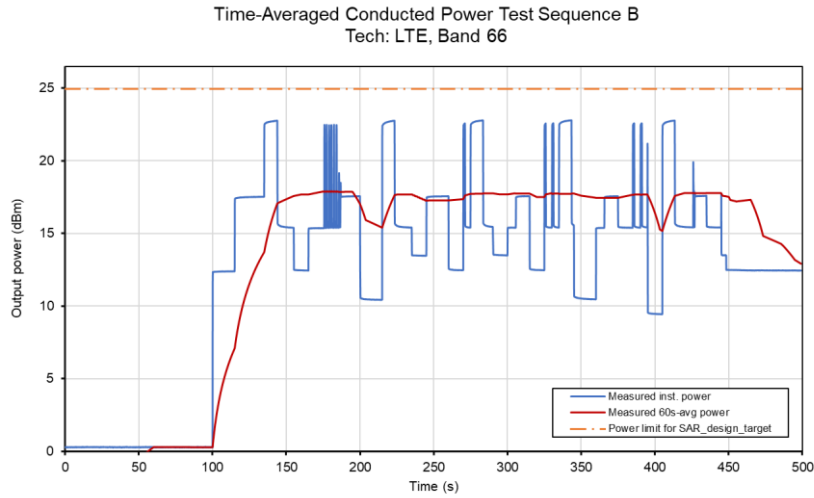

Time-averaged conducted Tx power is converted/calculated into time-averaged 1gSAR and is plotted below to demonstrate that the time-averaged 1gSAR versus time does not exceed the FCC limit of 1.6 W/kg for 1gSAR:

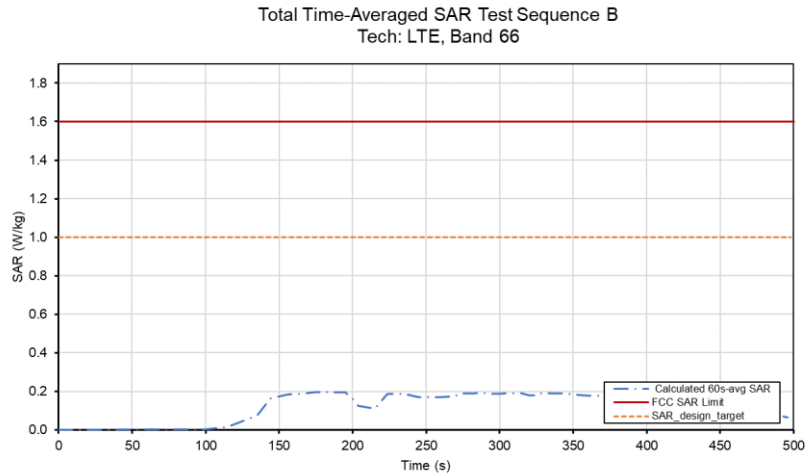

	(W/kg)
FCC 1gSAR limit	1.6
Max 60s-time averaged 1gSAR (blue curve)	0.197
<p style="color: green; margin: 0;">Validated: Max time averaged SAR (blue curve) is within 1 dB device uncertainty of measured SAR at P_{limit} (worst case SAR column in Table 7-3).</p>	

FCC ID: A3LSMA356E	PART 2 RF EXPOSURE EVALUATION REPORT	Approved by: Technical Manager
Document S/N: 1M2310260110-21.A3L	DUT Type: Portable Handset	Page 36 of 66

8.1.5 LTE Band 41, Ant B

Test result for test sequence A:

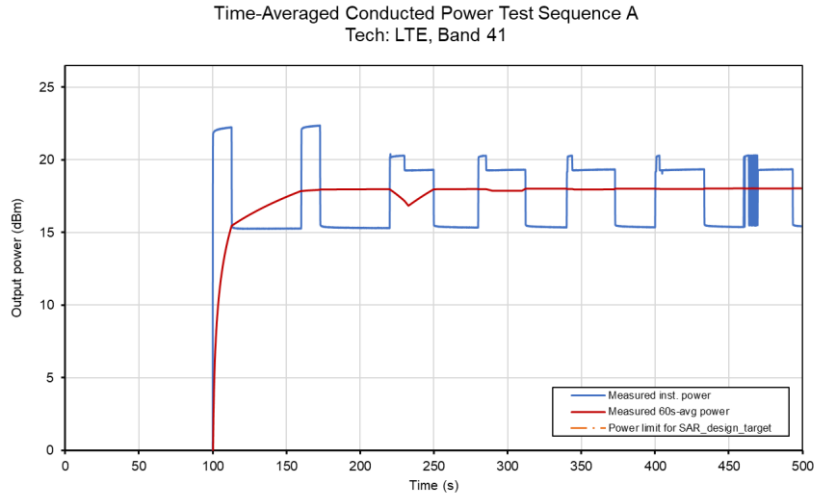

Time-averaged conducted Tx power is converted/calculated into time-averaged 1gSAR and is plotted below to demonstrate that the time-averaged 1gSAR versus time does not exceed the FCC limit of 1.6 W/kg for 1gSAR:

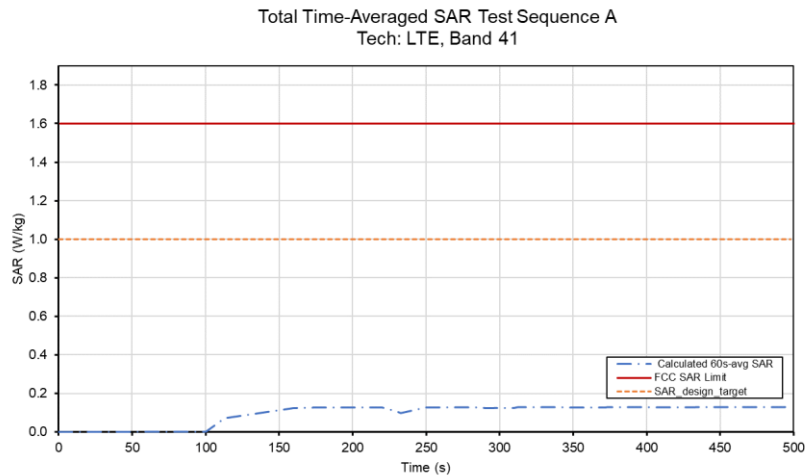

	(W/kg)
FCC 1gSAR limit	1.6
Max 60s-time averaged 1gSAR (blue curve)	0.129
Validated: Max time averaged SAR (blue curve) is within 1 dB device uncertainty of measured SAR at P_{limit} (worst case SAR column in Table 7-3).	

FCC ID: A3LSMA356E	PART 2 RF EXPOSURE EVALUATION REPORT	Approved by: Technical Manager
Document S/N: 1M2310260110-21.A3L	DUT Type: Portable Handset	Page 37 of 66

Test result for test sequence B:

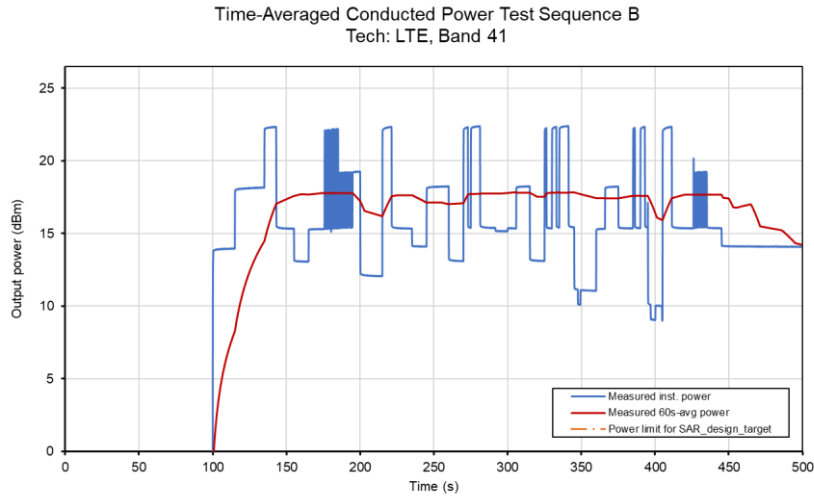

Time-averaged conducted Tx power is converted/calculated into time-averaged 1gSAR and is plotted below to demonstrate that the time-averaged 1gSAR versus time does not exceed the FCC limit of 1.6 W/kg for 1gSAR:

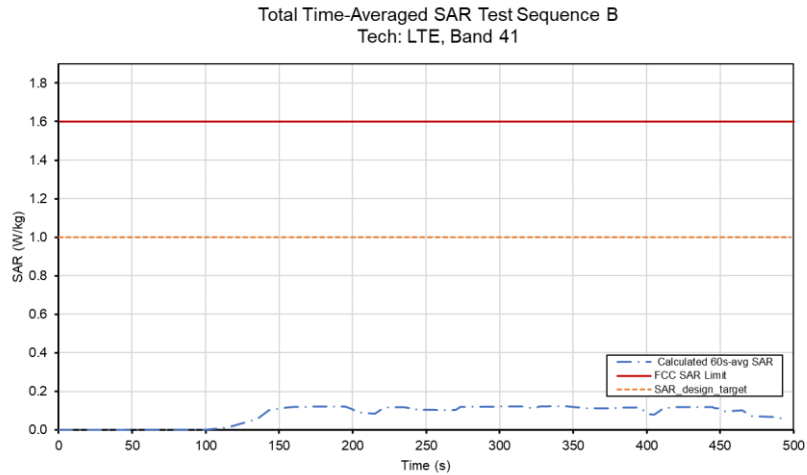

	(W/kg)
FCC 1gSAR limit	1.6
Max 60s-time averaged 1gSAR (blue curve)	0.123
<p>Validated: Max time averaged SAR (blue curve) is within 1 dB device uncertainty of measured SAR at P_{limit} (worst case SAR column in Table 7-3).</p>	

FCC ID: A3LSMA356E	PART 2 RF EXPOSURE EVALUATION REPORT	Approved by: Technical Manager
Document S/N: 1M2310260110-21.A3L	DUT Type: Portable Handset	Page 38 of 66

8.1.6 NR FR1 n66 SA, Ant B

Test result for test sequence A:

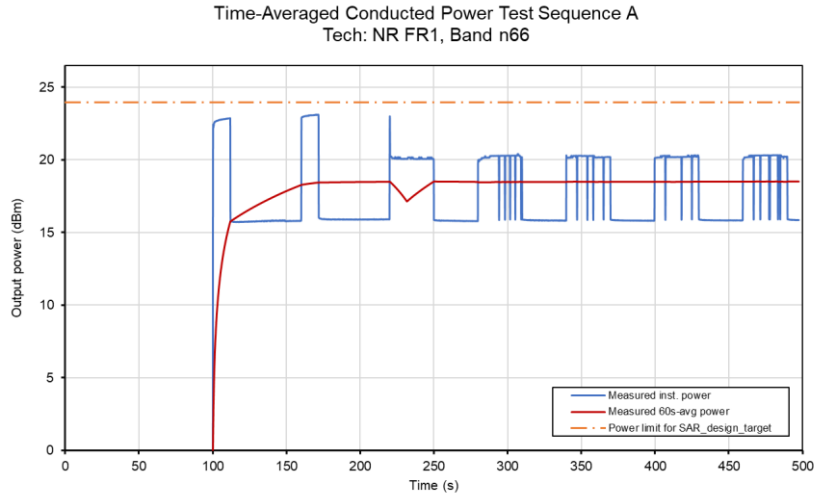

Time-averaged conducted Tx power is converted/calculated into time-averaged 1gSAR and is plotted below to demonstrate that the time-averaged 1gSAR versus time does not exceed the FCC limit of 1.6 W/kg for 1gSAR:

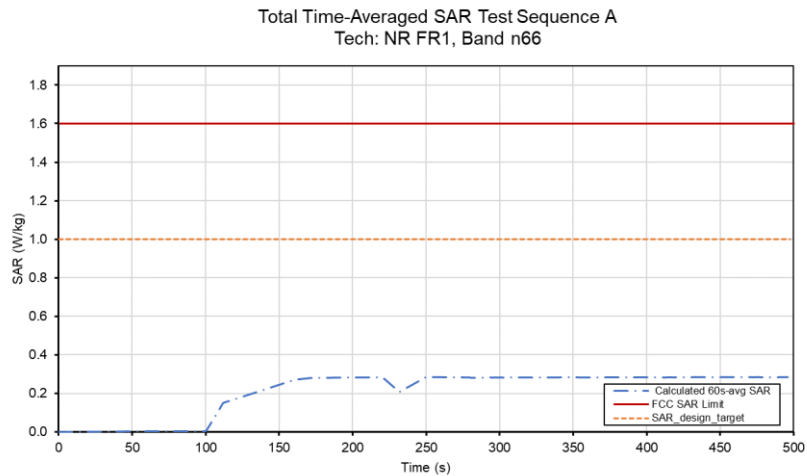

	(W/kg)
FCC 1gSAR limit	1.6
Max 60s-time averaged 1gSAR (blue curve)	0.285
Validated: Max time averaged SAR (blue curve) is within 1 dB device uncertainty of measured SAR at P_{limit} (worst case SAR column in Table 7-3).	

FCC ID: A3LSMA356E	PART 2 RF EXPOSURE EVALUATION REPORT	Approved by: Technical Manager
Document S/N: 1M2310260110-21.A3L	DUT Type: Portable Handset	Page 39 of 66

Test result for test sequence B:

Time-Averaged Conducted Power Test Sequence B
Tech: NR FR1, Band n66

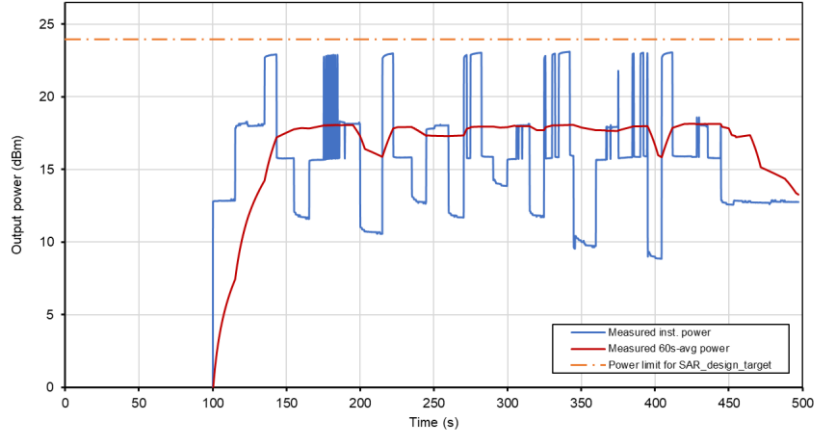

Time-averaged conducted Tx power is converted/calculated into time-averaged 1gSAR and is plotted below to demonstrate that the time-averaged 1gSAR versus time does not exceed the FCC limit of 1.6 W/kg for 1gSAR:

Total Time-Averaged SAR Test Sequence B
Tech: NR FR1, Band n66

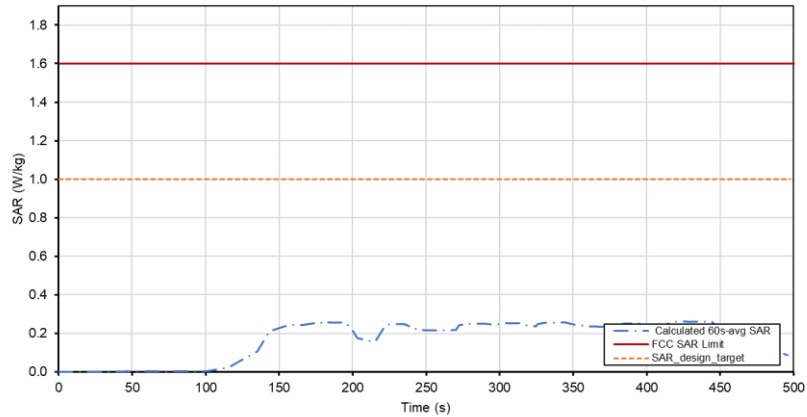

	(W/kg)
FCC 1gSAR limit	1.6
Max 60s-time averaged 1gSAR (blue curve)	0.262
<p>Validated: Max time averaged SAR (blue curve) is within 1 dB device uncertainty of measured SAR at P_{limit} (worst case SAR column in Table 7-3).</p>	

FCC ID: A3LSMA356E	PART 2 RF EXPOSURE EVALUATION REPORT	Approved by: Technical Manager
Document S/N: 1M2310260110-21.A3L	DUT Type: Portable Handset	Page 40 of 66

8.1.7 NR FR1 n41 SA, Ant B

Test result for test sequence A:

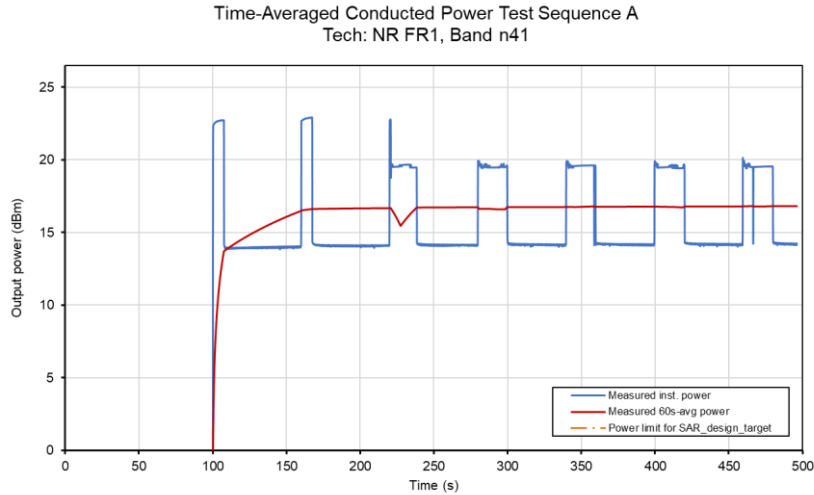

Time-averaged conducted Tx power is converted/calculated into time-averaged 1gSAR and is plotted below to demonstrate that the time-averaged 1gSAR versus time does not exceed the FCC limit of 1.6 W/kg for 1gSAR:

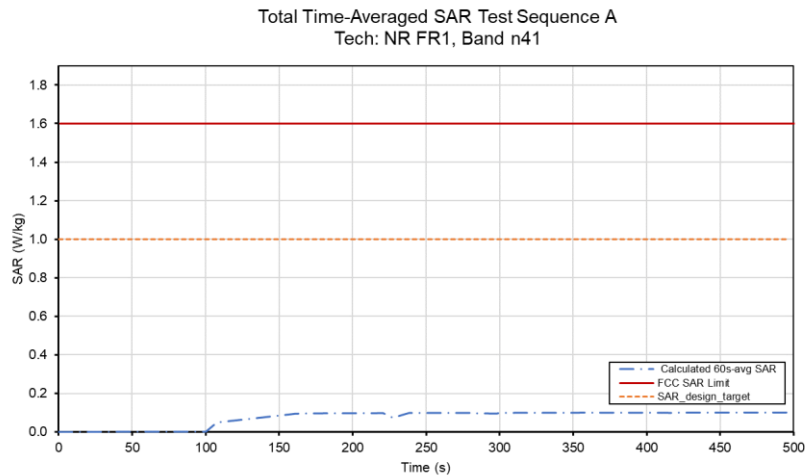

	(W/kg)
FCC 1gSAR limit	1.6
Max 60s-time averaged 1gSAR (blue curve)	0.101
Validated: Max time averaged SAR (blue curve) is within 1 dB device uncertainty of measured SAR at P_{limit} (worst case SAR column in Table 7-3).	

FCC ID: A3LSMA356E	PART 2 RF EXPOSURE EVALUATION REPORT	Approved by: Technical Manager
Document S/N: 1M2310260110-21.A3L	DUT Type: Portable Handset	Page 41 of 66

Test result for test sequence B:

Time-Averaged Conducted Power Test Sequence B
Tech: NR FR1, Band n41

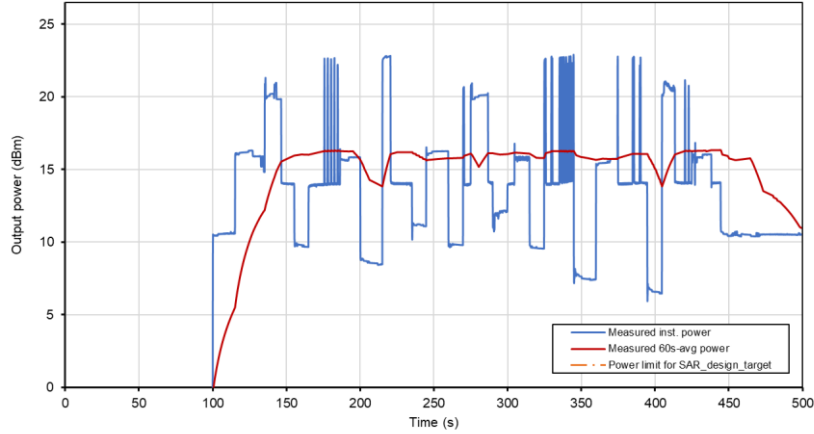

Time-averaged conducted Tx power is converted/calculated into time-averaged 1gSAR and is plotted below to demonstrate that the time-averaged 1gSAR versus time does not exceed the FCC limit of 1.6 W/kg for 1gSAR:

Total Time-Averaged SAR Test Sequence B
Tech: NR FR1, Band n41

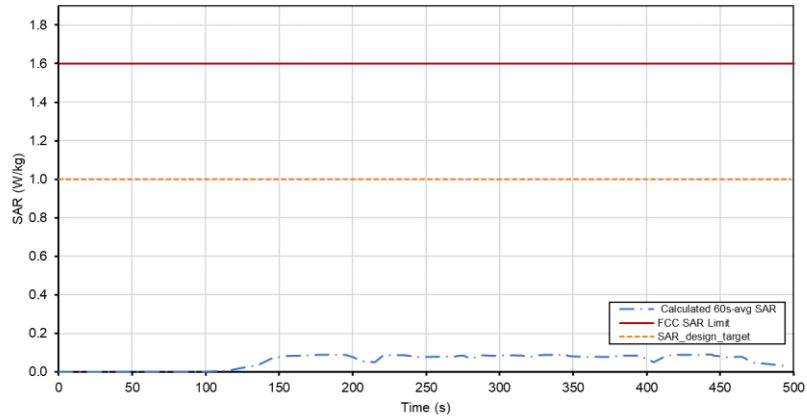

	(W/kg)
FCC 1gSAR limit	1.6
Max 60s-time averaged 1gSAR (blue curve)	0.090
Validated: Max time averaged SAR (blue curve) is within 1 dB device uncertainty of measured SAR at P_{limit} (worst case SAR column in Table 7-3).	

FCC ID: A3LSMA356E	PART 2 RF EXPOSURE EVALUATION REPORT	Approved by: Technical Manager
Document S/N: 1M2310260110-21.A3L	DUT Type: Portable Handset	Page 42 of 66

8.2 Change in Call Test Case

This test was measured NR FR1 n41 SA, antenna B, RSI = 0, and with callbox requesting maximum power. The call drop was manually performed at around 500s and resumed after 10s as shown in the plot below. The measurement setup is shown in Figure 6-1(a).

Call drop test result:

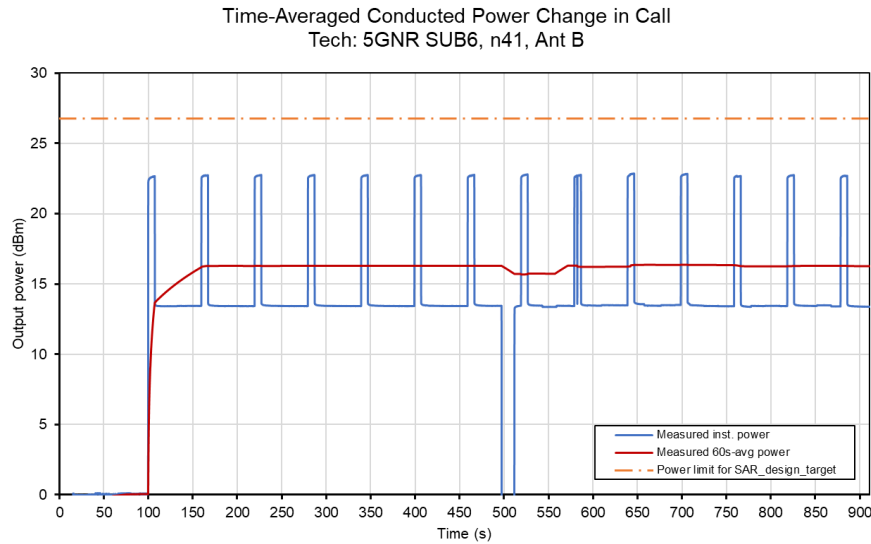

Time-averaged conducted Tx power is converted/calculated into time-averaged 1gSAR and is plotted below to demonstrate that the time-averaged 1gSAR versus time does not exceed the total SAR_design_target limit of 1.0 W/kg while also being under the FCC limit of 1.6 W/kg for 1gSAR:

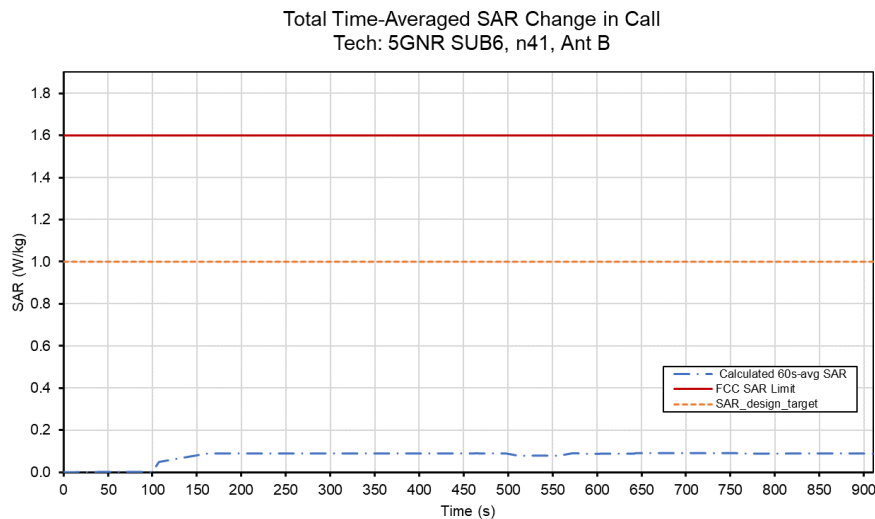

FCC ID: A3LSMA356E	PART 2 RF EXPOSURE EVALUATION REPORT	Approved by: Technical Manager
Document S/N: 1M2310260110-21.A3L	DUT Type: Portable Handset	Page 43 of 66

	(W/kg)
FCC 1gSAR limit	1.6
Max 60s-time averaged 1gSAR (blue curve)	0.091
Validated	

The test result validated the continuity of power limiting in call change scenario.

8.3 Change in Technology/Band Test Case

This test was conducted with callbox requesting maximum power, and with a technology switch from LTE Band 66, antenna B, RSI = 0, to WCDMA Band 2, antenna B, RSI = 0. Using the measurement setup shown in Figure 6-1(a), the technology/band switch was performed around 232s as shown in the plot below.

Test result for change in technology/band:

Conducted Tx Power for LTE to WCDMA IRAT Re-selection
Tech: LTE, Band 66, Antenna B / WCDMA, Band 2, Antenna B

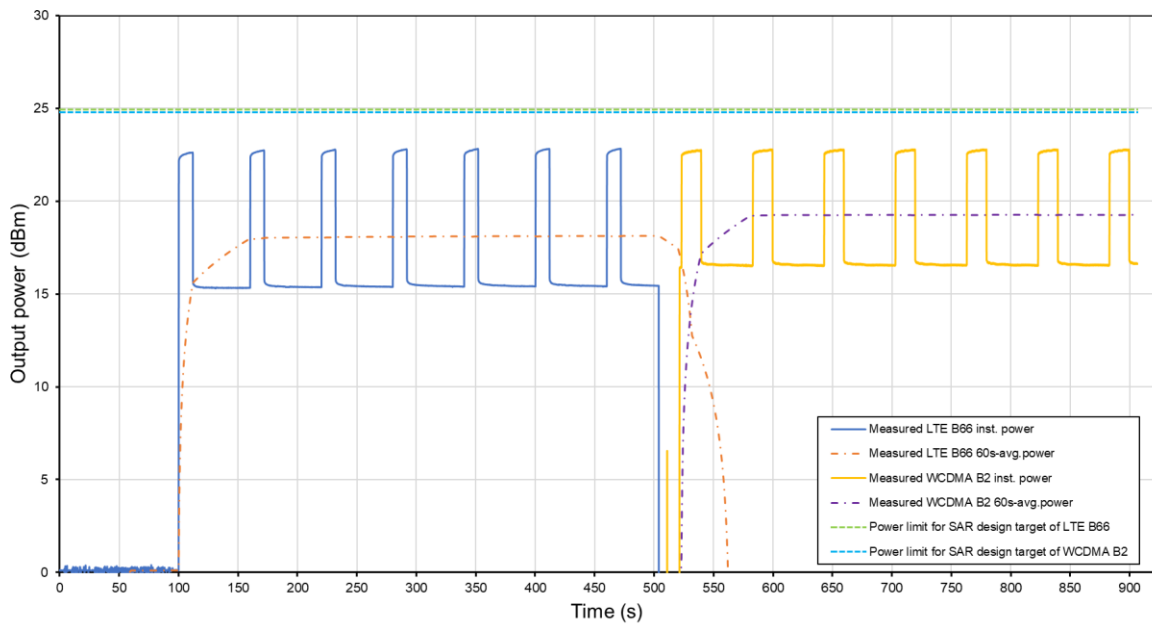

Time-averaged conducted Tx power is converted/calculated into time-averaged 1gSAR and is plotted below to demonstrate that the time-averaged 1gSAR versus time does not exceed the total SAR_design_target limit of 1.0 W/kg while also being under the FCC limit of 1.6 W/kg for 1gSAR:

FCC ID: A3LSMA356E	PART 2 RF EXPOSURE EVALUATION REPORT	Approved by: Technical Manager
Document S/N: 1M2310260110-21.A3L	DUT Type: Portable Handset	Page 44 of 66

Total Time Averaged SAR for LTE to WCDMA IRAT Re-selection
 Tech: LTE, Band 66, Antenna B / WCDMA, Band 2, Antenna B

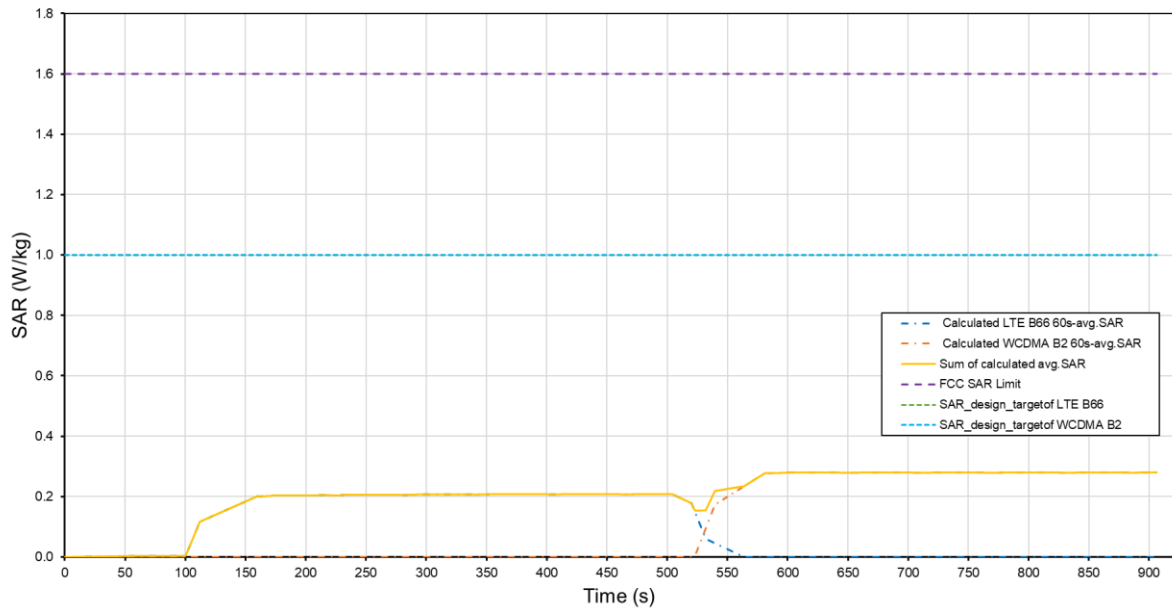

	(W/kg)
FCC 1gSAR limit	1.6
Max sum of calculated averaged 1gSAR (yellow curve)	0.280
Validated	

The test result validated the continuity of power limiting in technology/band switch scenario.

8.4 Change in Antenna Test Results

This test was conducted with callbox requesting maximum power, within an antenna group (AG2) with an antenna switch from LTE Band 5, Antenna A, RSI = 0, to LTE Band 66, Antenna B, RSI = 0. Using the measurement setup shown in Figure 6-1(a), the technology/band switch was performed around 400s as shown in the plot below.

Test result for change in antenna:

FCC ID: A3LSMA356E	PART 2 RF EXPOSURE EVALUATION REPORT	Approved by: Technical Manager
Document S/N: 1M2310260110-21.A3L	DUT Type: Portable Handset	Page 45 of 66

Conducted Tx Power for Change in Antenna
 Tech: LTE, Band 5, Antenna A / LTE, Band 66, Antenna B

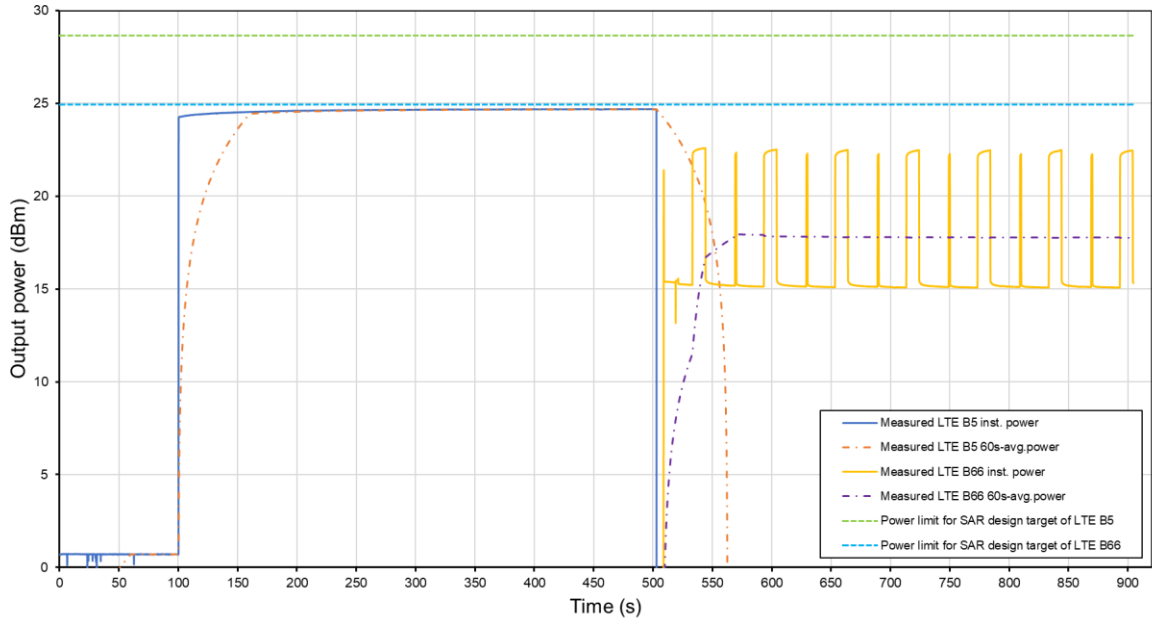

FCC ID: A3LSMA356E	PART 2 RF EXPOSURE EVALUATION REPORT	Approved by: Technical Manager
Document S/N: 1M2310260110-21.A3L	DUT Type: Portable Handset	Page 46 of 66

Time-averaged conducted Tx power is converted/calculated into time-averaged 1gSAR and is plotted below to demonstrate that the time-averaged 1gSAR versus time does not exceed the total SAR_design_target limit of 1.0 W/kg while also being under the FCC limit of 1.6 W/kg for 1gSAR:

Total Time Averaged SAR for Change in Antenna
Tech: LTE, Band 5, Antenna A / LTE, Band 66, Antenna B

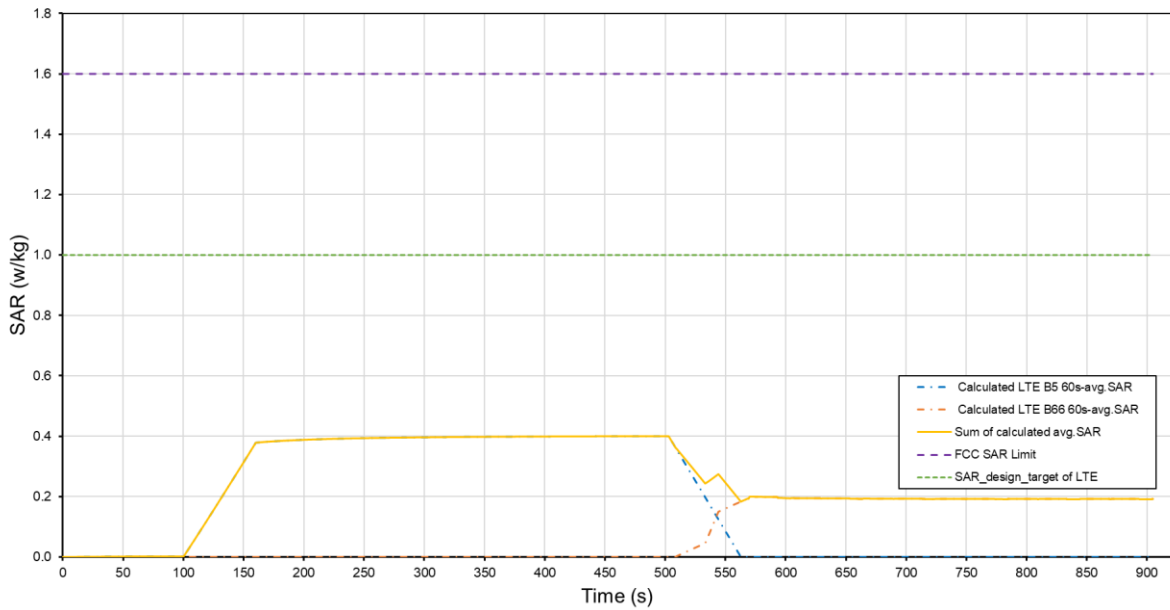

	(W/kg)
FCC 1gSAR limit	1.6
Max sum of calculated averaged 1gSAR (yellow curve)	0.400
Validated	

The test result validated the continuity of power limiting in antenna switch scenario.

8.5 Change in Radio SAR Index (RSI)

This test was conducted with a callbox requesting maximum power, and with an RSI switch from 0 to 4 of LTE Band 25, antenna B. Using the measurement setup shown in Figure 6-1(a), the technology/band switch was performed around 500s.

Test result for change in DSI:

FCC ID: A3LSMA356E	PART 2 RF EXPOSURE EVALUATION REPORT	Approved by: Technical Manager
Document S/N: 1M2310260110-21.A3L	DUT Type: Portable Handset	Page 47 of 66

Conducted Tx Power for Change in RSI
 Tech: LTE, Band 25, Antenna B, RSI = 0 to RSI = 4

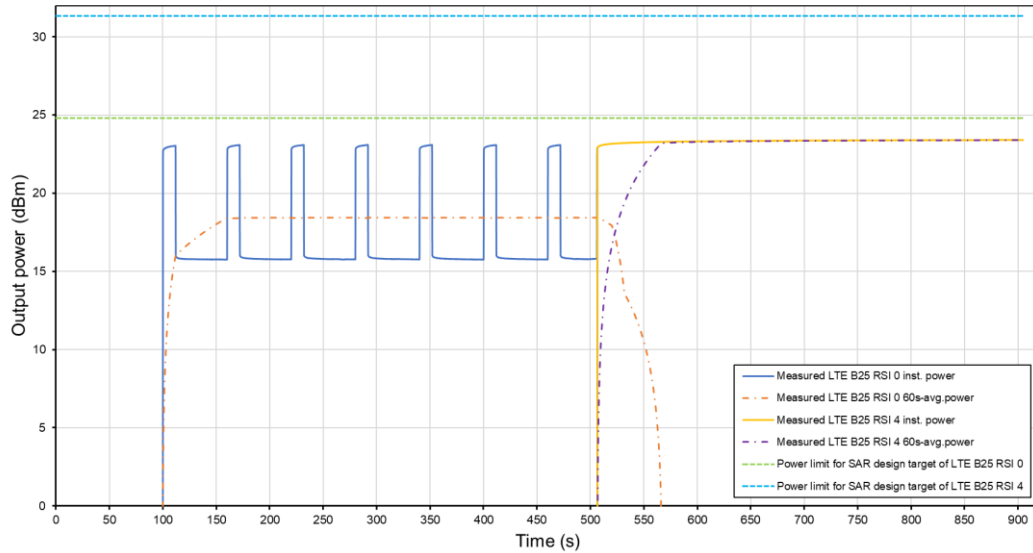

Time-averaged conducted Tx power is converted/calculated into time-averaged 1gSAR and is plotted below to demonstrate that the time-averaged 1gSAR versus time does not exceed the total SAR_design_target limit of 1.0 W/kg while also being under the FCC limit of 1.6 W/kg for 1gSAR:

Total Time Averaged SAR for for Change in RSI
 Tech: LTE, Band 25, Antenna B, RSI = 0 to RSI = 4

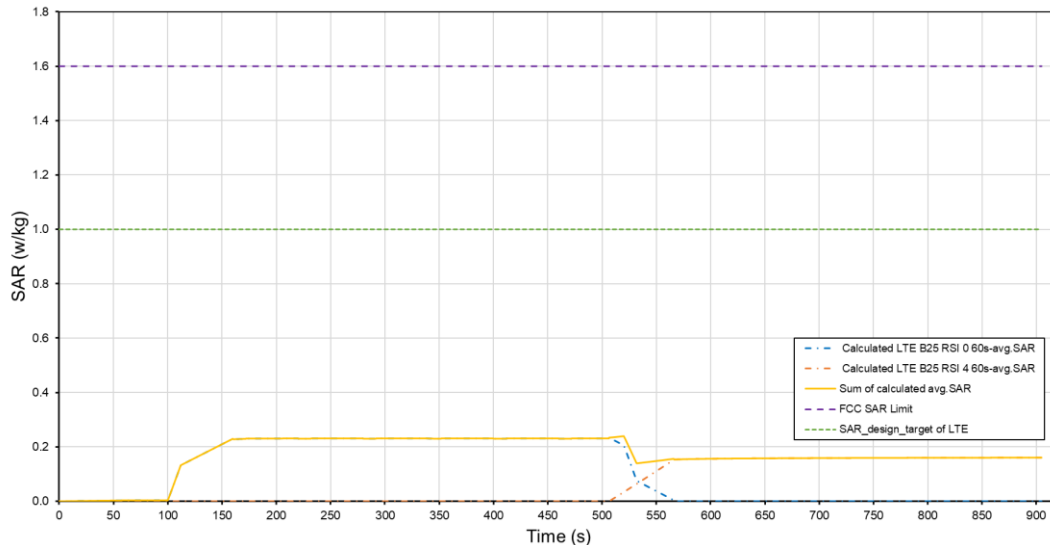

FCC ID: A3LSMA356E	PART 2 RF EXPOSURE EVALUATION REPORT	Approved by: Technical Manager
Document S/N: 1M2310260110-21.A3L	DUT Type: Portable Handset	Page 48 of 66

	(W/kg)
FCC 1gSAR limit	1.6
Max sum of calculated averaged 1gSAR (yellow curve)	0.234
Validated	

The test result validated the continuity of power limiting in change in RSI scenario.

8.6 SAR Exposure Switching Test Results (ENDC)

This test was conducted with a callbox requesting maximum power, and with the EUT in LTE Band 5 + Sub6 NR Band n66 call. Using the measurement setup shown in Figure 6-1(c), the SAR exposure switch measurement is performed with the EUT in various SAR exposure scenarios, i.e., in SAR_{sub6NR} only scenario (t =0s ~220s), SAR_{sub6NR} + SAR_{LTE} scenario (t =220s ~ 330s) and SAR_{LTE} only scenario (t > 330s).

Conducted Tx Power for SAR Exposure Switching
 Tech: LTE, Band 5, Antenna A / 5GNR SUB6, n66, Antenna B

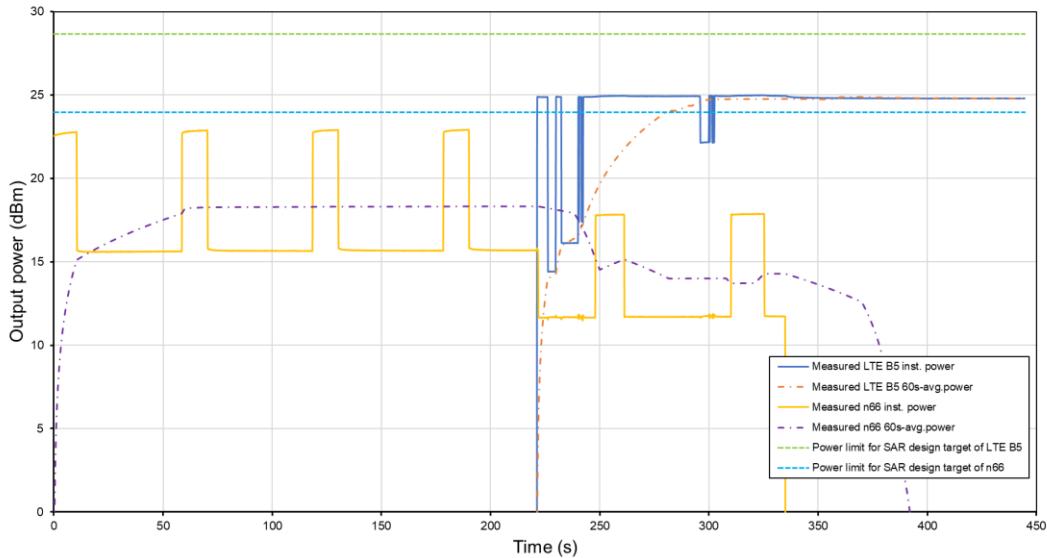

Plot Notes: All the conducted Tx power measurement results were converted into time-averaged SAR values and plotted below to demonstrate that the time-averaged SAR versus time does not exceed the total SAR_{design_target} limit of 1.0 W/kg, while also being under FCC limit of 1.6W/kg.

FCC ID: A3LSMA356E	PART 2 RF EXPOSURE EVALUATION REPORT	Approved by: Technical Manager
Document S/N: 1M2310260110-21.A3L	DUT Type: Portable Handset	Page 49 of 66

Total Time Averaged SAR for SAR Exposure Switching
 Tech: LTE, Band 5, Antenna A / 5G NR SUB6, n66, Antenna B

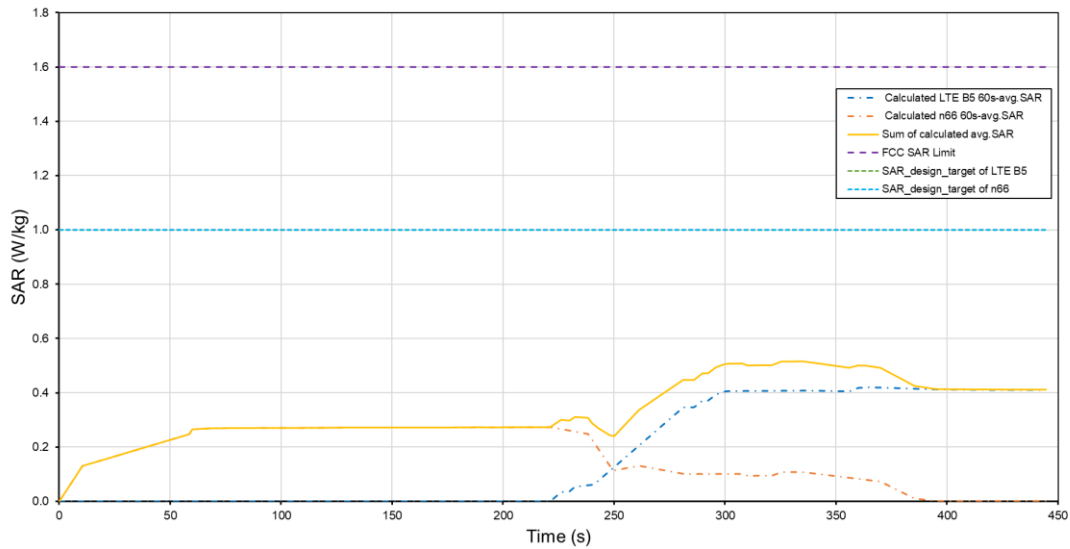

	(W/kg)
FCC 1gSAR limit	1.6
Max time averaged normalized SAR (yellow curve)	0.515
Validated	

Plot Notes: Device starts predominantly in Sub6 NR SAR exposure scenario between 0s and 220s, and in LTE SAR + Sub6 NR SAR exposure scenario between 220s and 330s, and in predominantly in LTE SAR exposure scenario after 330s. In this test, time-averaged SAR for both LTE and FR1 as well as the sum are under the total SAR_design_target limit of 1.0W/kg, while also being under the FCC limit of 1.6 W/kg at all times.

8.7 TAS to non-TAS Handover

This test was conducted with callbox requesting maximum power, and with a technology switch from LTE Band 66, antenna B, RSI = 0, TAS ON to WCDMA Band 4, antenna B, RSI = 4, TAS OFF. Using the measurement setup shown in Figure 6-1(a), the technology/band switch was performed around 500s as shown in the plot below.

Test result for TAS to nonTAS H.O:

FCC ID: A3LSMA356E	PART 2 RF EXPOSURE EVALUATION REPORT	Approved by: Technical Manager
Document S/N: 1M2310260110-21.A3L	DUT Type: Portable Handset	Page 50 of 66

Conducted Tx Power for TAS to nonTAS
 Tech: LTE, Band 66, Antenna B / WCDMA, Band 4, Antenna B

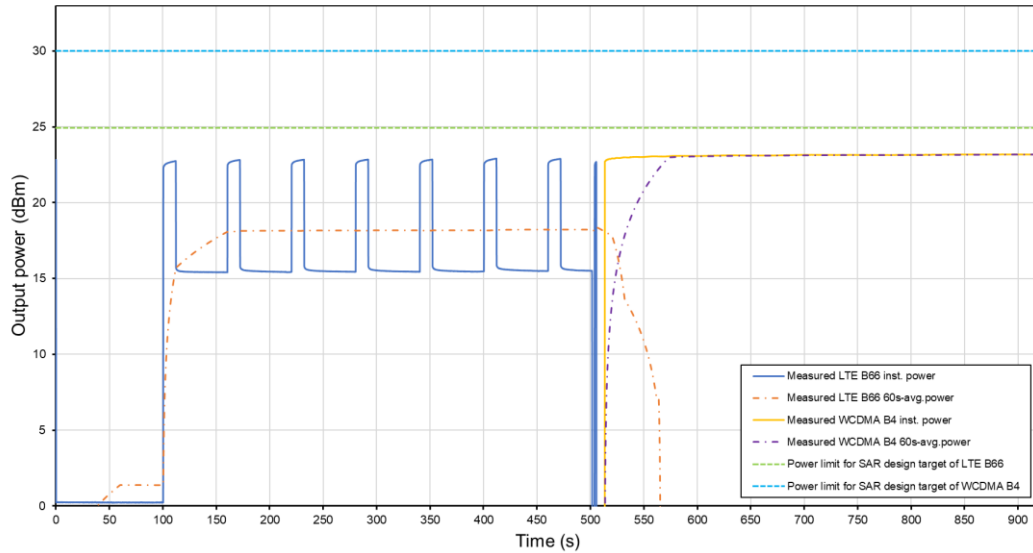

Plot note: The plot above shows the the instantaneous and time-averaged conducted Tx power for both LTE Band 66 with P_{limit} of 18.5dBm and WCDMA Band 4 with P_{limit} of 23.0dBm (TAS OFF). At around 500s time stamp of LTE Band 66 was manually handovered to WCDMA Band 4, resulting in reduction of time-averaged power of LTE Band 66 and simultaneous increase in time-averaged power of WCDMA Band 4. As WCDMA is a nonTAS RAT, its transmission shall be fixed at P_{max} of 23.0dBm.

Time-averaged conducted Tx power is converted/calculated into time-averaged 1gSAR and is plotted below to demonstrate that the time-averaged 1gSAR versus time does not exceed the total SAR_{design_target} limit of 1.0 W/kg while also being under the FCC limit of 1.6 W/kg for 1gSAR:

FCC ID: A3LSMA356E	PART 2 RF EXPOSURE EVALUATION REPORT	Approved by: Technical Manager
Document S/N: 1M2310260110-21.A3L	DUT Type: Portable Handset	Page 51 of 66

Total Time Averaged SAR for TAS to nonTAS
 Tech: LTE, Band 66, Antenna B / WCDMA, Band 4, Antenna B

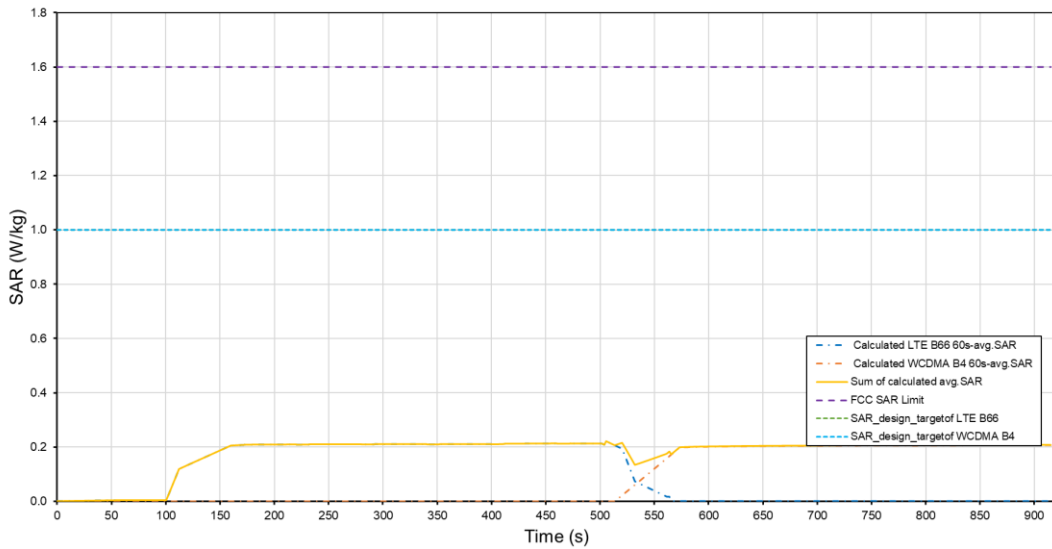

	(W/kg)
FCC 1gSAR limit	1.6
Max sum of calculated averaged 1gSAR (yellow curve)	0.222
Validated	

The test result validated the continuity of power limiting in TAS to nonTAS H.O scenario.

8.8 SAR Exposure Switching ULCA

This test was conducted with callbox requesting maximum power, and with the EUT in LTE ULCA 5A-66A combo. The measurement setup shown in Figure 6-1(b) was used because each LTE do not share the same antenna port. The SAR exposure switch measurement is performed with the EUT in various SAR exposure scenarios, i.e., in low power 0dBm scenario (t =0s ~110s), SAR_{PCC} max scenario (t =110s ~ 220s) and SAR_{PCC} + SAR_{SCC} max scenario (t > 220s).

FCC ID: A3LSMA356E	PART 2 RF EXPOSURE EVALUATION REPORT	Approved by: Technical Manager
Document S/N: 1M2310260110-21.A3L	DUT Type: Portable Handset	Page 52 of 66

Conducted Tx Power for LTE ULCA
 Tech: LTE, Band 66, Antenna B / LTE, Band 5, Antenna A

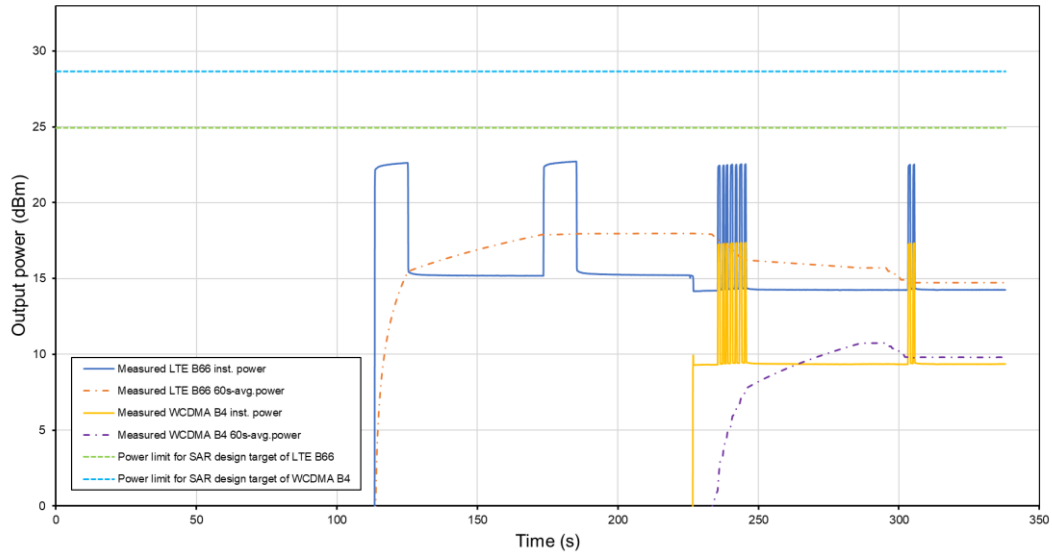

All the conducted Tx power measurement results were converted into time-averaged SAR values using Equation (3a), (3b) and (3c), and plotted below to demonstrate that the time-averaged SAR versus time does not exceed the total SAR_design_target limit of 1.0 W/kg while also being under the FCC limit of 1.6 W/kg for 1gSAR.

Total Time Averaged SAR for LTE ULCA
 Tech: LTE, Band 66, Antenna B / LTE, Band 5, Antenna A

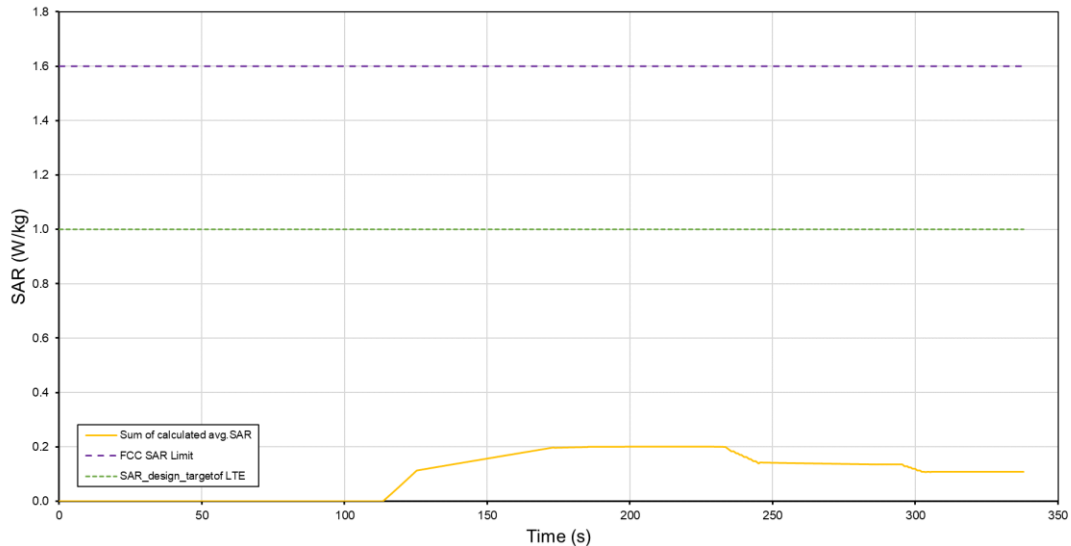

FCC ID: A3LSMA356E	PART 2 RF EXPOSURE EVALUATION REPORT	Approved by: Technical Manager
Document S/N: 1M2310260110-21.A3L	DUT Type: Portable Handset	Page 53 of 66

	(W/kg)
FCC 1gSAR limit	1.6
Max 60s-time averaged 1gSAR (yellow curve)	0.200
Validated	

Plot Notes: Device starts predominantly in LTE Band 66 (PCC) SAR exposure scenario between 110s and 220s, and in LTE B66 (PCC) SAR + LTE B5 (SCC) SAR exposure scenario between 220s and 330s. In this test, time-averaged SAR for both LTE PCC and LTE SCC as well as the sum are under the total SAR_design_target limit of 1.0W/kg, while also being under the FCC limit of 1.6 W/kg at all times.

8.9 LTE Antenna Switch with Spatial TAS

This test was conducted with a callbox requesting maximum power, and with a band switch from antenna B - AG1 (LTE Band 25, RSI = 0) to antenna F - AG2 (LTE Band 66, RSI = 0) then switch back to antenna B - AG1 (LTE Band 25, RSI = 0). Using the measurement setup shown in Figure 6-1(a), the technology/band switch was performed around 500s and 900s as shown in the plot below:

Conducted Tx Power for LTE Antenna Switching Spatial TAS
Tech: LTE, Band 66, Antenna B / LTE, Band 25, Antenna F

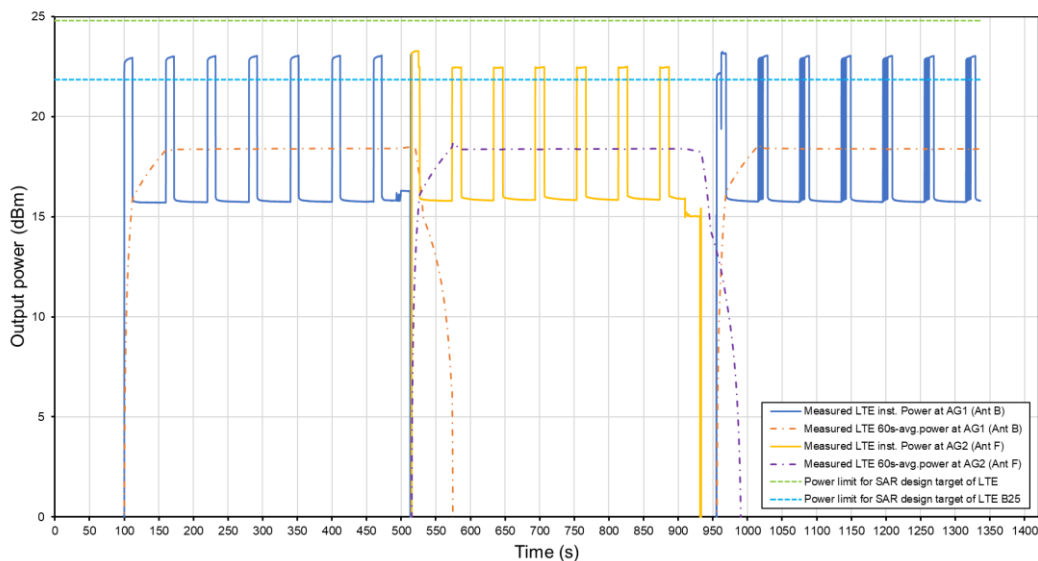

Plot note: The plot above shows the instantaneous and time-averaged conducted Tx power at antenna B - AG1 (LTE Band 66, RSI = 0) and antenna F - AG2 (LTE Band 25, RSI = 0). Transmission is initialized on LTE Band 66, antenna B - AG1 where it was set for very low power for ~100s. After that, a maximum power of 30.0dBm is requested and the TAS starts to cycle. After ~500s a band change happens to LTE Band 25 which operates at antenna F (AG2) and a maximum power of 30.0dBm is requested. Since the coupling between AG1 and AG2 is 0, then transmission at antenna F will start from maximum power regardless of the transmission at antenna B and will continue transmission for ~400s. Next, another band change is done to the first band LTE Band 66 and so an antenna switching to antenna B happens where a maximum power

FCC ID: A3LSMA356E	PART 2 RF EXPOSURE EVALUATION REPORT	Approved by: Technical Manager
Document S/N: 1M2310260110-21.A3L	DUT Type: Portable Handset	Page 54 of 66

of 30dBm is requested. Since AG1 and AG2 are uncoupled, then the transmission will start with maximum power.

As shown below, the total average SAR at each AG is below 1.0W/kg, while also being below the FCC limit of 1.6W/kg.

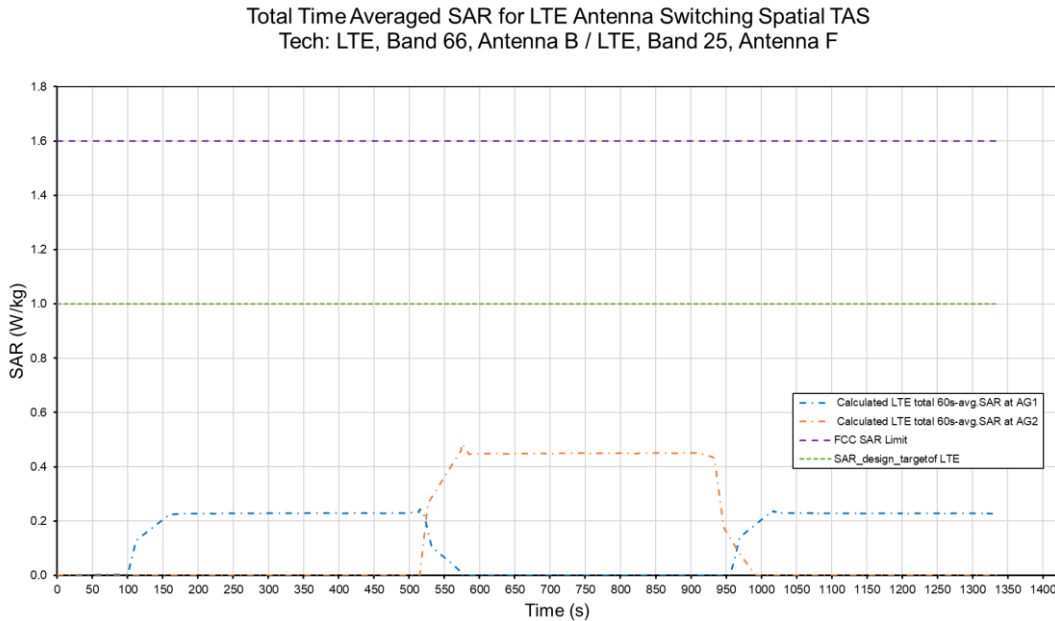

	(W/kg)
FCC 1gSAR limit	1.6
Max 60s-time averaged 1gSAR at AG1 (blue curve)	0.224
Max 60s-time averaged 1gSAR at AG2 (orange curve)	0.485
Validated	

8.10 NR FR1 Antenna Switch with Spatial TAS

This test was conducted with callbox requesting maximum power, and with a band switch from antenna B - AG1 (NR FR1 n41, RSI = 0) to antenna G - AG2 (NR FR1 n77, RSI = 0) then switch back to antenna B - AG1 (NR FR1 n41, RSI = 0). Using the measurement setup shown in Figure 6-1(a), the technology/band switch was performed around 500s and 900s as shown in the plot below:

FCC ID: A3LSMA356E	PART 2 RF EXPOSURE EVALUATION REPORT	Approved by: Technical Manager
Document S/N: 1M2310260110-21.A3L	DUT Type: Portable Handset	Page 55 of 66

Conducted Tx Power for NR FR1 Antenna Switching Spatial TAS
 Tech: NR FR1, n41, Antenna B / NR FR1, n77, Antenna G

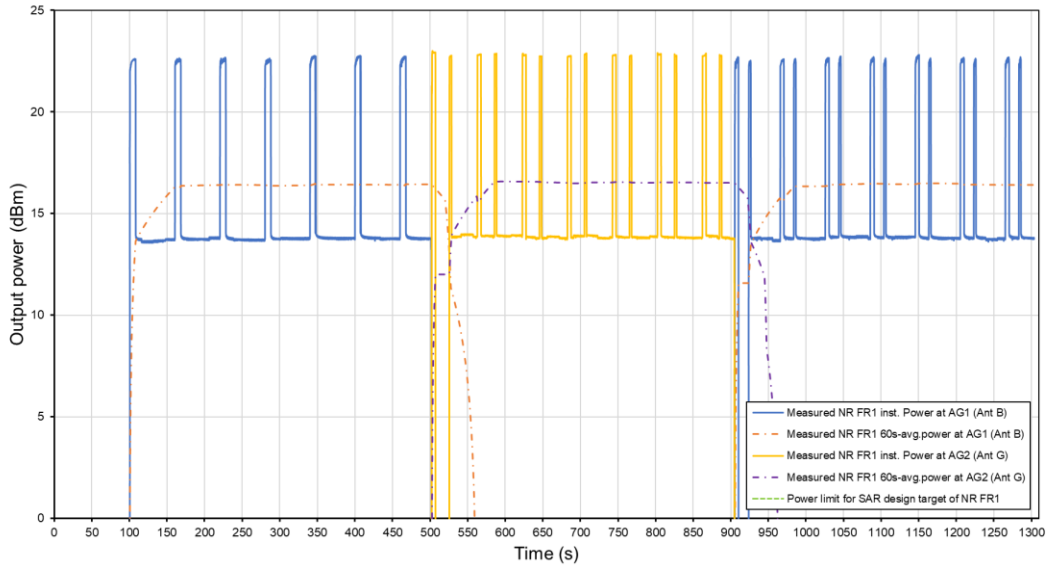

Plot note: The plot above shows the instantaneous and time-averaged conducted Tx power at antenna B - AG1 (NR FR1 n41, RSI = 0) and antenna G - AG2 (NR FR1 n77, RSI = 0). Transmission is initialized on NR FR1 n41, antenna B - AG1 where it was set for very low power for ~100s. After that, a maximum power of 30.0dBm is requested and the TAS starts to cycle. After ~400s a band change happens to NR FR1 n77 which operates at antenna G (AG2) and a maximum power of 30.0dBm is requested. Since the coupling between AG1 and AG2 is 0, then transmission at antenna F will start from maximum power regardless of the transmission at antenna B and will continue transmission for ~400s. Next, another band change is done to the first band NR FR1 n41 and so an antenna switching to antenna B happens where a maximum power of 30dBm is requested. Since AG1 and AG2 are uncoupled, then the transmission will start with maximum power.

As shown below, the total average SAR at each AG is below 1.0 W/kg, while also being below the FCC limit of 1.6W/kg.

FCC ID: A3LSMA356E	PART 2 RF EXPOSURE EVALUATION REPORT	Approved by: Technical Manager
Document S/N: 1M2310260110-21.A3L	DUT Type: Portable Handset	Page 56 of 66

Total Time Averaged SAR for NR FR1 Antenna Switching Spatial TAS
 Tech: NR FR1, n41, Antenna B / NR FR1, n77, Antenna G

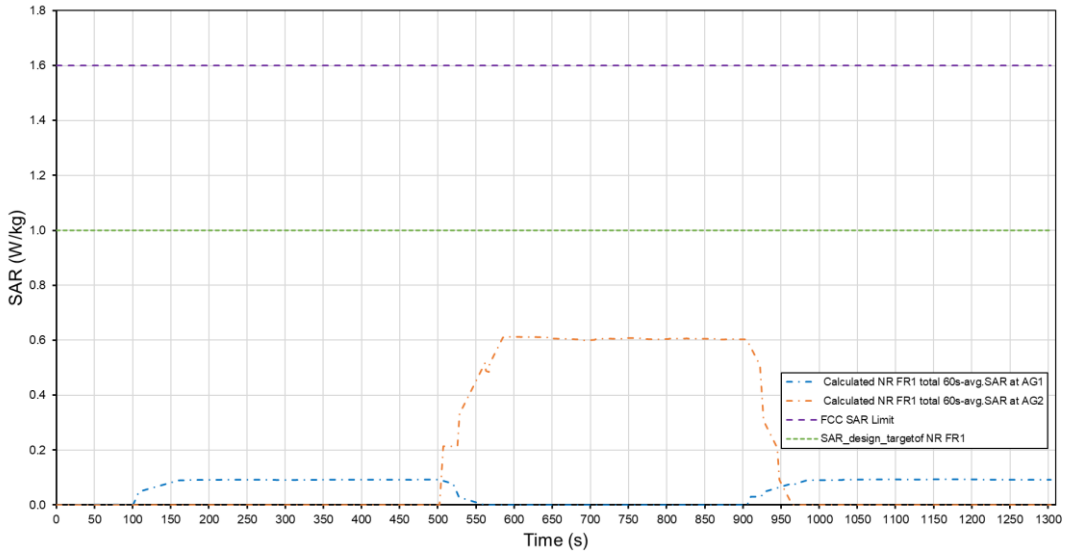

	(W/kg)
FCC 1gSAR limit	1.6
Max 60s-time averaged 1gSAR at AG1 (blue curve)	0.093
Max 60s-time averaged 1gSAR at AG2 (orange curve)	0.613
Validated	

8.11 NSA with Spatial TAS

This test was conducted with callbox requesting maximum power, and with the EUT in RSI = 0, LTE Band 66, antenna B + Sub6 NR Band n77, antenna G call. Using the measurement setup shown in Figure 6-1(c) since LTE and Sub6 NR are in different antenna ports, the SAR exposure switch measurement is performed with the EUT in various SAR exposure scenarios as shown in the plot below:

FCC ID: A3LSMA356E	PART 2 RF EXPOSURE EVALUATION REPORT	Approved by: Technical Manager
Document S/N: 1M2310260110-21.A3L	DUT Type: Portable Handset	Page 57 of 66

Conducted Tx Power for NSA with Spatial TAS
 Tech: LTE, Band 66, Antenna F / 5GNR SUB6, n77, Antenna G

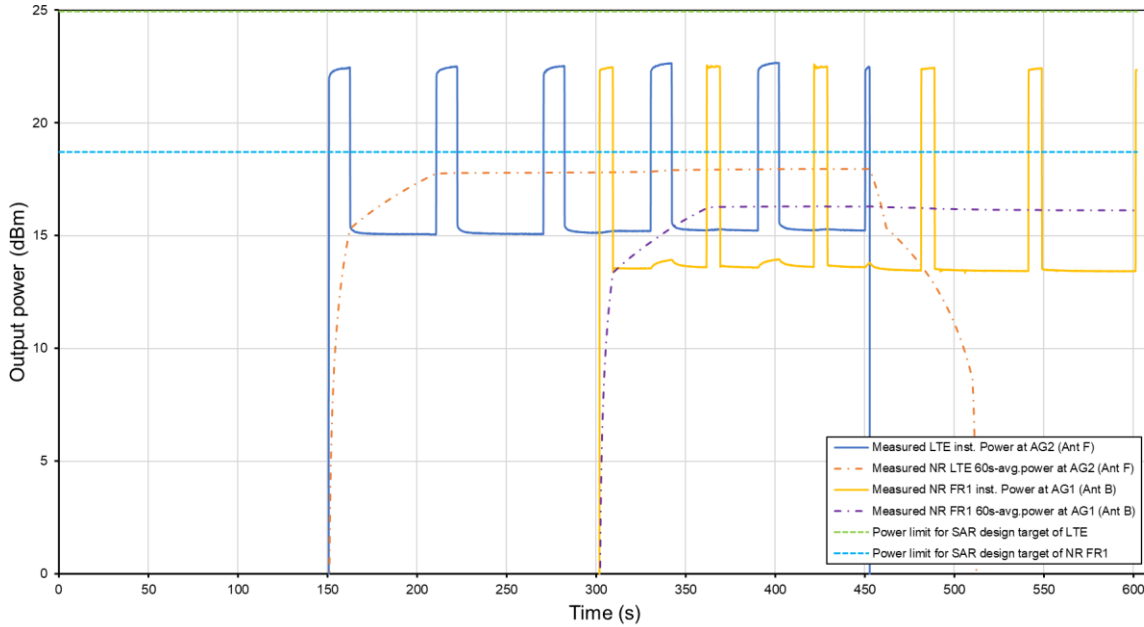

Plot note: The plot above shows the instantaneous and time-averaged conducted Tx power with RSI = 0, at antenna B with LTE band 66 (AG1) and at antenna G with NR FR1 band n77 (AG1). After the ENDC connection establishment, Both LTE and FR1 are set to no transmission for ~150s. Next, a transmission starts with LTE B66 requesting full max power of 30.0dBm and no transmission for FR1 and continue for 200s. After that, a maximum power of 30.0dBm is requested for FR1 band n77 and for 200s. Since both AGs are fully uncoupled, each RAT will operate with full Plimit. Next, the LTE transmission is down while FR1 continues transmission.

As shown below, the total average SAR at each AG is below 1.0W/kg, while also being below the FCC limit of 1.6W/kg.

FCC ID: A3LSMA356E	PART 2 RF EXPOSURE EVALUATION REPORT	Approved by: Technical Manager
Document S/N: 1M2310260110-21.A3L	DUT Type: Portable Handset	Page 58 of 66

Total Time Averaged SAR for NSA with Spatial TAS
Tech: LTE, Band 66, Antenna F / 5GNR SUB6, n77, Antenna G

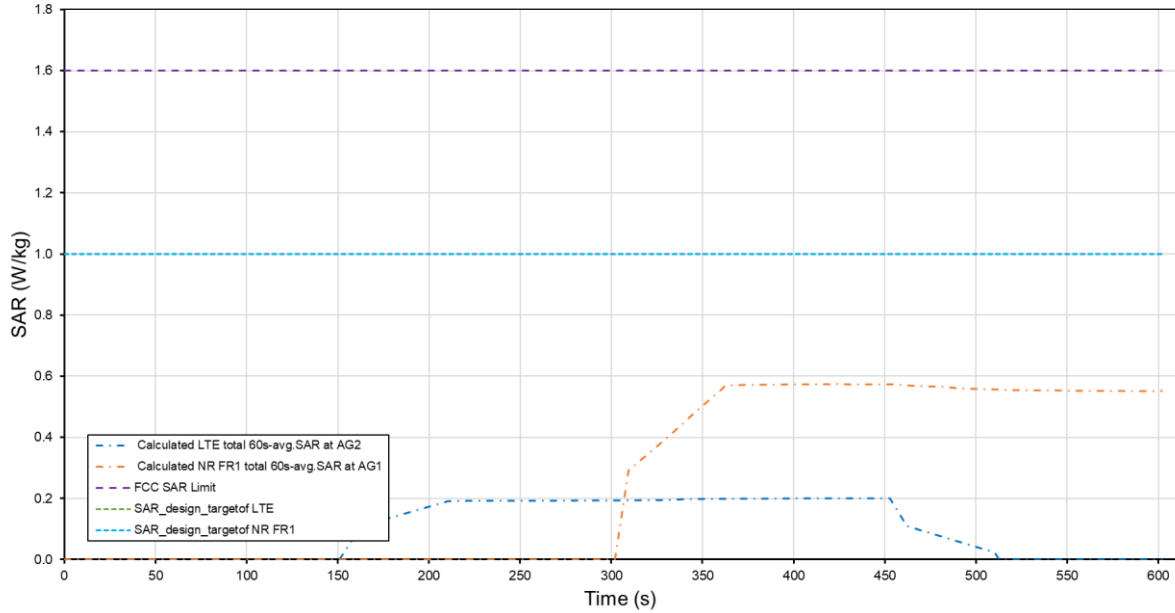

	(W/kg)
FCC 1gSAR limit	1.6
Max 60s-time averaged 1gSAR at AG1 (blue curve)	0.200
Max 60s-time averaged 1gSAR at AG2 (orange curve)	0.575
Validated	

8.12 NSA Antenna Switching with Spatial TAS

This test was conducted with callbox requesting maximum power, and with the EUT in RSI = 0, LTE Band 12 + NR FR1 n41 (AG1) and LTE Band 12 + NR FR1 n77 (AG2) call. Using the measurement setup shown in Figure 6-1(d) since LTE and Sub6 NR are in different antenna ports, the SAR exposure switch measurement is performed with the EUT in various SAR exposure scenarios as shown in the plot below:

FCC ID: A3LSMA356E	PART 2 RF EXPOSURE EVALUATION REPORT	Approved by: Technical Manager
Document S/N: 1M2310260110-21.A3L	DUT Type: Portable Handset	Page 59 of 66

Conducted Tx Power for NSA Antenna Switching with Spatial TAS
 Tech: LTE, Band 12, Ant A / 5GNR SUB6, n41, Ant B / 5GNR SUB6, n77, Ant G

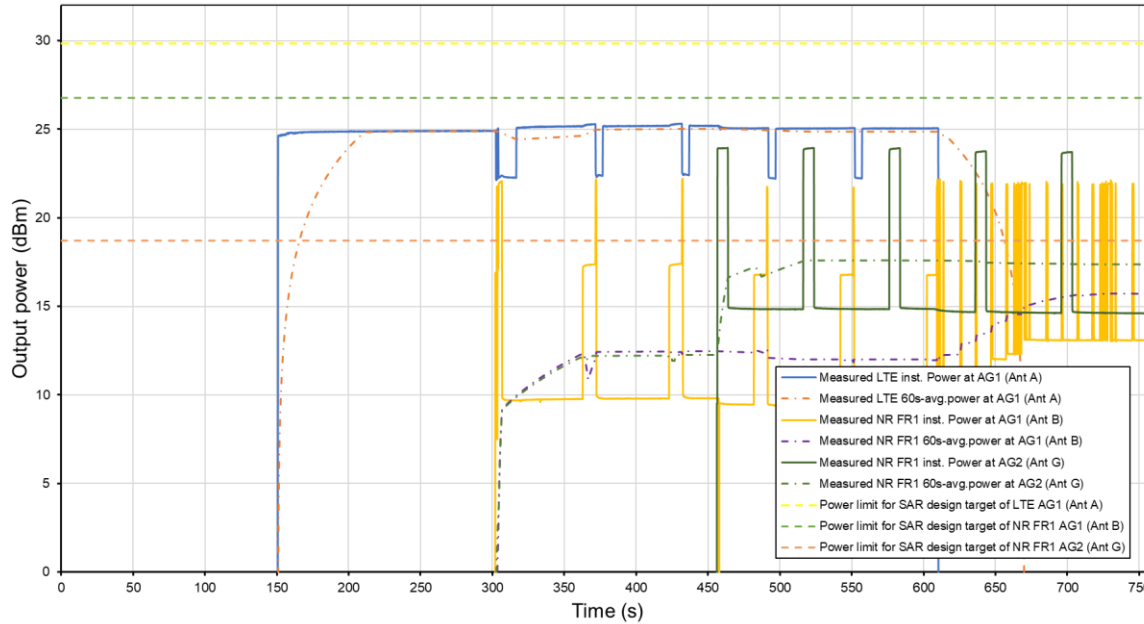

Plot note: The plot above shows the instantaneous and time-averaged conducted Tx power for an NSA operation where LTE transmits at antenna A (AG1) and FR1 at antenna B and antenna F with bands n41(AG0) and n77 (AG1) respectively. After the LTE B12 antenna A – n41 antenna B (AG1) ENDC connection establishment, Both LTE and FR1 are set to no transmission for ~150s. Next, a transmission starts with a callbox requesting LTE power of ~30.0dBm and no transmission for FR1 and continue for ~150s. After that, a maximum power of 30.0dBm is requested for FR1 n41 and transmission is done on antenna B and continues for ~150s. Next, FR1 will switch to band n77 which will require an antenna switch to antenna G (AG2) where FR1 requests maximum power 30.0dBm and transmission continues for ~150s. Since AG1 and AG2 are fully uncoupled, each RAT will operate with full Plimit. Next, the LTE transmission is down while FR1 continues transmission.

As shown below, the total average SAR at each AG is below 1.0W/kg, while also being below the FCC limit of 1.6W/kg.

FCC ID: A3LSMA356E	PART 2 RF EXPOSURE EVALUATION REPORT	Approved by: Technical Manager
Document S/N: 1M2310260110-21.A3L	DUT Type: Portable Handset	Page 60 of 66

Total Time Averaged SAR for NSA Antenna Switching with Spatial TAS
 Tech: LTE, Band 12, Ant A / 5G NR SUB6, n41, Ant B / 5G NR SUB6, n77, Ant G

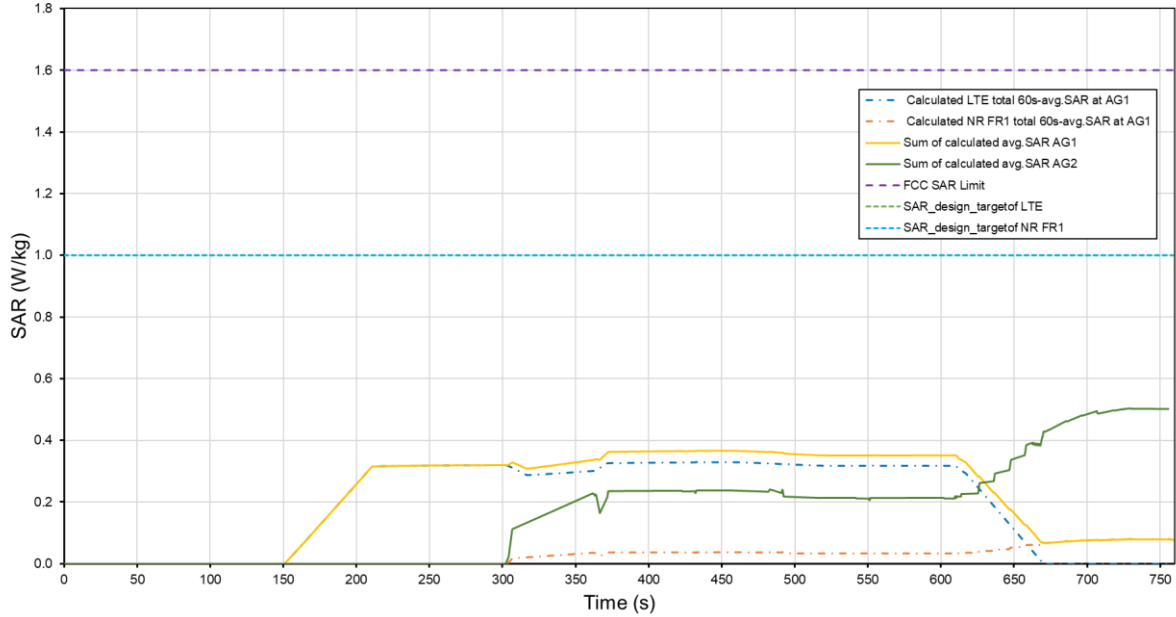

	(W/kg)
FCC 1gSAR limit	1.6
Max 60s-time averaged 1gSAR at AG1 (yellow curve)	0.366
Max 60s-time averaged 1gSAR at AG2 (green curve)	0.503
Validated	

FCC ID: A3LSMA356E	PART 2 RF EXPOSURE EVALUATION REPORT	Approved by: Technical Manager
Document S/N: 1M2310260110-21.A3L	DUT Type: Portable Handset	Page 61 of 66

9 EQUIPMENT LIST

Manufacturer	Model	Description	Cal Date	Cal Interval	Cal Due	Serial Number
Anritsu	MT8000A	Radio Communication Test Station	2/9/2023	Annual	2/9/2024	6272337408
Anritsu	MT8821C	Radio Communication Test Station	1/10/2023	Annual	1/10/2024	6201524637
K & L	11SH10-1300/U4000	High Pass Filter	CBT	N/A	CBT	11SH10-1300/U4000 - 2
Keysight Technologies	772D	Dual Directional Coupler	CBT	N/A	CBT	MY52180215
Keysight Technologies	E7515B	UXM 5G Wireless Test Platform	CBT	N/A	CBT	MY59150289
Krytar	110067006	Directional Coupler, 10 - 67 GHz	CBT	N/A	CBT	200391
MCL	BW-N6W5+	6dB Attenuator	CBT	N/A	CBT	1139
Mini Circuits	ZA2PD2-63-S+	Power Splitter	CBT	N/A	CBT	SUU64901930
Mini Circuits	ZAPD-2-272-S+	Power Splitter	CBT	N/A	CBT	SF702001405
MiniCircuits	NLP-1200+	Low Pass Filter	CBT	N/A	CBT	VUU78201318
MiniCircuits	SLP-2400+	Low Pass Filter	CBT	N/A	CBT	R8979500903
MiniCircuits	VLf-6000+	Low Pass Filter	CBT	N/A	CBT	N/A
Mini-Circuits	BW-N20W5+	DC to 18 GHz Precision Fixed 20 dB Attenuator	CBT	N/A	CBT	N/A
Mini-Circuits	NLP-2950+	Low Pass Filter DC to 2700 MHz	CBT	N/A	CBT	N/A
Mini-Circuits	NLP-1200+	Low Pass Filter DC to 1000 MHz	CBT	N/A	CBT	N/A
Mini-Circuits	BW-N20W5	Power Attenuator	CBT	N/A	CBT	1226
Narda	4216-10	Directional Coupler, 0.5 to 8.0 GHz, 10 dB	CBT	N/A	CBT	01492
Narda	4216-10	Directional Coupler, 0.5 to 8.0 GHz, 10 dB	CBT	N/A	CBT	01493
Narda	4014C-6	4 - 8 GHz SMA 6 dB Directional Coupler	CBT	N/A	CBT	N/A
Newmark System	NSC-G2	Motion Controller	CBT	N/A	CBT	1007-D
Pasternack	PE2208-6	Bidirectional Coupler	CBT	N/A	CBT	N/A
Pasternack	PE2209-10	Bidirectional Coupler	CBT	N/A	CBT	N/A
Rohde & Schwarz	CMW500	Radio Communication Tester	3/8/2023	Annual	3/8/2024	128635
Rohde & Schwarz	CMW500	Radio Communication Tester	8/10/2023	Annual	8/10/2024	140144
Rohde & Schwarz	NRP85	3-Path Dipole Power Sensor	1/19/2023	Annual	1/19/2024	109961
Rohde & Schwarz	NRP85	3-Path Dipole Power Sensor	1/19/2024	Annual	1/19/2024	109960
Rohde & Schwarz	NRP50S	3-Path Dipole Power Sensor	1/19/2023	Annual	1/19/2024	101350

Notes:

1. CBT (Calibrated Before Testing). Prior to testing, the measurement paths containing a cable, amplifier, attenuator, coupler, or filter were connected to a calibrated source (i.e. a signal generator) to determine the losses of the measurement path. The power meter offset was then adjusted to compensate for the measurement system losses. This level offset is stored within the power meter before measurements are made. This calibration verification procedure applies to the system verification and output power measurements. The calibrated reading is then taken directly from the power meter after compensation of the losses for all final power measurements.
2. Each equipment item is used solely within its respective calibration period.

FCC ID: A3LSMA356E	PART 2 RF EXPOSURE EVALUATION REPORT	Approved by: Technical Manager
Document S/N: 1M2310260110-21.A3L	DUT Type: Portable Handset	Page 62 of 66

10 MEASUREMENT UNCERTAINTIES

For SAR Measurements

a	c	d	e= f(d,k)	f	g	h = c x f/e	i = c x g/e	k
Uncertainty Component	Tol. (± %)	Prob. Dist.	Div.	c ₁ 1gm	c ₁ 10 gms	1gm u ₁ (± %)	10gms u ₁ (± %)	v ₁
Measurement System								
Probe Calibration	6.55	N	1	1.0	1.0	6.6	6.6	∞
Axial Isotropy	0.25	N	1	0.7	0.7	0.2	0.2	∞
Hemishperical Isotropy	1.3	N	1	0.7	0.7	0.9	0.9	∞
Boundary Effect	2.0	R	1.73	1.0	1.0	1.2	1.2	∞
Linearity	0.3	N	1	1.0	1.0	0.3	0.3	∞
System Detection Limits	0.25	R	1.73	1.0	1.0	0.1	0.1	∞
Readout Electronics	0.3	N	1	1.0	1.0	0.3	0.3	∞
Response Time	0.8	R	1.73	1.0	1.0	0.5	0.5	∞
Integration Time	2.6	R	1.73	1.0	1.0	1.5	1.5	∞
RF Ambient Conditions - Noise	3.0	R	1.73	1.0	1.0	1.7	1.7	∞
RF Ambient Conditions - Reflections	3.0	R	1.73	1.0	1.0	1.7	1.7	∞
Probe Positioner Mechanical Tolerance	0.4	R	1.73	1.0	1.0	0.2	0.2	∞
Probe Positioning w/ respect to Phantom	6.7	R	1.73	1.0	1.0	3.9	3.9	∞
Extrapolation, Interpolation & Integration algorithms for Max. SAR Evaluation	4.0	R	1.73	1.0	1.0	2.3	2.3	∞
Test Sample Related								
Test Sample Positioning	2.7	N	1	1.0	1.0	2.7	2.7	35
Device Holder Uncertainty	1.67	N	1	1.0	1.0	1.7	1.7	5
Output Power Variation - SAR drift measurement	5.0	R	1.73	1.0	1.0	2.9	2.9	∞
SAR Scaling	0.0	R	1.73	1.0	1.0	0.0	0.0	∞
Phantom & Tissue Parameters								
Phantom Uncertainty (Shape & Thickness tolerances)	7.6	R	1.73	1.0	1.0	4.4	4.4	∞
Liquid Conductivity - measurement uncertainty	4.2	N	1	0.78	0.71	3.3	3.0	10
Liquid Permittivity - measurement uncertainty	4.1	N	1	0.23	0.26	1.0	1.1	10
Liquid Conductivity - Temperature Uncertainty	3.4	R	1.73	0.78	0.71	1.5	1.4	∞
Liquid Permittivity - Temperature Uncertainty	0.6	R	1.73	0.23	0.26	0.1	0.1	∞
Liquid Conductivity - deviation from target values	5.0	R	1.73	0.64	0.43	1.8	1.2	∞
Liquid Permittivity - deviation from target values	5.0	R	1.73	0.60	0.49	1.7	1.4	∞
Combined Standard Uncertainty (k=1)	RSS					11.5	11.3	60
Expanded Uncertainty (95% CONFIDENCE LEVEL)	k=2					23.0	22.6	

FCC ID: A3LSMA356E	PART 2 RF EXPOSURE EVALUATION REPORT	Approved by: Technical Manager
Document S/N: 1M2310260110-21.A3L	DUT Type: Portable Handset	Page 63 of 66

11 CONCLUSION

11.2 Measurement Conclusion

The SAR evaluation indicates that the DUT complies with the RF radiation exposure limits of the FCC and Innovation, Science, and Economic Development Canada, with respect to all parameters subject to this test. These measurements were taken to simulate the RF effects of RF exposure under worst-case conditions. Precise laboratory measures were taken to assure repeatability of the tests. The results and statements relate only to the item(s) tested.

Please note that the absorption and distribution of electromagnetic energy in the body are very complex phenomena that depend on the mass, shape, and size of the body, the orientation of the body with respect to the field vectors, and the electrical properties of both the body and the environment. Other variables that may play a substantial role in possible biological effects are those that characterize the environment (e.g. ambient temperature, air velocity, relative humidity, and body insulation) and those that characterize the individual (e.g. age, gender, activity level, debilitation, or disease). Because various factors may interact with one another to vary the specific biological outcome of an exposure to electromagnetic fields, any protection guide should consider maximal amplification of biological effects as a result of field-body interactions, environmental conditions, and physiological variables. [3]

FCC ID: A3LSMA356E	PART 2 RF EXPOSURE EVALUATION REPORT	Approved by: Technical Manager
Document S/N: 1M2310260110-21.A3L	DUT Type: Portable Handset	Page 64 of 66

12 REFERENCES

- [1] Federal Communications Commission, ET Docket 93-62, Guidelines for Evaluating the Environmental Effects of Radiofrequency Radiation, Aug. 1996.
- [2] ANSI/IEEE C95.1-2005, American National Standard safety levels with respect to human exposure to radio frequency electromagnetic fields, 3kHz to 300GHz, New York: IEEE, 2006.
- [3] ANSI/IEEE C95.1-1992, American National Standard safety levels with respect to human exposure to radio frequency electromagnetic fields, 3kHz to 300GHz, New York: IEEE, Sept. 1992.
- [4] ANSI/IEEE C95.3-2002, IEEE Recommended Practice for the Measurement of Potentially Hazardous Electromagnetic Fields - RF and Microwave, New York: IEEE, December 2002.
- [5] IEEE Standards Coordinating Committee 39 –Standards Coordinating Committee 34 – IEEE Std. 1528-3013, IEEE Recommended Practice for Determining the Peak Spatial-Average Specific Absorption Rate (SAR) in the Human Head from Wireless Communications Devices: Measurement Techniques.
- [6] NCRP, National Council on Radiation Protection and Measurements, Biological Effects and Exposure Criteria for RadioFrequency Electromagnetic Fields, NCRP Report No. 86, 1986. Reprinted Feb. 1995.
- [7] T. Schmid, O. Egger, N. Kuster, Automated E-field scanning system for dosimetric assessments, IEEE Transaction on Microwave Theory and Techniques, vol. 44, Jan. 1996, pp. 105-113.
- [8] K. Pokovic, T. Schmid, N. Kuster, Robust setup for precise calibration of E-field probes in tissue simulating liquids at mobile communications frequencies, ICECOM97, Oct. 1997, pp. 1 -124.
- [9] K. Pokovic, T. Schmid, and N. Kuster, E-field Probe with improved isotropy in brain simulating liquids, Proceedings of the ELMAR, Zadar, Croatia, June 23-25, 1996, pp. 172-175.
- [10] Schmid & Partner Engineering AG, Application Note: Data Storage and Evaluation, June 1998, p2.
- [11] V. Hombach, K. Meier, M. Burkhardt, E. Kuhn, N. Kuster, The Dependence of EM Energy Absorption upon Human Modeling at 900 MHz, IEEE Transaction on Microwave Theory and Techniques, vol. 44 no. 10, Oct. 1996, pp. 1865-1873.
- [12] N. Kuster and Q. Balzano, Energy absorption mechanism by biological bodies in the near field of dipole antennas above 300MHz, IEEE Transaction on Vehicular Technology, vol. 41, no. 1, Feb. 1992, pp. 17-23.
- [13] G. Hartsgrrove, A. Kraszewski, A. Surowiec, Simulated Biological Materials for Electromagnetic Radiation Absorption Studies, University of Ottawa, Bioelectromagnetics, Canada: 1987, pp. 29-36.
- [14] Q. Balzano, O. Garay, T. Manning Jr., Electromagnetic Energy Exposure of Simulated Users of Portable Cellular Telephones, IEEE Transactions on Vehicular Technology, vol. 44, no.3, Aug. 1995.
- [15] W. Gander, Computermathematick, Birkhaeuser, Basel, 1992.
- [16] W.H. Press, S.A. Teukolsky, W.T. Vetterling, and B.P. Flannery, Numerical Recipes in C, The Art of Scientific Computing, Second edition, Cambridge University Press, 1992.

FCC ID: A3LSMA356E	PART 2 RF EXPOSURE EVALUATION REPORT	Approved by: Technical Manager
Document S/N: 1M2310260110-21.A3L	DUT Type: Portable Handset	Page 65 of 66

- [17] N. Kuster, R. Kastle, T. Schmid, Dosimetric evaluation of mobile communications equipment with known precision, IEEE Transaction on Communications, vol. E80-B, no. 5, May 1997, pp. 645-652.
- [18] CENELEC CLC/SC111B, European Prestandard (prENV 50166-2), Human Exposure to Electromagnetic Fields High-frequency: 10kHz-300GHz, Jan. 1995.
- [19] Prof. Dr. Niels Kuster, ETH, Eidgenössische Technische Hochschule Zürich, Dosimetric Evaluation of the Cellular Phone.
- [20] IEC 62209-1, Measurement procedure for the assessment of specific absorption rate of human exposure to radio frequency fields from hand-held and body-mounted wireless communication devices - Part 1: Devices used next to the ear (Frequency range of 300 MHz to 6 GHz), July 2016.
- [21] Innovation, Science, Economic Development Canada RSS-102 Radio Frequency Exposure Compliance of Radiocommunication Apparatus (All Frequency Bands) Issue 5, March 2015.
- [22] Health Canada Safety Code 6 Limits of Human Exposure to Radio Frequency Electromagnetic Fields in the Frequency Range from 3 kHz – 300 GHz, 2015
- [23] FCC SAR Test Procedures for 2G-3G Devices, Mobile Hotspot and UMPC Devices KDB Publications 941225, D01-D07
- [24] SAR Measurement Guidance for IEEE 802.11 Transmitters, KDB Publication 248227 D01
- [25] FCC SAR Considerations for Handsets with Multiple Transmitters and Antennas, KDB Publications 648474 D03-D04
- [26] FCC SAR Evaluation Considerations for Laptop, Notebook, Netbook and Tablet Computers, FCC KDB Publication 616217 D04
- [27] FCC SAR Measurement and Reporting Requirements for 100MHz – 6 GHz, KDB Publications 865664 D01-D02
- [28] FCC General RF Exposure Guidance and SAR Procedures for Dongles, KDB Publication 447498, D01-D02
- [29] Anexo à Resolução No. 533, de 10 de Setembro de 2009.
- [30] IEC 62209-2, Human exposure to radio frequency fields from hand-held and body-mounted wireless communication devices - Human models, instrumentation, and procedures - Part 2: Procedure to determine the specific absorption rate (SAR) for wireless communication devices used in close proximity to the human body (frequency range of 30 MHz to 6 GHz), Mar. 2010.

FCC ID: A3LSMA356E	PART 2 RF EXPOSURE EVALUATION REPORT	Approved by: Technical Manager
Document S/N: 1M2310260110-21.A3L	DUT Type: Portable Handset	Page 66 of 66