



CERTIFICATION TEST REPORT

Report Number. : 12678288-E3V1

Applicant : Samsung Electronics Co., Ltd.
129 Samsung-Ro, Yeongtong-Gu,
Suwon-Si, Gyeonggi-Do, 16677, Korea

Models : SM-A305GT/DS

FCC ID : A3LSMA305GT

EUT Description : GSM/WCDMA/LTE Phone with BT, DTS/UNII a/b/g/n/ac, and ANT+

Test Standard(s) : FCC 47 CFR PART 15 SUBPART C

Date Of Issue:
February 20, 2019

Prepared by:
UL Verification Services Inc.
47173 Benicia Street
Fremont, CA 94538 U.S.A.
TEL: (510) 771-1000
FAX: (510) 661-0888



NVLAP Lab code: 200065-0

REPORT REVISION HISTORY

Rev.	Issue Date	Revisions	Revised By
V1	2/20/2019	Initial Issue	

TABLE OF CONTENTS

REPORT REVISION HISTORY	2
TABLE OF CONTENTS	3
1. ATTESTATION OF TEST RESULTS	5
2. INTRODUCTION OF TEST DATA REUSE.....	6
2.1. INTRODUCTION	6
2.2. SPOT CHECK VERIFICATION RESULTS SUMMARY.....	6
2.3. REFERENCE DETAIL	11
3. TEST METHODOLOGY	12
4. FACILITIES AND ACCREDITATION	12
5. CALIBRATION AND UNCERTAINTY	13
5.1. MEASURING INSTRUMENT CALIBRATION	13
5.2. SAMPLE CALCULATION	13
5.3. MEASUREMENT UNCERTAINTY.....	13
6. EQUIPMENT UNDER TEST	14
6.1. EUT DESCRIPTION	14
6.2. MAXIMUM OUTPUT POWER.....	14
6.3. DESCRIPTION OF AVAILABLE ANTENNAS	14
6.4. SOFTWARE AND FIRMWARE.....	14
6.5. WORST-CASE CONFIGURATION AND MODE.....	14
6.6. DESCRIPTION OF TEST SETUP.....	15
7. MEASUREMENT METHOD.....	18
8. TEST AND MEASUREMENT EQUIPMENT	19
9. ANTENNA PORT TEST RESULTS	20
9.1. ON TIME AND DUTY CYCLE.....	20
9.2. 99% BANDWIDTH.....	21
9.2.1. 1Mbps.....	22
9.2.2. 2Mbps.....	23
9.3. 6 dB BANDWIDTH.....	24
9.3.1. 1Mbps.....	25
9.3.2. 2Mbps.....	26
9.4. OUTPUT POWER.....	27
9.4.1. 1Mbps.....	27
9.4.2. 2Mbps.....	27

9.5.	AVERAGE POWER.....	28
9.5.1.	1Mbps.....	28
9.5.2.	2Mbps.....	28
9.6.	POWER SPECTRAL DENSITY.....	29
9.6.1.	1Mbps.....	30
9.6.2.	2Mbps.....	31
9.7.	CONDUCTED SPURIOUS EMISSIONS.....	32
9.7.1.	1Mbps.....	33
9.7.2.	2Mbps.....	34
10.	RADIATED TEST RESULTS	35
10.1.	LIMITS AND PROCEDURE.....	35
10.2.	TRANSMITTER ABOVE 1 GHz.....	37
10.2.1.	1Mbps	37
10.2.1.	2Mbps	47
10.3.	Worst Case Below 30MHz.....	57
10.4.	Worst Case Below 1 GHz.....	59
10.5.	Worst Case 18-26 GHz	61
11.	AC POWER LINE CONDUCTED EMISSIONS	63
12.	SETUP PHOTOS	66
12.1.	A3LSMA305F (Original)	66
12.2.	A3LSMA305GT (Spot Check).....	69

1.

2.

3. ATTESTATION OF TEST RESULTS

COMPANY NAME: Samsung Electronics Co., Ltd.
129 Samsung-Ro, Yeongtong-Gu,
Suwon-Si, Gyeonggi-Do, 16677, Korea

EUT DESCRIPTION: GSM/WCDMA/LTE Phone with BT, DTS/UNII a/b/g/n/ac, and ANT+

MODEL: SM-A305GT/DS

SERIAL NUMBER: R38KC08WHJE (Conducted Original)
R38KC08WJSN, R38KC08WKGY (Radiated Original)
R38M103M9KN (Radiated Spot Check)

DATE TESTED: JANUARY 11 - FEBRUARY 7, 2019 (Original)
FEBRUARY 7 - 8, 2019 (Spot Check)

APPLICABLE STANDARDS	
STANDARD	TEST RESULTS
CFR 47 Part 15 Subpart C	Complies

UL Verification Services Inc. tested the above equipment in accordance with the requirements set forth in the above standards. The test results show that the equipment tested is capable of demonstrating compliance with the requirements as documented in this report.

The results documented in this report apply only to the tested sample, under the conditions and modes of operation as described herein. It is the manufacturer's responsibility to assure that additional production units of this model are manufactured with identical electrical and mechanical components. All samples tested were in good operating condition throughout the entire test program. Measurement Uncertainties are published for informational purposes only and were not taken into account unless noted otherwise.

This document may not be altered or revised in any way unless done so by UL Verification Services Inc. and all revisions are duly noted in the revisions section. Any alteration of this document not carried out by UL Verification Services Inc. will constitute fraud and shall nullify the document. This report must not be used by the client to claim product certification, approval, or endorsement by NVLAP, NIST, any agency of the Federal Government, or any agency of the U.S. government.

Approved & Released For
UL Verification Services Inc. By:



DAN CORONIA
Operations Leader
Consumer Technology Division
UL Verification Services Inc.

Reviewed By:



KIYA KEDIDA
Senior Project Engineer
Consumer Technology Division
UL Verification Services Inc.

4. INTRODUCTION OF TEST DATA REUSE

4.1. INTRODUCTION

According to the manufacturer, FCC ID: A3LSMA305F and FCC ID: A3LSMA305GT non-licensed radios are electrically identical. The FCC ID: A3LSMA305F test data shall remain representative of FCC ID: A3LSMA305GT.

The applicant takes full responsibility that the test data as referenced in this section represents compliance for this FCC ID.

4.2. SPOT CHECK VERIFICATION RESULTS SUMMARY

Spot check verification has been done on device A3LSMA305GT for radiated harmonic spurious and radiated band-edge. The data from the application has been verified through appropriate spot checks to demonstrate compliance for this device in accordance to FCC public KDB 484596 D01 as shown in the summary below.

A3LSMA305GT SPOT CHECK RESULTS												
Technology	Data Rate	Test Item	Channel	Measured Frequency	Original model		Spot check model		Delta (dB)			
					SM-A305F/DS		SM-A305GT/DS		Peak		Ave	
					A3LSMA305F		A3LSMA305GT					
Peak	Ave	Peak	Ave	Peak	Ave	Peak	Ave					
BLE	2Mbps	RBE	39	2484MHz	60.14	45.25	50.94	44.25	-9.2	-1.2		
	1Mbps	RSE	0	1327MHz	45.74	37.71	44.49	36.99	-1.25	-0.72		

Comparison of the models, upper deviation is within 3dB range and all tests are under FCC Technical Limits.

SPOT CHECK DATA

BANDEDGE (HIGH CHANNEL) – 2Mbps

HORIZONTAL RESULT

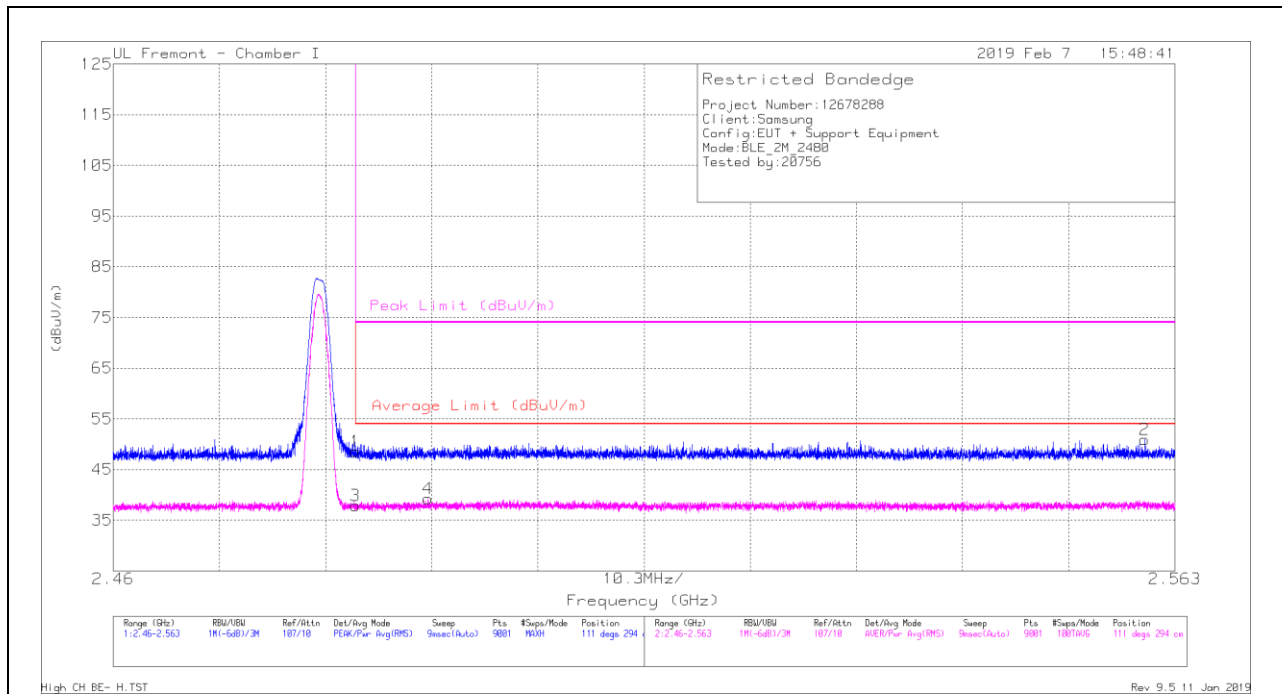

Trace Markers

Marker	Frequency (GHz)	Meter Reading (dBuV)	Det	AF T862 (dB/m)	Amp/Cb/Ftr/Pad (dB)	DC Corr (dB)	Corrected Reading (dBuV/m)	Average Limit (dBuV/m)	Margin (dB)	Peak Limit (dBuV/m)	PK Margin (dB)	Azimuth (Degs)	Height (cm)	Polarity
1	* 2.484	37.84	Pk	32.4	-21.7	0	48.54	-	-	74	-25.46	111	294	H
2	2.56	40.14	Pk	32.4	-21.6	0	50.94	-	-	74	-23.06	111	294	H
3	* 2.484	27.14	RMS	32.4	-21.7	5.04	42.88	54	-11.12	-	-	111	294	H
4	* 2.491	28.41	RMS	32.5	-21.7	5.04	44.25	54	-9.75	-	-	111	294	H

* - indicates frequency in CFR47 Pt 15 / IC RSS-Restricted Band
 Pk - Peak detector
 RMS - RMS detection

VERTICAL RESULT

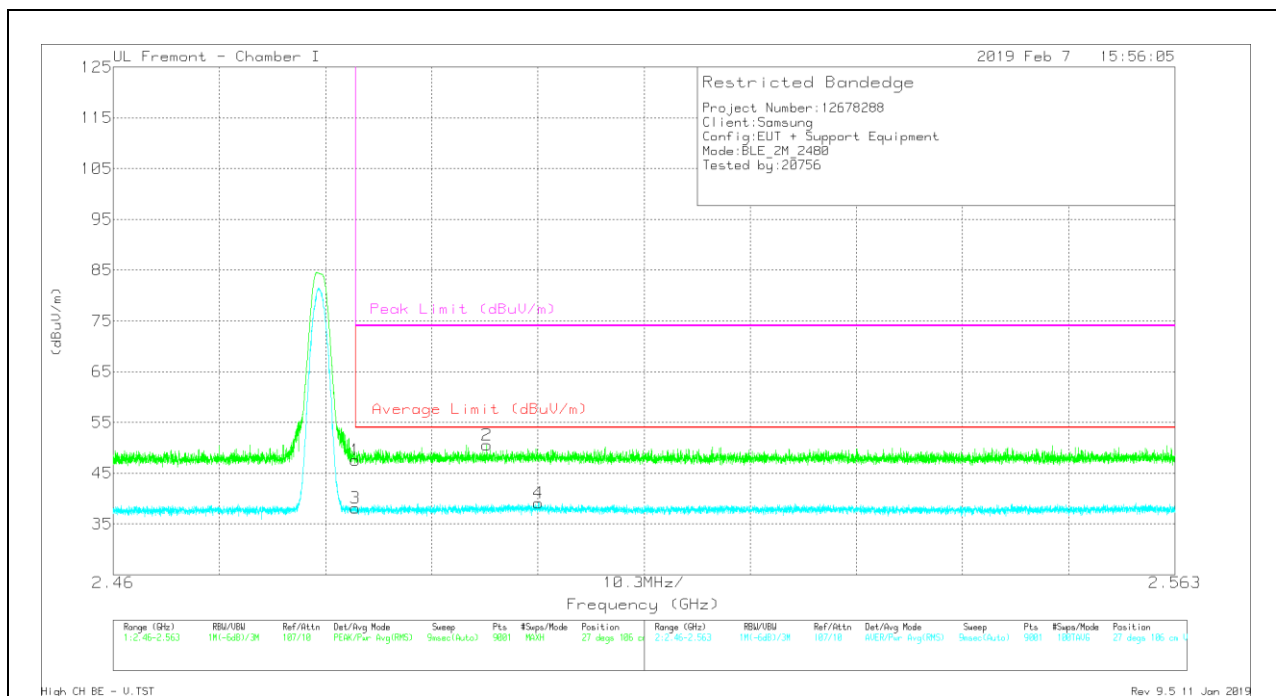

Trace Markers

Marker	Frequency (GHz)	Meter Reading (dBuV)	Det	AF T862 (dB/m)	Amp/Cb/Ftr/Pad (dB)	DC Corr (dB)	Corrected Reading (dBuV/m)	Average Limit (dBuV/m)	Margin (dB)	Peak Limit (dBuV/m)	PK Margin (dB)	Azimuth (Degs)	Height (cm)	Polarity
1	* 2.484	36.84	Pk	32.4	-21.7	0	47.54	-	-	74	-26.46	27	106	V
2	* 2.496	39.86	Pk	32.5	-21.8	0	50.56	-	-	74	-23.44	27	106	V
3	* 2.484	27.4	RMS	32.4	-21.7	5.04	43.14	54	-10.86	-	-	27	106	V
4	2.501	28.37	RMS	32.5	-21.7	5.04	44.21	54	-9.79	-	-	27	106	V

* - indicates frequency in CFR47 Pt 15 / IC RSS-Restricted Band

Pk - Peak detector

RMS - RMS detection

HARMONICS AND SPURIOUS EMISSIONS – 1Mbps

LOW CHANNEL RESULTS

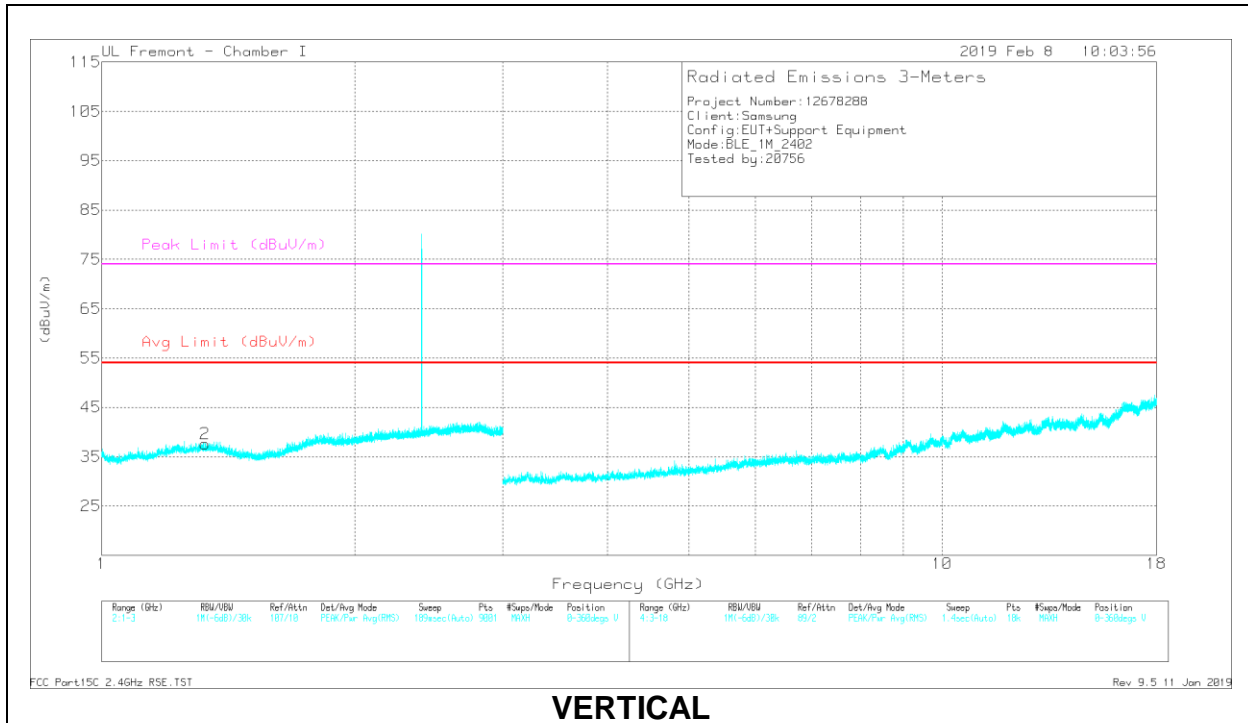
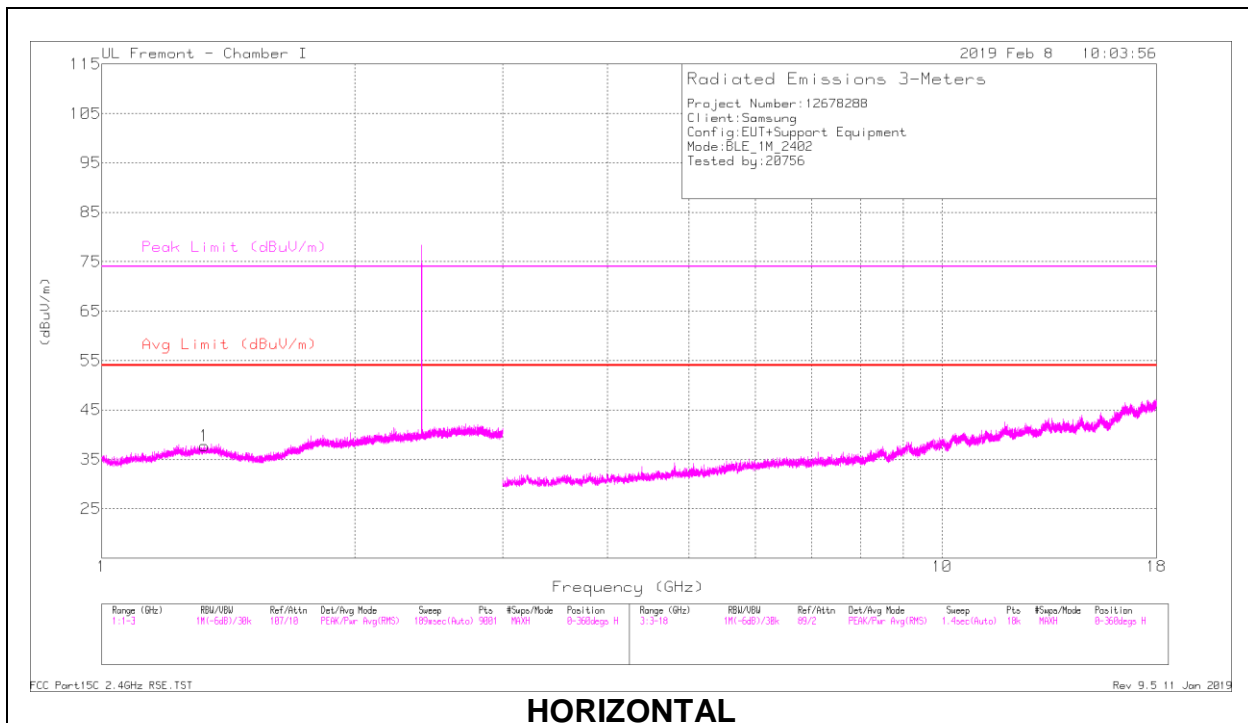

RADIATED EMISSIONS

Marker	Frequency (GHz)	Meter Reading (dBuV)	Det	AF T862 (dB/m)	Amp/Cb/Filtr/Pad (dB)	DC Corr (dB)	Corrected Reading (dBuV/m)	Avg Limit (dBuV/m)	Margin (dB)	Peak Limit (dBuV/m)	PK Margin (dB)	Azimuth (Degs)	Height (cm)	Polarity
1	* 1.323	38.09	PK2	29.4	-23	0	44.49	-	-	74	-29.51	84	383	H
	* 1.326	28.57	MAv1	29.3	-23	2.12	36.99	54	-17.01	-	-	84	383	H
2	* 1.325	39.79	PK2	29.4	-23	0	46.19	-	-	74	-27.81	37	354	V
	* 1.326	28.46	MAv1	29.3	-23	2.12	36.88	54	-17.12	-	-	37	354	V

* - indicates frequency in CFR47 Pt 15 / IC RSS-Restricted Band

Pk - Peak detector

Av - Average detection

4.3. REFERENCE DETAIL

Reference application that contains the reused reference data

Equipment Class	Reference FCC ID	Type Grant/ Permissive Change	Reference Application	Folder Test/RF Exposure	Report Title/Section
DTS	A3LSMA305F	Grant	12678282-E3	Test	FCC Report BLE / All sections

5. TEST METHODOLOGY

The tests documented in this report were performed in accordance with FCC CFR 47 Part 2, FCC CFR 47 Part 15, ANSI C63.10-2013, KDB 558074 D01 15.247 Meas Guidance v05.

6. FACILITIES AND ACCREDITATION

The test sites and measurement facilities used to collect data are located at 47173 and 47266 Benicia Street, and 47658 Kato Road, Fremont, California, USA. Line conducted emissions are measured only at the 47173 address. The following table identifies which facilities were utilized for radiated emission measurements documented in this report. Specific facilities are also identified in the test results sections.

47173 Benicia Street	47266 Benicia Street	47658 Kato Rd
<input type="checkbox"/> Chamber A (ISED:2324B-1)	<input type="checkbox"/> Chamber D (ISED:22541-1)	<input type="checkbox"/> Chamber I (ISED:2324A-5)
<input checked="" type="checkbox"/> Chamber B (ISED:2324B-2)	<input type="checkbox"/> Chamber E (ISED:22541-2)	<input checked="" type="checkbox"/> Chamber J (ISED:2324A-6)
<input type="checkbox"/> Chamber C (ISED:2324B-3)	<input type="checkbox"/> Chamber F (ISED:22541-3)	<input type="checkbox"/> Chamber K (ISED:2324A-1)
	<input type="checkbox"/> Chamber G (ISED:22541-4)	<input checked="" type="checkbox"/> Chamber L (ISED:2324A-3)
	<input type="checkbox"/> Chamber H (ISED:22541-5)	

The above test sites and facilities are covered under FCC Test Firm Registration # 208313. Chambers above are covered under Industry Canada company address and respective code

UL Verification Services Inc. is accredited by NVLAP, Laboratory Code 200065-0

7. CALIBRATION AND UNCERTAINTY

7.1. MEASURING INSTRUMENT CALIBRATION

The measuring equipment utilized to perform the tests documented in this report has been calibrated in accordance with the manufacturer's recommendations, and is traceable to recognized national standards.

7.2. SAMPLE CALCULATION

RADIATED EMISSIONS

Where relevant, the following sample calculation is provided:

Field Strength (dBuV/m) = Measured Voltage (dBuV) + Antenna Factor (dB/m) + Cable Loss (dB) – Preamp Gain (dB)

$$36.5 \text{ dBuV} + 18.7 \text{ dB/m} + 0.6 \text{ dB} - 26.9 \text{ dB} = 28.9 \text{ dBuV/m}$$

MAINS CONDUCTED EMISSIONS

Where relevant, the following sample calculation is provided:

Final Voltage (dBuV) = Measured Voltage (dBuV) + Cable Loss (dB) + Limiter Factor (dB) + LISN Insertion Loss.

$$36.5 \text{ dBuV} + 0 \text{ dB} + 10.1 \text{ dB} + 0 \text{ dB} = 46.6 \text{ dBuV}$$

7.3. MEASUREMENT UNCERTAINTY

Where relevant, the following measurement uncertainty levels have been estimated for tests performed on the apparatus:

PARAMETER	UNCERTAINTY
Worst Case Conducted Disturbance, 9KHz to 0.15 MHz	3.84 dB
Worst Case Conducted Disturbance, 0.15 to 30 MHz	3.65 dB
Worst Case Radiated Disturbance, 9KHz to 30 MHz	3.15 dB
Worst Case Radiated Disturbance, 30 to 1000 MHz	5.36 dB
Worst Case Radiated Disturbance, 1000 to 18000 MHz	4.32 dB
Worst Case Radiated Disturbance, 18000 to 26000 MHz	4.45 dB
Worst Case Radiated Disturbance, 26000 to 40000 MHz	5.24 dB

Uncertainty figures are valid to a confidence level of 95%.

8. EQUIPMENT UNDER TEST

8.1. EUT DESCRIPTION

The EUT is a GSM/WCDMA/LTE Phone with BT, DTS/UNII a/b/g/n/ac, and ANT+. The test report addresses the BLE operational mode.

8.2. MAXIMUM OUTPUT POWER

The transmitter has a maximum peak conducted output power as follows:

Frequency Range	Mode	Output Power (dBm)	Output Power (mW)
2402 - 2480	BLE (1Mbps)	6.09	4.06
2402 - 2480	BLE (2Mbps)	6.49	4.46

8.3. DESCRIPTION OF AVAILABLE ANTENNAS

The radio utilizes an FPCB antenna, with a maximum gain of -2.9 dBi.

8.4. SOFTWARE AND FIRMWARE

The test utility software used during testing was A305F.001

8.5. WORST-CASE CONFIGURATION AND MODE

Radiated emissions below 1GHz, above 18GHz, and power line conducted emission were performed with the EUT set to transmit at the channel with highest output power as worst-case scenario.

Band edge and radiated emissions between 1GHz and 18GHz were performed with the EUT set to transmit at the highest power on low, middle and high channels.

The fundamental of the EUT was investigated in three orthogonal orientations X,Y,Z, it was determined that X orientation was worst-case orientation; therefore, all final radiated testing was performed with the EUT in X orientation.

Worst-case data rates as provided by the client were 1Mbps and 2Mbps.

8.6. DESCRIPTION OF TEST SETUP

SUPPORT EQUIPMENT

Support Equipment List				
Description	Manufacturer	Model	Serial Number	FCC ID
AC Adapter	Samsung	EP-TA50EWE	DW3J719AS/A-E	N/A
Earphone	Samsung	N/A	N/A	N/A

I/O CABLES (CONDUCTED TEST)

I/O Cable List						
Cable No	Port	# of identical ports	Connector Type	Cable Type	Cable Length (m)	Remarks
1	Antenna	1	RF	Shielded	0.2	To spectrum Analyzer
2	USB	1	USB	Un-shielded	1	EUT to AC Mains

I/O CABLES (RADIATED AND CONDUCTED EMISSIONS)

I/O Cable List						
Cable No	Port	# of identical ports	Connector Type	Cable Type	Cable Length (m)	Remarks
1	USB	1	USB	Shielded	1	N/A
2	Earphone	1	3.5mm	Un-shielded	1	N/A

TEST SETUP

The EUT is a stand alone unit. Test software exercised the radio card.

CONDUCTED TEST SETUP DIAGRAM

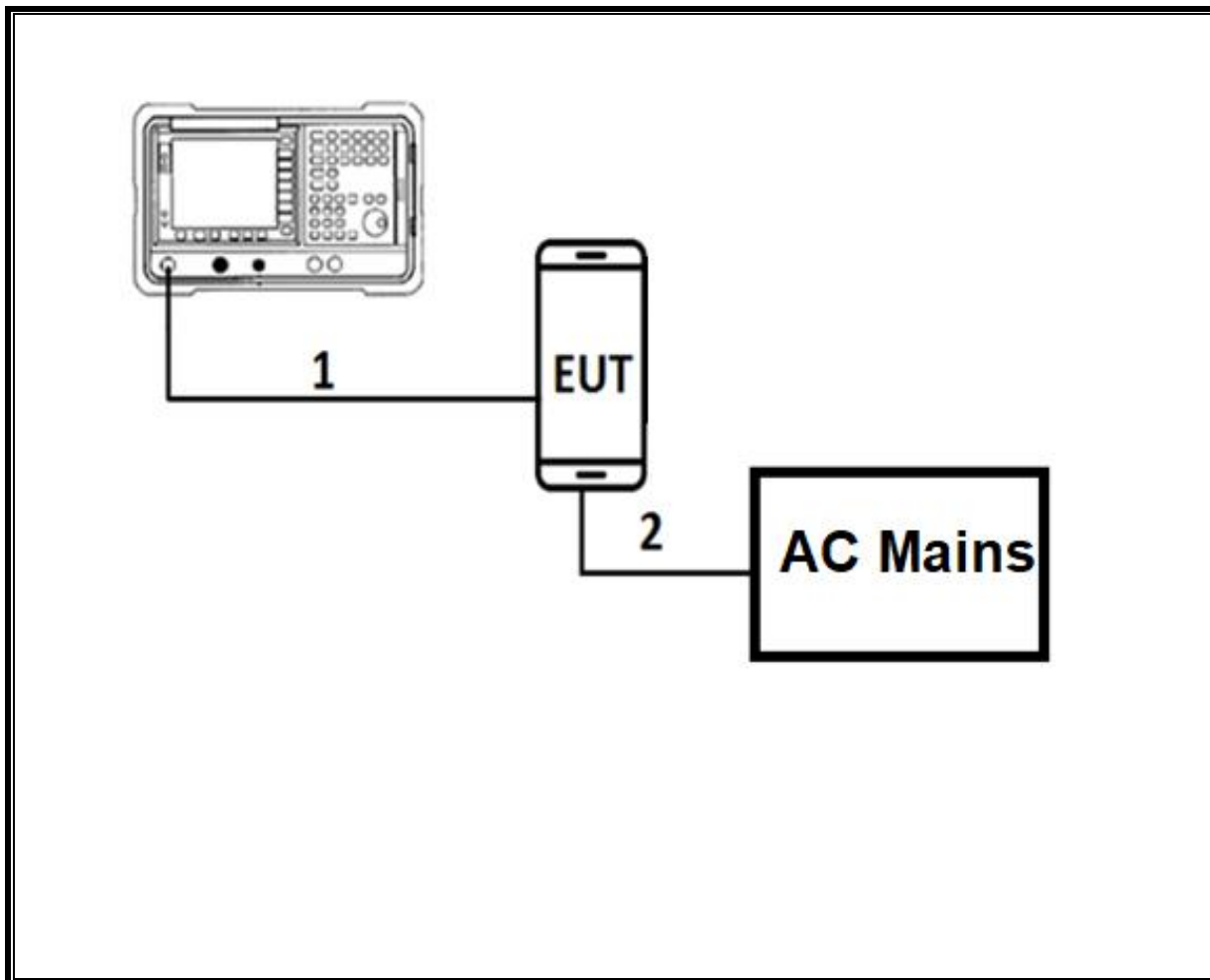

TEST SETUP

For conducted tests: the EUT was stand alone. The test software exercises the radio.

RADIATED AND AC LINE CONDUCTED EMISSIONS SETUP DIAGRAM

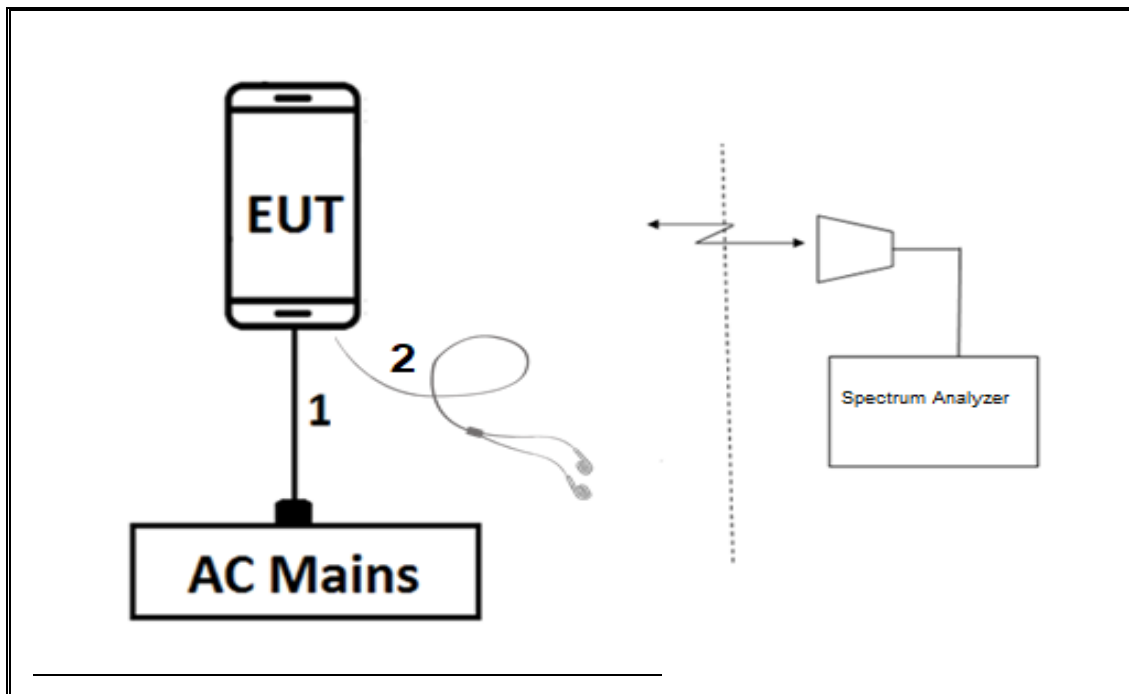

TEST SETUP

For radiated tests, the EUT is stand alone unit and the test software exercises the radio.

9. MEASUREMENT METHOD

On Time and Duty Cycle: KDB 558074 D01 v05, Section 6.

6 dB BW: ANSI C63.10 Subclause -11.8.1

Occupied BW (99%): ANSI C63.10-2013 Section 6.9.3

Output Power: ANSI C63.10 Subclause-11.9.1.3 PKPM1 Peak power meter method

Average Power: ANSI C63.10 Subclause -11.9.2.3.2 Method AVGPM-G (Measurement using a gated RF average-reading power meter)

PSD: ANSI C63.10 Subclause -11.10.2 Method PKPSD (peak PSD)

Band-edge: ANSI C63.10 Subclause -11.13.3.4 Trace averaging across ON and OFF times of the EUT transmissions followed by duty cycle correction factor

Radiated emissions non-restricted frequency bands: ANSI C63.10 Subclause -11.11

Radiated emissions restricted frequency bands: ANSI C63.10 Subclause -11.12.1

Radiated Spurious Emissions Below 30MHz: ANSI C63.10-2013 Section 6.4

Conducted emissions in restricted frequency bands: ANSI C63.10 Subclause -11.12.

AC Power Line Conducted Emissions: ANSI C63.10-2013, Section 6.2.

10. TEST AND MEASUREMENT EQUIPMENT

The following test and measurement equipment was utilized for the tests documented in this report:

TEST EQUIPMENT LIST				
Description	Manufacturer	Model	Asset	Cal Due
Antenna, Passive Loop 9KHz to 1MHz	ELETRO METRICS	EM-6871	PRE0179465	05/22/2019
Antenna, Passive Loop 9KHz to 1MHz	ELETRO METRICS	EM-6872	PRE0179467	05/22/2019
Amplifier, 10KHz to 1GHz, 32dB	SONOMA INSTRUMENT	310	PRE0180175	07/09/2019
Antenna, Horn 1-18GHz	ETS Lindgren	3117	T862	05/24/2019
Antenna, Horn 1-18GHz	ETS Lindgren	3117	T863	06/21/2019
Amplifier, 1 to 18GHz	MITEQ	AFS42-00101800-25-S-42	PRE1782151	08/01/2019
Amplifier, 1 to 18GHz	MITEQ	AFS42-00101800-25-S-42	T493	10/13/2019
Antenna, Horn 1-18GHz	ETS Lindgren	3117	AT0067	03/06/2019
Amplifier, 1 to 18GHz	Amplical	AMP1G18-35	T1571	07/30/2019
Antenna, Broadband Hybrid, 30MHz to 2000MHz	Sunol Sciences	JB1	PRE0181575	08/01/2019
Amplifier, 10KHz to 1GHz, 32dB	SONOMA INSTRUMENT	310	PRE0180174	05/31/2019
Spectrum Analyzer, PXA, 3Hz to 44GHz	Keysight	E4446A	T146	08/13/2019
Spectrum Analyzer, PXA, 3Hz to 44GHz	Agilent	N9030A	T1454	01/23/2020
Antenna Horn, 18 to 26.5GHz	ARA	MWH-1826/B	T448	03/13/2019
Pre-Amp 1-26.5 GHz	Agilent	8449B	T404	03/09/2019
EMI Test Receiver	Rohde&Schwarz	ESW44	PRE0179367	04/28/2019
EMI Test Receiver	Rohde&Schwarz	ESW44	PRE0179375	05/08/2019
EMI Test Receiver	Rohde&Schwarz	ESW44	PRE0179376	05/08/2019
EMI Test Receiver	Rohde&Schwarz	ESW44	PRE0179377	11/02/2019
Power Meter, P-series single channel	Agilent (Keysight) Technologies	N1911A	T1271	07/17/2019
Power Sensor, P-series, 50MHz to 18GHz, Wideband	Agilent (Keysight) Technologies	N1921A	T1225	04/10/2019
AC Line Conducted				
EMI Receiver	Rohde & Schwarz	ESR	T1436	02/21/2019
LISN for Conducted Emissions CISPR-16	FCC INC.	FCC LISN 50/250	T1310	06/15/2019
UL AUTOMATION SOFTWARE				
Radiated Software	UL	UL EMC	Ver 9.5, June 22, 2018	
Antenna Port Software	UL	UL RF	Ver 8.8.1, Sep 26, 2018	
AC Line Conducted Software	UL	UL EMC	Ver 9.5, May 26, 2015	

NOTES:

1. Equipment listed above that calibrated during the testing period was set for test after the calibration.
2. Equipment listed above that has a calibration due date during the testing period, the testing is completed before equipment expiration date.

11. ANTENNA PORT TEST RESULTS

11.1. ON TIME AND DUTY CYCLE

LIMITS

None; for reporting purposes only.

ON TIME AND DUTY CYCLE RESULTS

Mode	ON Time B (msec)	Period (msec)	Duty Cycle x (linear)	Duty Cycle (%)	Duty Cycle Correction Factor (dB)	1/B Minimum VBW (kHz)
BLE (1Mbps)	0.387	0.630	0.614	61.38%	2.12	2.586
BLE (2Mbps)	0.196	0.625	0.314	31.36%	5.04	5.102

DUTY CYCLE PLOTS

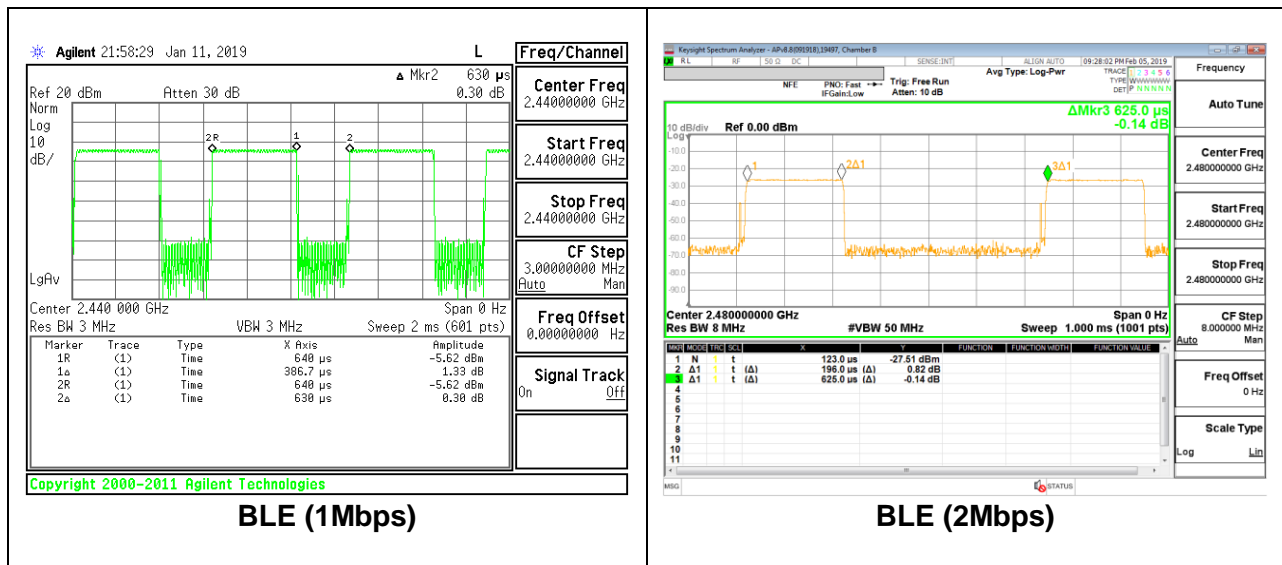

11.2. 99% BANDWIDTH

LIMITS

None; for reporting purposes only.

RESULTS

11.2.1. 1Mbps

Channel	Frequency (MHz)	99% Bandwidth (MHz)
Low	2402	1.0584
Middle	2440	1.0641
High	2480	1.0530

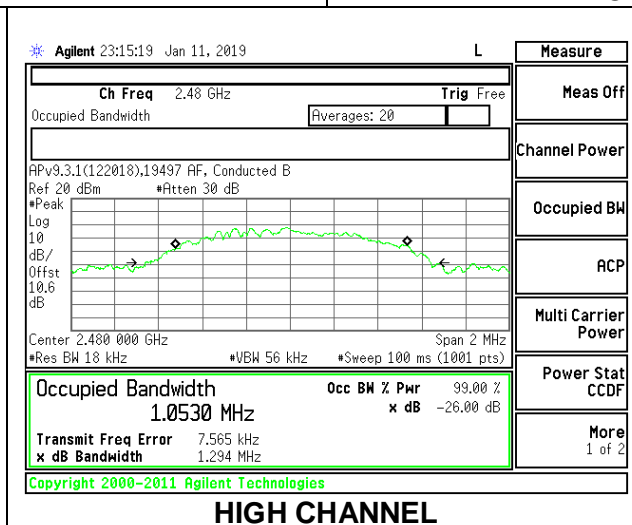
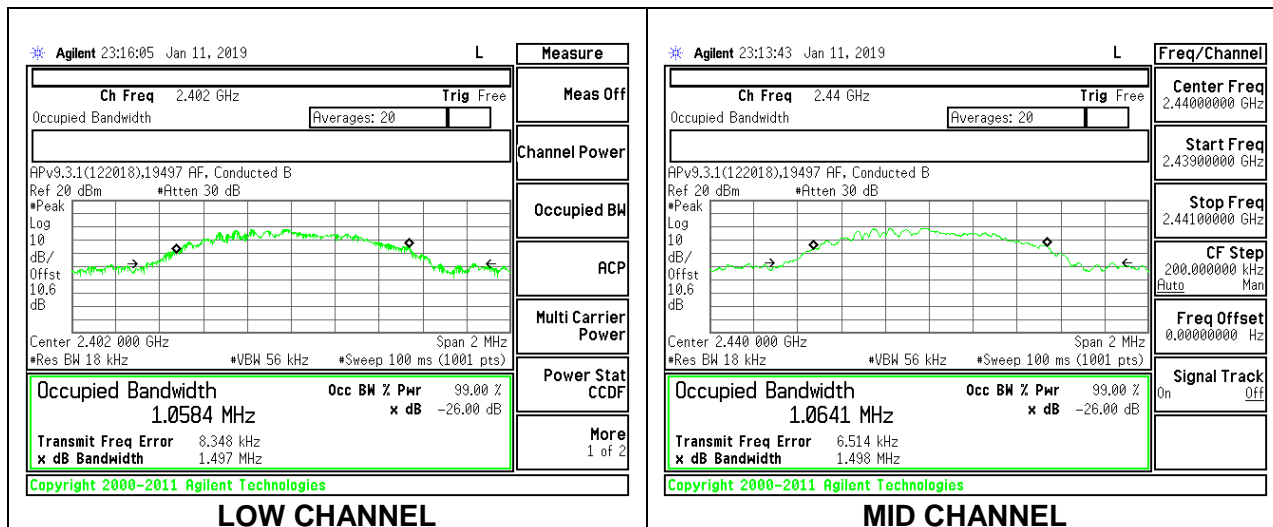

11.2.2. 2Mbps

Channel	Frequency (MHz)	99% Bandwidth (MHz)
Low	2402	2.0575
Middle	2440	2.0590
High	2480	2.0553

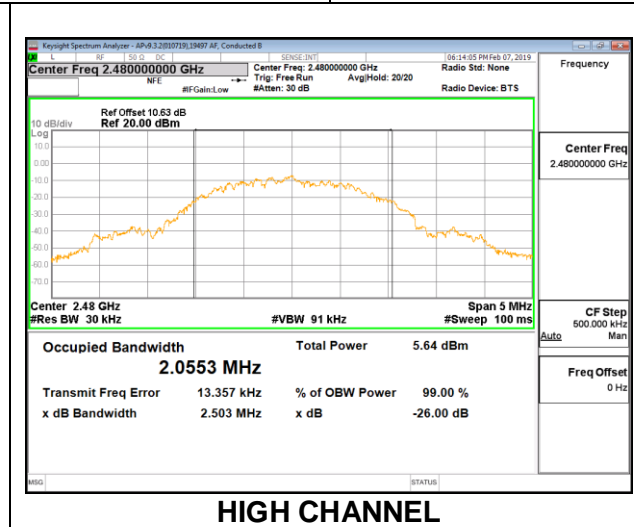
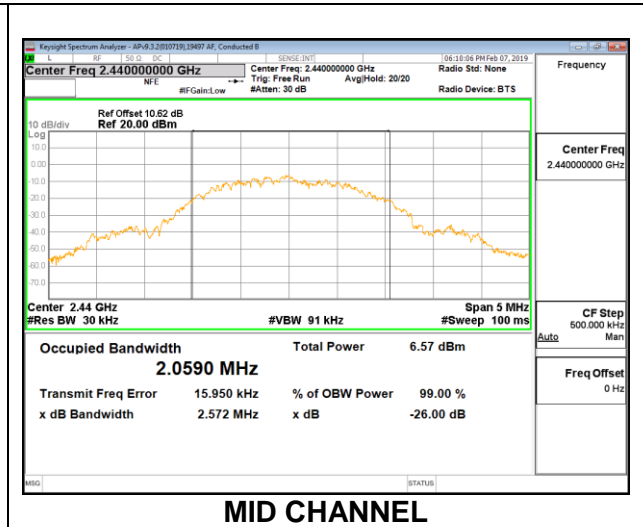
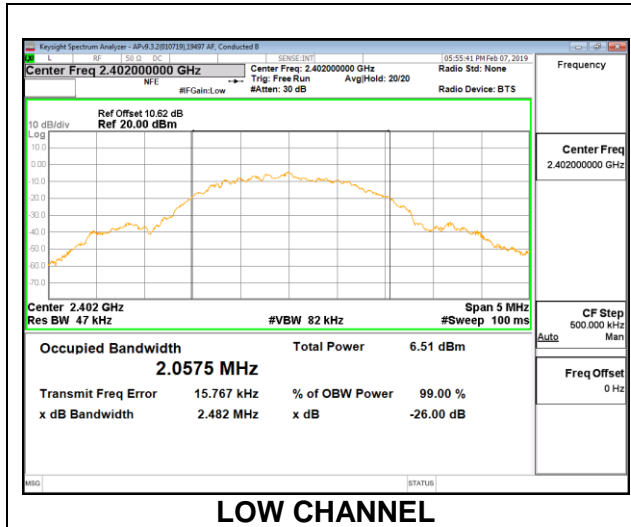

11.3. 6 dB BANDWIDTH

LIMITS

FCC §15.407 (e)

The minimum 6 dB bandwidth shall be at least 500 kHz.

RESULTS

11.3.1. 1Mbps

Channel	Frequency (MHz)	6 dB Bandwidth (MHz)	Minimum Limit (MHz)
Low	2402	0.717	0.5
Middle	2440	0.726	0.5
High	2480	0.720	0.5

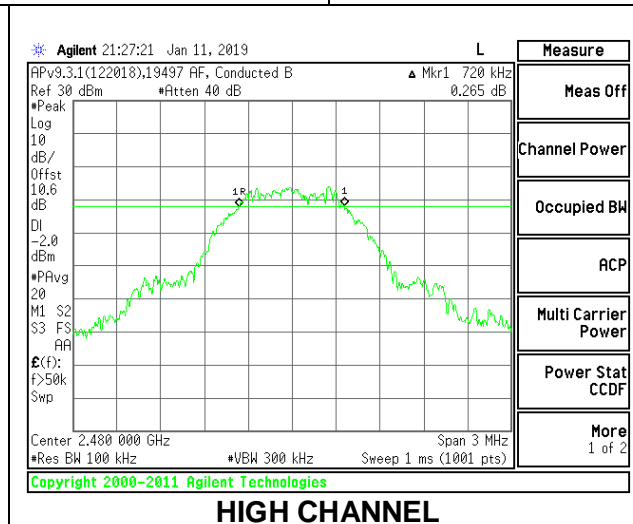
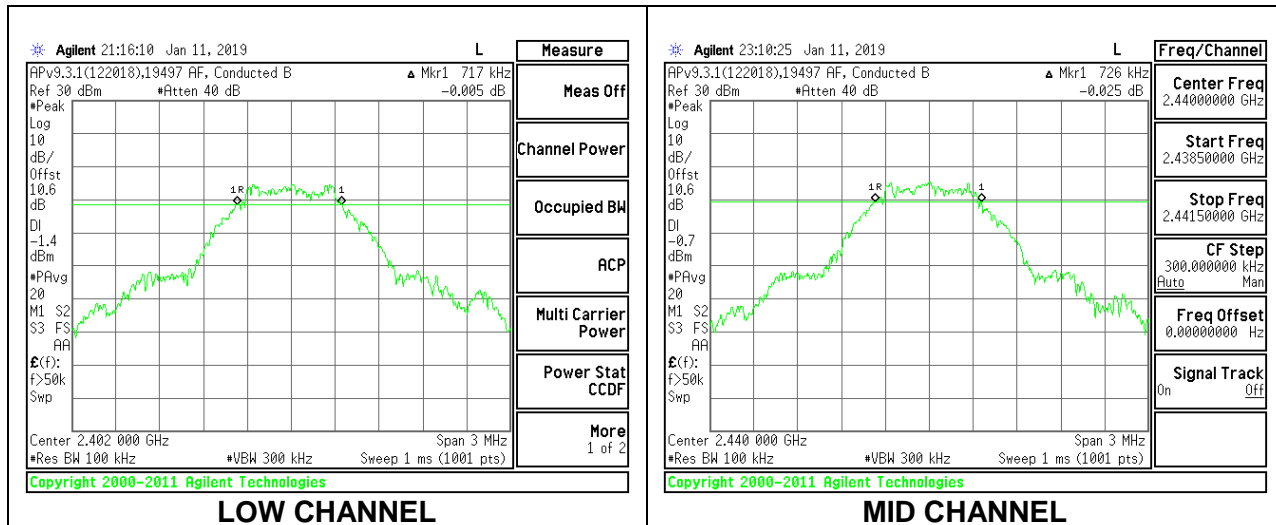

11.3.2. 2Mbps

Channel	Frequency (MHz)	6 dB Bandwidth (MHz)	Minimum Limit (MHz)
Low	2402	1.329	0.5
Middle	2440	1.254	0.5
High	2480	1.395	0.5

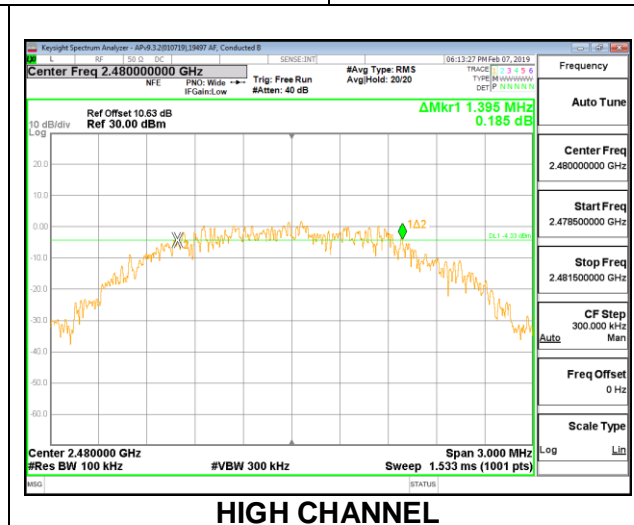
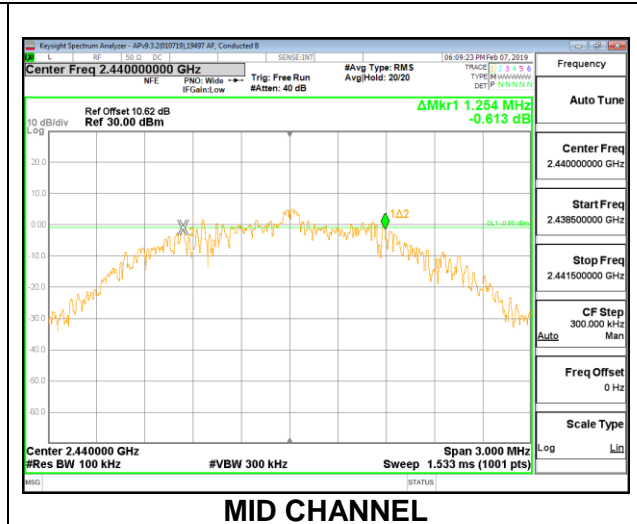
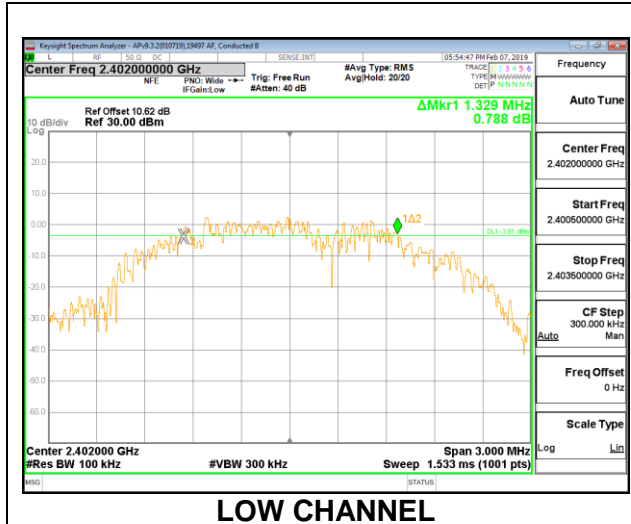

11.4. OUTPUT POWER

LIMITS

FCC §15.247 (b) (3)

The maximum antenna gain is less than or equal to 6 dBi, therefore the limit is 30 dBm.

TEST PROCEDURE

The transmitter output is connected to a power meter. The cable assembly insertion loss was entered as an offset in the power meter to allow for the peak reading of power.

RESULTS

11.4.1. 1Mbps

Tested By:	19497 AF
Date:	1/11/2019

Channel	Frequency (MHz)	Peak Power Reading (dBm)	Limit (dBm)	Margin (dB)
Low	2402	5.36	30	-24.640
Middle	2440	6.09	30	-23.910
High	2480	6.05	30	-23.950

11.4.2. 2Mbps

Tested By:	19497 AF
Date:	2/7/2019

Channel	Frequency (MHz)	Peak Power Reading (dBm)	Limit (dBm)	Margin (dB)
Low	2402	5.63	30	-24.370
Middle	2440	6.49	30	-23.506
High	2480	5.46	30	-24.540

11.5. AVERAGE POWER

LIMITS

None; for reporting purposes only.

TEST PROCEDURE

The transmitter output is connected to a power meter. The cable assembly insertion loss of was entered as an offset in the power meter to allow for the gated average reading of power.

RESULTS

11.5.1. 1Mbps

Tested By:	19497AF
Date:	1/11/2019

Channel	Frequency (MHz)	AV power (dBm)
Low	2402	4.78
Middle	2440	5.51
High	2480	5.51

11.5.2. 2Mbps

Tested By:	16080 ZS
Date:	2/6/2019

Channel	Frequency (MHz)	AV power (dBm)
Low	2402	4.31
Middle	2440	5.1
High	2480	3.97

11.6. POWER SPECTRAL DENSITY

LIMITS

FCC §15.247 (e)

The power spectral density conducted from the transmitter to the antenna shall not be greater than 8 dBm in any 3 kHz band during any time interval of continuous transmission.

RESULTS

11.6.1. 1Mbps

Channel	Frequency (MHz)	PSD (dBm/3kHz)	Limit (dBm/3kHz)	Margin (dB)
Low	2402	-9.76	8	-17.76
Middle	2440	-9.02	8	-17.02
High	2480	-10.20	8	-18.20

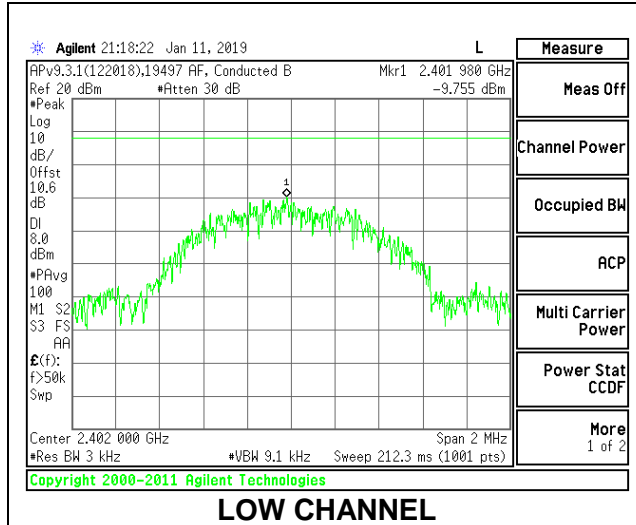

LOW CHANNEL

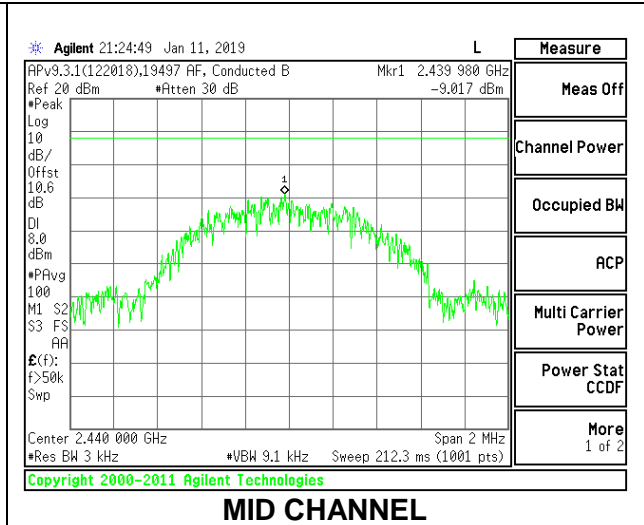

MID CHANNEL

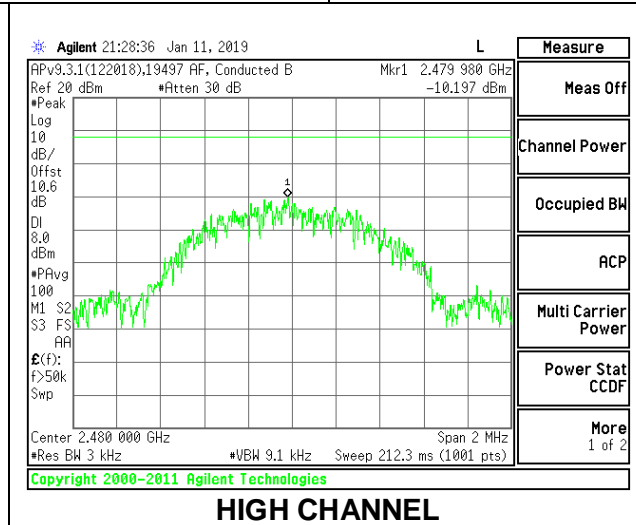

HIGH CHANNEL

11.6.2. 2Mbps

Channel	Frequency (MHz)	PSD (dBm/3kHz)	Limit (dBm/3kHz)	Margin (dB)
Low	2402	-13.20	8	-21.20
Middle	2440	-13.22	8	-21.22
High	2480	-14.11	8	-22.11

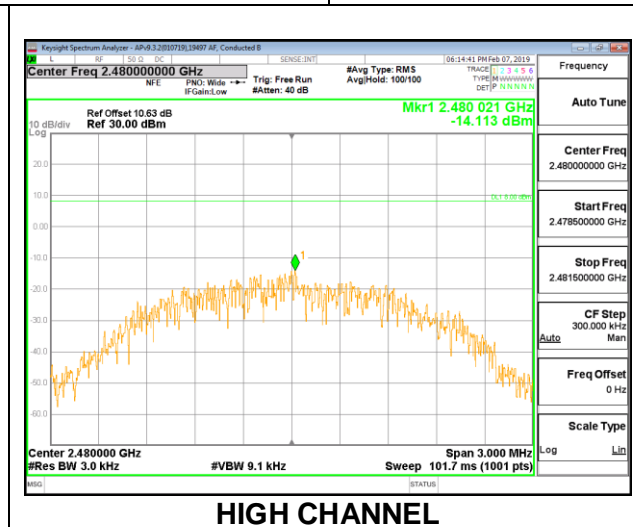
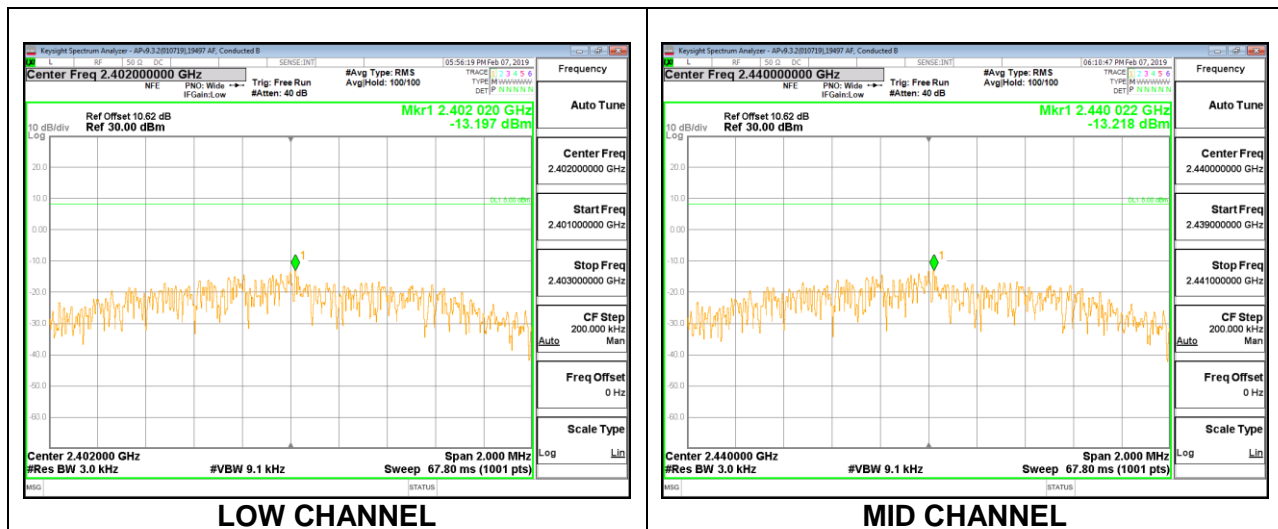

11.7. CONDUCTED SPURIOUS EMISSIONS

LIMITS

FCC §15.247 (d)

Output power was measured based on the use of a peak measurement, therefore the required attenuation is 20 dB.

RESULTS

11.7.1. 1Mbps

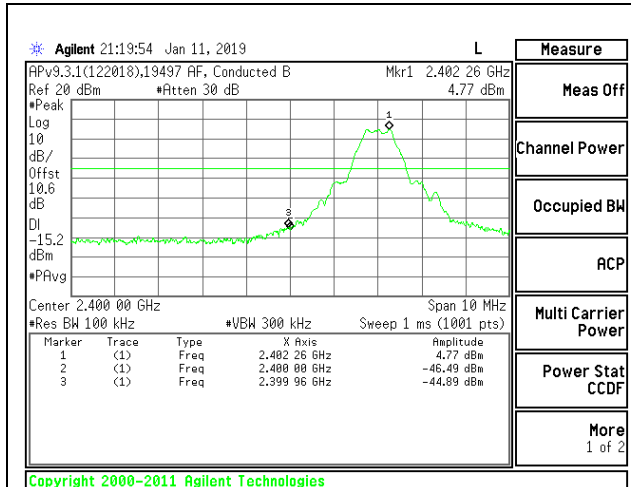

LOW CHANNEL BANDEDGE

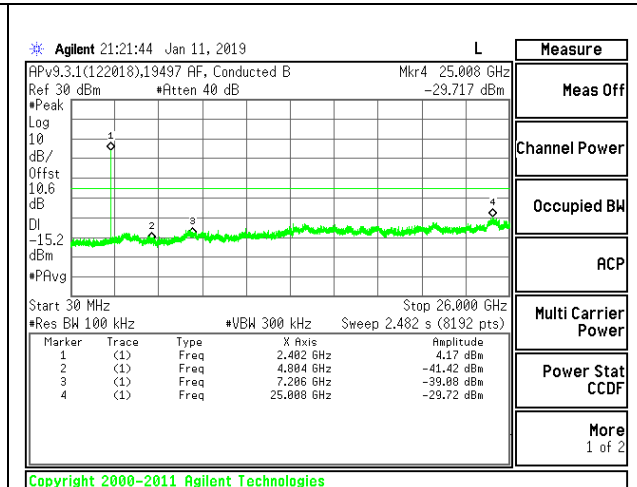

OUT-OF-BAND LOW CHANNEL

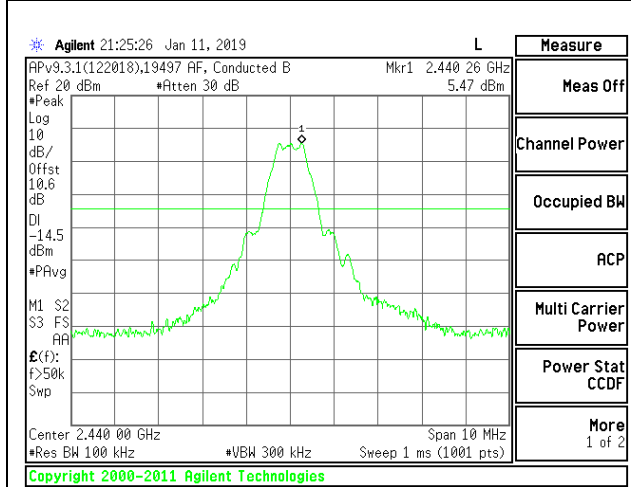

IN-BAND REFERENCE LEVEL

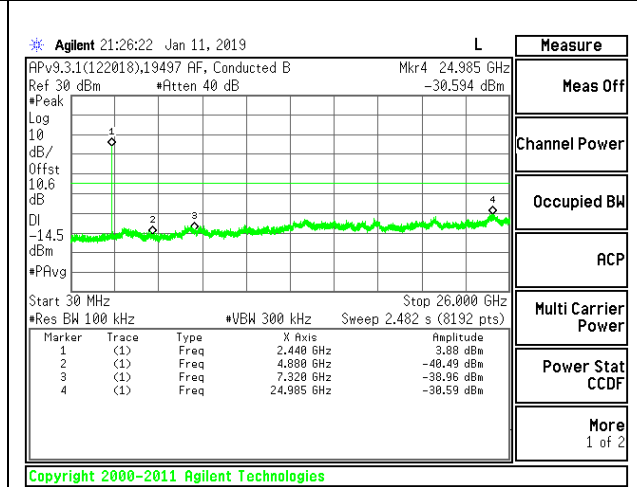

OUT-OF-BAND MID CHANNEL

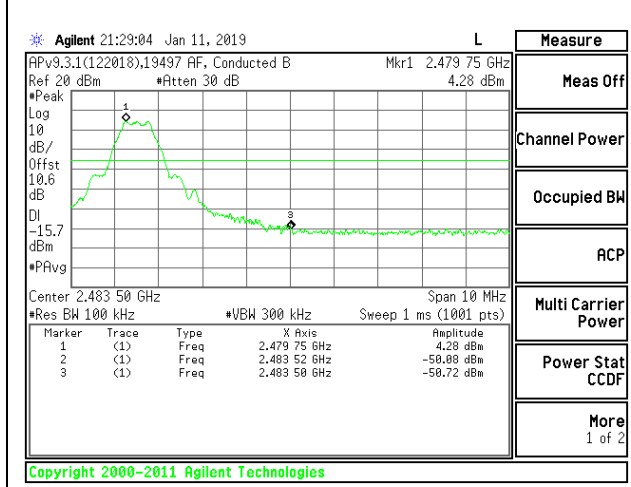

HIGH CHANNEL BANDEDGE

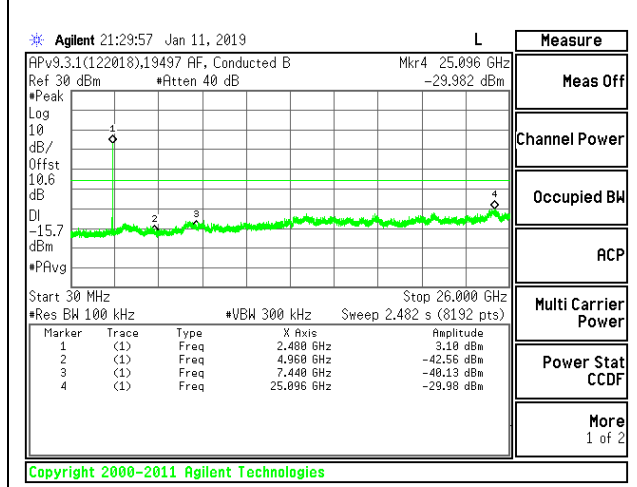

OUT-OF-BAND HIGH CHANNEL

11.7.2. 2Mbps

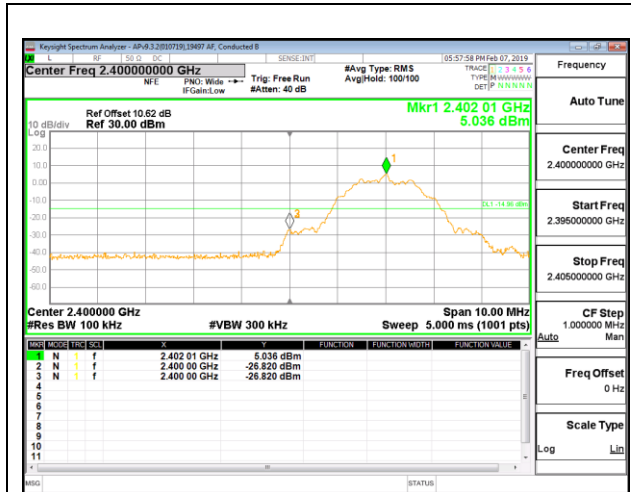

LOW CHANNEL BANDEDGE

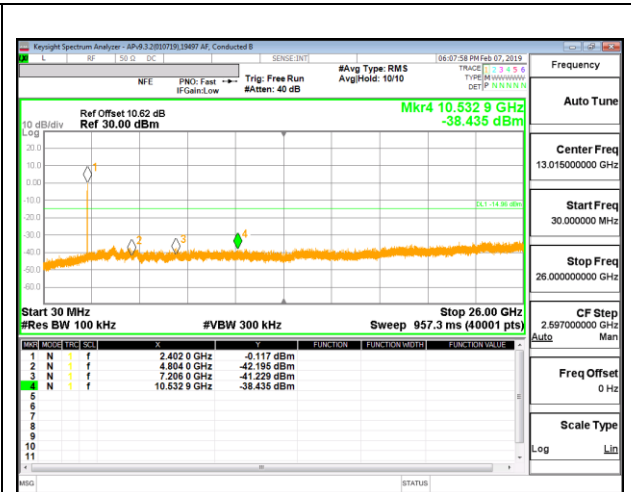

OUT-OF-BAND LOW CHANNEL

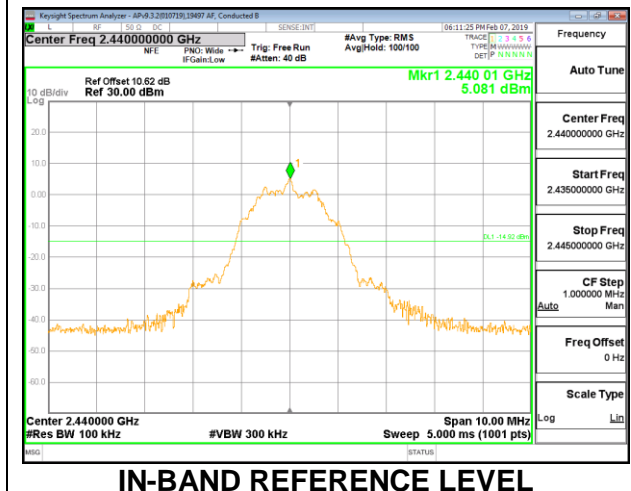

IN-BAND REFERENCE LEVEL

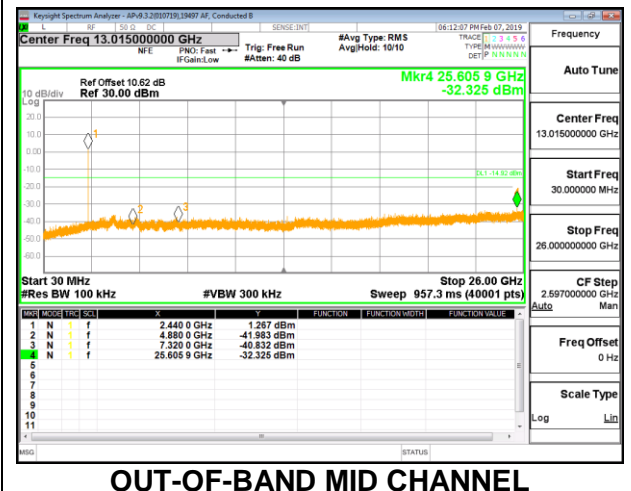

OUT-OF-BAND MID CHANNEL

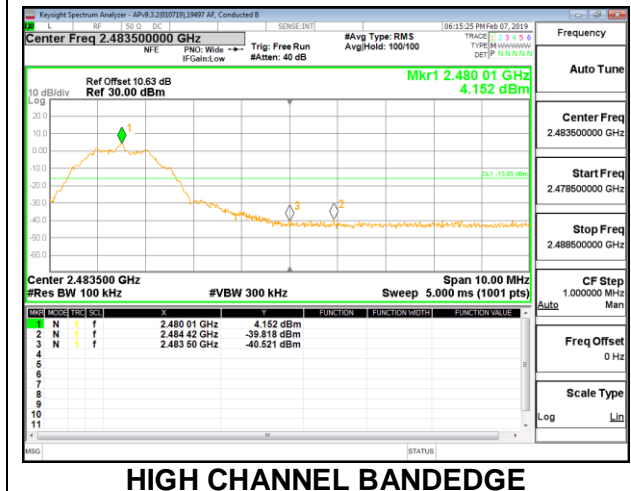

HIGH CHANNEL BANDEDGE

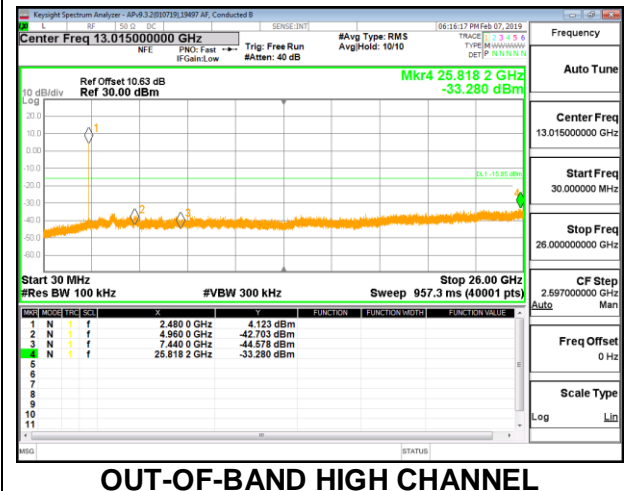

OUT-OF-BAND HIGH CHANNEL

12. RADIATED TEST RESULTS

12.1. LIMITS AND PROCEDURE

LIMITS

FCC §15.205 and §15.209

Frequency Range (MHz)	Field Strength Limit (uV/m) at 3 m	Field Strength Limit (dBuV/m) at 3 m
0.009-0.490	2400/F(kHz) @ 300 m	-
0.490-1.705	24000/F(kHz) @ 30 m	-
1.705 - 30	30 @ 30m	-
30 - 88	100	40
88 - 216	150	43.5
216 - 960	200	46
Above 960	500	54

TEST PROCEDURE

The EUT is placed on a non-conducting table 80 cm above the ground plane for measurement below 1GHz; 1.5 m above the ground plane for measurement above 1GHz. The antenna to EUT distance is 3 meters. The EUT is configured in accordance with ANSI C63.10. The EUT is set to transmit in a continuous mode.

For measurements below 1 GHz the resolution bandwidth is set to 100 kHz for peak detection measurements or 120 kHz for quasi-peak detection measurements. Peak detection is used unless otherwise noted as quasi-peak.

For pre-scans above 1 GHz the resolution bandwidth is set to 1 MHz; the video bandwidth is set to 30 KHz for peak measurements.

For final measurements above 1 GHz the resolution bandwidth is set to 1 MHz; the video bandwidth is set to 3 MHz for peak measurements and as applicable for average measurements.

The spectrum from 1 GHz to 18 GHz is investigated with the transmitter set to the lowest, middle, and highest channels in each applicable band. Below 1GHz and above 18GHz emissions, the channel with the highest output power was tested.

The frequency range of interest is monitored at a fixed antenna height and EUT azimuth. The EUT is rotated through 360 degrees to maximize emissions received. The antenna is scanned from 1 to 4 meters above the ground plane to further maximize the emission. Measurements are made with the antenna polarized in both the vertical and the horizontal positions.

2D antenna use - For below 30MHz testing, investigation was done on three antenna orientations (parallel, perpendicular, and ground-parallel), parallel and perpendicular are the worst orientations, therefore testing was performed on these two orientations only.

KDB 414788 OATS and Chamber Correlation Justification

Base on FCC 15.31 (f) (2): measurements may be performed at a distance closer than that specified in the regulations; however, an attempt should be made to avoid making measurements in the near field.

OATs and chamber correlation testing had been performed and chamber measured test result is the worst case test result.

12.2. TRANSMITTER ABOVE 1 GHz

12.2.1. 1Mbps

BANDEDGE (LOW CHANNEL)

HORIZONTAL RESULT

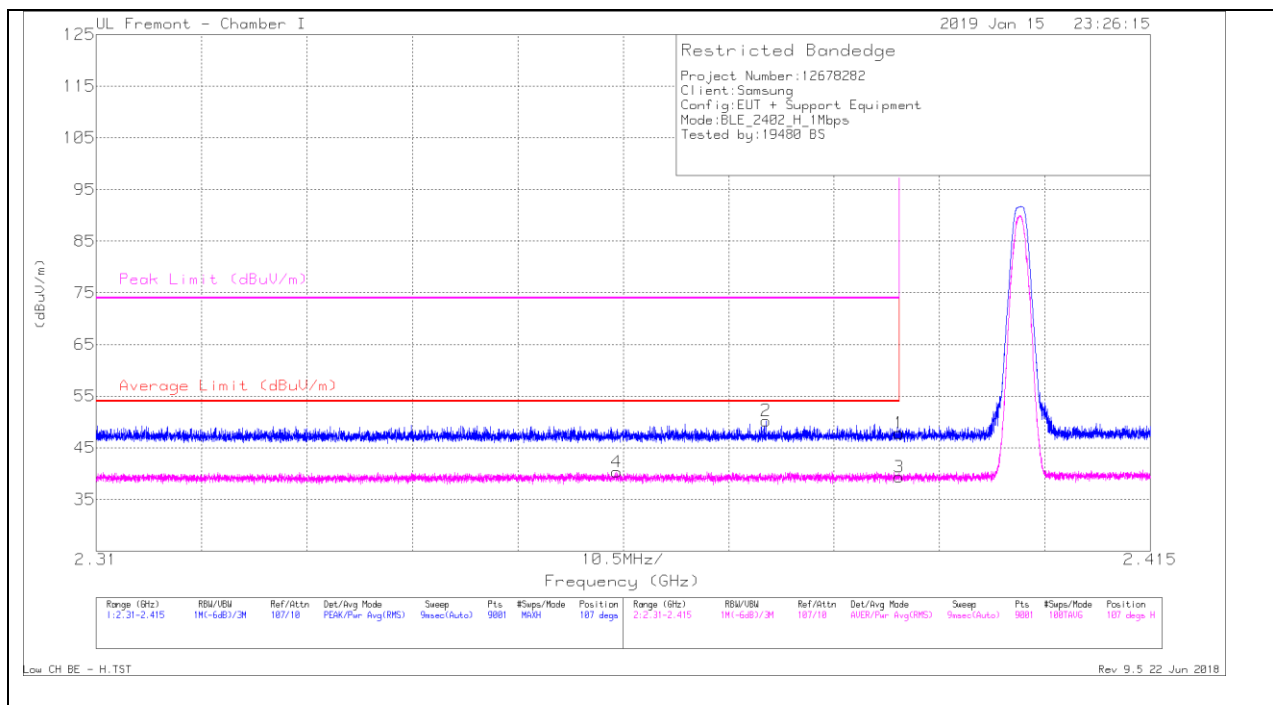

Trace Markers

Marker	Frequency (GHz)	Meter Reading (dBuV)	Det	AF T862 (dB/m)	Amp/Cb/Retr/Pad (dB)	DC Corr (dB)	Corrected Reading (dBuV/m)	Average Limit (dBuV/m)	Margin (dB)	Peak Limit (dBuV/m)	PK Margin (dB)	Azimuth (Degs)	Height (cm)	Polarity
1	* 2.39	37.64	Pk	31.8	-21.6	0	47.84	-	-	74	-26.16	107	389	H
2	* 2.377	40.02	Pk	31.7	-21.5	0	50.22	-	-	74	-23.78	107	389	H
3	* 2.39	27.01	RMS	31.8	-21.6	2.12	39.33	54	-14.67	-	-	107	389	H
4	* 2.362	28.08	RMS	31.6	-21.5	2.12	40.3	54	-13.7	-	-	107	389	H

* - indicates frequency in CFR47 Pt 15 / IC RSS-Restricted Band

Pk - Peak detector

RMS - RMS detection

VERTICAL RESULT

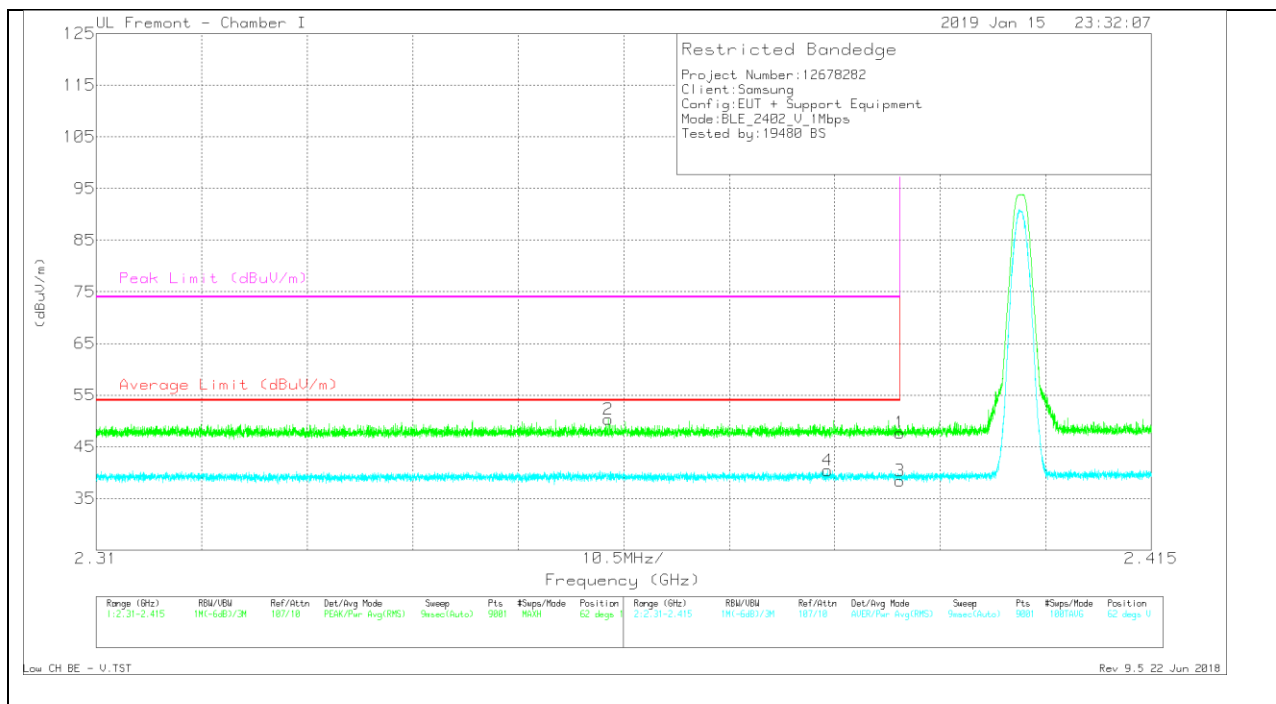

Trace Markers

Marker	Frequency (GHz)	Meter Reading (dBuV)	Det	AF 1862 (dB/m)	Amp/Cbl/Rtr/Pad (dB)	DC Corr (dB)	Corrected Reading (dBuV/m)	Average Limit (dBuV/m)	Margin (dB)	Peak Limit (dBuV/m)	PK Margin (dB)	Azimuth (Degs)	Height (cm)	Polarity
1	* 2.39	37.49	Pk	31.8	-21.6	0	47.69	-	-	74	-26.31	62	151	V
2	* 2.361	40.21	Pk	31.6	-21.5	0	50.31	-	-	74	-23.69	62	151	V
3	* 2.39	26.07	RMS	31.8	-21.6	2.12	38.39	54	-15.61	-	-	62	151	V
4	* 2.383	28.19	RMS	31.7	-21.6	2.12	40.41	54	-13.59	-	-	62	151	V

* - indicates frequency in CFR47 Pt 15 / IC RSS-Restricted Band

Pk - Peak detector

RMS - RMS detection

BANEDGE (HIGH CHANNEL)

HORIZONTAL RESULT

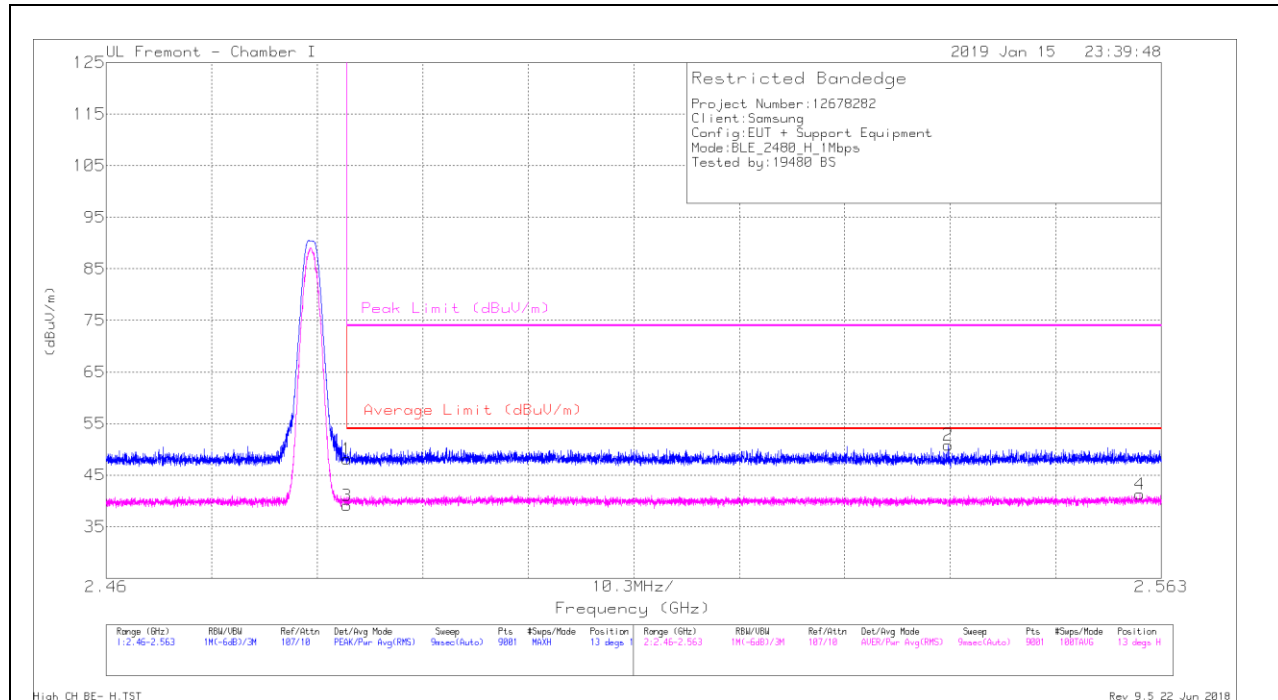

Trace Markers

Marker	Frequency (GHz)	Meter Reading (dBuV)	Det	AF T862 (dB/m)	Amp/Cbl/Ftr/Pad (dB)	DC Corr (dB)	Corrected Reading (dBuV/m)	Average Limit (dBuV/m)	Margin (dB)	Peak Limit (dBuV/m)	PK Margin (dB)	Azimuth (Degs)	Height (cm)	Polarity
1	* 2.484	37.42	Pk	32.4	-21.7	0	48.12	-	-	74	-25.88	13	120	H
2	2.542	40.23	Pk	32.4	-21.8	0	50.83	-	-	74	-23.17	13	120	H
3	* 2.484	26.28	RMS	32.4	-21.7	2.12	39.1	54	-14.9	-	-	13	120	H
4	2.561	28.37	RMS	32.4	-21.6	2.12	41.29	54	-12.71	-	-	13	120	H

* - indicates frequency in CFR47 Pt 15 / IC RSS-Restricted Band

Pk - Peak detector

RMS - RMS detection

VERTICAL RESULT

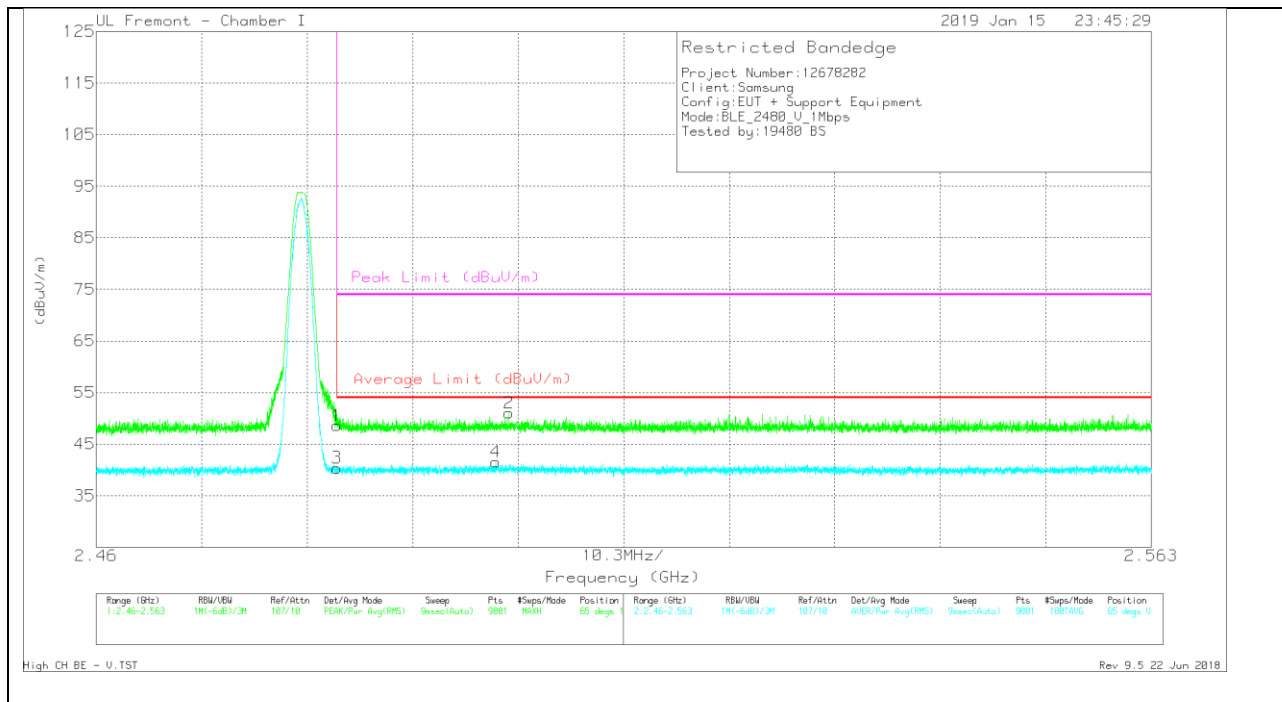

Trace Markers

Marker	Frequency (GHz)	Meter Reading (dBuV)	Det	AFT82 (dB/m)	Amp/Chl/Rtr/Psd (dB)	DC Corr (dB)	Corrected Reading (dBuV/m)	Average Limit (dBuV/m)	Margin (dB)	Peak Limit (dBuV/m)	PK Margin (dB)	Azimuth (Degs)	Height (cm)	Polarity
1	* 2.484	37.91	Pk	32.4	-21.7	0	48.61	-	-	74	-25.39	65	163	V
2	2.5	40.25	Pk	32.5	-21.7	0	51.05	-	-	74	-22.95	65	163	V
3	* 2.484	27.54	RMS	32.4	-21.7	2.12	40.36	54	-13.64	-	-	65	163	V
4	* 2.499	28.6	RMS	32.5	-21.7	2.12	41.52	54	-12.48	-	-	65	163	V

* - indicates frequency in CFR47 Pt 15 / IC RSS-Restricted Band

Pk - Peak detector

RMS - RMS detection

HARMONICS AND SPURIOUS EMISSIONS

LOW CHANNEL RESULTS

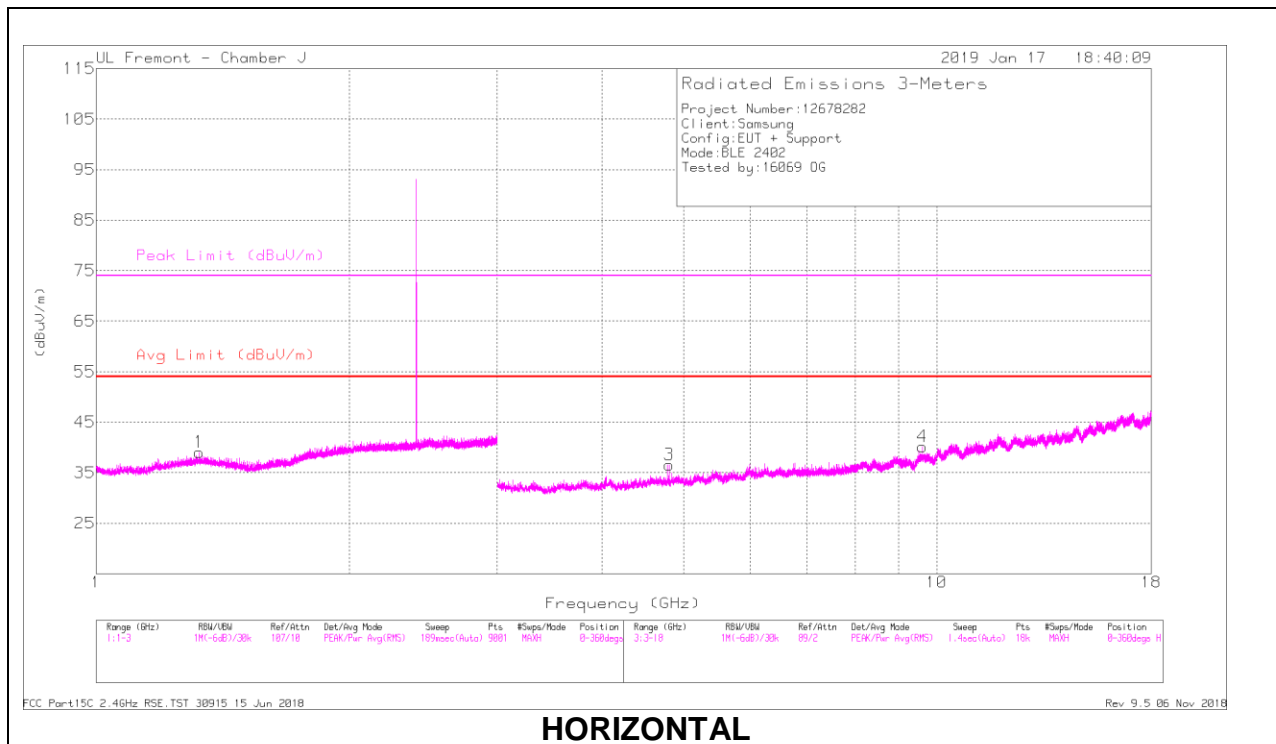

HORIZONTAL

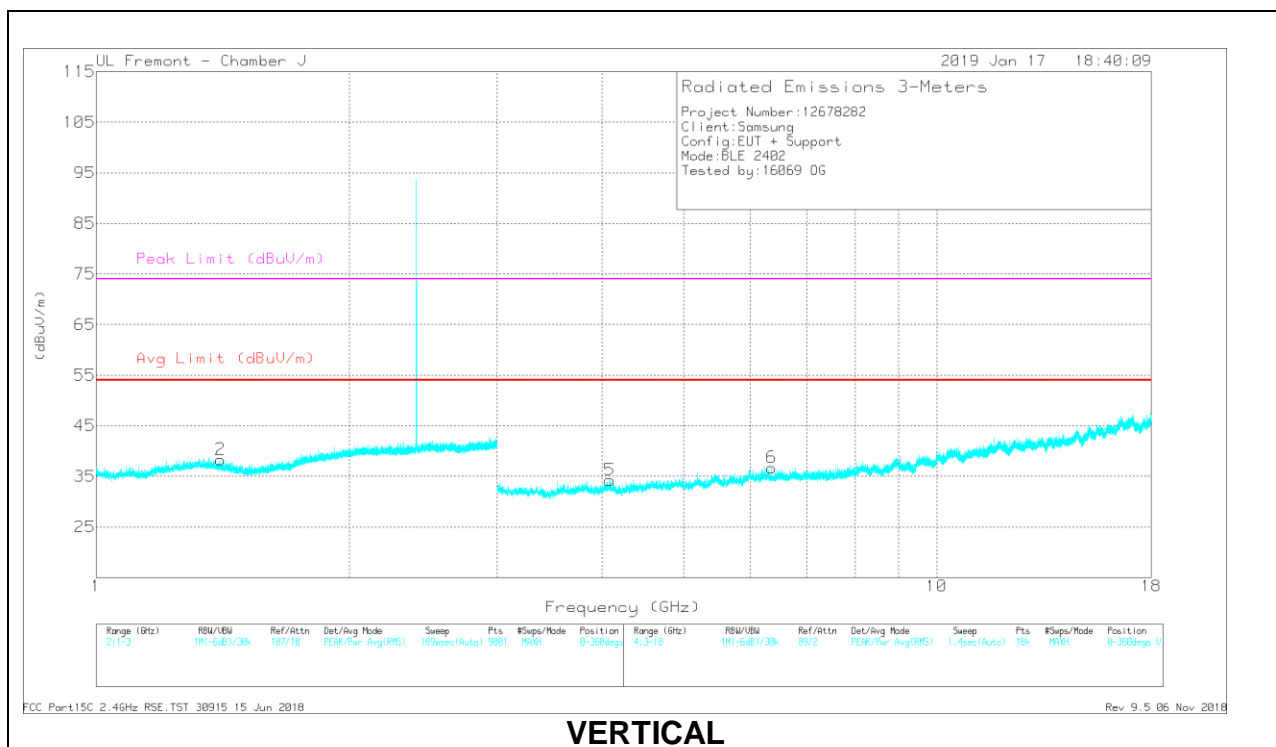

VERTICAL

RADIATED EMISSIONS

Frequency (GHz)	Meter Reading (dBuV)	Det	AF AT0067 (dB/m)	Amp/Cb/FI tr/Pad (dB)	DC Corr (dB)	Corrected Reading (dBuV/m)	Avg Limit (dBuV/m)	Margin (dB)	Peak Limit (dBuV/m)	PK Margin (dB)	Azimuth (Degs)	Height (cm)	Polarity
* 1.324	42.44	PK2	29.3	-26	0	45.74	-	-	74	-28.26	184	388	H
* 1.327	32.29	MAv1	29.3	-26	2.12	37.71	54	-16.29	-	-	184	388	H
* 1.408	41.8	PK2	28.9	-26.1	0	44.6	-	-	74	-29.4	315	228	V
* 1.408	32.18	MAv1	28.9	-26.1	2.12	37.1	54	-16.9	-	-	315	228	V
* 4.804	39.42	PK2	34.1	-31.3	0	42.22	-	-	74	-31.78	81	220	H
* 4.804	31.56	MAv1	34.1	-31.3	2.12	36.48	54	-17.52	-	-	81	220	H
9.619	33.74	PK2	36.6	-24.9	0	45.44	-	-	-	-	253	182	H
* 4.083	39.32	PK2	33.6	-31.7	0	41.22	-	-	74	-32.78	307	254	V
* 4.085	29.14	MAv1	33.6	-31.7	2.12	33.16	54	-20.84	-	-	307	254	V
6.362	35.83	PK2	35.5	-28.7	0	42.63	-	-	-	-	285	131	V

* - indicates frequency in CFR47 Pt 15 / IC RSS-Restricted Band

PK2 - KDB558074 Method: Maximum Peak

MAv1 - KDB558074 Option 1 Maximum RMS Average

MID CHANNEL RESULTS

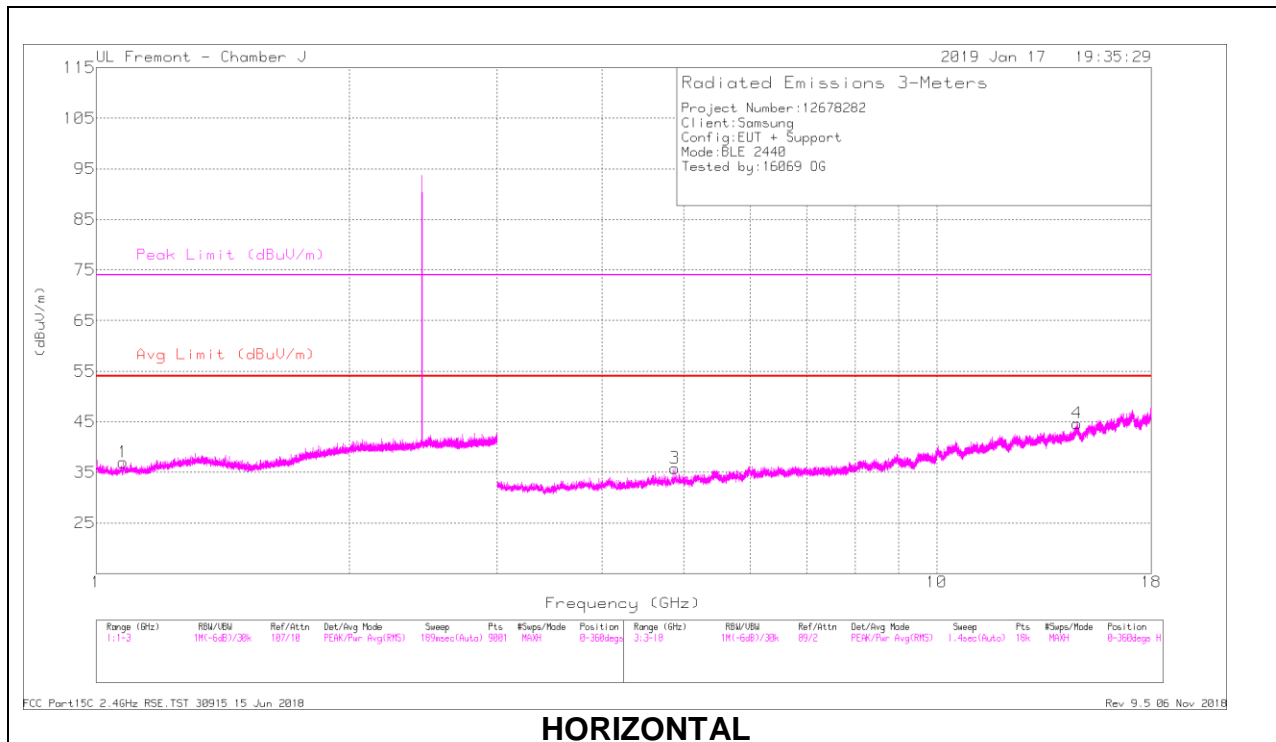

HORIZONTAL

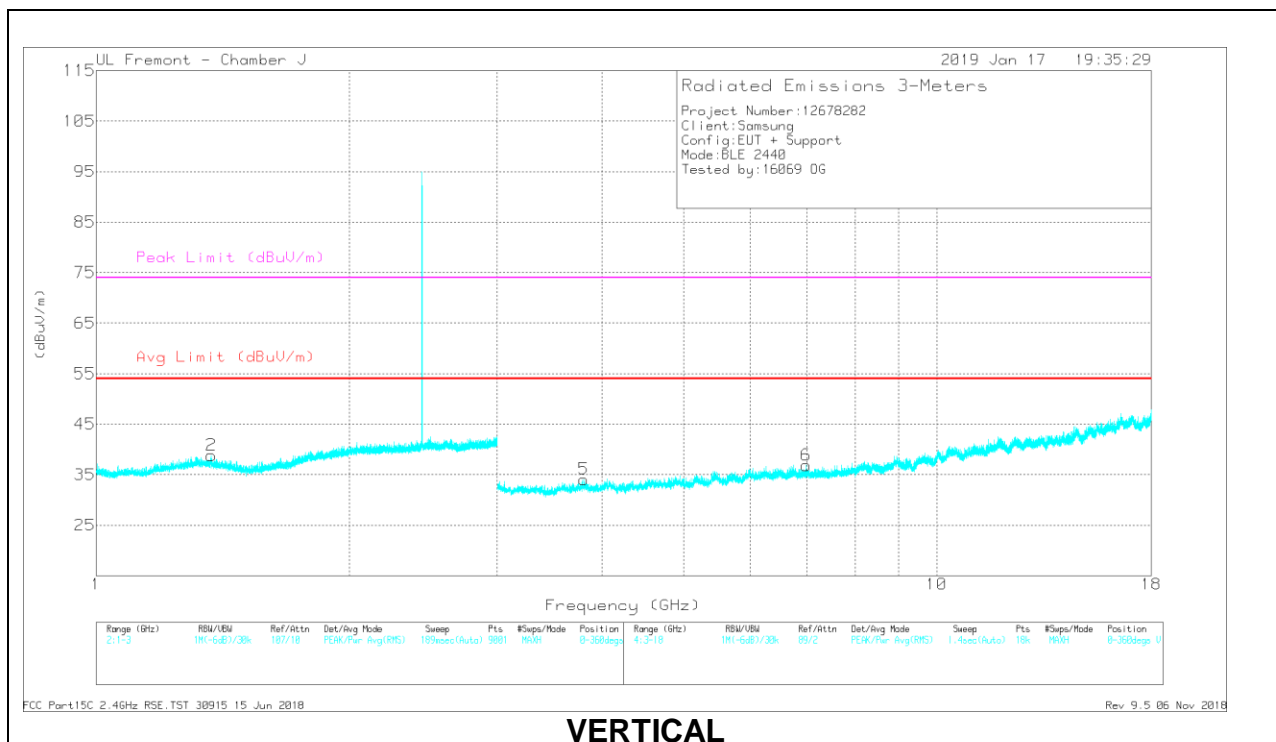

VERTICAL

RADIATED EMISSIONS

Frequency (GHz)	Meter Reading (dBuV)	Det	AF AT0067 (dB/m)	Amp/Cb/FI tr/Pad (dB)	DC Corr (dB)	Corrected Reading (dBuV/m)	Avg Limit (dBuV/m)	Margin (dB)	Peak Limit (dBuV/m)	PK Margin (dB)	Azimuth (Degs)	Height (cm)	Polarity
* 1.078	41.44	PK2	27.5	-25.8	0	43.14	-	-	74	-30.86	221	222	H
* 1.075	32.37	MAv1	27.4	-25.7	2.12	36.19	54	-17.81	-	-	221	222	H
* 1.373	41.55	PK2	29.1	-26.1	0	44.55	-	-	74	-29.45	360	290	V
* 1.369	32.18	MAv1	29.2	-26.1	2.12	37.4	54	-16.6	-	-	360	290	V
* 4.88	40.14	PK2	34	-31.4	0	42.74	-	-	74	-31.26	101	115	H
* 4.88	31.49	MAv1	34	-31.4	2.12	36.21	54	-17.79	-	-	101	115	H
14.686	31.28	PK2	39.4	-19.7	0	50.98	-	-	-	-	316	215	H
* 3.798	39.8	PK2	33.4	-32.8	0	40.4	-	-	74	-33.6	113	271	V
* 3.798	30.37	MAv1	33.4	-32.8	2.12	33.09	54	-20.91	-	-	113	271	V
6.991	34.15	PK2	35.6	-27.6	0	42.15	-	-	-	-	220	226	V

* - indicates frequency in CFR47 Pt 15 / IC RSS-Restricted Band

PK2 - KDB558074 Method: Maximum Peak

MAv1 - KDB558074 Option 1 Maximum RMS Average

HIGH CHANNEL RESULTS

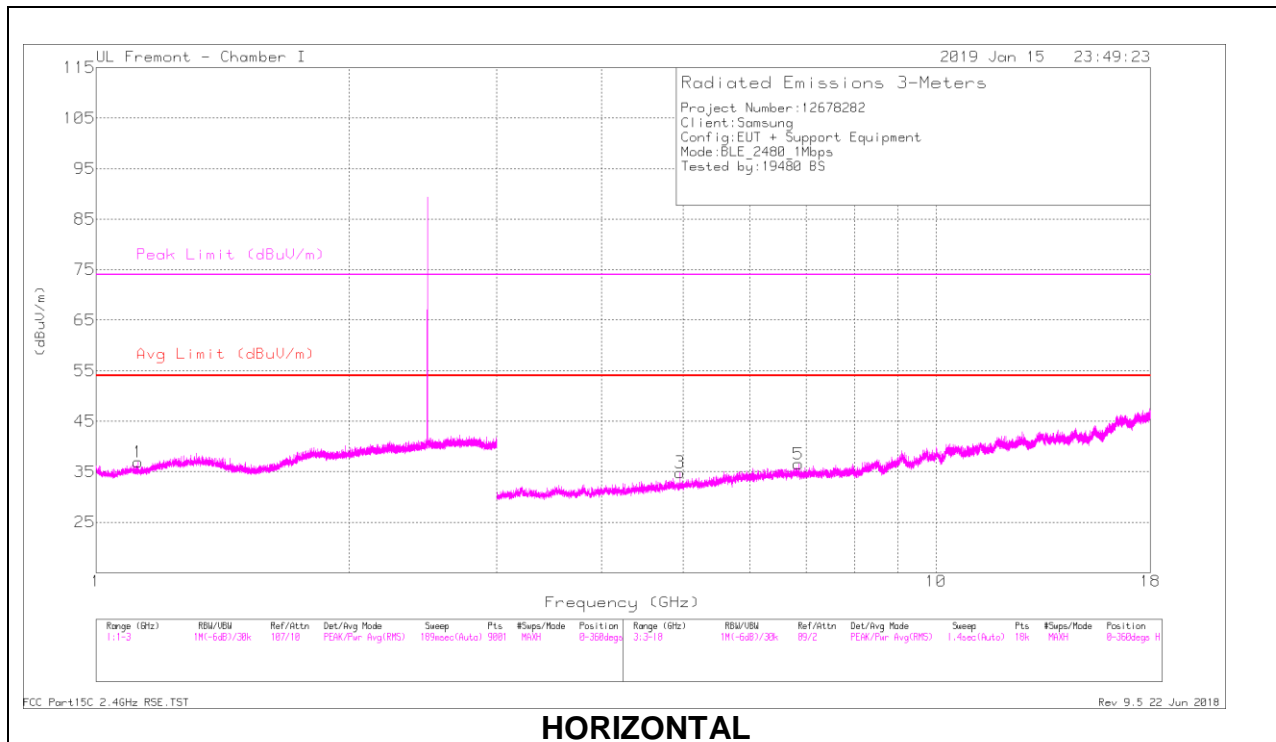

HORIZONTAL

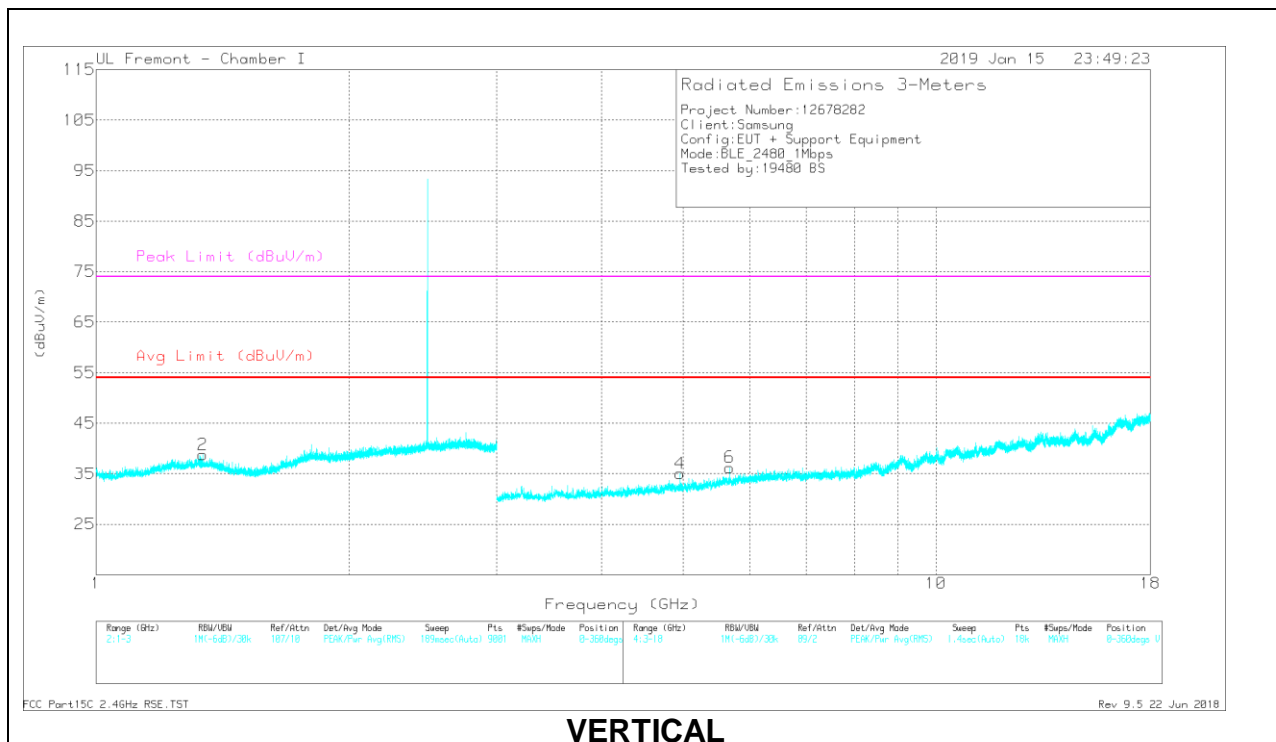

VERTICAL

RADIATED EMISSIONS

Frequency (GHz)	Meter Reading (dBuV)	Det	AF T862 (dB/m)	Amp/Cbl/Ftr/Pad (dB)	DC Corr (dB)	Corrected Reading (dBuV/m)	Avg Limit (dBuV/m)	Margin (dB)	Peak Limit (dBuV/m)	PK Margin (dB)	Azimuth (Degs)	Height (cm)	Polarity
* 1.122	39.41	PK2	27.7	-23.5	0	43.61	-	-	74	-30.39	16	130	H
* 1.12	29.47	MAv1	27.6	-23.6	2.12	35.59	54	-18.41	-	-	16	130	H
* 1.34	38.19	PK2	29.3	-23.1	0	44.39	-	-	74	-29.61	25	172	V
* 1.339	28.75	MAv1	29.3	-23.1	2.12	37.07	54	-16.93	-	-	25	172	V
* 4.96	35.32	PK2	34.2	-29	0	40.52	-	-	74	-33.48	148	160	H
* 4.96	27	MAv1	34.2	-29	2.12	34.32	54	-19.68	-	-	148	160	H
6.858	32.7	PK2	35.6	-25.4	0	42.9	-	-	-	-	53	189	H
* 4.96	35.57	PK2	34.2	-29	0	40.77	-	-	74	-33.23	156	137	V
* 4.96	26.86	MAv1	34.2	-29	2.12	34.18	54	-19.82	-	-	156	137	V
5.68	33.24	PK2	35	-27.1	0	41.14	-	-	-	-	274	389	V

* - indicates frequency in CFR47 Pt 15 / IC RSS-Restricted Band

PK2 - KDB558074 Method: Maximum Peak

MAv1 - KDB558074 Option 1 Maximum RMS Average

12.2.1. 2Mbps

BANDEDGE (LOW CHANNEL)

HORIZONTAL RESULT

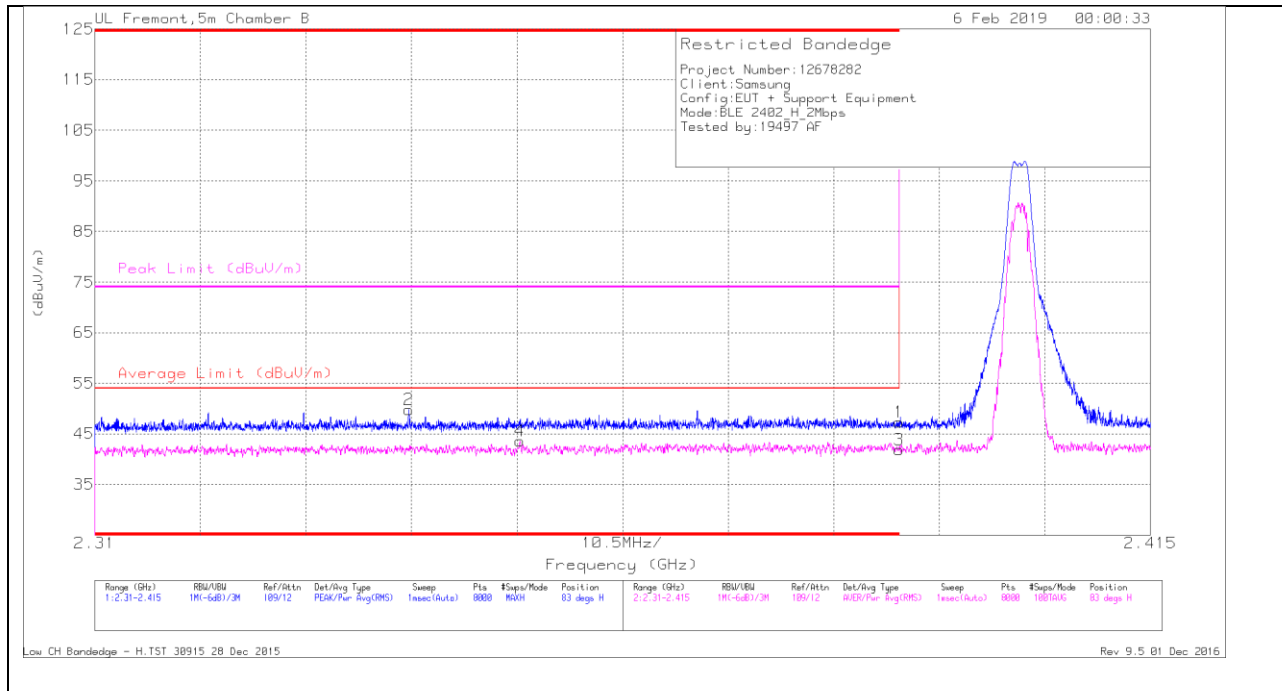

Trace Markers

Marker	Frequency (GHz)	Meter Reading (dBuV)	Det	AF T863 (dB/m)	Amp/Chl/Filt/Pad (dB)	DC Corr (dB)	Corrected Reading (dBuV/m)	Average Limit (dBuV/m)	Margin (dB)	Peak Limit (dBuV/m)	PK Margin (dB)	Azimuth (Degs)	Height (cm)	Polarity
1	* 2.39	35.67	Pk	32.3	-20.7	0	47.27	-	-	74	-26.73	83	309	H
2	* 2.341	38.38	Pk	32.1	-20.7	0	49.78	-	-	74	-24.22	83	309	H
3	* 2.39	25.19	RMS	32.3	-20.7	5.04	41.83	54	-12.17	-	-	83	309	H
4	* 2.352	27.03	RMS	32.2	-20.7	5.04	43.57	54	-10.43	-	-	83	309	H

* - indicates frequency in CFR47 Pt 15 / IC RSS-Restricted Band

Pk - Peak detector

RMS - RMS detection

VERTICAL RESULT



Trace Markers

Marker	Frequenc y (GHz)	Meter Reading (dBuV)	Det	AF T863 (dB/m)	Amp/CbI/Fitr/Pad (dB)	DC Corr (dB)	Correcte d Reading (dBuV/m)	Average Limit (dBuV/m)	Margin	Peak Limit (dBuV/m)	PK Margin (dB)	Azimuth (Degs)	Height (cm)	Polarity
1	* 2.39	35.86	Pk	32.3	-20.7	0	47.46	-	-	74	-26.54	83	309	V
2	* 2.38	38.16	Pk	32.3	-20.7	0	49.76	-	-	74	-24.24	83	309	V
3	* 2.39	25.34	RMS	32.3	-20.7	5.04	41.98	54	-12.02	-	-	83	309	V
4	* 2.352	26.69	RMS	32.2	-20.7	5.04	43.23	54	-10.77	-	-	83	309	V

* - indicates frequency in CFR47 Pt 15 / IC RSS-Restricted Band

Pk - Peak detector

RMS - RMS detection

BANDEDGE (HIGH CHANNEL)

HORIZONTAL RESULT

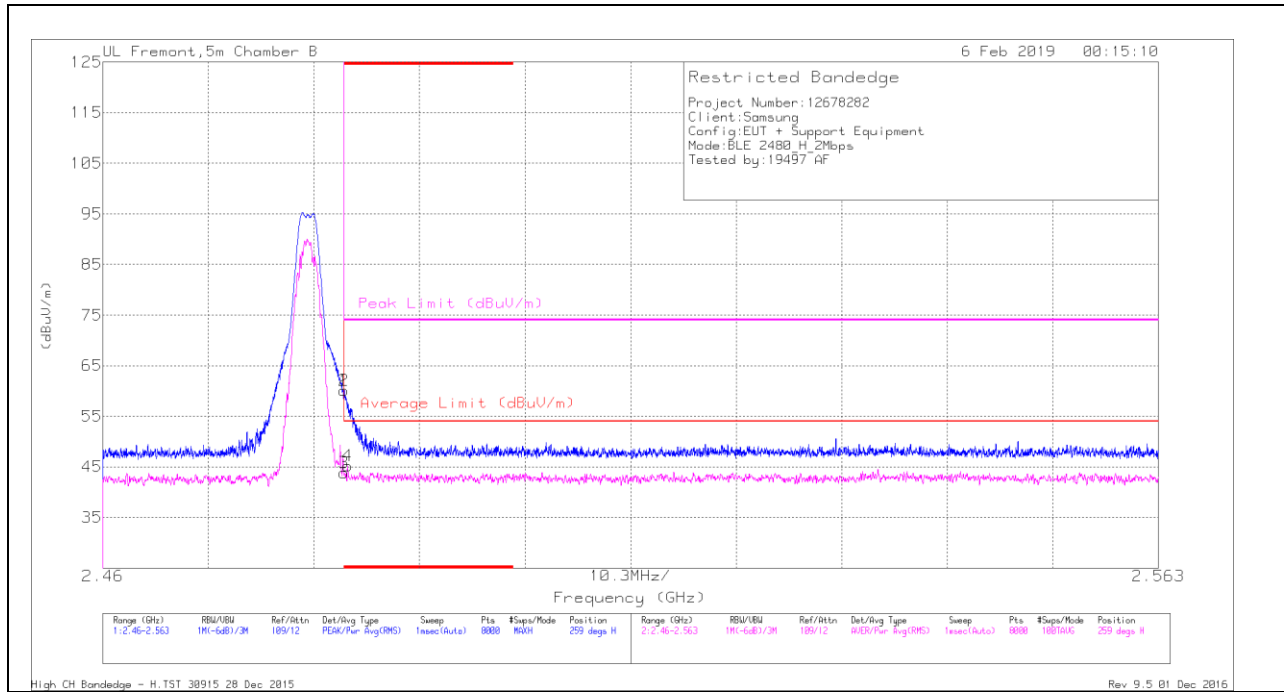

Trace Markers

Marker	Frequency (GHz)	Meter Reading (dBuV)	Det	AF T863 (dB/m)	Ampl/Ch/Filt/Pad (dB)	DC Corr (dB)	Corrected Reading (dBuV/m)	Average Limit (dBuV/m)	Margin (dB)	Peak Limit (dBuV/m)	PK Margin (dB)	Azimuth (Degs)	Height (cm)	Polarity
1	* 2.484	47.82	PK	32.6	-20.3	0	60.12	-	-	74	-13.88	259	309	H
2	* 2.484	47.84	PK	32.6	-20.3	0	60.14	-	-	74	-13.86	259	309	H
3	* 2.484	26.49	RMS	32.6	-20.3	5.04	43.83	54	-10.17	-	-	259	309	H
4	* 2.484	28.01	RMS	32.6	-20.4	5.04	45.25	54	-8.75	-	-	259	309	H

* - indicates frequency in CFR47 Pt 15 / IC RSS-Restricted Band

PK - Peak detector

RMS - RMS detection

VERTICAL RESULT

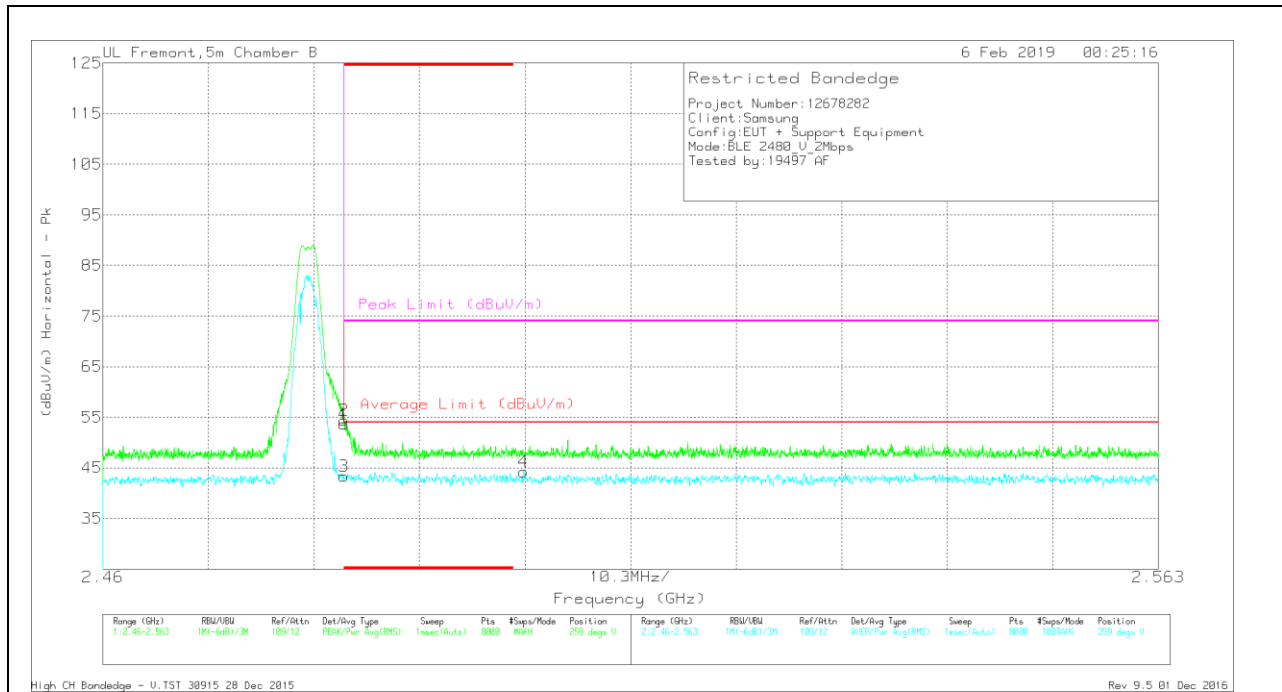

Trace Markers

Marker	Frequency (GHz)	Meter Reading (dBuV)	Det	AF T863 (dB/m)	Ampl/Chl/Filt/Pad (dB)	DC Corr (dB)	Corrected Reading (dBuV/m)	Average Limit (dBuV/m)	Margin (dB)	Peak Limit (dBuV/m)	PK Margin (dB)	Azimuth (Degs)	Height (cm)	Polarity
1	* 2.484	41.32	Pk	32.6	-20.3	0	53.62	-	-	74	-20.38	259	316	V
2	* 2.484	42.13	Pk	32.6	-20.3	0	54.43	-	-	74	-19.57	259	316	V
3	* 2.484	25.99	RMS	32.6	-20.3	5.04	43.33	54	-10.67	-	-	259	316	V
4	2.501	27.01	RMS	32.7	-20.5	5.04	44.25	54	-9.75	-	-	259	316	V

* - indicates frequency in CFR47 Pt 15 / IC RSS-Restricted Band

Pk - Peak detector

RMS - RMS detection

HARMONICS AND SPURIOUS EMISSIONS

LOW CHANNEL RESULTS

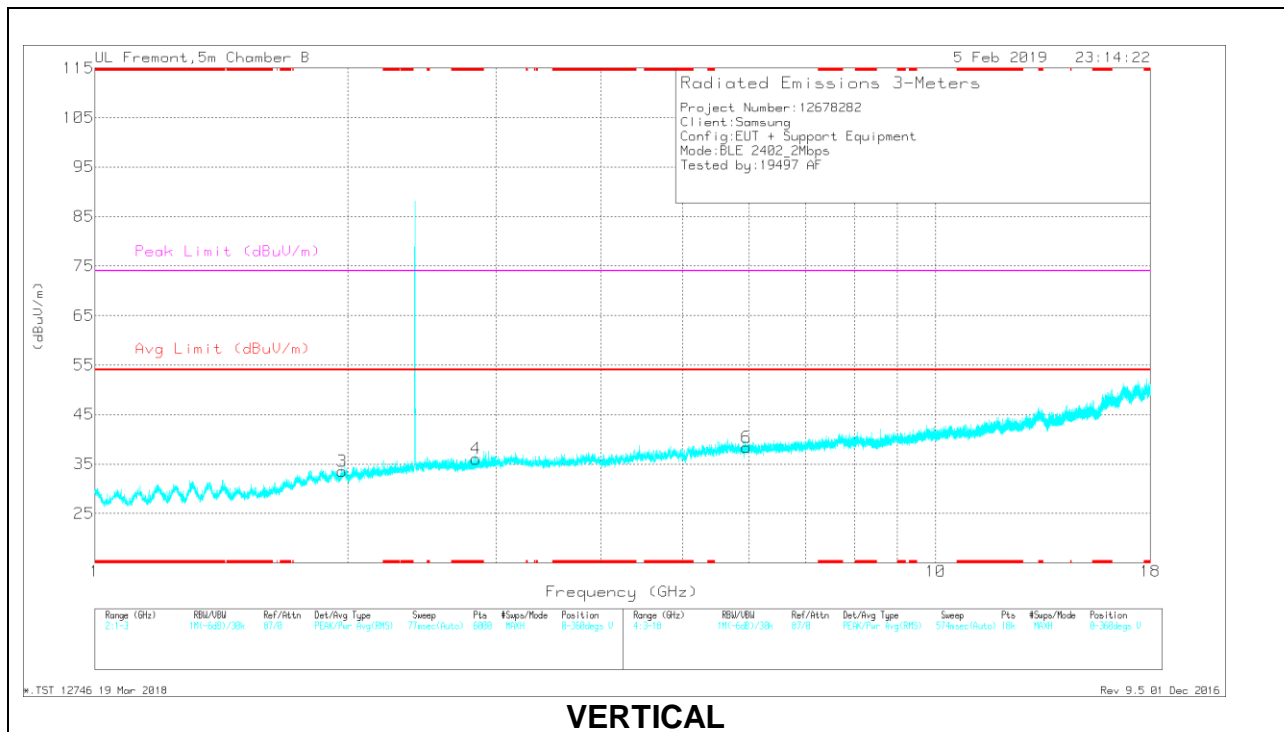
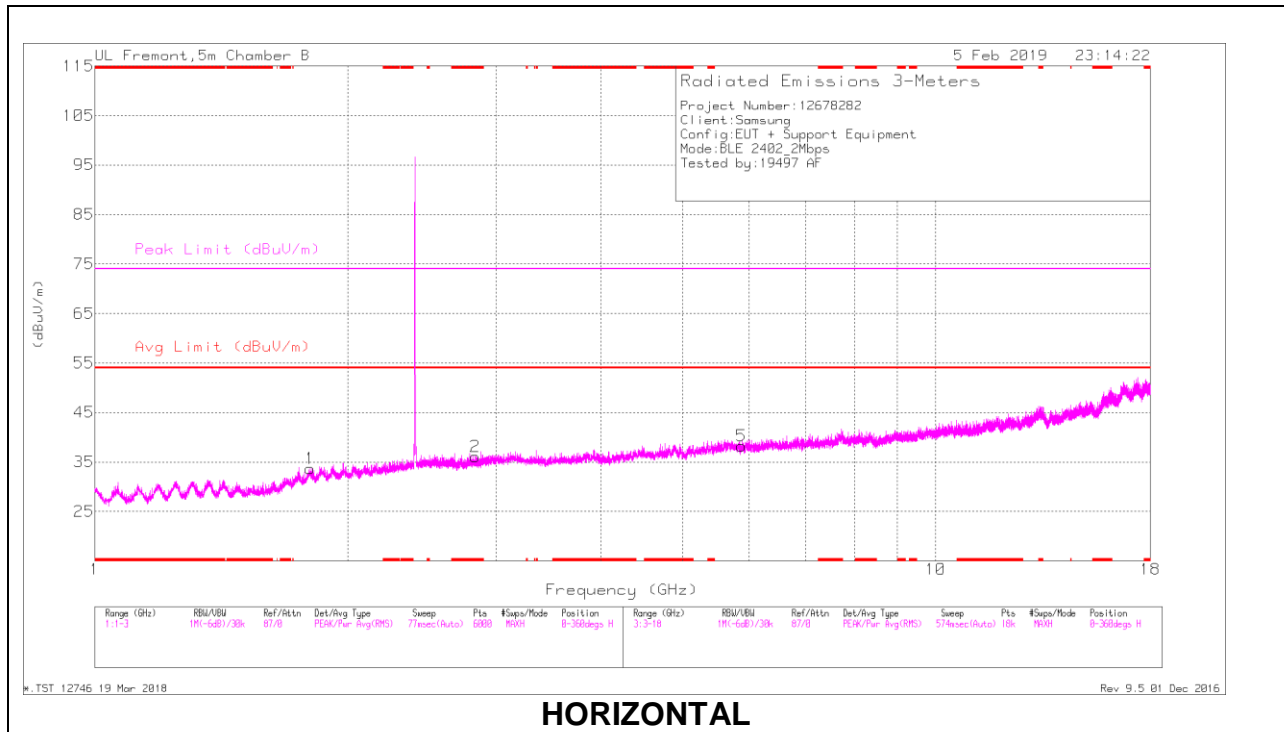

RADIATED EMISSIONS

Frequency (GHz)	Meter Reading (dBuV)	Det	AF T863 (dB/m)	Amp/Cb/Filt/ Pad (dB)	DC Corr (dB)	Corrected Reading (dBuV/m)	Avg Limit (dBuV/m)	Margin (dB)	Peak Limit (dBuV/m)	PK Margin (dB)	Azimuth (Degs)	Height (cm)	Polarity
* 2.831	29.77	PK2	32.5	-19.9	0	42.37	-	-	74	-31.63	217	106	H
* 2.832	13.69	MAv1	32.5	-19.9	5.04	31.33	54	-22.67	-	-	217	106	H
* 2.838	29.24	PK2	32.5	-19.8	0	41.94	-	-	74	-32.06	268	282	V
* 2.837	13.49	MAv1	32.5	-19.8	5.04	31.23	54	-22.77	-	-	268	282	V
1.8	29.39	PK2	30.7	-20.6	0	39.49	-	-	-	-	125	334	H
1.971	29.88	PK2	30.9	-20.5	0	40.28	-	-	-	-	42	326	V
5.876	38.65	PK2	35.4	-28.8	0	45.25	-	-	-	-	42	326	H
5.957	38.24	PK2	35.4	-28.4	0	45.24	-	-	-	-	42	326	V

* - indicates frequency in CFR47 Pt 15 / IC RSS-Restricted Band

PK2 - KDB558074 Method: Maximum Peak

MAv1 - KDB558074 Option 1 Maximum RMS Average

MID CHANNEL RESULTS

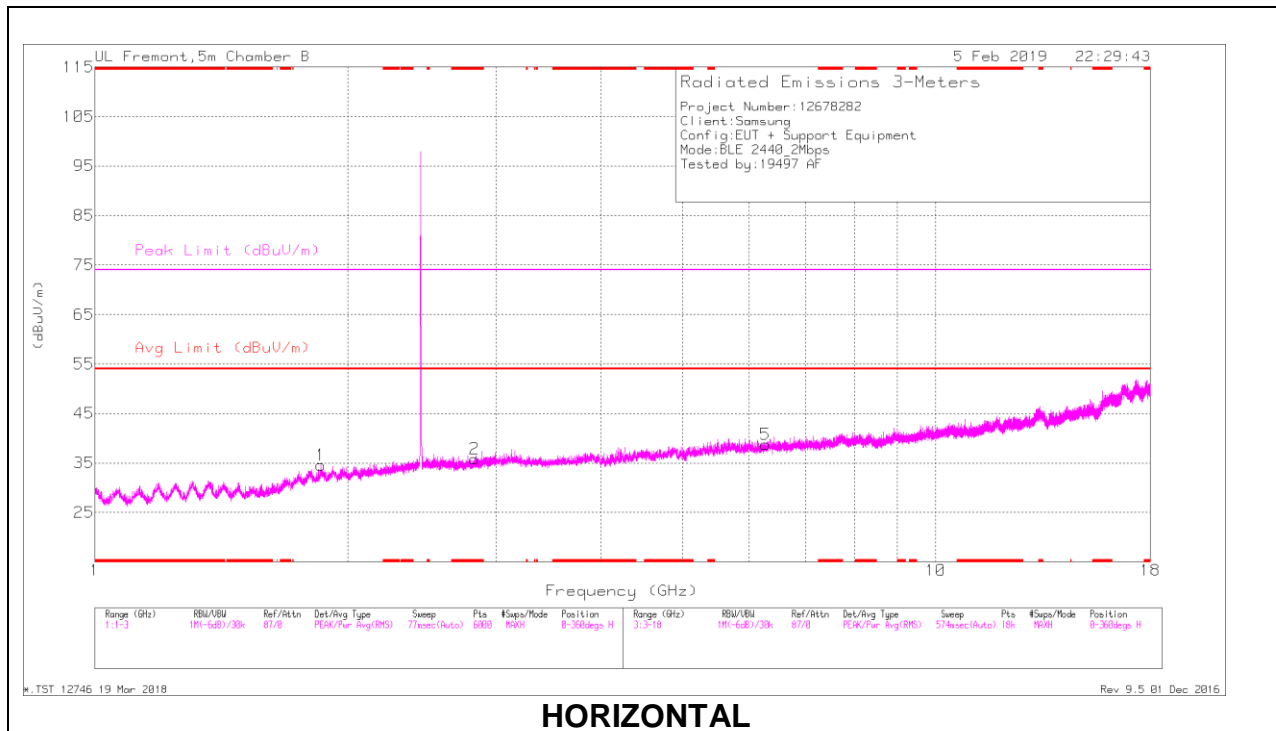

HORIZONTAL

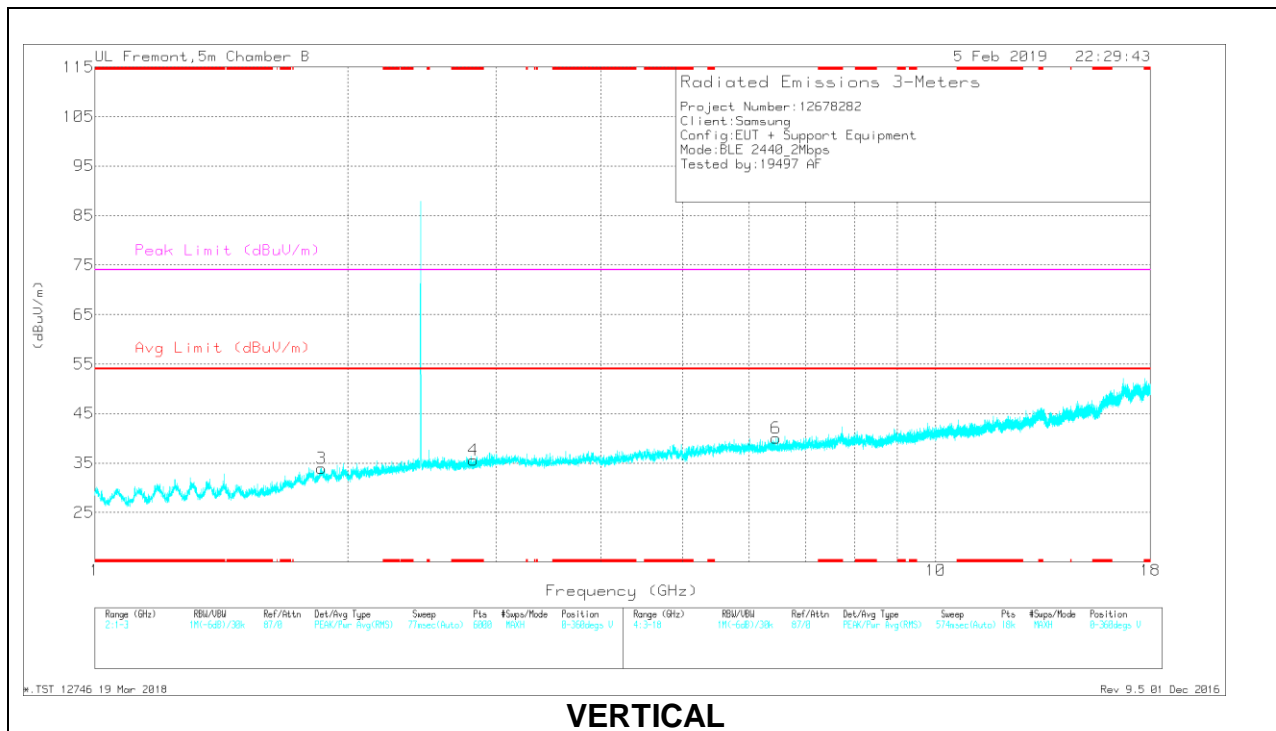

VERTICAL

RADIATED EMISSIONS

Frequency (GHz)	Meter Reading (dBuV)	Det	AF T863 (dB/m)	Amp/Cb/Filt/ Pad (dB)	DC Corr (dB)	Corrected Reading (dBuV/m)	Avg Limit (dBuV/m)	Margin (dB)	Peak Limit (dBuV/m)	PK Margin (dB)	Azimuth (Degs)	Height (cm)	Polarity
* 2.831	29.61	PK2	32.5	-19.9	0	42.21	-	-	74	-31.79	316	228	H
* 2.831	13.65	MAv1	32.5	-19.9	5.04	31.29	54	-22.71	-	-	316	228	H
* 2.819	29.4	PK2	32.5	-19.9	0	42	-	-	74	-32	71	188	V
* 2.819	13.51	MAv1	32.5	-19.9	5.04	31.15	54	-22.85	-	-	71	188	V
1.855	30.31	PK2	30.9	-20.6	0	40.61	-	-	-	-	254	289	H
1.862	29.8	PK2	30.9	-20.7	0	40	-	-	-	-	181	300	V
6.27	38.79	PK2	35.6	-28.5	0	45.89	-	-	-	-	194	250	H
6.456	37.92	PK2	35.7	-27.8	0	45.82	-	-	-	-	186	262	V

* - indicates frequency in CFR47 Pt 15 / IC RSS-Restricted Band

PK2 - KDB558074 Method: Maximum Peak

MAv1 - KDB558074 Option 1 Maximum RMS Average

HIGH CHANNEL RESULTS

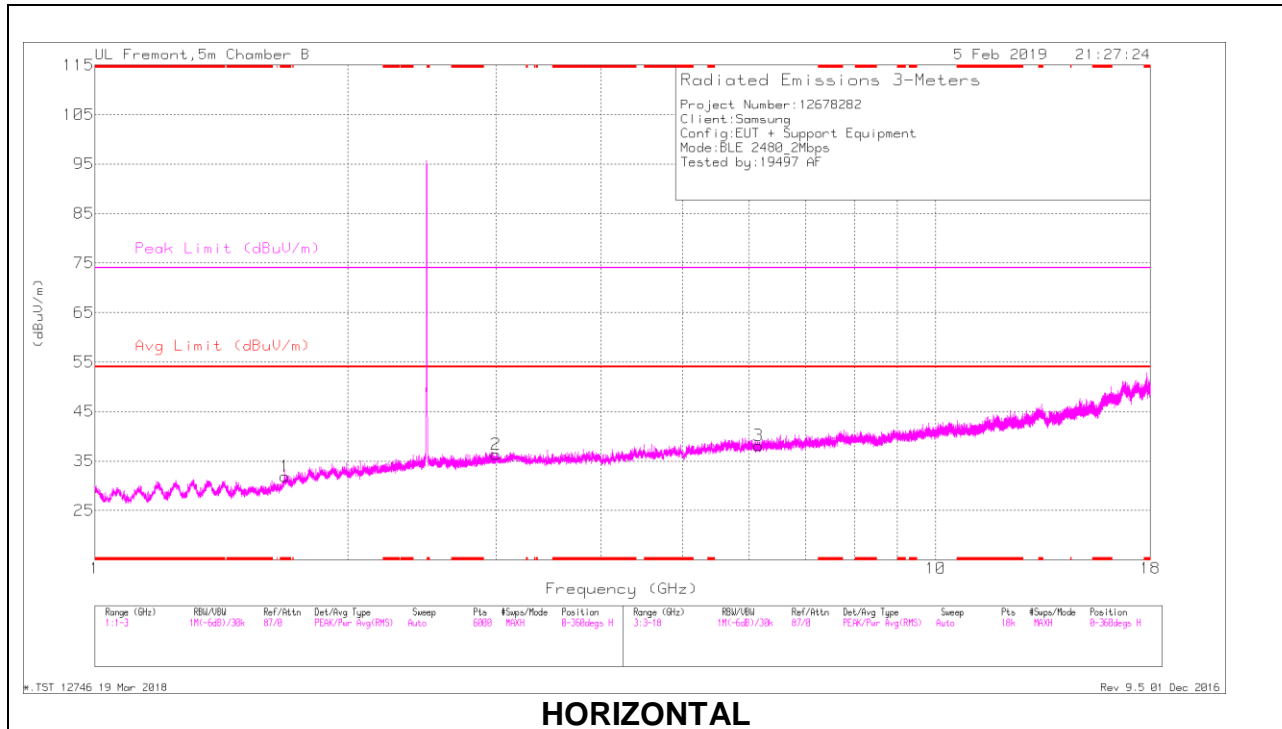

HORIZONTAL

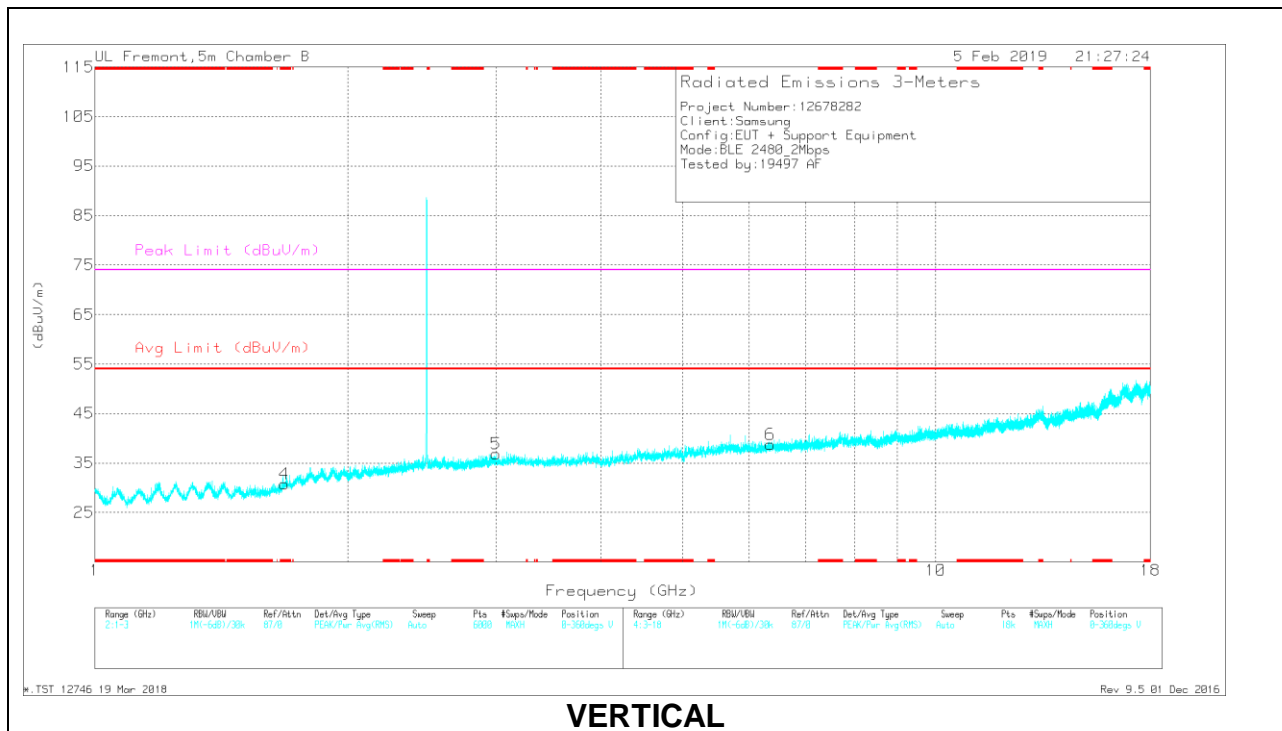

VERTICAL

RADIATED EMISSIONS

Frequency (GHz)	Meter Reading (dBuV)	Det	AF T863 (dB/m)	Amp/Cb/Filt/ Pad (dB)	DC Corr (dB)	Corrected Reading (dBuV/m)	Avg Limit (dBuV/m)	Margin (dB)	Peak Limit (dBuV/m)	PK Margin (dB)	Azimuth (Degs)	Height (cm)	Polarity
* 1.683	30	PK2	29.2	-21	0	38.2	-	-	74	-35.8	210	119	H
* 1.685	14.64	MAv1	29.3	-21.1	5.04	27.88	54	-26.12	-	-	210	119	H
* 1.682	30.16	PK2	29.2	-21	0	38.36	-	-	74	-35.64	207	120	V
* 1.682	14.71	MAv1	29.2	-21	5.04	27.95	54	-26.05	-	-	207	120	V
2.998	28.65	PK2	32.7	-19.1	0	42.25	-	-	-	-	14	366	H
3	28.8	PK2	32.7	-19.1	0	42.4	-	-	-	-	106	385	V
6.156	38.42	PK2	35.5	-28.9	0	45.02	-	-	-	-	212	311	H
6.358	38.66	PK2	35.7	-28.8	0	45.56	-	-	-	-	281	267	V

* - indicates frequency in CFR47 Pt 15 / IC RSS-Restricted Band

PK2 - KDB558074 Method: Maximum Peak

MAv1 - KDB558074 Option 1 Maximum RMS Average

12.3. Worst Case Below 30MHz

SPURIOUS EMISSIONS BELOW 30 MHz (WORST-CASE CONFIGURATION)

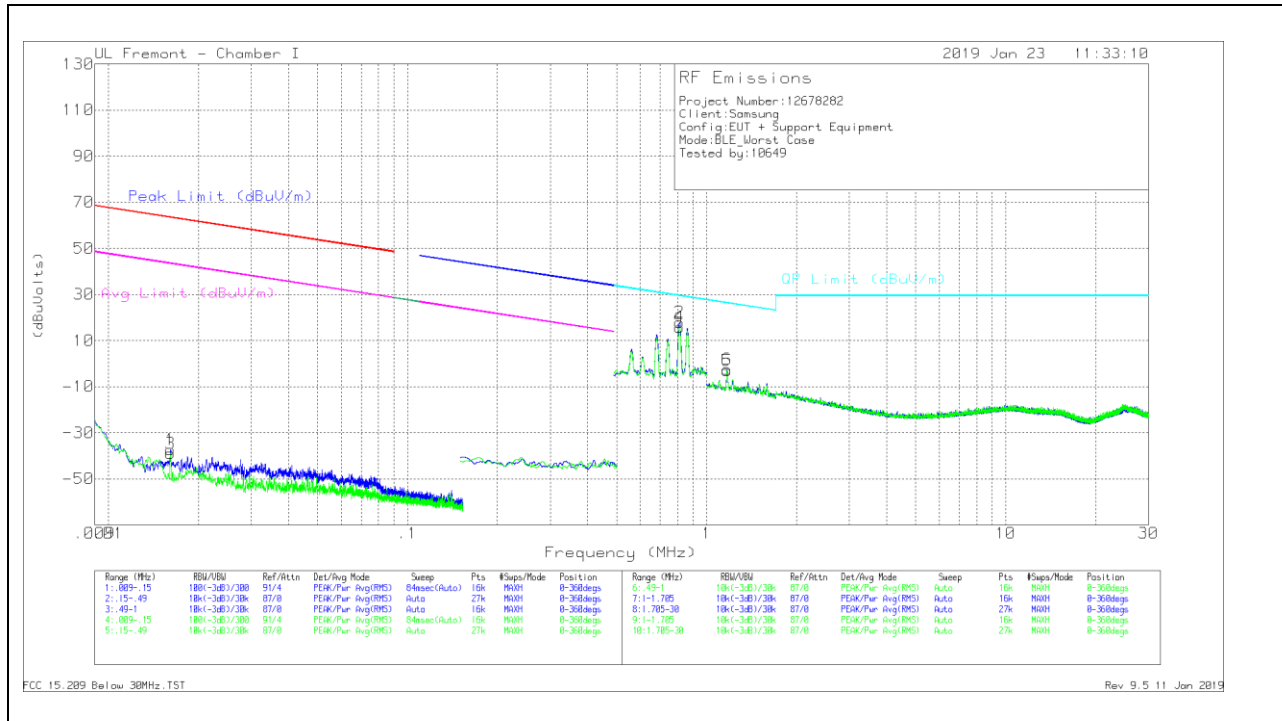

Below 30MHz Data

Marker	Frequency (MHz)	Meter Reading (dBuV)	Det	Loop Antenna (ACF)	Cables w/ PRE0 18017 5 (dB)	Dist Corr 300m	Corrected Reading (dBuVolts)	Peak Limit (dBuV /m)	Margin (dB)	Avg Limit (dBuV /m)	Margin (dB)	Azimuth (Degs)
1	.01615	15.56	Pk	59.5	-32.4	-80	-37.34	63.42	-100.76	43.42	-80.76	0-360
3	.01614	14.01	Pk	59.5	-32.4	-80	-38.89	63.43	-102.32	43.43	-82.32	0-360

Pk - Peak detector

Marker	Frequency (MHz)	Meter Reading (dBuV)	Det	Loop Antenna (ACF)	Cables w/ PRE0 18017 5 (dB)	Dist Corr 30m (dB) 40Log	Corrected Reading (dBuVolts)	QP Limit (dBuV /m)	Margin (dB)	Azimuth (Degs)
2	.81149	33.47	Pk	56.3	-31.8	-40	17.97	29.43	-11.46	0-360
4	.81178	31.35	Pk	56.3	-31.8	-40	15.85	29.43	-13.58	0-360
6	1.16955	23.84	Pk	45.5	-31.8	-40	-2.46	26.26	-28.72	0-360
5	1.17054	23.24	Pk	45.5	-31.8	-40	-3.06	26.26	-29.32	0-360

Pk - Peak detector

12.4. Worst Case Below 1 GHz

SPURIOUS EMISSIONS 30 TO 1000 MHz (WORST-CASE CONFIGURATION)

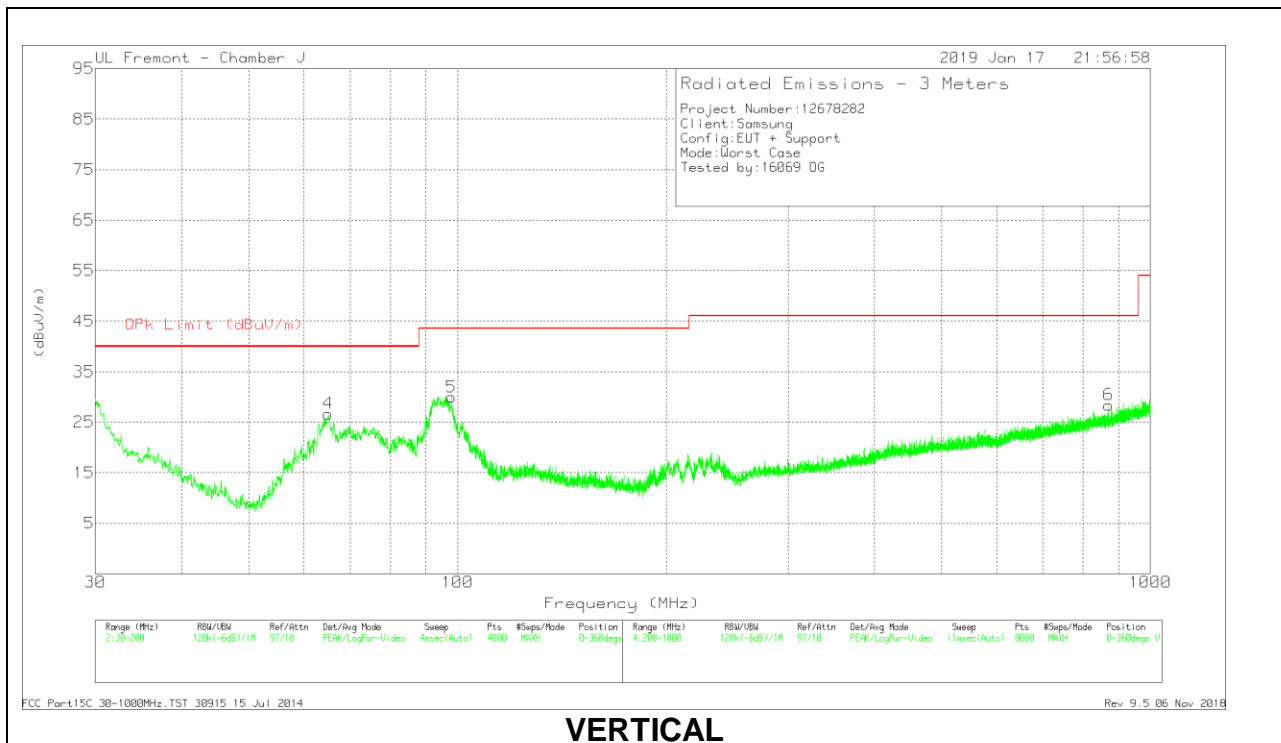
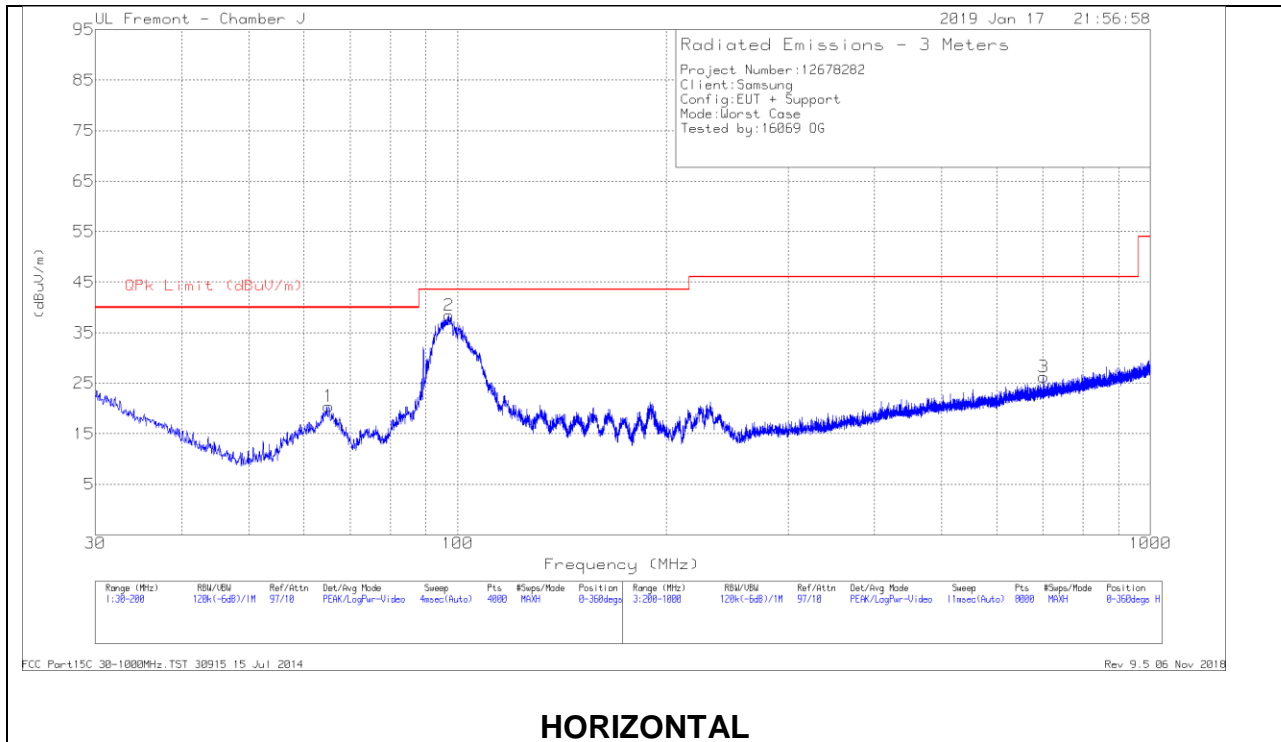

Below 1GHz Data

Marker	Frequency (MHz)	Meter Reading (dBuV)	Det	AF PRE0181575 (dB/m)	Amp Cbl (dB)	DC Corr (dB)	Corrected Reading (dBuV/m)	QPk Limit (dBuV/m)	Margin (dB)	Azimuth (Degs)	Height (cm)	Polarity
1	65.1566	37.83	Pk	13.8	-31.2	0	20.43	40	-19.57	0-360	299	H
2	97.2099	53.83	Pk	15.6	-31	0	38.43	43.52	-5.09	0-360	198	H
4	65.0716	44.07	Pk	13.8	-31.2	0	26.67	40	-13.33	0-360	101	V
5	98.0176	45.18	Pk	15.8	-31	0	29.98	43.52	-13.54	0-360	101	V
3	701.5652	28.95	Pk	26.2	-28.9	0	26.25	46.02	-19.77	0-360	398	H
6	871.3873	28.22	Pk	27.8	-27.6	0	28.42	46.02	-17.6	0-360	199	V

Pk - Peak detector

12.5. Worst Case 18-26 GHz

SPURIOUS EMISSIONS 18-26 GHz (WORST-CASE CONFIGURATION)

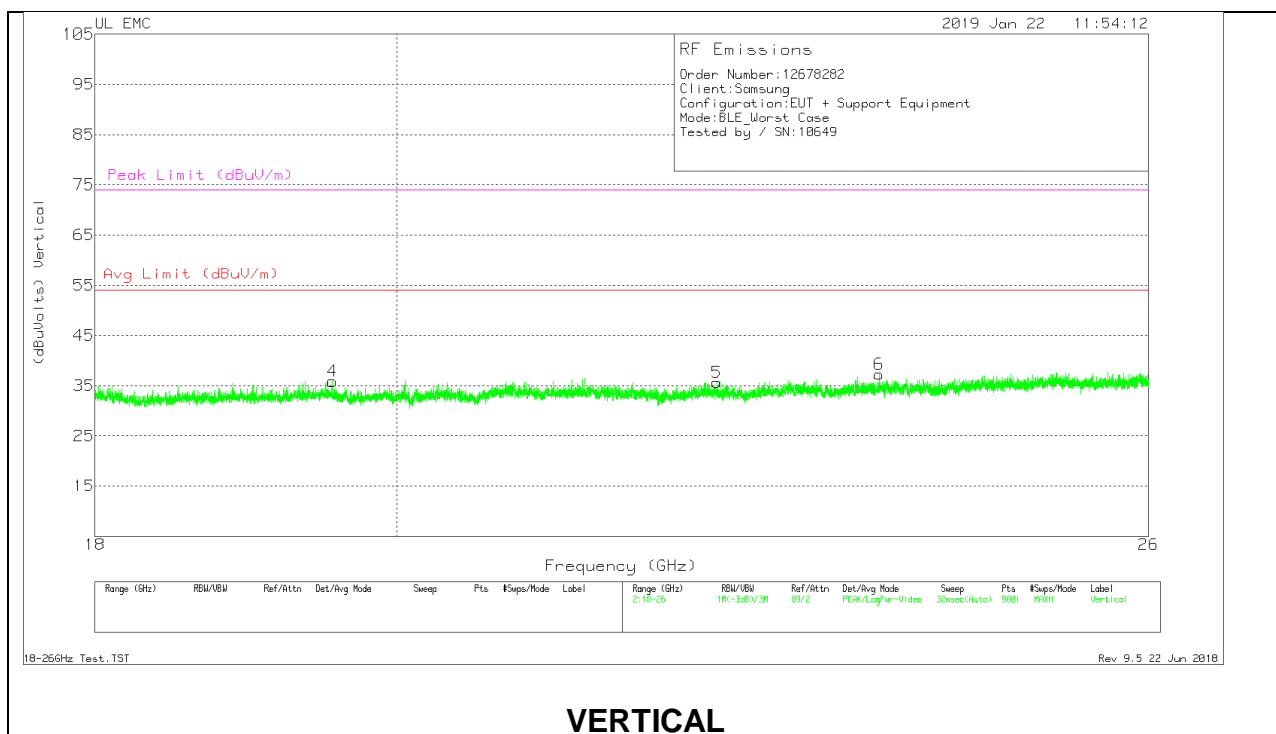
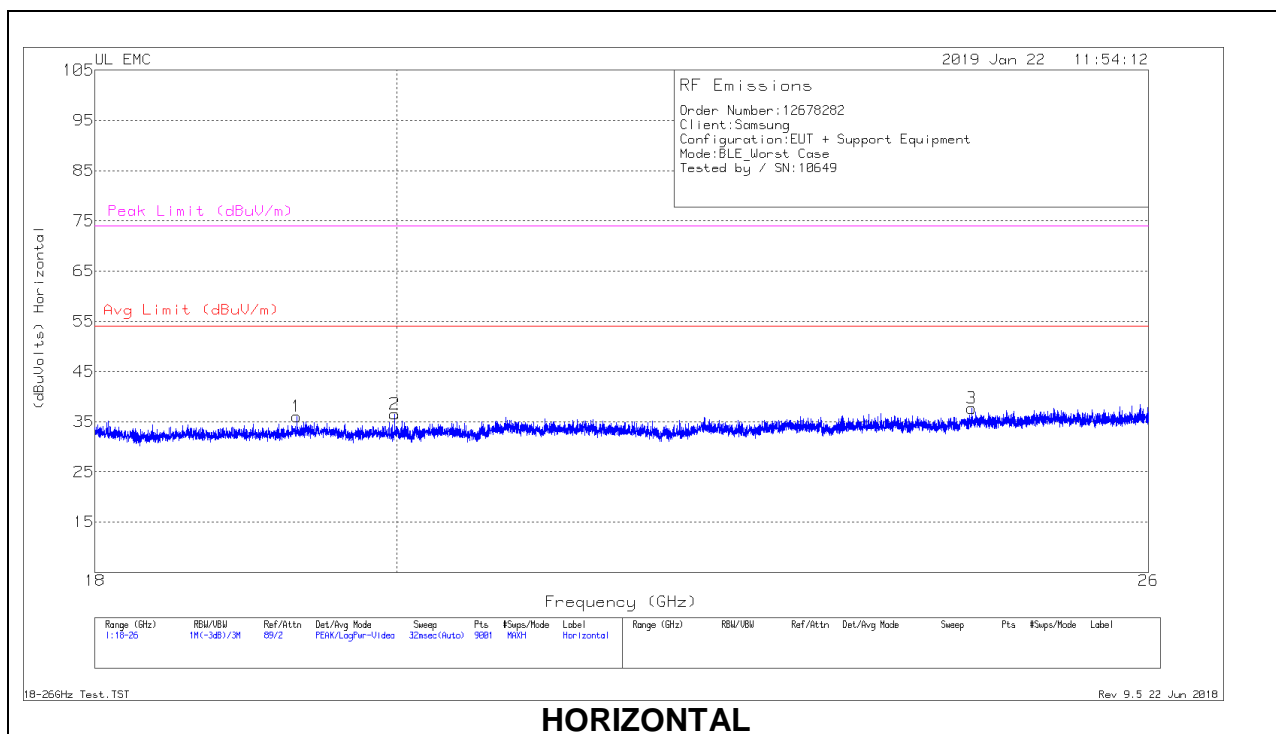

18 – 26GHz DATA

Marker	Frequency (GHz)	Meter Reading (dBuV)	Det	T448 AF (dB/m)	Amp/Cbl (dB)	Dist Corr (dB)	Corrected Reading (dBuVolts)	Avg Limit (dBuV/m)	Margin (dB)	Peak Limit (dBuV/m)	PK Margin (dB)
1	19.313	69.53	Pk	32.7	-56.7	-9.5	36.03	54	-17.97	74	-37.97
2	19.985	69.84	Pk	32.7	-56.5	-9.5	36.54	54	-17.46	74	-37.46
3	24.444	69.18	Pk	34.1	-56.1	-9.5	37.68	54	-16.32	74	-36.32
4	19.555	69.45	Pk	32.6	-56.7	-9.5	35.85	54	-18.15	74	-38.15
5	22.363	69.45	Pk	33.4	-57.7	-9.5	35.65	54	-18.35	74	-38.35
6	23.666	69.66	Pk	33.9	-56.8	-9.5	37.26	54	-16.74	74	-36.74

Pk - Peak detector

13. AC POWER LINE CONDUCTED EMISSIONS

LIMITS

FCC §15.207 (a)

Frequency of Emission (MHz)	Conducted Limit (dBuV)	
	Quasi-peak	Average
0.15-0.5	66 to 56*	56 to 46*
0.5-5	56	46
5-30	60	50

*Decreases with the logarithm of the frequency.

RESULTS

AC Power Line Norm

LINE 1 RESULTS

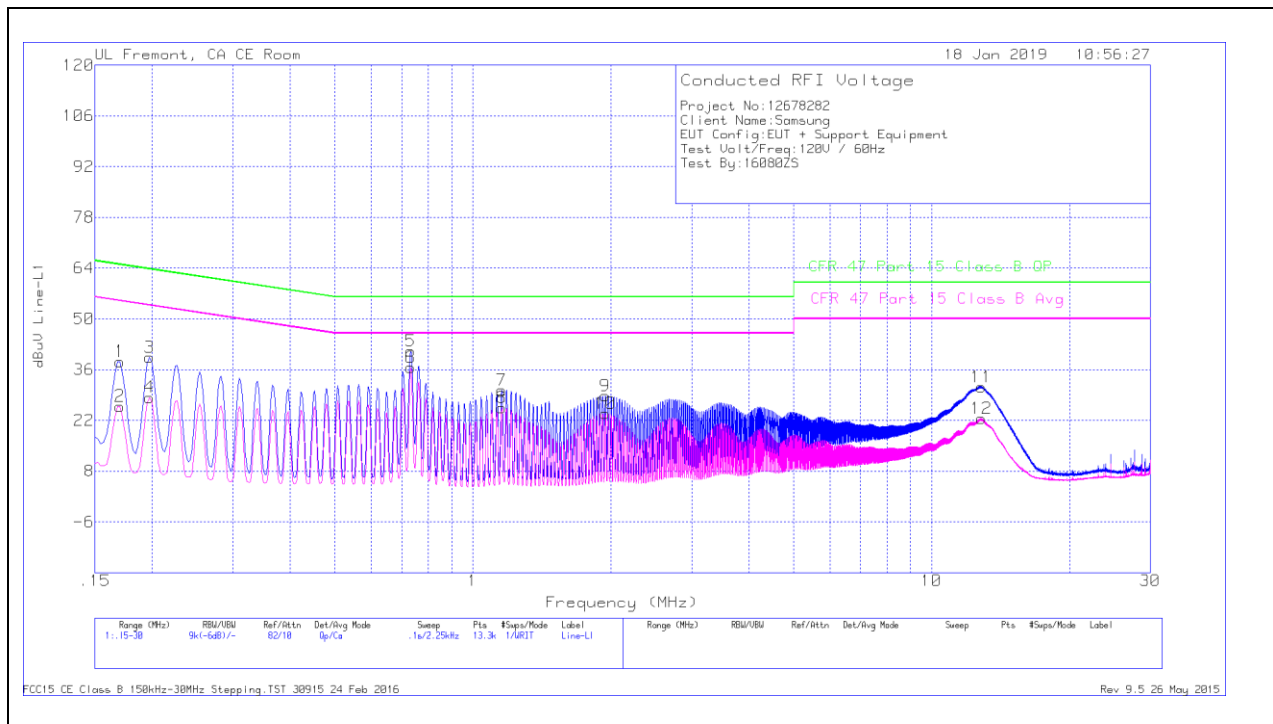

Range 1: Line-L1 .15 - 30MHz											
Marker	Frequency (MHz)	Meter Reading (dBuV)	Det	LISN L1	LC Cables C1&C3	Limiter (dB)	Corrected Reading dBuV	CFR 47 Part 15 Class B QP	QP Margin (dB)	CFR 47 Part 15 Class B Avg	Av(CISPR) Margin (dB)
1	.17025	28.16	Qp	0	0	10.1	38.26	64.95	-26.69	-	-
2	.17025	15.82	Ca	0	0	10.1	25.92	-	-	54.95	-29.03
3	.19725	29.28	Qp	0	0	10.1	39.38	63.73	-24.35	-	-
4	.19725	18.26	Ca	0	0	10.1	28.36	-	-	53.73	-25.37
5	.73275	31.11	Qp	0	0	10.1	41.21	56	-14.79	-	-
6	.73275	26.57	Ca	0	0	10.1	36.67	-	-	46	-9.33
7	1.15575	20.15	Qp	0	.1	10.1	30.35	56	-25.65	-	-
8	1.15575	15.27	Ca	0	.1	10.1	25.47	-	-	46	-20.53
9	1.9455	18.55	Qp	0	.1	10.1	28.75	56	-27.25	-	-
10	1.9455	13.75	Ca	0	.1	10.1	23.95	-	-	46	-22.05
11	12.858	20.79	Qp	.1	.2	10.2	31.29	60	-28.71	-	-
12	12.858	12.01	Ca	.1	.2	10.2	22.51	-	-	50	-27.49

Qp - Quasi-Peak detector

Ca - CISPR average detection

LINE 2 RESULTS

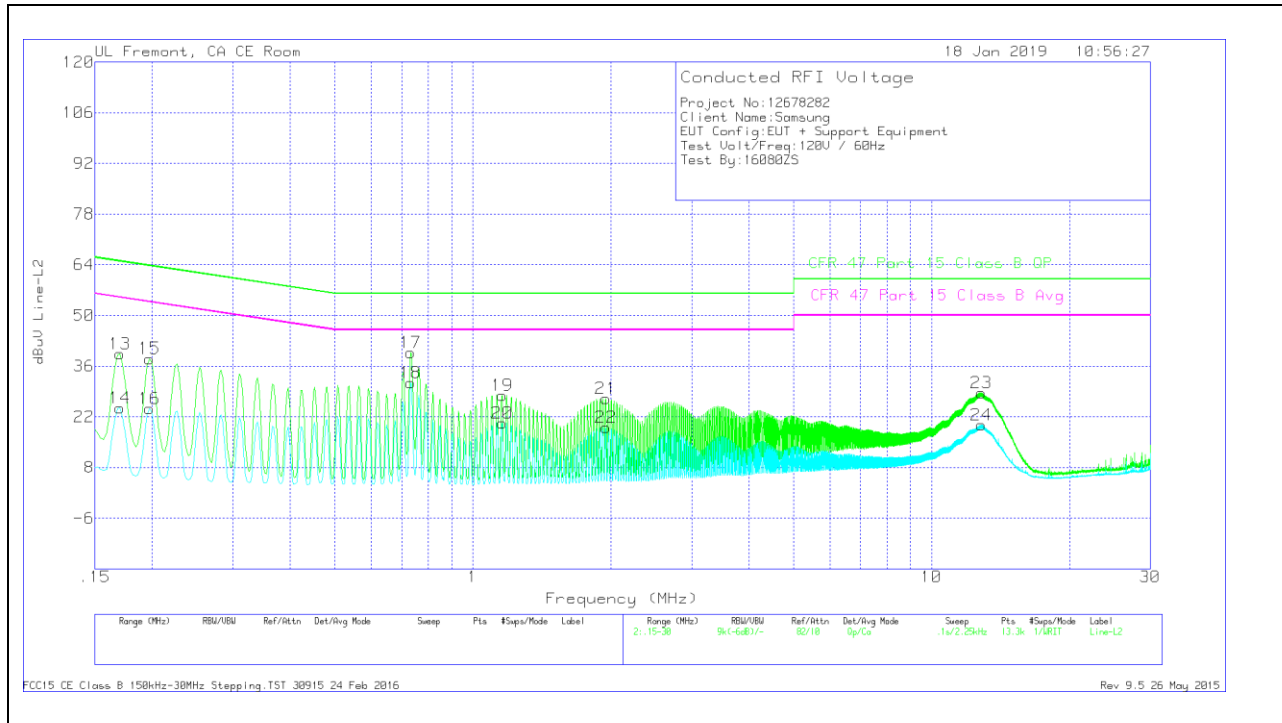

Range 2: Line-L2 .15 - 30MHz											
Marker	Frequency (MHz)	Meter Reading (dBuV)	Det	LISN L2	LC Cables C2&C3	Limiter (dB)	Corrected Reading dBuV	CFR 47 Part 15 Class B QP	QP Margin (dB)	CFR 47 Part 15 Class B Avg	Av(CISPR) Margin (dB)
13	.17025	29.23	Qp	0	0	10.1	39.33	64.95	-25.62	-	-
14	.17025	14.41	Ca	0	0	10.1	24.51	-	-	54.95	-30.44
15	.19725	27.99	Qp	0	0	10.1	38.09	63.73	-25.64	-	-
16	.19725	14.14	Ca	0	0	10.1	24.24	-	-	53.73	-29.49
17	.73275	29.59	Qp	0	0	10.1	39.69	56	-16.31	-	-
18	.73275	21.35	Ca	0	0	10.1	31.45	-	-	46	-14.55
19	1.158	17.75	Qp	0	.1	10.1	27.95	56	-28.05	-	-
20	1.158	10.04	Ca	0	.1	10.1	20.24	-	-	46	-25.76
21	1.94775	16.8	Qp	0	.1	10.1	27	56	-29	-	-
22	1.94775	8.92	Ca	0	.1	10.1	19.12	-	-	46	-26.88
23	12.83775	18.09	Qp	.1	.2	10.2	28.59	60	-31.41	-	-
24	12.84	9.25	Ca	.1	.2	10.2	19.75	-	-	50	-30.25

Qp - Quasi-Peak detector

Ca - CISPR average detection