



CERTIFICATION TEST REPORT

Report Number. : 12678284-E4V2

Applicant : Samsung Electronics Co., Ltd.
129 Samsung-Ro, Yeongtong-Gu,
Suwon-Si, Gyeonggi-Do, 16677, Korea

Model : SM-A305GN/DS and SM-A305GN

FCC ID : A3LSMA305GN

EUT Description : GSM/WCDMA/LTE Phone with BT, DTS/UNII a/b/g/n/ac, ANT+ and NFC

Test Standard(s) : FCC 47 CFR PART 15 SUBPART C

Date Of Issue:

February 20, 2019

Prepared by:

UL Verification Services Inc.
47173 Benicia Street
Fremont, CA 94538 U.S.A.
TEL: (510) 319-4000
FAX: (510) 661-0888



NVLAP Lab code: 200065-0

REPORT REVISION HISTORY

Rev.	Issue Date	Revisions	Revised By
V1	2/18/2019	Initial Issue	
V2	2/20/2019	Updated Section 2.3	K.Kedida

REPORT REVISION HISTORY	2
1. ATTESTATION OF TEST RESULTS	5
2. INTRODUCTION OF TEST DATA REUSE.....	6
2.1. INTRODUCTION	6
2.2. DIFFERENCES	6
2.3. SPOT CHECK VERIFICATION RESULTS SUMMARY	6
2.3.1. SPOT CHECK DATA	7
2.4. REFERENCE DETAIL	11
3. TEST METHODOLOGY	12
4. FACILITIES AND ACCREDITATION	12
5. CALIBRATION AND UNCERTAINTY	13
5.1. MEASURING INSTRUMENT CALIBRATION	13
5.2. SAMPLE CALCULATION	13
5.3. MEASUREMENT UNCERTAINTY.....	13
6. EQUIPMENT UNDER TEST	14
6.1. EUT DESCRIPTION	14
6.2. MAXIMUM OUTPUT POWER.....	14
6.3. DESCRIPTION OF AVAILABLE ANTENNAS	14
6.4. SOFTWARE AND FIRMWARE.....	14
6.5. WORST-CASE CONFIGURATION AND MODE.....	14
6.6. DESCRIPTION OF TEST SETUP.....	15
7. MEASUREMENT METHOD.....	18
8. TEST AND MEASUREMENT EQUIPMENT	19
9. ANTENNA PORT TEST RESULTS	20
9.1. ON TIME AND DUTY CYCLE.....	20
9.2. 99% BANDWIDTH.....	22
9.2.1. 802.11b MODE	23
9.2.2. 802.11g MODE	25
9.2.3. 802.11n HT20 MODE	27
9.3. 6 dB BANDWIDTH.....	29
9.3.1. 802.11b MODE	30
9.3.2. 802.11g MODE	32
9.3.3. 802.11n HT20 MODE	34
9.4. OUTPUT POWER.....	36

9.4.1.	802.11b MODE	37
9.4.2.	802.11g MODE	38
9.4.3.	802.11n HT20 MODE	39
9.5.	<i>POWER SPECTRAL DENSITY</i>	40
9.5.1.	802.11b MODE	41
9.5.2.	802.11g MODE	43
9.5.3.	802.11n HT20 MODE	45
9.6.	<i>CONDUCTED SPURIOUS EMISSIONS</i>	47
9.6.1.	RESULTS 802.11b MODE.....	47
9.6.2.	802.11g MODE	50
9.6.3.	802.11n HT20 MODE	52
10.	RADIATED TEST RESULTS.....	54
10.1.	<i>TRANSMITTER ABOVE 1 GHz</i>	56
10.1.1.	TX ABOVE 1 GHz 802.11b MODE IN THE 2.4 GHz BAND	56
10.1.2.	TX ABOVE 1 GHz 802.11g MODE IN THE 2.4 GHz BAND	70
10.1.3.	TX ABOVE 1 GHz 802.11n HT20 MODE IN THE 2.4 GHz BAND.....	84
10.2.	<i>Worst Case Below 30MHz</i>	98
10.3.	<i>Worst Case Below 1 GHz</i>	100
10.4.	<i>Worst Case 18-26 GHz</i>	102
11.	AC POWER LINE CONDUCTED EMISSIONS	104
11.1.1.	AC Power Line Norm	105
12.	SETUP PHOTOS.....	107
12.1.1.	A3LSMA305F (Original).....	107
12.1.2.	A3LSMA305GN (Spot Check).....	110

1. ATTESTATION OF TEST RESULTS

COMPANY NAME: Samsung Electronics Co., Ltd.
129 Samsung-Ro, Yeongtong-Gu,
Suwon-Si, Gyeonggi-Do, 16677, Korea

EUT DESCRIPTION: GSM/WCDMA/LTE Phone with BT, DTS/UNII a/b/g/n/ac, ANT+
and NFC

MODEL: SM-A305GN/DS and SM-A305GN

SERIAL NUMBER: R38KC08WJSN; R38KC08WKGY (Radiated)
R38KC08WHJE (Conducted) (Original)
R38KC0L4PSX; R38KC0L4PPB (Spot Check)

DATE TESTED: JANUARY 14 to 28, 2019 (Original)
JANUARY 28, 2019 (Spot Check)

APPLICABLE STANDARDS	
STANDARD	TEST RESULTS
CFR 47 Part 15 Subpart C	Complies

UL Verification Services Inc. tested the above equipment in accordance with the requirements set forth in the above standards. The test results show that the equipment tested is capable of demonstrating compliance with the requirements as documented in this report.

The results documented in this report apply only to the tested sample, under the conditions and modes of operation as described herein. It is the manufacturer's responsibility to assure that additional production units of this model are manufactured with identical electrical and mechanical components. All samples tested were in good operating condition throughout the entire test program. Measurement Uncertainties are published for informational purposes only and were not taken into account unless noted otherwise.

This document may not be altered or revised in any way unless done so by UL Verification Services Inc. and all revisions are duly noted in the revisions section. Any alteration of this document not carried out by UL Verification Services Inc. will constitute fraud and shall nullify the document. This report must not be used by the client to claim product certification, approval, or endorsement by NVLAP, NIST, any agency of the Federal Government, or any agency of the U.S. government.

Approved & Released For
UL Verification Services Inc. By:



DAN CORONIA
Operations Leader
Consumer Technology Division
UL Verification Services Inc.

Reviewed By:



KIYA KEDIDA
Project Engineer
Consumer Technology Division
UL Verification Services Inc.

2. INTRODUCTION OF TEST DATA REUSE

2.1. INTRODUCTION

According to the manufacturer, FCC ID: A3LSMA305F and FCC ID: A3LSMA305GN non-licensed radios are electrically identical. The FCC ID: A3LSMA305F test data shall remain representative of FCC ID: A3LSMA305GN.

The applicant takes full responsibility that the test data as referenced in this section represents compliance for this FCC ID.

2.2. DIFFERENCES

Difference between A3LSMA305F and A3LSMA305GN:

Samsung Electronics Co. Ltd. declares that A3LSMA305GN supports NFC function and the following additional WCDMA and LTE bands: WCDMA Band 4, LTE Band 2, Band 4, Band 12, Band 13, Band 17 and Band 66.

The FCC ID: A3LSMA305F, shares the same enclosure and circuit board as FCC ID: A3LSMA305GN. The DTS WLAN antennas and surrounding circuitry and layout are identical between two models.

After confirming through preliminary radiated emissions that the performance of the FCC ID: A3LSMA305F remains representative of FCC ID: A3LSMA305GN. The test data of FCC ID: A3LSMA305F being submitted for this application to cover DTS WLAN features.

2.3. SPOT CHECK VERIFICATION RESULTS SUMMARY

Spot check verification has been done on device A3LSMA305GN for radiated harmonic spurious and radiated band-edge. The data from the application has been verified through appropriate spot checks to demonstrate compliance for this device in accordance to FCC public KDB 484596 D01 as shown in the summary below.

A3LSMA305GN SPOT CHECK RESULTS										
Technology	Mode	Test Item	Channel	Measured Frequency	Original model		Spot check model		Delta (dB)	
					SM-A305F/DS	A3LSMA305F	SM-A305GN/DS	A3LSMA305GN		
					Peak	Ave	Peak	Ave	Peak	Ave
DTS	11n HT20	RBE	11	2484MHz	68.8	50.79	54.69	40.06	-14.11	-10.73
	11b mode	RSE	6	4874MHz	45.5	41.75	46.98	42.25	1.48	0.5

Comparison of the models, upper deviation is within 3dB range and all tests are under FCC Technical Limits.

2.3.1. SPOT CHECK DATA

BANDEDGE (HIGH CHANNEL)

HORIZONTAL RESULT

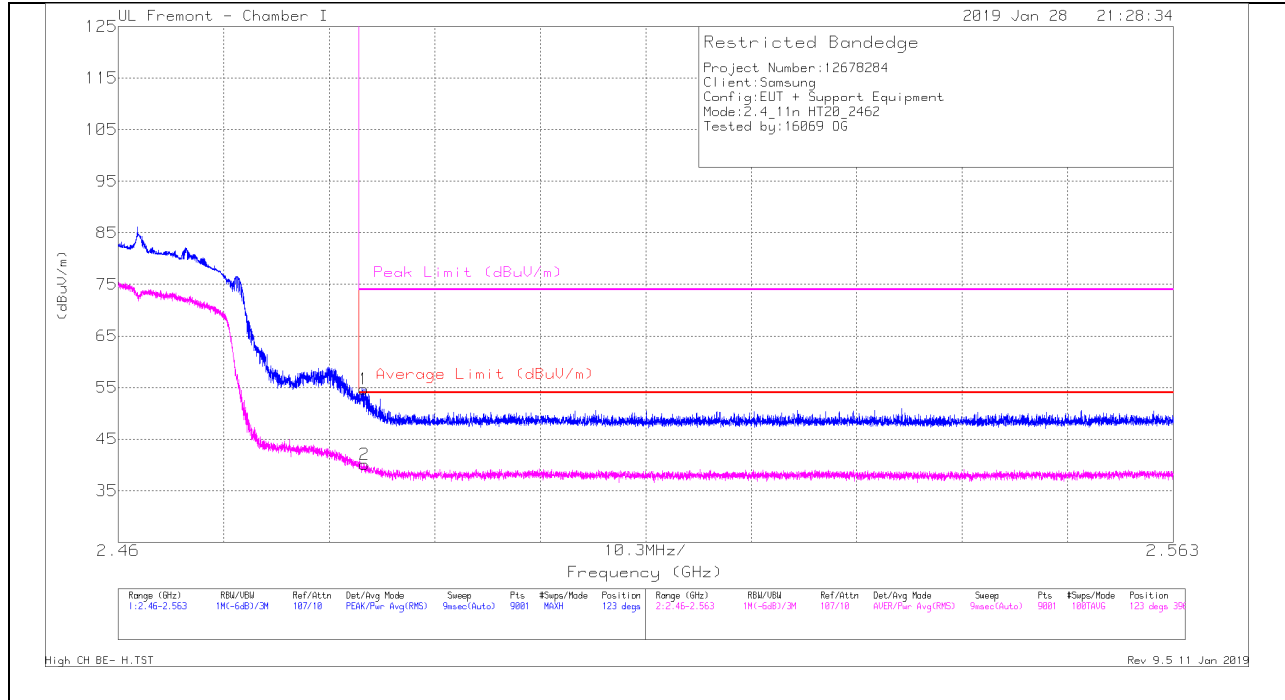

Trace Markers

Marker	Frequency (GHz)	Meter Reading (dBuV)	Det	AF T862 (dB/m)	Amp/Cb/Filt/Par d (dB)	DC Corr (dB)	Corrected Reading (dBuV/m)	Average Limit (dBuV/m)	Margin (dB)	Peak Limit (dBuV/m)	PK Margin (dB)	Azimuth (Degs)	Height (cm)	Polarity
1	2.484	43.99	PK	32.4	-21.7	0	54.69	-	-	74	-19.31	123	396	H
2	2.484	29.12	RMS	32.4	-21.7	.24	40.06	54	-13.94	-	-	123	396	H

Pk - Peak detector
 RMS - RMS detection

VERTICAL RESULT

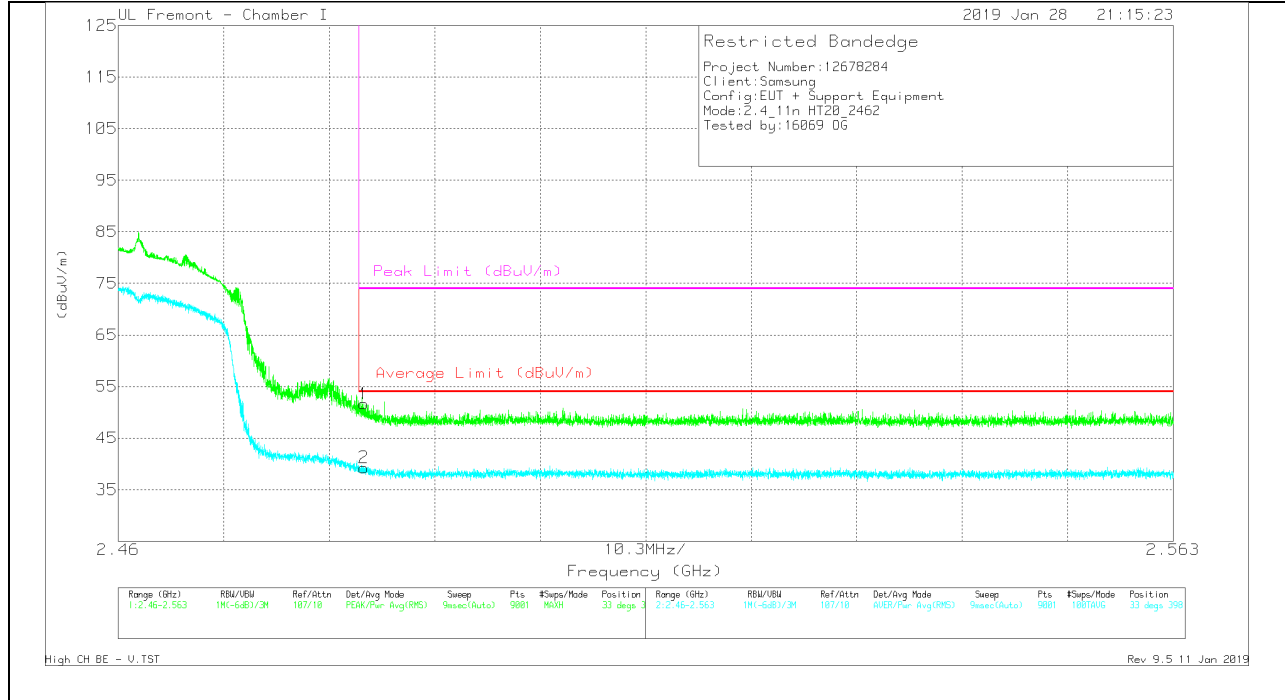

Trace Markers

Marker	Frequency (GHz)	Meter Reading (dBuV)	Det	AF T862 (dB/m)	Amp/Cb/Filt/Pa d (dB)	DC Corr (dB)	Corrected Reading (dBuV/m)	Average Limit (dBuV/m)	Margin (dB)	Peak Limit (dBuV/m)	PK Margin (dB)	Azimuth (Degs)	Height (cm)	Polarity
1	2.484	40.93	PK	32.4	-21.7	0	51.63	-	-	74	-22.37	33	398	V
2	2.484	28.32	RMS	32.4	-21.7	.24	39.26	54	-14.74	-	-	33	398	V

Pk - Peak detector
 RMS - RMS detection

HARMONICS AND SPURIOUS EMISSIONS

LOW CHANNEL RESULTS

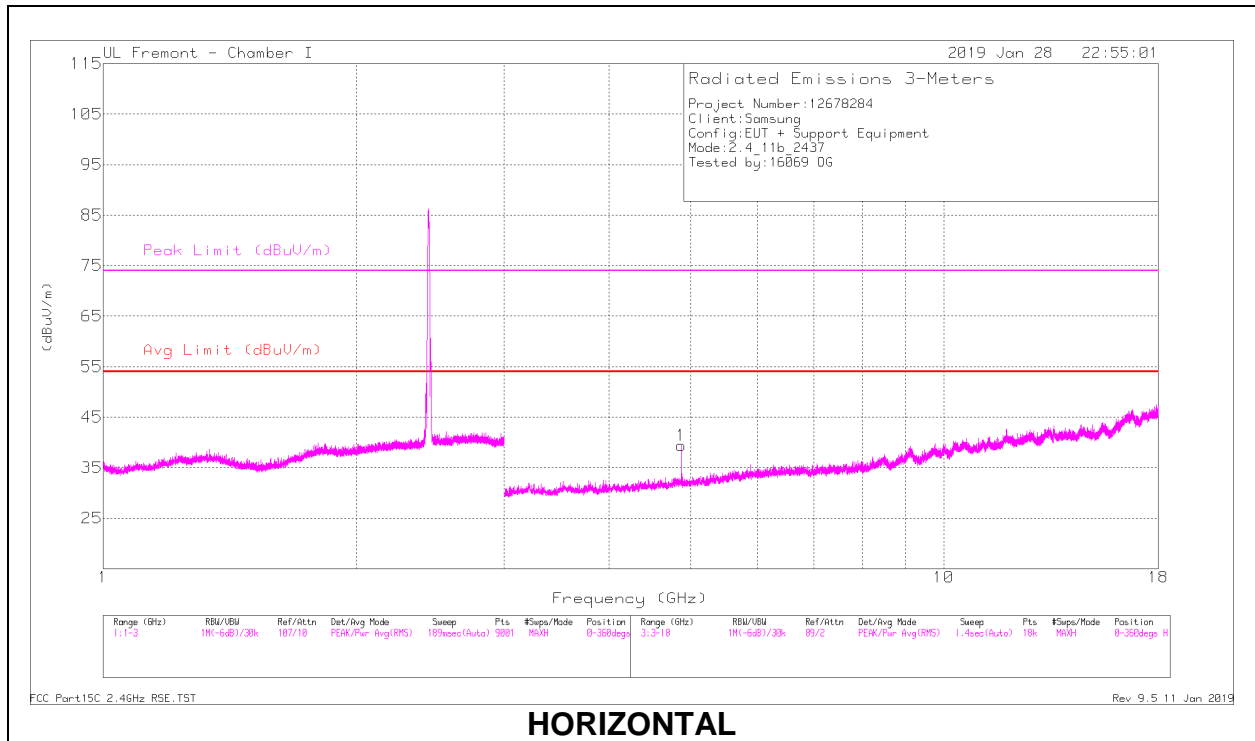

HORIZONTAL

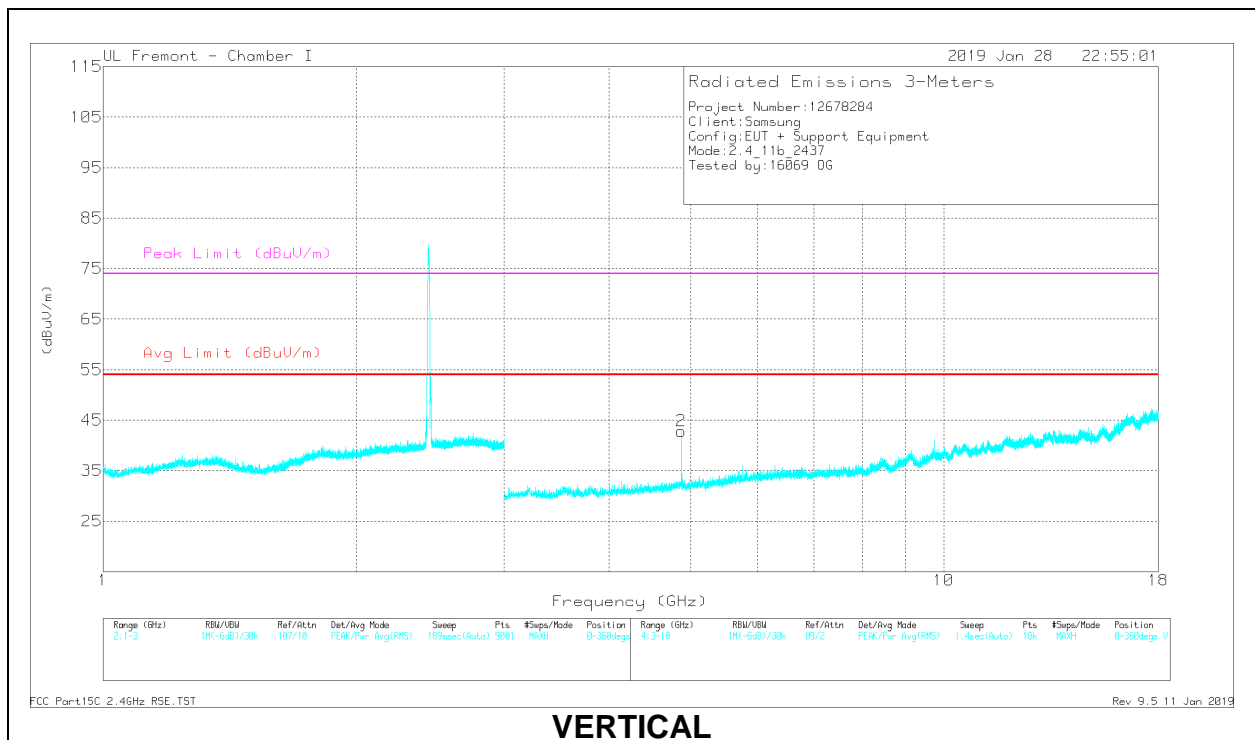

VERTICAL

RADIATED EMISSIONS

Frequency (GHz)	Meter Reading (dBuV)	Det	AF T862 (dB/m)	Amp/Cbl/FI tr/Pad (dB)	DC Corr (dB)	Corrected Reading (dBuV/m)	Avg Limit (dBuV/m)	Margin (dB)	Peak Limit (dBuV/m)	PK Margin (dB)	Azimuth (Degs)	Height (cm)	Polarity
4.874	38.03	PK2	34.2	-28.6	0	43.63	-	-	74	-30.37	49	307	H
4.874	31.97	MAv1	34.2	-28.6	0	37.57	54	-16.43	-	-	49	307	H
4.874	41.38	PK2	34.2	-28.6	0	46.98	-	-	74	-27.02	58	120	V
4.874	36.65	MAv1	34.2	-28.6	0	42.25	54	-11.75	-	-	58	120	V

PK2 - KDB558074 Method: Maximum Peak
 MAv1 - KDB558074 Option 1 Maximum RMS Average

2.4. REFERENCE DETAIL

Reference application that contains the reused reference data

Equipment Class	Reference FCC ID	Type Grant/ Permissive Change	Reference Application	Folder Test/RF Exposure	Report Title/Section
DTS	A3LSMA305F	Grant	12678282-E4	Test	FCC Report DTS WLAN / All sections

3. TEST METHODOLOGY

The tests documented in this report were performed in accordance with FCC CFR 47 Part 2, FCC CFR 47 Part 15, ANSI C63.10-2013, KDB 558074 D01 15.247 Meas Guidance v05

4. FACILITIES AND ACCREDITATION

The test sites and measurement facilities used to collect data are located at 47173 and 47266 Benicia Street, and 47658 Kato Road, Fremont, California, USA. Line conducted emissions are measured only at the 47173 address. The following table identifies which facilities were utilized for radiated emission measurements documented in this report. Specific facilities are also identified in the test results sections.

47173 Benicia Street	47266 Benicia Street	47658 Kato Rd
<input type="checkbox"/> Chamber A (ISED:2324B-1)	<input type="checkbox"/> Chamber D (ISED:22541-1)	<input checked="" type="checkbox"/> Chamber I (ISED:2324A-5)
<input type="checkbox"/> Chamber B (ISED:2324B-2)	<input type="checkbox"/> Chamber E (ISED:22541-2)	<input checked="" type="checkbox"/> Chamber J (ISED:2324A-6)
<input type="checkbox"/> Chamber C (ISED:2324B-3)	<input type="checkbox"/> Chamber F (ISED:22541-3)	<input checked="" type="checkbox"/> Chamber K (ISED:2324A-1)
	<input type="checkbox"/> Chamber G (ISED:22541-4)	<input checked="" type="checkbox"/> Chamber L (ISED:2324A-3)
	<input type="checkbox"/> Chamber H (ISED:22541-5)	

The above test sites and facilities are covered under FCC Test Firm Registration # 208313. Chambers above are covered under Industry Canada company address and respective code

UL Verification Services Inc. is accredited by NVLAP, Laboratory Code 200065-0

5. CALIBRATION AND UNCERTAINTY

5.1. MEASURING INSTRUMENT CALIBRATION

The measuring equipment utilized to perform the tests documented in this report has been calibrated in accordance with the manufacturer's recommendations, and is traceable to recognized national standards.

5.2. SAMPLE CALCULATION

RADIATED EMISSIONS

Where relevant, the following sample calculation is provided:

Field Strength (dBuV/m) = Measured Voltage (dBuV) + Antenna Factor (dB/m) + Cable Loss (dB) – Preamp Gain (dB)
 $36.5 \text{ dBuV} + 18.7 \text{ dB/m} + 0.6 \text{ dB} - 26.9 \text{ dB} = 28.9 \text{ dBuV/m}$

MAINS CONDUCTED EMISSIONS

Where relevant, the following sample calculation is provided:

Final Voltage (dBuV) = Measured Voltage (dBuV) + Cable Loss (dB) + Limiter Factor (dB) + LISN Insertion Loss.
 $36.5 \text{ dBuV} + 0 \text{ dB} + 10.1 \text{ dB} + 0 \text{ dB} = 46.6 \text{ dBuV}$

5.3. MEASUREMENT UNCERTAINTY

Where relevant, the following measurement uncertainty levels have been estimated for tests performed on the apparatus:

PARAMETER	UNCERTAINTY
Worst Case Conducted Disturbance, 9KHz to 0.15 MHz	3.84 dB
Worst Case Conducted Disturbance, 0.15 to 30 MHz	3.65 dB
Worst Case Radiated Disturbance, 9KHz to 30 MHz	3.15 dB
Worst Case Radiated Disturbance, 30 to 1000 MHz	5.36 dB
Worst Case Radiated Disturbance, 1000 to 18000 MHz	4.32 dB
Worst Case Radiated Disturbance, 18000 to 26000 MHz	4.45 dB
Worst Case Radiated Disturbance, 26000 to 40000 MHz	5.24 dB

Uncertainty figures are valid to a confidence level of 95%.

6. EQUIPMENT UNDER TEST

6.1. EUT DESCRIPTION

The EUT is a GSM/WCDMA/LTE phone with BT, DTS/UNII a/b/g/n/ac, ANT+ and NFC. The test report addresses the DTS WLAN operational mode

6.2. MAXIMUM OUTPUT POWER

The transmitter has a maximum conducted output power as follows:

Frequency Range (MHz)	Mode	Output Power (dBm)	Output Power (mW)
2412 - 2472	802.11b	18.97	78.89
2412 - 2472	802.11g	15.75	37.58
2412 - 2472	802.11n HT20	15.35	34.28

6.3. DESCRIPTION OF AVAILABLE ANTENNAS

The radio utilizes an FPCB antenna, with a maximum gain of -2.9dBi.

6.4. SOFTWARE AND FIRMWARE

The test utility software used during testing was A305F.001

6.5. WORST-CASE CONFIGURATION AND MODE

Radiated emissions below 1GHz, above 18GHz, and power line conducted emission were performed with the EUT set to transmit at the channel with highest output power as worst-case scenario.

Band edge and radiated emissions between 1GHz and 18GHz were performed with the EUT set to transmit at the highest power on low, middle and high channels.

The fundamental of the EUT was investigated in three orthogonal orientations X, Y, Z, it was determined that X orientation was worst-case orientation; therefore, all final radiated testing was performed with the EUT in X orientation.

Worst-case data rates as provided by the client were:

802.11b mode: 1 Mbps
802.11g mode: 6 Mbps
802.11n HT20mode: MCS0

6.6. DESCRIPTION OF TEST SETUP

SUPPORT EQUIPMENT

Support Equipment List				
Description	Manufacturer	Model	Serial Number	FCC ID
AC Adapter	Samsung	EP-TA50EWE	DW3J719AS/A-E	N/A
Earphone	Samsung	N/A	N/A	N/A

I/O CABLES (CONDUCTED TEST)

I/O Cable List						
Cable No	Port	# of identical ports	Connector Type	Cable Type	Cable Length (m)	Remarks
1	Antenna	1	RF	Shielded	0.2	To spectrum Analyzer
2	USB	1	USB	Un-shielded	1	EUT to AC Mains

I/O CABLES (RADIATED AND CONDUCTED EMISSIONS)

I/O Cable List						
Cable No	Port	# of identical ports	Connector Type	Cable Type	Cable Length (m)	Remarks
1	USB	1	USB	Shielded	1	N/A
2	earphone	1	3.5mm	Un-shielded	1	N/A

TEST SETUP

The EUT is a stand alone unit. Test software exercised the radio card.

CONDUCTED TEST SETUP DIAGRAM

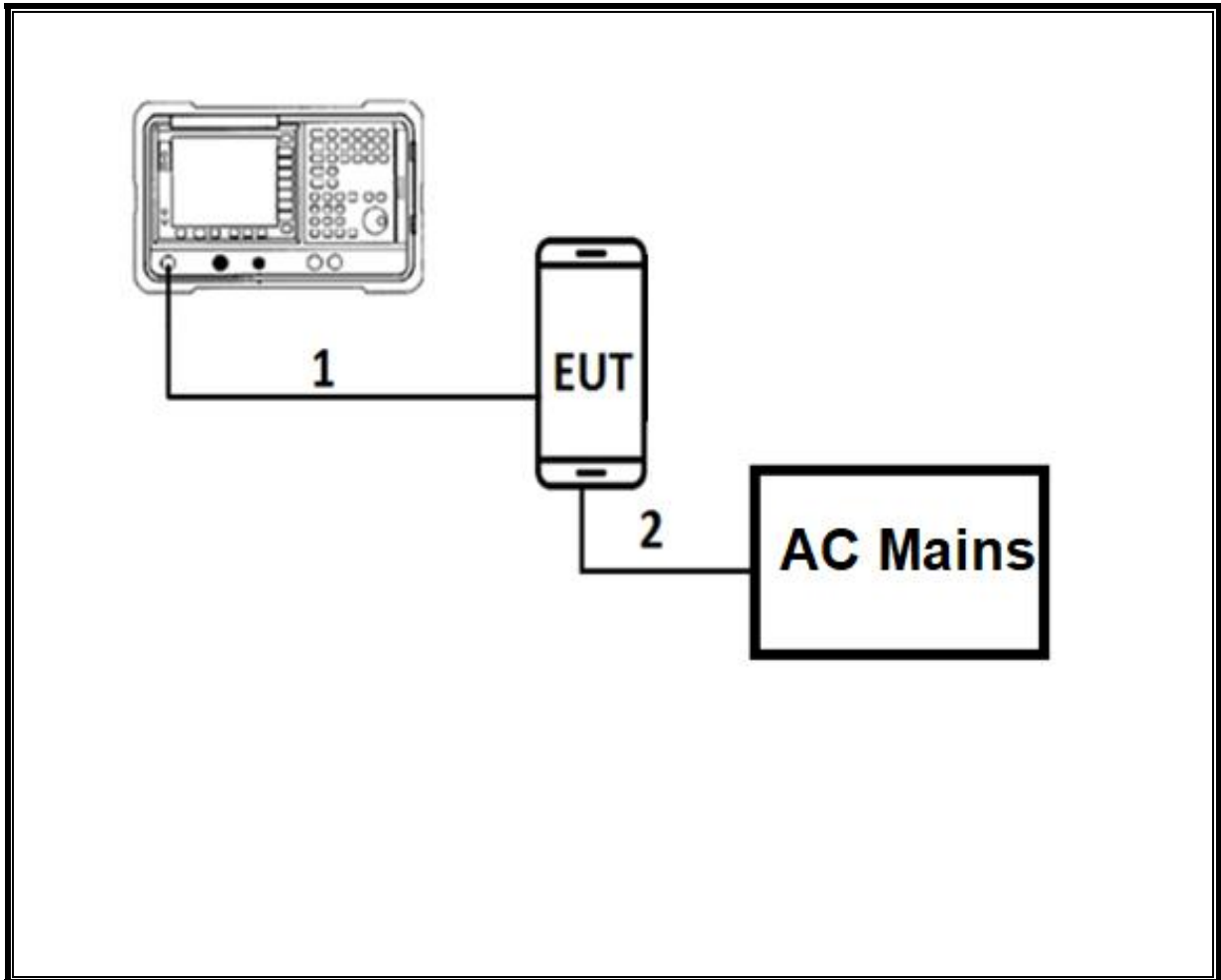

TEST SETUP

For conducted tests: the EUT was stand alone. The test software exercises the radio.

RADIATED AND AC LINE CONDUCTED EMISSIONS SETUP DIAGRAM

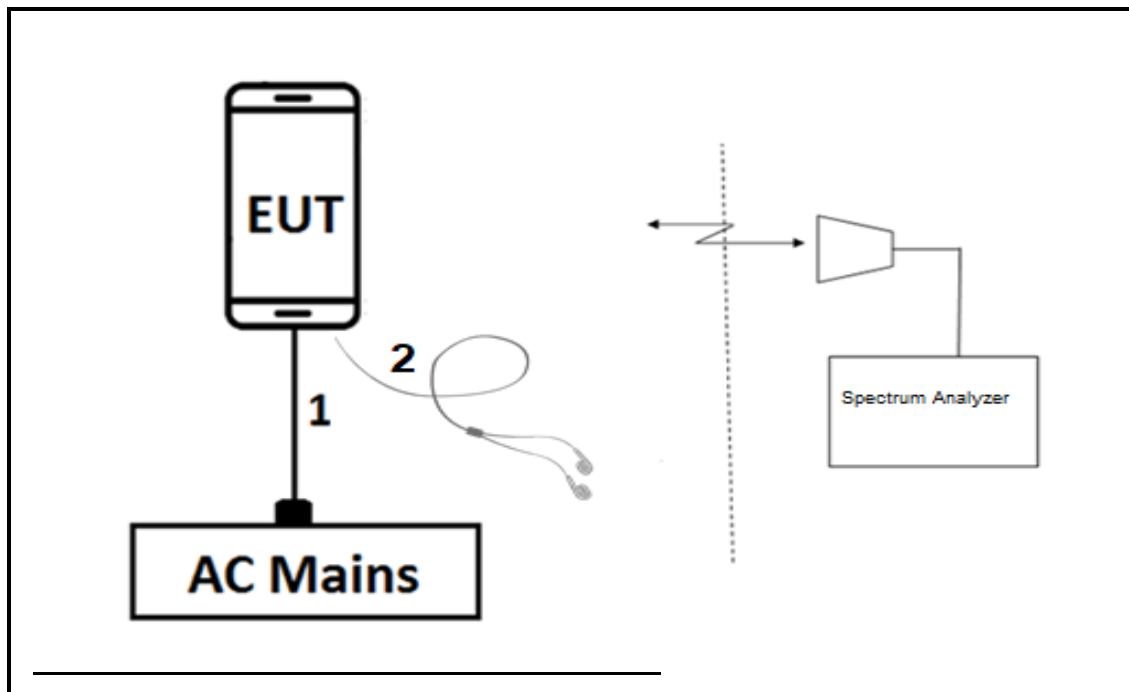

TEST SETUP

For radiated tests: EUT is stand alone. The test software exercises the radio.

7. MEASUREMENT METHOD

On Time and Duty Cycle: KDB 558074 D01 v05, Section 6.

6 dB BW: ANSI C63.10 Subclause -11.8.1 RBW \geq DTS BW

99% BW: ANSI C63.10-2013, Section 6.9.3.

Output Power: ANSI C63.10 Subclause -11.9.2.3.2 Method AVGPM-G (Measurement using a gated RF average-reading power meter)

PSD: ANSI C63.10 Subclause -11.10.3 Method AVGPSD-1

Radiated emissions non-restricted frequency bands: ANSI C63.10 Subclause -11.11

Radiated emissions restricted frequency bands: ANSI C63.10 Subclause -11.12.1

Conducted emissions in restricted frequency bands: ANSI C63.10 Subclause -11.12.2

Band-edge: ANSI C63.10 Subclause -11.13.3.2 Integration method -Peak detection

Band-edge: ANSI C63.10 Subclause -11.13.3.4 Integration method -Trace averaging across ON and OFF times DC correction

AC Power Line Conducted Emissions: ANSI C63.10-2013, Section 6.2.

8. TEST AND MEASUREMENT EQUIPMENT

The following test and measurement equipment was utilized for the tests documented in this report:

TEST EQUIPMENT LIST				
Description	Manufacturer	Model	Asset	Cal Due
Antenna, Passive Loop 9KHz to 1MHz	ELETRO METRICS	EM-6871	PRE0179465	05/22/2019
Antenna, Passive Loop 9KHz to 1MHz	ELETRO METRICS	EM-6872	PRE0179467	05/22/2019
Amplifier, 10KHz to 1GHz, 32dB	SONOMA INSTRUMENT	310	PRE0180175	07/09/2019
Antenna, Horn 1-18GHz	ETS Lindgren	3117	T862	05/24/2019
Amplifier, 1 to 18GHz	MITEQ	AFS42-00101800-25-S-42	PRE1782151	08/01/2019
Antenna, Horn 1-18GHz	ETS Lindgren	3117	AT0067	03/06/2019
Amplifier, 1 to 18GHz	Amplical	AMP1G18-35	T1571	07/30/2019
Antenna, Broadband Hybrid, 30MHz to 3000MHz	SunAR RF Motion	JB3	PRE0184970	11/13/2019
Amplifier, 10KHz to 1GHz, 32dB	SONOMA INSTRUMENT	310	PRE0180174	05/31/2019
Spectrum Analyzer, PXA, 3Hz to 44GHz	Keysight	E4446A	T146	08/13/2019
Antenna Horn, 18 to 26.5GHz	ARA	MWH-1826/B	T448	03/13/2019
Pre-Amp 1-26.5 GHz	Agilent	8449B	T404	03/09/2019
EMI Test Receiver	Rohde&Schwarz	ESW44	PRE0179372	05/04/2019
EMI Test Receiver	Rohde&Schwarz	ESW44	PRE0179367	04/28/2019
EMI Test Receiver	Rohde&Schwarz	ESW44	PRE0179375	05/08/2019
EMI Test Receiver	Rohde&Schwarz	ESW44	PRE0179376	05/08/2019
EMI Test Receiver	Rohde&Schwarz	ESW44	PRE0179377	11/02/2019
Power Meter, P-series single channel	Agilent (Keysight) Technologies	N1911A	T1271	07/17/2019
Power Sensor, P-series, 50MHz to 18GHz, Wideband	Agilent (Keysight) Technologies	N1921A	T1225	04/10/2019
AC Line Conducted				
EMI Receiver	Rohde & Schwarz	ESR	T1436	02/21/2019
LISN for Conducted Emissions CISPR-16	FCC INC.	FCC LISN 50/250	T1310	06/15/2019
UL AUTOMATION SOFTWARE				
Radiated Software	UL	UL EMC	Ver 9.5, June 22, 2018	
Antenna Port Software	UL	UL RF	Ver 8.8.1, Sep 26, 2018	
AC Line Conducted Software	UL	UL EMC	Ver 9.5, May 26, 2015	

NOTES:

1. Equipment listed above that calibrated during the testing period was set for test after the calibration.
2. Equipment listed above that has a calibration due date during the testing period, the testing is completed before equipment expiration date.

9. ANTENNA PORT TEST RESULTS

9.1. ON TIME AND DUTY CYCLE

LIMITS

None; for reporting purposes only.

PROCEDURE

KDB 558074 D01 Zero-Span Spectrum Analyzer Method.

ON TIME AND DUTY CYCLE RESULTS

Mode	ON Time B (msec)	Period (msec)	Duty Cycle x (linear)	Duty Cycle (%)	Duty Cycle Correction Factor (dB)	1/B Minimum VBW (kHz)
2.4GHz Band						
802.11b 1TX	50.00	50.00	1.000	100.00%	0.00	0.010
802.11g 1TX	1.403	1.537	0.913	91.28%	0.40	0.713
802.11n HT20 1TX	1.344	1.420	0.946	94.65%	0.24	0.744

DUTY CYCLE PLOTS

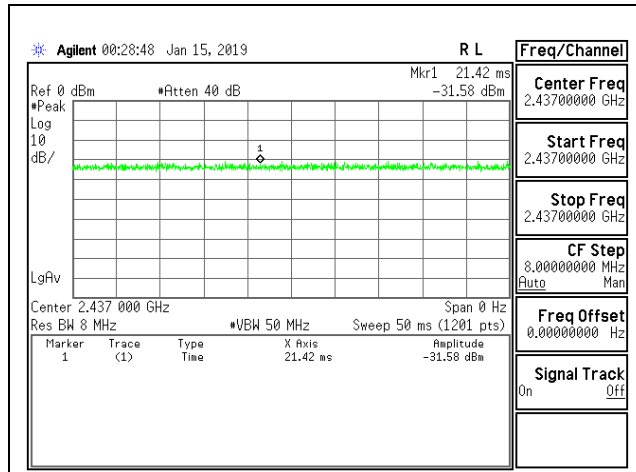

DUTY CYCLE 802.11b MODE

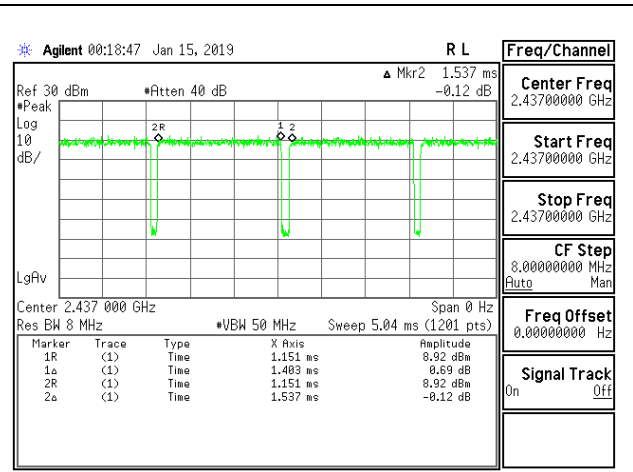

DUTY CYCLE 802.11g MODE

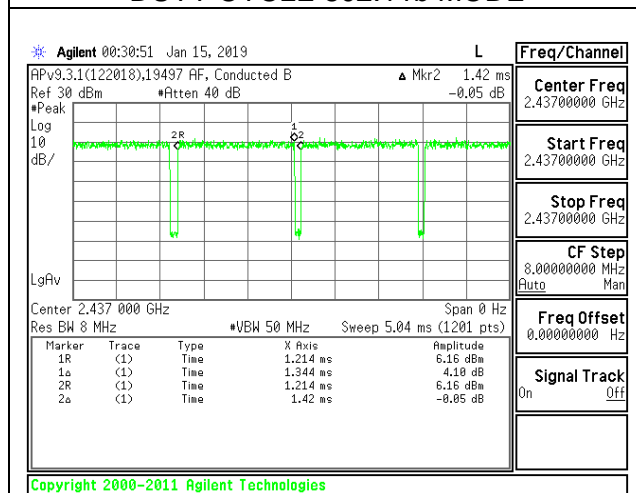

DUTY CYCLE 802.11n HT20 MODE

9.2. 99% BANDWIDTH

LIMITS

None; for reporting purposes only.

RESULTS

9.2.1. 802.11b MODE

1TX Antenna 1 MODE

Channel	Frequency (MHz)	99% Bandwidth (MHz)
Low 1	2412	13.182
Mid 6	2437	13.152
High 11	2462	13.306
High 12	2467	13.297
High 13	2472	13.815

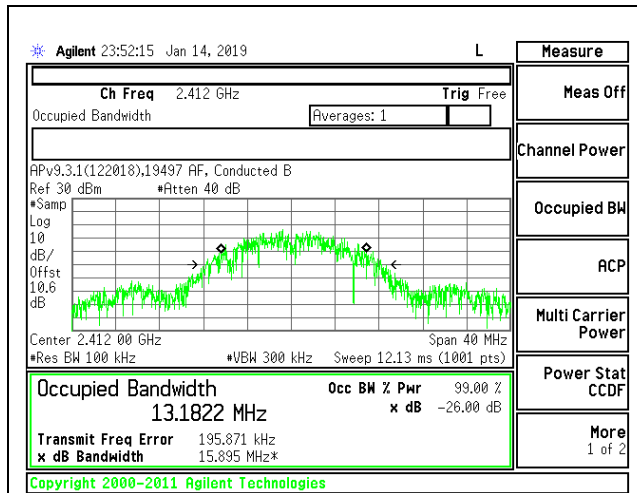

LOW CHANNEL 1

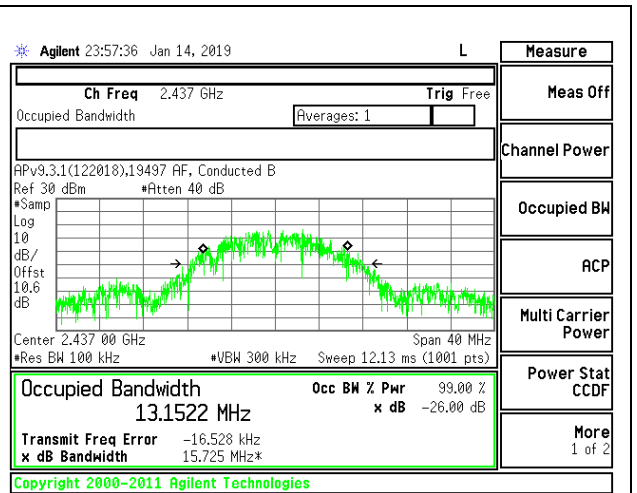

MID CHANNEL 6

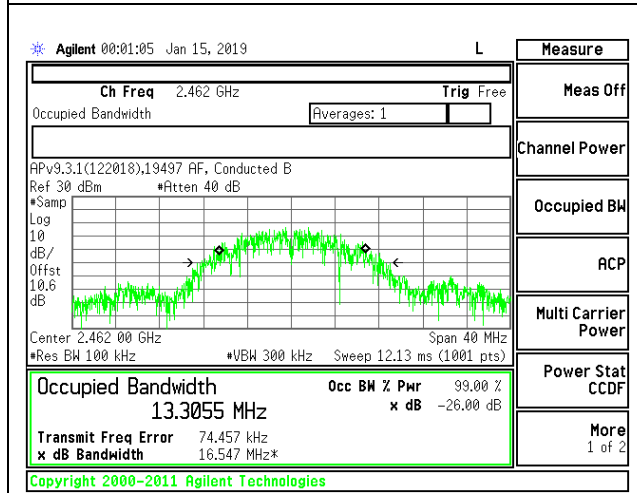

HIGH CHANNEL 11

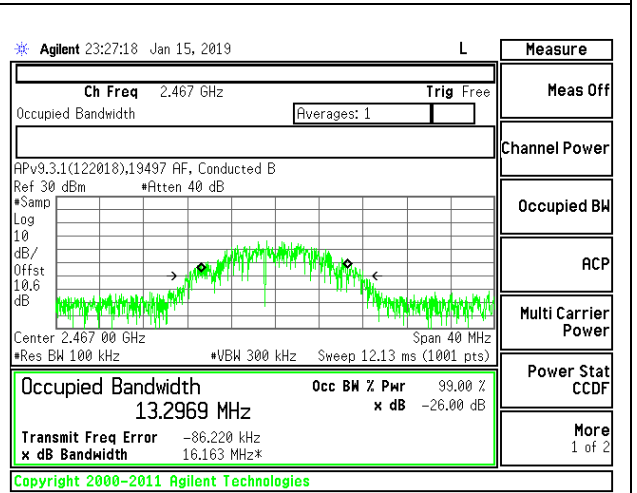

HIGH CHANNEL 12

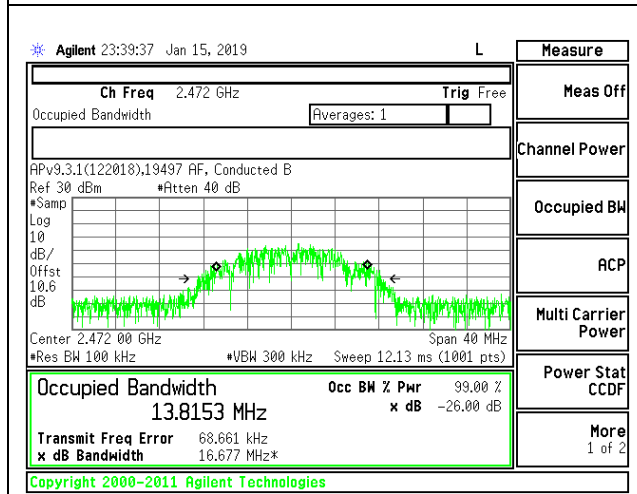

HIGH CHANNEL 13

9.2.2. 802.11g MODE

1TX Antenna 1 MODE

Channel	Frequency (MHz)	99% Bandwidth (MHz)
Low 1	2412	16.525
Mid 6	2437	16.375
High 11	2462	16.440
High 12	2467	16.556
High 13	2472	16.501

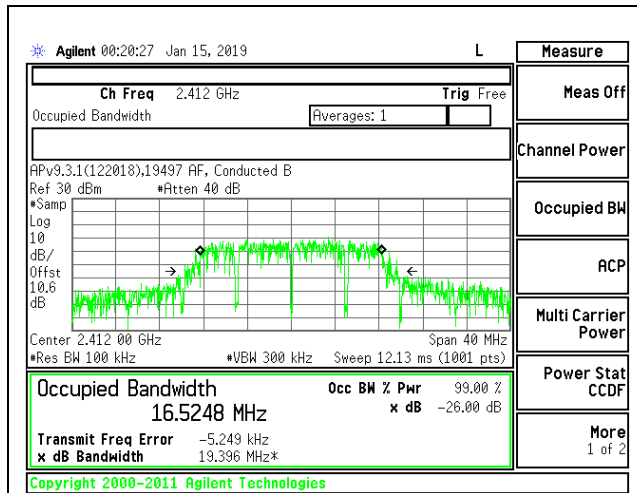

LOW CHANNEL 1

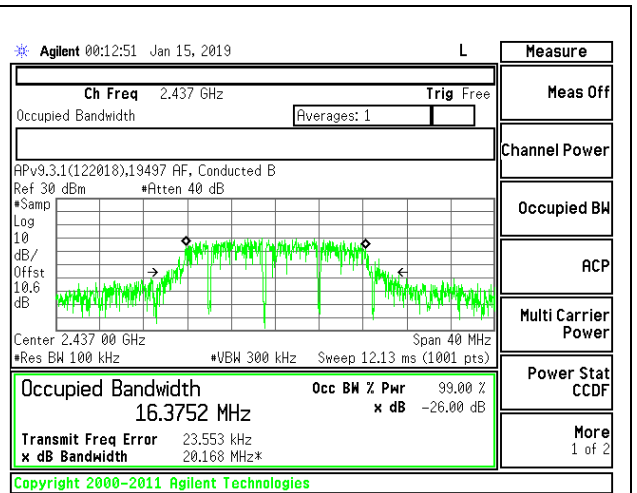

MID CHANNEL 6

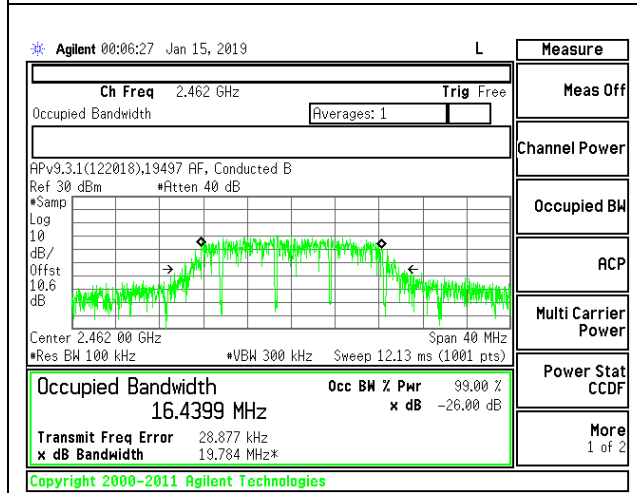

HIGH CHANNEL 11

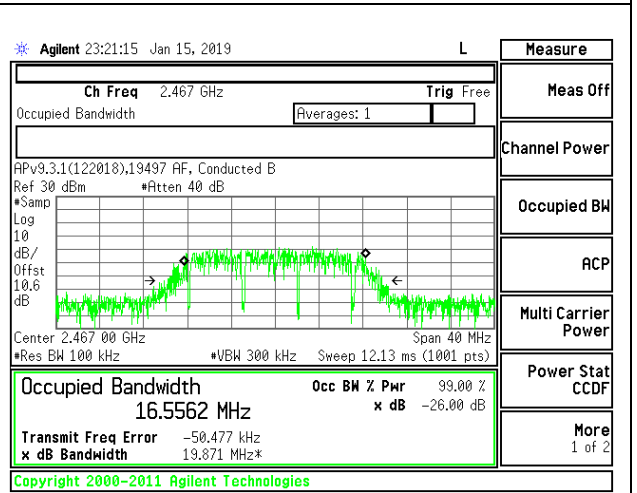

HIGH CHANNEL 12

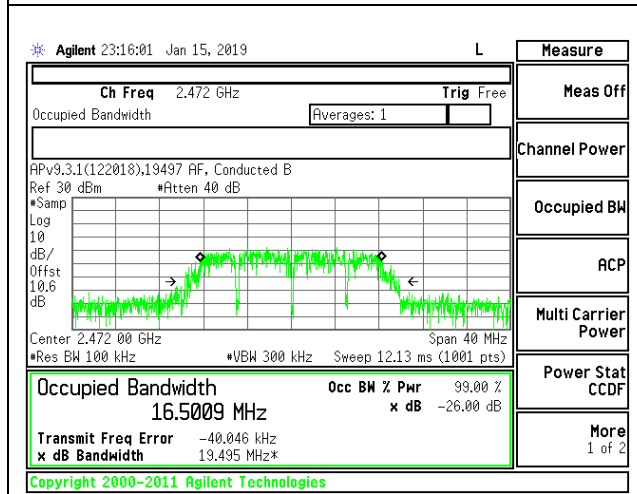

HIGH CHANNEL 13

9.2.3. 802.11n HT20 MODE

1TX Antenna 1 MODE

Channel	Frequency (MHz)	99% Bandwidth (MHz)
Low 1	2412	17.542
Mid 6	2437	17.474
High 11	2462	17.710
High 12	2467	17.503
High 13	2472	17.428

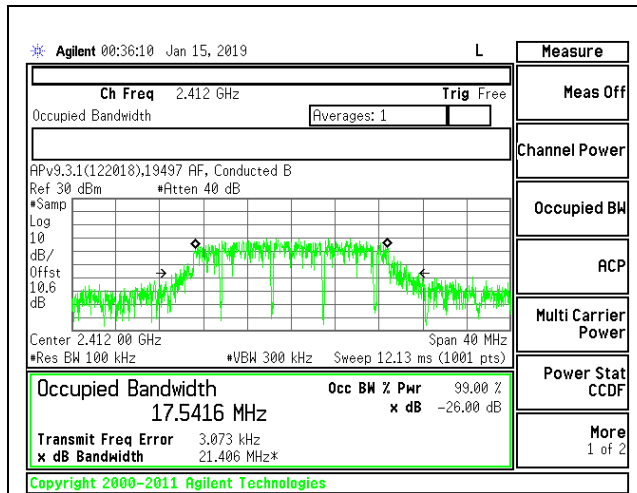

LOW CHANNEL 1

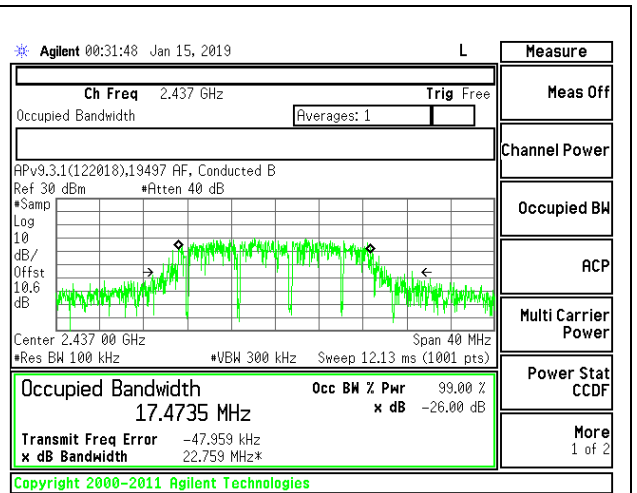

MID CHANNEL 6

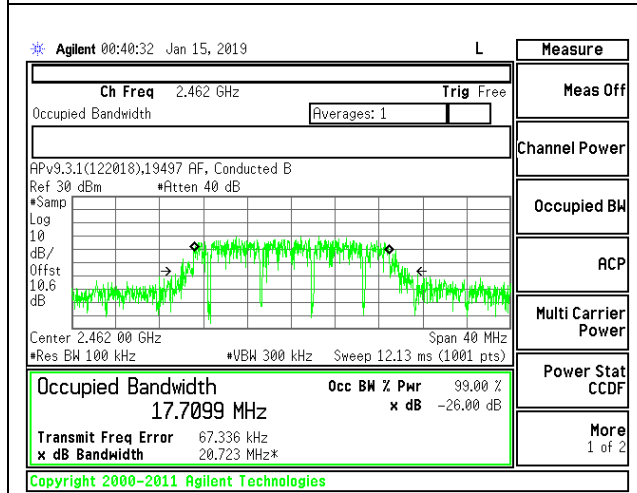

HIGH CHANNEL 11

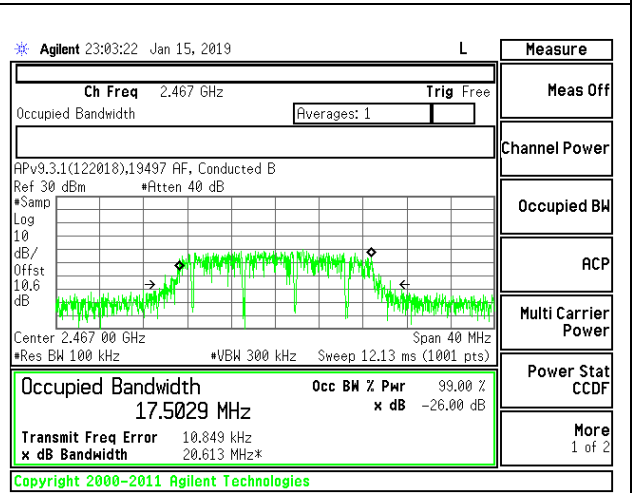

HIGH CHANNEL 12

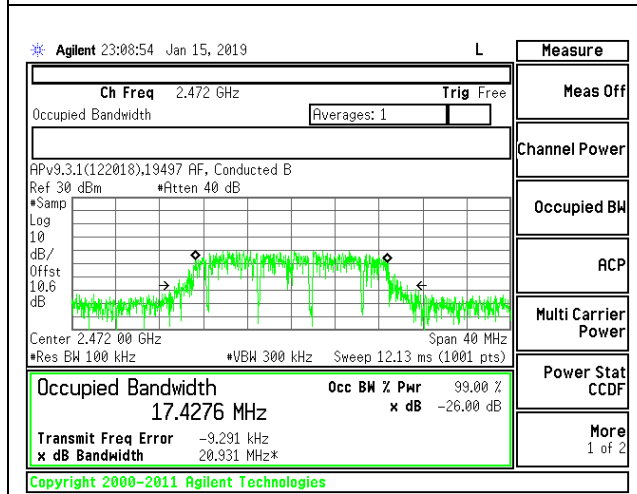

HIGH CHANNEL 13

9.3. 6 dB BANDWIDTH

LIMITS

FCC §15.247 (a) (2)

The minimum 6 dB bandwidth shall be at least 500 kHz.

RESULTS

9.3.1. 802.11b MODE

1TX Antenna 1 MODE

Channel	Frequency (MHz)	6 dB Bandwidth (MHz)	Minimum Limit (MHz)
Low 1	2412	7.60	0.5
Mid 6	2437	7.12	0.5
High 11	2462	7.56	0.5
High 12	2467	8.08	0.5
High 13	2472	7.76	0.5

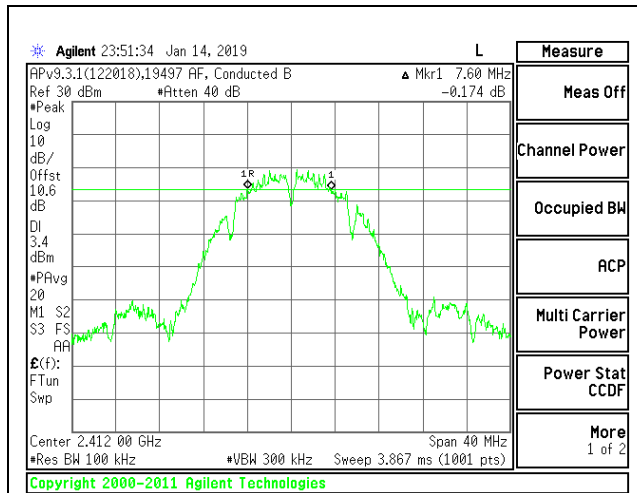

LOW CHANNEL 1

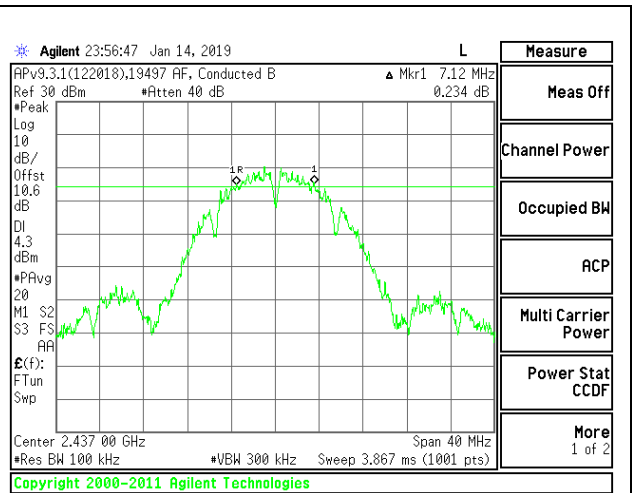

MID CHANNEL 6

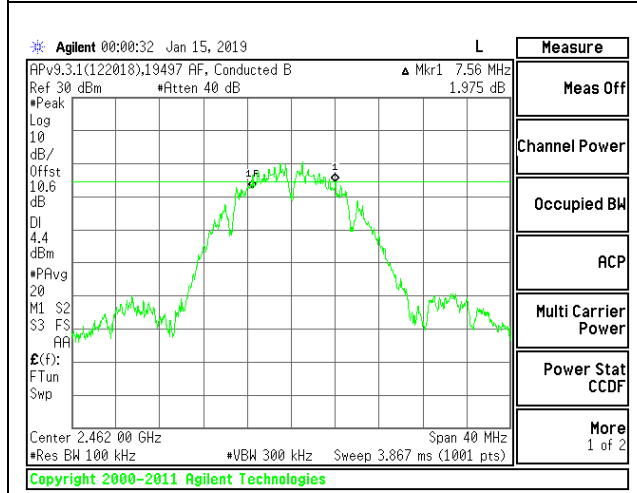

HIGH CHANNEL 11

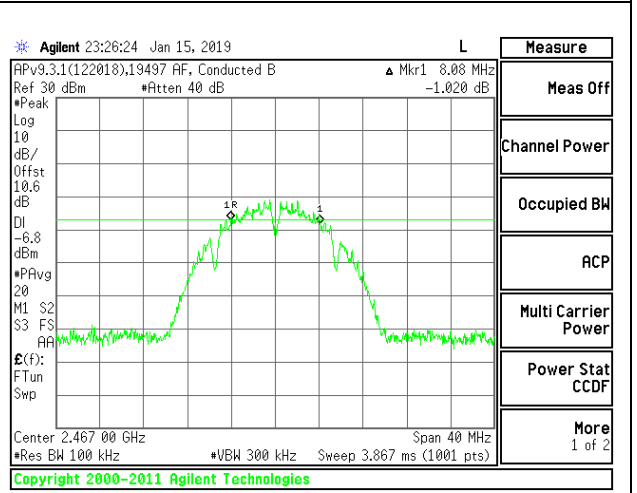

HIGH CHANNEL 12

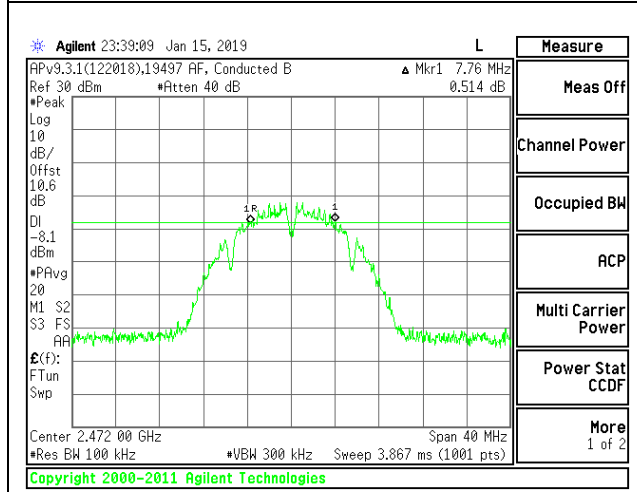

HIGH CHANNEL 13

9.3.2. 802.11g MODE

1TX Antenna 1 MODE

Channel	Frequency (MHz)	6 dB Bandwidth (MHz)	Minimum Limit (MHz)
Low 1	2412	15.28	0.5
Mid 6	2437	14.48	0.5
High 11	2462	15.92	0.5
High 12	2467	16.40	0.5
High 13	2472	15.84	0.5

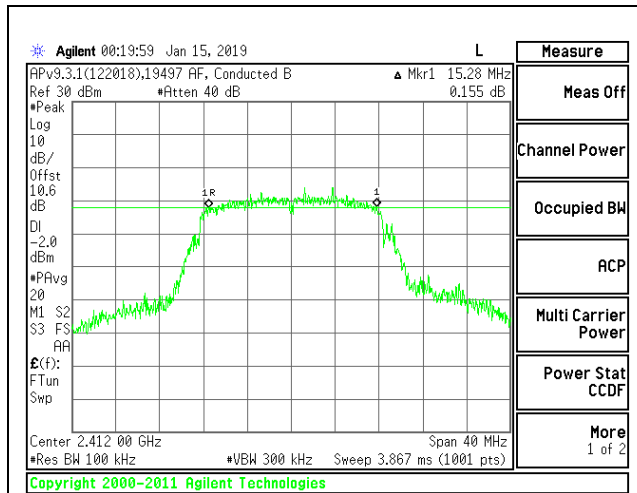

LOW CHANNEL 1

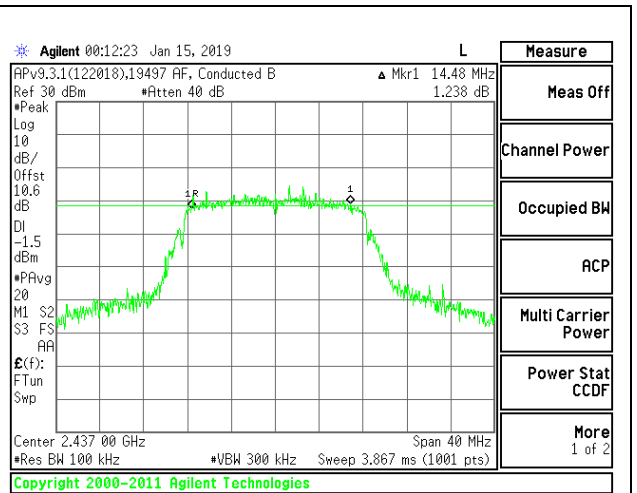

MID CHANNEL 6

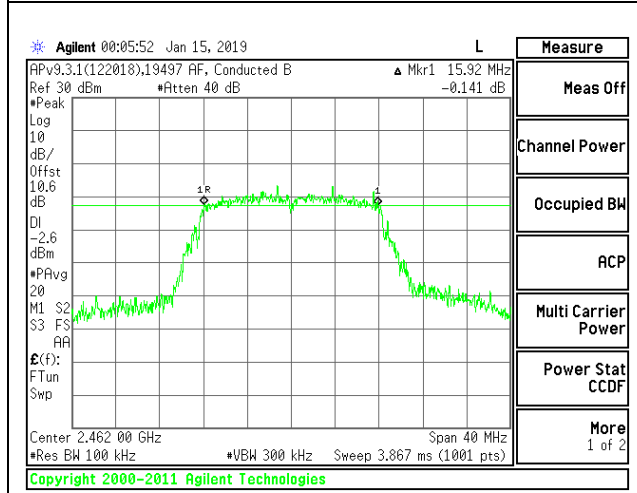

HIGH CHANNEL 11

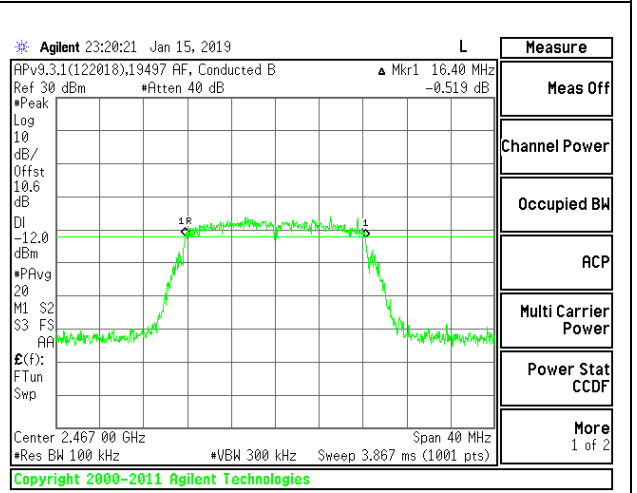

HIGH CHANNEL 12

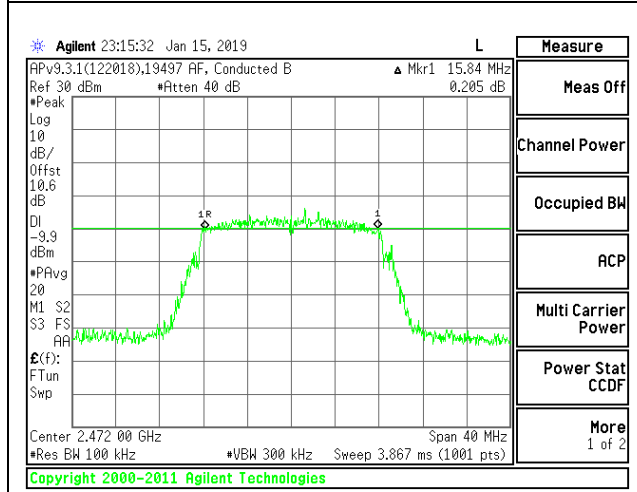

HIGH CHANNEL 13

9.3.3. 802.11n HT20 MODE

1TX Antenna 1 MODE

Channel	Frequency (MHz)	6 dB Bandwidth (MHz)	Minimum Limit (MHz)
Low 1	2412	15.80	0.5
Mid 6	2437	16.04	0.5
High 11	2462	14.00	0.5
High 12	2467	15.72	0.5
High 13	2472	16.68	0.5

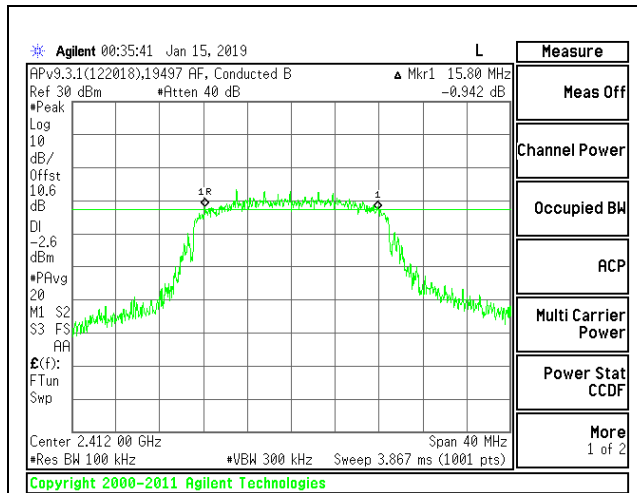

LOW CHANNEL 1

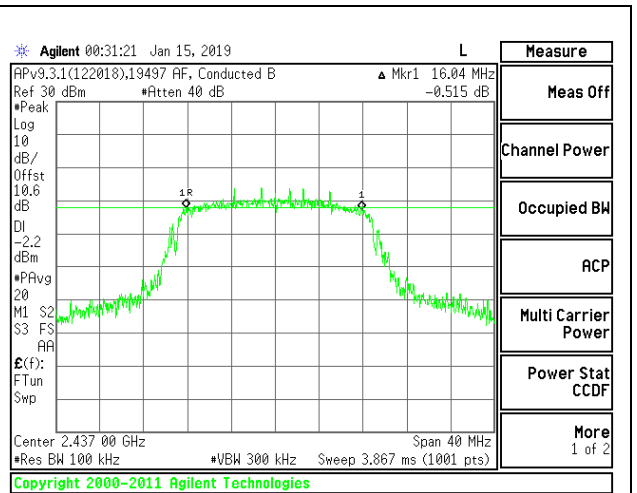

MID CHANNEL 6

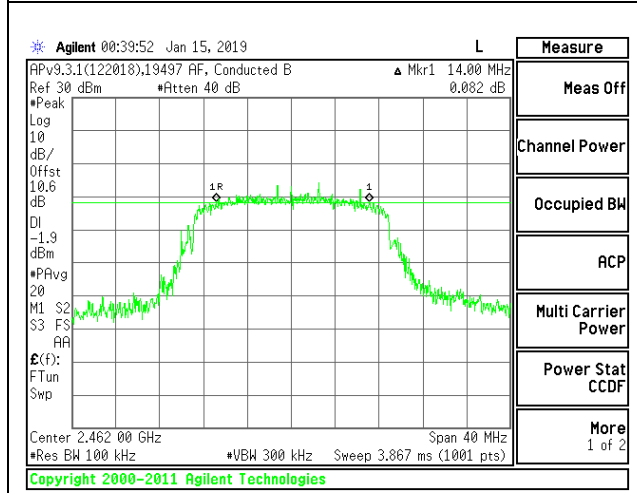

HIGH CHANNEL 11

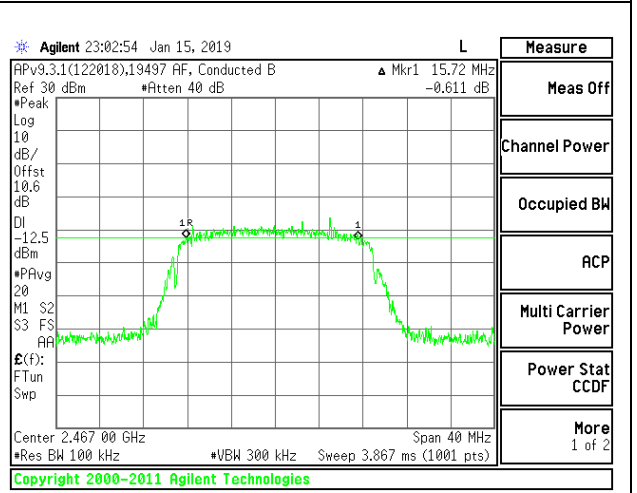

HIGH CHANNEL 12

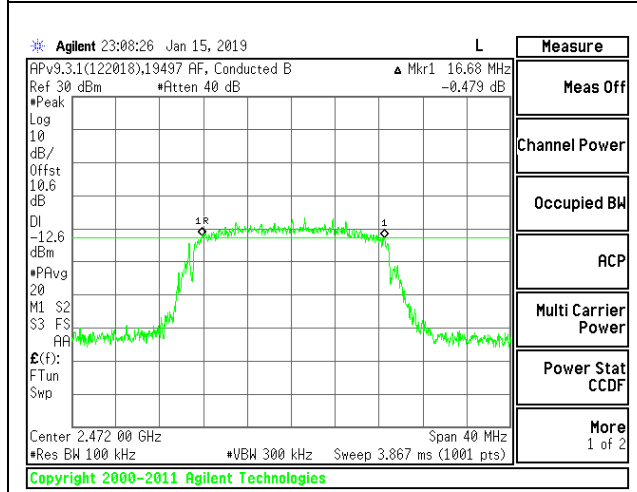

HIGH CHANNEL 13

9.4. OUTPUT POWER

LIMITS

FCC §15.247 (b) (3)

For systems using digital modulation in the 902–928 MHz, 2400–2483.5 MHz, and 5725–5850 MHz bands: 1 Watt, based on the use of antennas with directional gains that do not exceed 6 dBi. If transmitting antennas of directional gain greater than 6 dBi are used, the conducted output power from the intentional radiator shall be reduced by the amount in dB that the directional gain of the antenna exceeds 6 dBi.

TEST PROCEDURE

The transmitter output is connected to a power meter. The cable assembly insertion loss was entered as an offset in the power meter to allow for a gated average reading of power.

DIRECTIONAL ANTENNA GAIN

There is only one transmitter output therefore the directional gain is equal to the antenna gain.

RESULTS

9.4.1. 802.11b MODE

1TX Antenna 1 MODE

Limits

Channel	Frequency (MHz)	Directional Gain (dBi)	FCC Power Limit (dBm)	ISED Power Limit (dBm)	ISED EIRP Limit (dBm)	Max Power (dBm)
Low 1	2412	-2.90	30.00	30	36	30.00
Mid 6	2437	-2.90	30.00	30	36	30.00
High 11	2462	-2.90	30.00	30	36	30.00
High 12	2467	-2.90	30.00	30	36	30.00
High 13	2472	-2.90	30.00	30	36	30.00

Results

Channel	Frequency (MHz)	Meas Power (dBm)	Total Corr'd Power (dBm)	Power Limit (dBm)	Margin (dB)
Low 1	2412	18.35	18.35	30.00	-11.65
Mid 6	2437	18.97	18.97	30.00	-11.03
High 11	2462	18.35	18.35	30.00	-11.65
High 12	2467	7.88	7.88	30.00	-22.12
High 13	2472	7.15	7.15	30.00	-22.85

9.4.2. 802.11g MODE

1TX Antenna 1 MODE

Limits

Channel	Frequency (MHz)	Directional Gain (dBi)	FCC Power Limit (dBm)	ISED Power Limit (dBm)	ISED EIRP Limit (dBm)	Max Power (dBm)
Low 1	2412	-2.90	30.00	30	36	30.00
Mid 6	2437	-2.90	30.00	30	36	30.00
High 11	2462	-2.90	30.00	30	36	30.00
High 12	2467	-2.90	30.00	30	36	30.00
High 13	2472	-2.90	30.00	30	36	30.00

Results

Channel	Frequency (MHz)	Meas Power (dBm)	Total Corr'd Power (dBm)	Power Limit (dBm)	Margin (dB)
Low 1	2412	15.75	15.75	30.00	-14.25
Mid 6	2437	15.71	15.71	30.00	-14.29
High 11	2462	15.36	15.36	30.00	-14.64
High 12	2467	7.32	7.32	30.00	-22.68
High 13	2472	7.88	7.88	30.00	-22.12

9.4.3. 802.11n HT20 MODE

1TX Antenna 1 MODE

Limits

Channel	Frequency (MHz)	Directional Gain (dBi)	FCC Power Limit (dBm)	ISED Power Limit (dBm)	ISED EIRP Limit (dBm)	Max Power (dBm)
Low 1	2412	-2.90	30.00	30	36	30.00
Mid 6	2437	-2.90	30.00	30	36	30.00
High 11	2462	-2.90	30.00	30	36	30.00
High 12	2467	-2.90	30.00	30	36	30.00
High 13	2472	-2.90	30.00	30	36	30.00

Results

Channel	Frequency (MHz)	Meas Power (dBm)	Total Corr'd Power (dBm)	Power Limit (dBm)	Margin (dB)
Low 1	2412	15.21	15.21	30.00	-14.79
Mid 6	2437	15.24	15.24	30.00	-14.76
High 11	2462	15.35	15.35	30.00	-14.65
High 12	2467	5.02	5.02	30.00	-24.98
High 13	2472	5.44	5.44	30.00	-24.56

9.5. POWER SPECTRAL DENSITY

LIMITS

FCC §15.247 (e)

The power spectral density conducted from the transmitter to the antenna shall not be greater than 8 dBm in any 3 kHz band during any time interval of continuous transmission.

RESULTS

9.5.1. 802.11b MODE

1TX Antenna 1 MODE

Duty Cycle CF (dB)	0.00	Included in Calculations of Corr'd PSD
---------------------------	------	---

PSD Results

Channel	Frequency (MHz)	Chain 0 Meas (dBm/ 30kHz)	Total Corr'd PSD (dBm/ 30kHz)	Limit (dBm/ 30kHz)	Margin (dB)
Low 1	2412	-3.11	-3.11	8.0	-11.1
Mid 6	2437	-3.29	-3.29	8.0	-11.3
High 11	2462	-2.97	-2.97	8.0	-11.0
High 12	2467	-13.93	-13.93	8.0	-21.9
High 13	2472	-14.51	-14.51	8.0	-22.5

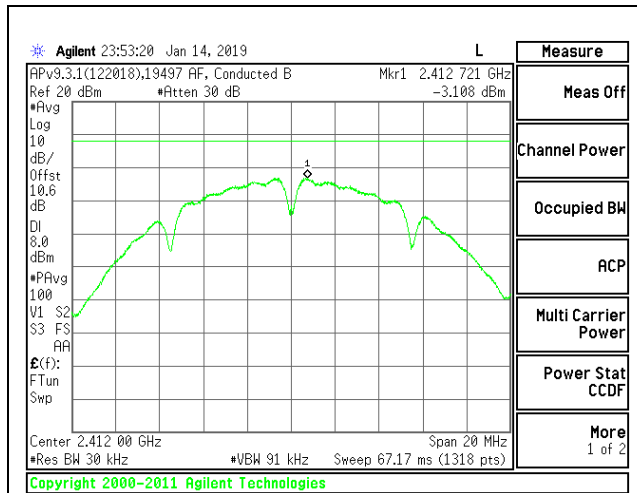

LOW CHANNEL 1

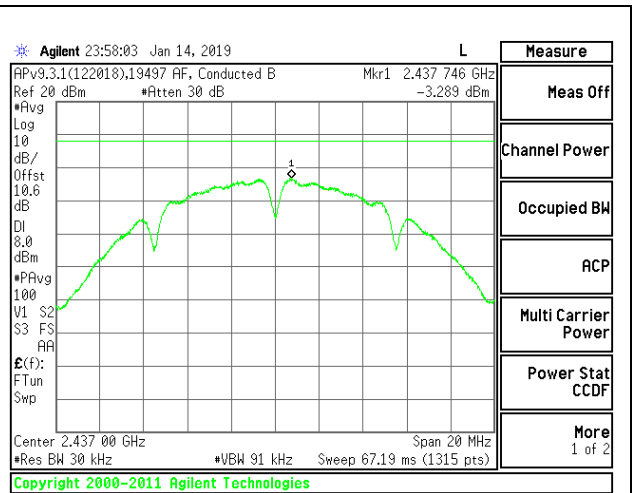

MID CHANNEL 6

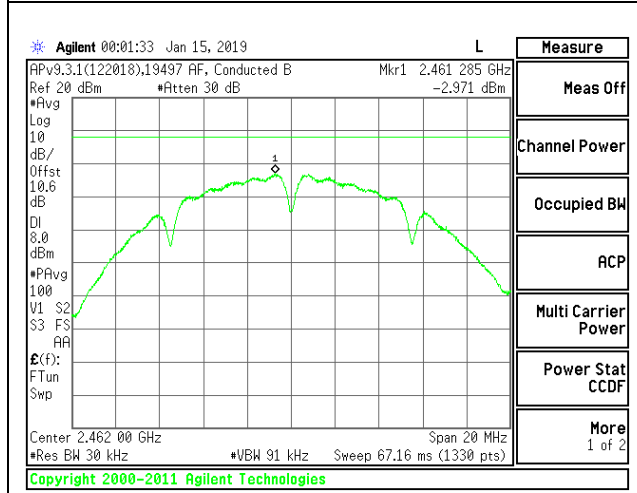

HIGH CHANNEL 11

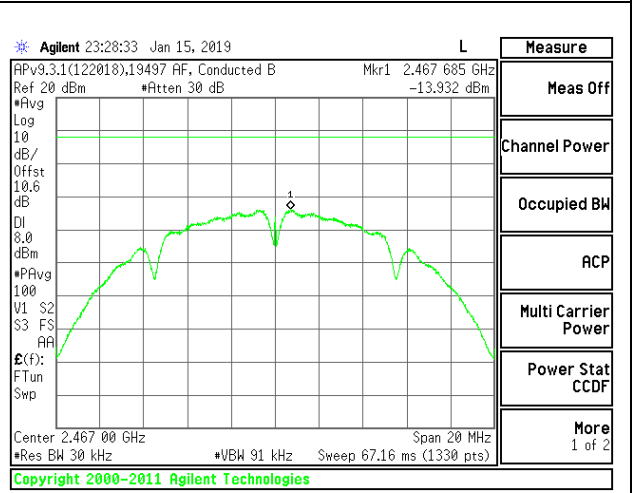

HIGH CHANNEL 12

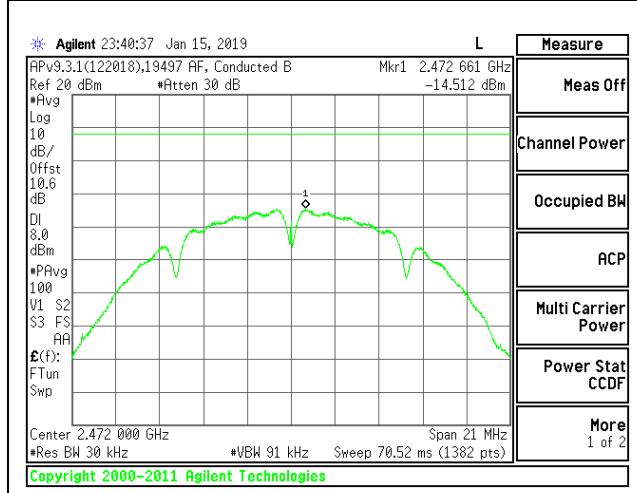

HIGH CHANNEL 13

9.5.2. 802.11g MODE

1TX Antenna 1 MODE

Duty Cycle CF (dB)	0.40	Included in Calculations of Corr'd PSD
---------------------------	------	---

PSD Results

Channel	Frequency (MHz)	Chain 0 Meas (dBm/30kHz)	Total Corr'd PSD (dBm/30kHz)	Limit (dBm/30kHz)	Margin (dB)
Low 1	2412	-9.18	-8.78	8.0	-16.8
Mid 6	2437	-9.14	-8.74	8.0	-16.7
High 11	2462	-9.56	-9.16	8.0	-17.2
High 12	2467	-17.30	-16.90	8.0	-24.9
High 13	2472	-17.15	-16.75	8.0	-24.7

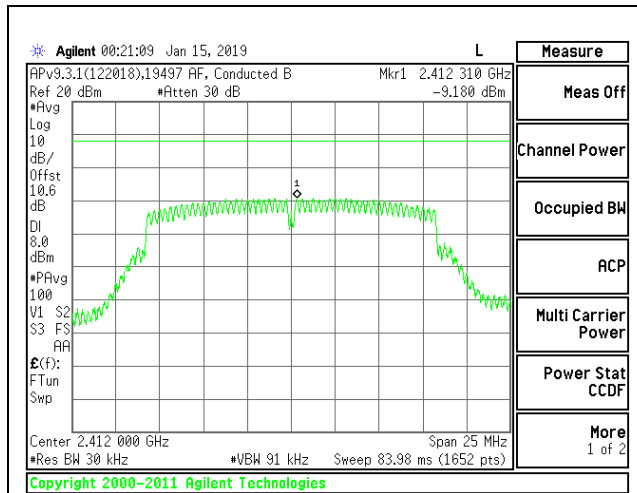

LOW CHANNEL 1

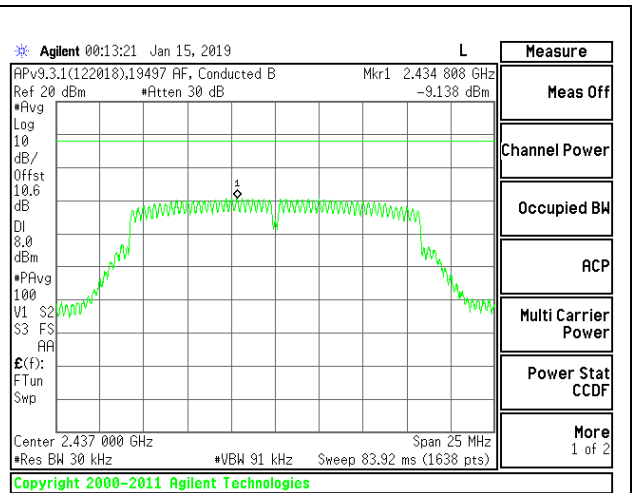

MID CHANNEL 6

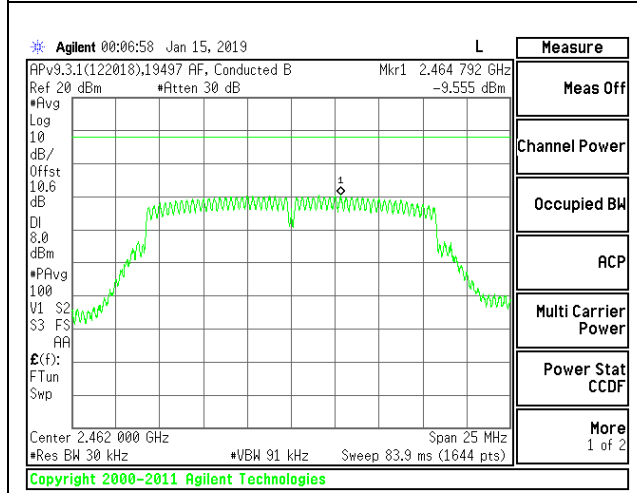

HIGH CHANNEL 11

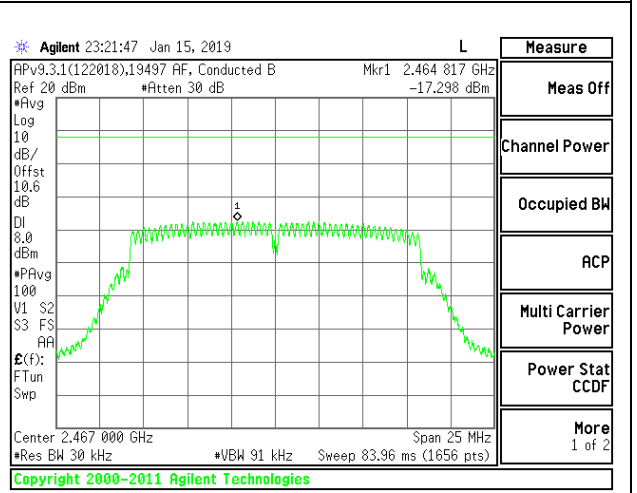

HIGH CHANNEL 12

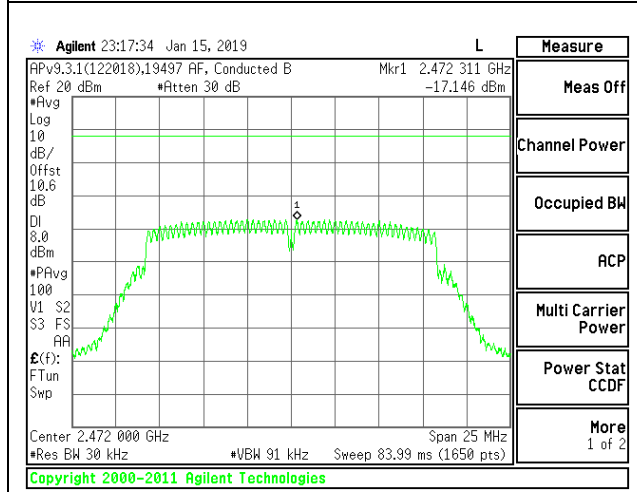

HIGH CHANNEL 13

9.5.3. 802.11n HT20 MODE

1TX Antenna 1 MODE

Duty Cycle CF (dB)	0.24	Included in Calculations of Corr'd PSD
---------------------------	------	---

PSD Results

Channel	Frequency (MHz)	Chain 0 Meas (dBm/ 30kHz)	Total Corr'd PSD (dBm/ 30kHz)	Limit (dBm/ 30kHz)	Margin (dB)
Low 1	2412	-9.44	-9.20	8.0	-17.2
Mid 6	2437	-9.53	-9.29	8.0	-17.3
High 11	2462	-9.94	-9.70	8.0	-17.7
High 12	2467	-18.21	-17.97	8.0	-26.0
High 13	2472	-17.14	-16.90	8.0	-24.9

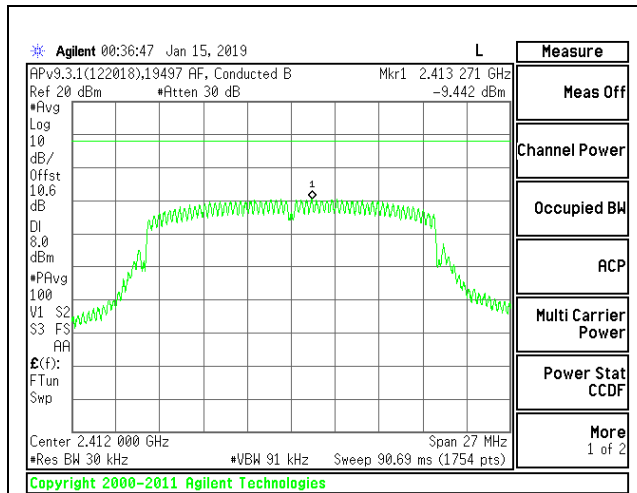

LOW CHANNEL 1

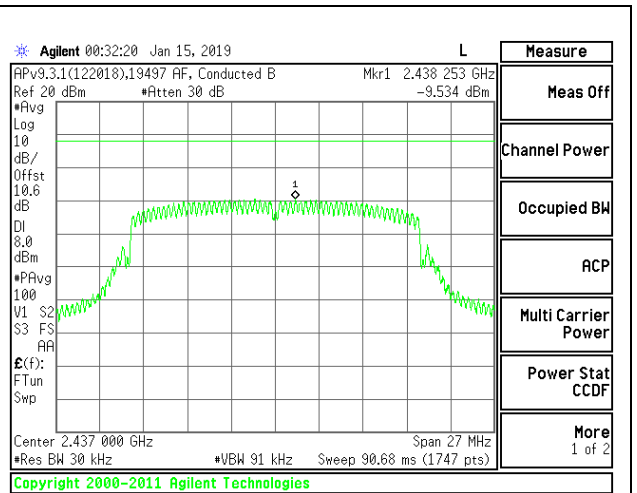

MID CHANNEL 6

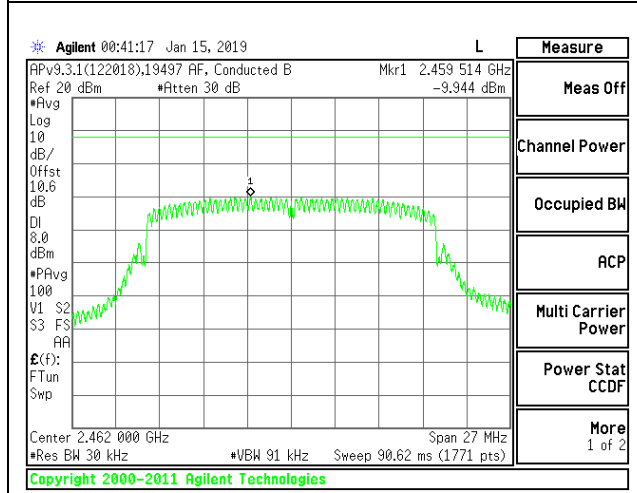

HIGH CHANNEL 11

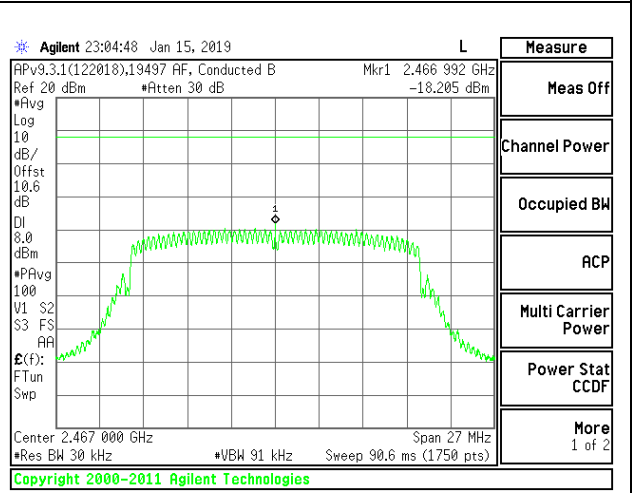

HIGH CHANNEL 12

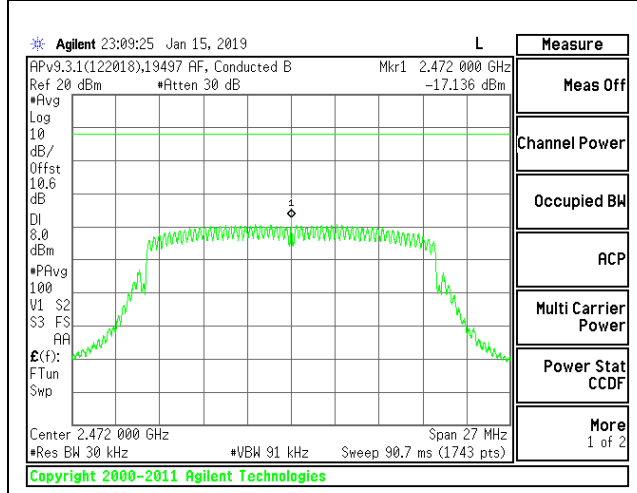

HIGH CHANNEL 13

9.6. CONDUCTED SPURIOUS EMISSIONS

LIMITS

FCC §15.247 (d)

Output power was measured based on the use of average measurement, therefore the required attenuation is 30 dB.

9.6.1. RESULTS

802.11b MODE

1TX Antenna 1 MODE

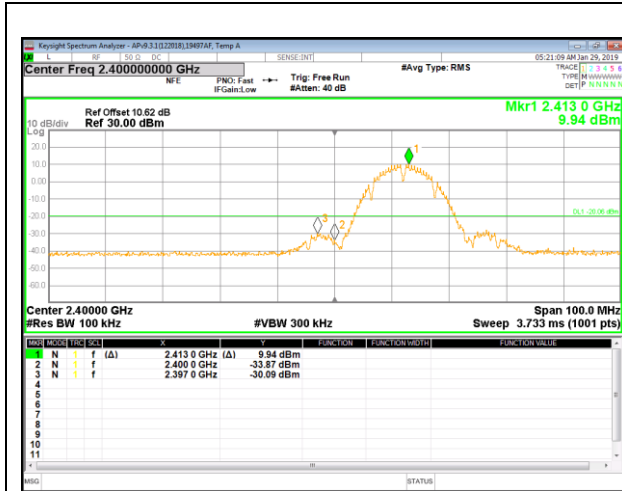

LOW CHANNEL 1 BANDEDGE

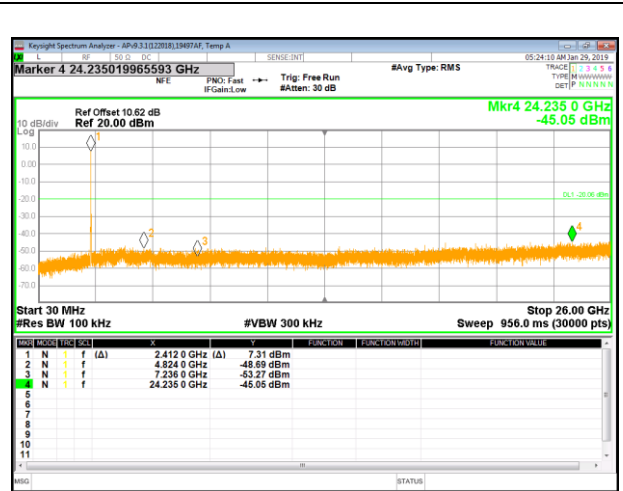

OUT-OF-BAND LOW CHANNEL 1

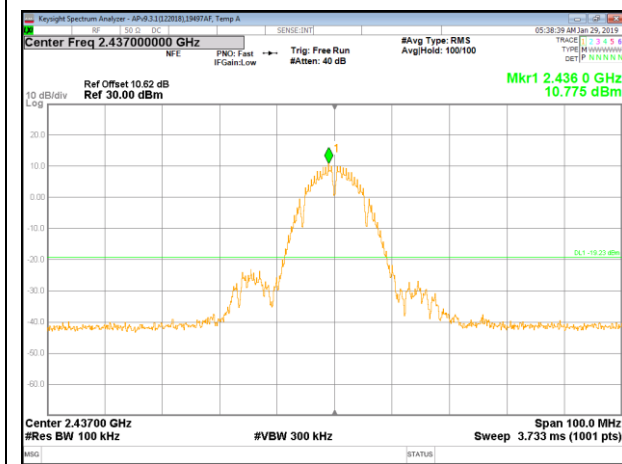

IN-BAND REFERENCE LEVEL

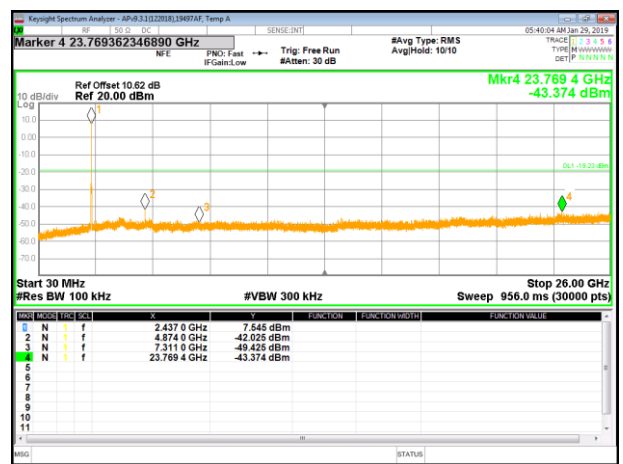

OUT-OF-BAND MID CHANNEL

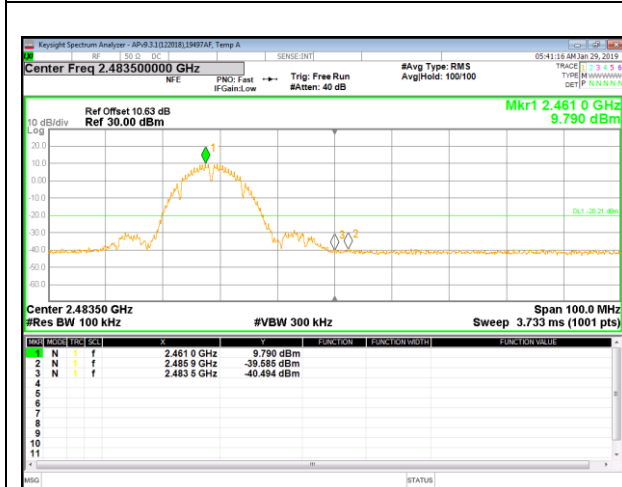

HIGH CHANNEL 11 BANDEDGE

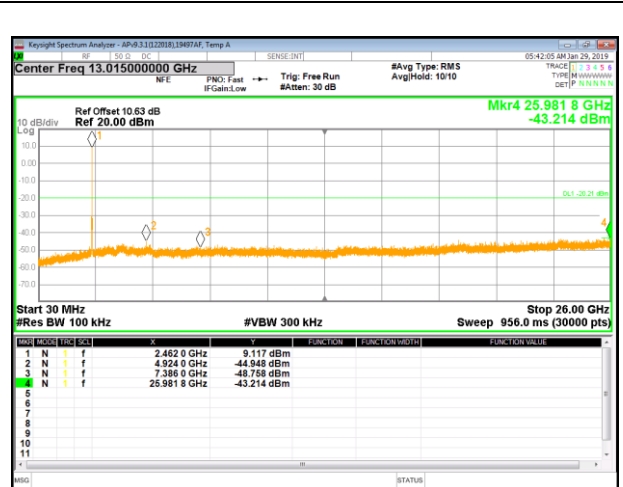

OUT-OF-BAND HIGH CHANNEL 11

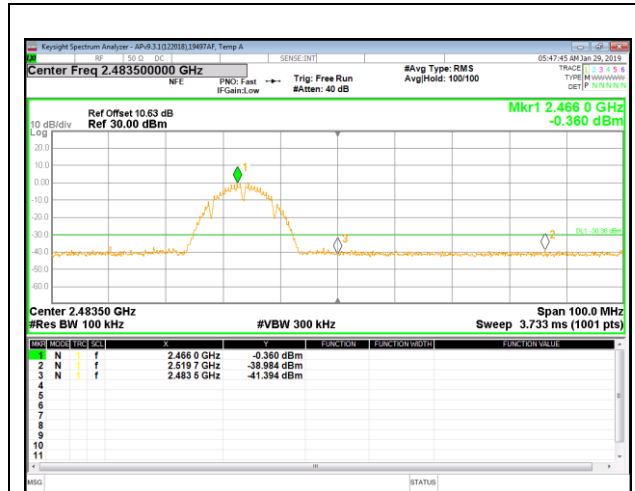

HIGH CHANNEL 12 BANDEDGE

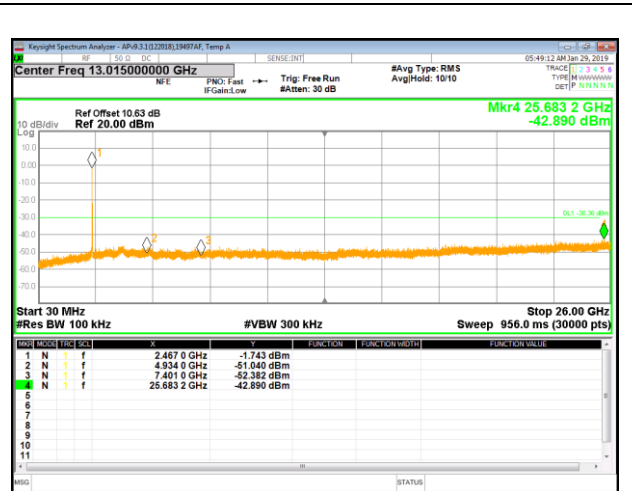

OUT-OF-BAND HIGH CHANNEL 12

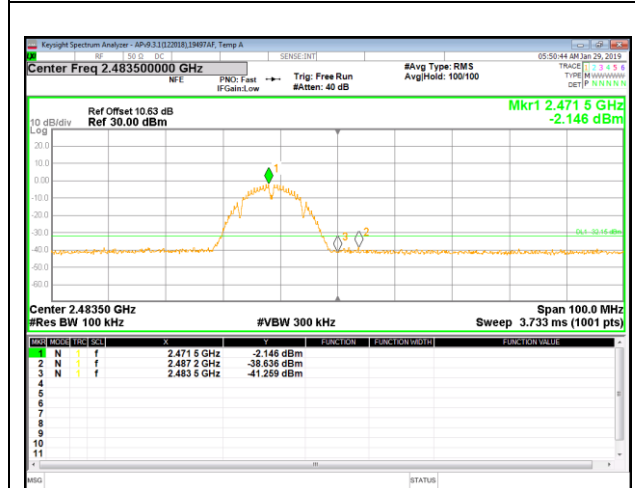

HIGH CHANNEL 13 BANDEDGE

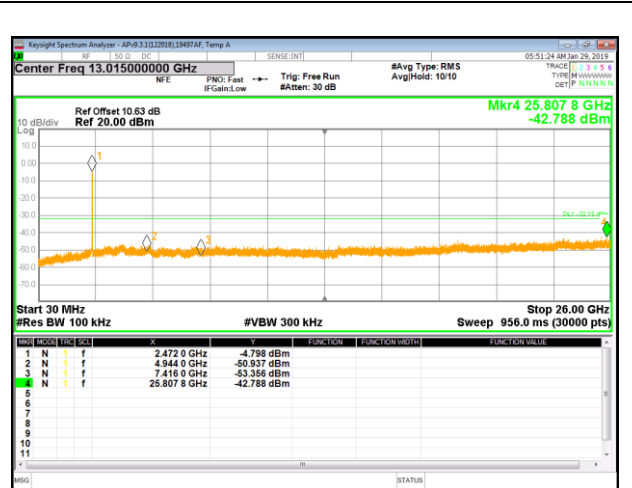

OUT-OF-BAND HIGH CHANNEL 13

9.6.2. 802.11g MODE

1TX Antenna 1 MODE

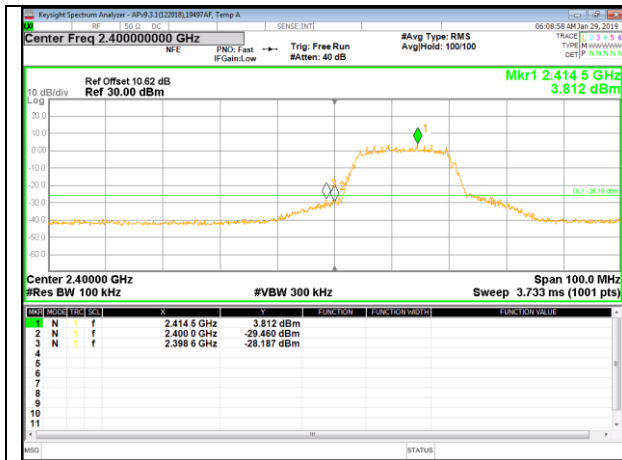

LOW CHANNEL 1 BANDEDGE

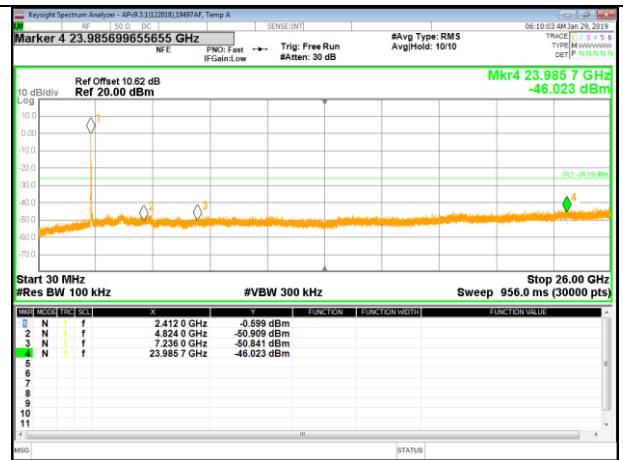

OUT-OF-BAND LOW CHANNEL 1

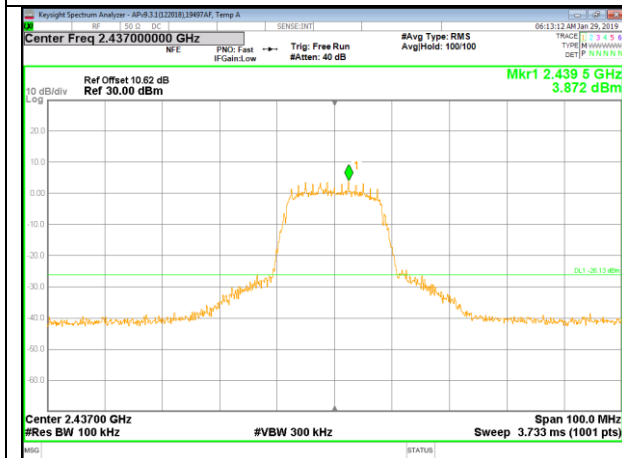

IN-BAND REFERENCE LEVEL

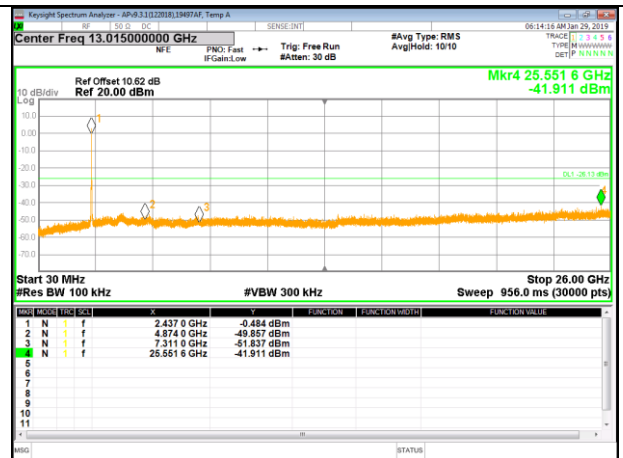

OUT-OF-BAND MID CHANNEL

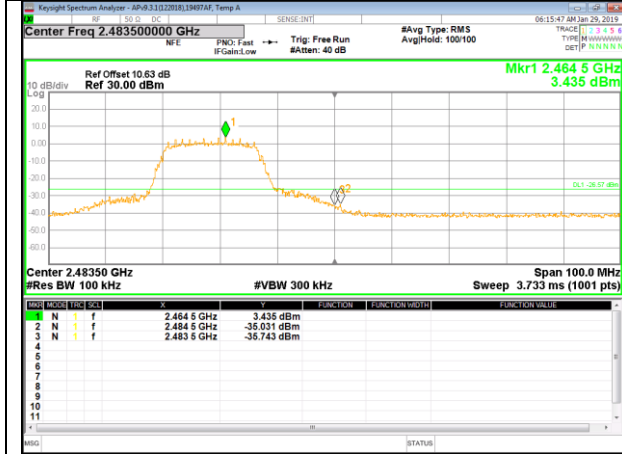

HIGH CHANNEL 11 BANDEDGE

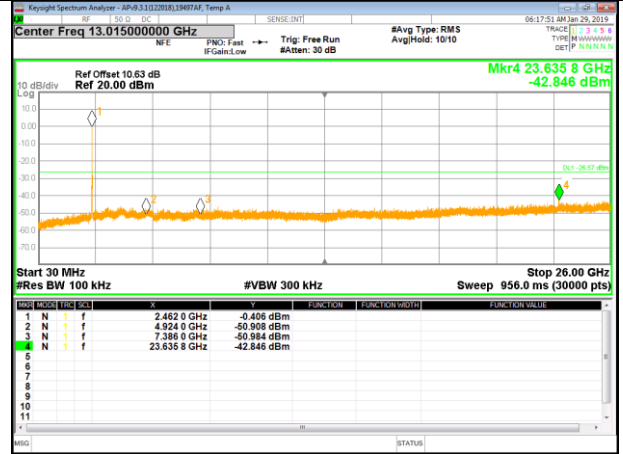

OUT-OF-BAND HIGH CHANNEL 11

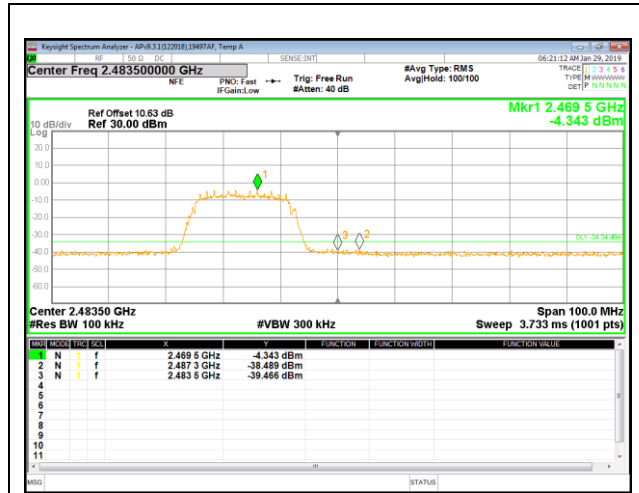

HIGH CHANNEL 12 BANDEDGE

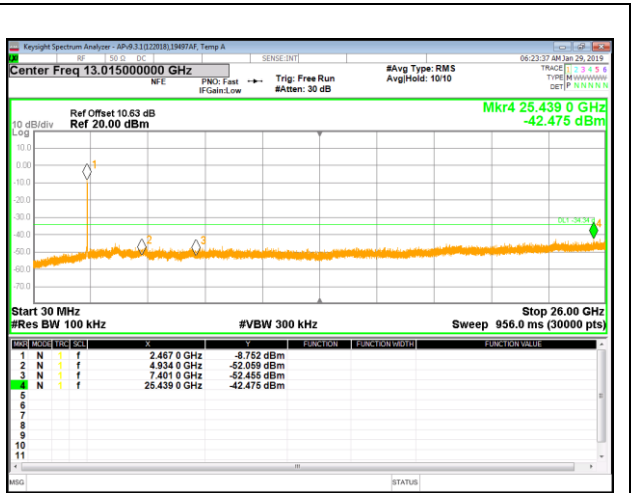

OUT-OF-BAND HIGH CHANNEL 12

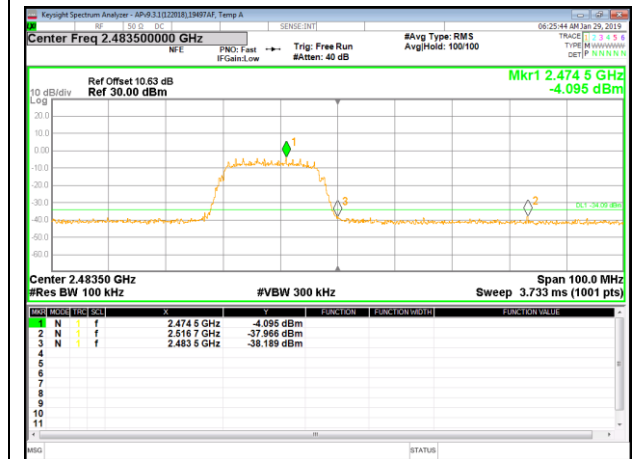

HIGH CHANNEL 13 BANDEDGE

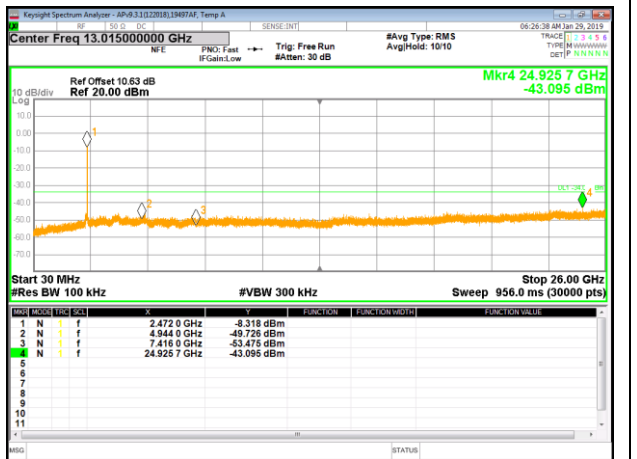

OUT-OF-BAND HIGH CHANNEL 13

9.6.3. 802.11n HT20 MODE

1TX Antenna 1 MODE

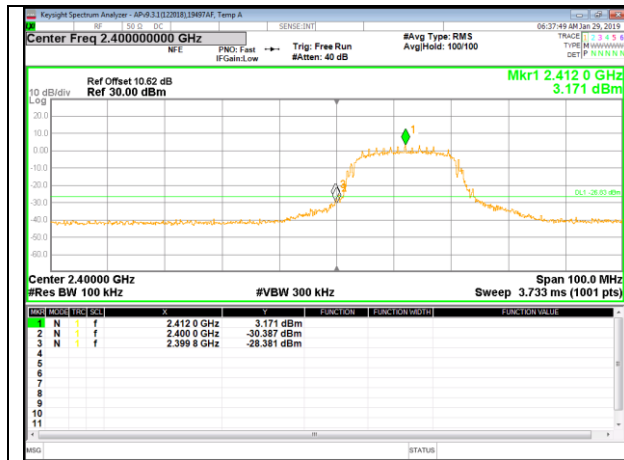

LOW CHANNEL 1 BANDEDGE

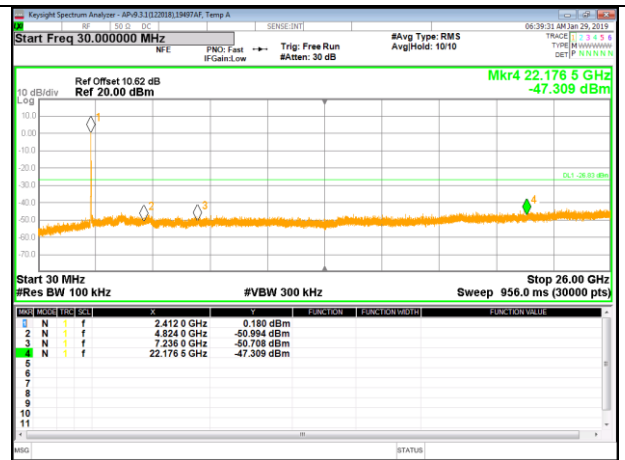

OUT-OF-BAND LOW CHANNEL 1

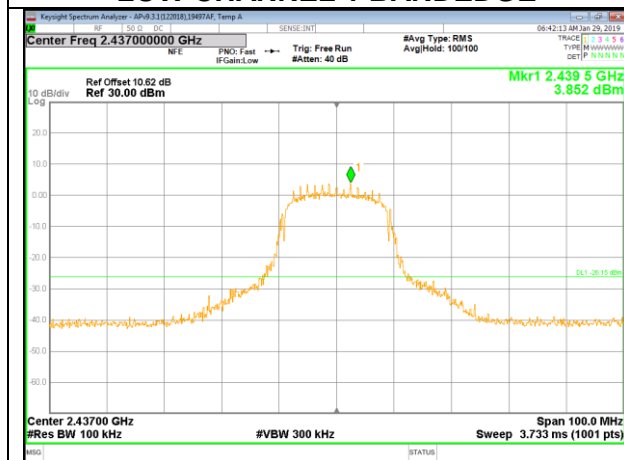

IN-BAND REFERENCE LEVEL

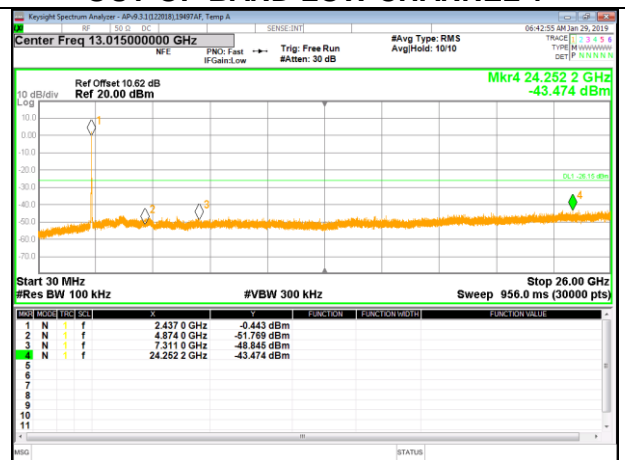

OUT-OF-BAND MID CHANNEL

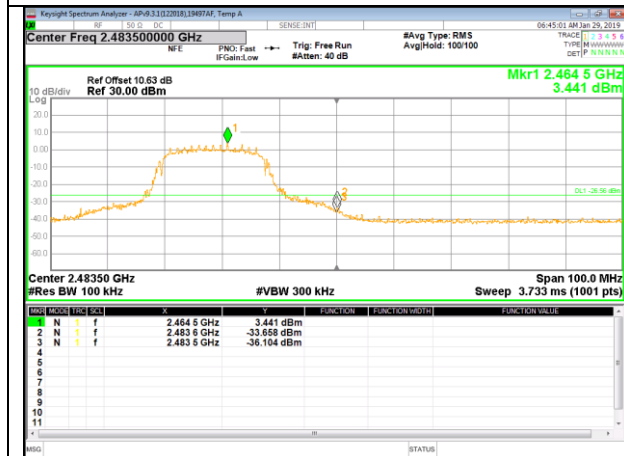

HIGH CHANNEL 11 BANDEDGE

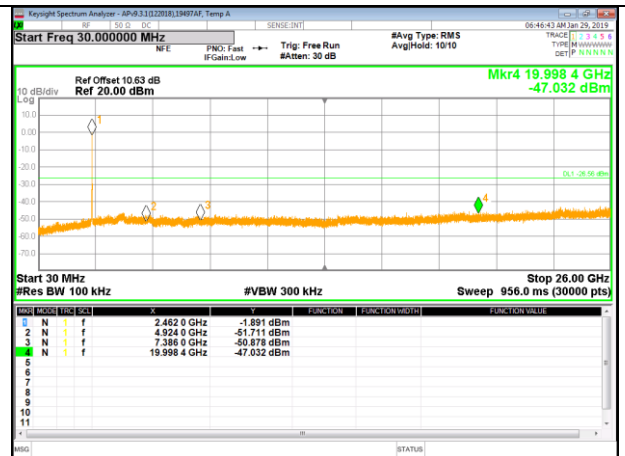

OUT-OF-BAND HIGH CHANNEL 11

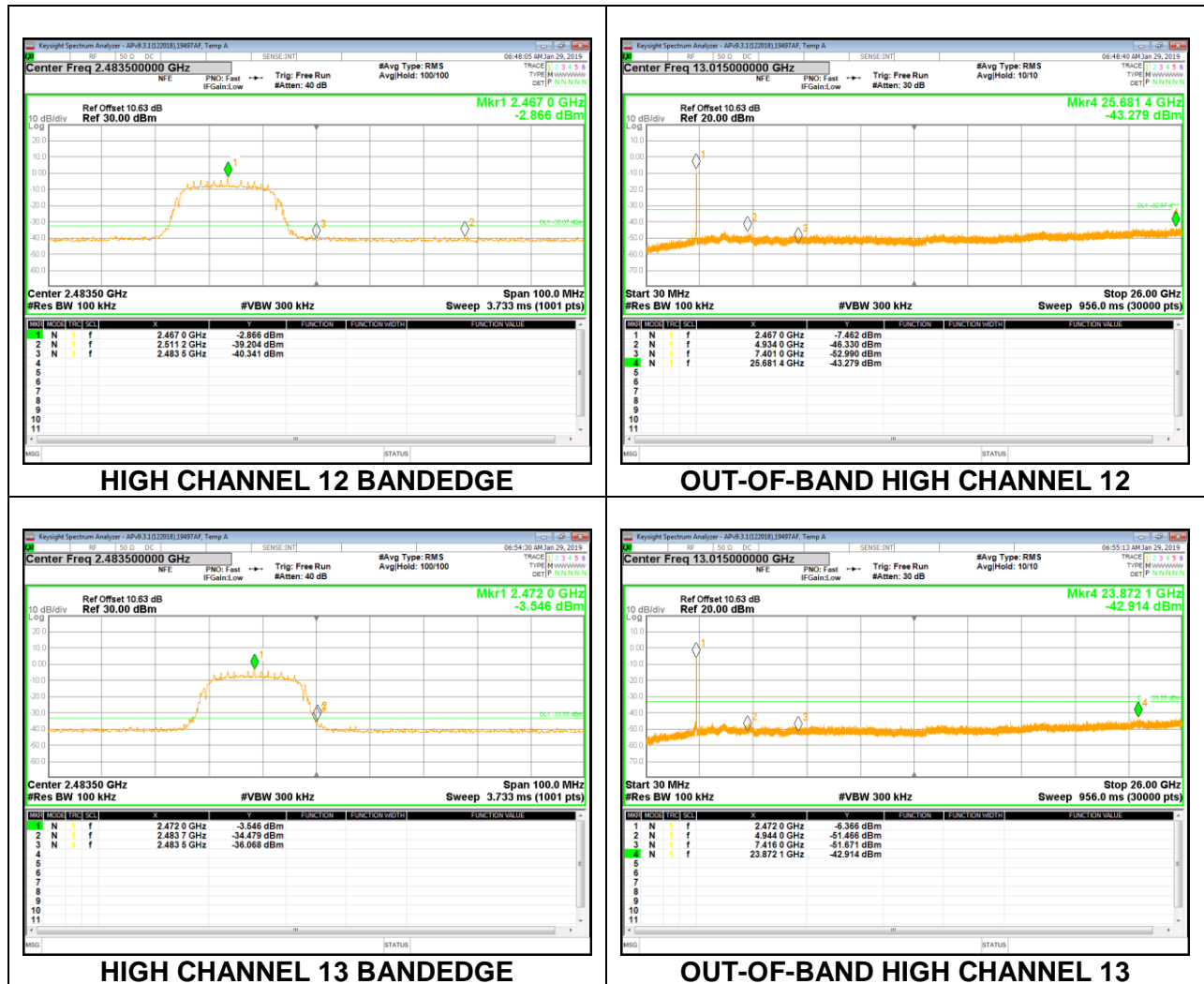

10. RADIATED TEST RESULTS

LIMITS

FCC §15.205 and §15.209

Frequency Range (MHz)	Field Strength Limit (uV/m) at 3 m	Field Strength Limit (dBuV/m) at 3 m
0.009-0.490	2400/F(kHz) @ 300 m	-
0.490-1.705	24000/F(kHz) @ 30 m	-
1.705 - 30	30 @ 30m	-
30 - 88	100	40
88 - 216	150	43.5
216 - 960	200	46
Above 960	500	54

TEST PROCEDURE

The EUT is placed on a non-conducting table 80 cm above the ground plane for measurement below 1GHz; 1.5 m above the ground plane for measurement above 1GHz. The antenna to EUT distance is 3 meters. The EUT is configured in accordance with ANSI C63.10. The EUT is set to transmit in a continuous mode.

For measurements below 1 GHz the resolution bandwidth is set to 100 kHz for peak detection measurements or 120 kHz for quasi-peak detection measurements. Peak detection is used unless otherwise noted as quasi-peak.

For pre-scans above 1 GHz the resolution bandwidth is set to 1 MHz; the video bandwidth is set to 30 KHz for peak measurements.

For final measurements above 1 GHz the resolution bandwidth is set to 1 MHz; the video bandwidth is set to 3 MHz for peak measurements and as applicable for average measurements.

The spectrum from 1 GHz to 18 GHz is investigated with the transmitter set to the lowest, middle, and highest channels in each applicable band. Below 1GHz and above 18GHz emissions, the channel with the highest output power was tested.

The frequency range of interest is monitored at a fixed antenna height and EUT azimuth. The EUT is rotated through 360 degrees to maximize emissions received. The antenna is scanned from 1 to 4 meters above the ground plane to further maximize the emission. Measurements are made with the antenna polarized in both the vertical and the horizontal positions.

2D antenna use - For below 30MHz testing, investigation was done on three antenna orientations (parallel, perpendicular, and ground-parallel), parallel and perpendicular are the worst orientations, therefore testing was performed on these two orientations only.

KDB 414788 OATS and Chamber Correlation Justification

Base on FCC 15.31 (f) (2): measurements may be performed at a distance closer than that specified in the regulations; however, an attempt should be made to avoid making measurements in the near field.

OATs and chamber correlation testing had been performed and chamber measured test result is the worst case test result.

10.1. TRANSMITTER ABOVE 1 GHz

10.1.1. TX ABOVE 1 GHz 802.11b MODE IN THE 2.4 GHz BAND

1TX Antenna 1 MODE

BANDEDGE (LOW CHANNEL, CH 1)

HORIZONTAL RESULT

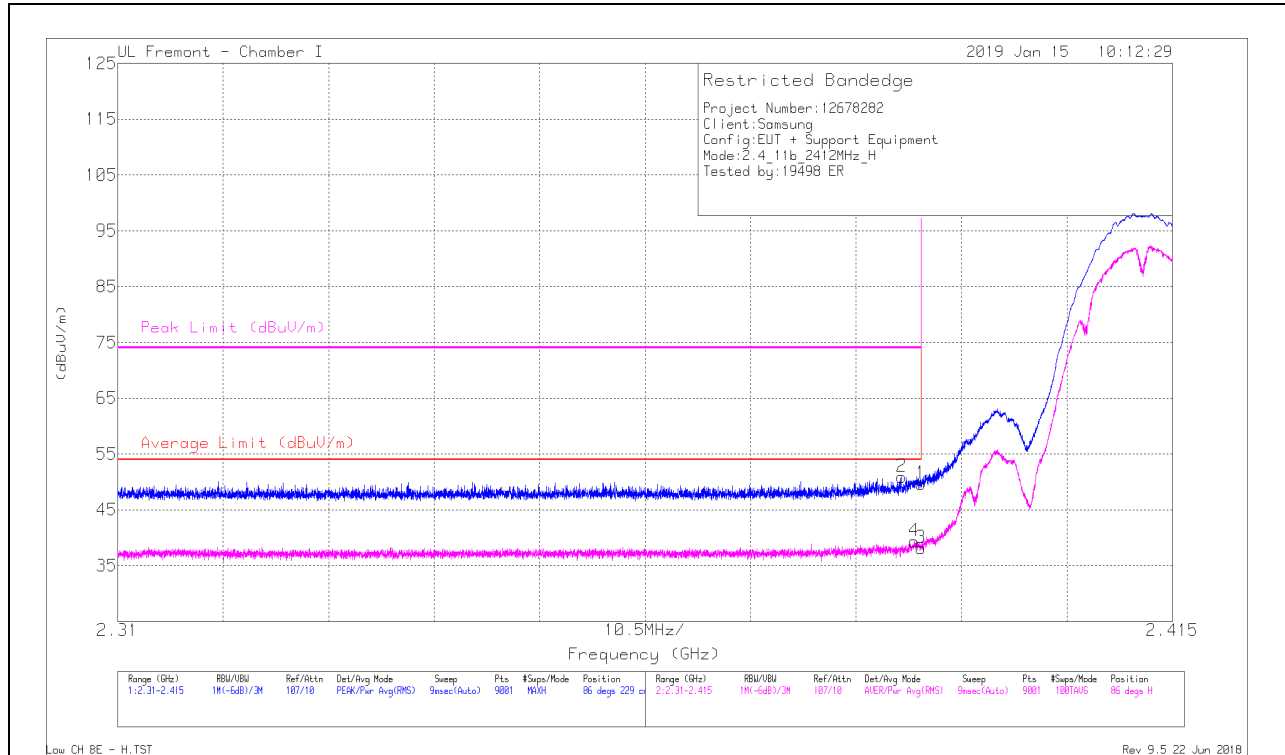

Marker	Frequency (GHz)	Meter Reading (dBuV)	Det	AF T862 (dB/m)	Amp/Cbl/Fitr/P ad (dB)	Corrected Reading (dBuV/m)	Average Limit (dBuV/m)	Margin (dB)	Peak Limit (dBuV/m)	PK Margin (dB)	Azimuth (Degs)	Height (cm)	Polarity
1	* 2.39	39.45	Pk	31.8	-21.6	49.65	-	-	74	-24.35	86	229	H
2	* 2.388	40.69	Pk	31.8	-21.6	50.89	-	-	74	-23.11	86	229	H
3	* 2.39	27.98	RMS	31.8	-21.6	38.18	54	-15.82	-	-	86	229	H
4	* 2.389	29.15	RMS	31.8	-21.6	39.35	54	-14.65	-	-	86	229	H

* - indicates frequency in CFR47 Pt 15 / IC RSS-Restricted Band

Pk - Peak detector

RMS - RMS detection

VERTICAL RESULT

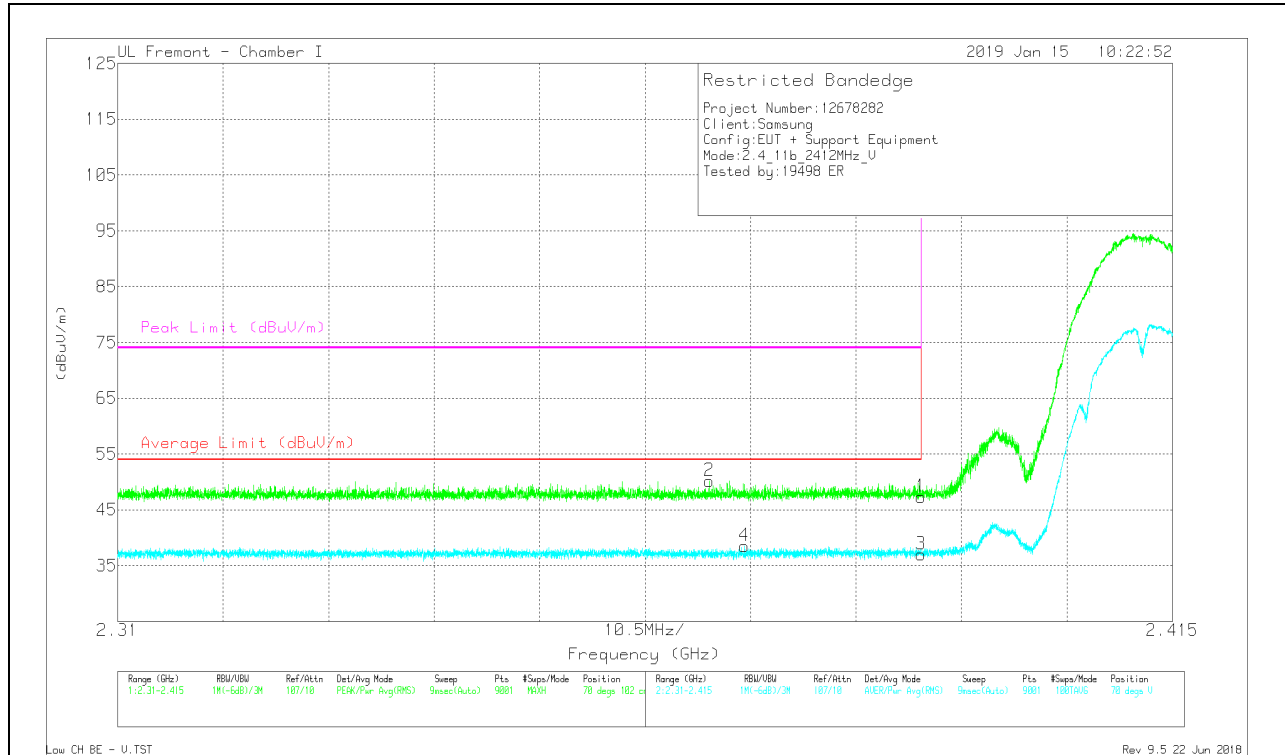

Marker	Frequency (GHz)	Meter Reading (dBuV)	Det	AF T862 (dB/m)	Amp/Cb/Filtr/P ad (dB)	Corrected Reading (dBuV/m)	Average Limit (dBuV/m)	Margin (dB)	Peak Limit (dBuV/m)	PK Margin (dB)	Azimuth (Degs)	Height (cm)	Polarity
1	* 2.39	37.14	Pk	31.8	-21.6	47.34	-	-	74	-26.66	70	102	V
2	* 2.369	39.96	Pk	31.7	-21.5	50.16	-	-	74	-23.84	70	102	V
3	* 2.39	26.79	RMS	31.8	-21.6	36.99	54	-17.01	-	-	70	102	V
4	* 2.372	28.29	RMS	31.7	-21.5	38.49	54	-15.51	-	-	70	102	V

* - indicates frequency in CFR47 Pt 15 / IC RSS-Restricted Band
 Pk - Peak detector
 RMS - RMS detection

BANDEDGE (HIGH CHANNEL, CH 11)

HORIZONTAL RESULT

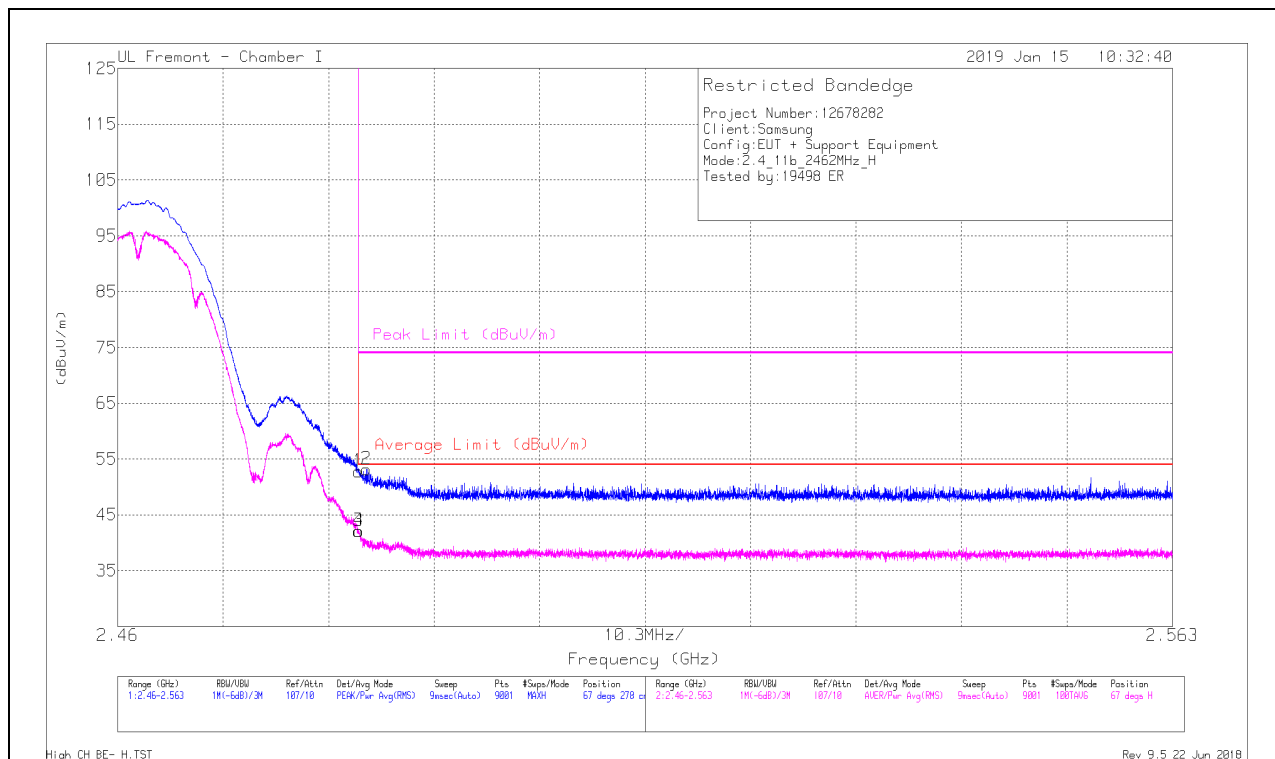

Marker	Frequency (GHz)	Meter Reading (dBuV)	Det	AF T862 (dB/m)	Amp/Cbl/Fitr/P ad (dB)	Corrected Reading (dBuV/m)	Average Limit (dBuV/m)	Margin (dB)	Peak Limit (dBuV/m)	PK Margin (dB)	Azimuth (Degs)	Height (cm)	Polarity
1	* 2.484	42.06	Pk	32.4	-21.7	52.76	-	-	74	-21.24	67	278	H
2	* 2.484	42.48	Pk	32.4	-21.7	53.18	-	-	74	-20.82	67	278	H
3	* 2.484	31.38	RMS	32.4	-21.7	42.08	54	-11.92	-	-	67	278	H
4	* 2.484	31.36	RMS	32.4	-21.7	42.06	54	-11.94	-	-	67	278	H

* - indicates frequency in CFR47 Pt 15 / IC RSS-Restricted Band

Pk - Peak detector

RMS - RMS detection

VERTICAL RESULT

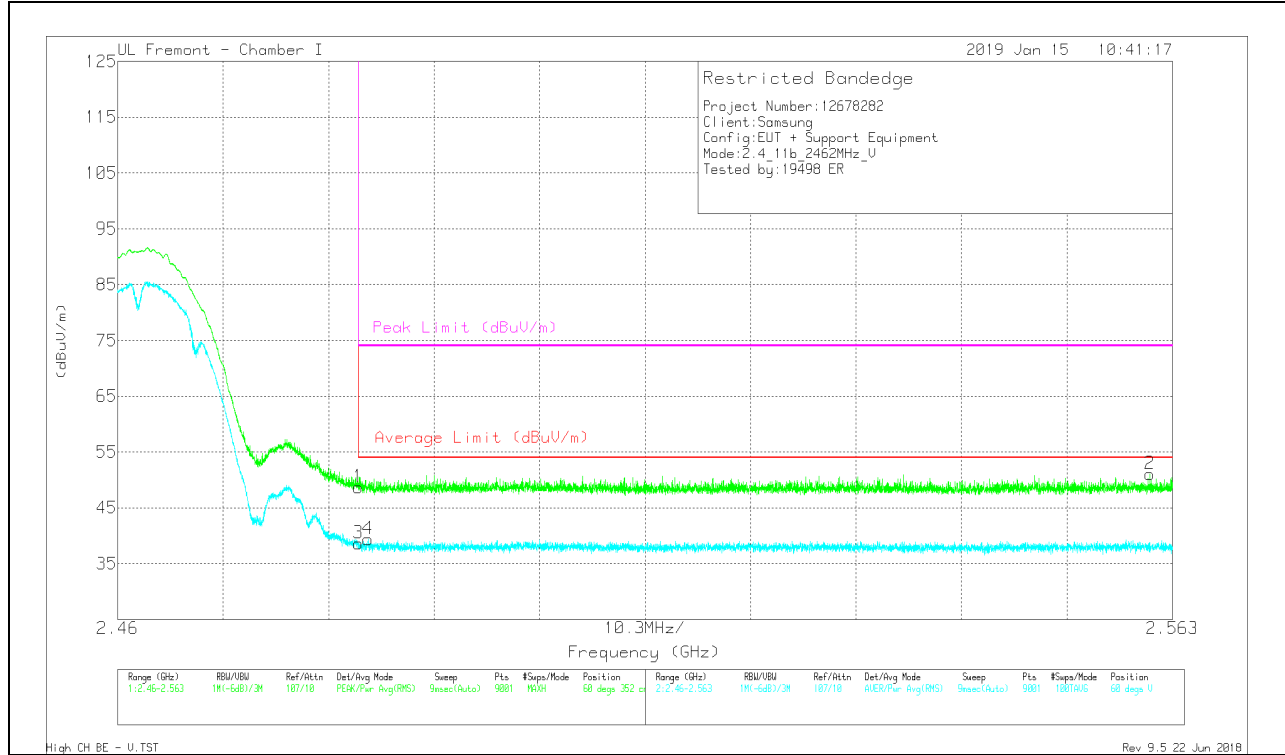

Marker	Frequency (GHz)	Meter Reading (dBuV)	Det	AF T862 (dB/m)	Amp/Cb/Filtr/Pad (dB)	Corrected Reading (dBuV/m)	Average Limit (dBuV/m)	Margin (dB)	Peak Limit (dBuV/m)	PK Margin (dB)	Azimuth (Degs)	Height (cm)	Polarity
1	* 2.484	37.97	Pk	32.4	-21.7	48.67	-	-	74	-25.33	60	352	V
2	2.561	40.23	Pk	32.4	-21.6	51.03	-	-	74	-22.97	60	352	V
3	* 2.484	27.91	RMS	32.4	-21.7	38.61	54	-15.39	-	-	60	352	V
4	* 2.484	28.65	RMS	32.4	-21.7	39.35	54	-14.65	-	-	60	352	V

* - indicates frequency in CFR47 Pt 15 / IC RSS-Restricted Band
 Pk - Peak detector
 RMS - RMS detection

BANEDGE (HIGH CHANNEL, CH 12)

HORIZONTAL RESULT

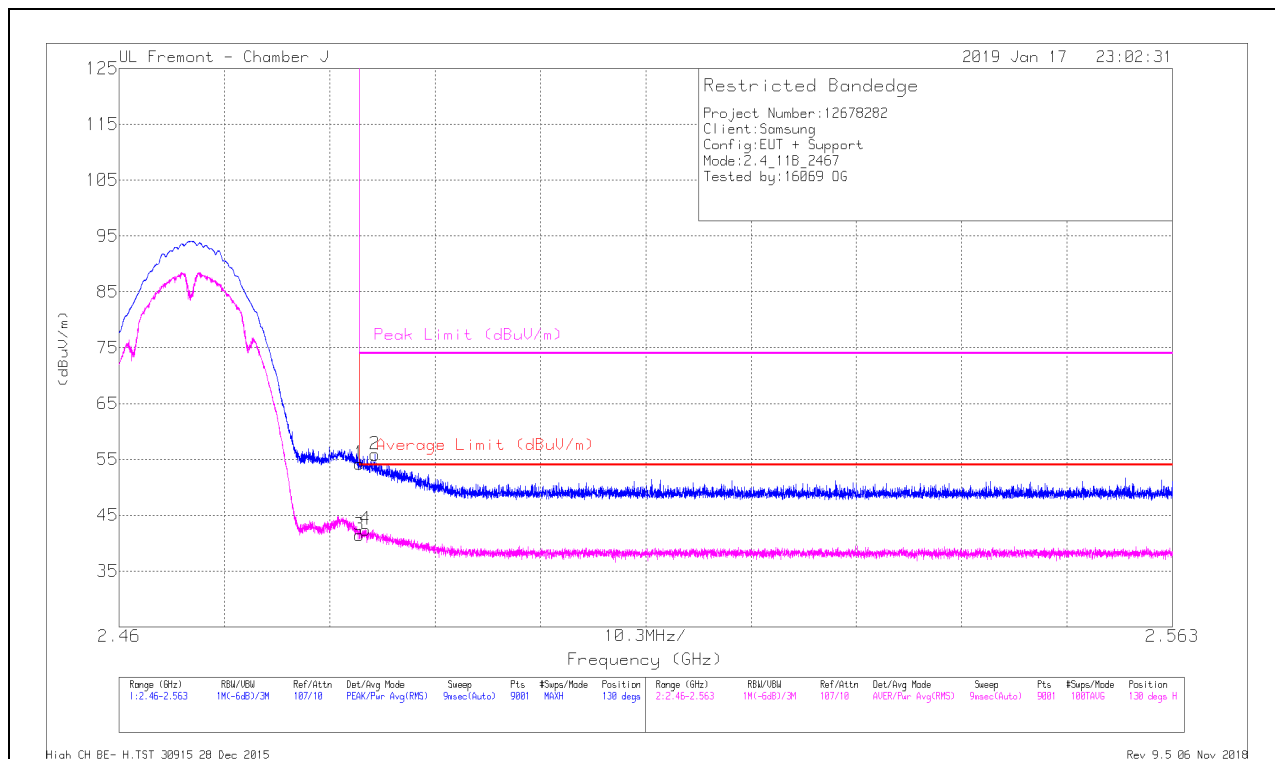

Marker	Frequency (GHz)	Meter Reading (dBuV)	Det	AF AT0067 (dB/m)	Amp/Cb/Ftr/Pad (dB)	DC Corr (dB)	Corrected Reading (dBuV/m)	Average Limit (dBuV/m)	Margin (dB)	Peak Limit (dBuV/m)	PK Margin (dB)	Azimuth (Degs)	Height (cm)	Polarity
1	* 2.484	47.53	Pk	32.5	-25.8	0	54.23	-	-	74	-19.77	130	333	H
2	* 2.485	49.17	Pk	32.5	-25.8	0	55.87	-	-	74	-18.13	130	333	H
3	* 2.484	34.72	RMS	32.5	-25.8	0	41.42	54	-12.58	-	-	130	333	H
4	* 2.484	35.74	RMS	32.5	-25.8	0	42.44	54	-11.56	-	-	130	333	H

* - indicates frequency in CFR47 Pt 15 / IC RSS-Restricted Band

Pk - Peak detector

RMS - RMS detection

VERTICAL RESULT

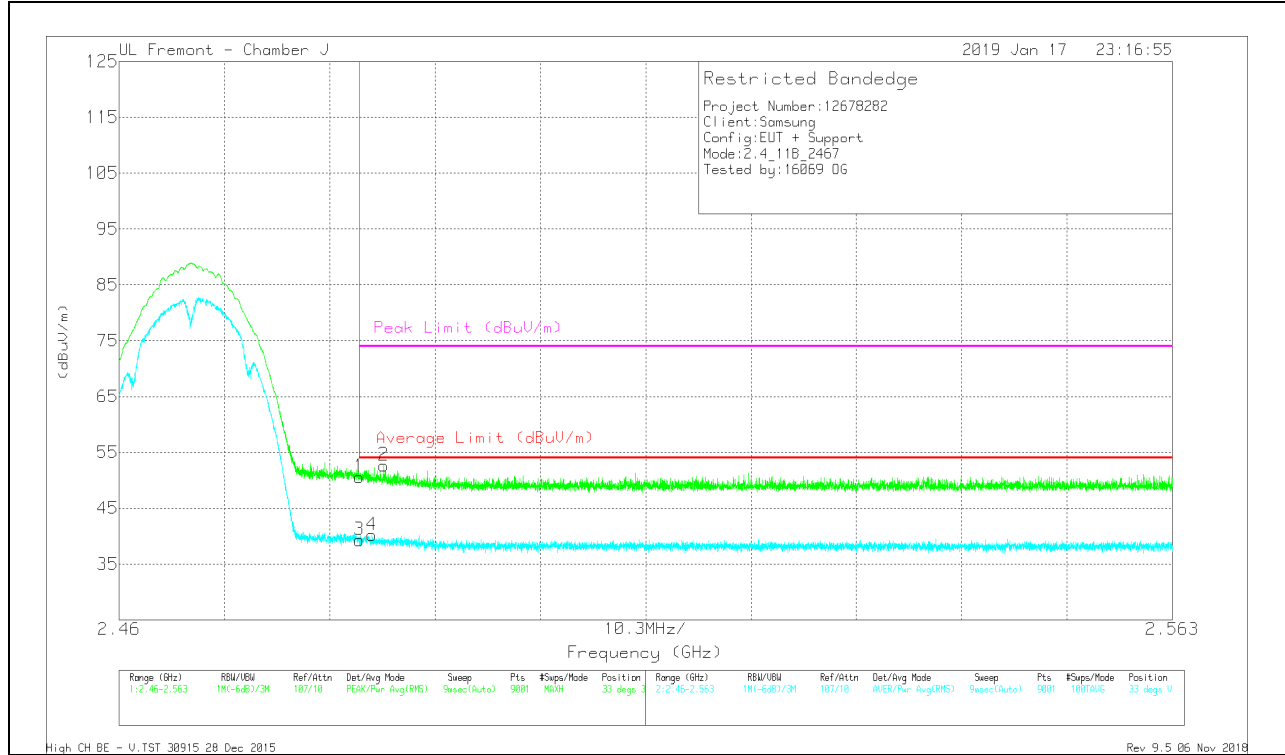

Marker	Frequency (GHz)	Meter Reading (dBuV)	Det	AF AT0067 (dBm)	Amp/Cbl/Ftr/Pad (dB)	DC Corr (dB)	Corrected Reading (dBuV/m)	Average Limit (dBuV/m)	Margin (dB)	Peak Limit (dBuV/m)	PK Margin (dB)	Azimuth (Degs)	Height (cm)	Polarity
1	* 2.484	43.88	Pk	32.5	-25.8	0	50.58	-	-	74	-23.42	33	362	V
2	* 2.486	45.87	Pk	32.5	-25.7	0	52.67	-	-	74	-21.33	33	362	V
3	* 2.484	32.6	RMS	32.5	-25.8	0	39.3	54	-14.7	-	-	33	362	V
4	* 2.485	33.48	RMS	32.5	-25.8	0	40.18	54	-13.82	-	-	33	362	V

* - indicates frequency in CFR47 Pt 15 / IC RSS-Restricted Band

Pk - Peak detector

RMS - RMS detection

BANDEDGE (HIGH CHANNEL, CH 13)

HORIZONTAL RESULT

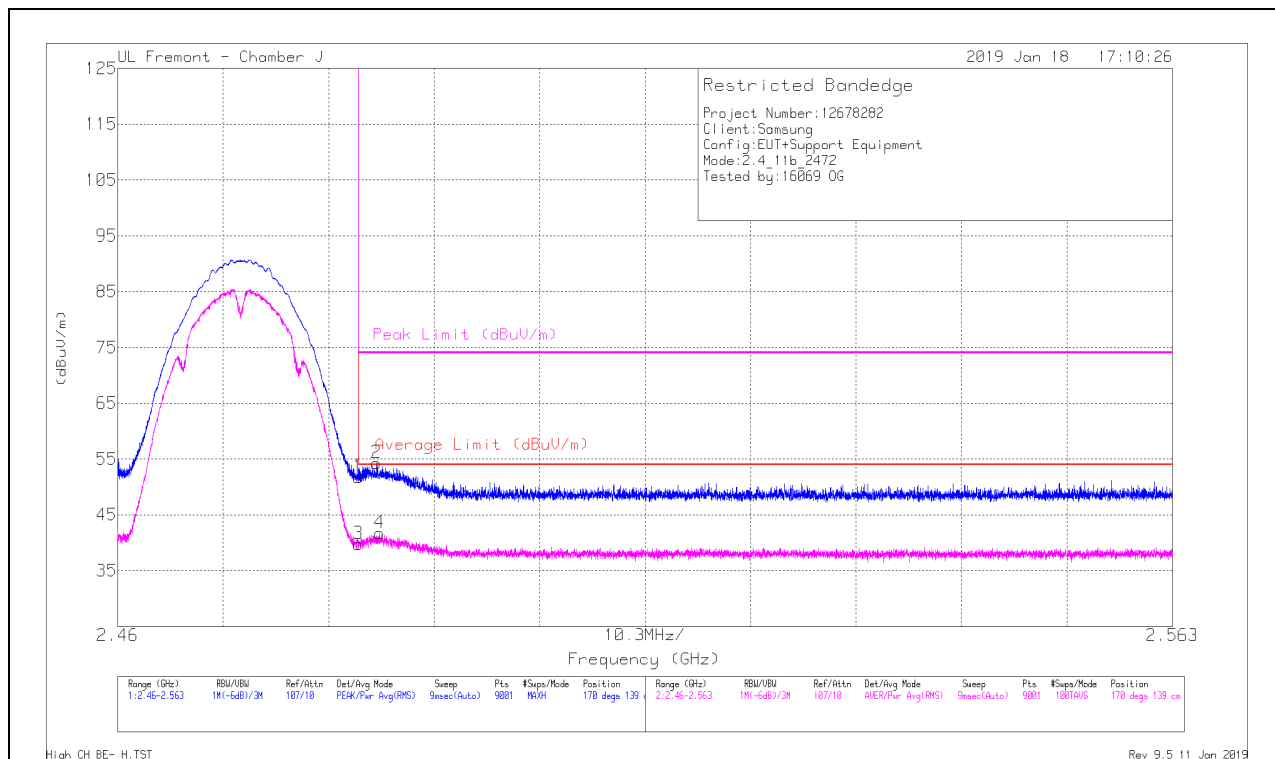

Marker	Frequency (GHz)	Meter Reading (dBuV)	Det	AF AT0067 (dBm)	Amp/Cb/Ftr/Pad (dB)	DC Corr (dB)	Corrected Reading (dBuV/m)	Average Limit (dBuV/m)	Margin (dB)	Peak Limit (dBuV/m)	PK Margin (dB)	Azimuth (Degs)	Height (cm)	Polarity
1	* 2.484	45.12	Pk	32.5	-25.8	0	51.82	-	-	74	-22.18	170	139	H
2	* 2.485	47.58	Pk	32.5	-25.8	0	54.28	-	-	74	-19.72	170	139	H
3	* 2.484	33.07	RMS	32.5	-25.8	0	39.77	54	-14.23	-	-	170	139	H
4	* 2.486	34.87	RMS	32.5	-25.7	0	41.67	54	-12.33	-	-	170	139	H

* - indicates frequency in CFR47 Pt 15 / IC RSS-Restricted Band

Pk - Peak detector

RMS - RMS detection

VERTICAL RESULT

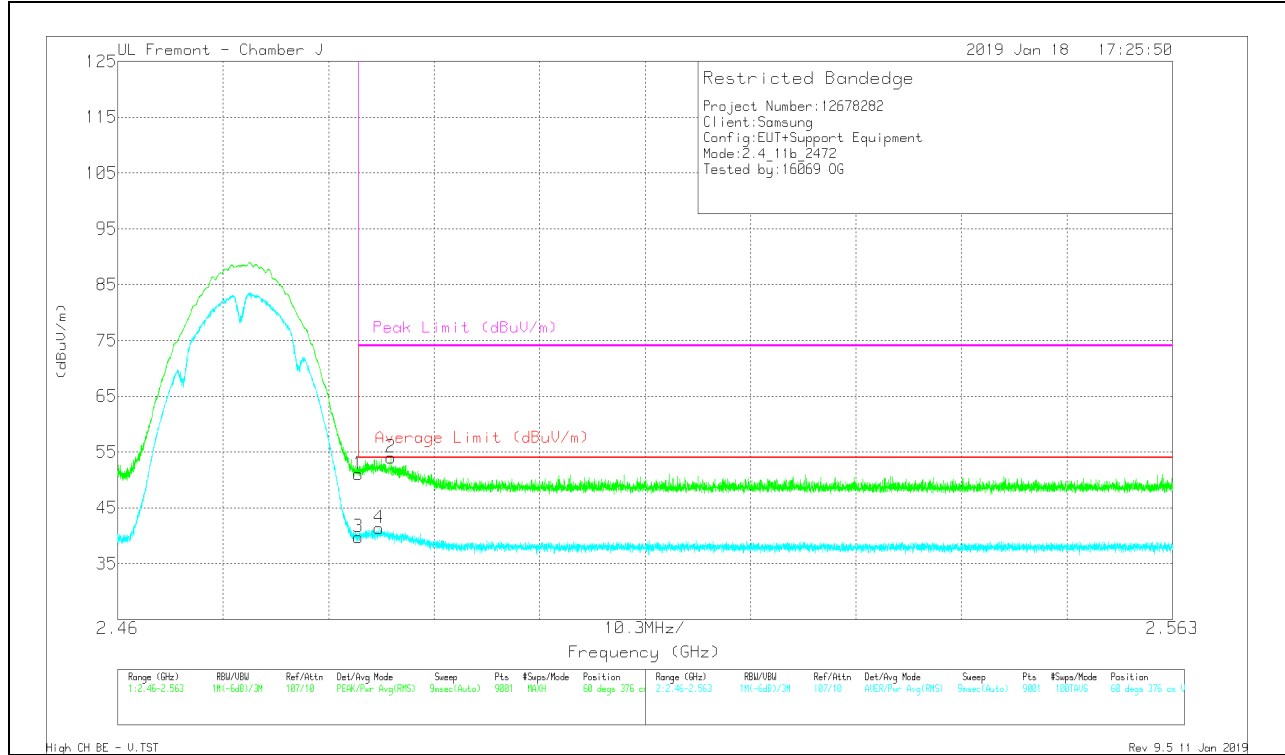

Marker	Frequency (GHz)	Meter Reading (dBuV)	Det	AF AT0067 (dBm)	Amp/Cou/Filt/Pad (dB)	DC Corr (dB)	Corrected Reading (dBuV/m)	Average Limit (dBuV/m)	Margin (dB)	Peak Limit (dBuV/m)	PK Margin (dB)	Azimuth (Degs)	Height (cm)	Polarity
1	* 2.484	44.36	Pk	32.5	-25.8	0	51.06	-	-	74	-22.94	60	376	V
2	* 2.487	47.27	Pk	32.5	-25.7	0	54.07	-	-	74	-19.93	60	376	V
3	* 2.484	33.07	RMS	32.5	-25.8	0	39.77	54	-14.23	-	-	60	376	V
4	* 2.485	34.56	RMS	32.5	-25.7	0	41.36	54	-12.64	-	-	60	376	V

* - indicates frequency in CFR47 Pt 15 / IC RSS-Restricted Band

Pk - Peak detector
 RMS - RMS detection

HARMONICS AND SPURIOUS EMISSIONS

LOW CHANNEL, CH 4 RESULTS

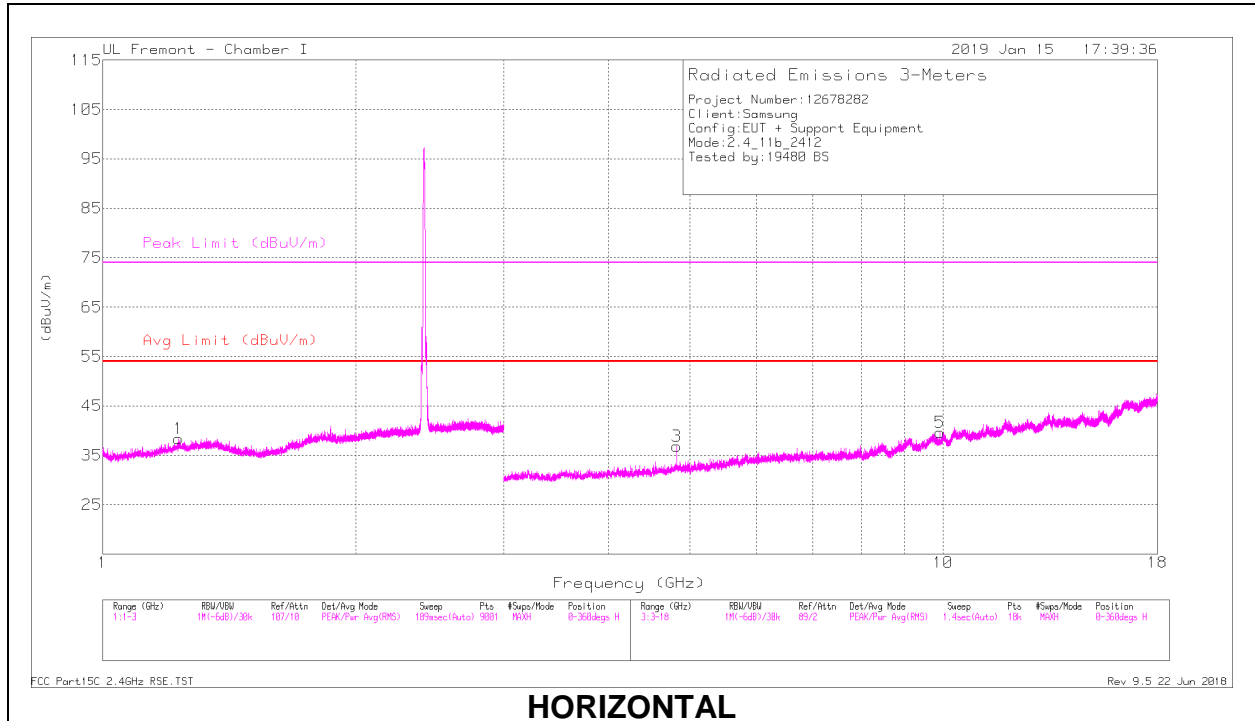

HORIZONTAL

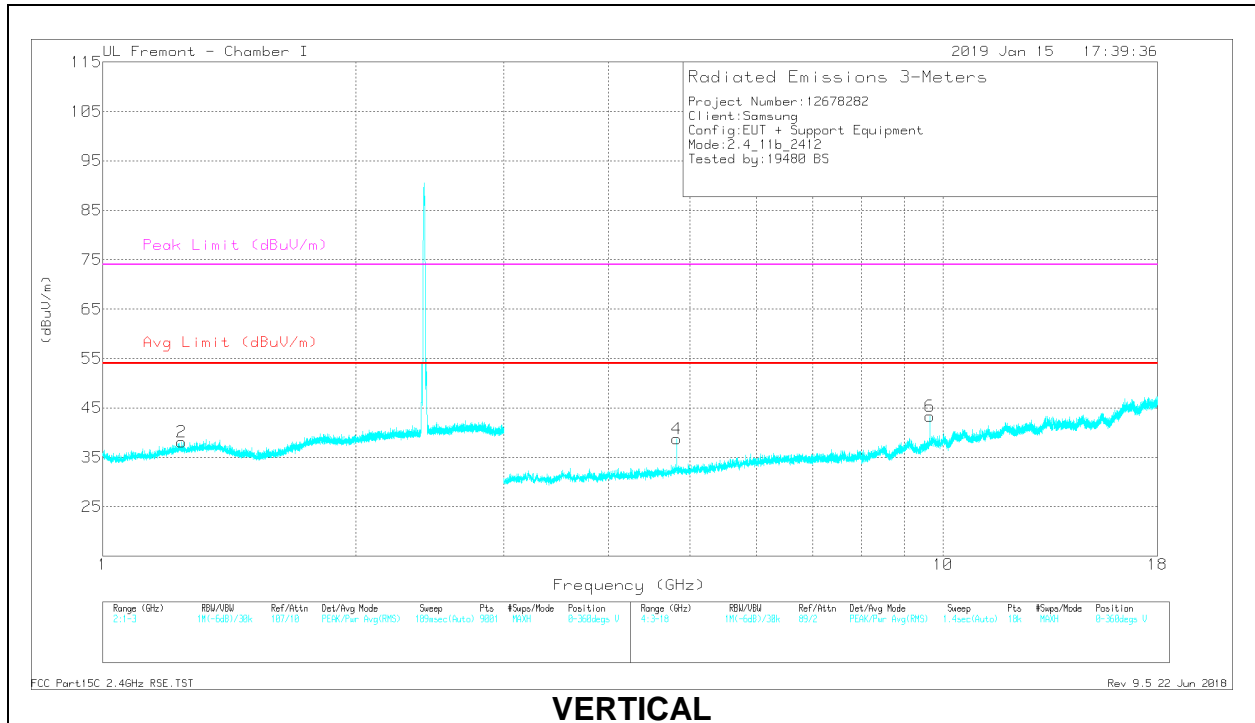

VERTICAL

RADIATED EMISSIONS

Frequency (GHz)	Meter Reading (dBuV)	Det	AF T862 (dB/m)	Amp/Cbl/Filtr/Pad (dB)	Corrected Reading (dBuV/m)	Avg Limit (dBuV/m)	Margin (dB)	Peak Limit (dBuV/m)	PK Margin (dB)	Azimuth (Degs)	Height (cm)	Polarity
* 1.232	38.07	PK2	29	-22.9	44.17	-	-	74	-29.83	177	312	H
* 1.232	29.06	MAv1	29	-22.9	35.16	54	-18.84	-	-	177	312	H
* 1.242	39.35	PK2	28.9	-22.9	45.35	-	-	74	-28.65	221	255	V
* 1.241	29.28	MAv1	28.9	-22.9	35.28	54	-18.72	-	-	221	255	V
* 4.824	37	PK2	34.2	-28.3	42.9	-	-	74	-31.1	230	368	H
* 4.824	28.73	MAv1	34.2	-28.3	34.63	54	-19.37	-	-	230	368	H
9.912	30.74	PK2	37.1	-21.8	46.04	-	-	-	-	118	205	H
* 4.824	38.05	PK2	34.2	-28.3	43.95	-	-	74	-30.05	4	102	V
* 4.824	29.2	MAv1	34.2	-28.3	35.1	54	-18.9	-	-	4	102	V
9.648	32	PK2	36.8	-21.5	47.3	-	-	-	-	154	118	V

* - indicates frequency in CFR47 Pt 15 / IC RSS-Restricted Band

PK2 - KDB558074 Method: Maximum Peak

MAv1 - KDB558074 Option 1 Maximum RMS Average

MID CHANNEL, CH 6 RESULTS

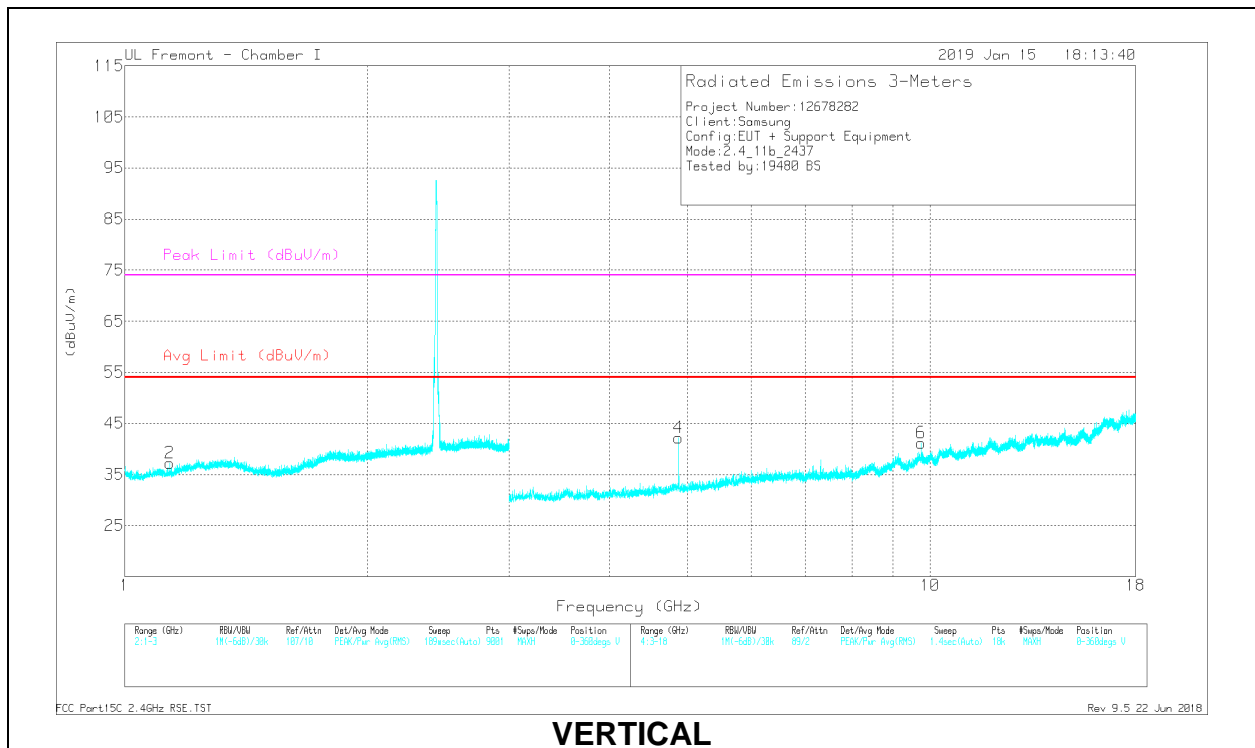
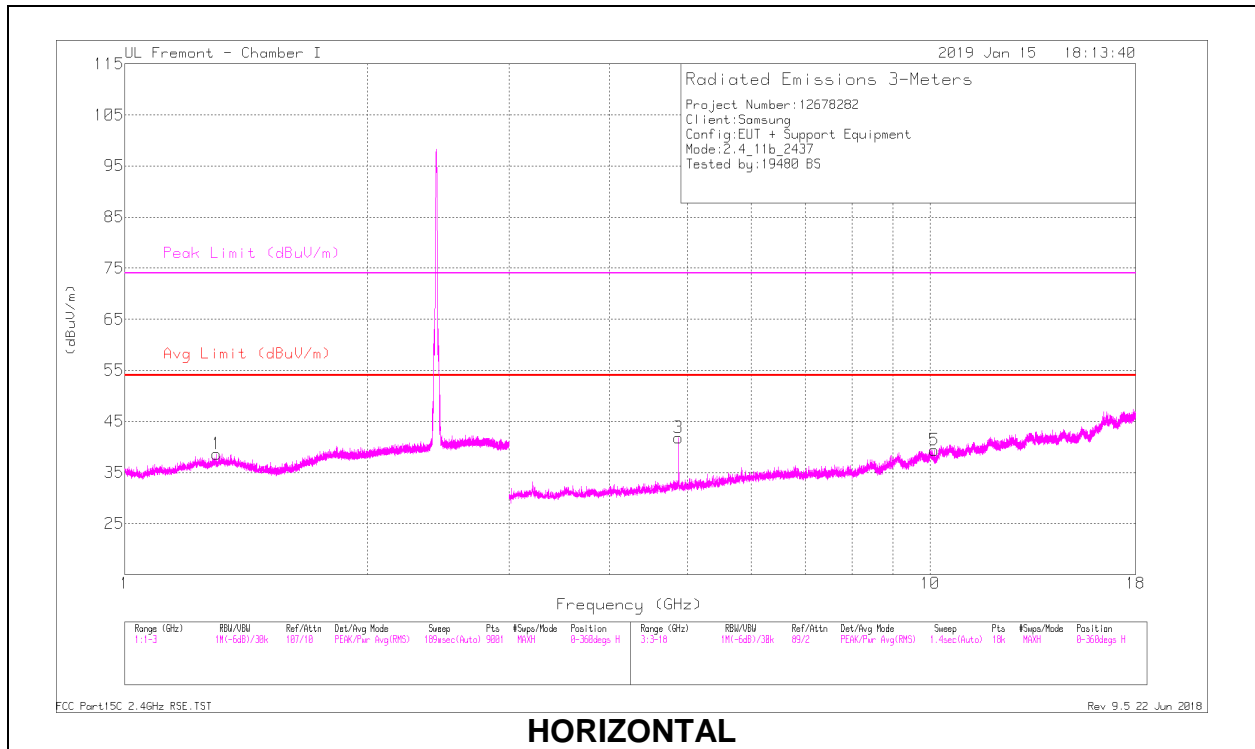

RADIATED EMISSIONS

Frequency (GHz)	Meter Reading (dBuV)	Det	AF T862 (dB/m)	Amp/Cbl/Fitr/ Pad (dB)	Corrected Reading (dBuV/m)	Avg Limit (dBuV/m)	Margin (dB)	Peak Limit (dBuV/m)	PK Margin (dB)	Azimuth (Degs)	Height (cm)	Polarity
* 1.302	38.58	PK2	29.2	-23	44.78	-	-	74	-29.22	295	116	H
* 1.3	28.92	MAv1	29.2	-23	35.12	54	-18.88	-	-	295	116	H
* 1.137	39.39	PK2	27.6	-23.4	43.59	-	-	74	-30.41	224	377	V
* 1.135	29.29	MAv1	27.6	-23.4	33.49	54	-20.51	-	-	224	377	V
* 4.874	39.68	PK2	34.2	-28.6	45.28	-	-	74	-28.72	257	110	H
* 4.874	35.71	MAv1	34.2	-28.6	41.31	54	-12.69	-	-	257	110	H
10.13	30.18	PK2	37.2	-21.5	45.88	-	-	-	-	230	335	H
* 4.874	39.9	PK2	34.2	-28.6	45.5	-	-	74	-28.5	27	119	V
* 4.874	36.15	MAv1	34.2	-28.6	41.75	54	-12.25	-	-	27	119	V
9.748	31.34	PK2	36.9	-20.5	47.74	-	-	-	-	117	103	V

* - indicates frequency in CFR47 Pt 15 / IC RSS-Restricted Band

PK2 - KDB558074 Method: Maximum Peak

MAv1 - KDB558074 Option 1 Maximum RMS Average

HIGH CHANNEL, CH 11 RESULTS

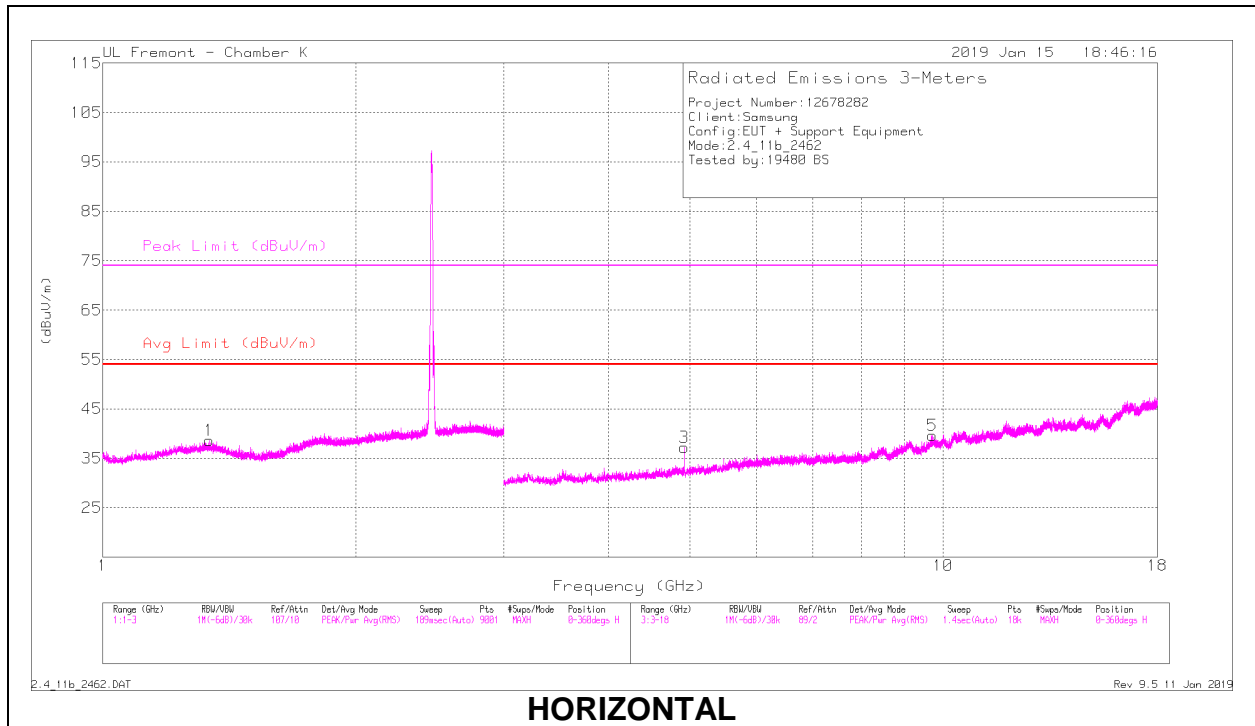

HORIZONTAL

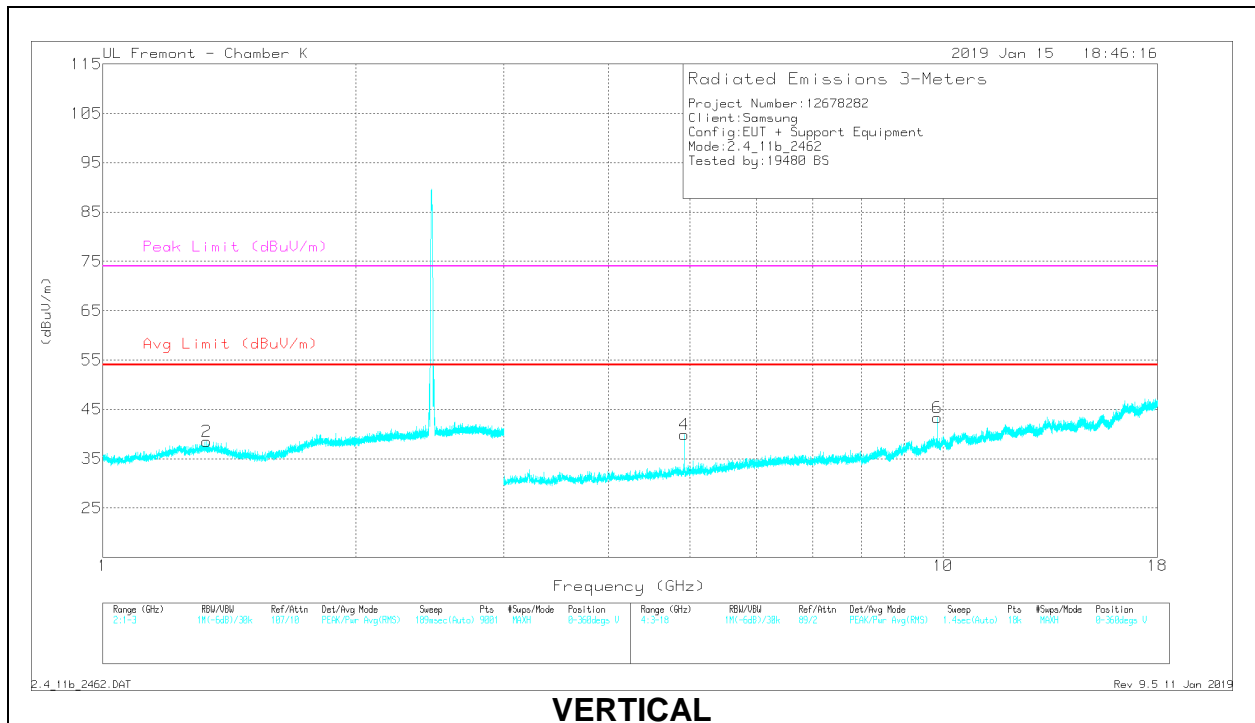

VERTICAL

RADIATED EMISSIONS

Frequency (GHz)	Meter Reading (dBuV)	Det	AF T862 (dB/m)	Amp/Cbl/Fitr/ Pad (dB)	Corrected Reading (dBuV/m)	Avg Limit (dBuV/m)	Margin (dB)	Peak Limit (dBuV/m)	PK Margin (dB)	Azimuth (Degs)	Height (cm)	Polarity
* 1.338	38.82	PK2	29.3	-23	45.12	-	-	74	-28.88	144	299	H
* 1.336	28.9	MAv1	29.3	-23	35.2	54	-18.8	-	-	144	299	H
* 1.328	38.26	PK2	29.3	-23	44.56	-	-	74	-29.44	10	121	V
* 1.331	29.23	MAv1	29.2	-23.1	35.33	54	-18.67	-	-	10	121	V
* 4.924	37.57	PK2	34.2	-29	42.77	-	-	74	-31.23	249	176	H
* 4.924	28.56	MAv1	34.2	-29	33.76	54	-20.24	-	-	249	176	H
9.713	29.85	PK2	36.9	-20.8	45.95	-	-	-	-	182	127	H
* 4.924	39.06	PK2	34.2	-29	44.26	-	-	74	-29.74	42	103	V
* 4.924	32.47	MAv1	34.2	-29	37.67	54	-16.33	-	-	42	103	V
9.848	33.61	PK2	36.9	-22	48.51	-	-	-	-	355	103	V

* - indicates frequency in CFR47 Pt 15 / IC RSS-Restricted Band

PK2 - KDB558074 Method: Maximum Peak

MAv1 - KDB558074 Option 1 Maximum RMS Average

10.1.2. TX ABOVE 1 GHz 802.11g MODE IN THE 2.4 GHz BAND

1TX Antenna 1 MODE

BANDEDGE (LOW CHANNEL, CH 1)

HORIZONTAL RESULT

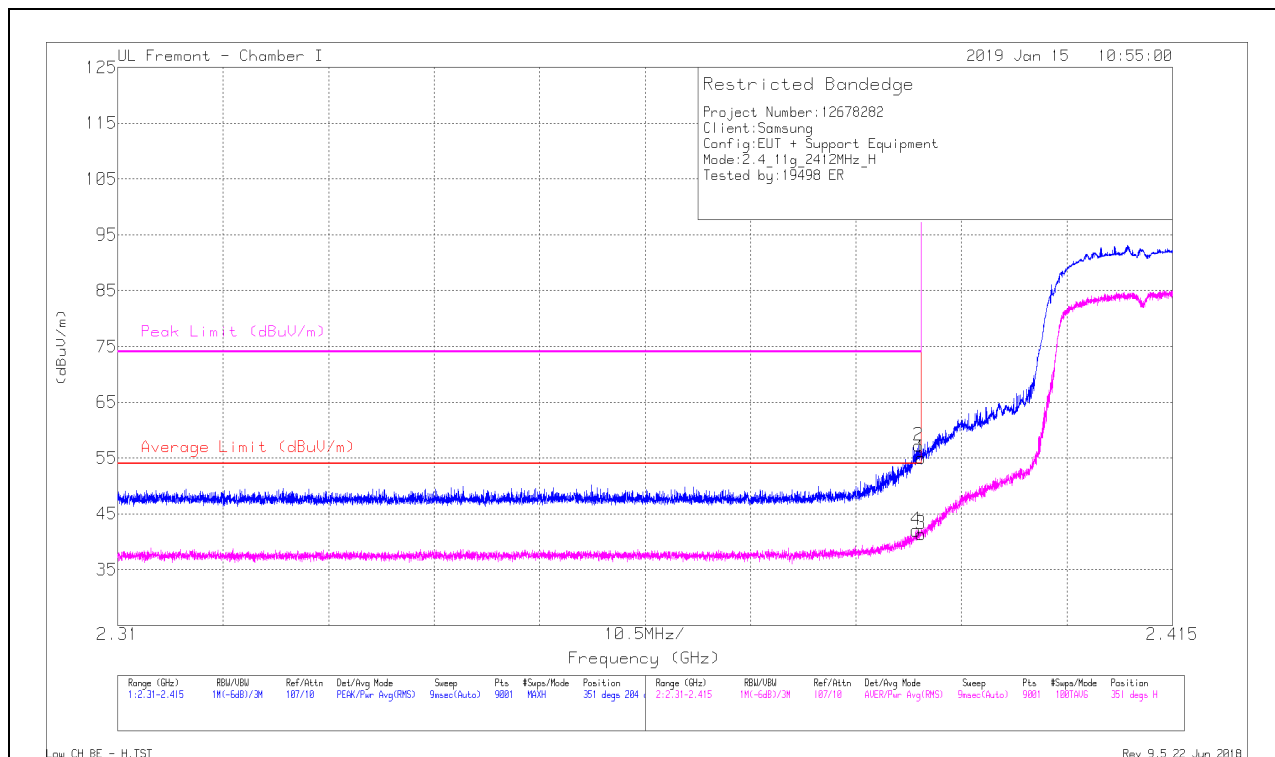

Marker	Frequency (GHz)	Meter Reading (dBuV)	Det	AF T652 (dBm)	Amp/Chl/Filt/Pad (dB)	DC Corr (dB)	Corrected Reading (dBuV/m)	Average Limit (dBuV/m)	Margin (dB)	Peak Limit (dBuV/m)	PK Margin (dB)	Azimuth (Degs)	Height (cm)	Polarity
1	* 2.39	44.76	Pk	31.8	-21.6	0	54.96	-	-	74	-19.04	351	204	H
2	* 2.39	47.05	Pk	31.8	-21.6	0	57.25	-	-	74	-16.75	351	204	H
3	* 2.39	30.81	RMS	31.8	-21.6	.4	41.41	54	-12.59	-	-	351	204	H
4	* 2.389	31.44	RMS	31.8	-21.6	.4	42.04	54	-11.96	-	-	351	204	H

* - indicates frequency in CFR47 Pt 15 / IC RSS-Restricted Band

Pk - Peak detector

RMS - RMS detection

VERTICAL RESULT

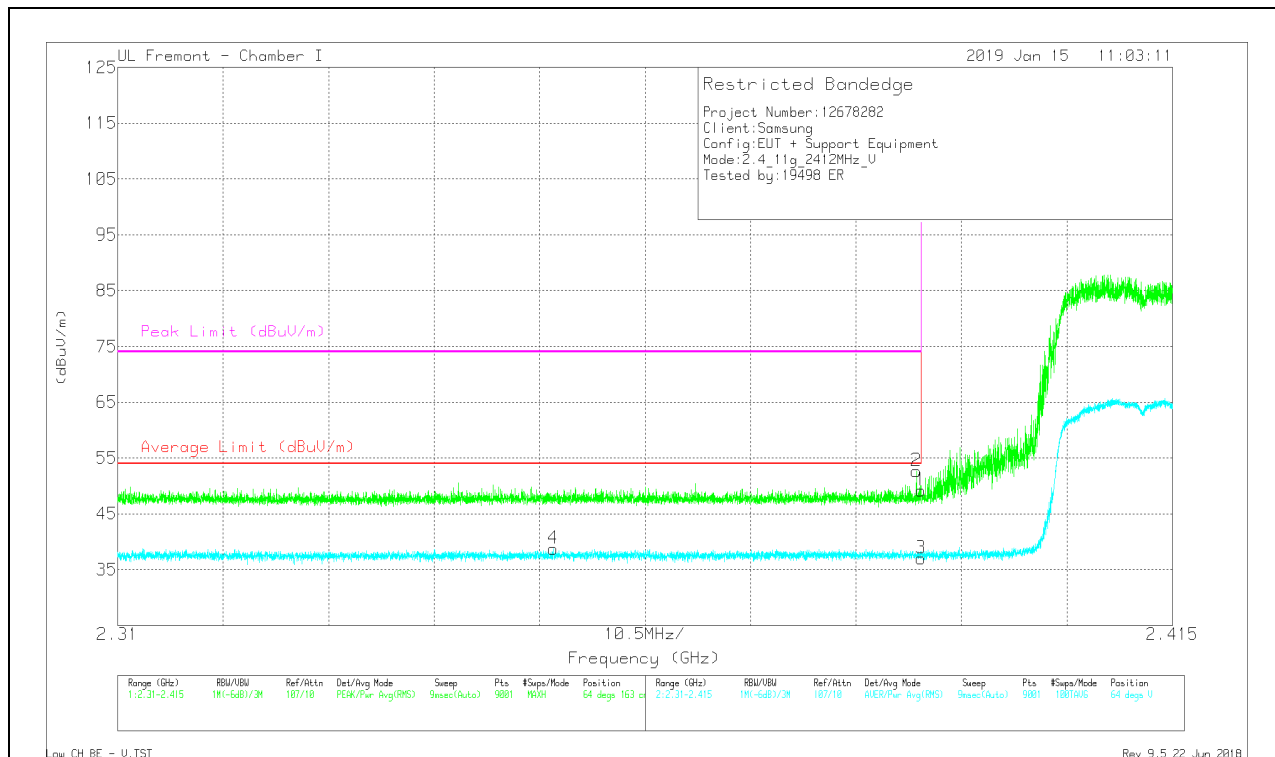

Marker	Frequency (GHz)	Meter Reading (dBuV)	Det	AF T862 (dB/m)	Amp/Cb/Filtz/Pad (dB)	DC Corr (dB)	Corrected Reading (dBuV/m)	Average Limit (dBuV/m)	Margin (dB)	Peak Limit (dBuV/m)	PK Margin (dB)	Azimuth (Degs)	Height (cm)	Polarity
1	* 2.39	38.97	Pk	31.8	-21.6	0	49.17	-	-	74	-24.83	64	163	V
2	* 2.39	42.44	Pk	31.8	-21.6	0	52.64	-	-	74	-21.36	64	163	V
3	* 2.39	26.45	RMS	31.8	-21.6	.4	37.05	54	-16.95	-	-	64	163	V
4	* 2.353	28.19	RMS	31.6	-21.5	.4	38.69	54	-15.31	-	-	64	163	V

* - indicates frequency in CFR47 Pt 15 / IC RSS-Restricted Band

Pk - Peak detector

RMS - RMS detection

BANDEDGE (HIGH CHANNEL, CH 11)

HORIZONTAL RESULT

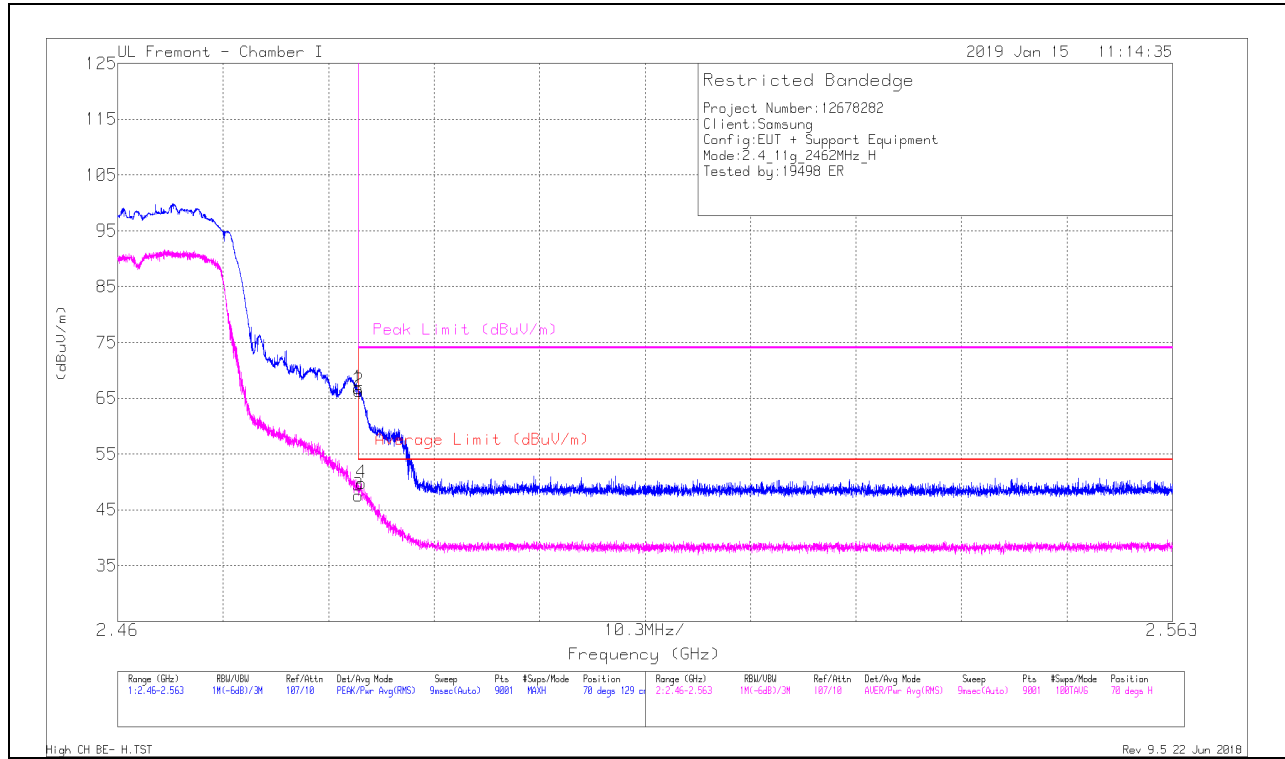

Marker	Frequency (GHz)	Meter Reading (dBuV)	Det	AF T862 (dB/m)	Amp/Cbl/Fitr/Pad (dB)	DC Corr (dB)	Corrected Reading (dBuV/m)	Average Limit (dBuV/m)	Margin (dB)	Peak Limit (dBuV/m)	PK Margin (dB)	Azimuth (Degs)	Height (cm)	Polarity
1	* 2.484	56.05	Pk	32.4	-21.7	0	66.75	-	-	74	-7.25	70	129	H
2	* 2.484	55.61	Pk	32.4	-21.7	0	66.31	-	-	74	-7.69	70	129	H
3	* 2.484	36.48	RMS	32.4	-21.7	.4	47.58	54	-6.42	-	-	70	129	H
4	* 2.484	38.74	RMS	32.4	-21.7	.4	49.84	54	-4.16	-	-	70	129	H

* - indicates frequency in CFR47 Pt 15 / IC RSS-Restricted Band
 Pk - Peak detector
 RMS - RMS detection

VERTICAL RESULT

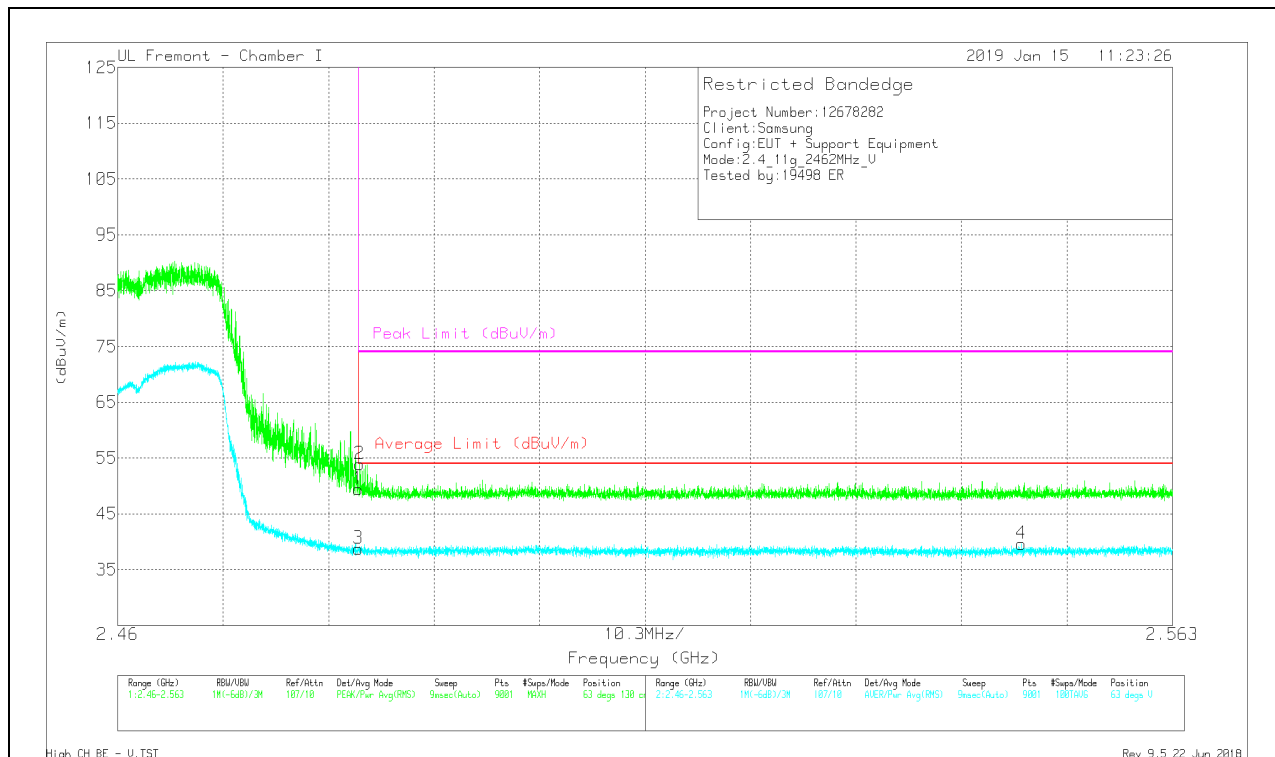

Marker	Frequency (GHz)	Meter Reading (dBuV)	Det	AF T862 (dB/m)	Amp/Cb/Filt/Pad (dB)	DC Corr (dB)	Corrected Reading (dBu/m)	Average Limit (dBu/m)	Margin (dB)	Peak Limit (dBu/m)	PK Margin (dB)	Azimuth (Degs)	Height (cm)	Polarity
1	* 2.484	38.76	Pk	32.4	-21.7	0	49.46	-	-	74	-24.54	63	130	V
2	* 2.484	43.18	Pk	32.4	-21.7	0	53.88	-	-	74	-20.12	63	130	V
3	* 2.484	27.6	RMS	32.4	-21.7	.4	38.7	54	-15.3	-	-	63	130	V
4	2.548	28.57	RMS	32.4	-21.7	.4	39.67	54	-14.33	-	-	63	130	V

* - indicates frequency in CFR47 Pt 15 / IC RSS-Restricted Band
 Pk - Peak detector
 RMS - RMS detection

BANDEDGE (HIGH CHANNEL, CH 12)

HORIZONTAL RESULT

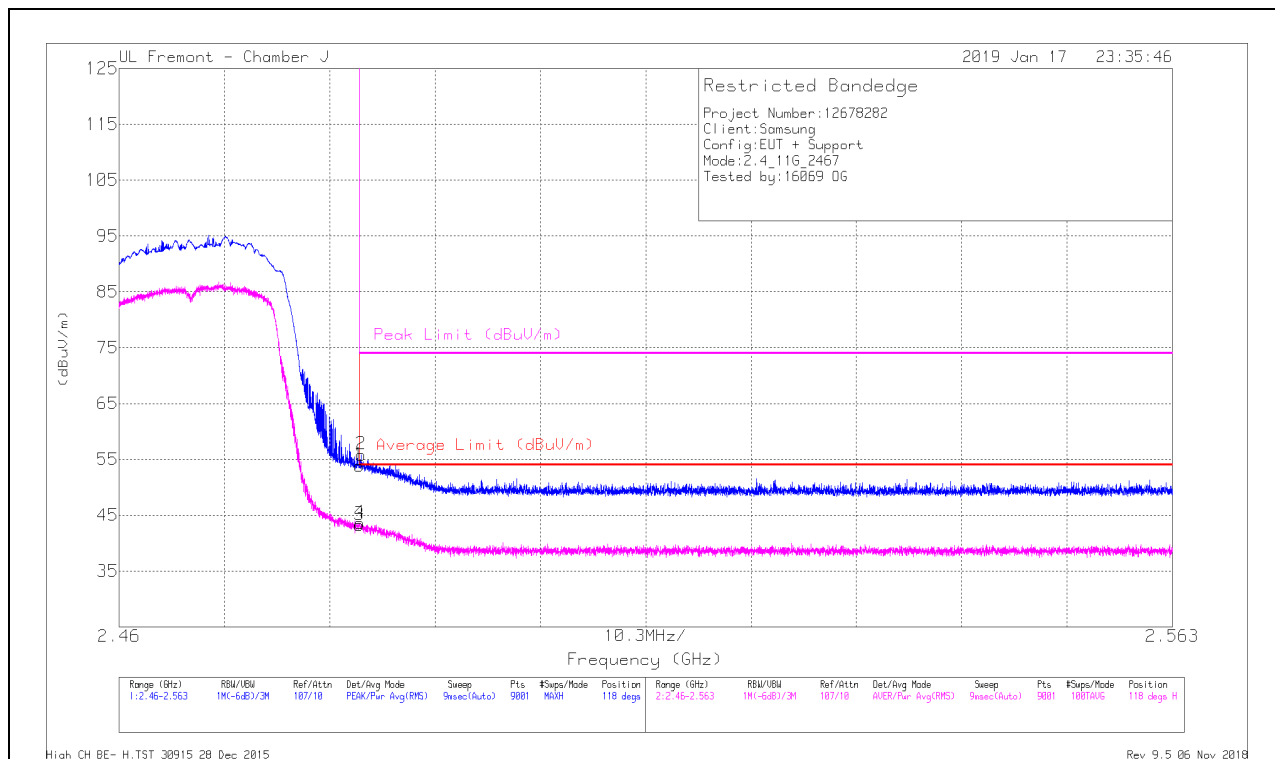

Marker	Frequency (GHz)	Meter Reading (dBuV)	Det	AF AT0067 (dB/m)	Amp/Cb/Ftr/Pad (dB)	DC Corr (dB)	Corrected Reading (dBuV/m)	Average Limit (dBuV/m)	Margin (dB)	Peak Limit (dBuV/m)	PK Margin (dB)	Azimuth (Degs)	Height (cm)	Polarity
1	* 2.484	47.19	Pk	32.5	-25.8	0	53.89	-	-	74	-20.11	118	234	H
2	* 2.484	49.15	Pk	32.5	-25.8	0	55.85	-	-	74	-18.15	118	234	H
3	* 2.484	36.16	RMS	32.5	-25.8	.4	43.26	54	-10.74	-	-	118	234	H
4	* 2.484	36.49	RMS	32.5	-25.8	.4	43.59	54	-10.41	-	-	118	234	H

* - indicates frequency in CFR47 Pt 15 / IC RSS-Restricted Band

Pk - Peak detector

RMS - RMS detection

VERTICAL RESULT

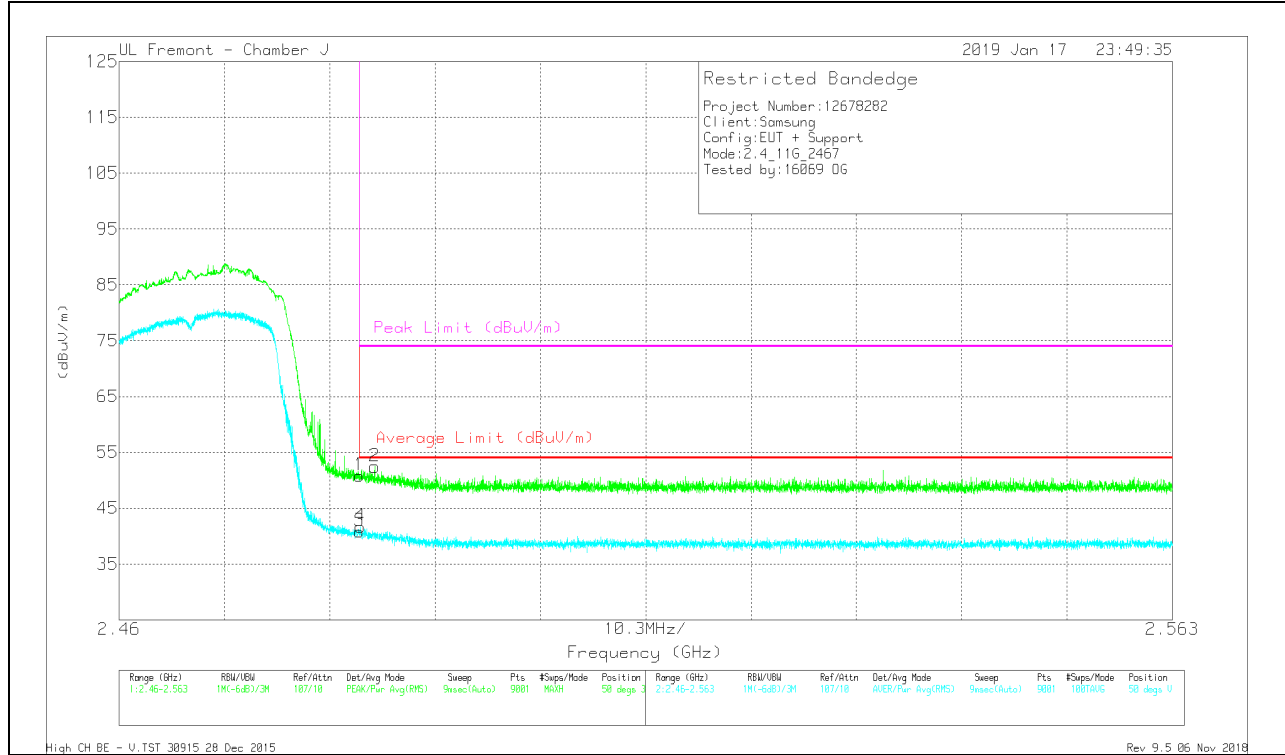

Marker	Frequency (GHz)	Meter Reading (dBuV)	Det	AF AT0067 (dBm)	Amp/Cbl/Filtr/Pad (dB)	DC Corr (dB)	Corrected Reading (dBuV/m)	Average Limit (dBuV/m)	Margin (dB)	Peak Limit (dBuV/m)	PK Margin (dB)	Azimuth (Degs)	Height (cm)	Polarity
1	* 2.484	44.17	Pk	32.5	-25.8	0	50.87	-	-	74	-23.13	50	331	V
2	* 2.485	45.77	Pk	32.5	-25.8	0	52.47	-	-	74	-21.53	50	331	V
3	* 2.484	33.77	RMS	32.5	-25.8	.4	40.87	54	-13.13	-	-	50	331	V
4	* 2.484	34.6	RMS	32.5	-25.8	.4	41.7	54	-12.3	-	-	50	331	V

* - indicates frequency in CFR47 Pt 15 / IC RSS-Restricted Band

Pk - Peak detector
 RMS - RMS detection

BANDEDGE (HIGH CHANNEL, CH 13)

HORIZONTAL RESULT

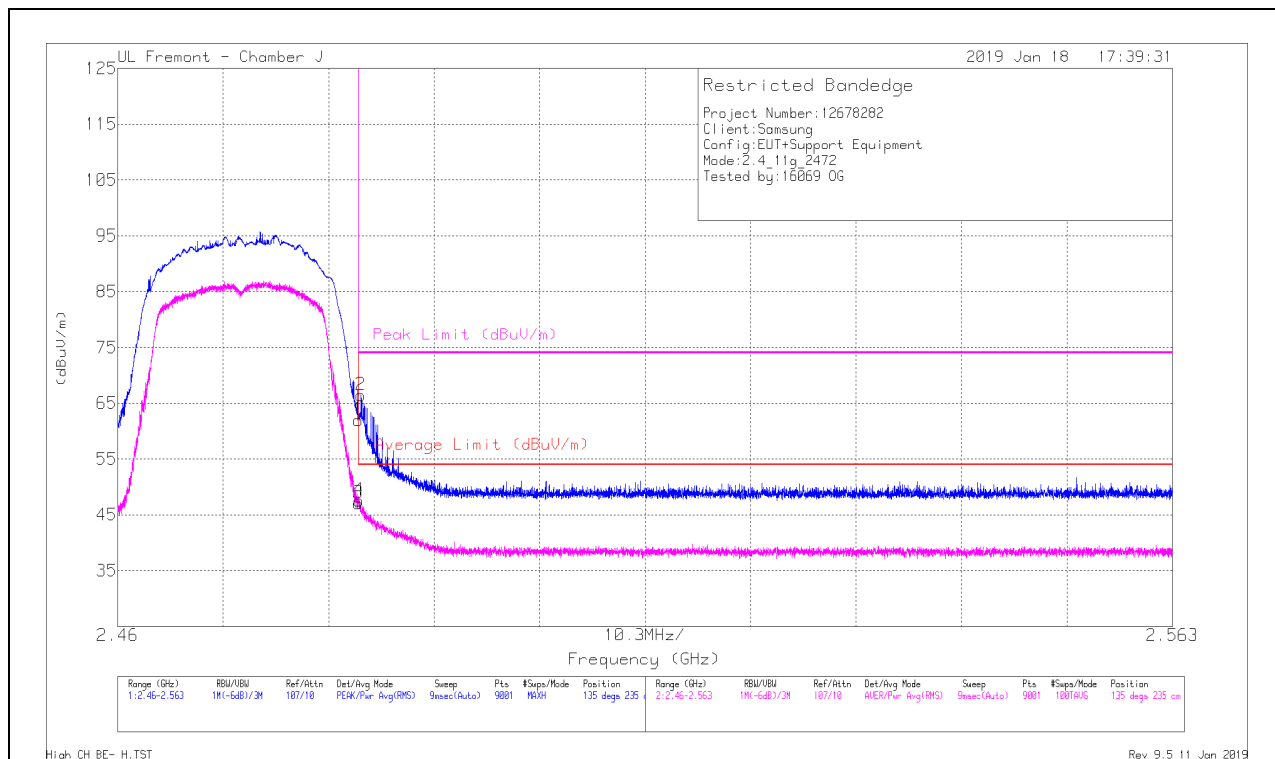

Marker	Frequency (GHz)	Meter Reading (dBuV)	Det	AF AT0067 (dBm)	Amp/Cbl/Filtr/Pad (dB)	DC Corr (dB)	Corrected Reading (dBuV/m)	Average Limit (dBuV/m)	Margin (dB)	Peak Limit (dBuV/m)	PK Margin (dB)	Azimuth (Degs)	Height (cm)	Polarity
1	* 2.484	55.29	Pk	32.5	-25.8	0	61.99	-	-	74	-12.01	135	235	H
2	* 2.484	59.7	Pk	32.5	-25.8	0	66.4	-	-	74	-7.6	135	235	H
3	* 2.484	39.95	RMS	32.5	-25.8	.4	47.05	54	-6.95	-	-	135	235	H
4	* 2.484	40.5	RMS	32.5	-25.8	.4	47.6	54	-6.4	-	-	135	235	H

* - indicates frequency in CFR47 Pt 15 / IC RSS-Restricted Band

Pk - Peak detector

RMS - RMS detection

VERTICAL RESULT

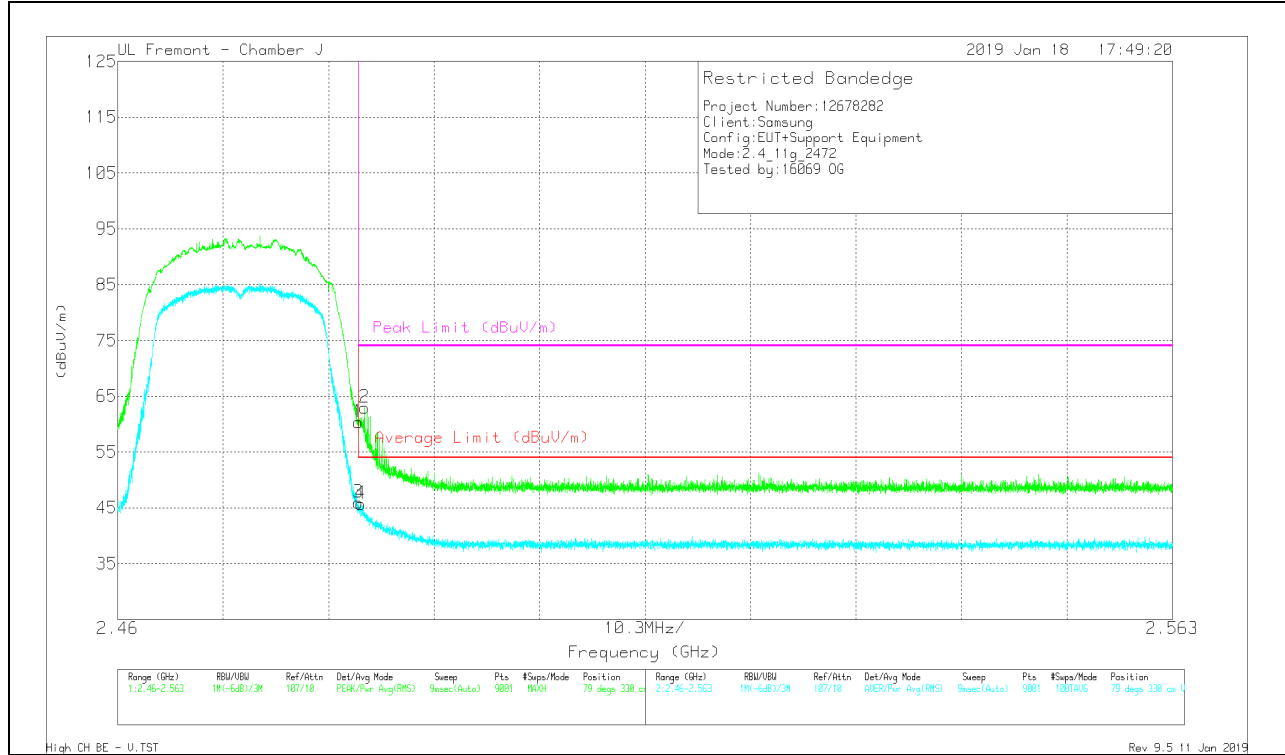

Marker	Frequency (GHz)	Meter Reading (dBuV)	Det	AF AT0067 (dBm)	Amp/Cb/Filt/Pad (dB)	DC Corr (dB)	Corrected Reading (dBuV/m)	Average Limit (dBuV/m)	Margin (dB)	Peak Limit (dBuV/m)	PK Margin (dB)	Azimuth (Degs)	Height (cm)	Polarity
1	* 2.484	53.63	Pk	32.5	-25.8	0	60.33	-	-	74	-13.67	79	330	V
2	* 2.484	56.26	Pk	32.5	-25.8	0	62.96	-	-	74	-11.04	79	330	V
3	* 2.484	38.82	RMS	32.5	-25.8	.4	45.92	54	-8.08	-	-	79	330	V
4	* 2.484	38.64	RMS	32.5	-25.8	.4	45.74	54	-8.26	-	-	79	330	V

* - indicates frequency in CFR47 Pt 15 / IC RSS-Restricted Band

Pk - Peak detector

RMS - RMS detection

HARMONICS AND SPURIOUS EMISSIONS

LOW CHANNEL, CH 1 RESULTS

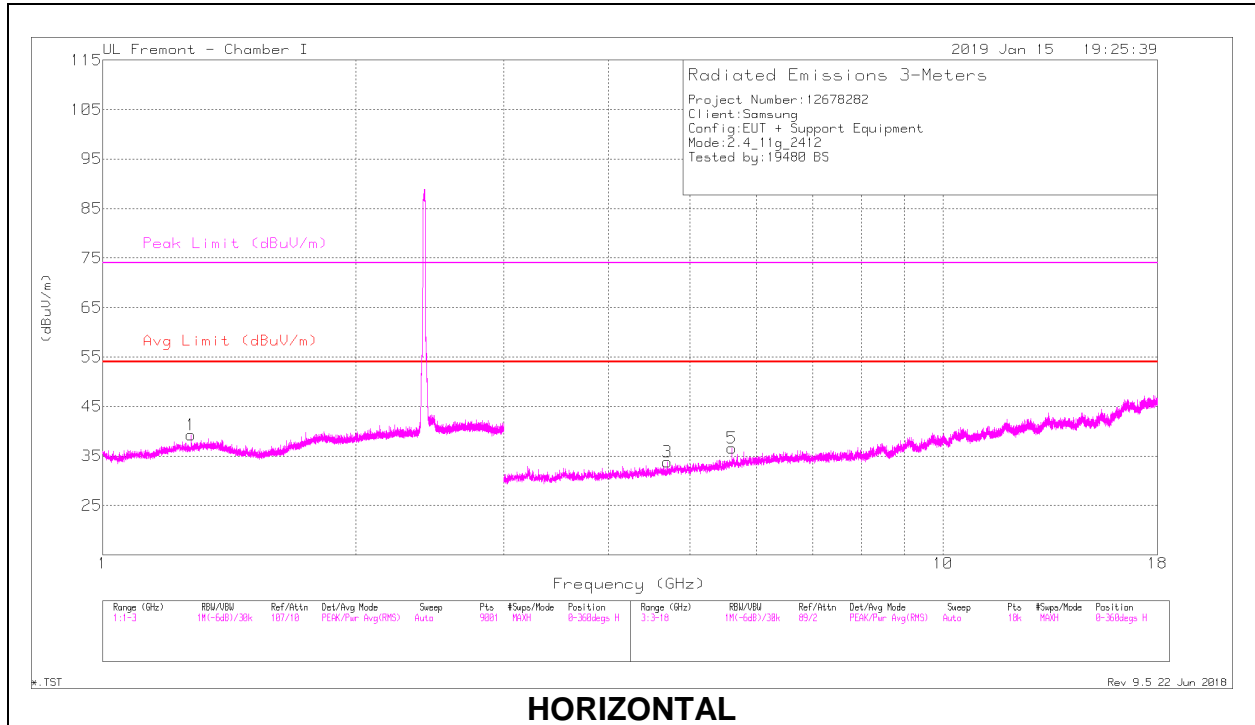

HORIZONTAL

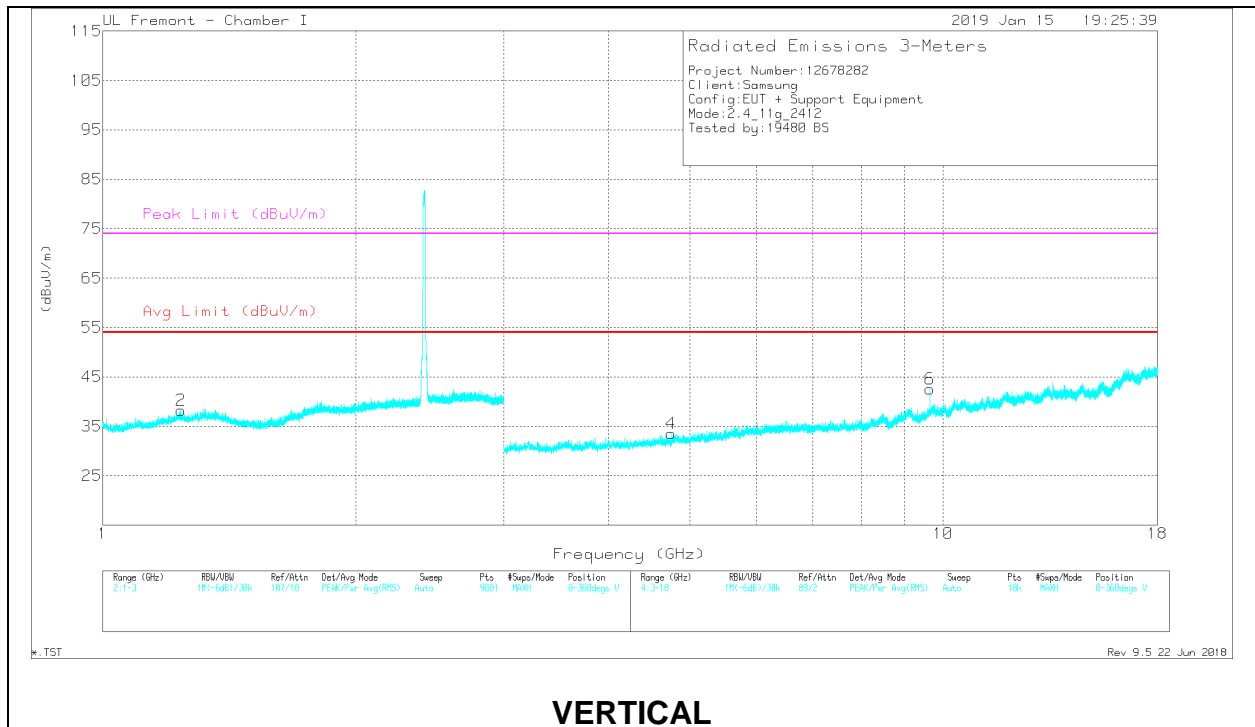

VERTICAL

RADIATED EMISSIONS

Frequency (GHz)	Meter Reading (dBuV)	Det	AF T862 (dB/m)	Amp/Cbl/Filtr/Pad (dB)	DC Corr (dB)	Corrected Reading (dBuV/m)	Avg Limit (dBuV/m)	Margin (dB)	Peak Limit (dBuV/m)	PK Margin (dB)	Azimuth (Degs)	Height (cm)	Polarity
* 1.272	38.66	PK2	29	-22.9	0	44.76	-	-	74	-29.24	18	133	H
* 1.273	28.69	MAv1	29	-22.9	.4	35.19	54	-18.81	-	-	18	133	H
* 1.238	38.45	PK2	29	-22.9	0	44.55	-	-	74	-29.45	111	377	V
* 1.238	28.94	MAv1	29	-22.9	.4	35.44	54	-18.56	-	-	111	377	V
* 4.699	35.39	PK2	33.8	-29	0	40.19	-	-	74	-33.81	329	292	H
* 4.7	25.45	MAv1	33.8	-29	.4	30.65	54	-23.35	-	-	329	292	H
5.607	34.44	PK2	35	-27.8	0	41.64	-	-	-	-	9	379	H
* 4.748	33.3	PK2	33.9	-28.4	0	38.8	-	-	74	-35.2	10	288	V
* 4.748	25.25	MAv1	33.9	-28.4	.4	31.15	54	-22.85	-	-	10	288	V
9.648	33.53	PK2	36.8	-21.5	0	48.83	-	-	-	-	142	104	V

* - indicates frequency in CFR47 Pt 15 / IC RSS-Restricted Band

PK2 - KDB558074 Method: Maximum Peak

MAv1 - KDB558074 Option 1 Maximum RMS Average

MID CHANNEL, CH 6 RESULTS

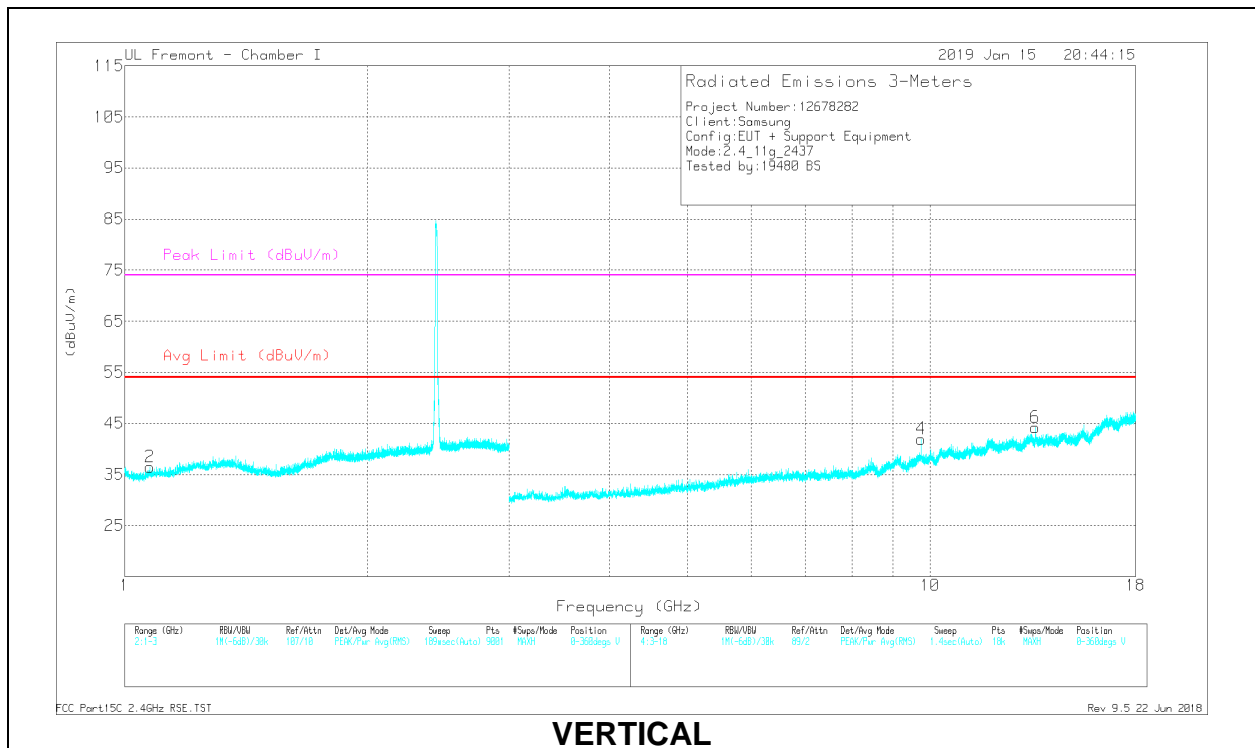
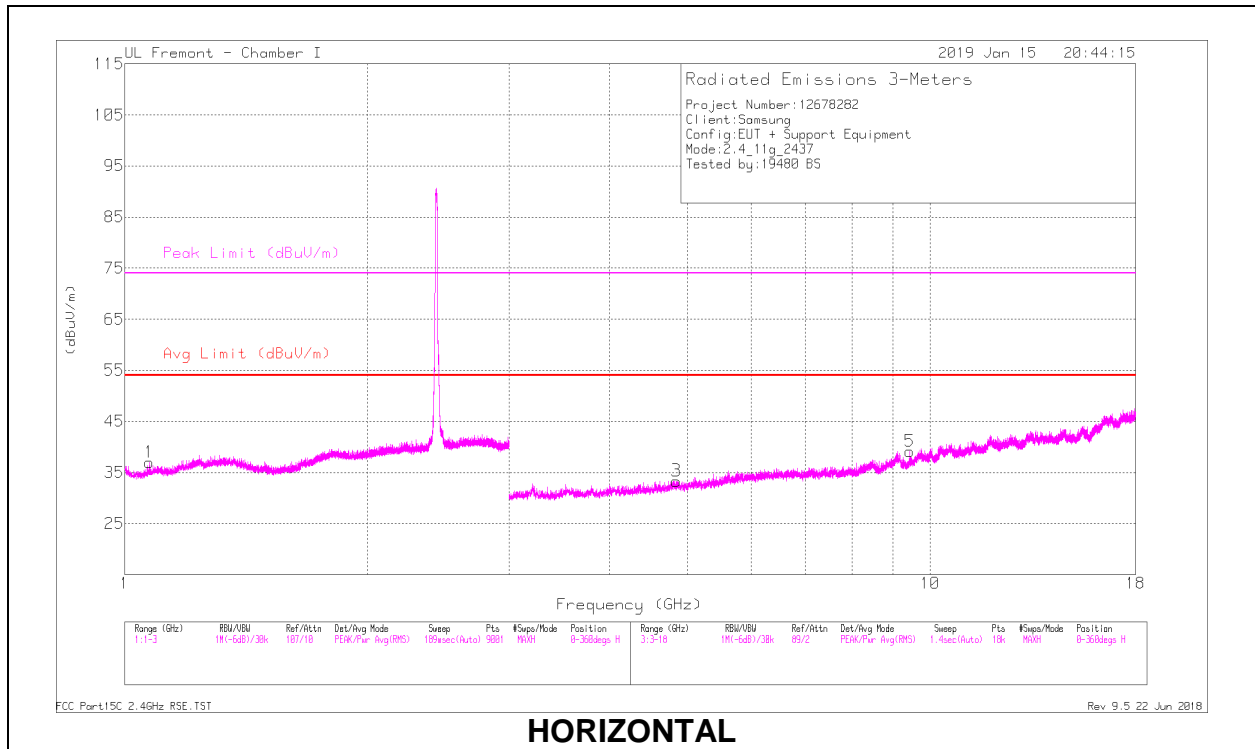

RADIATED EMISSIONS

Frequency (GHz)	Meter Reading (dBuV)	Det	AF T862 (dB/m)	Amp/Cbl/Fitr /Pad (dB)	DC Corr (dB)	Corrected Reading (dBuV/m)	Avg Limit (dBuV/m)	Margin (dB)	Peak Limit (dBuV/m)	PK Margin (dB)	Azimuth (Degs)	Height (cm)	Polarity
* 1.074	38.94	PK2	27.3	-23.9	0	42.34	-	-	74	-31.66	334	168	H
* 1.074	29.56	MAv1	27.3	-23.9	.4	33.36	54	-20.64	-	-	334	168	H
* 1.074	39.21	PK2	27.3	-23.9	0	42.61	-	-	74	-31.39	147	247	V
* 1.076	30.37	MAv1	27.3	-23.9	.4	34.17	54	-19.83	-	-	147	247	V
* 4.842	33.47	PK2	34.2	-28.2	0	39.47	-	-	74	-34.53	305	140	H
* 4.841	24.55	MAv1	34.2	-28.2	.4	30.95	54	-23.05	-	-	305	140	H
* 9.436	28.93	PK2	36.5	-20.8	0	44.63	-	-	74	-29.37	76	244	H
* 9.433	19.51	MAv1	36.5	-20.9	.4	35.51	54	-18.49	-	-	76	244	H
9.748	31.47	PK2	36.9	-20.5	0	47.87	-	-	-	-	143	102	V
13.504	32.14	PK2	39.4	-21.2	0	50.34	-	-	-	-	51	109	V

* - indicates frequency in CFR47 Pt 15 / IC RSS-Restricted Band

PK2 - KDB558074 Method: Maximum Peak

MAv1 - KDB558074 Option 1 Maximum RMS Average

HIGH CHANNEL, CH 11 RESULTS

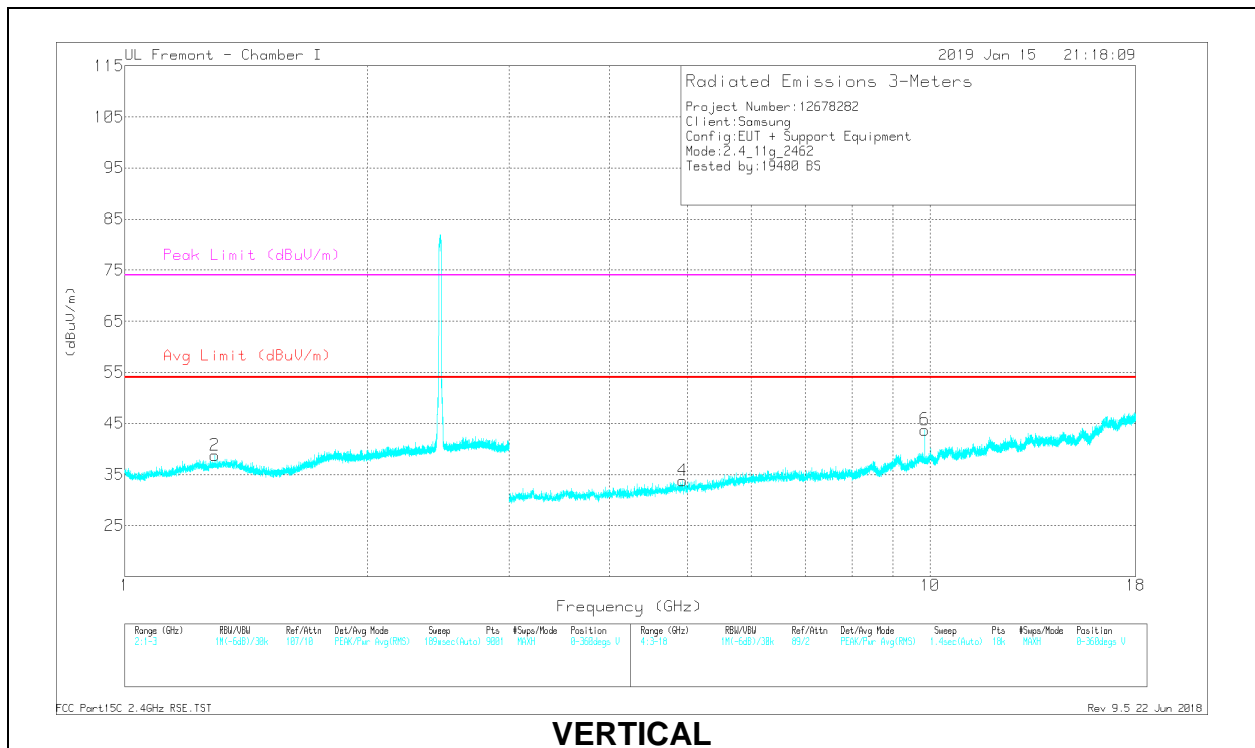
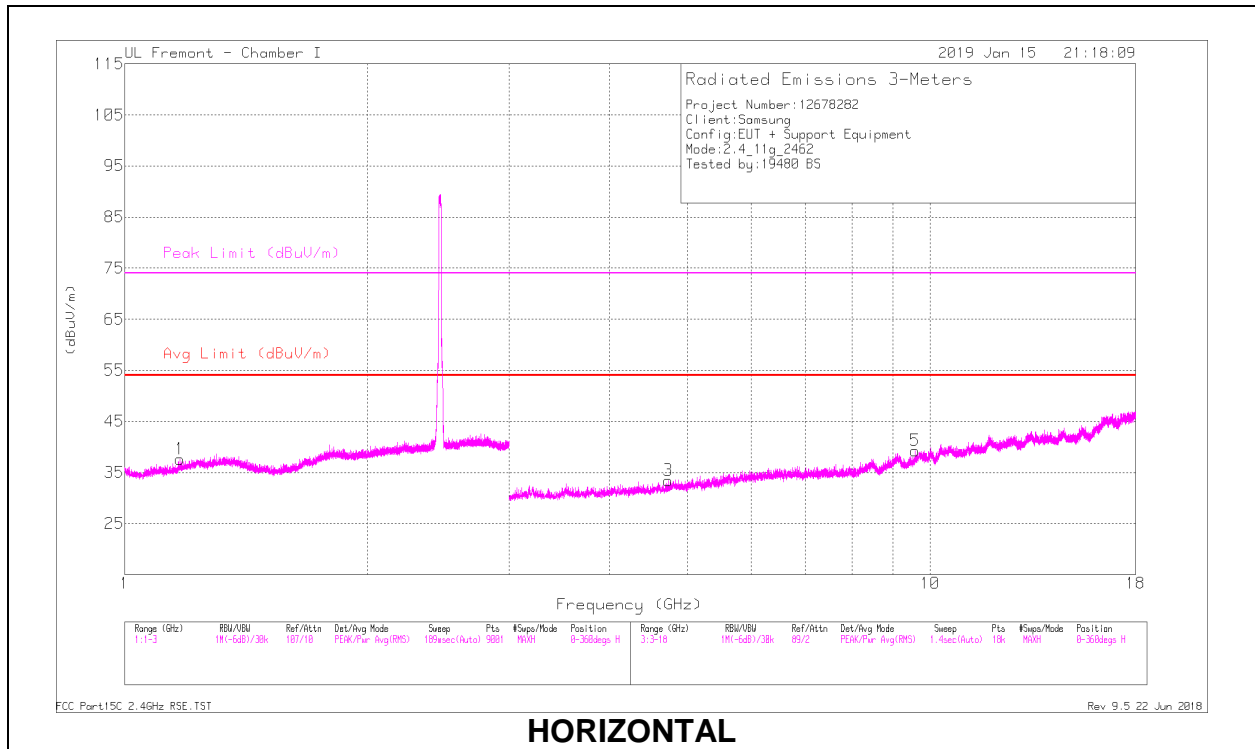

RADIATED EMISSIONS

Frequency (GHz)	Meter Reading (dBuV)	Det	AF T862 (dB/m)	Amp/Cbl/Fitr /Pad (dB)	DC Corr (dB)	Corrected Reading (dBuV/m)	Avg Limit (dBuV/m)	Margin (dB)	Peak Limit (dBuV/m)	PK Margin (dB)	Azimuth (Degs)	Height (cm)	Polarity
* 1.17	38.76	PK2	27.8	-23.2	0	43.36	-	-	74	-30.64	298	254	H
* 1.172	29.53	MAv1	27.7	-23.2	.4	34.43	54	-19.57	-	-	298	254	H
* 1.296	39.63	PK2	29.3	-22.9	0	46.03	-	-	74	-27.97	196	218	V
* 1.293	29.08	MAv1	29.3	-23	.4	35.78	54	-18.22	-	-	196	218	V
* 4.732	34.97	PK2	33.9	-28.4	0	40.47	-	-	74	-33.53	59	352	H
* 4.728	25	MAv1	33.9	-28.5	.4	30.8	54	-23.2	-	-	59	352	H
9.586	30.31	PK2	36.7	-22	0	45.01	-	-	-	-	233	336	H
* 4.925	35.78	PK2	34.2	-29	0	40.98	-	-	74	-33.02	109	257	V
* 4.927	25.16	MAv1	34.2	-29.1	.4	30.66	54	-23.34	-	-	109	257	V
9.848	33.44	PK2	36.9	-22	0	48.34	-	-	-	-	355	105	V

* - indicates frequency in CFR47 Pt 15 / IC RSS-Restricted Band

PK2 - KDB558074 Method: Maximum Peak

MAv1 - KDB558074 Option 1 Maximum RMS Average

10.1.3. TX ABOVE 1 GHz 802.11n HT20 MODE IN THE 2.4 GHz BAND

1TX Antenna 1 MODE

BANDEDGE (LOW CHANNEL, CH 1)

HORIZONTAL RESULT

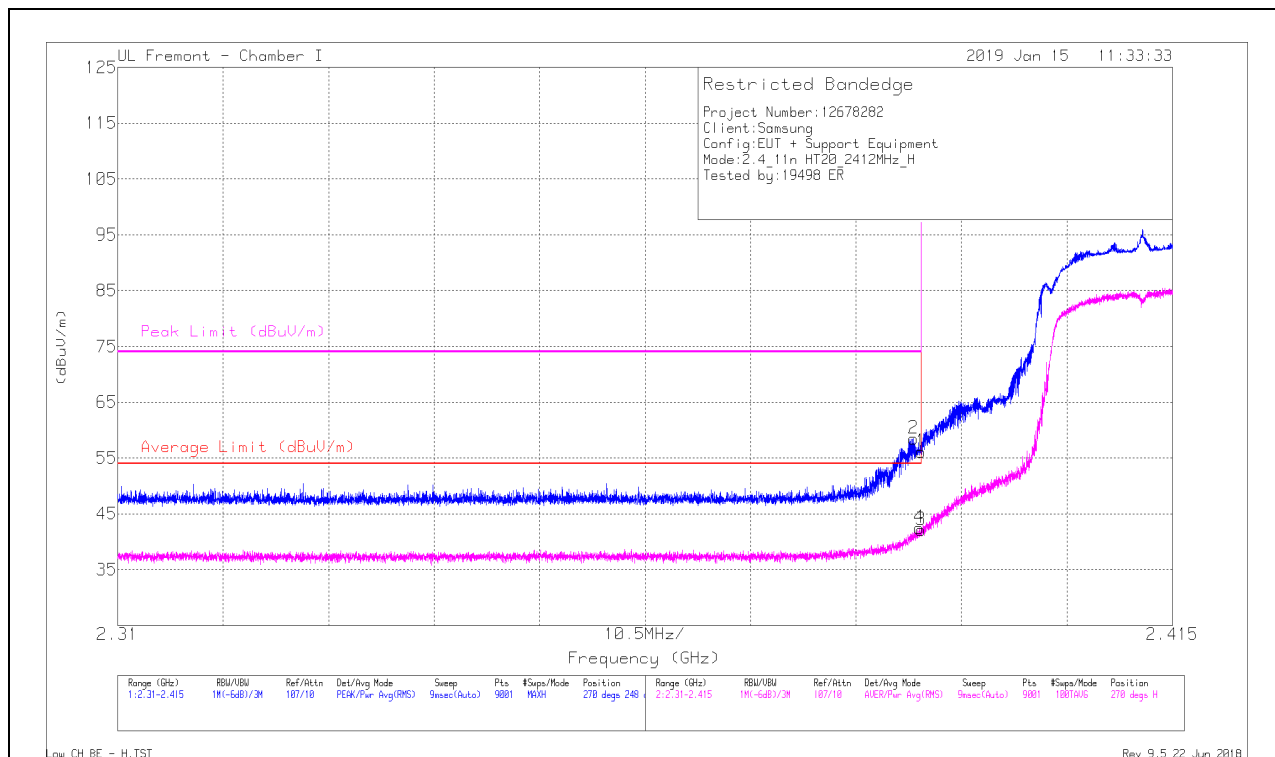

Marker	Frequency (GHz)	Meter Reading (dBuV)	Det	AF T652 (dBm)	Amp/Chl/Filt/Pad (dB)	DC Corr (dB)	Corrected Reading (dBuV/m)	Average Limit (dBuV/m)	Margin (dB)	Peak Limit (dBuV/m)	PK Margin (dB)	Azimuth (Degs)	Height (cm)	Polarity
1	* 2.39	45.96	Pk	31.8	-21.6	0	56.16	-	-	74	-17.84	270	248	H
2	* 2.389	48.25	Pk	31.8	-21.6	0	58.45	-	-	74	-15.55	270	248	H
3	* 2.39	31.67	RMS	31.8	-21.6	.24	42.11	54	-11.89	-	-	270	248	H
4	* 2.39	32.04	RMS	31.8	-21.6	.24	42.48	54	-11.52	-	-	270	248	H

* - indicates frequency in CFR47 Pt 15 / IC RSS-Restricted Band

Pk - Peak detector

RMS - RMS detection

VERTICAL RESULT

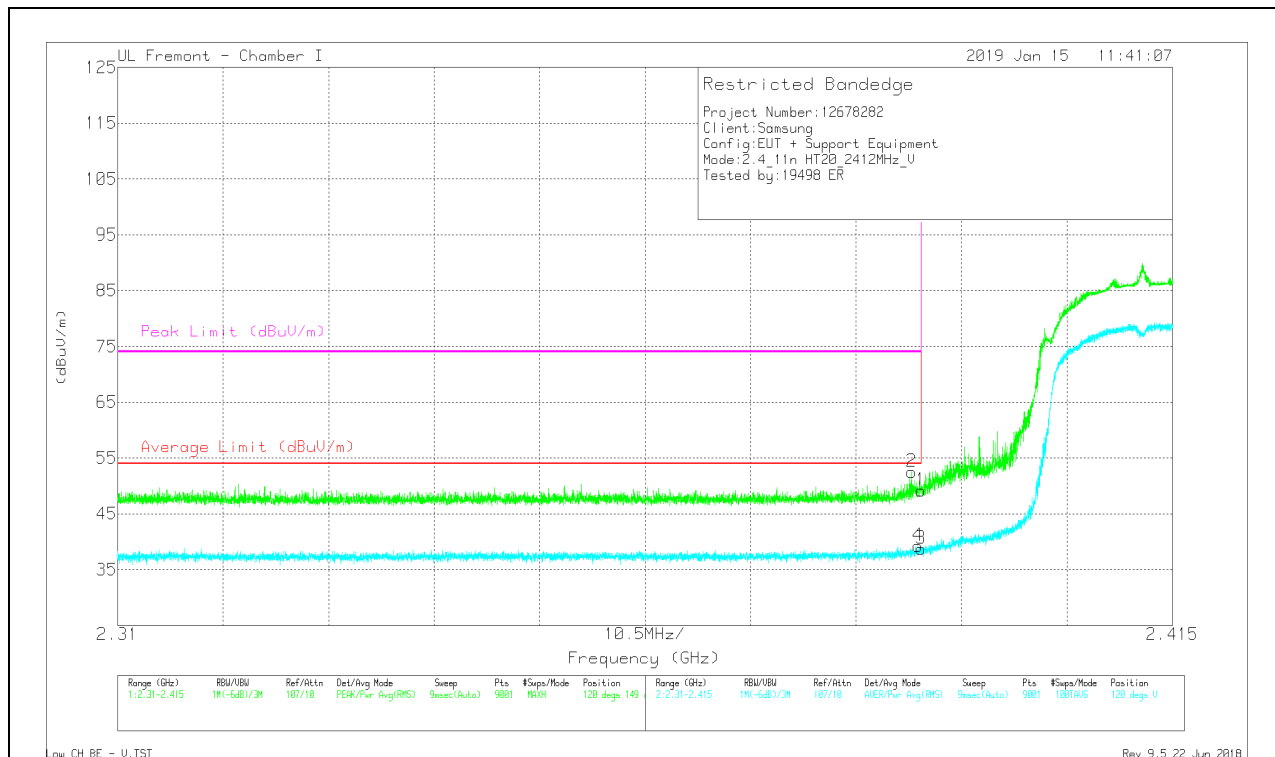

Marker	Frequency (GHz)	Meter Reading (dBuV)	Det	AF T862 (dB/m)	Amp/Cb/Fltr/Pad (dB)	DC Corr (dB)	Corrected Reading (dBuV/m)	Average Limit (dBuV/m)	Margin (dB)	Peak Limit (dBuV/m)	PK Margin (dB)	Azimuth (Degs)	Height (cm)	Polarity
1	* 2.39	38.94	Pk	31.8	-21.6	0	49.14	-	-	74	-24.86	120	149	V
2	* 2.389	42.29	Pk	31.8	-21.6	0	52.49	-	-	74	-21.51	120	149	V
3	* 2.39	28.25	RMS	31.8	-21.6	.24	38.69	54	-15.31	-	-	120	149	V
4	* 2.39	28.77	RMS	31.8	-21.6	.24	39.21	54	-14.79	-	-	120	149	V

* - indicates frequency in CFR47 Pt 15 / IC RSS-Restricted Band

Pk - Peak detector

RMS - RMS detection

BANDEDGE (HIGH CHANNEL, CH 11)

HORIZONTAL RESULT

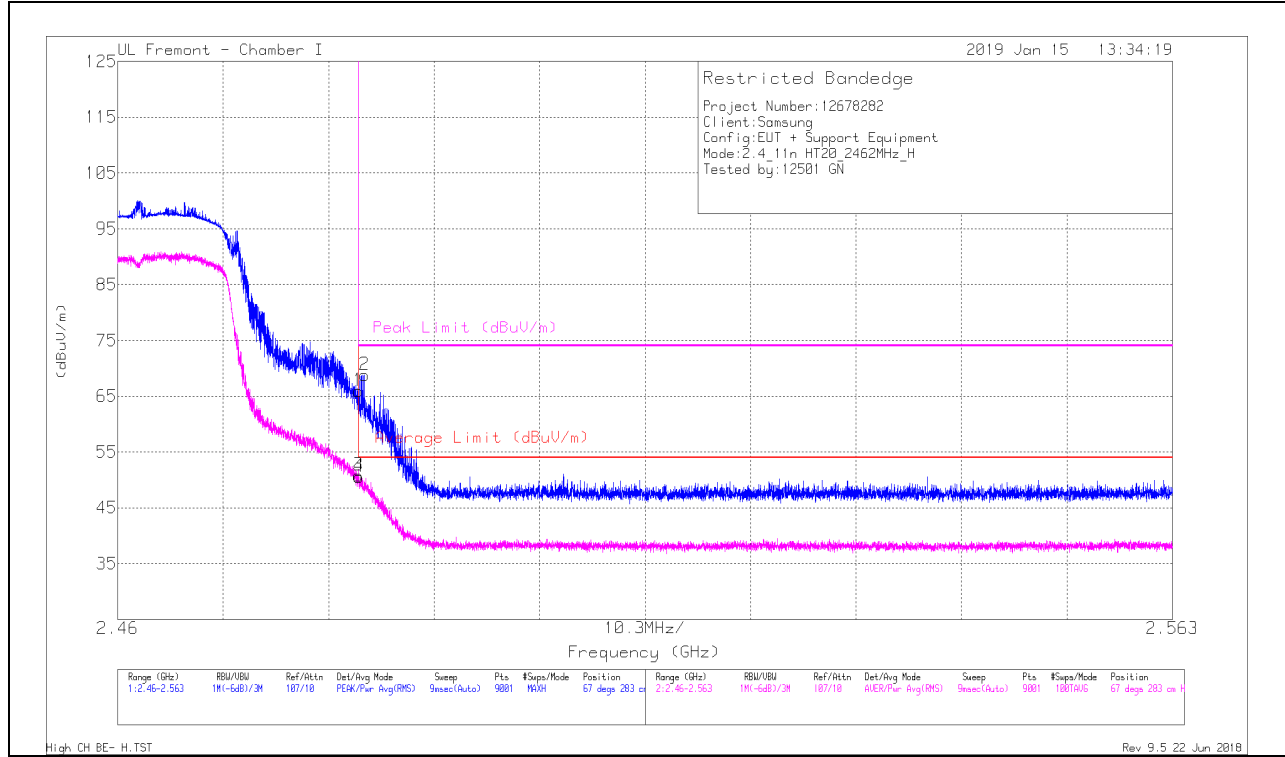

Marker	Frequency (GHz)	Meter Reading (dBuV)	Det	AF T862 (dB/m)	Amp/Cbl/Fitr/Pad (dB)	DC Corr (dB)	Corrected Reading (dBuV/m)	Average Limit (dBuV/m)	Margin (dB)	Peak Limit (dBuV/m)	PK Margin (dB)	Azimuth (Degs)	Height (cm)	Polarity
1	* 2.484	55.28	Pk	32.4	-21.7	0	65.98	-	-	74	-8.02	67	283	H
2	* 2.484	58.1	Pk	32.4	-21.7	0	68.8	-	-	74	-5.2	67	283	H
3	* 2.484	39.85	RMS	32.4	-21.7	.24	50.79	54	-3.21	-	-	67	283	H
4	* 2.484	39.56	RMS	32.4	-21.7	.24	50.5	54	-3.5	-	-	67	283	H

* - indicates frequency in CFR47 Pt 15 / IC RSS-Restricted Band
 Pk - Peak detector
 RMS - RMS detection

VERTICAL RESULT

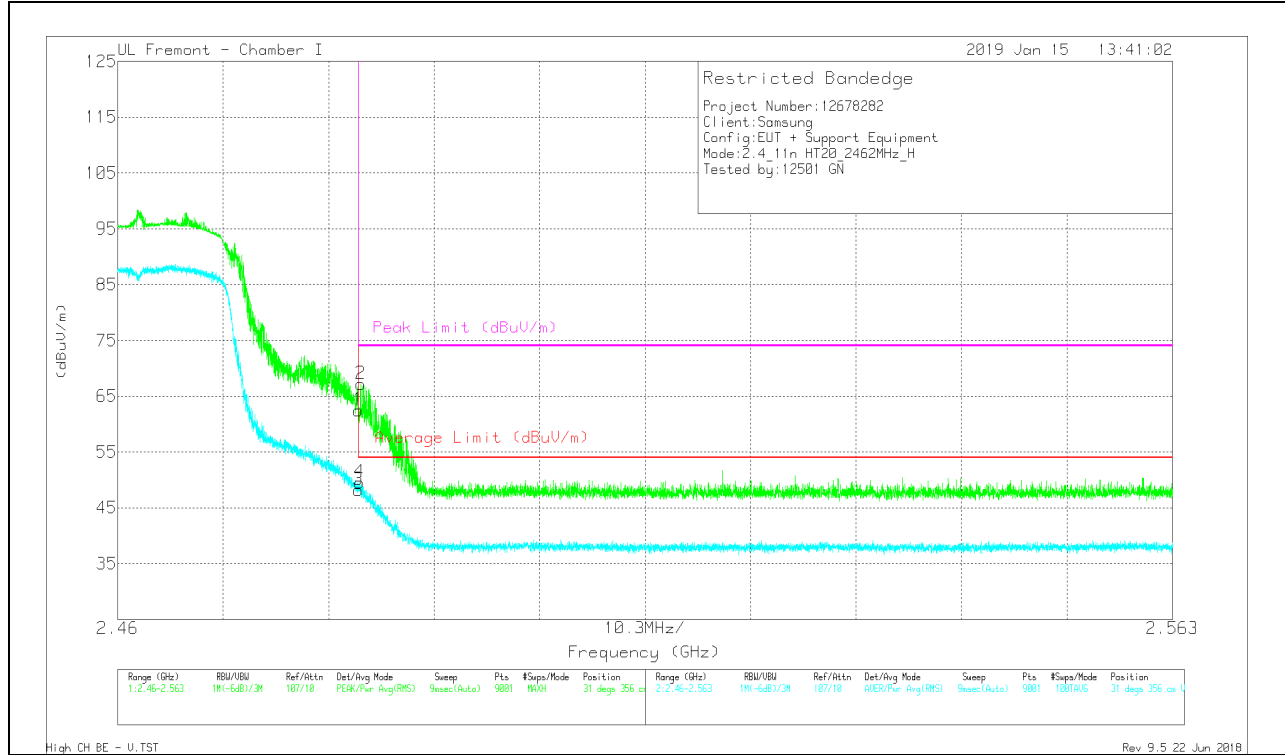

Marker	Frequency (GHz)	Meter Reading (dBuV)	Det	AF T862 (dB/m)	Amp/Cb/Ftr/Pad (dB)	DC Corr (dB)	Corrected Reading (dBuV/m)	Average Limit (dBuV/m)	Margin (dB)	Peak Limit (dBuV/m)	PK Margin (dB)	Azimuth (Degs)	Height (cm)	Polarity
1	* 2.484	51.75	Pk	32.4	-21.7	0	62.45	-	-	74	-11.55	31	356	V
2	* 2.484	56.45	Pk	32.4	-21.7	0	67.15	-	-	74	-6.85	31	356	V
3	* 2.484	37.46	RMS	32.4	-21.7	.24	48.4	54	-5.6	-	-	31	356	V
4	* 2.484	38.9	RMS	32.4	-21.7	.24	49.84	54	-4.16	-	-	31	356	V

* - indicates frequency in CFR47 Pt 15 / IC RSS-Restricted Band
 Pk - Peak detector
 RMS - RMS detection

BANEDGE (HIGH CHANNEL, CH 12)

HORIZONTAL RESULT

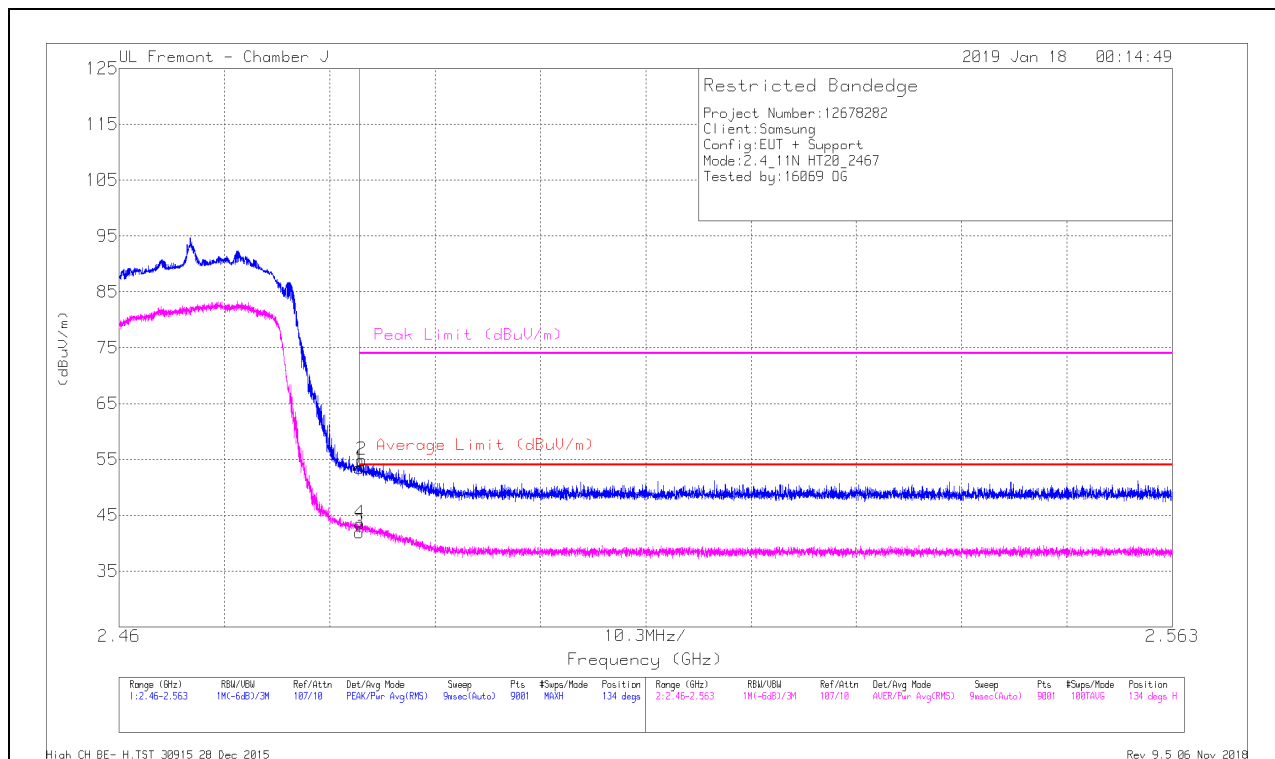

Marker	Frequency (GHz)	Meter Reading (dBuV)	Det	AF AT0067 (dB/m)	Amp/Cb/Ftr/Pad (dB)	DC Corr (dB)	Corrected Reading (dBuV/m)	Average Limit (dBuV/m)	Margin (dB)	Peak Limit (dBuV/m)	PK Margin (dB)	Azimuth (Degs)	Height (cm)	Polarity
1	* 2.484	46.78	Pk	32.5	-25.8	0	53.48	-	-	74	-20.52	134	236	H
2	* 2.484	48.21	Pk	32.5	-25.8	0	54.91	-	-	74	-19.09	134	236	H
3	* 2.484	34.98	RMS	32.5	-25.8	.24	41.92	54	-12.08	-	-	134	236	H
4	* 2.484	36.6	RMS	32.5	-25.8	.24	43.54	54	-10.46	-	-	134	236	H

* - indicates frequency in CFR47 Pt 15 / IC RSS-Restricted Band

Pk - Peak detector

RMS - RMS detection

VERTICAL RESULT

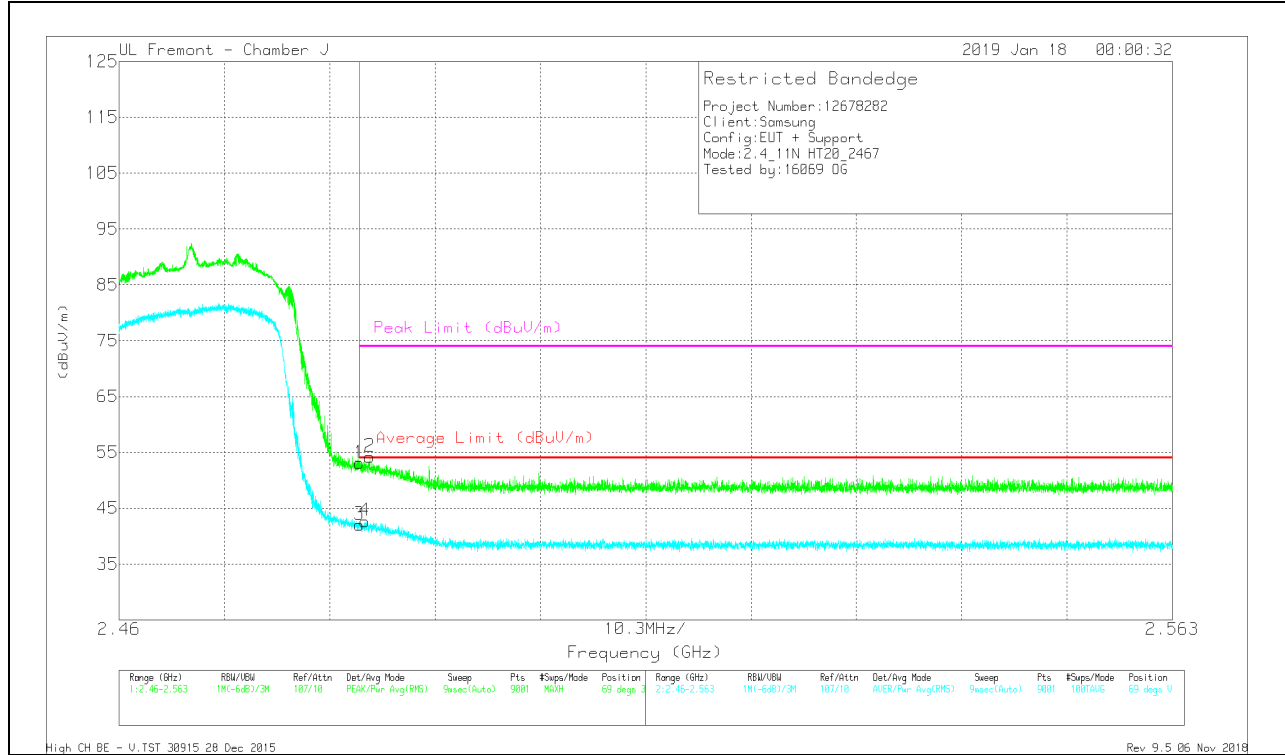

Marker	Frequency (GHz)	Meter Reading (dBuV)	Det	AF AT0067 (dBm)	Amp/Cbl/Filtr/Pad (dB)	DC Corr (dB)	Corrected Reading (dBuV/m)	Average Limit (dBuV/m)	Margin (dB)	Peak Limit (dBuV/m)	PK Margin (dB)	Azimuth (Degs)	Height (cm)	Polarity
1	* 2.484	46.42	Pk	32.5	-25.8	0	53.12	-	-	74	-20.88	69	369	V
2	* 2.485	47.53	Pk	32.5	-25.8	0	54.23	-	-	74	-19.77	69	369	V
3	* 2.484	34.97	RMS	32.5	-25.8	.24	41.91	54	-12.09	-	-	69	369	V
4	* 2.484	35.6	RMS	32.5	-25.8	.24	42.54	54	-11.46	-	-	69	369	V

* - indicates frequency in CFR47 Pt 15 / IC RSS-Restricted Band

Pk - Peak detector

RMS - RMS detection

BANDEDGE (HIGH CHANNEL, CH 13)

HORIZONTAL RESULT

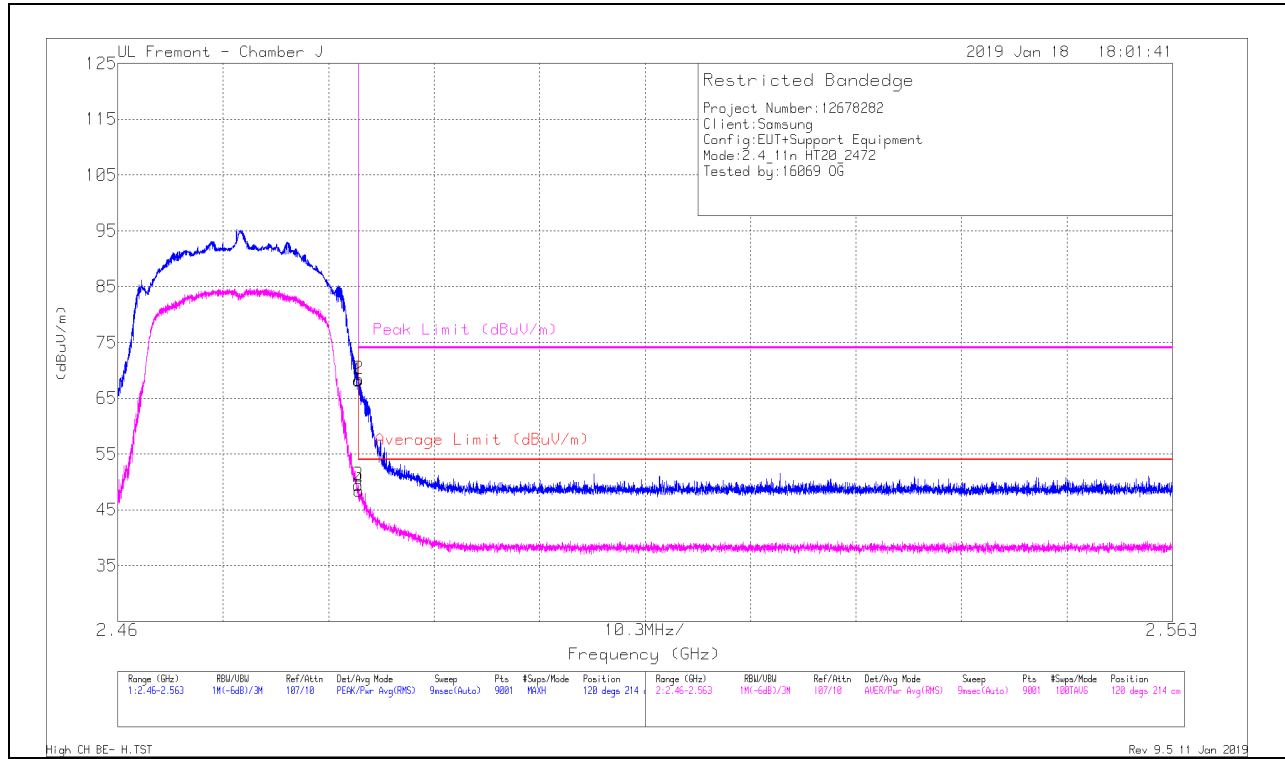

Marker	Frequency (GHz)	Meter Reading (dBuV)	Det	AF AT0067 (dBm)	Amp/Cbl/Filt/Pad (dB)	DC Corr (dB)	Corrected Reading (dBuV/m)	Average Limit (dBuV/m)	Margin (dB)	Peak Limit (dBuV/m)	PK Margin (dB)	Azimuth (Degs)	Height (cm)	Polarity
1	* 2.484	61.51	Pk	32.5	-25.8	0	68.21	-	-	74	-5.79	120	214	H
2	* 2.484	61.66	Pk	32.5	-25.8	0	68.36	-	-	74	-5.64	120	214	H
3	* 2.484	42.48	RMS	32.5	-25.8	.24	49.42	54	-4.58	-	-	120	214	H
4	* 2.484	41.46	RMS	32.5	-25.8	.24	48.4	54	-5.6	-	-	120	214	H

* - indicates frequency in CFR47 Pt 15 / IC RSS-Restricted Band
 Pk - Peak detector
 RMS - RMS detection

VERTICAL RESULT

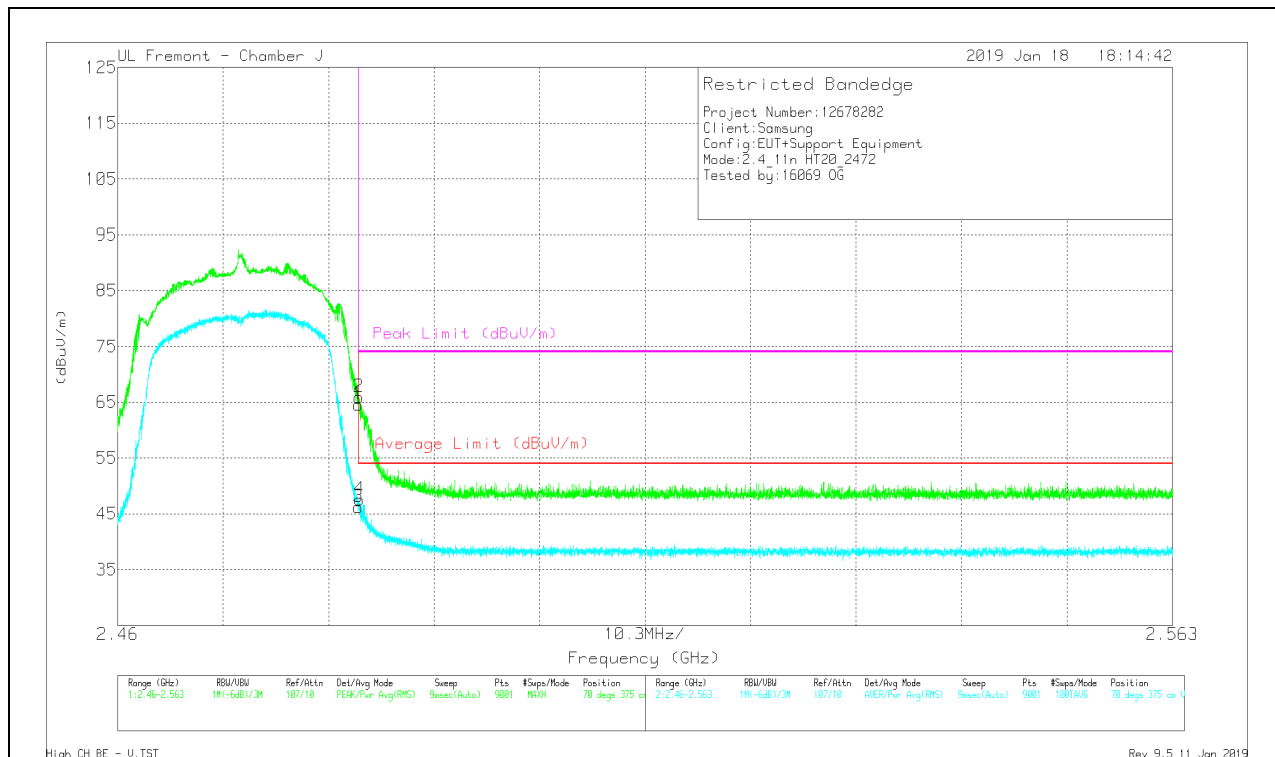

Marker	Frequency (GHz)	Meter Reading (dBuV)	Det	AF AT0067 (dBm)	Amp/Cb/Filt/Pad (dB)	DC Corr (dB)	Corrected Reading (dBuV/m)	Average Limit (dBuV/m)	Margin (dB)	Peak Limit (dBuV/m)	PK Margin (dB)	Azimuth (Degs)	Height (cm)	Polarity
1	* 2.484	57.89	Pk	32.5	-25.8	0	64.59	-	-	74	-9.41	70	375	V
2	* 2.484	59.24	Pk	32.5	-25.8	0	65.94	-	-	74	-8.06	70	375	V
3	* 2.484	39.21	RMS	32.5	-25.8	.24	46.15	54	-7.85	-	-	70	375	V
4	* 2.484	40.6	RMS	32.5	-25.8	.24	47.54	54	-6.46	-	-	70	375	V

* - indicates frequency in CFR47 Pt 15 / IC RSS-Restricted Band

Pk - Peak detector
 RMS - RMS detection

HARMONICS AND SPURIOUS EMISSIONS

LOW CHANNEL, CH 1 RESULTS

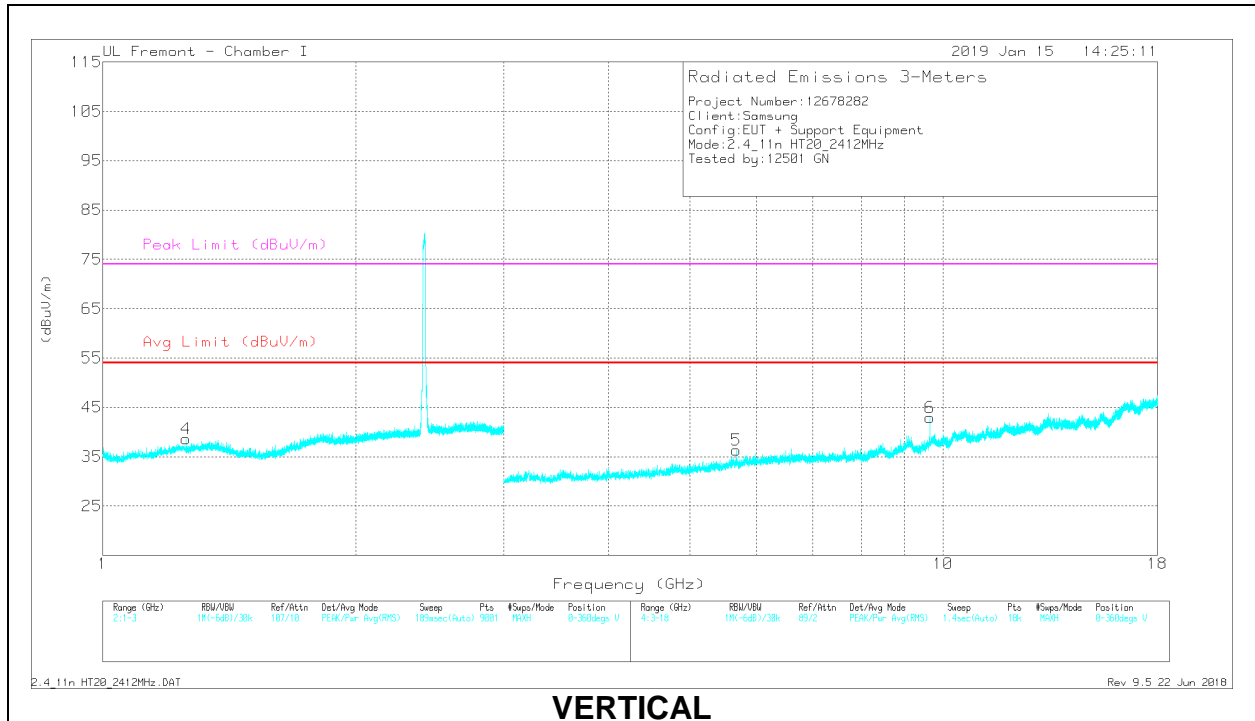
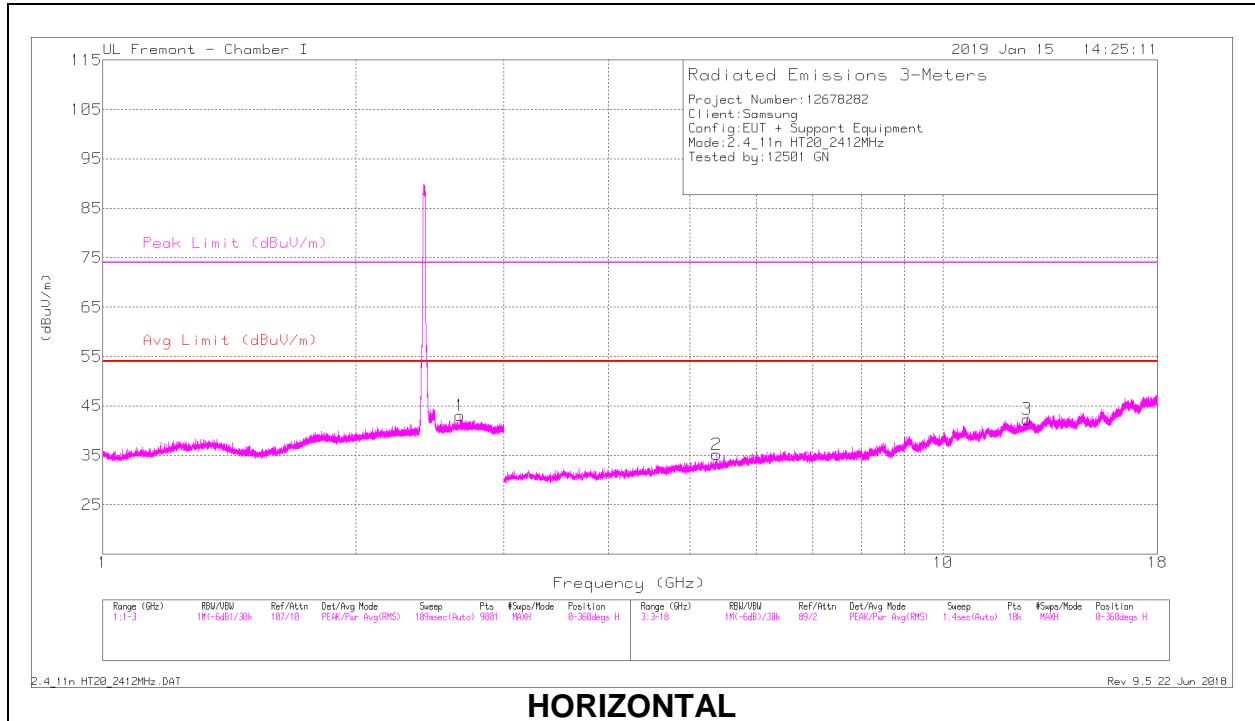

RADIATED EMISSIONS

Frequency (GHz)	Meter Reading (dBuV)	Det	AF T862 (dB/m)	Amp/Cbl/Filtr/ Pad (dB)	DC Corr (dB)	Corrected Reading (dBuV/m)	Avg Limit (dBuV/m)	Margin (dB)	Peak Limit (dBuV/m)	PK Margin (dB)	Azimuth (Degs)	Height (cm)	Polarity
* 2.659	36.85	PK2	32.5	-21.3	0	48.05	-	-	74	-25.95	210	129	H
* 2.659	27.91	MAv1	32.5	-21.3	.24	39.35	54	-14.65	-	-	210	129	H
* 1.255	38.82	PK2	28.9	-22.9	0	44.82	-	-	74	-29.18	358	170	V
* 1.256	28.71	MAv1	28.9	-22.9	.24	34.95	54	-19.05	-	-	358	170	V
* 5.376	32.81	PK2	34.4	-26.7	0	40.51	-	-	74	-33.49	234	161	H
* 5.378	23.82	MAv1	34.5	-26.7	.24	31.86	54	-22.14	-	-	234	161	H
* 12.594	31.12	PK2	39.1	-21.2	0	49.02	-	-	74	-24.98	260	155	H
* 12.595	21.56	MAv1	39.1	-21.2	.24	39.7	54	-14.3	-	-	260	155	H
5.68	33.49	PK2	35	-27.1	0	41.39	-	-	-	-	216	198	V
5.678	24	MAv1	35	-27.1	.24	32.14	-	-	-	-	216	198	V
9.648	32.45	PK2	36.8	-21.5	0	47.75	-	-	-	-	140	108	V
9.648	26.01	MAv1	36.8	-21.5	.24	41.55	-	-	-	-	140	108	V

* - indicates frequency in CFR47 Pt 15 / IC RSS-Restricted Band

PK2 - KDB558074 Method: Maximum Peak

MAv1 - KDB558074 Option 1 Maximum RMS Average

MID CHANNEL, CH 6 RESULTS

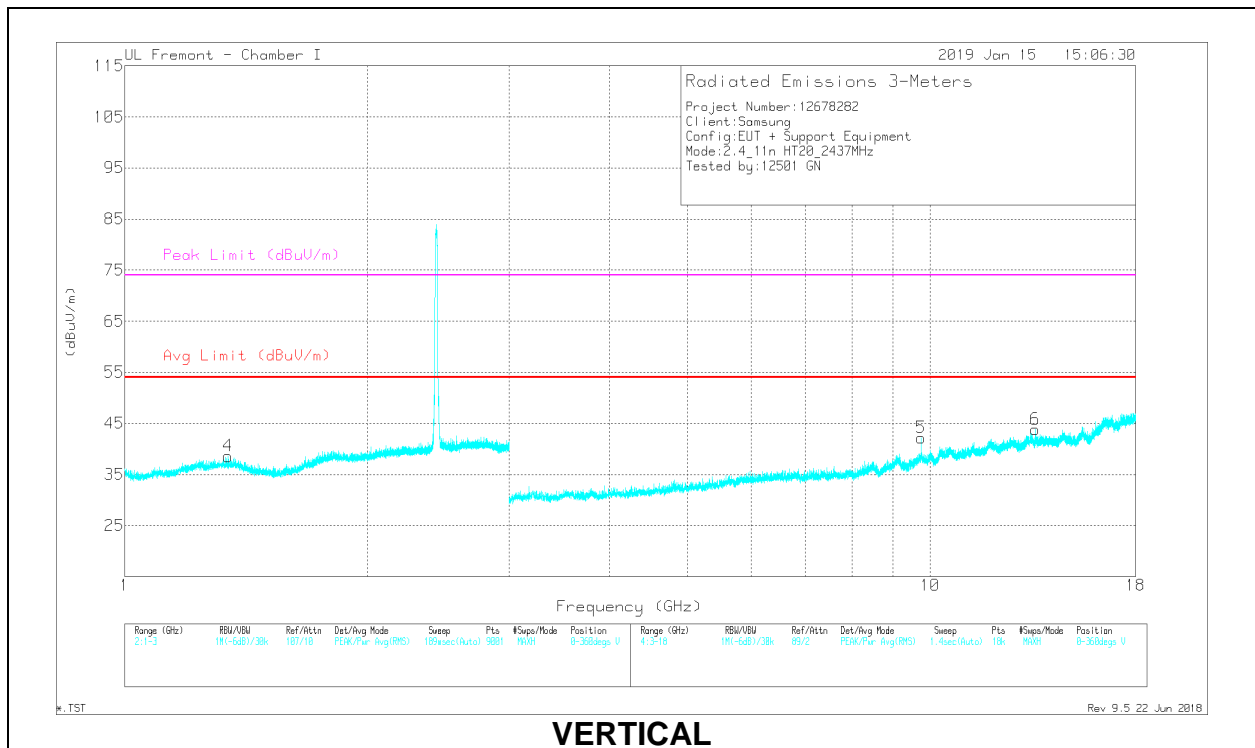
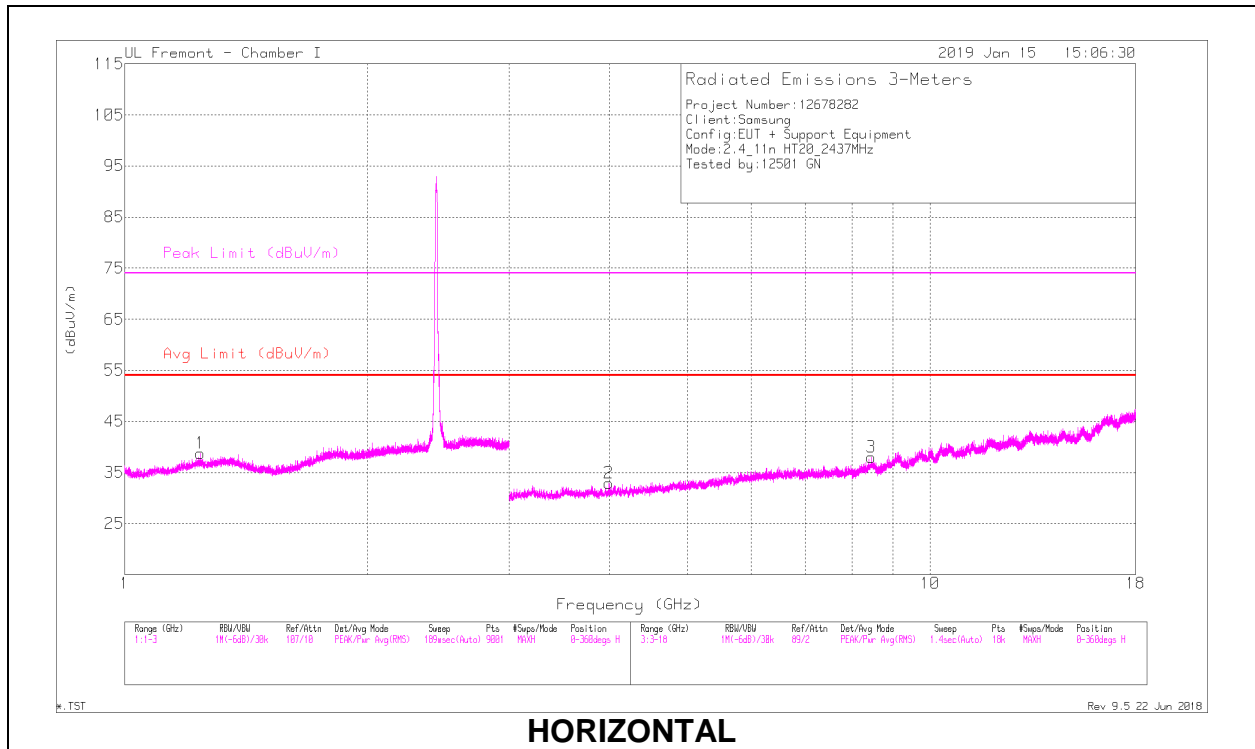

RADIATED EMISSIONS

Frequency (GHz)	Meter Reading (dBuV)	Det	AF T862 (dB/m)	Amp/Cbl/Fitr /Pad (dB)	DC Corr (dB)	Corrected Reading (dBuV/m)	Avg Limit (dBuV/m)	Margin (dB)	Peak Limit (dBuV/m)	PK Margin (dB)	Azimuth (Degs)	Height (cm)	Polarity
* 1.244	39.01	PK2	28.9	-22.9	0	45.01	-	-	74	-28.99	319	232	H
* 1.24	28.85	MAv1	28.9	-22.9	.24	35.09	54	-18.91	-	-	319	232	H
* 1.343	38.4	PK2	29.3	-23.1	0	44.6	-	-	74	-29.4	173	201	V
* 1.345	28.93	MAv1	29.3	-23.1	.24	35.37	54	-18.63	-	-	173	201	V
* 3.995	36.01	PK2	33.4	-29.6	0	39.81	-	-	74	-34.19	209	104	H
* 3.994	26.54	MAv1	33.3	-29.7	.24	30.38	54	-23.62	-	-	209	104	H
* 8.458	32.55	PK2	35.8	-23.2	0	45.15	-	-	74	-28.85	334	198	H
* 8.458	22.32	MAv1	35.8	-23.2	.24	35.16	54	-18.84	-	-	334	198	H
9.748	32.41	PK2	36.9	-20.5	0	48.81	-	-	-	-	220	122	V
9.748	25.28	MAv1	36.9	-20.5	.24	41.92	-	-	-	-	220	122	V
13.51	32.56	PK2	39.4	-21.2	0	50.76	-	-	-	-	138	250	V
13.51	22.48	MAv1	39.4	-21.2	.24	40.92	-	-	-	-	138	250	V

* - indicates frequency in CFR47 Pt 15 / IC RSS-Restricted Band
 PK2 - KDB558074 Method: Maximum Peak
 MAv1 - KDB558074 Option 1 Maximum RMS Average

HIGH CHANNEL, CH 11 RESULTS

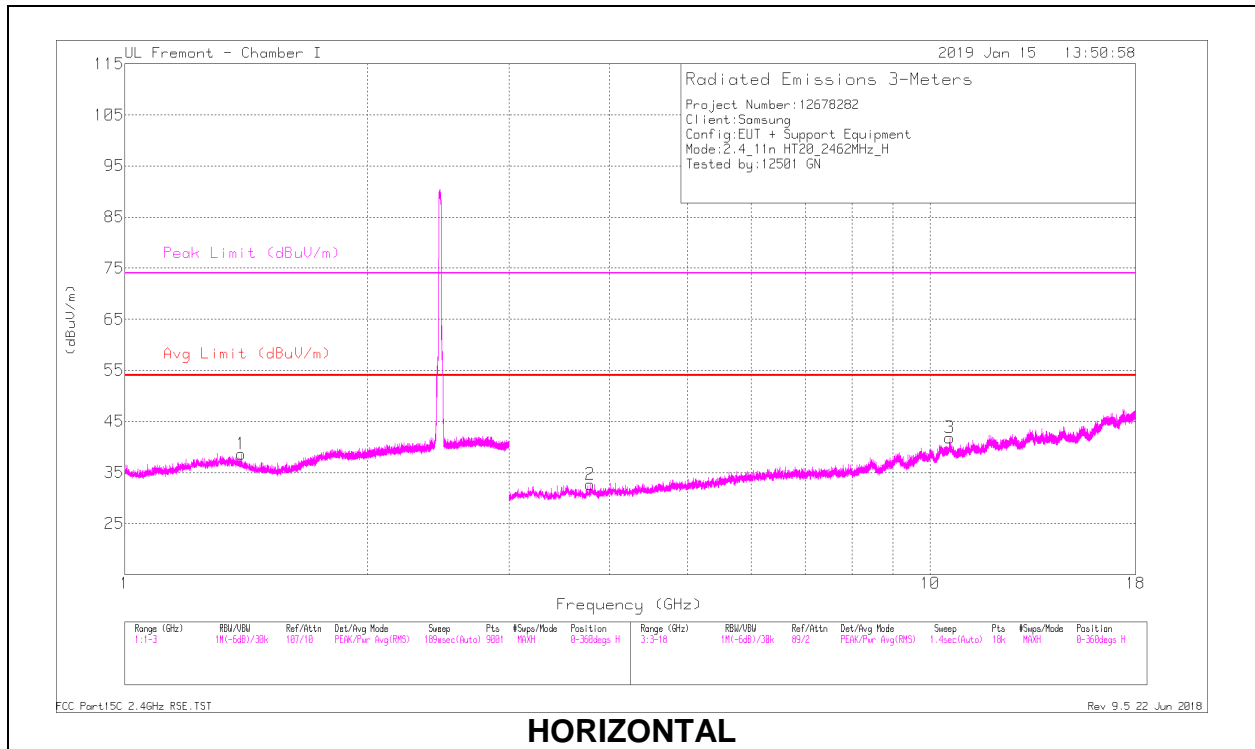

HORIZONTAL

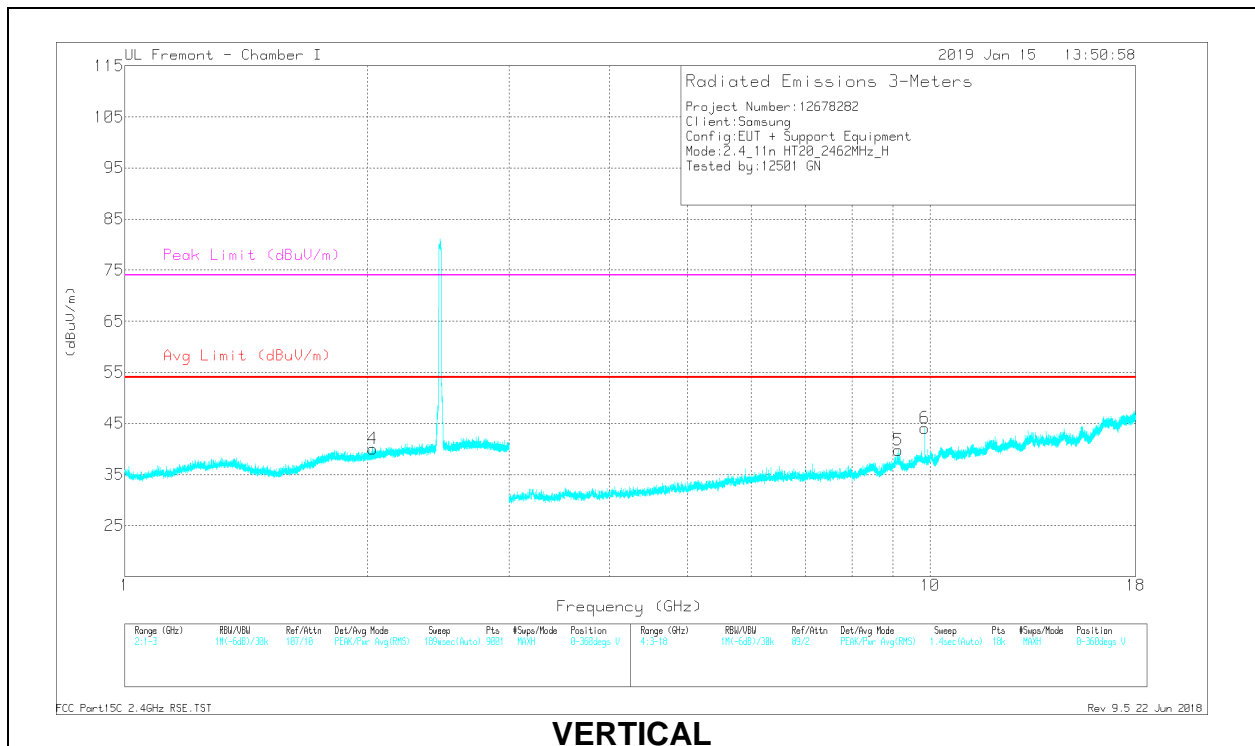

VERTICAL

RADIATED EMISSIONS

Frequency (GHz)	Meter Reading (dBuV)	Det	AF T862 (dB/m)	Amp/Cbl/Fitr/ Pad (dB)	DC Corr (dB)	Corrected Reading (dBuV/m)	Avg Limit (dBuV/m)	Margin (dB)	Peak Limit (dBuV/m)	PK Margin (dB)	Azimuth (Degs)	Height (cm)	Polarity
* 1.396	38.51	PK2	29.1	-23.3	0	44.31	-	-	74	-29.69	176	156	H
* 1.394	28.9	MAv1	29.1	-23.3	.24	34.94	54	-19.16	-	-	176	156	H
2.031	37.98	PK2	31	-22.6	0	46.38	-	-	-	-	138	179	V
2.031	28.78	MAv1	31	-22.6	.24	37.42	-	-	-	-	138	179	V
* 3.782	35.17	PK2	33.1	-29	0	39.27	-	-	74	-34.73	73	113	H
* 3.784	25.47	MAv1	33.1	-29	.24	29.81	54	-24.19	-	-	73	113	H
10.577	29.62	PK2	37.6	-20.2	0	47.02	-	-	-	-	10	182	H
10.579	20.73	MAv1	37.6	-20.2	.24	38.37	-	-	-	-	10	182	H
* 9.125	29.17	PK2	36.4	-21.4	0	44.17	-	-	74	-29.83	10	115	V
* 9.126	20.92	MAv1	36.4	-21.4	.24	36.06	54	-17.94	-	-	10	115	V
9.848	32.71	PK2	36.9	-22	0	47.61	-	-	-	-	9	123	V
9.848	26.17	MAv1	36.9	-22	.24	41.31	-	-	-	-	9	123	V

* - indicates frequency in CFR47 Pt 15 / IC RSS-Restricted Band

PK2 - KDB558074 Method: Maximum Peak

MAv1 - KDB558074 Option 1 Maximum RMS Average

10.2. Worst Case Below 30MHz

SPURIOUS EMISSIONS BELOW 30 MHz (WORST-CASE CONFIGURATION)

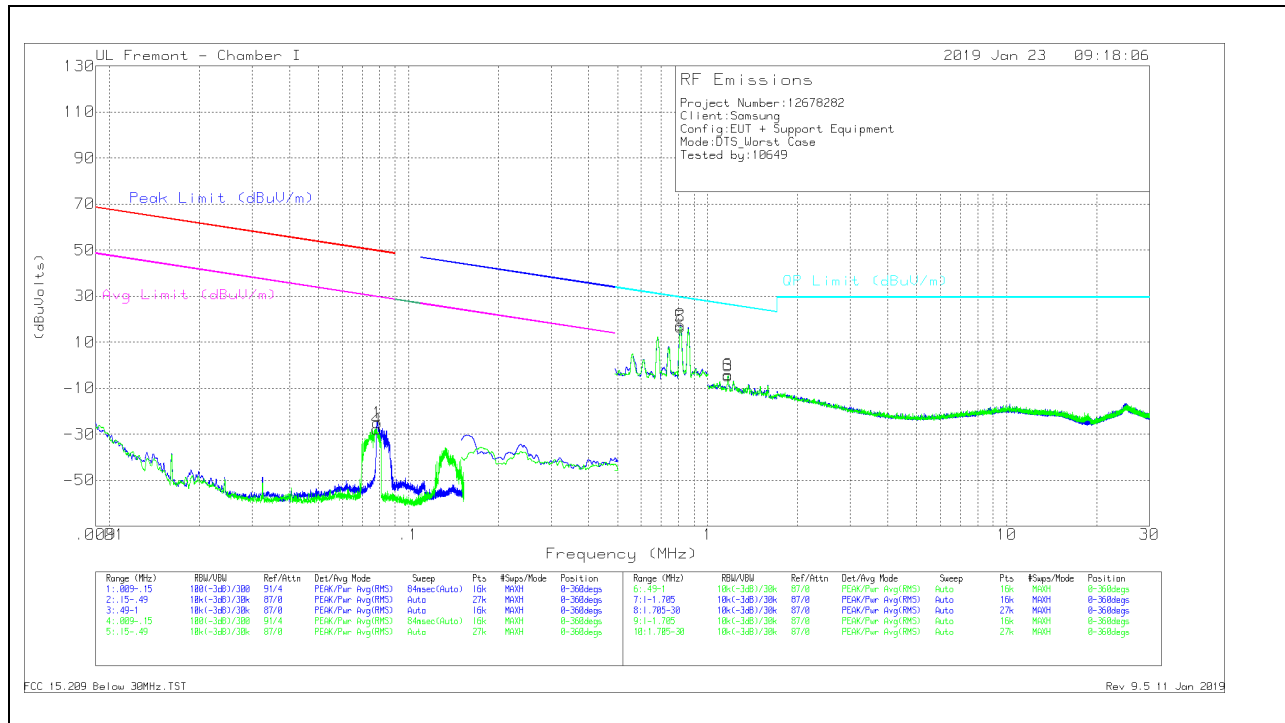

Below 30MHz Data

Marker	Frequency (MHz)	Meter Reading (dBuV)	Det	Loop Antenna (ACF)	Cables w/ PRE0 18017 5 (dB)	Dist Corr 300m	Corrected Reading (dBuVolts)	Peak Limit (dBuV /m)	Margin (dB)	Avg Limit (dBuV /m)	Margin (dB)	Azimuth (Degs)
1	.0788	31.37	Pk	55.7	-32	-80	-24.93	49.65	-74.58	29.65	-54.58	0-360
4	.07829	28.48	Pk	55.8	-32	-80	-27.72	49.71	-77.43	29.71	-57.43	0-360

Pk - Peak detector

Marker	Frequency (MHz)	Meter Reading (dBuV)	Det	Loop Antenna (ACF)	Cables w/ PRE0 18017 5 (dB)	Dist Corr 30m (dB) 40Log	Corrected Reading (dBuVolts)	QP Limit (dBuV /m)	Margin (dB)	Azimuth (Degs)
2	.81246	32.89	Pk	56.3	-31.8	-40	17.39	29.42	-12.03	0-360
5	.81181	32.16	Pk	56.3	-31.8	-40	16.66	29.43	-12.77	0-360
3	1.17087	21.76	Pk	45.5	-31.8	-40	-4.54	26.26	-30.8	0-360
6	1.16922	22.13	Pk	45.5	-31.8	-40	-4.17	26.27	-30.44	0-360

Pk - Peak detector

10.3. Worst Case Below 1 GHz

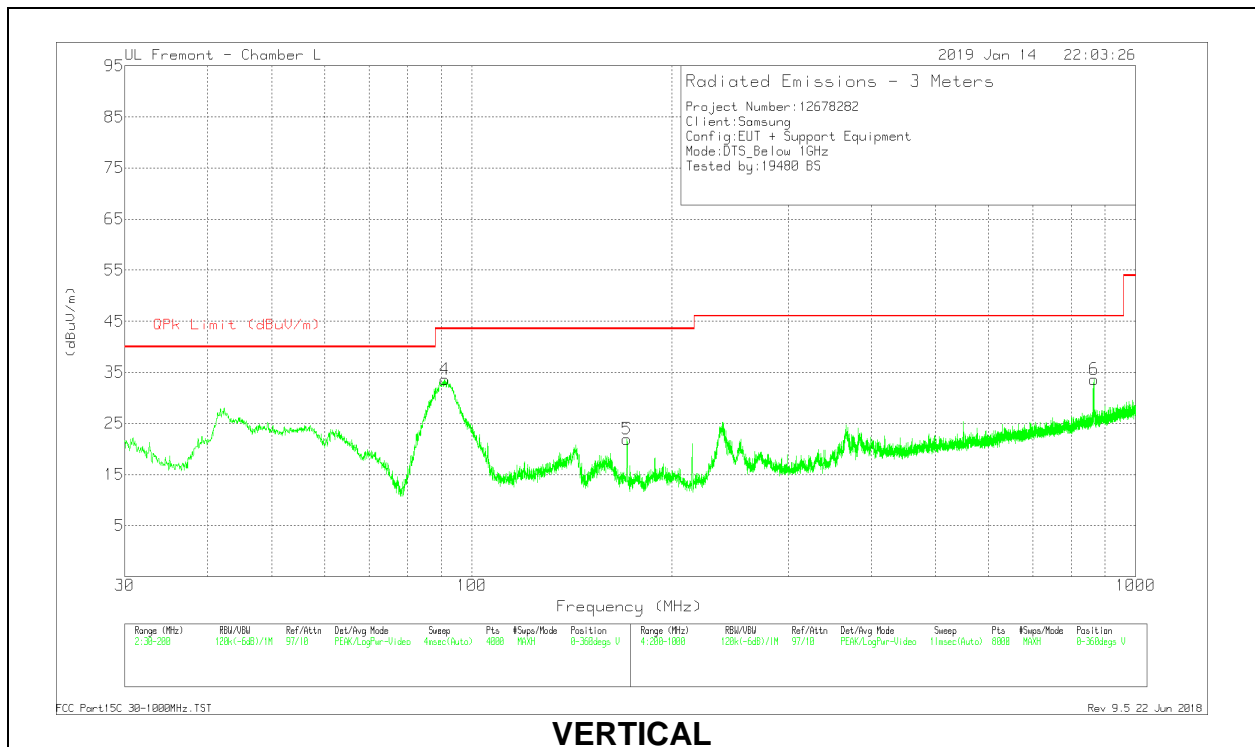
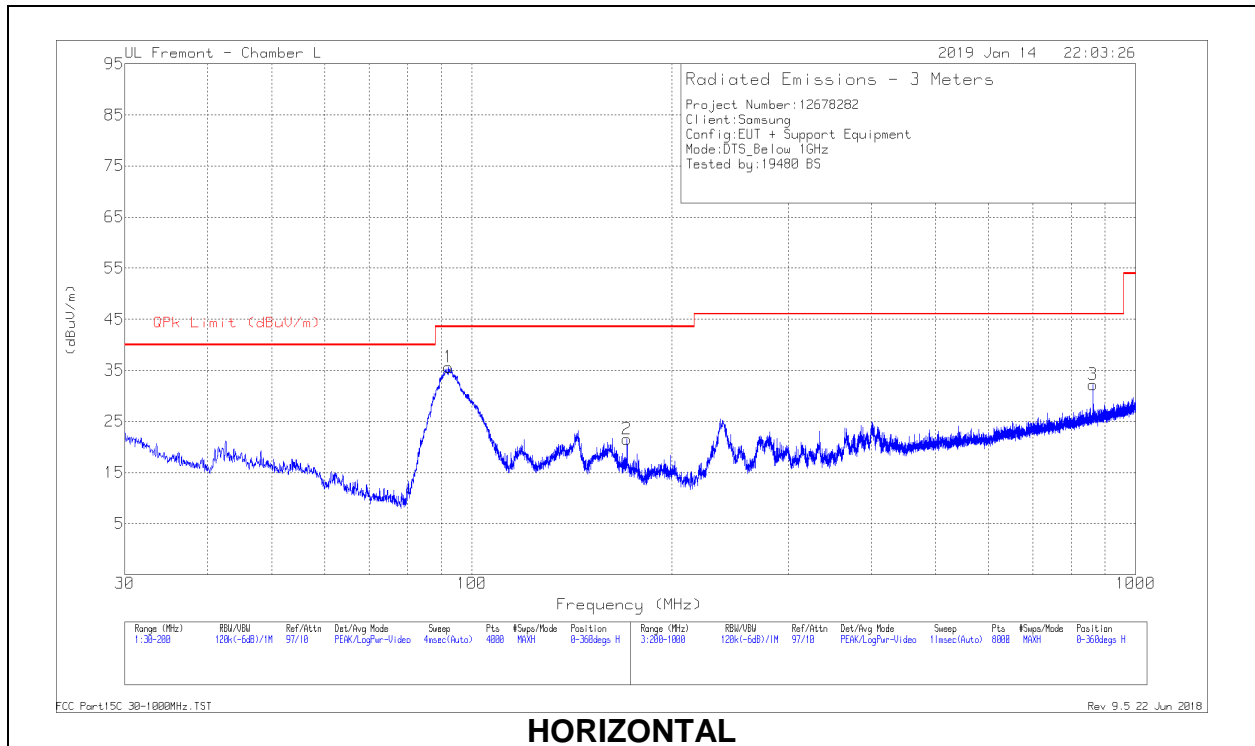

Below 1GHz DATA

Marker	Frequency (MHz)	Meter Reading (dBuV)	Det	AF PRE0184970 (dB/m)	Amp/Cbl (dB)	Corrected Reading (dBuV/m)	QPk Limit (dBuV/m)	Margin (dB)	Azimuth (Degs)	Height (cm)	Polarity
1	92.2361	52.68	Pk	14	-31	35.68	43.52	-7.84	0-360	199	H
		51.03	Qp	13.9	-31	33.93	43.52	-9.59	67	333	H
2	* 171.3066	34.5	Pk	17.5	-30.5	21.5	43.52	-22.02	0-360	199	H
4	91.0458	50.89	Pk	13.7	-31	33.59	43.52	-9.93	0-360	102	V
5	* 171.3066	34.94	Pk	17.5	-30.5	21.94	43.52	-21.58	0-360	102	V
3	862.6861	32.2	Pk	27.6	-27.6	32.2	46.02	-13.82	0-360	299	H
6	865.8866	33.54	Pk	27.7	-27.6	33.64	46.02	-12.38	0-360	102	V

* - indicates frequency in CFR47 Pt 15 / IC RSS-Restricted Band

Pk - Peak detector

Qp - Quasi-Peak detector

10.4. Worst Case 18-26 GHz

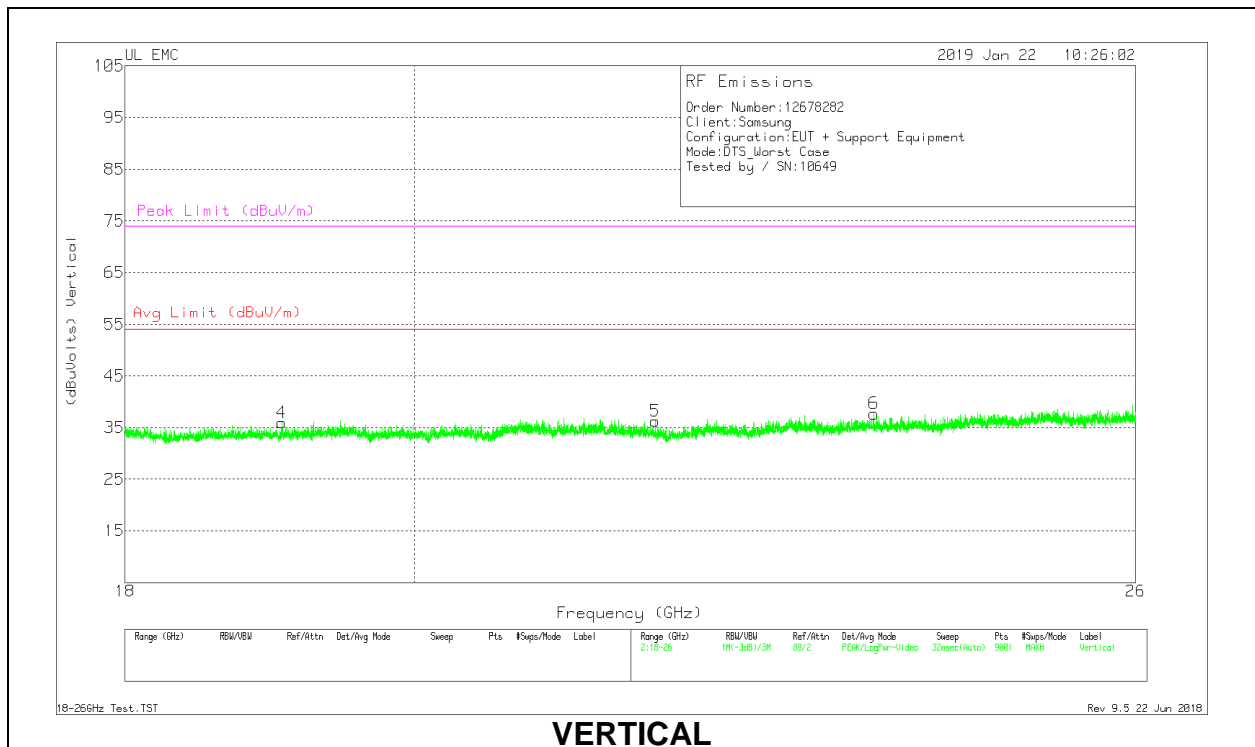
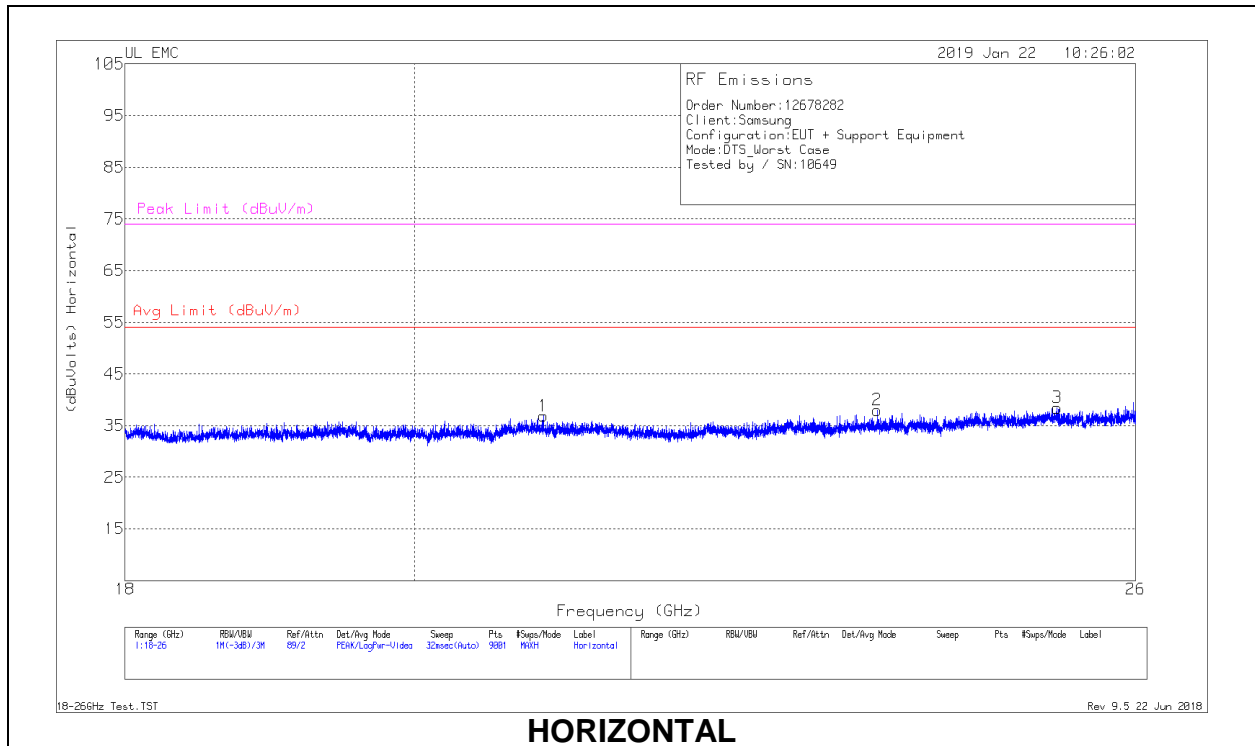

18 – 26GHz DATA

Marker	Frequency (GHz)	Meter Reading (dBuV)	Det	T448 AF (dB/m)	Amp/Cbl (dB)	Dist Corr (dB)	Corrected Reading (dBuVolts)	Avg Limit (dBuV/m)	Margin (dB)	Peak Limit (dBuV/m)	PK Margin (dB)
1	20.959	70.27	Pk	33.3	-57.2	-9.5	36.87	54	-17.13	74	-37.13
2	23.667	70.59	Pk	33.9	-57	-9.5	37.99	54	-16.01	74	-36.01
3	25.268	68.55	Pk	34.7	-55.3	-9.5	38.45	54	-15.55	74	-35.55
4	19.055	70.85	Pk	32.4	-57.8	-9.5	35.95	54	-18.05	74	-38.05
5	21.831	70.06	Pk	33.3	-57.6	-9.5	36.26	54	-17.74	74	-37.74
6	23.638	69.7	Pk	33.9	-56.4	-9.5	37.7	54	-16.3	74	-36.3

Pk - Peak detector

11. AC POWER LINE CONDUCTED EMISSIONS

LIMITS

FCC §15.207 (a)

Frequency of Emission (MHz)	Conducted Limit (dBuV)	
	Quasi-peak	Average
0.15-0.5	66 to 56	56 to 46
0.5-5	56	46
5-30	60	50

*Decreases with the logarithm of the frequency.

TEST PROCEDURE

The EUT is placed on a non-conducting table 40 cm from the vertical ground plane and 80 cm above the horizontal ground plane. The EUT is configured in accordance with ANSI C63.10.

The receiver is set to a resolution bandwidth of 9 kHz. Peak detection is used unless otherwise noted as quasi-peak or average.

Line conducted data is recorded for both NEUTRAL and HOT lines.

RESULTS

11.1.1. AC Power Line Norm

LINE 1 RESULTS

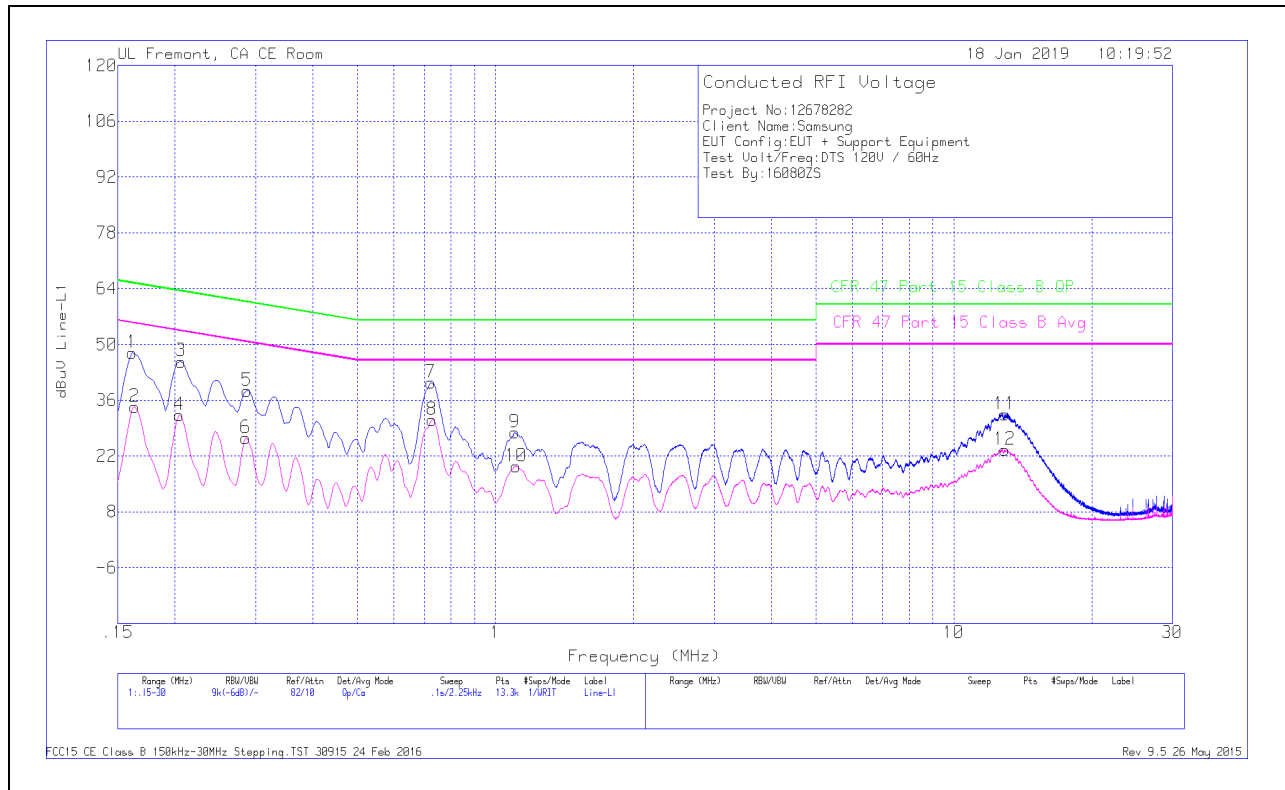

Range 1: Line-L1 .15 - 30MHz											
Marker	Frequency (MHz)	Meter Reading (dBuV)	Det	LISN L1	LC Cables C1&C3	Limiter (dB)	Corrected Reading dBuV	CFR 47 Part 15 Class B QP	QP Margin (dB)	CFR 47 Part 15 Class B Avg	Av(CISPR)Margin (dB)
1	.16125	37.67	Qp	.1	0	10.1	47.87	65.4	-17.53	-	-
2	.1635	24.09	Ca	.1	0	10.1	34.29	-	-	55.28	-20.99
3	.20625	35.64	Qp	0	0	10.1	45.74	63.35	-17.61	-	-
4	.204	22.18	Ca	0	0	10.1	32.28	-	-	53.45	-21.17
5	.28725	28.32	Qp	0	0	10.1	38.42	60.6	-22.18	-	-
6	.285	16.42	Ca	0	0	10.1	26.52	-	-	50.67	-24.15
7	.72375	30.26	Qp	0	0	10.1	40.36	56	-15.64	-	-
8	.72825	20.99	Ca	0	0	10.1	31.09	-	-	46	-14.91
9	1.10175	17.68	Qp	0	.1	10.1	27.88	56	-28.12	-	-
10	1.1085	9.23	Ca	0	.1	10.1	19.43	-	-	46	-26.57
11	12.9187	21.93	Qp	.1	.2	10.2	32.43	60	-27.57	-	-
12	12.9187	13.05	Ca	.1	.2	10.2	23.55	-	-	50	-26.45

Qp - Quasi-Peak detector
 Ca - CISPR average detection

LINE 2 RESULTS

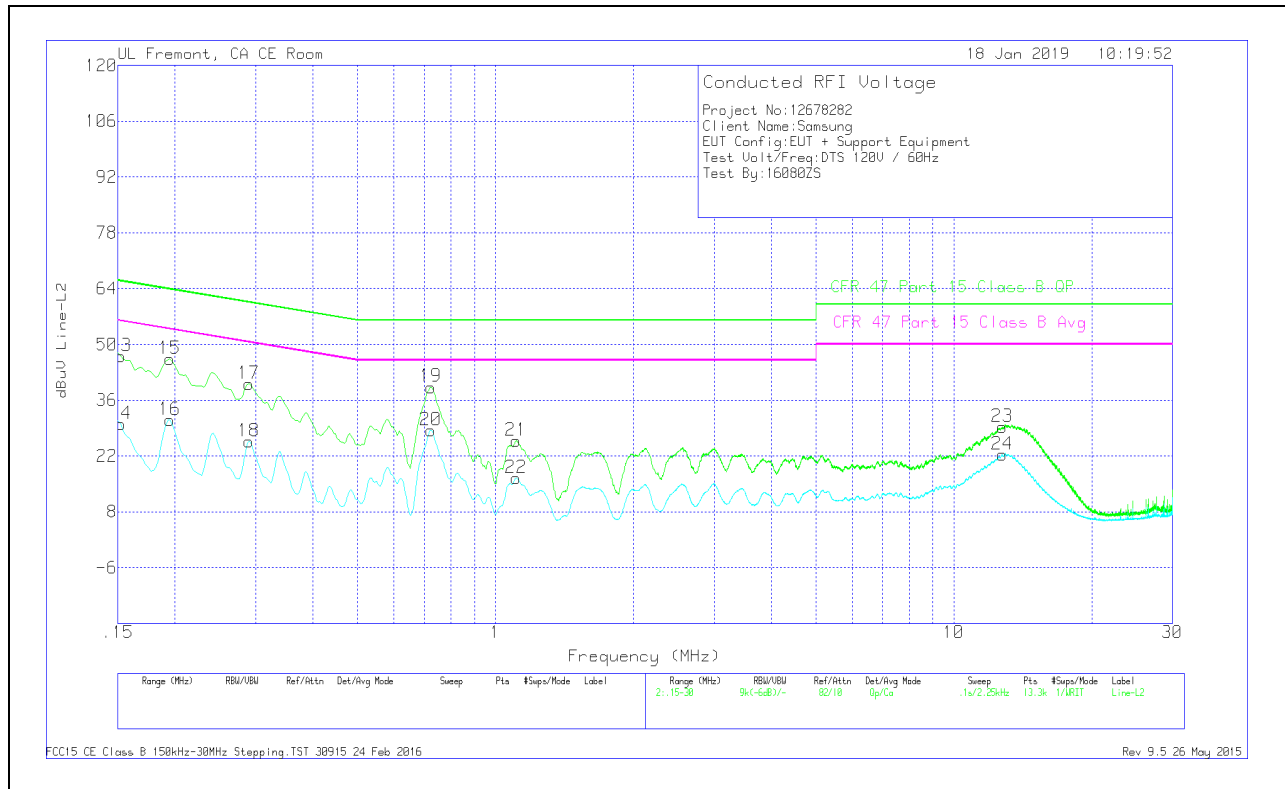

Range 2: Line-L2 .15 - 30MHz											
Marker	Frequency (MHz)	Meter Reading (dBuV)	Det	LISN L2	LC Cables C2&C3	Limiter (dB)	Corrected Reading dBuV	CFR 47 Part 15 Class B QP	QP Margin (dB)	CFR 47 Part 15 Class B Avg	Av(CISPR)Margin (dB)
13	.15225	36.81	Qp	.1	0	10.1	47.01	65.88	-18.87	-	-
14	.15225	19.75	Ca	.1	0	10.1	29.95	-	-	55.88	-25.93
15	.195	36.18	Qp	0	0	10.1	46.28	63.82	-17.54	-	-
16	.195	20.91	Ca	0	0	10.1	31.01	-	-	53.82	-22.81
17	.2895	29.99	Qp	0	0	10.1	40.09	60.54	-20.45	-	-
18	.2895	15.64	Ca	0	0	10.1	25.74	-	-	50.54	-24.8
19	.72375	29.21	Qp	0	0	10.1	39.31	56	-16.69	-	-
20	.72375	18.41	Ca	0	0	10.1	28.51	-	-	46	-17.49
21	1.11075	15.69	Qp	0	.1	10.1	25.89	56	-30.11	-	-
22	1.10963	6.27	Ca	0	.1	10.1	16.47	-	-	46	-29.53
23	12.768	18.74	Qp	.1	.2	10.2	29.24	60	-30.76	-	-
24	12.7702	11.84	Ca	.1	.2	10.2	22.34	-	-	50	-27.66

Qp - Quasi-Peak detector
 Ca - CISPR average detection