



# **CERTIFICATION TEST REPORT**

**Report Number. :** 12678287-E2V1

**Applicant :** Samsung Electronics Co., Ltd.  
129 Samsung-Ro, Yeongtong-Gu,  
Suwon-Si, Gyeonggi-Do, 16677, Korea

**Models :** SM-A305G/DS and SM-A305G

**FCC ID :** A3LSMA305G

**EUT Description :** GSM/WCDMA/LTE Phone with BT, DTS/UNII a/b/g/n/ac, and  
ANT+

**Test Standard(s) :** FCC 47 CFR PART 15 SUBPART C

**Date Of Issue:**  
February 20, 2019

**Prepared by:**  
UL Verification Services Inc.  
47173 Benicia Street  
Fremont, CA 94538 U.S.A.  
TEL: (510) 771-1000  
FAX: (510) 661-0888



NVLAP Lab code: 200065-0

---

## REPORT REVISION HISTORY

Rev.	Issue Date	Revisions	Revised By
V1	2/20/2019	Initial Issue	

---

## TABLE OF CONTENTS

<b>REPORT REVISION HISTORY .....</b>	<b>2</b>
<b>TABLE OF CONTENTS .....</b>	<b>3</b>
<b>1. ATTESTATION OF TEST RESULTS .....</b>	<b>5</b>
<b>2. INTRODUCTION OF TEST DATA REUSE.....</b>	<b>6</b>
2.1. INTRODUCTION .....	6
2.2. DIFFERENCES.....	6
2.3. SPOT CHECK VERIFICATION RESULTS SUMMARY.....	6
2.4. REFERENCE DETAIL .....	11
<b>3. TEST METHODOLOGY .....</b>	<b>12</b>
<b>4. FACILITIES AND ACCREDITATION .....</b>	<b>12</b>
<b>5. CALIBRATION AND UNCERTAINTY .....</b>	<b>13</b>
5.1. MEASURING INSTRUMENT CALIBRATION .....	13
5.2. SAMPLE CALCULATION .....	13
5.3. MEASUREMENT UNCERTAINTY.....	13
<b>6. EQUIPMENT UNDER TEST.....</b>	<b>14</b>
6.1. EUT DESCRIPTION .....	14
6.2. MAXIMUM OUTPUT POWER.....	14
6.3. DESCRIPTION OF AVAILABLE ANTENNAS .....	14
6.4. SOFTWARE AND FIRMWARE.....	14
6.5. WORST-CASE CONFIGURATION AND MODE.....	14
6.6. DESCRIPTION OF TEST SETUP.....	15
<b>7. TEST AND MEASUREMENT EQUIPMENT .....</b>	<b>18</b>
<b>8. MEASUREMENT METHODS .....</b>	<b>19</b>
<b>9. ANTENNA PORT TEST RESULTS .....</b>	<b>20</b>
9.1. ON TIME AND DUTY CYCLE.....	20
9.2. 20 dB AND 99% BANDWIDTH .....	22
9.2.1. BLUETOOTH ENHANCED DATA RATE GFSK MODULATION .....	23
9.2.2. BLUETOOTH ENHANCED DATA RATE 8PSK MODULATION.....	24
9.3. HOPPING FREQUENCY SEPARATION.....	25
9.3.1. BLUETOOTH BASIC DATA RATE GFSK MODULATION .....	26
9.3.2. BLUETOOTH ENHANCED DATA RATE 8PSK MODULATION.....	27
9.4. NUMBER OF HOPPING CHANNELS.....	28

---

9.4.1.	BLUETOOTH BASIC DATA RATE GFSK MODULATION .....	29
9.4.2.	BLUETOOTH ENHANCED DATA RATE 8PSK MODULATION .....	31
9.5.	<i>AVERAGE TIME OF OCCUPANCY</i> .....	33
9.5.1.	BLUETOOTH BASIC DATA RATE GFSK MODULATION .....	34
9.5.2.	BLUETOOTH ENHANCED DATA RATE 8PSK MODULATION .....	36
9.6.	<i>OUTPUT POWER</i> .....	38
9.6.1.	BLUETOOTH BASIC DATA RATE GFSK MODULATION .....	39
9.6.2.	BLUETOOTH ENHANCED DATA RATE DQPSK MODULATION .....	40
9.6.3.	BLUETOOTH ENHANCED DATA RATE 8PSK MODULATION .....	41
9.7.	<i>AVERAGE POWER</i> .....	42
9.7.1.	BLUETOOTH BASIC DATA RATE GFSK MODULATION .....	43
9.7.2.	BLUETOOTH ENHANCED DATA RATE DQPSK MODULATION .....	44
9.7.3.	BLUETOOTH ENHANCED DATA RATE 8PSK MODULATION .....	45
9.8.	<i>CONDUCTED SPURIOUS EMISSIONS</i> .....	46
9.8.1.	BLUETOOTH BASIC DATA RATE GFSK MODULATION .....	47
9.8.2.	BLUETOOTH ENHANCED DATA RATE 8PSK MODULATION .....	49
<b>10.</b>	<b>RADIATED TEST RESULTS .....</b>	<b>51</b>
10.1.	<i>TRANSMITTER ABOVE 1 GHz</i> .....	53
10.1.1.	BLUETOOTH BASIC DATA RATE GFSK MODULATION .....	53
10.1.2.	BLUETOOTH ENHANCED DATA RATE 8PSK MODULATION .....	63
10.2.	<i>Worst Case Below 30MHz</i> .....	73
10.3.	<i>Worst Case Below 1 GHz</i> .....	75
10.4.	<i>Worst Case 18-26 GHz</i> .....	77
<b>11.</b>	<b>AC POWER LINE CONDUCTED EMISSIONS .....</b>	<b>79</b>
<b>12.</b>	<b>SETUP PHOTOS .....</b>	<b>82</b>
12.1.	<i>A3LSMA305F (Original)</i> .....	82
12.2.	<i>A3LSMA305G (Spot Check)</i> .....	85

# 1. ATTESTATION OF TEST RESULTS

**COMPANY NAME:** Samsung Electronics Co., Ltd.  
129 Samsung-Ro, Yeongtong-Gu,  
Suwon-Si, Gyeonggi-Do, 16677, Korea

**EUT DESCRIPTION:** GSM/WCDMA/LTE phone with BT, DTS/UNII a/b/g/n/, and ANT+

**MODELS:** SM-A305G/DS and SM-A305G

**SERIAL NUMBER:** R38KC08WHJE (Conducted Original)  
R38KC08WJSN, R38KC08WKGY (Radiated Original)  
R38KC0KSQGX (Radiated Spot Check)

**DATE TESTED:** JANUARY 11 to 23, 2019 (Original)  
FEBRUARY 07, 2019 (Spot Check)

APPLICABLE STANDARDS	
STANDARD	TEST RESULTS
CFR 47 Part 15 Subpart C	Complies

UL Verification Services Inc. tested the above equipment in accordance with the requirements set forth in the above standards. The test results show that the equipment tested is capable of demonstrating compliance with the requirements as documented in this report.

The results documented in this report apply only to the tested sample, under the conditions and modes of operation as described herein. It is the manufacturer's responsibility to assure that additional production units of this model are manufactured with identical electrical and mechanical components. All samples tested were in good operating condition throughout the entire test program. Measurement Uncertainties are published for informational purposes only and were not taken into account unless noted otherwise.

This document may not be altered or revised in any way unless done so by UL Verification Services Inc. and all revisions are duly noted in the revisions section. Any alteration of this document not carried out by UL Verification Services Inc. will constitute fraud and shall nullify the document. This report must not be used by the client to claim product certification, approval, or endorsement by NVLAP, NIST, any agency of the Federal Government, or any agency of the U.S. government.

Approved & Released For  
UL Verification Services Inc. By:

Reviewed By:



Dan Corona  
Operations Leader  
Consumer Technology Division  
UL Verification Services Inc.

Kiya Kedida  
Senior Project Engineer  
Consumer Technology Division  
UL Verification Services Inc.

## 2. INTRODUCTION OF TEST DATA REUSE

### 2.1. INTRODUCTION

According to the manufacturer, FCC ID: A3LSMA305F and FCC ID: A3LSMA305G non-licensed radios are electrically identical. The FCC ID: A3LSMA305F test data shall remain representative of FCC ID: A3LSMA305G.

The applicant takes full responsibility that the test data as referenced in this section represents compliance for this FCC ID.

### 2.2. DIFFERENCES

Difference between A3LSMA305F and A3LSMA305G:

Samsung Electronics Co. Ltd. declares that A3LSMA305G does not support NFC function.

The FCC ID: A3LSMA305F, shares the same enclosure and circuit board as FCC ID: A3LSMA305G. The BT antennas and surrounding circuitry and layout are identical between two models.

After confirming through preliminary radiated emissions that the performance of the FCC ID: A3LSMG305F remains representative of FCC ID: A3LSMA305G. The test data of FCC ID: A3LSMG305F being submitted for this application to cover BT features.

### 2.3. SPOT CHECK VERIFICATION RESULTS SUMMARY

Spot check verification has been done on device A3LSMA305G for radiated harmonic spurious and radiated band-edge. The data from the application has been verified through appropriate spot checks to demonstrate compliance for this device in accordance to FCC public KDB 484596 D01 as shown in the summary below.

A3LSMA305G SPOT CHECK RESULTS										
Technology	Mode	Test Item	Channel	Measured Frequency	Original model		Spot check model		Delta (dB)	
					SM-A305F/DS		SM-A305G/DS		Peak Ave	
					A3LSMA305F		A3LSMA305G			
Peak	Ave	Peak	Ave	Peak	Ave					
BT	8PSK	RBE	78	2484MHz	62.68	38.17	57.96	37.21	-4.72	-0.96
	8PSK	RSE	39	15524MHz	51.3	39.04	51.76	38.69	0.46	-0.35

Comparison of the models, upper deviation is within 3dB range and all tests are under FCC Technical Limits.

**SPOT CHECK DATA**

**BANDEDGE (HIGH CHANNEL)**

**HORIZONTAL RESULT**

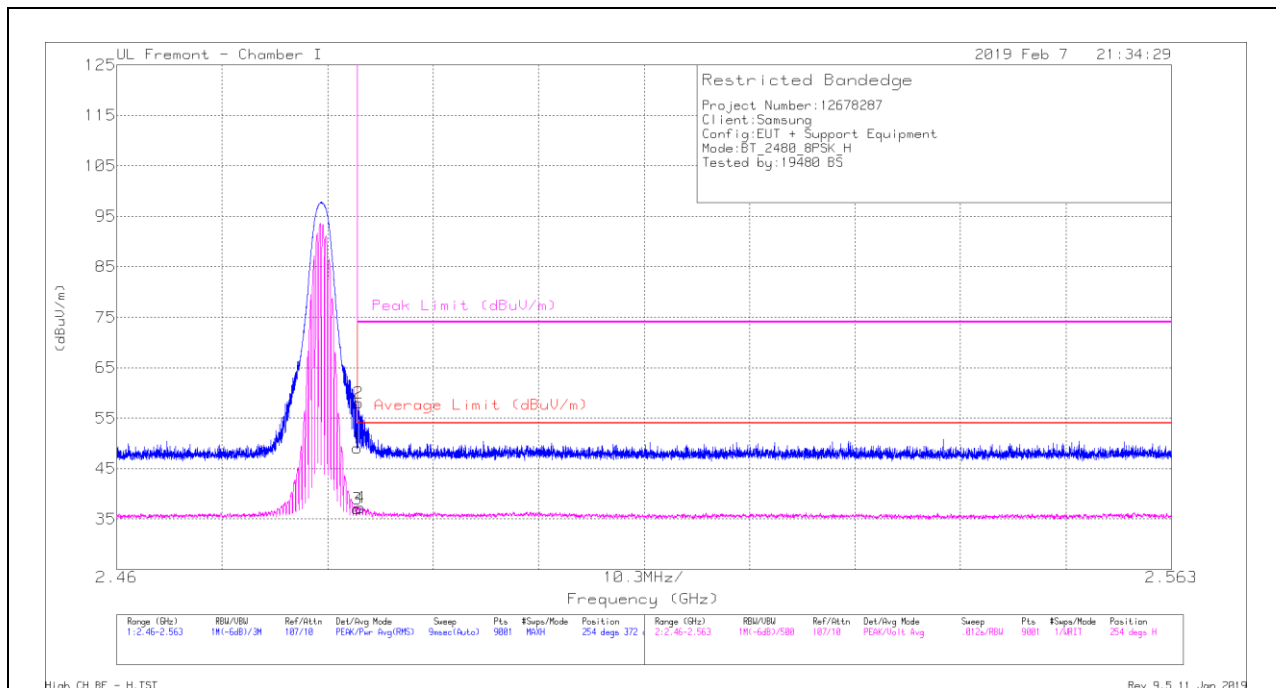

**Trace Markers**

Marker	Frequency (GHz)	Meter Reading (dBuV)	Det	AF T862 (dB/m)	Amp/Cbl/Filtr/Pad (dB)	Corrected Reading (dBuV/m)	Average Limit (dBuV/m)	Margin (dB)	Peak Limit (dBuV/m)	PK Margin (dB)	Azimuth (Degs)	Height (cm)	Polarity
1	* 2.484	38.37	Pk	32.4	-21.7	49.07	-	-	74	-24.93	254	372	H
2	* 2.484	47.26	Pk	32.4	-21.7	57.96	-	-	74	-16.04	254	372	H
3	* 2.484	26.27	VA1T	32.4	-21.7	36.97	54	-17.03	-	-	254	372	H
4	* 2.484	26.51	VA1T	32.4	-21.7	37.21	54	-16.79	-	-	254	372	H

\* - indicates frequency in CFR47 Pt 15 / IC RSS-Restricted Band

Pk - Peak detector

VA1T - FHSS: Linear Voltage Average VB=1/Ton where: Ton is transmit duration

### VERTICAL RESULT

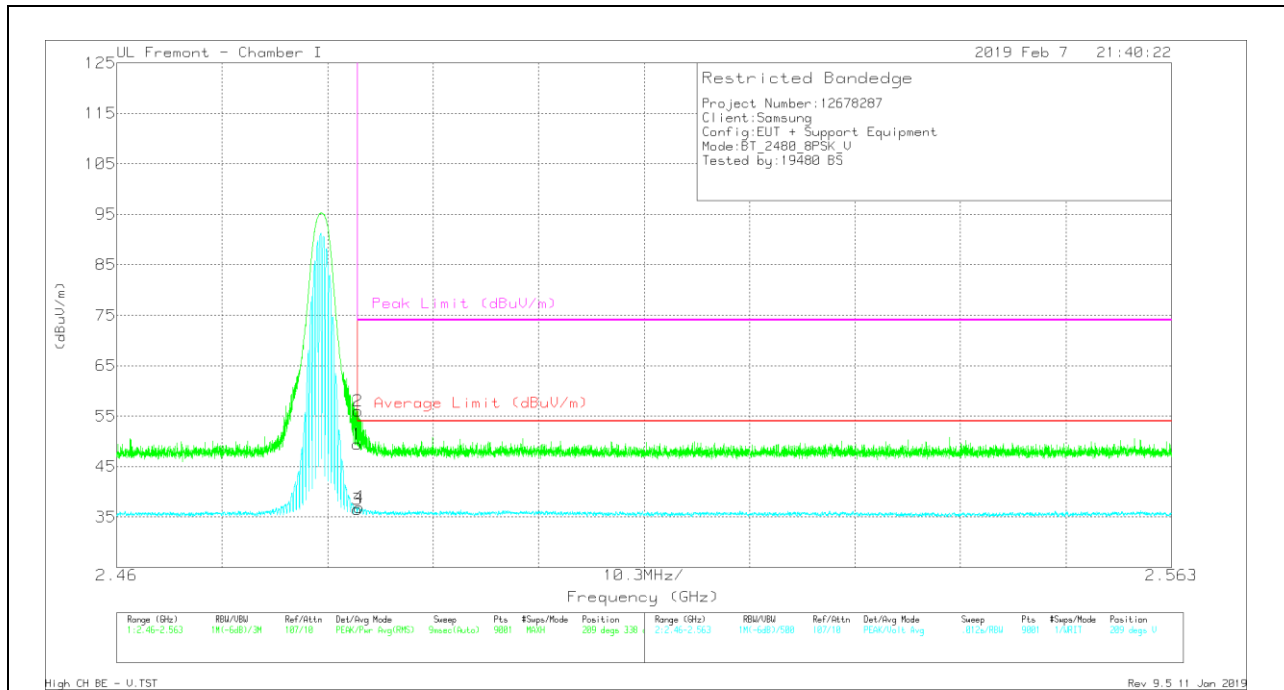

### Trace Markers

Marker	Frequency (GHz)	Meter Reading (dBuV)	Det	AF T862 (dB/m)	Amp/Cbl/Filtr/Pad (dB)	Corrected Reading (dBuV/m)	Average Limit (dBuV/m)	Margin (dB)	Peak Limit (dBuV/m)	PK Margin (dB)	Azimuth (Degs)	Height (cm)	Polarity
1	* 2.484	38.77	Pk	32.4	-21.7	49.47	-	-	74	-24.53	209	338	V
2	* 2.484	45.29	Pk	32.4	-21.7	55.99	-	-	74	-18.01	209	338	V
3	* 2.484	25.83	VA1T	32.4	-21.7	36.53	54	-17.47	-	-	209	338	V
4	* 2.484	26.24	VA1T	32.4	-21.7	36.94	54	-17.06	-	-	209	338	V

\* - indicates frequency in CFR47 Pt 15 / IC RSS-Restricted Band  
 Pk - Peak detector  
 VA1T - FHSS: Linear Voltage Average  $V_B=1/T_{on}$  where:  $T_{on}$  is transmit duration



# HARMONICS AND SPURIOUS EMISSIONS

## MID CHANNEL RESULTS

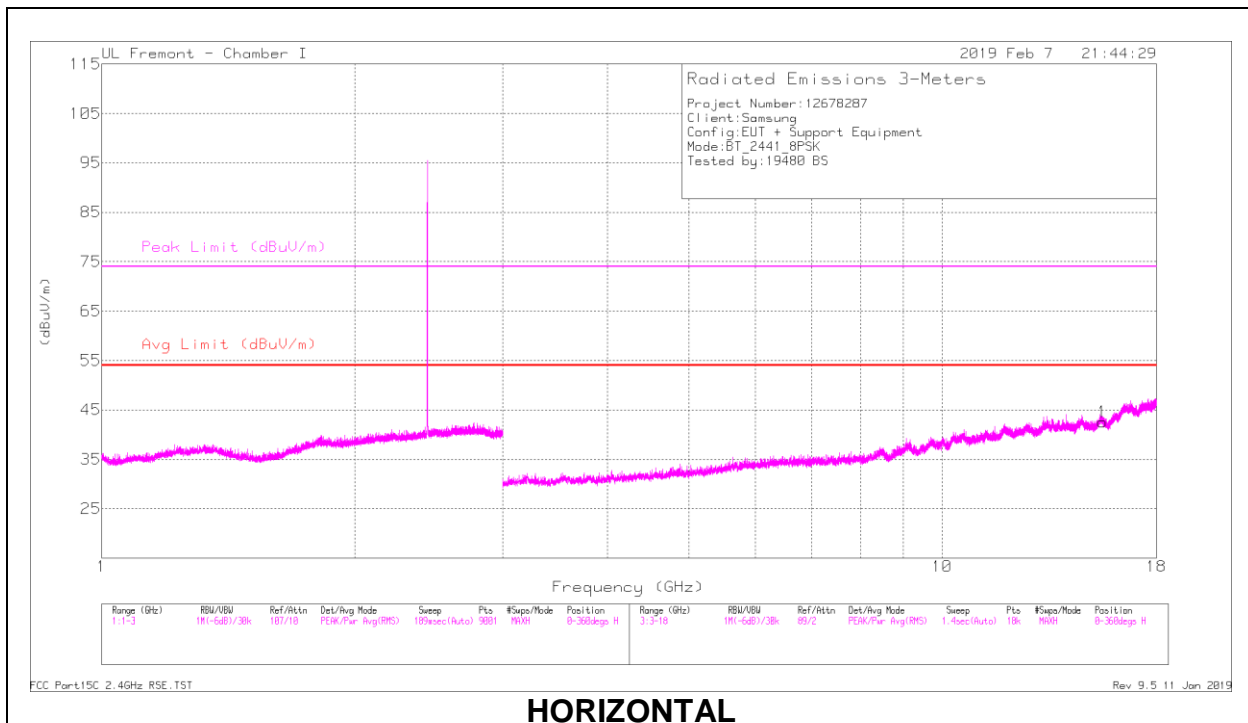

**HORIZONTAL**

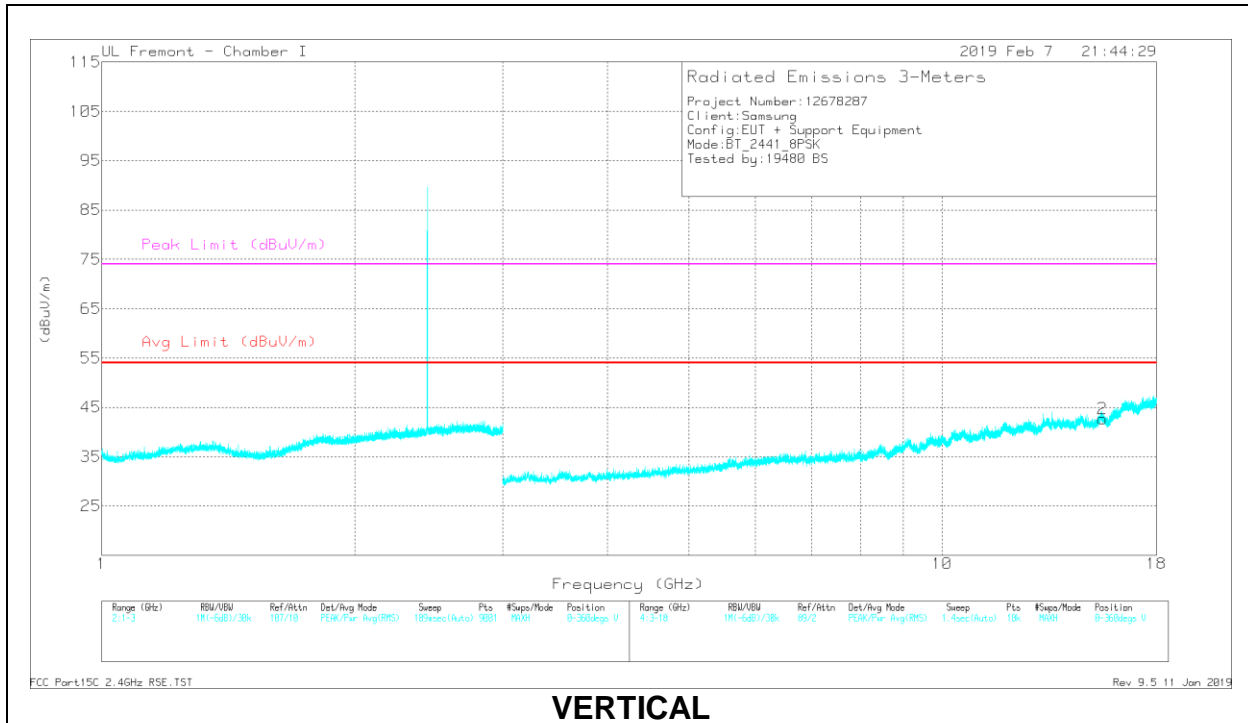

**VERTICAL**

**RADIATED EMISSIONS**

Marker	Frequency (GHz)	Meter Reading (dBuV)	Det	AF T862 (dB/m)	Amp/Cbl/Filtr/Pad (dB)	Corrected Reading (dBuV/m)	Avg Limit (dBuV/m)	Margin (dB)	Peak Limit (dBuV/m)	PK Margin (dB)	Azimuth (Degs)	Height (cm)	Polarity
1	* 15.526	31.46	PKFH	40.1	-19.8	51.76	-	-	74	-22.24	318	319	H
	* 15.524	18.29	VA1T	40.1	-19.7	38.69	54	-15.31	-	-	318	319	H
2	* 15.526	30.82	PKFH	40.1	-19.8	51.12	-	-	74	-22.88	285	106	V
	* 15.523	18.18	VA1T	40.1	-19.7	38.58	54	-15.42	-	-	285	106	V

\* - indicates frequency in CFR47 Pt 15 / IC RSS-Restricted Band

Pk - Peak detector

Av - Average detection

PKFH FHSS/BT RB=100k for Frequencies<1GHz / RB=1MHz for Frequencies>1GHz, VB=3 x RB, Peak

VA1T - FHSS: Linear Voltage Average VB=1/Ton where: Ton is transmit duration

## 2.4. REFERENCE DETAIL

Reference application that contains the reused reference data

<b>Equipment Class</b>	<b>Reference FCC ID</b>	<b>Type Grant/ Permissive Change</b>	<b>Reference Application</b>	<b>Folder Test/RF Exposure</b>	<b>Report Title/Section</b>
DSS	A3LSMA305F	Grant	12678282-E2	Test	FCC Report BT / All sections

### 3. TEST METHODOLOGY

The tests documented in this report were performed in accordance with FCC CFR 47 Part 2, FCC CFR 47 Part 15, ANSI C63.10-2013 and KDB 558074 D01 15.247 Meas Guidance v05.

### 4. FACILITIES AND ACCREDITATION

The test sites and measurement facilities used to collect data are located at 47173 and 47266 Benicia Street, and 47658 Kato Road, Fremont, California, USA. Line conducted emissions are measured only at the 47173 address. The following table identifies which facilities were utilized for radiated emission measurements documented in this report. Specific facilities are also identified in the test results sections.

47173 Benicia Street	47266 Benicia Street	47658 Kato Rd
<input type="checkbox"/> Chamber A (ISED:2324B-1)	<input type="checkbox"/> Chamber D (ISED:22541-1)	<input checked="" type="checkbox"/> Chamber I (ISED:2324A-5)
<input checked="" type="checkbox"/> Chamber B (ISED:2324B-2)	<input type="checkbox"/> Chamber E (ISED:22541-2)	<input checked="" type="checkbox"/> Chamber J (ISED:2324A-6)
<input type="checkbox"/> Chamber C (ISED:2324B-3)	<input type="checkbox"/> Chamber F (ISED:22541-3)	<input type="checkbox"/> Chamber K (ISED:2324A-1)
	<input type="checkbox"/> Chamber G (ISED:22541-4)	<input checked="" type="checkbox"/> Chamber L (ISED:2324A-3)
	<input type="checkbox"/> Chamber H (ISED:22541-5)	

The above test sites and facilities are covered under FCC Test Firm Registration # 208313. Chambers above are covered under Industry Canada company address and respective code

UL Verification Services Inc. is accredited by NVLAP, Laboratory Code 200065-0

## 5. CALIBRATION AND UNCERTAINTY

### 5.1. MEASURING INSTRUMENT CALIBRATION

The measuring equipment utilized to perform the tests documented in this report has been calibrated in accordance with the manufacturer's recommendations, and is traceable to recognized national standards.

### 5.2. SAMPLE CALCULATION

#### RADIATED EMISSIONS

Where relevant, the following sample calculation is provided:

Field Strength (dBuV/m) = Measured Voltage (dBuV) + Antenna Factor (dB/m) + Cable Loss (dB) – Preamp Gain (dB)

$$36.5 \text{ dBuV} + 18.7 \text{ dB/m} + 0.6 \text{ dB} - 26.9 \text{ dB} = 28.9 \text{ dBuV/m}$$

#### MAINS CONDUCTED EMISSIONS

Where relevant, the following sample calculation is provided:

Final Voltage (dBuV) = Measured Voltage (dBuV) + Cable Loss (dB) + Limiter Factor (dB) + LISN Insertion Loss.

$$36.5 \text{ dBuV} + 0 \text{ dB} + 10.1 \text{ dB} + 0 \text{ dB} = 46.6 \text{ dBuV}$$

### 5.3. MEASUREMENT UNCERTAINTY

Where relevant, the following measurement uncertainty levels have been estimated for tests performed on the apparatus:

PARAMETER	UNCERTAINTY
Worst Case Conducted Disturbance, 9KHz to 0.15 MHz	3.84 dB
Worst Case Conducted Disturbance, 0.15 to 30 MHz	3.65 dB
Worst Case Radiated Disturbance, 9KHz to 30 MHz	3.15 dB
Worst Case Radiated Disturbance, 30 to 1000 MHz	5.36 dB
Worst Case Radiated Disturbance, 1000 to 18000 MHz	4.32 dB
Worst Case Radiated Disturbance, 18000 to 26000 MHz	4.45 dB
Worst Case Radiated Disturbance, 26000 to 40000 MHz	5.24 dB

Uncertainty figures are valid to a confidence level of 95%.

## 6. EQUIPMENT UNDER TEST

### 6.1. EUT DESCRIPTION

The EUT is a GSM/WCDMA/LTE phone with BT, DTS/UNII a/b/g/n/ac, and ANT+. The test report addresses the BT operational mode.

### 6.2. MAXIMUM OUTPUT POWER

The transmitter has a maximum peak conducted output power as follows:

Frequency Range (MHz)	Mode	Output Power (dBm)	Output Power (mW)
2402 - 2480	Basic GFSK	9.71	9.35
2402 - 2480	Enhanced DQPSK	8.07	6.41
2402 - 2480	Enhanced 8PSK	8.16	6.55

Note: GFSK, DQPSK, 8PSK average Power are all investigated, The GFSK & 8PSK Power are the worst case. Testing is based on these modes to showing compliance. For average power data please refer to section 8.5.

### 6.3. DESCRIPTION OF AVAILABLE ANTENNAS

The radio utilizes an FPCB antenna, with a maximum gain of -2.9 dBi.

### 6.4. SOFTWARE AND FIRMWARE

The test utility software used during testing was A305F.001.

### 6.5. WORST-CASE CONFIGURATION AND MODE

Radiated emissions below 1GHz, above 18GHz, and power line conducted emission were performed with the EUT set to transmit at the channel with highest output power as worst-case scenario.

Band edge and radiated emissions between 1GHz and 18GHz were performed with the EUT set to transmit at the highest power on low, middle and high channels.

The fundamental of the EUT was investigated in three orthogonal orientations X,Y,Z, it was determined that X orientation was worst-case orientation; therefore, all final radiated testing was performed with the EUT in X orientation.

Worst-case data rates as provided by the client were:

GFSK mode: DH5

8PSK mode: 3-DH5

## 6.6. DESCRIPTION OF TEST SETUP

### SUPPORT EQUIPMENT

Support Equipment List				
Description	Manufacturer	Model	Serial Number	FCC ID
AC Adapter	Samsung	EP-TA50EWE	DW3J719AS/A-E	N/A
Earphone	Samsung	N/A	N/A	N/A

### I/O CABLES (CONDUCTED TEST)

I/O Cable List						
Cable No	Port	# of identical ports	Connector Type	Cable Type	Cable Length (m)	Remarks
1	Antenna	1	RF	Shielded	0.2	To PSA and BT Tester
2	USB	1	USB	Un-shielded	1	EUT to AC Mains

### I/O CABLES (RADIATED AND CONDUCTED EMISSIONS)

I/O Cable List						
Cable No	Port	# of identical ports	Connector Type	Cable Type	Cable Length (m)	Remarks
1	USB	1	USB	Shielded	1	N/A
2	earphone	1	3.5mm	Un-shielded	1	N/A

### TEST SETUP

The EUT is a stand alone unit. Test software exercised the radio card.

**CONDCUTED TEST SETUP DIAGRAM**

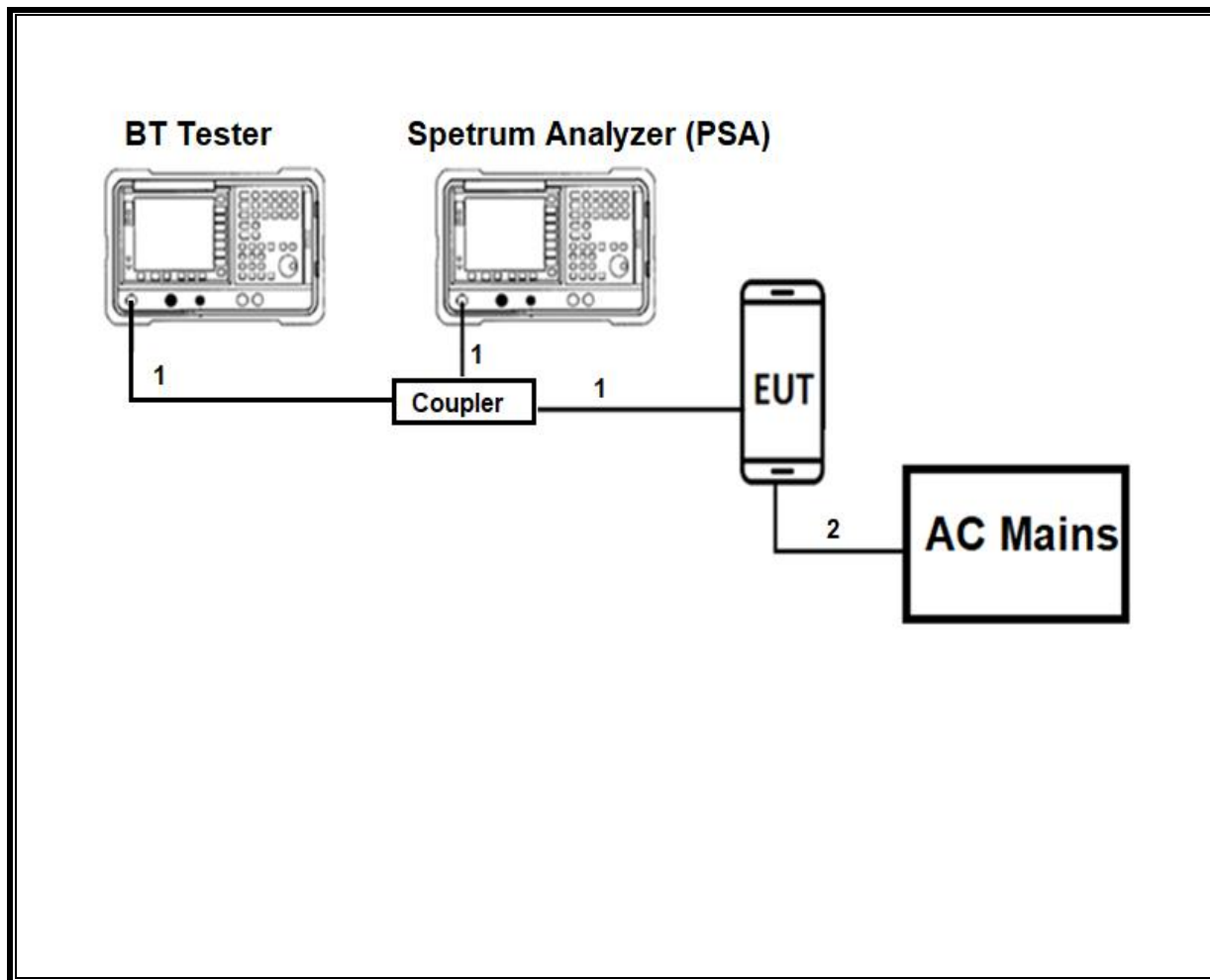

**TEST SETUP**

For conducted tests: the EUT was stand alone. The test software exercises the radio.



**RADIATED AND AC LINE CONDUCTED EMISSIONS SETUP DIAGRAM**

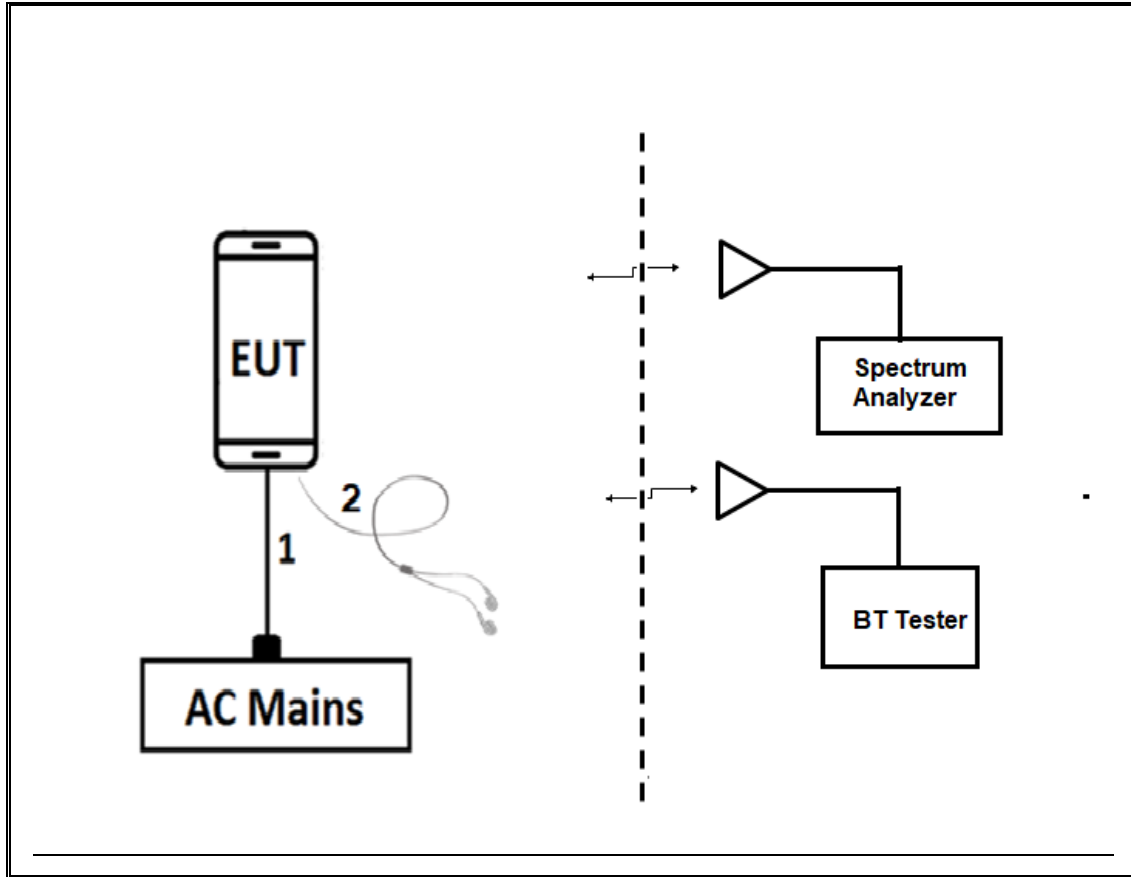

**TEST SETUP**

For radiated tests: EUT is stand alone. The test software exercises the radio.

## 7. TEST AND MEASUREMENT EQUIPMENT

The following test and measurement equipment was utilized for the tests documented in this report:

TEST EQUIPMENT LIST				
Description	Manufacturer	Model	Asset	Cal Due
Antenna, Passive Loop 9KHz to 1MHz	ELETRO METRICS	EM-6871	PRE0179465	05/22/2019
Antenna, Passive Loop 9KHz to 1MHz	ELETRO METRICS	EM-6872	PRE0179467	05/22/2019
Amplifier, 10KHz to 1GHz, 32dB	SONOMA INSTRUMENT	310	PRE0180175	07/09/2019
Antenna, Horn 1-18GHz	ETS Lindgren	3117	T863	06/21/2019
Amplifier, 1 to 18GHz	MITEQ	AFS42-00101800-25-S-42	T493	10/13/2019
Antenna, Horn 1-18GHz	ETS Lindgren	3117	AT0067	03/06/2019
Amplifier, 1 to 18GHz	Amplical	AMP1G18-35	T1571	07/30/2019
Antenna, Broadband Hybrid, 30MHz to 3000MHz	SunAR RF Motion	JB3	PRE0184970	11/13/2019
Amplifier, 10KHz to 1GHz, 32dB	SONOMA INSTRUMENT	310	PRE0180174	05/31/2019
Spectrum Analyzer, PXA, 3Hz to 44GHz	Keysight	E4446A	T146	08/13/2019
Spectrum Analyzer, PXA, 3Hz to 44GHz	Agilent (Keysight) Technologies	N9030A	T1466	04/16/2019
Antenna Horn, 18 to 26.5GHz	ARA	MWH-1826/B	T448	03/13/2019
Pre-Amp 1-26.5 GHz	Agilent	8449B	T404	03/09/2019
EMI Test Receiver	Rohde&Schwarz	ESW44	PRE0179375	05/08/2019
EMI Test Receiver	Rohde&Schwarz	ESW44	PRE0179376	05/08/2019
EMI Test Receiver	Rohde&Schwarz	ESW44	PRE0179377	11/02/2019
Power Meter, P-series single channel	Agilent (Keysight) Technologies	N1911A	T1271	07/17/2019
Power Sensor, P-series, 50MHz to 18GHz, Wideband	Agilent (Keysight) Technologies	N1921A	T1225	04/10/2019
Bluetooth Tester	Rohde & Schwarz (Koeln) GmbH & Co. KG	CBT	T258	02/23/2019
AC Line Conducted				
EMI Receiver	Rohde & Schwarz	ESR	T1436	02/21/2019
LISN for Conducted Emissions CISPR-16	FCC INC.	FCC LISN 50/250	T1310	06/15/2019
UL AUTOMATION SOFTWARE				
Radiated Software	UL	UL EMC	Ver 9.5, June 22, 2018	
Antenna Port Software	UL	UL RF	Ver 8.8.1, Sep 26, 2018	
AC Line Conducted Software	UL	UL EMC	Ver 9.5, May 26, 2015	

### NOTES:

1. Equipment listed above that calibrated during the testing period was set for test after the calibration.
2. Equipment listed above that has a calibration due date during the testing period, the testing is completed before equipment expiration date.

---

## 8. MEASUREMENT METHODS

On Time and Duty Cycle: ANSI C63.10-2013 Section 11.6

Occupied BW (20dB): ANSI C63.10-2013 Section 6.9.2

Occupied BW (99%): ANSI C63.10-2013 Section 6.9.3

Carrier Frequency Separation: ANSI C63.10-2013 Section 7.8.2

Number of Hopping Frequencies: ANSI C63.10-2013 Section 7.8.3

Time of Occupancy (Dwell Time): ANSI C63.10-2013 Section 7.8.4

Peak Output Power: ANSI C63.10-2013 Section 7.8.5

Conducted Spurious Emissions: ANSI C63.10-2013 Section 7.8.8

Conducted Band-Edge: ANSI C63.10-2013 Section 6.10.4

Radiated Spurious Emissions Below 30MHz: ANSI C63.10-2013 Section 6.4

Radiated Spurious Emissions 30-1000MHz: ANSI C63.10-2013 Section 6.3 and 6.5

Radiated Spurious Emissions above 1GHz: ANSI C63.10-2013 Section 6.3 and 6.6

Radiated Band-edge: ANSI C63.10-2013 Section 6.10.5

AC Power-line conducted emissions: ANSI C63.10-2013, Section 6.2.

## 9. ANTENNA PORT TEST RESULTS

### 9.1. ON TIME AND DUTY CYCLE

#### LIMITS

None; for reporting purposes only.

#### PROCEDURE

ANSI C63.10, Section 11.6 : Zero-Span Spectrum Analyzer Method.

#### ON TIME AND DUTY CYCLE RESULTS

Mode	ON Time B (msec)	Period (msec)	Duty Cycle x (linear)	Duty Cycle (%)	Duty Cycle Correction Factor (dB)	1/T Minimum VBW (kHz)
Bluetooth GFSK	2.877	3.752	0.767	76.7%	1.15	0.348
Bluetooth 8PSK	2.885	3.751	0.769	76.9%	1.14	0.347

**DUTY CYCLE PLOTS**

Tested By:	19497 AF
Date:	1/12/2019

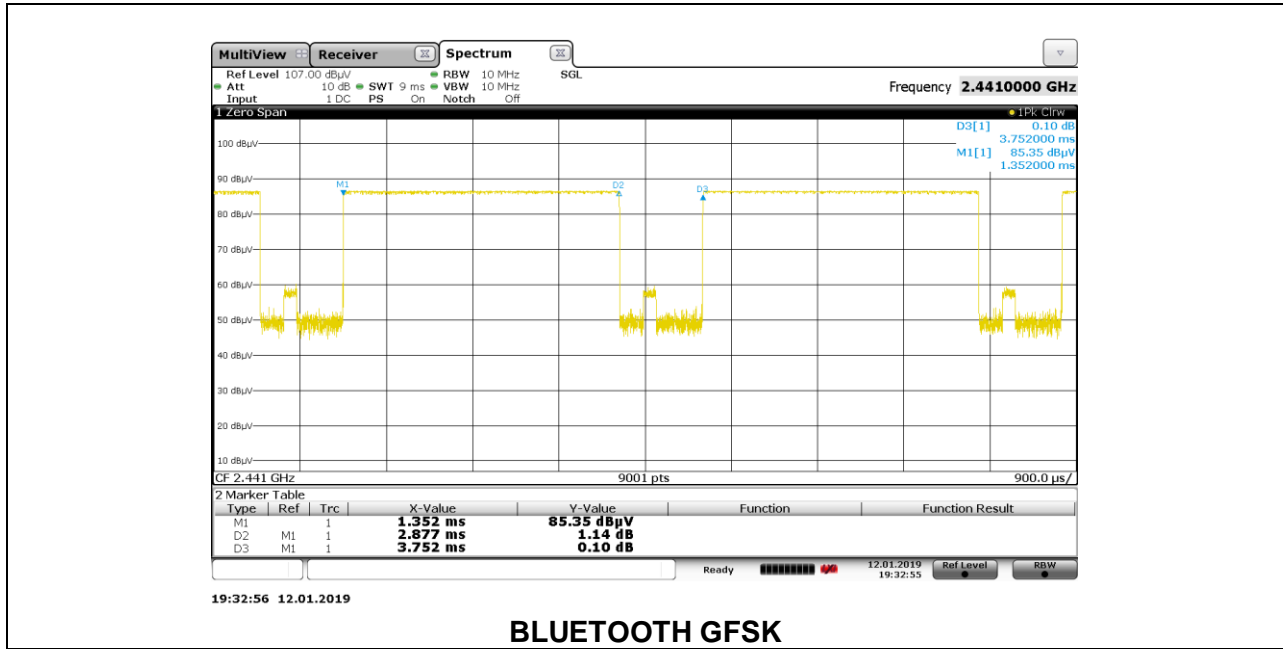

**BLUETOOTH GFSK**

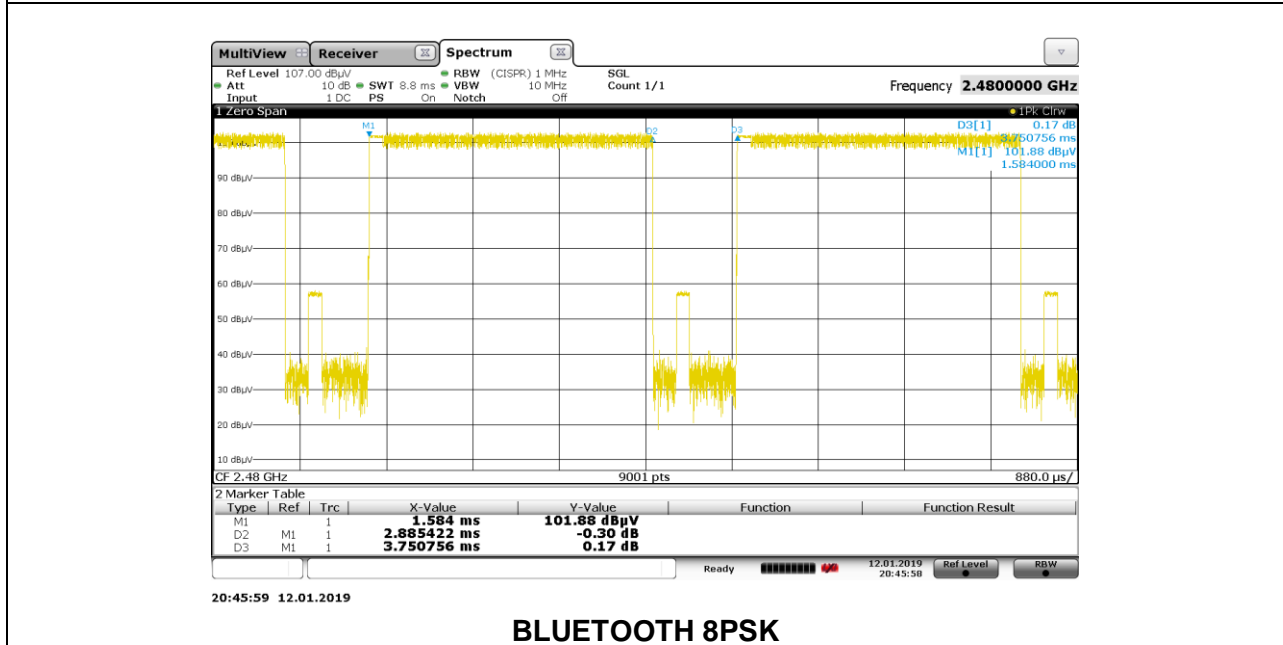

**BLUETOOTH 8PSK**

---

**9.2. 20 dB AND 99% BANDWIDTH**

**LIMITS**

None; for reporting purposes only.

**TEST PROCEDURE**

The transmitter output is connected to a spectrum analyzer. The RBW is set to  $\geq 1\%$  of the 20 dB bandwidth. The VBW is set to  $\geq$  RBW. The sweep time is coupled.

**RESULTS**

### 9.2.1. BLUETOOTH ENHANCED DATA RATE GFSK MODULATION

Channel	Frequency (MHz)	20dB Bandwidth (MHz)	99% Bandwidth (MHz)
Low	2402	1.045	0.9161
Mid	2441	1.036	0.9118
High	2480	1.030	0.9047

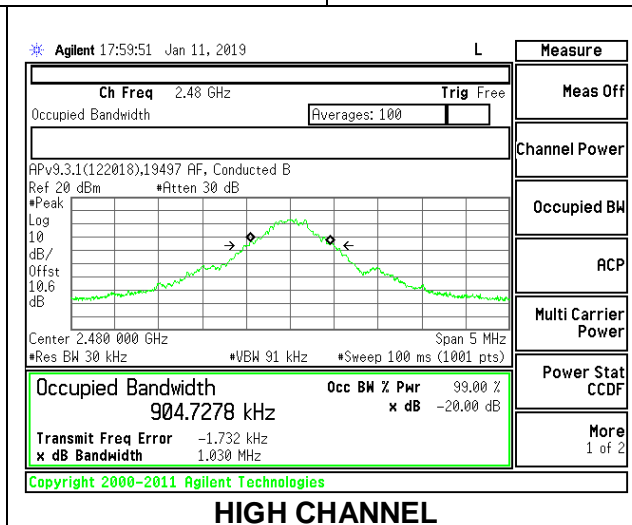
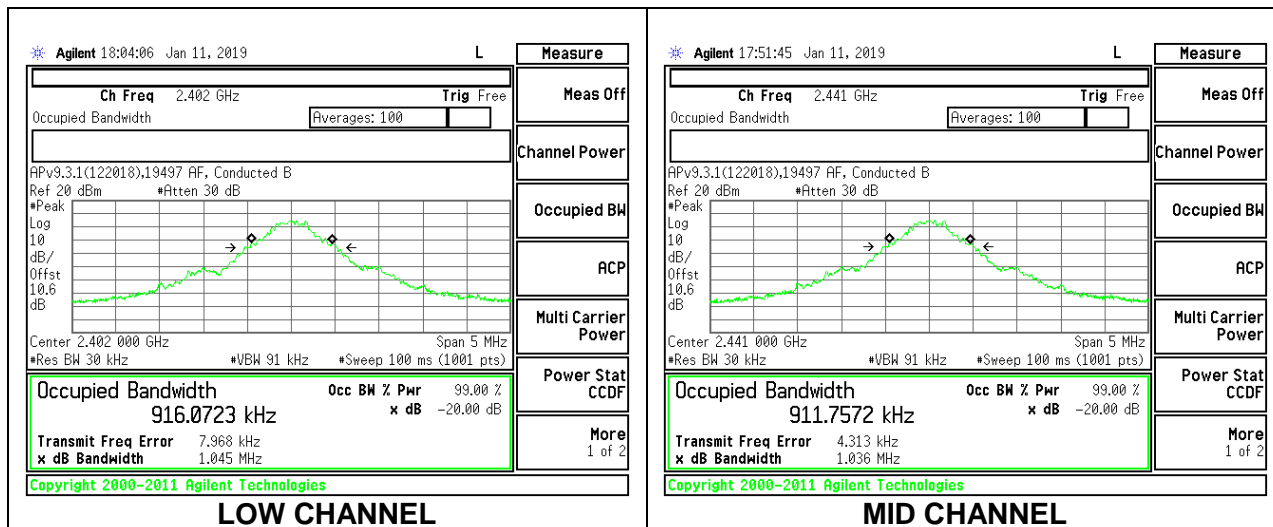

### 9.2.2. BLUETOOTH ENHANCED DATA RATE 8PSK MODULATION

Channel	Frequency (MHz)	20dB Bandwidth (MHz)	99% Bandwidth (MHz)
Low	2402	1.313	1.1932
Mid	2441	1.331	1.2005
High	2480	1.334	1.1204

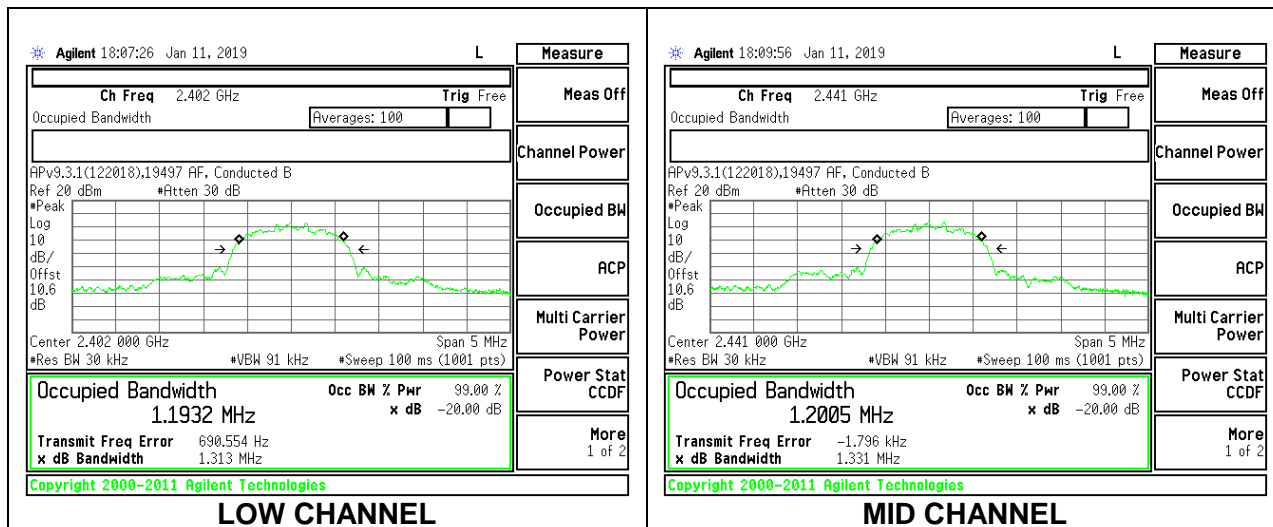

**LOW CHANNEL**

**MID CHANNEL**

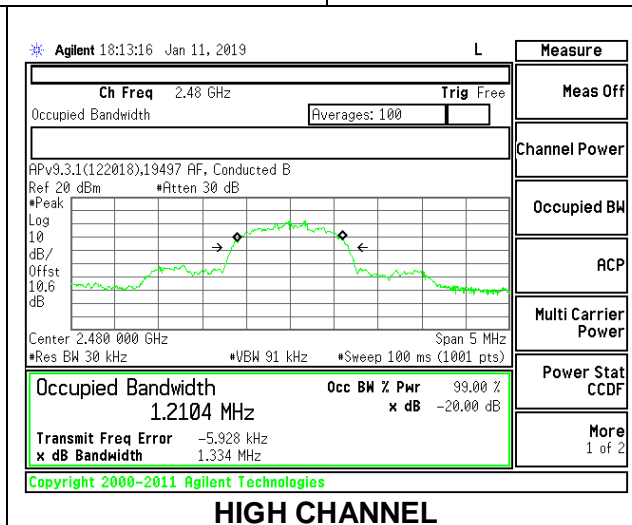

**HIGH CHANNEL**



---

### 9.3. HOPPING FREQUENCY SEPARATION

#### **LIMITS**

FCC §15.247 (a) (1)

Frequency hopping systems shall have hopping channel carrier frequencies separated by a minimum of 25 kHz or the 20 dB bandwidth of the hopping channel, whichever is greater.

Alternatively, frequency hopping systems operating in the 2400-2483.5 MHz band may have hopping channel carrier frequencies that are separated by 25 kHz or two-thirds of the 20 dB bandwidth of the hopping channel, whichever is greater, provided the systems operate with an output power no greater than 125 mW.

#### **TEST PROCEDURE**

The transmitter output is connected to a spectrum analyzer. The RBW is set to 300 kHz and the VBW is set to 300 kHz. The sweep time is coupled.

#### **RESULTS**

### 9.3.1. BLUETOOTH BASIC DATA RATE GFSK MODULATION

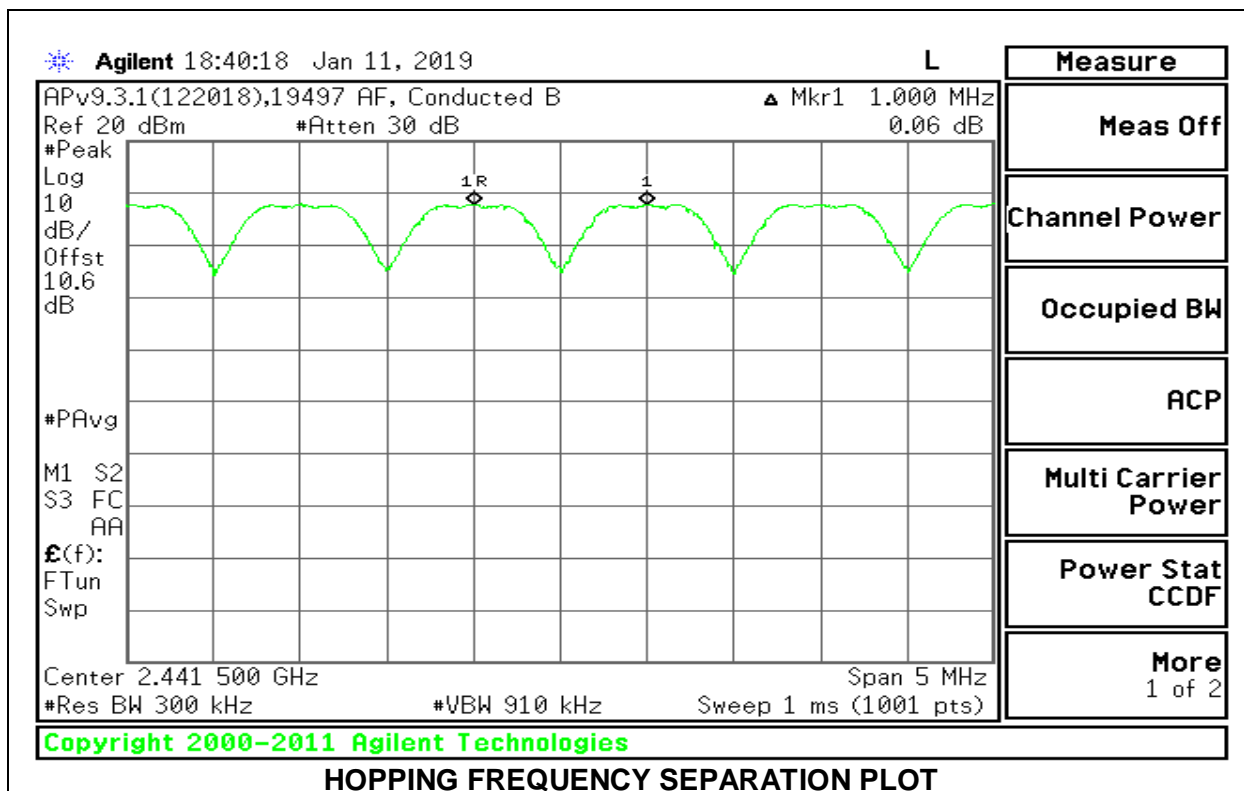

### 9.3.2. BLUETOOTH ENHANCED DATA RATE 8PSK MODULATION

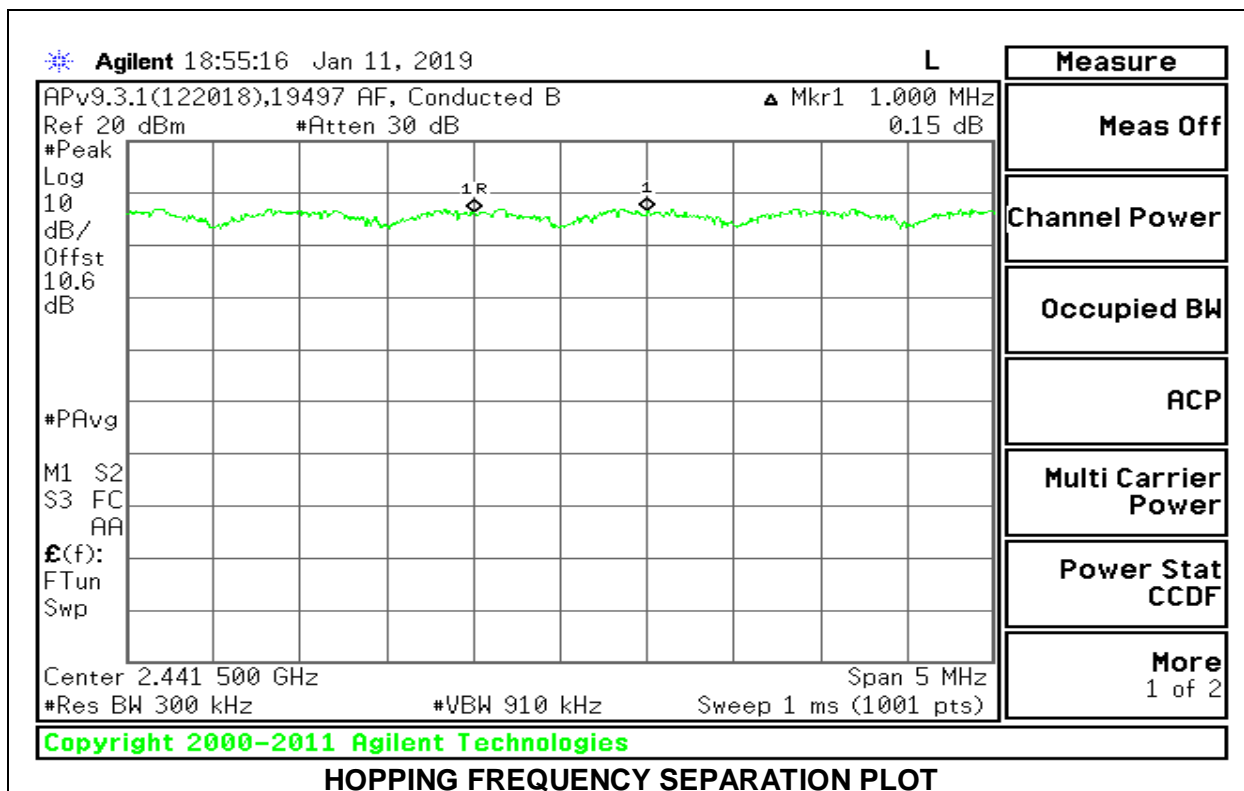

---

## 9.4. NUMBER OF HOPPING CHANNELS

### **LIMITS**

FCC §15.247 (a) (1) (iii)

Frequency hopping systems in the 2400 – 2483.5 MHz band shall use at least 15 non-overlapping channels.

### **TEST PROCEDURE**

The transmitter output is connected to a spectrum analyzer. The span is set to cover the entire authorized band, in either a single sweep or in multiple contiguous sweeps. The RBW is set to a maximum of 1 % of the span. The analyzer is set to Max Hold.

### **RESULTS**

Normal Mode: 79 Channels Observed

### 9.4.1. BLUETOOTH BASIC DATA RATE GFSK MODULATION

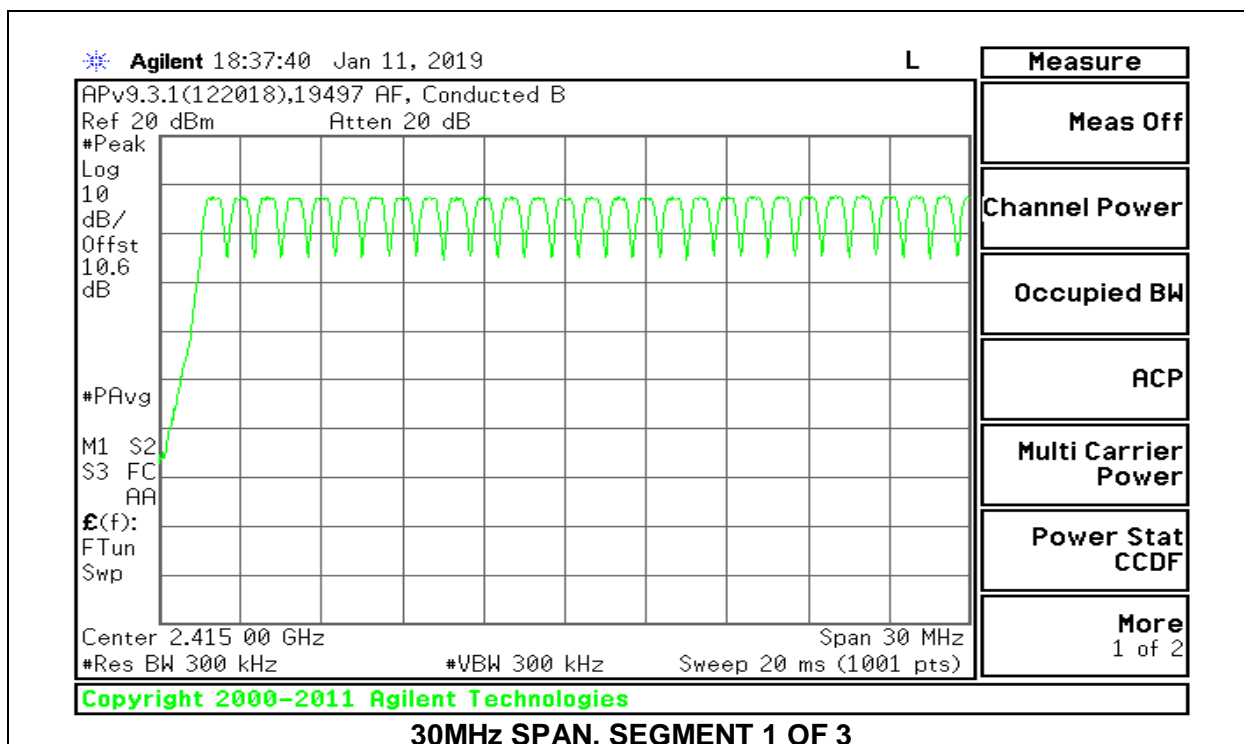
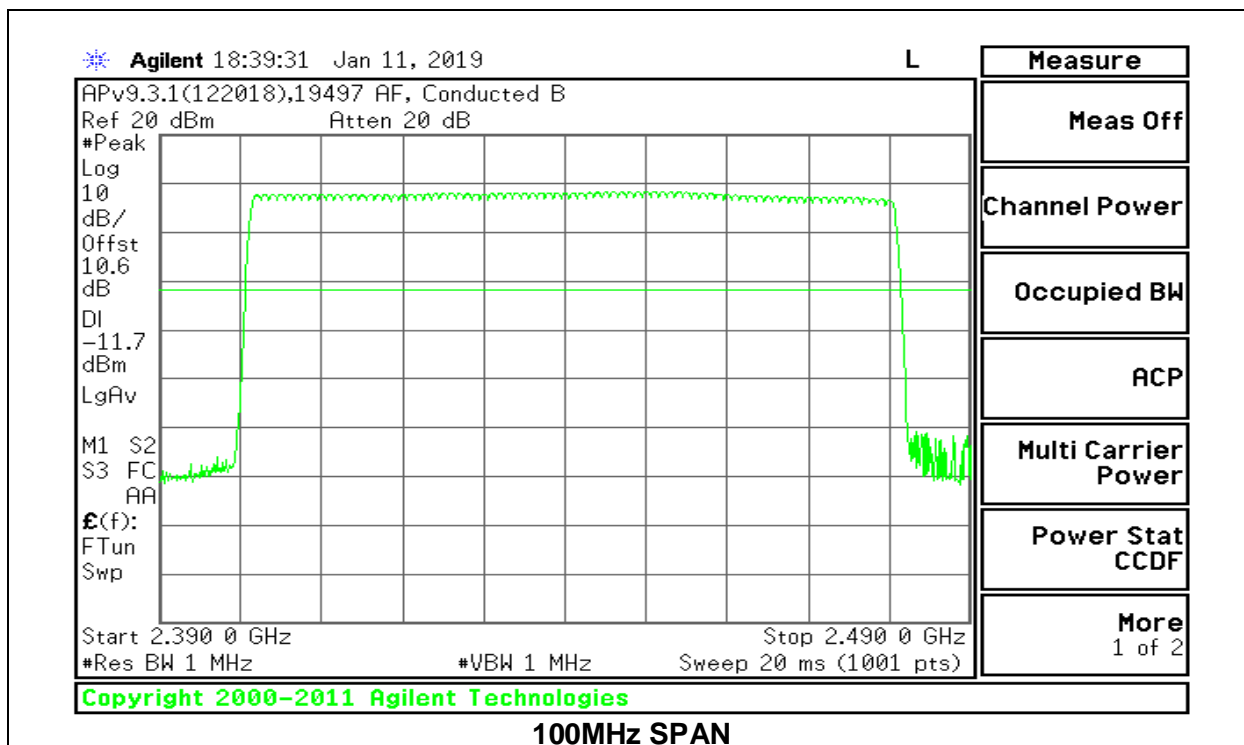

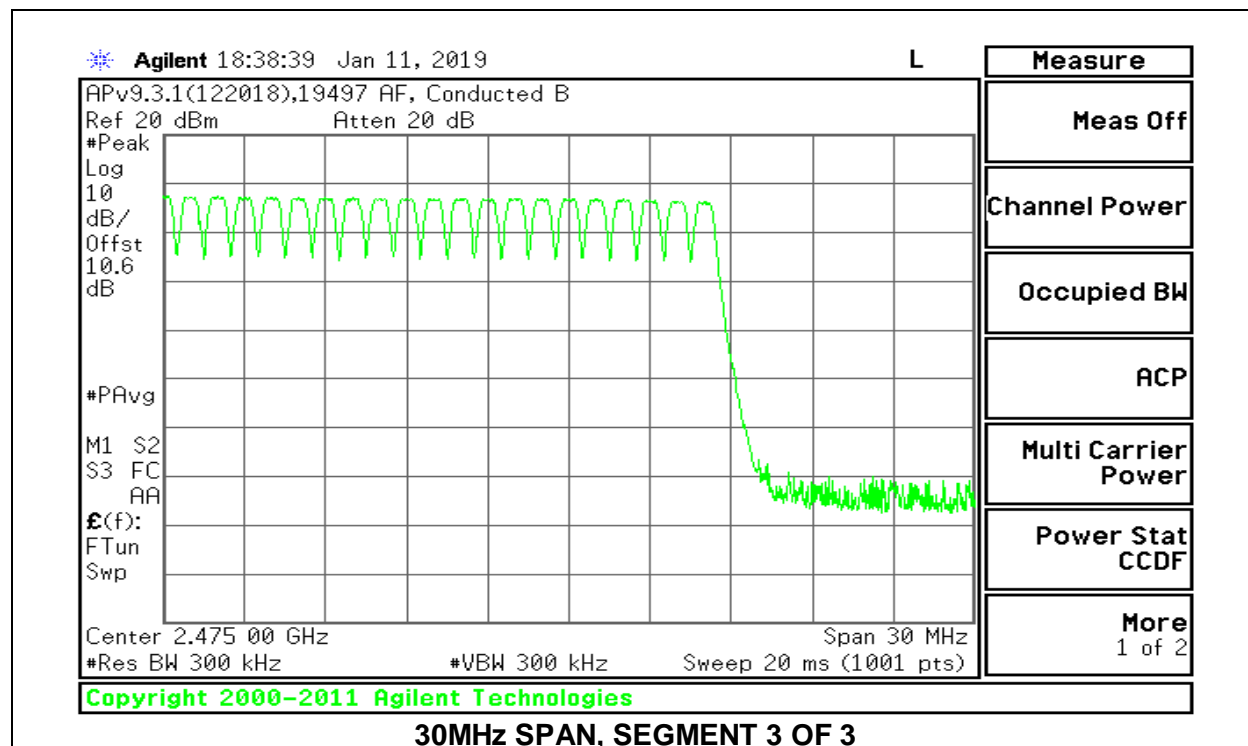
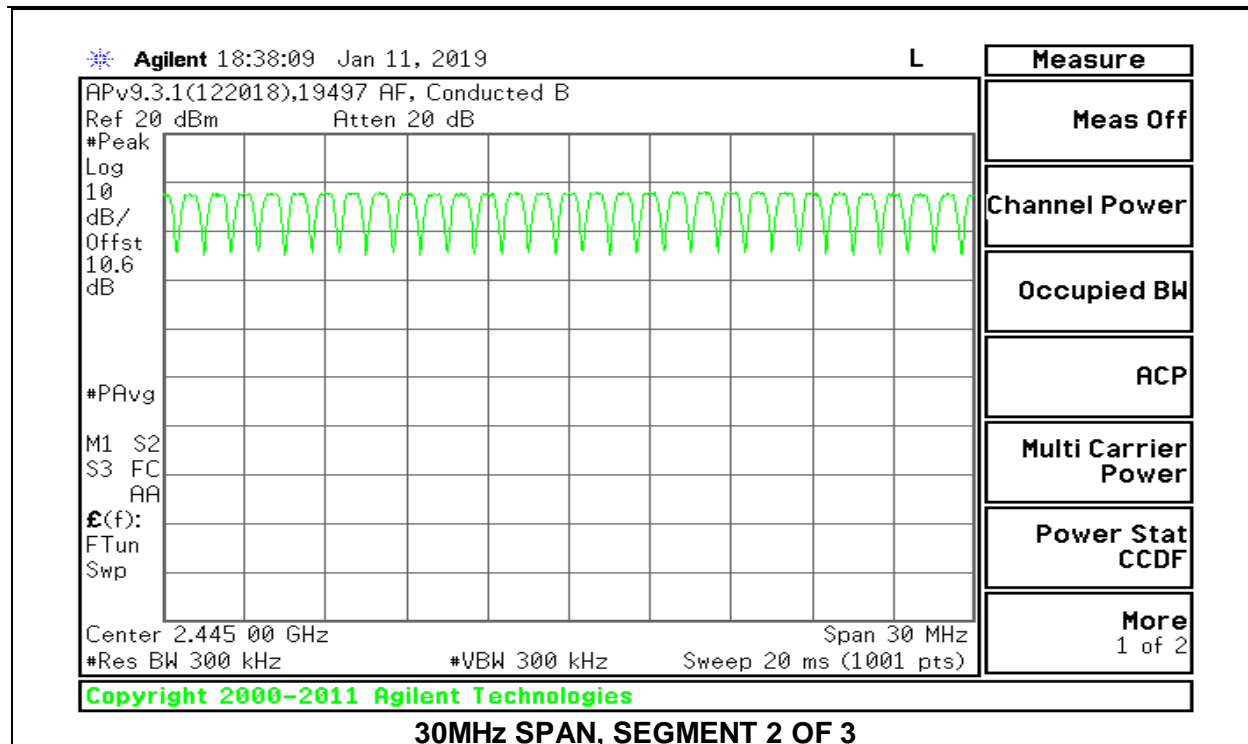

### 9.4.2. BLUETOOTH ENHANCED DATA RATE 8PSK MODULATION

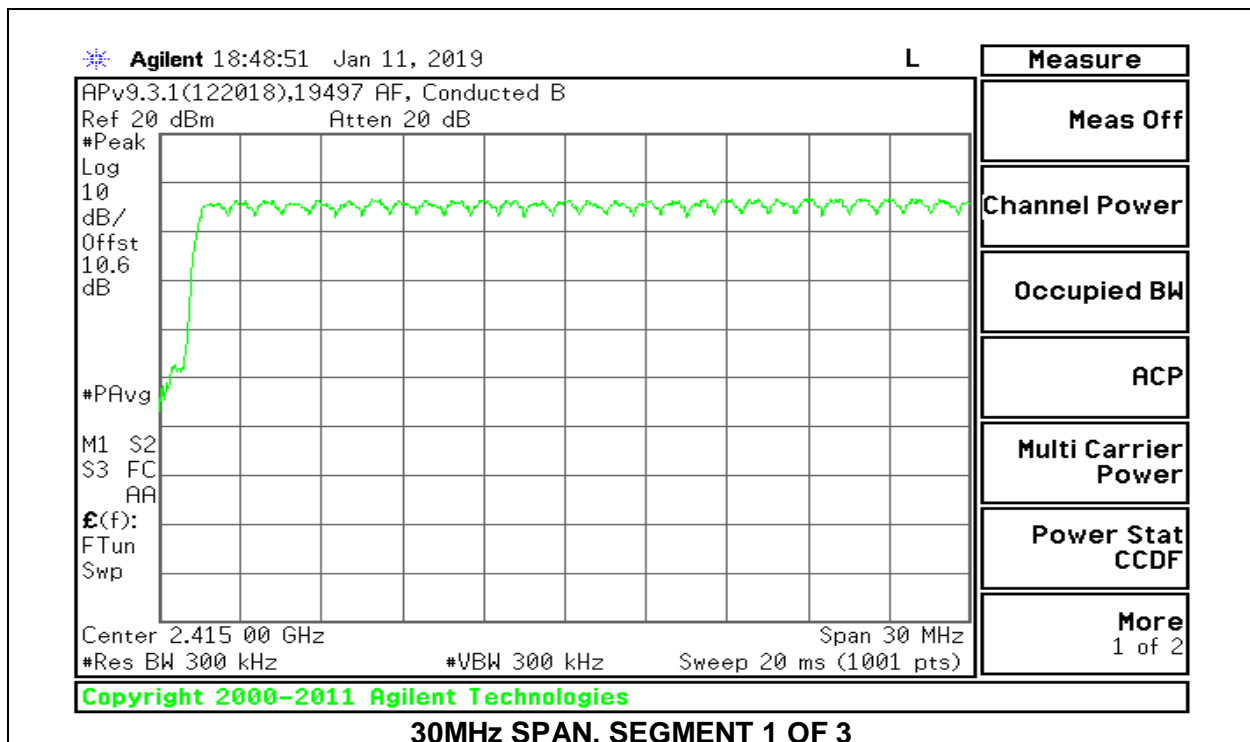
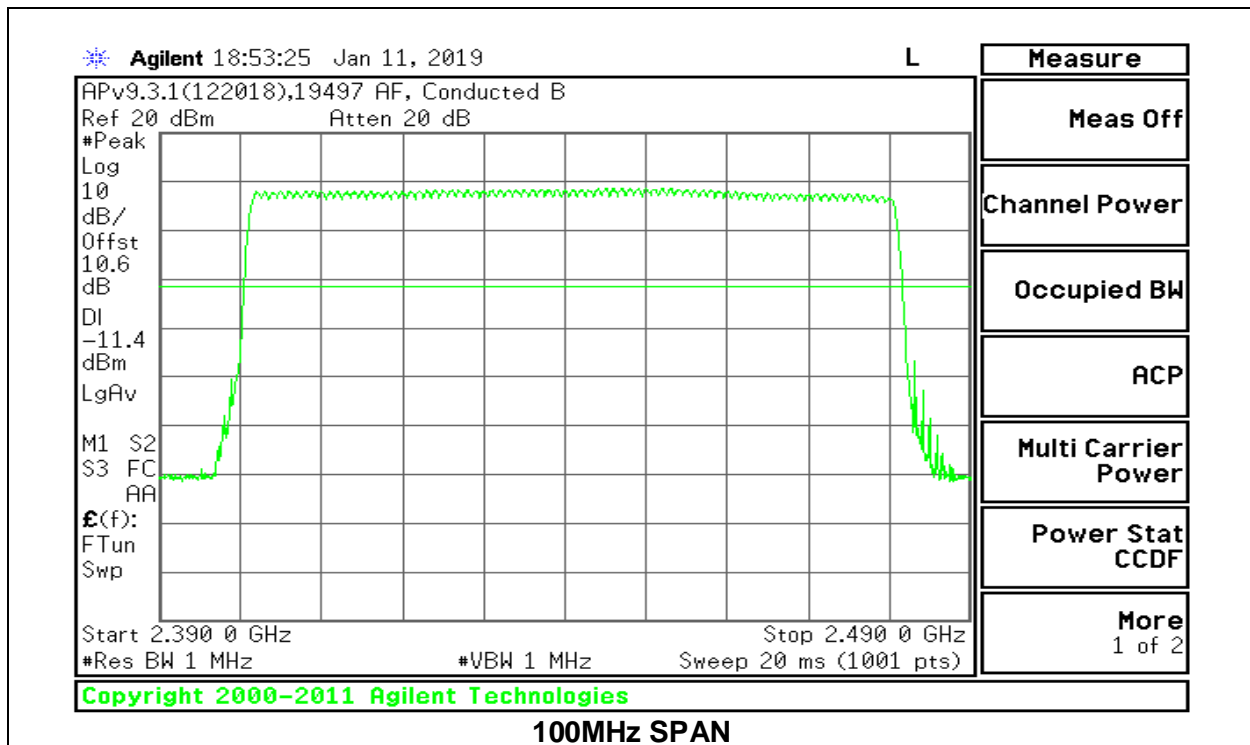

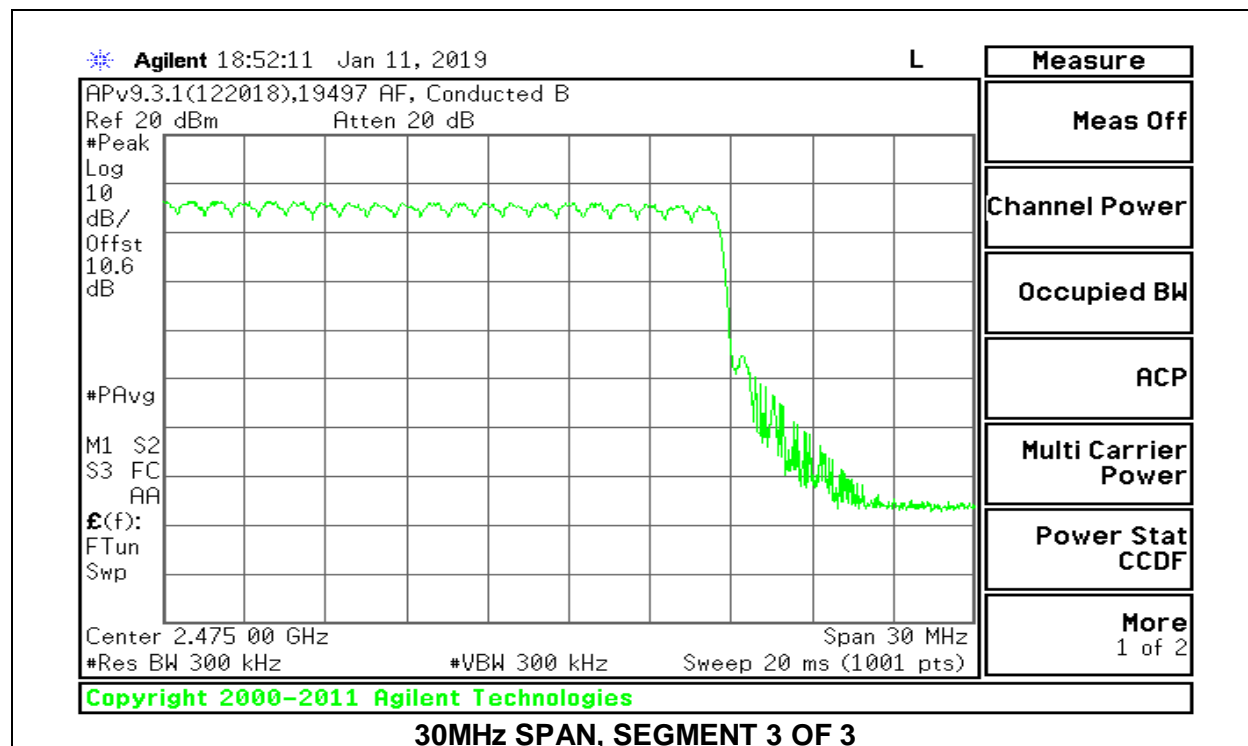
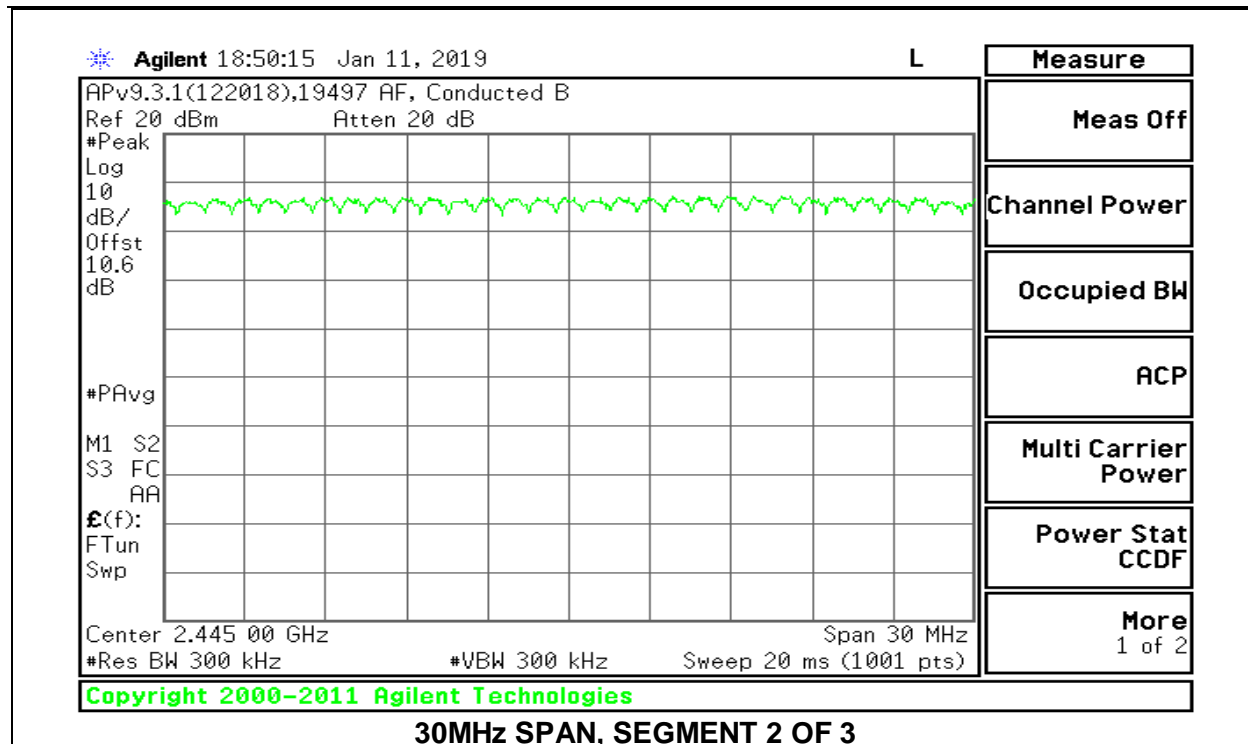



---

## 9.5. AVERAGE TIME OF OCCUPANCY

### LIMITS

FCC §15.247 (a) (1) (iii)

The average time of occupancy on any channel shall not be greater than 0.4 seconds within a period of 0.4 seconds multiplied by the number of hopping channels employed.

### TEST PROCEDURE

The transmitter output is connected to a spectrum analyzer. The span is set to 0 Hz, centered on a single, selected hopping channel. The width of a single pulse is measured in a fast scan. The number of pulses is measured in a 3.16 second scan, to enable resolution of each occurrence.

The average time of occupancy in the specified 3.16 second period (79 channels \* 0.4 s) is equal to  $10 * (\# \text{ of pulses in } 3.16 \text{ s}) * \text{ pulse width}$ .

For AFH mode, the average time of occupancy in the specified 8 second period (20 channels \* 0.4 seconds) is equal to  $10 * (\# \text{ of pulses in } 0.8 \text{ s}) * \text{ pulse width}$ .

### RESULTS

**9.5.1. BLUETOOTH BASIC DATA RATE GFSK MODULATION**

DH Packet	Pulse Width (msec)	Number of Pulses in 3.16 seconds	Average Time of Occupancy (sec)	Limit (sec)	Margin (sec)
<b>GFSK Normal Mode</b>					
3DH1	0.3808	32	0.1219	0.4	-0.2781
3DH3	1.635	15	0.2453	0.4	-0.1548
3DH5	2.885	12	0.3462	0.4	-0.0538
<b>GFSK AFH Mode</b>					
DH Packet	Pulse Width (sec)	Number of Pulses in 0.8 seconds	Average Time of Occupancy (sec)	Limit (sec)	Margin (sec)
3DH1	0.3808	8	0.03046	0.4	-0.3695
3DH3	1.635	3.75	0.06131	0.4	-0.3387
3DH5	2.885	3	0.08655	0.4	-0.3135

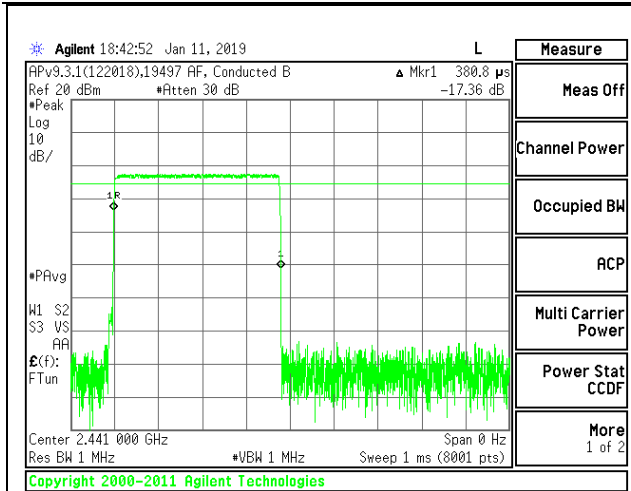

**PULSE WIDTH – 3DH1**

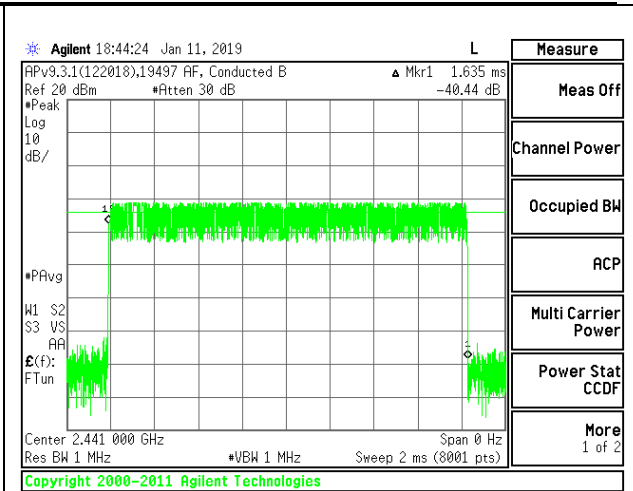

**PULSE WIDTH – 3DH3**

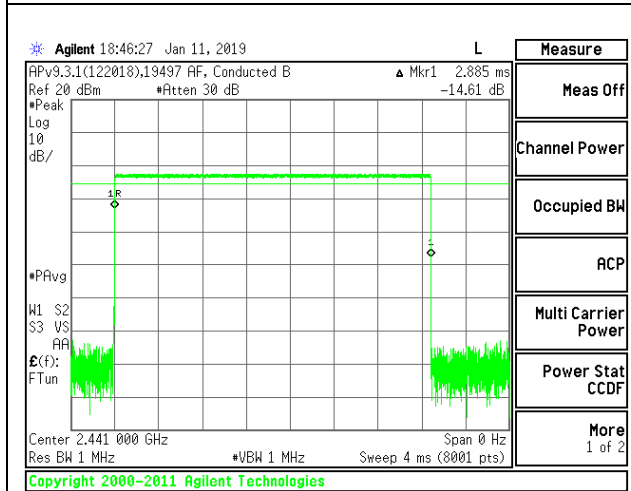

**PULSE WIDTH – 3DH5**

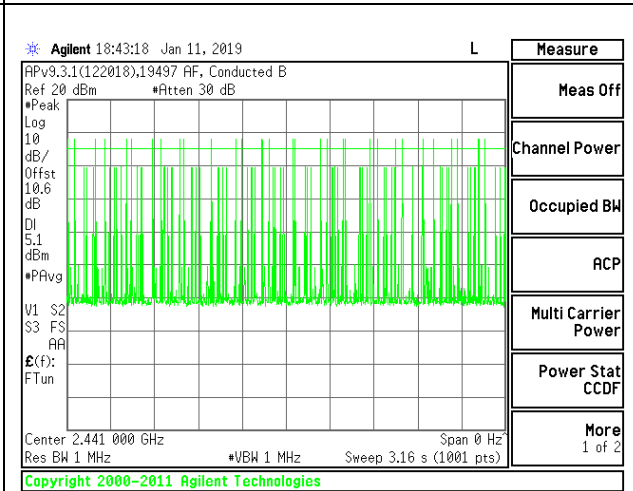

**NUMBER OF PULSES IN 3.16 SECOND OBSERVATION PERIOD – 3DH1**

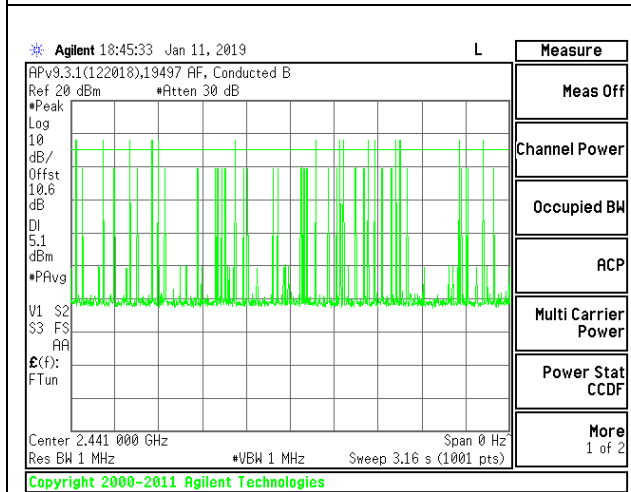

**NUMBER OF PULSES IN 3.16 SECOND OBSERVATION PERIOD – 3DH3**

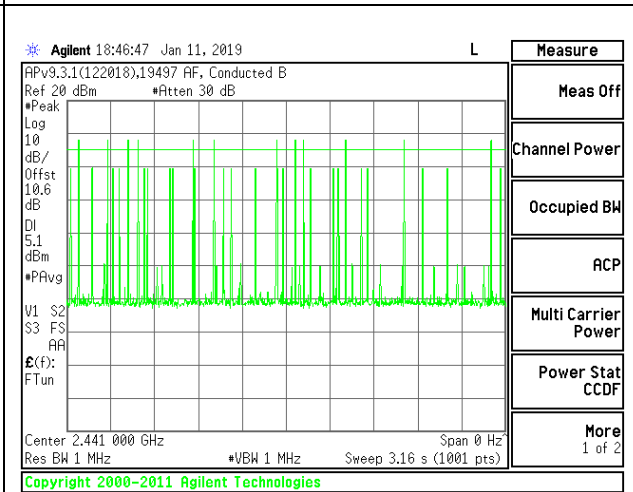

**NUMBER OF PULSES IN 3.16 SECOND OBSERVATION PERIOD – 3DH5**

**9.5.2. BLUETOOTH ENHANCED DATA RATE 8PSK MODULATION**

DH Packet	Pulse Width (msec)	Number of Pulses in 3.16 seconds	Average Time of Occupancy (sec)	Limit (sec)	Margin (sec)
8PSK Normal Mode					
3DH1	0.3926	32	0.125632	0.4	-0.27437
3DH3	1.641	17	0.27897	0.4	-0.12103
3DH5	2.892	10	0.2892	0.4	-0.1108

Note: for AFH(8PSK) mode, please refer to the results of AFH(GFSK) mode; the channel selection and hopping rate are the same for both EDR and Basic Rate operation, data for Basic Rate demonstrates compliance with channel occupancy when AFH is employed.

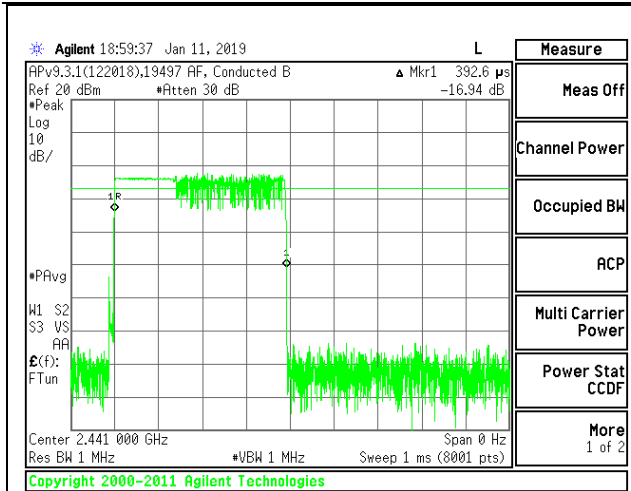

**PULSE WIDTH – 3DH1**

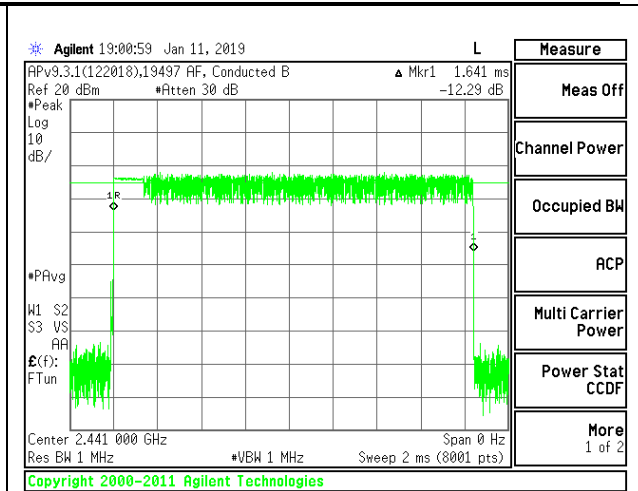

**PULSE WIDTH – 3DH3**

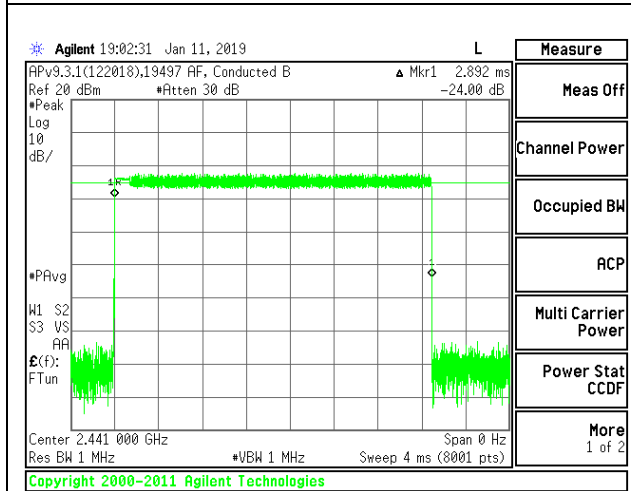

**PULSE WIDTH – 3DH5**

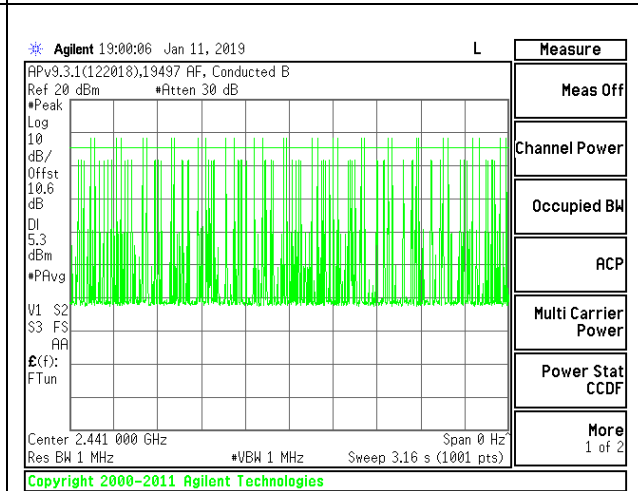

**NUMBER OF PULSES IN 3.16 SECOND  
OBSERVATION PERIOD – 3DH1**

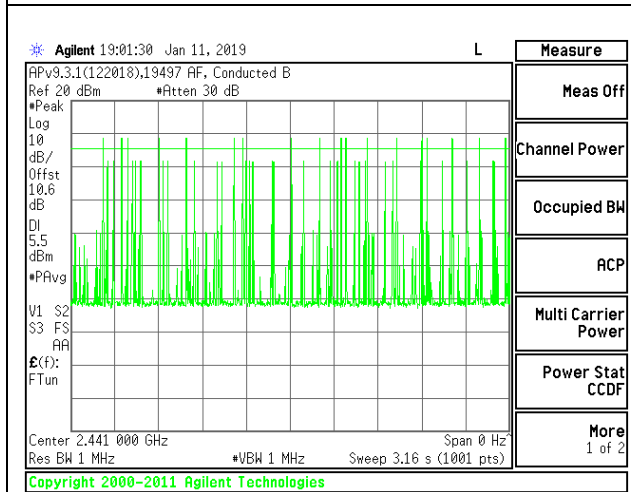

**NUMBER OF PULSES IN 3.16 SECOND  
OBSERVATION PERIOD – 3DH3**

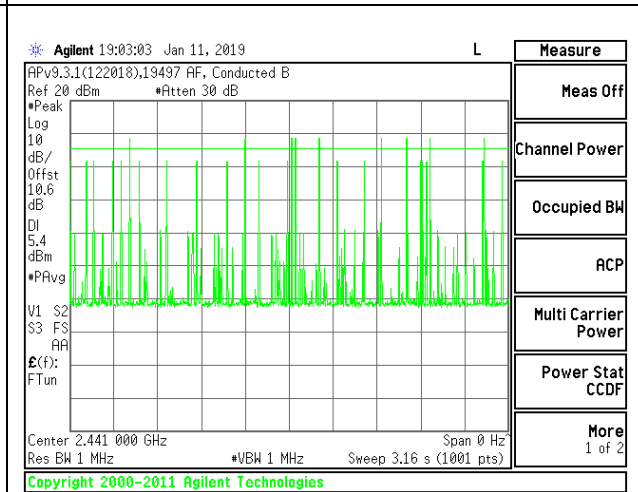

**NUMBER OF PULSES IN 3.16 SECOND  
OBSERVATION PERIOD – 3DH5**

---

## 9.6. OUTPUT POWER

### **LIMITS**

§15.247 (b) (1)

The maximum antenna gain is less than 6 dBi, therefore the limit is 30 dBm. Alternatively, frequency hopping systems operating in the 2400-2483.5 MHz band may have hopping channel carrier frequencies that are separated by 25 kHz or two-thirds of the 20 dB bandwidth of the hopping channel, whichever is greater, provided the systems operate with an output power no greater than 125 mW.

### **TEST PROCEDURE**

Measurements perform using a wideband gated RF power meter.

The cable assembly insertion loss of 10.6 dB (including 10 dB pad and 0.6 dB cable) was entered as an offset in the power meter to allow for a gated peak reading of power.

### **RESULTS**

---

### 9.6.1. BLUETOOTH BASIC DATA RATE GFSK MODULATION

Tested By:	19497 AF
Date:	1/14/2019

Channel	Frequency (MHz)	Output Power (dBm)	Limit (dBm)	Margin (dB)
Low	2402	9.55	30	-20.45
Middle	2441	9.71	30	-20.29
High	2480	8.23	30	-21.77

---

### 9.6.2. BLUETOOTH ENHANCED DATA RATE DQPSK MODULATION

Tested By:	19497 AF
Date:	1/14/2019

Channel	Frequency (MHz)	Output Power (dBm)	Limit (dBm)	Margin (dB)
Low	2402	7.91	21	-13.09
Middle	2441	8.07	21	-12.93
High	2480	6.98	21	-14.02



---

### 9.6.3. BLUETOOTH ENHANCED DATA RATE 8PSK MODULATION

Tested By:	19497 AF
Date:	1/14/2019

Channel	Frequency (MHz)	Output Power (dBm)	Limit (dBm)	Margin (dB)
Low	2402	7.94	21	-13.06
Middle	2441	8.16	21	-12.84
High	2480	7.12	21	-13.88

---

**9.7. AVERAGE POWER**

**LIMITS**

None; for reporting purposes only

**TEST PROCEDURE**

Measurements perform using a wideband gated RF power meter.

The cable assembly insertion loss of 10.6 dB (including 10 dB pad and 0.6 dB cable) was entered as an offset in the power meter to allow for a gated average reading of power.

**RESULTS**

---

### 9.7.1. BLUETOOTH BASIC DATA RATE GFSK MODULATION

Tested By:	19497 AF
Date	1/14/2019

Channel	Frequency (MHz)	Average Power (dBm)
Low	2402	8.77
Middle	2441	9.21
High	2480	7.70

---

### 9.7.2. BLUETOOTH ENHANCED DATA RATE DQPSK MODULATION

Tested By:	19497 AF
Date	1/14/2019

Channel	Frequency (MHz)	Average Power (dBm)
Low	2402	7.20
Middle	2441	7.64
High	2480	6.33

---

### 9.7.3. BLUETOOTH ENHANCED DATA RATE 8PSK MODULATION

Tested By:	19497 AF
Date	1/14/2019

Channel	Frequency (MHz)	Average Power (dBm)
Low	2402	7.23
Middle	2441	7.70
High	2480	6.38

---

## 9.8. CONDUCTED SPURIOUS EMISSIONS

### LIMITS

FCC §15.247 (d)

Limit = -20 dBc

### TEST PROCEDURE

The transmitter output is connected to a spectrum analyzer. The resolution bandwidth is set to 100 kHz. The video bandwidth is set to 300 kHz.

The spectrum from 30 MHz to 26 GHz is investigated with the transmitter set to the lowest, middle, and highest channels.

The band edges at 2.4 and 2.4835 GHz are investigated with the transmitter set to the normal hopping mode.

### RESULTS

### 9.8.1. BLUETOOTH BASIC DATA RATE GFSK MODULATION

#### Antenna 1 SPURIOUS EMISSIONS, NON-HOPPING

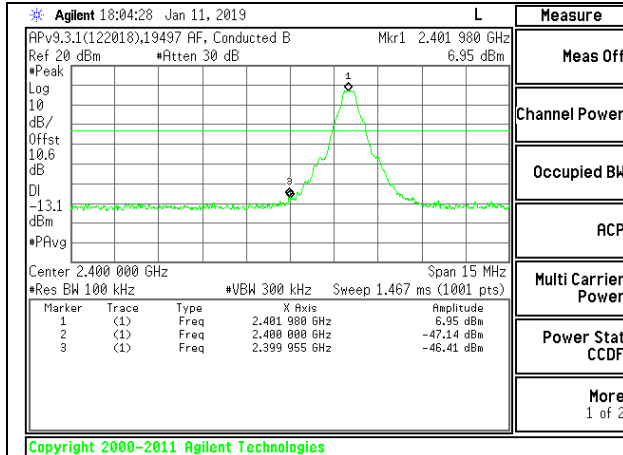

Copyright 2000-2011 Agilent Technologies

#### LOW CHANNEL BANDEDGE

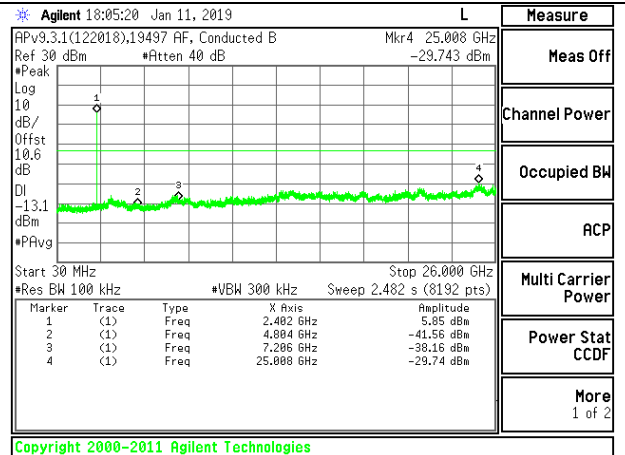

Copyright 2000-2011 Agilent Technologies

#### OUT-OF-BAND LOW CHANNEL

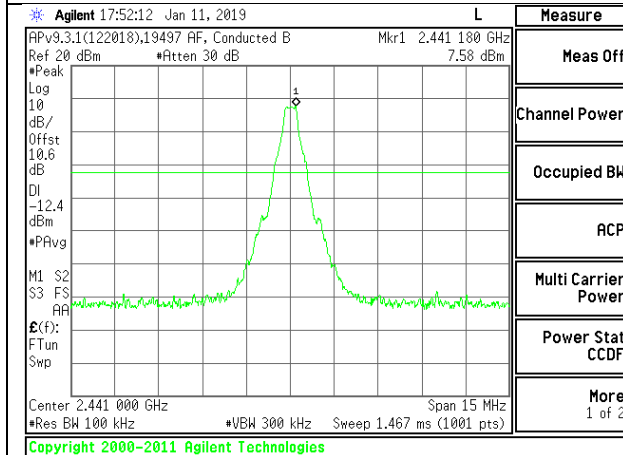

Copyright 2000-2011 Agilent Technologies

#### IN-BAND REFERENCE LEVEL

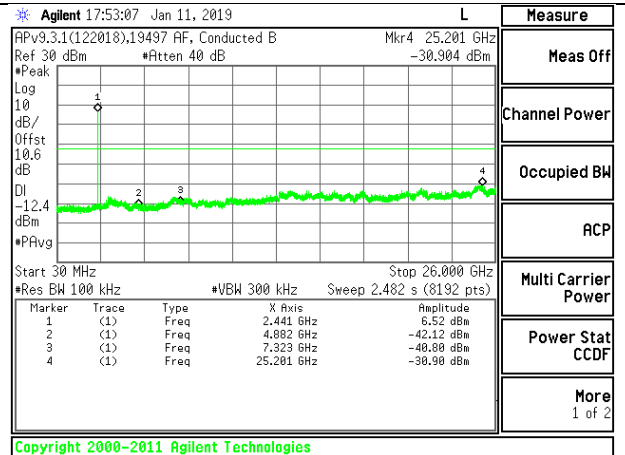

Copyright 2000-2011 Agilent Technologies

#### OUT-OF-BAND MID CHANNEL

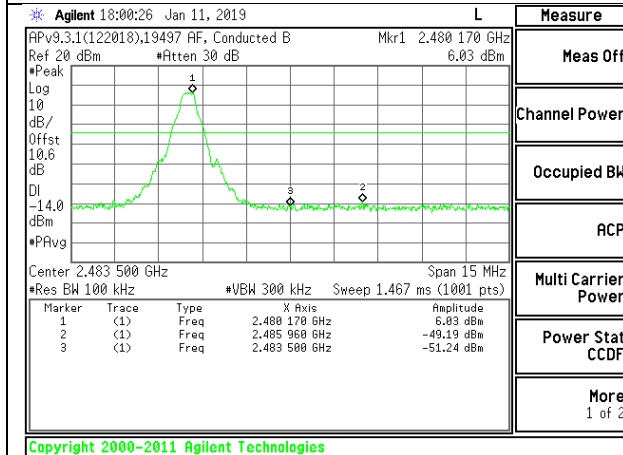

Copyright 2000-2011 Agilent Technologies

#### HIGH CHANNEL BANDEDGE

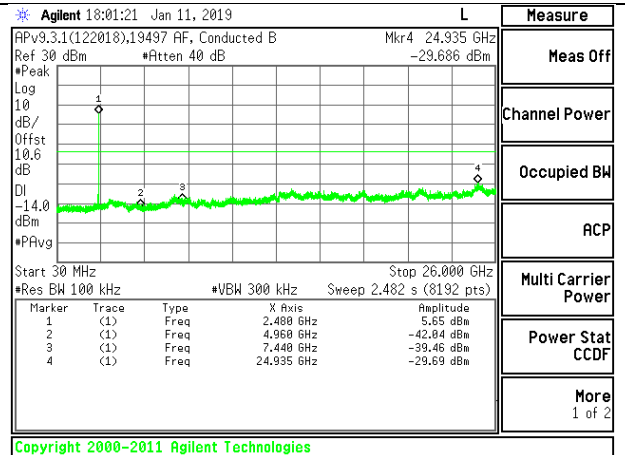

Copyright 2000-2011 Agilent Technologies

#### OUT-OF-BAND HIGH CHANNEL

**Antenna 1 SPURIOUS BANDEDGE EMISSIONS WITH HOPPING ON**

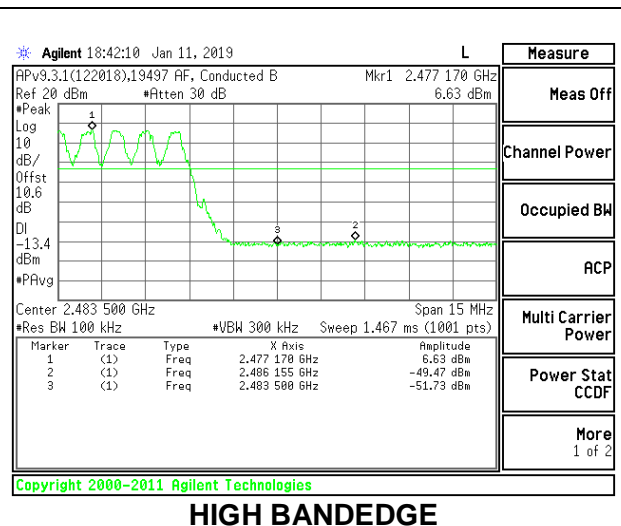
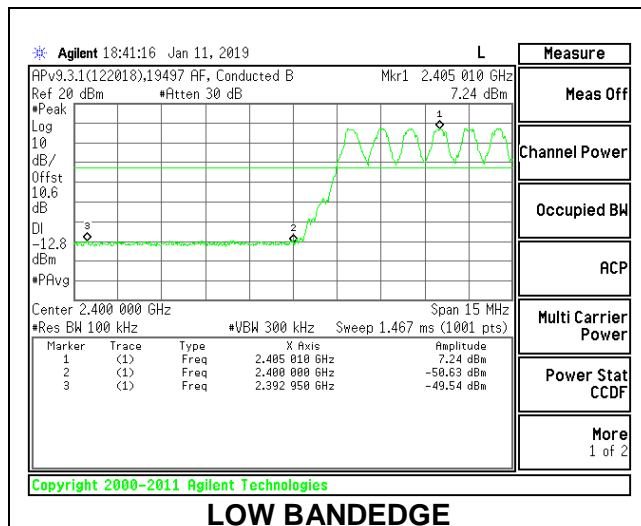



## 9.8.2. BLUETOOTH ENHANCED DATA RATE 8PSK MODULATION

### Antenna 1 SPURIOUS EMISSIONS, NON-HOPPING

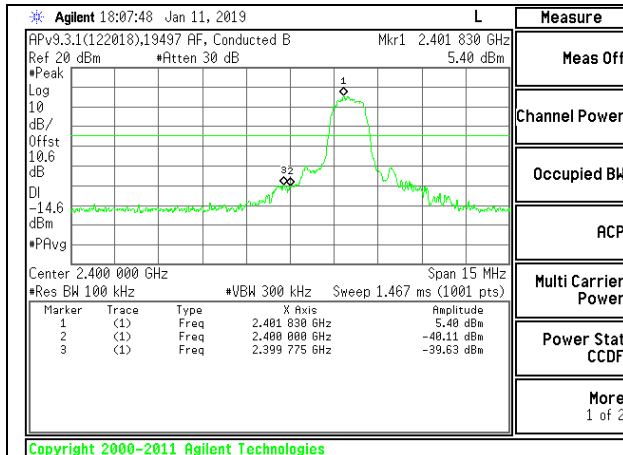

**LOW CHANNEL BANDEDGE**

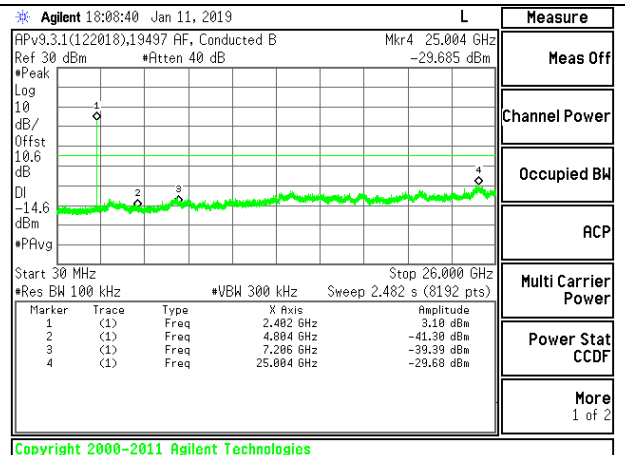

**OUT-OF-BAND LOW CHANNEL**

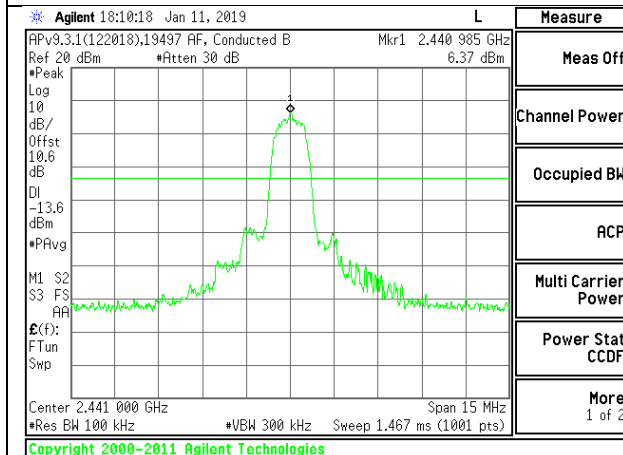

**IN-BAND REFERENCE LEVEL**

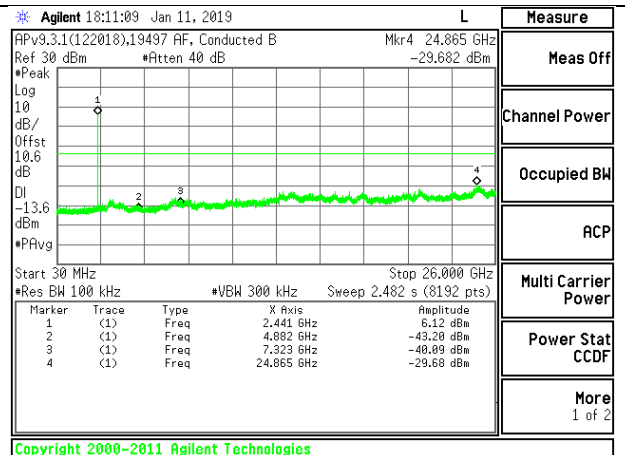

**OUT-OF-BAND MID CHANNEL**

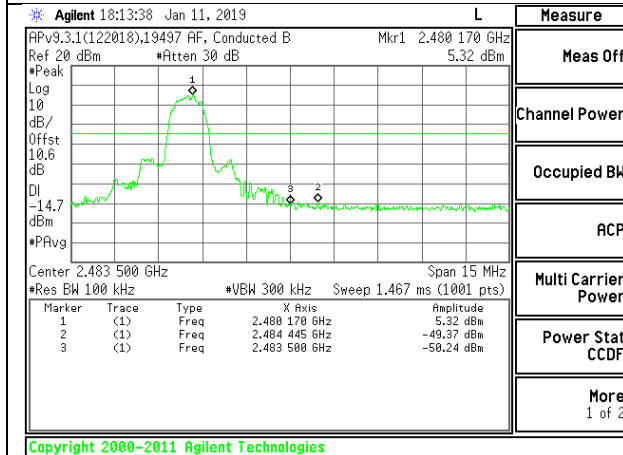

**HIGH CHANNEL BANDEDGE**

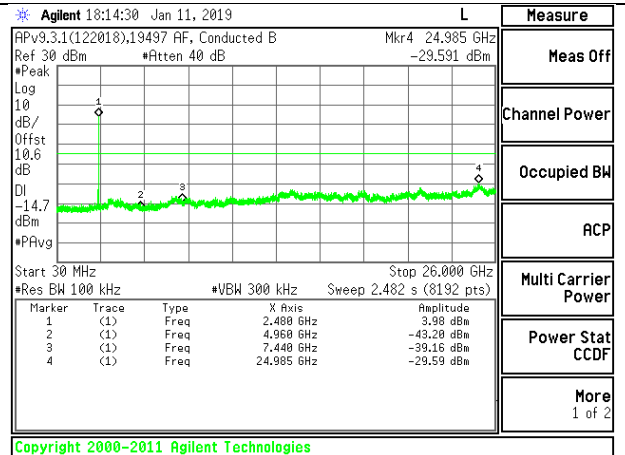

**OUT-OF-BAND HIGH CHANNEL**

**Antenna 1 SPURIOUS BANDEDGE EMISSIONS WITH HOPPING ON**

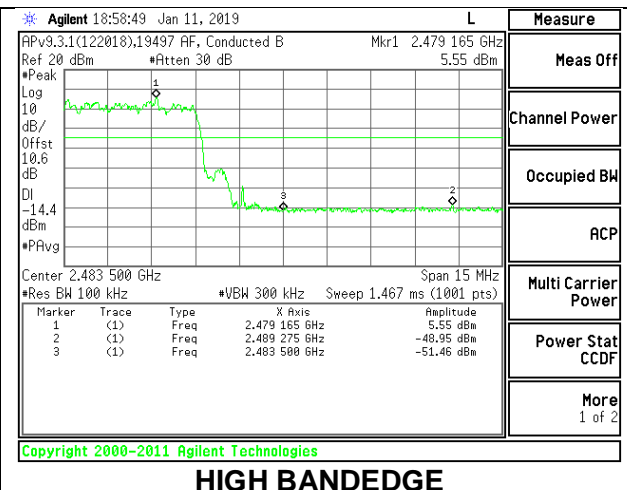
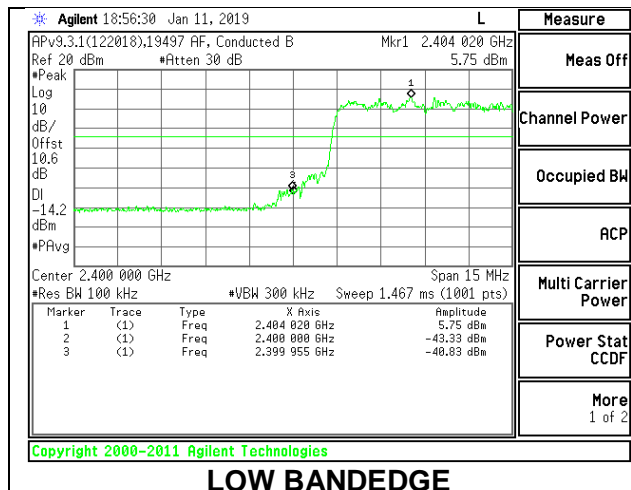

## 10. RADIATED TEST RESULTS

### LIMITS

FCC §15.205 and §15.209

Frequency Range (MHz)	Field Strength Limit (uV/m) at 3 m	Field Strength Limit (dBuV/m) at 3 m
0.009-0.490	2400/F(kHz) @ 300 m	-
0.490-1.705	24000/F(kHz) @ 30 m	-
1.705 - 30	30 @ 30m	-
30 - 88	100	40
88 - 216	150	43.5
216 - 960	200	46
Above 960	500	54

### TEST PROCEDURE

The EUT is placed on a non-conducting table 80 cm above the ground plane for measurement below 1GHz; 1.5 m above the ground plane for measurement above 1GHz. The antenna to EUT distance is 3 meters. The EUT is configured in accordance with ANSI C63.10. The EUT is set to transmit in a continuous mode.

For measurements below 1 GHz the resolution bandwidth is set to 100 kHz for peak detection measurements or 120 kHz for quasi-peak detection measurements. Peak detection is used unless otherwise noted as quasi-peak.

For pre-scans above 1 GHz the resolution bandwidth is set to 1 MHz; the video bandwidth is set to 30 KHz for peak measurements.

For measurements above 1 GHz the resolution bandwidth is set to 1 MHz, then the video bandwidth is set to 3 MHz for peak measurements and 1 MHz resolution bandwidth with 1/T (360Hz) video bandwidth with peak detector for average measurements.

The spectrum from 1 GHz to 18 GHz is investigated with the transmitter set to the lowest, middle, and highest channels in each applicable band. Below 1GHz and above 18GHz emissions, the channel with the highest output power was tested.

The frequency range of interest is monitored at a fixed antenna height and EUT azimuth. The EUT is rotated through 360 degrees to maximize emissions received. The antenna is scanned from 1 to 4 meters above the ground plane to further maximize the emission. Measurements are made with the antenna polarized in both the vertical and the horizontal positions.

2D antenna use - For below 30MHz testing, investigation was done on three antenna orientations (parallel, perpendicular, and ground-parallel), parallel and perpendicular are the worst orientations, therefore testing was performed on these two orientations only.

---

**KDB 414788 OATS and Chamber Correlation Justification**

Base on FCC 15.31 (f) (2): measurements may be performed at a distance closer than that specified in the regulations; however, an attempt should be made to avoid making measurements in the near field.

OATs and chamber correlation testing had been performed and chamber measured test result is the worst case test result.

## 10.1. TRANSMITTER ABOVE 1 GHz

### 10.1.1. BLUETOOTH BASIC DATA RATE GFSK MODULATION

#### BANDEDGE (LOW CHANNEL)

#### HORIZONTAL RESULT

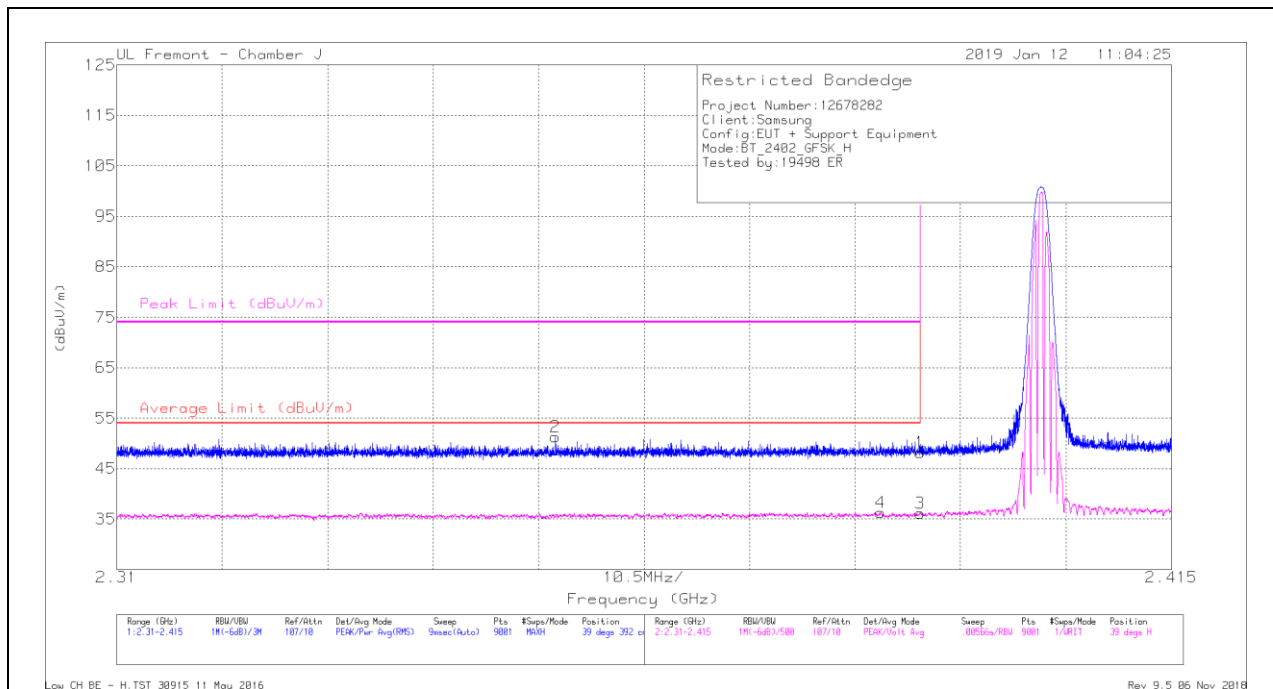

#### Trace Markers

Marker	Frequency (GHz)	Meter Reading (dBuV)	Det	AF AT0067 (dB/m)	Amp/Cbl/Fitr/Pad (dB)	Corrected Reading (dBuV/m)	Average Limit (dBuV/m)	Margin (dB)	Peak Limit (dBuV/m)	PK Margin (dB)	Azimuth (Degs)	Height (cm)	Polarity
1	* 2.39	41.99	Pk	32	-25.8	48.19	-	-	74	-25.81	39	392	H
2	* 2.354	45.2	Pk	31.9	-25.8	51.3	-	-	74	-22.7	39	392	H
3	* 2.39	29.93	VA1T	32	-25.8	36.13	54	-17.87	-	-	39	392	H
4	* 2.386	30.07	VA1T	32	-25.8	36.27	54	-17.73	-	-	39	392	H

\* - indicates frequency in CFR47 Pt 15 / IC RSS-Restricted Band

Pk - Peak detector

VA1T - FHSS: Linear Voltage Average  $V_B=1/T_{on}$  where:  $T_{on}$  is transmit duration

### VERTICAL RESULT

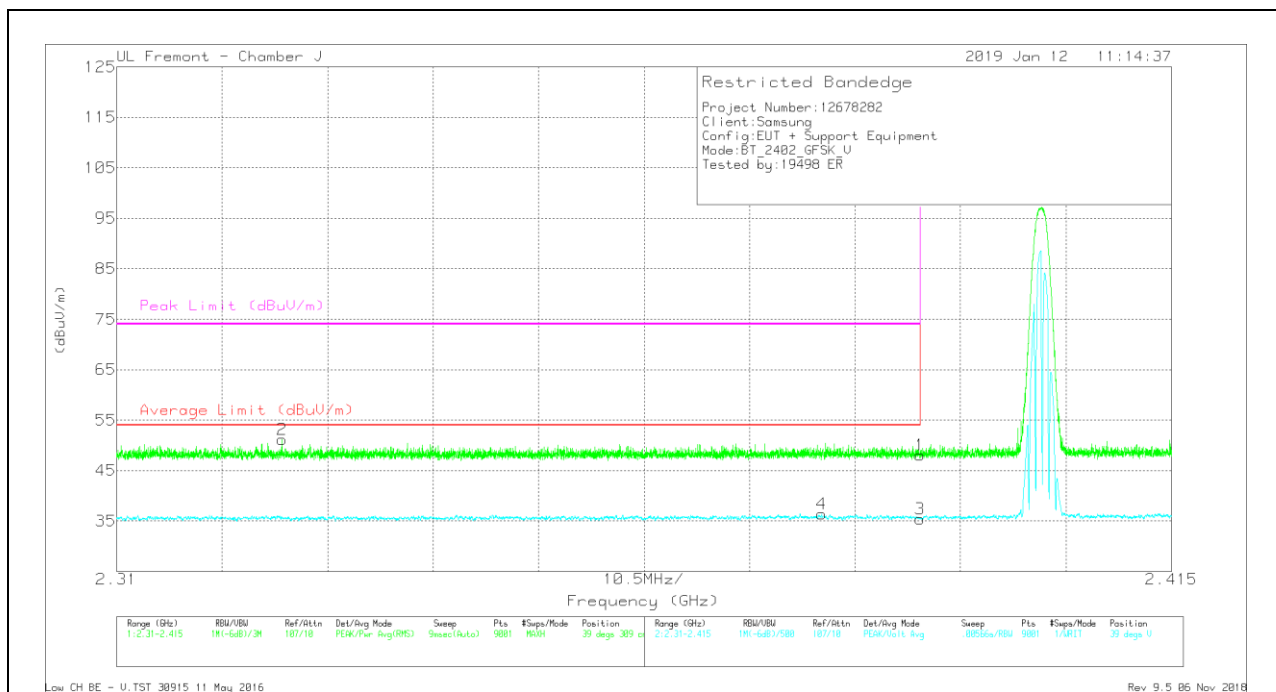

### Trace Markers

Marker	Frequency (GHz)	Meter Reading (dBuV)	Det	AF AT0067 (dB/m)	Amp/Cb/Fitr/Pad (dB)	Corrected Reading (dBuV/m)	Average Limit (dBuV/m)	Margin (dB)	Peak Limit (dBuV/m)	PK Margin (dB)	Azimuth (Degs)	Height (cm)	Polarity
1	* 2.39	41.89	Pk	32	-25.8	48.09	-	-	74	-25.91	39	309	V
2	* 2.326	45.09	Pk	31.9	-25.8	51.19	-	-	74	-22.81	39	309	V
3	* 2.39	29.18	VA1T	32	-25.8	35.38	54	-18.62	-	-	39	309	V
4	* 2.38	30.15	VA1T	32	-25.8	36.35	54	-17.65	-	-	39	309	V

\* - indicates frequency in CFR47 Pt 15 / IC RSS-Restricted Band

Pk - Peak detector

VA1T - FHSS: Linear Voltage Average VB=1/Ton where: Ton is transmit duration

**BANEDGE (HIGH CHANNEL)**

**HORIZONTAL RESULT**

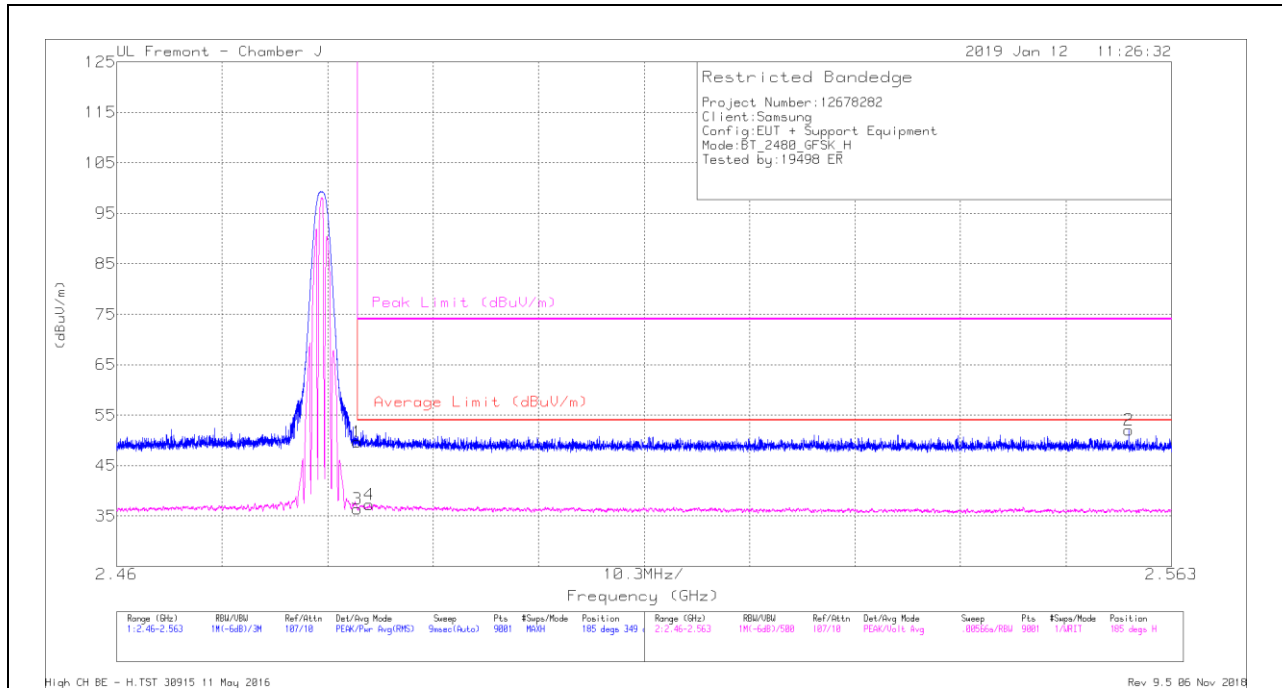

**Trace Markers**

Marker	Frequency (GHz)	Meter Reading (dBuV)	Det	AF AT0067 (dB/m)	Amp/Cb/Filtr/Pad (dB)	Corrected Reading (dBuV/m)	Average Limit (dBuV/m)	Margin (dB)	Peak Limit (dBuV/m)	PK Margin (dB)	Azimuth (Degs)	Height (cm)	Polarity
1	* 2.484	42.97	Pk	32.5	-25.8	49.67	-	-	74	-24.33	185	349	H
2	2.559	45.11	Pk	32.5	-25.6	52.01	-	-	74	-21.99	185	349	H
3	* 2.484	29.72	VA1T	32.5	-25.8	36.42	54	-17.58	-	-	185	349	H
4	* 2.485	30.54	VA1T	32.5	-25.8	37.24	54	-16.76	-	-	185	349	H

\* - indicates frequency in CFR47 Pt 15 / IC RSS-Restricted Band

Pk - Peak detector

VA1T - FHSS: Linear Voltage Average VB=1/Ton where: Ton is transmit duration

### VERTICAL RESULT

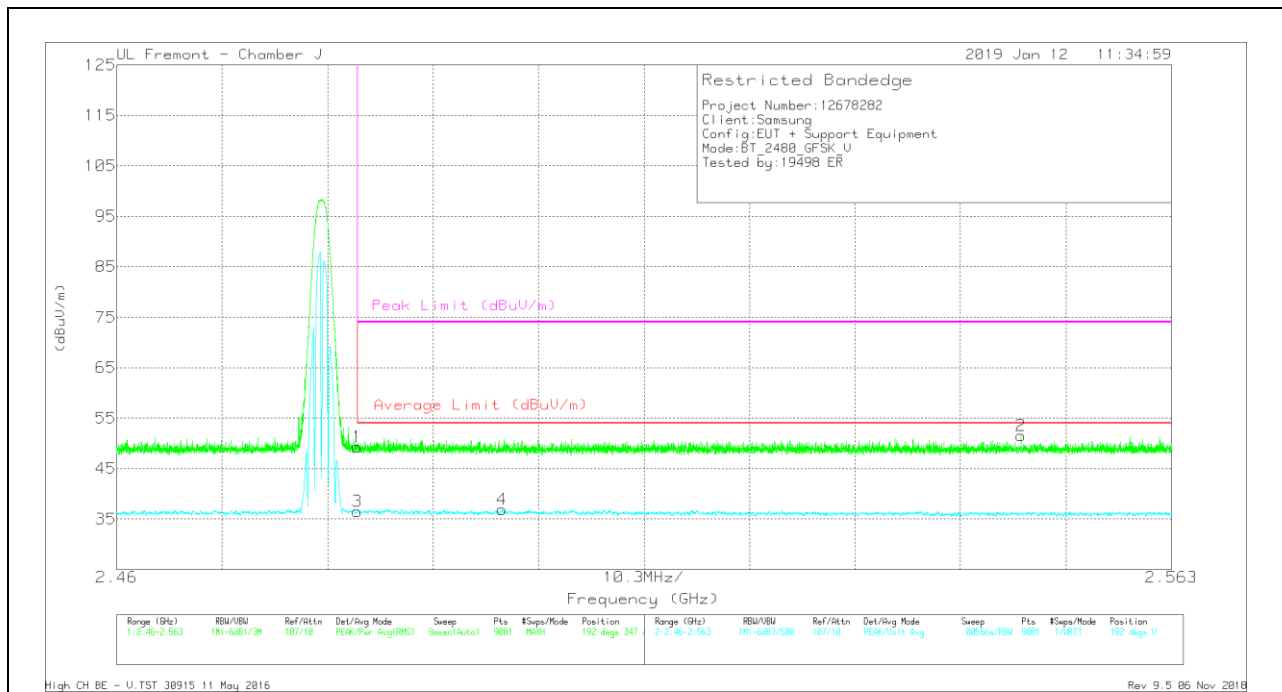

### Trace Markers

Marker	Frequency (GHz)	Meter Reading (dBuV)	Det	AF AT0067 (dB/m)	Amp/Cb/Fitr/Pad (dB)	Corrected Reading (dBuV/m)	Average Limit (dBuV/m)	Margin (dB)	Peak Limit (dBuV/m)	PK Margin (dB)	Azimuth (Degs)	Height (cm)	Polarity
1	* 2.484	42.57	Pk	32.5	-25.8	49.27	-	-	74	-24.73	192	347	V
2	2.548	44.76	Pk	32.5	-25.7	51.56	-	-	74	-22.44	192	347	V
3	* 2.484	29.81	VA1T	32.5	-25.8	36.51	54	-17.49	-	-	192	347	V
4	* 2.498	30.13	VA1T	32.5	-25.7	36.93	54	-17.07	-	-	192	347	V

\* - indicates frequency in CFR47 Pt 15 / IC RSS-Restricted Band

Pk - Peak detector

VA1T - FHSS: Linear Voltage Average  $V_B = 1/T_{on}$  where:  $T_{on}$  is transmit duration



**HARMONICS AND SPURIOUS EMISSIONS**

**LOW CHANNEL RESULTS**

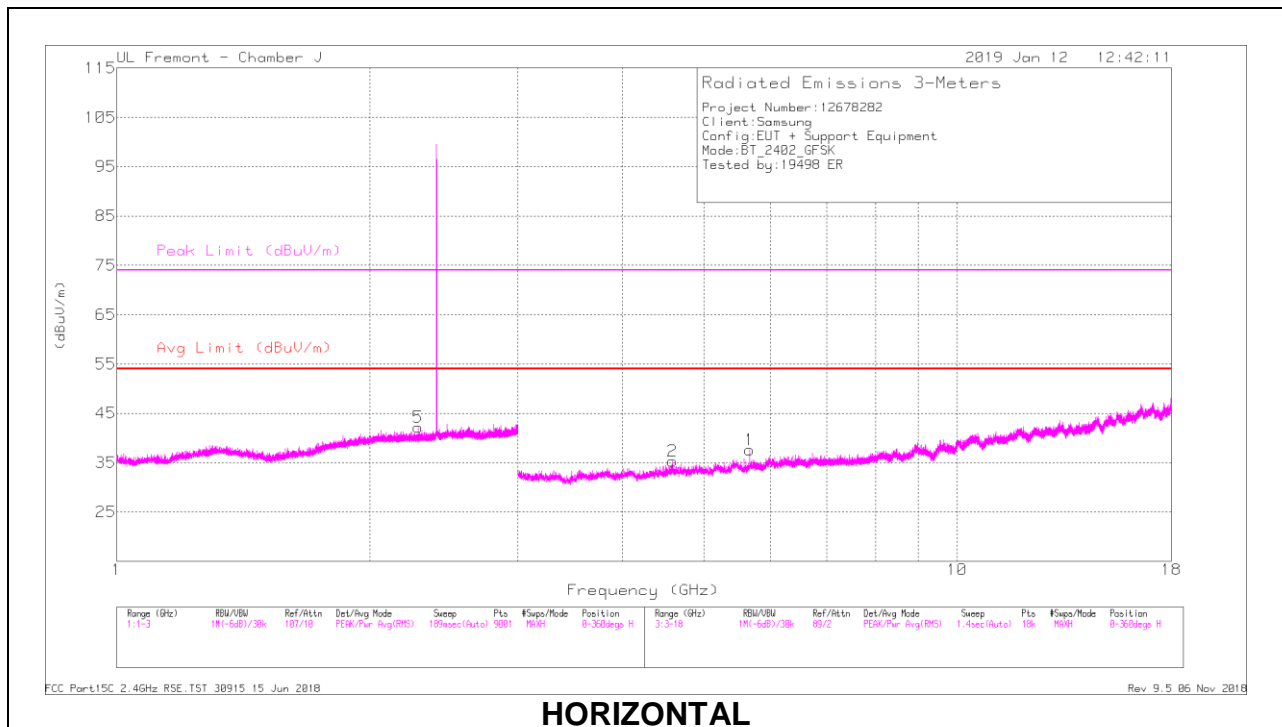

**HORIZONTAL**

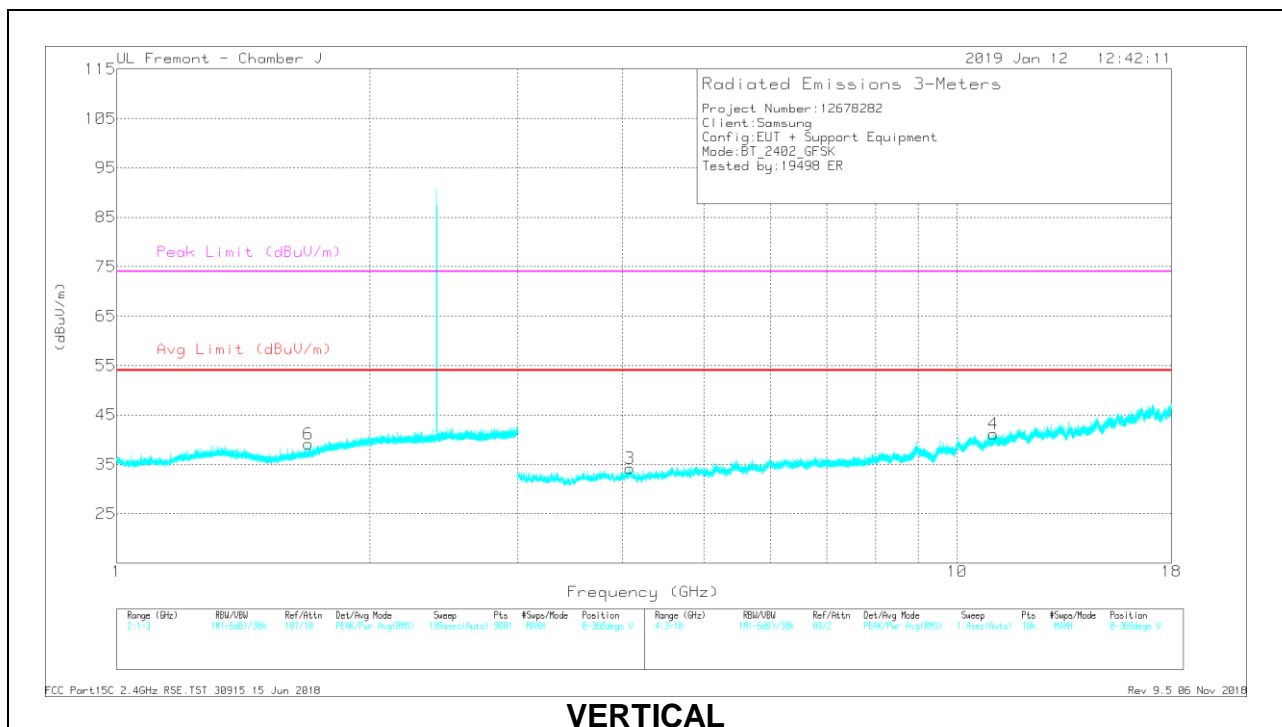

**VERTICAL**

**RADIATED EMISSIONS**

Marker	Frequency (GHz)	Meter Reading (dBuV)	Det	AF AT0067 (dB/m)	Amp/Cb/Filtr/Pad (dB)	Corrected Reading (dBuV/m)	Avg Limit (dBuV/m)	Margin (dB)	Peak Limit (dBuV/m)	PK Margin (dB)	Azimuth (Degs)	Height (cm)	Polarity
5	* 2.283	42.01	PKFH	31.9	-25.8	48.11	-	-	74	-25.89	182	175	H
	* 2.282	29.91	VA1T	31.9	-25.8	36.01	54	-17.99	-	-	182	175	H
6	* 1.692	42.34	PKFH	29	-26	45.34	-	-	74	-28.66	265	155	V
	* 1.691	29.85	VA1T	29	-26.1	32.75	54	-21.25	-	-	265	155	V
2	* 4.587	39.27	PKFH	34.2	-31.4	42.07	-	-	74	-31.93	338	122	H
	* 4.587	26.56	VA1T	34.2	-31.4	29.36	54	-24.64	-	-	338	122	H
1	5.669	38.62	PKFH	34.6	-30.3	42.92	-	-	-	-	340	282	H
	5.669	28.72	VA1T	34.6	-30.3	33.02	-	-	-	-	340	282	H
3	* 4.079	39.81	PKFH	33.6	-31.7	41.71	-	-	74	-32.29	316	196	V
	* 4.082	27.04	VA1T	33.6	-31.7	28.94	54	-25.06	-	-	316	196	V
4	* 11.045	33.24	PKFH	37.8	-23.5	47.54	-	-	74	-26.46	126	174	V
	* 11.046	21.4	VA1T	37.8	-23.5	35.7	54	-18.3	-	-	126	174	V

\* - indicates frequency in CFR47 Pt 15 / IC RSS-Restricted Band

PKFH - FHSS: RB=100k/1MHz VB=3 x RB, Peak

VA1T - FHSS: Linear Voltage Average VB=1/Ton where: Ton is transmit duration

### MID CHANNEL RESULTS

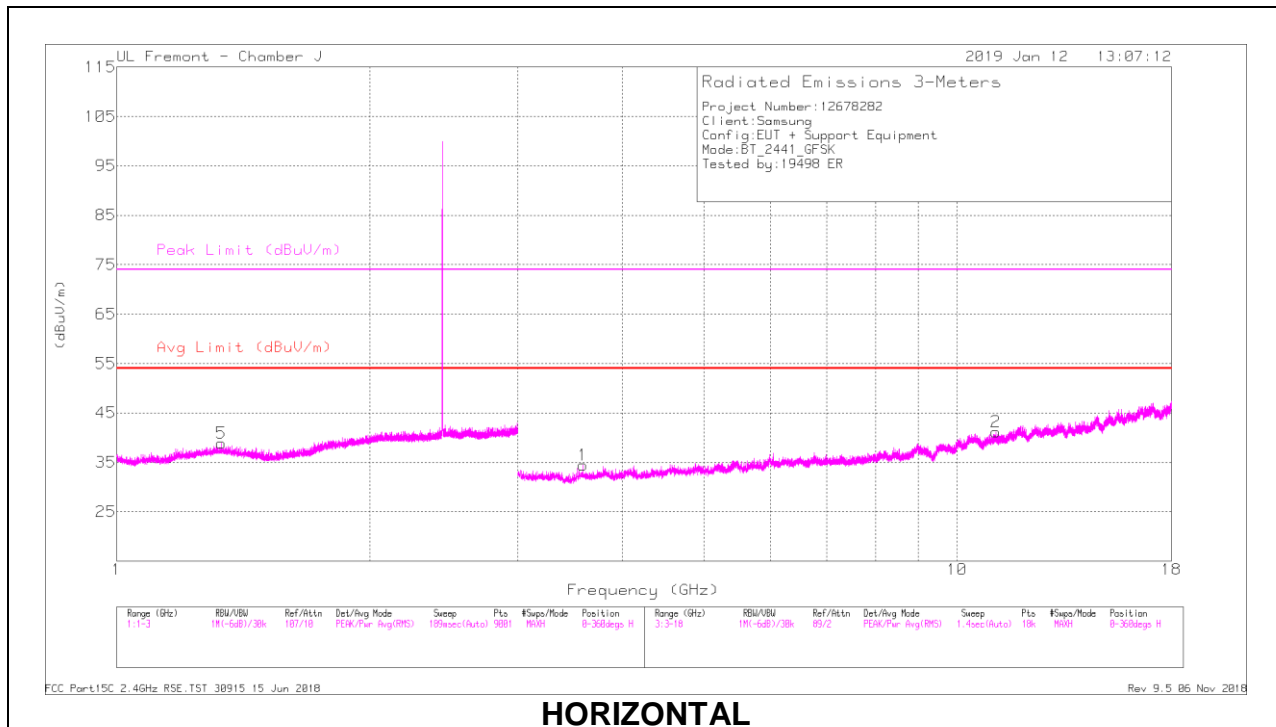

**HORIZONTAL**

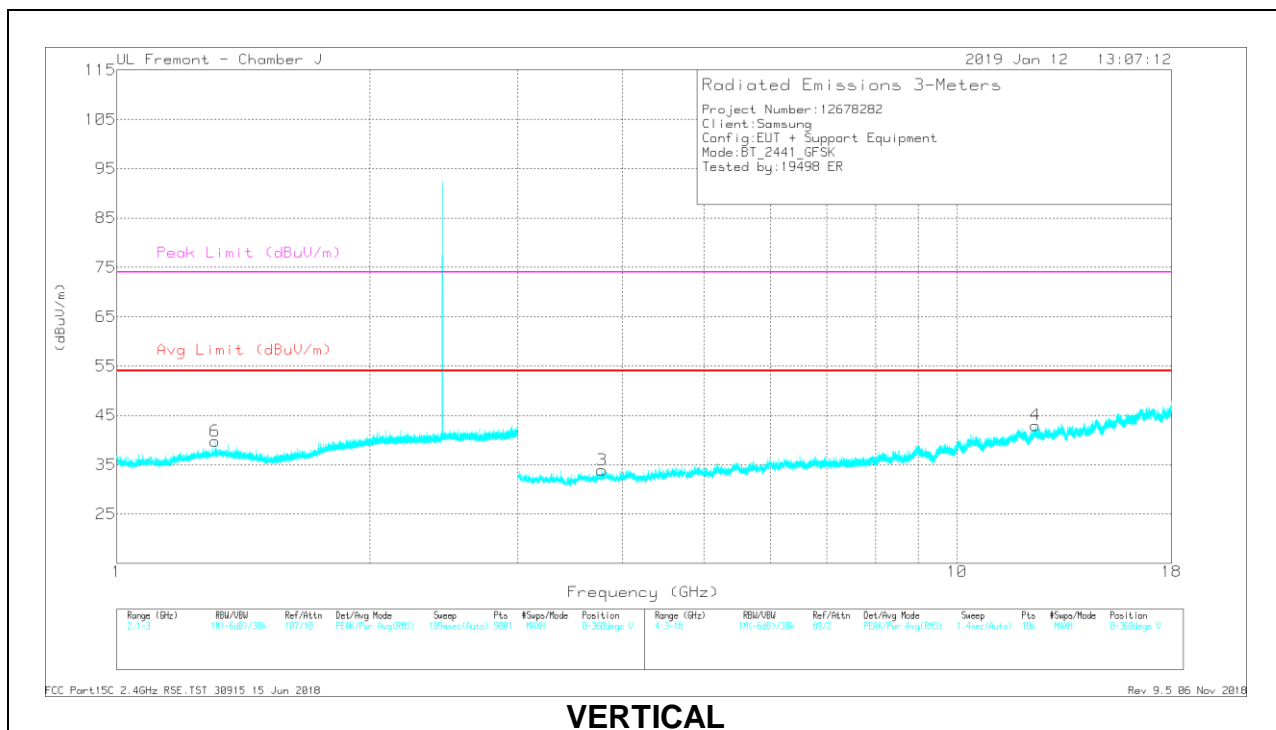

**VERTICAL**

**RADIATED EMISSIONS**

Marker	Frequency (GHz)	Meter Reading (dBuV)	Det	AF AT0067 (dB/m)	Amp/Cbl/Filtr/Pad (dB)	Corrected Reading (dBuV/m)	Avg Limit (dBuV/m)	Margin (dB)	Peak Limit (dBuV/m)	PK Margin (dB)	Azimuth (Degs)	Height (cm)	Polarity
5	* 1.333	42.59	PKFH	29.3	-26.1	45.79	-	-	74	-28.21	222	282	H
	* 1.333	29.93	VA1T	29.3	-26	33.23	54	-20.77	-	-	222	282	H
6	* 1.308	42.74	PKFH	29.3	-26.1	45.94	-	-	74	-28.06	139	241	V
	* 1.309	29.84	VA1T	29.3	-26.1	33.04	54	-20.96	-	-	139	241	V
1	* 3.588	40.96	PKFH	33	-33.1	40.86	-	-	74	-33.14	27	186	H
	* 3.589	28.23	VA1T	33	-33.1	28.13	54	-25.87	-	-	27	186	H
2	* 11.134	33.76	PKFH	37.8	-23.4	48.16	-	-	74	-25.84	296	123	H
	* 11.133	21.19	VA1T	37.8	-23.4	35.59	54	-18.41	-	-	296	123	H
3	* 3.78	40.46	PKFH	33.4	-33	40.86	-	-	74	-33.14	182	165	V
	* 3.782	27.99	VA1T	33.4	-32.9	28.49	54	-25.51	-	-	182	165	V
4	* 12.393	32.71	PKFH	38.8	-22.2	49.31	-	-	74	-24.69	90	215	V
	* 12.393	20.47	VA1T	38.8	-22.2	37.07	54	-16.93	-	-	90	215	V

\* - indicates frequency in CFR47 Pt 15 / IC RSS-Restricted Band

PKFH - FHSS: RB=100k/1MHz VB=3 x RB, Peak

VA1T - FHSS: Linear Voltage Average VB=1/Ton where: Ton is transmit duration

### HIGH CHANNEL RESULTS

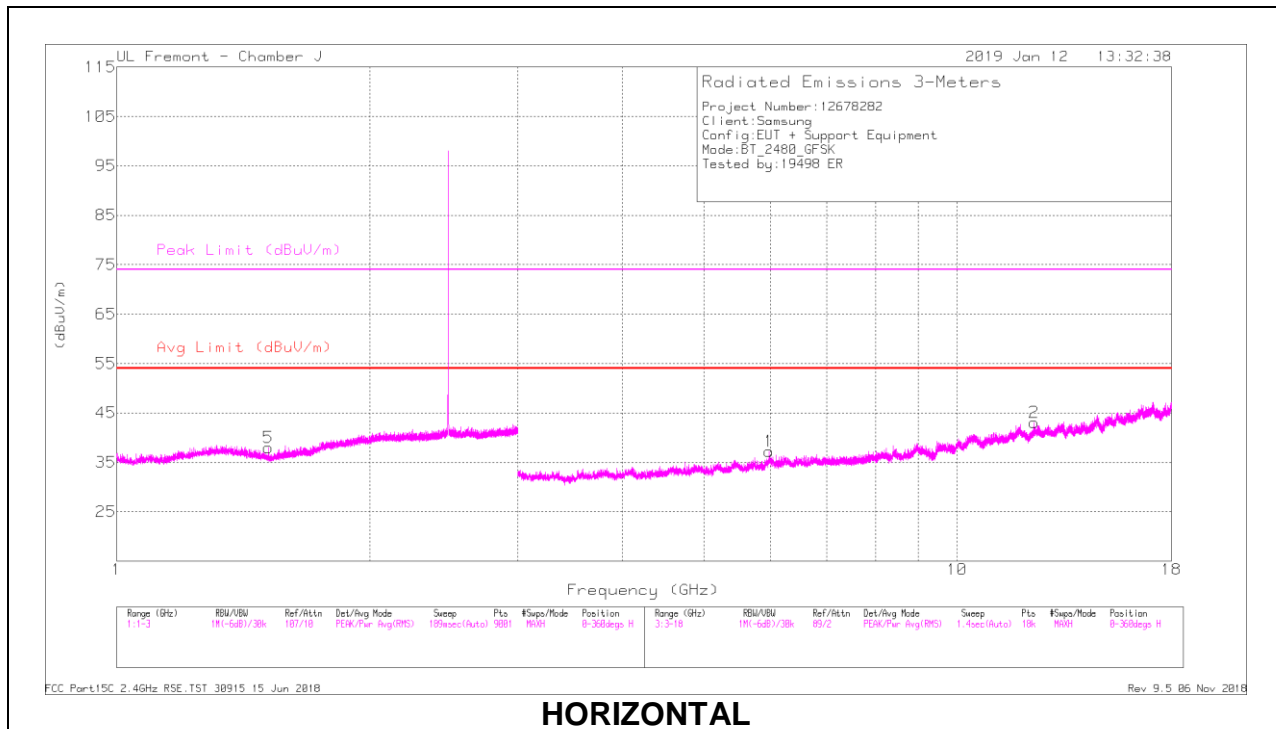

**HORIZONTAL**

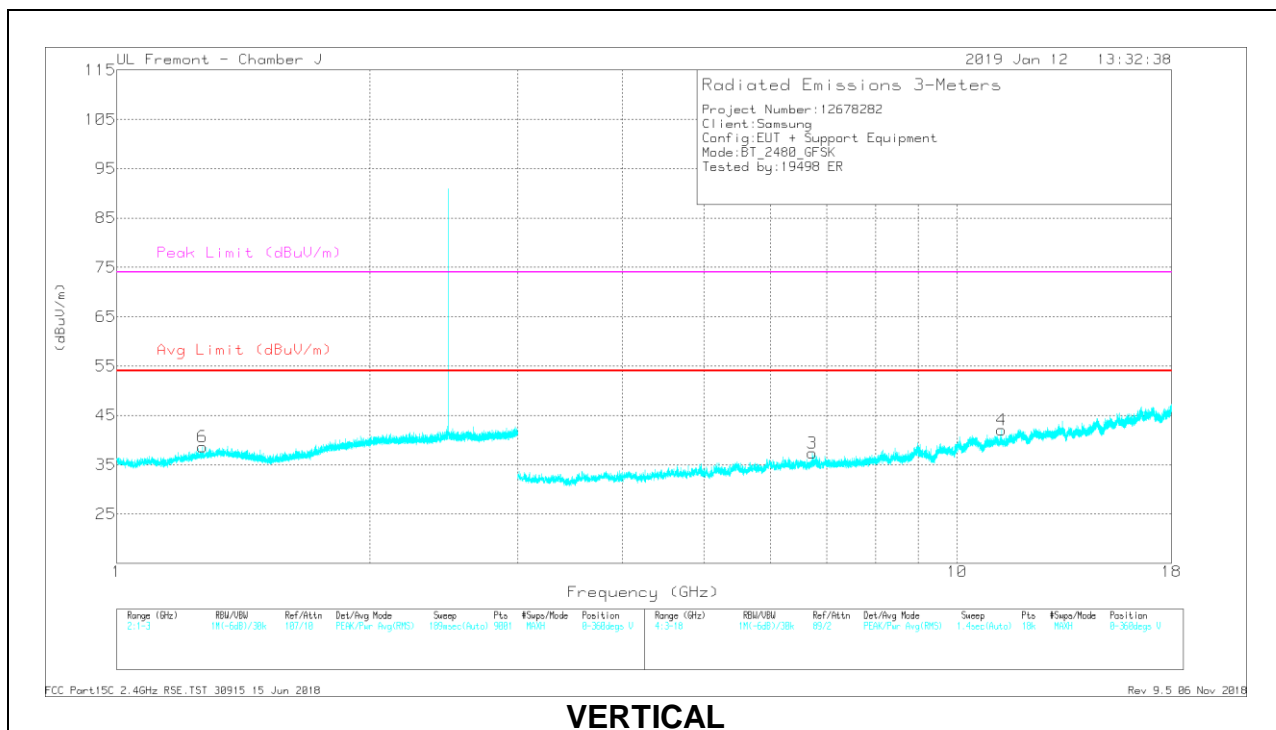

**VERTICAL**

**RADIATED EMISSIONS**

Marker	Frequency (GHz)	Meter Reading (dBuV)	Det	AF AT0067 (dB/m)	Amp/Cbl/Filtr/Pad (dB)	Corrected Reading (dBuV/m)	Avg Limit (dBuV/m)	Margin (dB)	Peak Limit (dBuV/m)	PK Margin (dB)	Azimuth (Degs)	Height (cm)	Polarity
5	* 1.517	41.85	PKFH	28	-26.1	43.75	-	-	74	-30.25	300	272	H
	* 1.515	29.74	VA1T	28	-26.1	31.64	54	-22.36	-	-	300	272	H
6	* 1.266	42.48	PKFH	29.1	-26	45.58	-	-	74	-28.42	134	239	V
	* 1.266	29.75	VA1T	29.1	-26	32.85	54	-21.15	-	-	134	239	V
1	* 12.349	33.56	PKFH	38.8	-22.2	50.16	-	-	74	-23.84	37	183	H
	* 12.349	19.96	VA1T	38.8	-22.2	36.56	54	-17.44	-	-	37	183	H
2	5.98	37.21	PKFH	35.1	-28.3	44.01	-	-	-	-	217	298	H
	5.98	26.92	VA1T	35.1	-28.3	33.72	-	-	-	-	217	298	H
4	* 11.304	32.84	PKFH	38	-23	47.84	-	-	74	-26.16	171	141	V
	* 11.306	20.61	VA1T	38	-23	35.61	54	-18.39	-	-	171	141	V
3	6.732	35.71	PKFH	35.6	-27.8	43.51	-	-	-	-	306	327	V
	6.732	26.31	VA1T	35.6	-27.8	34.11	-	-	-	-	306	327	V

\* - indicates frequency in CFR47 Pt 15 / IC RSS-Restricted Band

PKFH - FHSS: RB=100k/1MHz VB=3 x RB, Peak

VA1T - FHSS: Linear Voltage Average VB=1/Ton where: Ton is transmit duration

## 10.1.2. BLUETOOTH ENHANCED DATA RATE 8PSK MODULATION

### BANDEDGE (LOW CHANNEL)

### HORIZONTAL RESULT

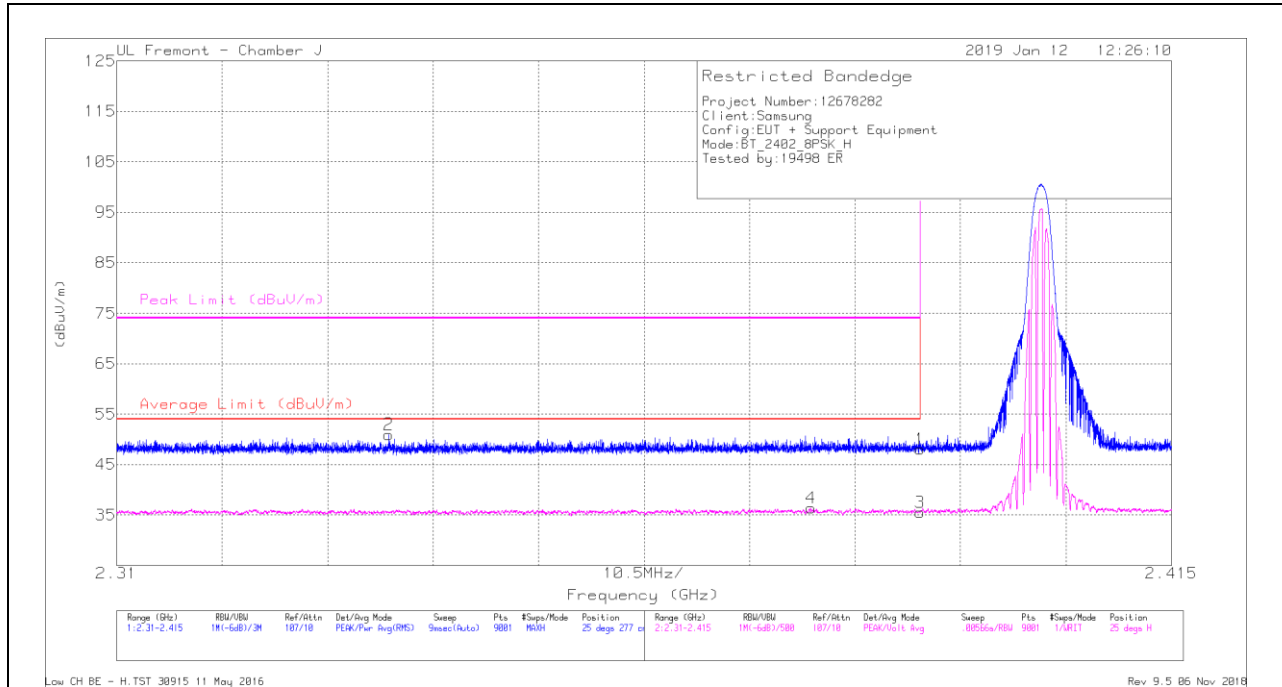

### Trace Markers

Marker	Frequency (GHz)	Meter Reading (dBuV)	Det	AF AT0067 (dB/m)	Amp/Cb/Fitr /Pad (dB)	Corrected Reading (dBuV/m)	Average Limit (dBuV/m)	Margin (dB)	Peak Limit (dBuV/m)	PK Margin (dB)	Azimuth (Degs)	Height (cm)	Polarity
1	* 2.39	41.9	Pk	32	-25.8	48.1	-	-	74	-25.9	25	277	H
2	* 2.337	44.87	Pk	31.9	-25.8	50.97	-	-	74	-23.03	25	277	H
3	* 2.39	29.28	VA1T	32	-25.8	35.48	54	-18.52	-	-	25	276	H
4	* 2.379	30.21	VA1T	32	-25.8	36.41	54	-17.59	-	-	25	276	H

\* - indicates frequency in CFR47 Pt 15 / IC RSS-Restricted Band

Pk - Peak detector

VA1T - FHSS: Linear Voltage Average VB=1/Ton where: Ton is transmit duration

### VERTICAL RESULT

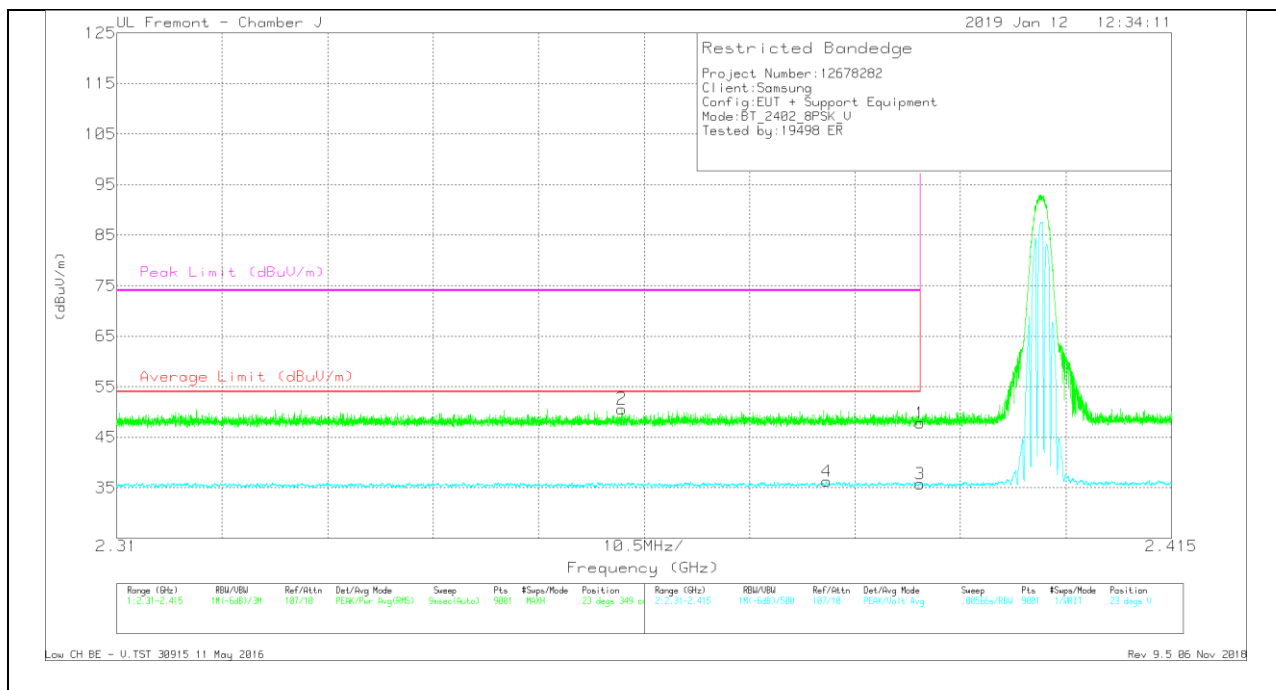

### Trace Markers

Marker	Frequency (GHz)	Meter Reading (dBuV)	Det	AF AT0067 (dB/m)	Amp/Cb/Filt /Pad (dB)	Corrected Reading (dBuV/m)	Average Limit (dBuV/m)	Margin (dB)	Peak Limit (dBuV/m)	PK Margin (dB)	Azimuth (Degs)	Height (cm)	Polarity
1	* 2.39	41.56	Pk	32	-25.8	47.76	-	-	74	-26.24	23	349	V
2	* 2.36	44.5	Pk	31.9	-25.8	50.6	-	-	74	-23.4	23	349	V
3	* 2.39	29.56	VA1T	32	-25.8	35.76	54	-18.24	-	-	23	349	V
4	* 2.381	30.11	VA1T	32	-25.8	36.31	54	-17.69	-	-	23	349	V

\* - indicates frequency in CFR47 Pt 15 / IC RSS-Restricted Band

Pk - Peak detector

VA1T - FHSS: Linear Voltage Average VB=1/Ton where: Ton is transmit duration



**BANEDGE (HIGH CHANNEL)**

**HORIZONTAL RESULT**

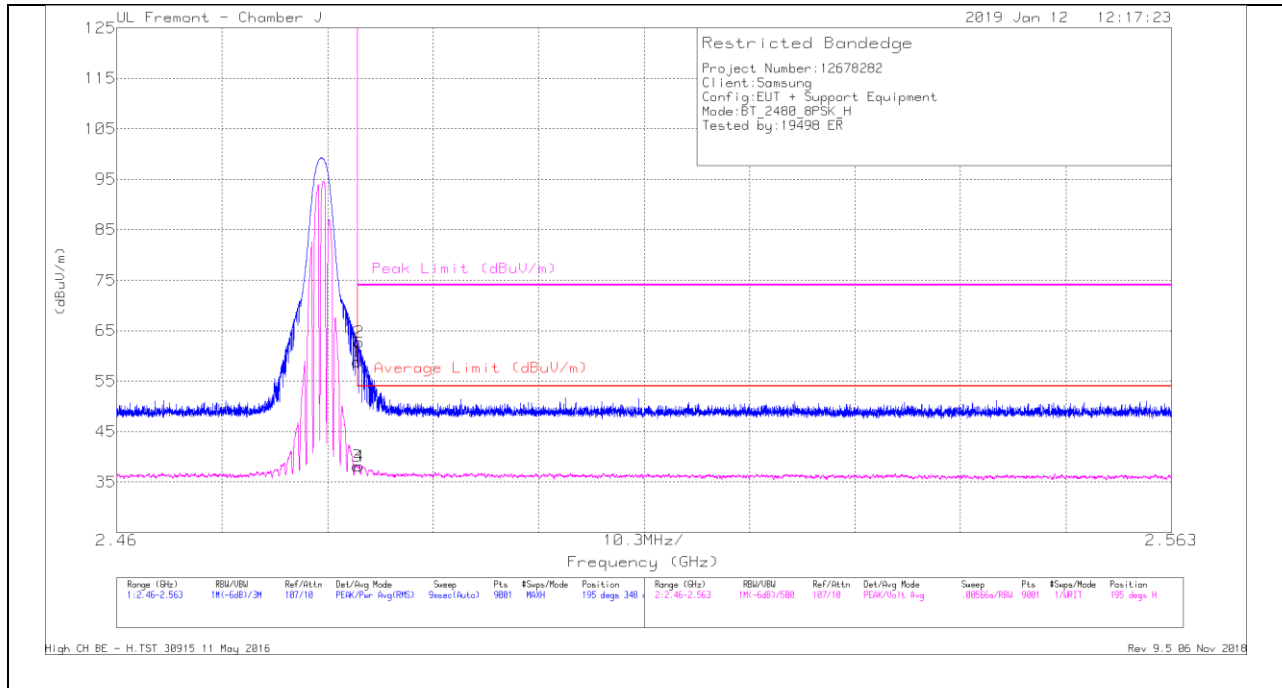

**Trace Markers**

Marker	Frequency (GHz)	Meter Reading (dBuV)	Det	AF AT0067 (dB/m)	Amp/Cb/Filtr /Pad (dB)	Corrected Reading (dBuV/m)	Average Limit (dBuV/m)	Margin (dB)	Peak Limit (dBuV/m)	PK Margin (dB)	Azimuth (Degs)	Height (cm)	Polarity
1	* 2.484	52.2	Pk	32.5	-25.8	58.9	-	-	74	-15.1	195	348	H
2	* 2.484	55.98	Pk	32.5	-25.8	62.68	-	-	74	-11.32	195	348	H
3	* 2.484	31.47	VA1T	32.5	-25.8	38.17	54	-15.83	-	-	195	348	H
4	* 2.484	31.42	VA1T	32.5	-25.8	38.12	54	-15.88	-	-	195	348	H

\* - indicates frequency in CFR47 Pt 15 / IC RSS-Restricted Band

Pk - Peak detector

VA1T - FHSS: Linear Voltage Average VB=1/Ton where: Ton is transmit duration

### VERTICAL RESULT

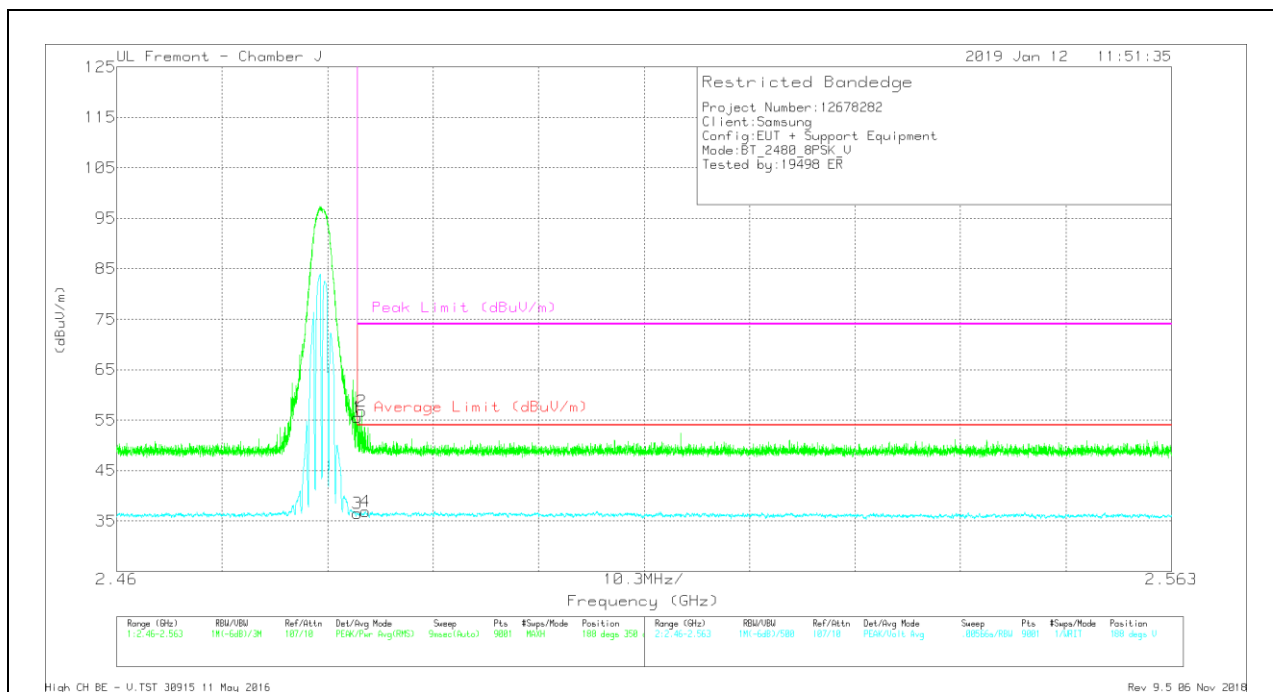

### Trace Markers

Marker	Frequency (GHz)	Meter Reading (dBuV)	Det	AF AT0067 (dB/m)	Amp/CbW/Fir /Pad (dB)	Corrected Reading (dBuV/m)	Average Limit (dBuV/m)	Margin (dB)	Peak Limit (dBuV/m)	PK Margin (dB)	Azimuth (Degs)	Height (cm)	Polarity
1	* 2.484	48.76	Pk	32.5	-25.8	55.46	-	-	74	-18.54	188	350	V
2	* 2.484	50.03	Pk	32.5	-25.8	56.73	-	-	74	-17.27	188	350	V
3	* 2.484	29.77	VA1T	32.5	-25.8	36.47	54	-17.53	-	-	188	350	V
4	* 2.484	30.21	VA1T	32.5	-25.8	36.91	54	-17.09	-	-	188	350	V

\* - indicates frequency in CFR47 Pt 15 / IC RSS-Restricted Band

Pk - Peak detector

VA1T - FHSS: Linear Voltage Average VB=1/Ton where: Ton is transmit duration

**HARMONICS AND SPURIOUS EMISSIONS**

**LOW CHANNEL RESULTS**

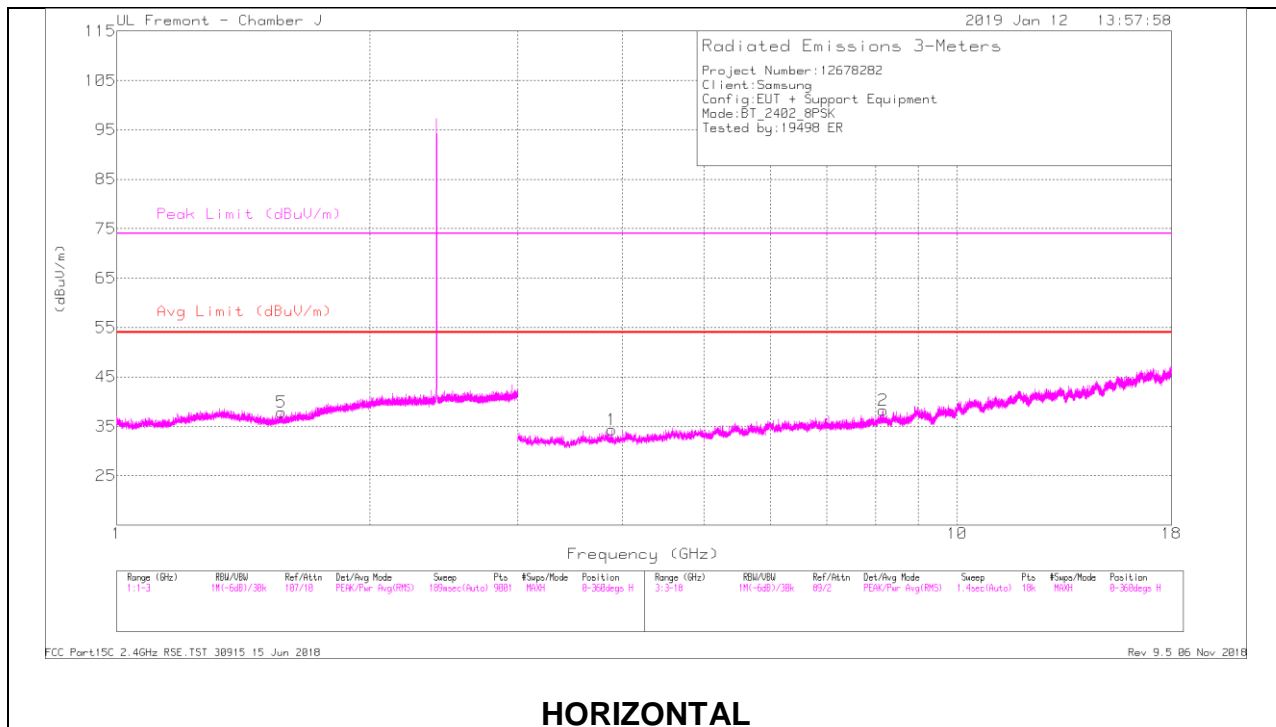

**HORIZONTAL**

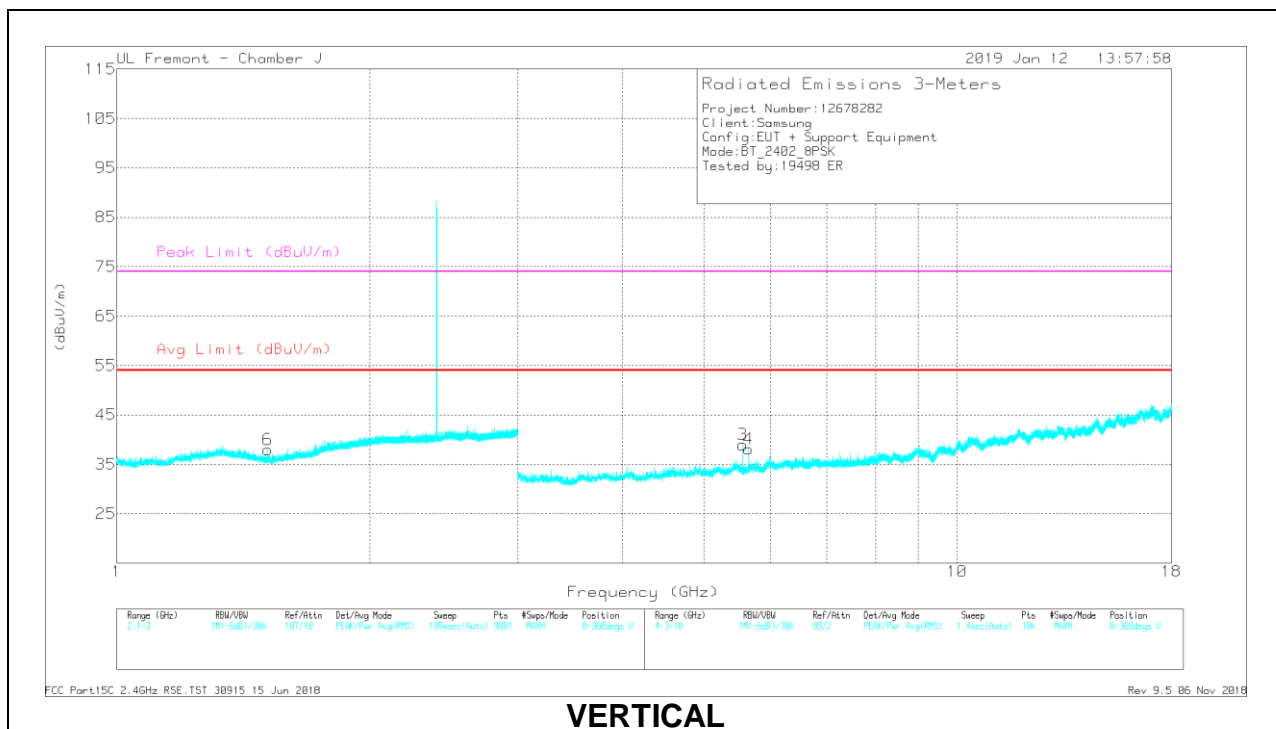

**VERTICAL**

**RADIATED EMISSIONS**

Frequency (GHz)	Meter Reading (dBuV)	Det	AF AT0067 (dB/m)	Amp/Cb/Fit r/Pad (dB)	Corrected Reading (dBuV/m)	Avg Limit (dBuV/m)	Margin (dB)	Peak Limit (dBuV/m)	PK Margin (dB)	Azimuth (Degs)	Height (cm)	Polarity
* 1.57	42.24	PKFH	28.3	-26.1	44.44	-	-	74	-29.56	221	124	H
* 1.572	29.89	VA1T	28.3	-26.1	32.09	54	-21.91	-	-	221	124	H
* 1.513	42.35	PKFH	28	-26.1	44.25	-	-	74	-29.75	97	141	V
* 1.512	29.82	VA1T	28	-26.1	31.72	54	-22.28	-	-	97	141	V
* 3.886	39.86	PKFH	33.5	-32.5	40.86	-	-	74	-33.14	26	186	H
* 3.886	26.99	VA1T	33.5	-32.5	27.99	54	-26.01	-	-	26	186	H
* 8.17	36.64	PKFH	35.7	-26.7	45.64	-	-	74	-28.36	232	238	H
* 8.171	23.37	VA1T	35.7	-26.6	32.47	54	-21.53	-	-	232	238	H
5.561	38.06	PKFH	34.6	-30	42.66	-	-	-	-	238	361	V
5.65	37.71	PKFH	34.6	-30.7	41.61	-	-	-	-	303	284	V

\* - indicates frequency in CFR47 Pt 15 / IC RSS-Restricted Band

PKFH - FHSS: RB=100k/1MHz VB=3 x RB, Peak

VA1T - FHSS: Linear Voltage Average VB=1/Ton where: Ton is transmit duration

### MID CHANNEL RESULTS

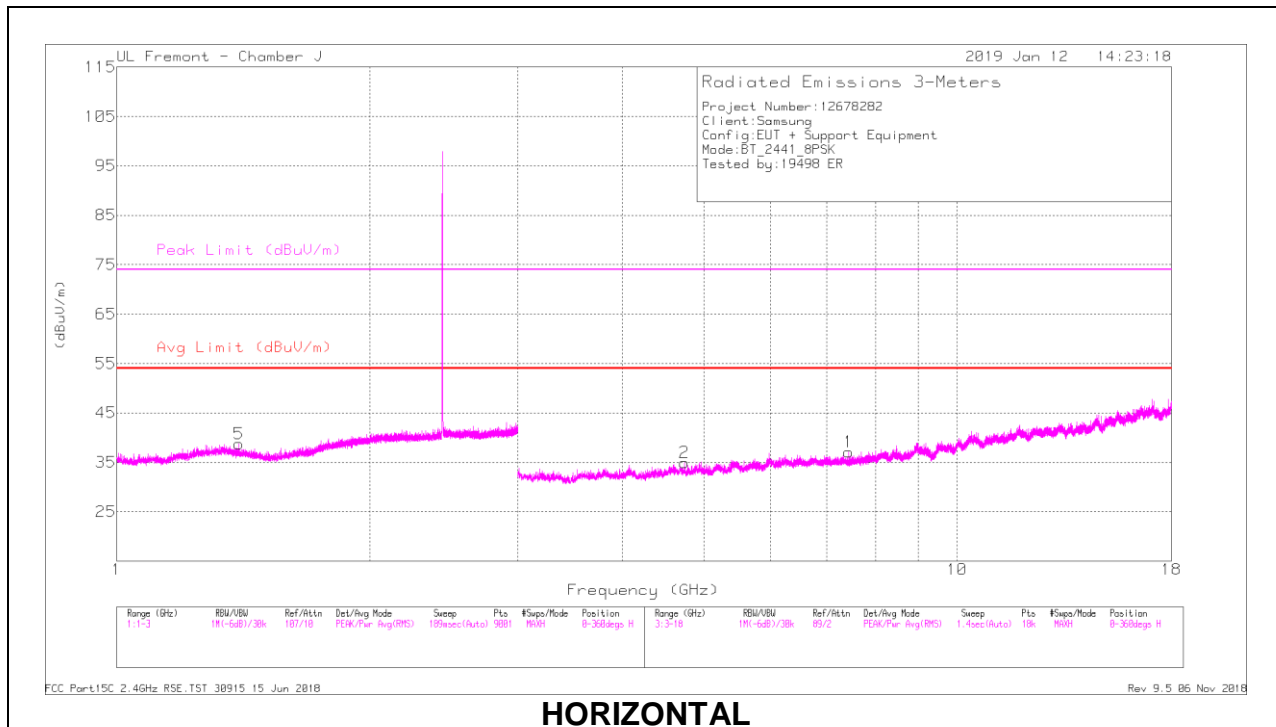

**HORIZONTAL**

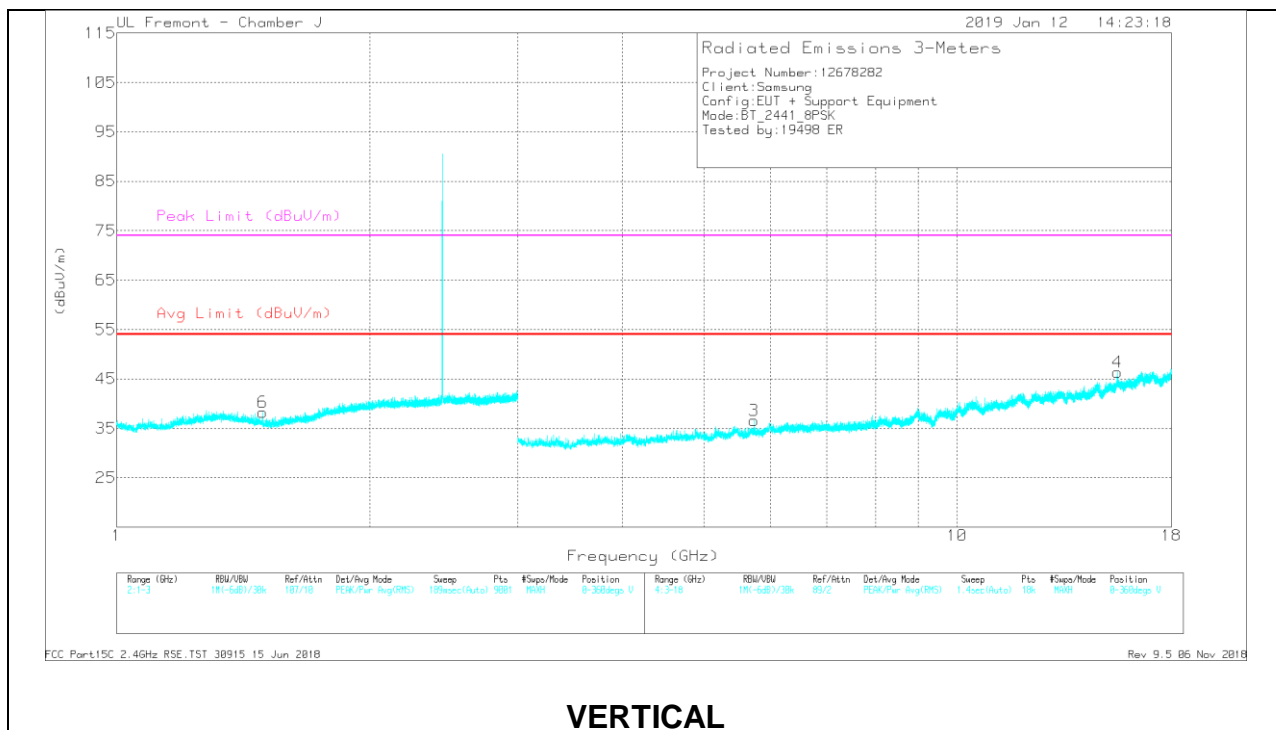

**VERTICAL**

**RADIATED EMISSIONS**

Frequency (GHz)	Meter Reading (dBuV)	Det	AF AT0067 (dB/m)	Amp/Cb/Fit r/Pad (dB)	Corrected Reading (dBuV/m)	Avg Limit (dBuV/m)	Margin (dB)	Peak Limit (dBuV/m)	PK Margin (dB)	Azimuth (Degs)	Height (cm)	Polarity
* 1.397	41.93	PKFH	28.9	-26.1	44.73	-	-	74	-29.27	196	208	H
* 1.395	29.85	VA1T	29	-26.1	32.75	54	-21.25	-	-	196	208	H
* 1.492	42.63	PKFH	28.1	-26.1	44.63	-	-	74	-29.37	269	182	V
* 1.493	29.94	VA1T	28.1	-26.1	31.94	54	-22.06	-	-	269	182	V
* 7.427	35.45	PKFH	35.6	-27.6	43.45	-	-	74	-30.55	54	221	H
* 7.428	22.9	VA1T	35.6	-27.6	30.9	54	-23.1	-	-	54	221	H
* 4.743	38.52	PKFH	34	-30.9	41.62	-	-	74	-32.38	247	321	H
* 4.744	26.06	VA1T	34	-30.9	29.16	54	-24.84	-	-	247	321	H
* 15.527	30.4	PKFH	40.2	-19.3	51.3	-	-	74	-22.7	243	128	V
* 15.524	18.14	VA1T	40.2	-19.3	39.04	54	-14.96	-	-	243	128	V
5.732	35.74	PKFH	34.7	-28.9	41.54	-	-	-	-	125	136	V

\* - indicates frequency in CFR47 Pt 15 / IC RSS-Restricted Band

PKFH - FHSS: RB=100k/1MHz VB=3 x RB, Peak

VA1T - FHSS: Linear Voltage Average VB=1/Ton where: Ton is transmit duration

### HIGH CHANNEL RESULTS

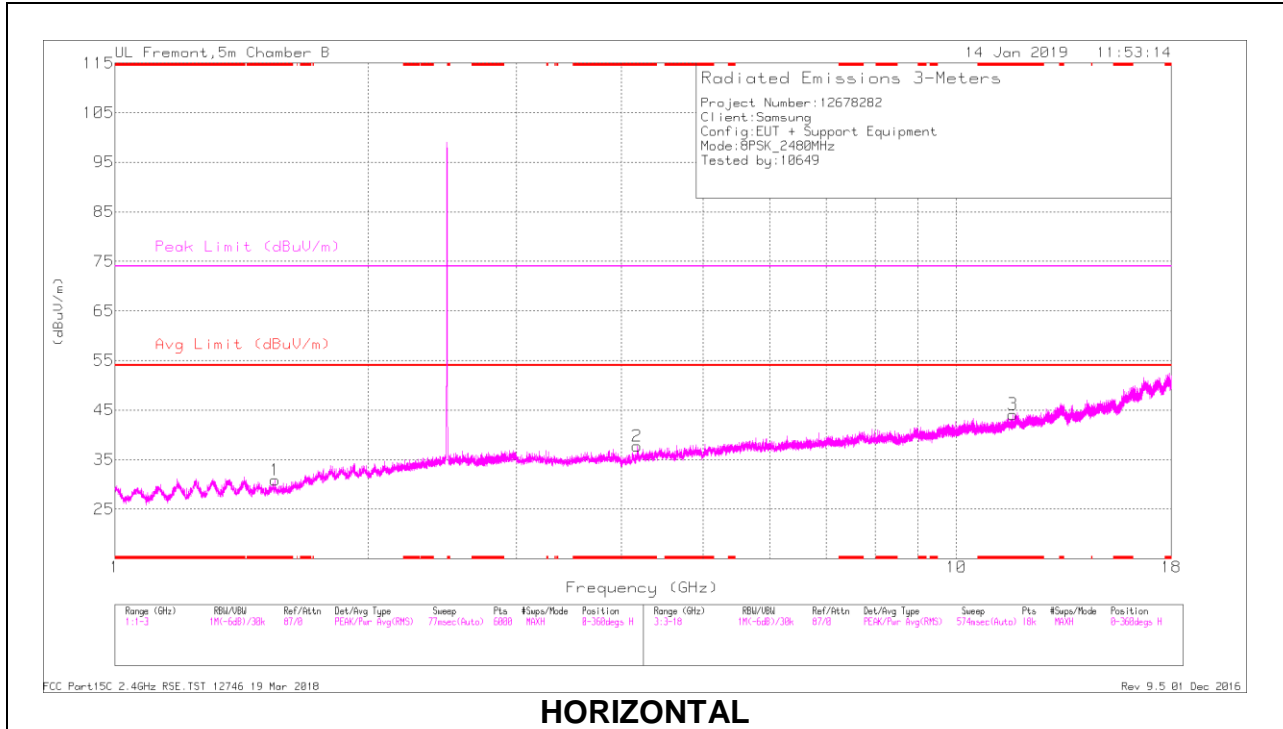

**HORIZONTAL**

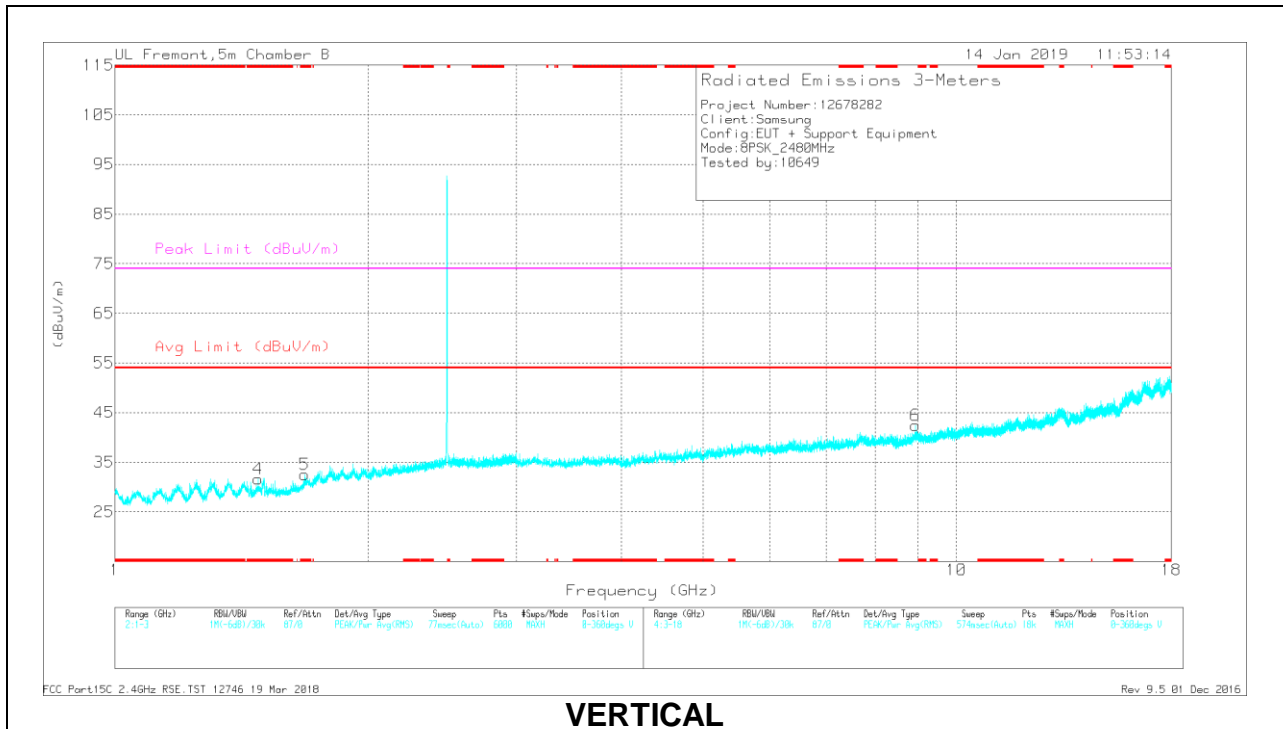

**VERTICAL**

**RADIATED EMISSIONS**

Marker	Frequency (GHz)	Meter Reading (dBuV)	Det	AF T863 (dB/m)	Amp/Cbl/Filtr/ Pad (dB)	Corrected Reading (dBuV/m)	Avg Limit (dBuV/m)	Margin (dB)	Peak Limit (dBuV/m)	PK Margin (dB)	Azimuth (Degs)	Height (cm)	Polarity
4	* 1.55	28.17	PKFH	27.7	-20.9	34.97	-	-	74	-39.03	157	211	H
	* 1.55	17.11	VA1T	27.7	-20.9	23.91	54	-30.09	-	-	157	211	H
1	* 1.48	29.9	PKFH	27.9	-21.1	36.7	-	-	74	-37.3	247	384	V
	* 1.48	22.15	VA1T	27.9	-21.1	28.95	54	-25.05	-	-	247	384	V
5	* 1.68	29.24	PKFH	29.2	-21	37.44	-	-	74	-36.56	283	316	V
	* 1.68	20.5	VA1T	29.2	-21	28.7	54	-25.3	-	-	283	316	V
3	* 4.176	37.77	PKFH	33.6	-29.6	41.77	-	-	74	-32.23	238	360	H
	* 4.175	26.49	VA1T	33.6	-29.6	30.49	54	-23.51	-	-	238	360	H
2	* 11.661	32.08	PKFH	38.8	-22.3	48.58	-	-	74	-25.42	138	223	H
	* 11.661	19.38	VA1T	38.8	-22.3	35.88	54	-18.12	-	-	138	223	H
6	8.933	33.19	PKFH	36.8	-23.9	46.09	-	-	-	-	215	251	V

\* - indicates frequency in CFR47 Pt 15 / IC RSS-Restricted Band

PKFH - FHSS: RB=100k/1MHz VB=3 x RB, Peak

VA1T - FHSS: Linear Voltage Average VB=1/Ton where: Ton is transmit duration



## 10.2. Worst Case Below 30MHz

### SPURIOUS EMISSIONS BELOW 30 MHz (WORST-CASE CONFIGURATION)

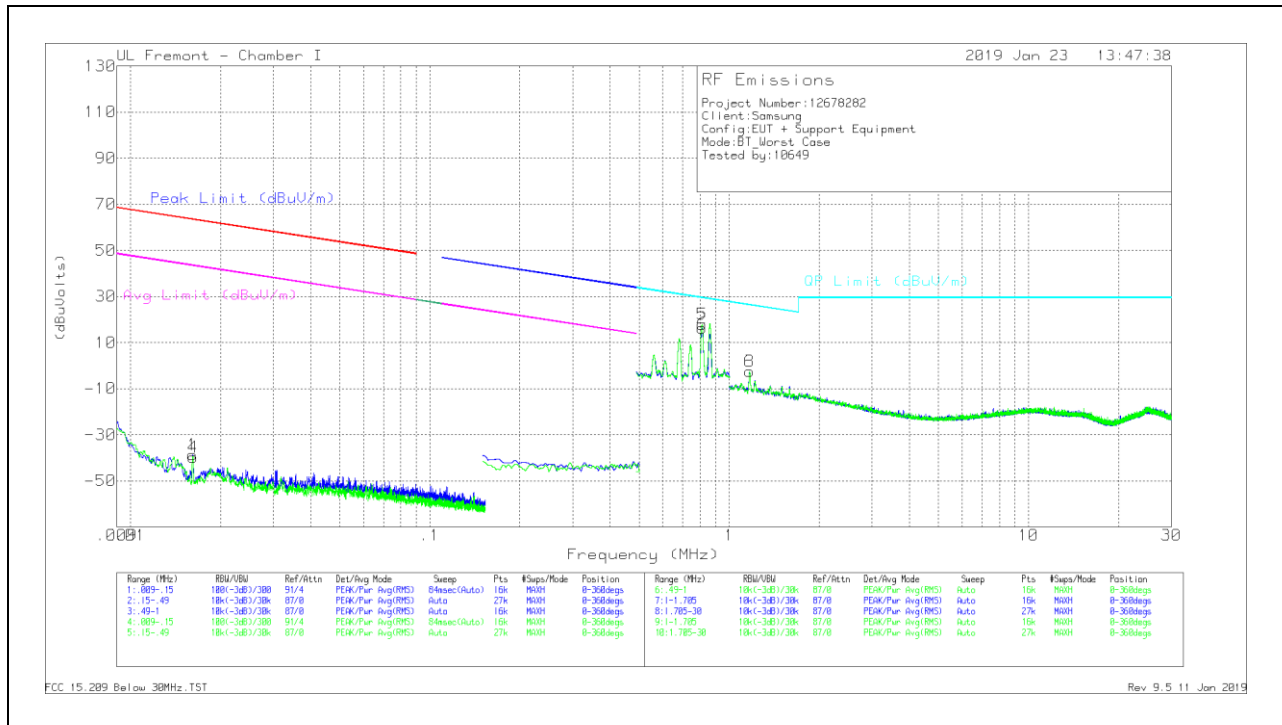

**Below 30MHz Data**

Marker	Frequency (MHz)	Meter Reading (dBuV)	Det	Loop Antenna (ACF)	Cable s w/ PRE0 18017 5 (dB)	Dist Corr 300m	Corrected Reading (dBuVolts)	Peak Limit (dBuV /m)	Margin (dB)	Avg Limit (dBuV /m)	Margin (dB)	Azimuth (Degs)
1	.01615	14.34	Pk	59.5	-32.4	-80	-38.56	63.42	-101.98	43.42	-81.98	0-360
4	.01617	13.22	Pk	59.5	-32.4	-80	-39.68	63.41	-103.09	43.41	-83.09	0-360

Pk - Peak detector

Marker	Frequency (MHz)	Meter Reading (dBuV)	Det	Loop Antenna (ACF)	Cable s w/ PRE0 18017 5 (dB)	Dist Corr 30m (dB) 40Log	Corrected Reading (dBuVolts)	QP Limit (dBuV /m)	Margin (dB)	Azimuth (Degs)
2	.81162	31.8	Pk	56.3	-31.8	-40	16.3	29.43	-13.13	0-360
5	.81136	33.43	Pk	56.3	-31.8	-40	17.93	29.43	-11.5	0-360
3	1.1696	23.88	Pk	45.5	-31.8	-40	-2.42	26.26	-28.68	0-360
6	1.16955	23.84	Pk	45.5	-31.8	-40	-2.46	26.26	-28.72	0-360

Pk - Peak detector

### 10.3. Worst Case Below 1 GHz

#### SPURIOUS EMISSIONS 30 TO 1000 MHz (WORST-CASE CONFIGURATION)

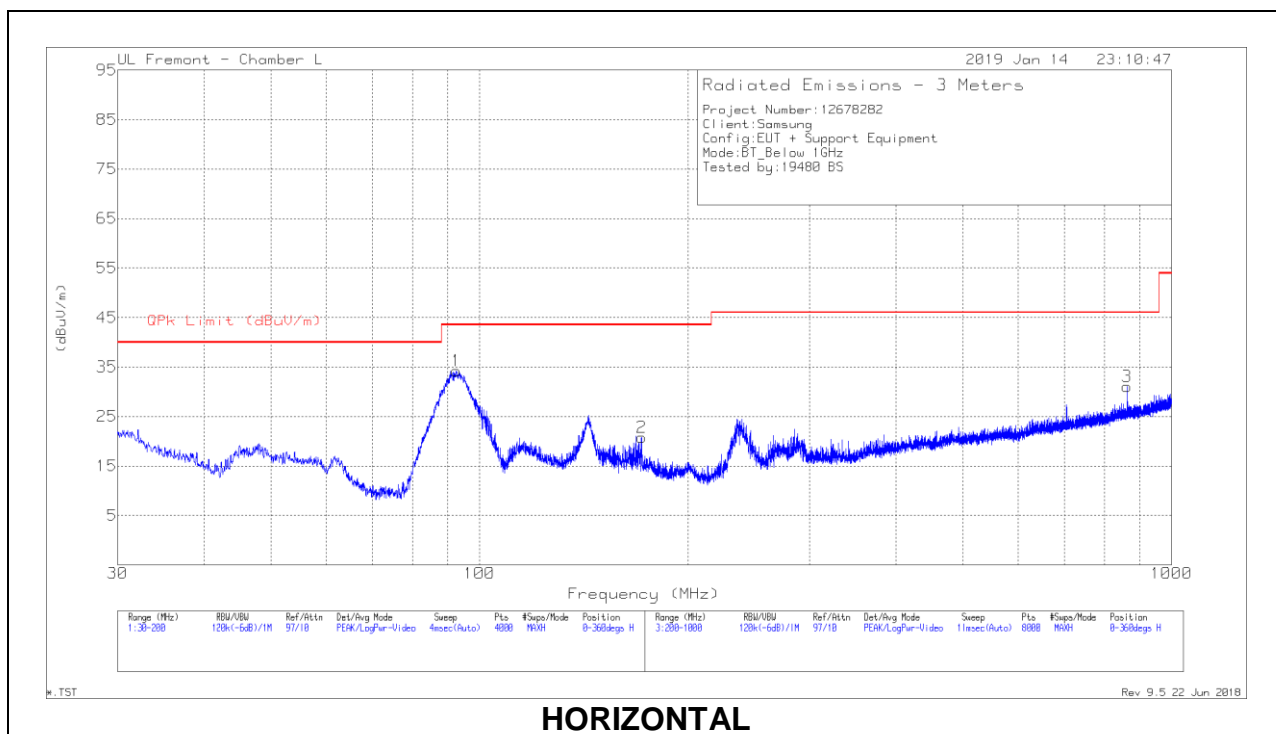

**HORIZONTAL**

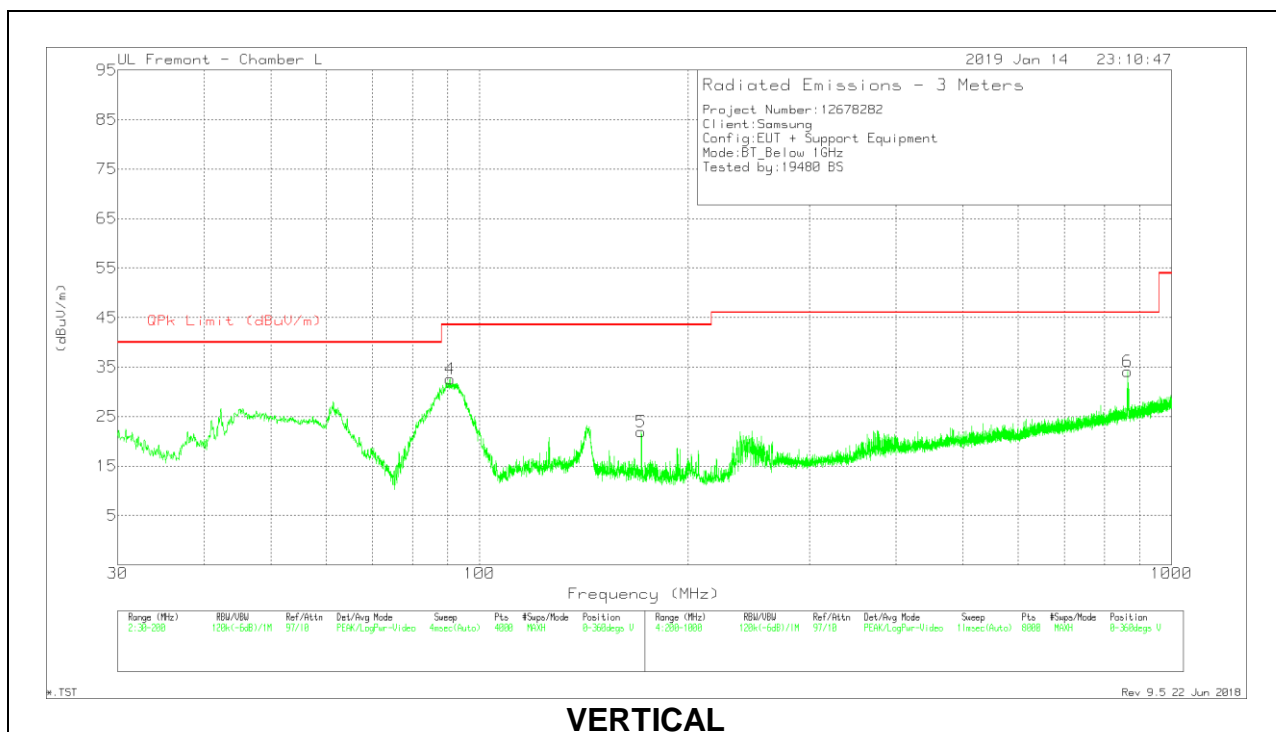

**VERTICAL**

**Below 1GHz Data**

Marker	Frequency (MHz)	Meter Reading (dBuV)	Det	AF PRE0184970 (dB/m)	Amp/Cbl (dB)	Corrected Reading (dBuV/m)	QPk Limit (dBuV/m)	Margin (dB)	Azimuth (Degs)	Height (cm)	Polarity
1	92.5762	51.11	Pk	14.1	-31	34.21	43.52	-9.31	0-360	299	H
		49.62	Qp	14.1	-31	32.72	43.52	-10.8	63	305	H
2	* 171.4341	33.81	Pk	17.5	-30.5	20.81	43.52	-22.71	0-360	199	H
4	90.6207	50.01	Pk	13.6	-31	32.61	43.52	-10.91	0-360	102	V
5	* 171.3066	34.89	Pk	17.5	-30.5	21.89	43.52	-21.63	0-360	102	V
3	862.3861	31.01	Pk	27.6	-27.6	31.01	46.02	-15.01	0-360	299	H
6	864.3864	33.89	Pk	27.7	-27.5	34.09	46.02	-11.93	0-360	102	V

\* - indicates frequency in CFR47 Pt 15 / IC RSS-Restricted Band

Pk - Peak detector

Qp - Quasi-Peak detector

### 10.4. Worst Case 18-26 GHz

#### SPURIOUS EMISSIONS 18-26 GHz (WORST-CASE CONFIGURATION)

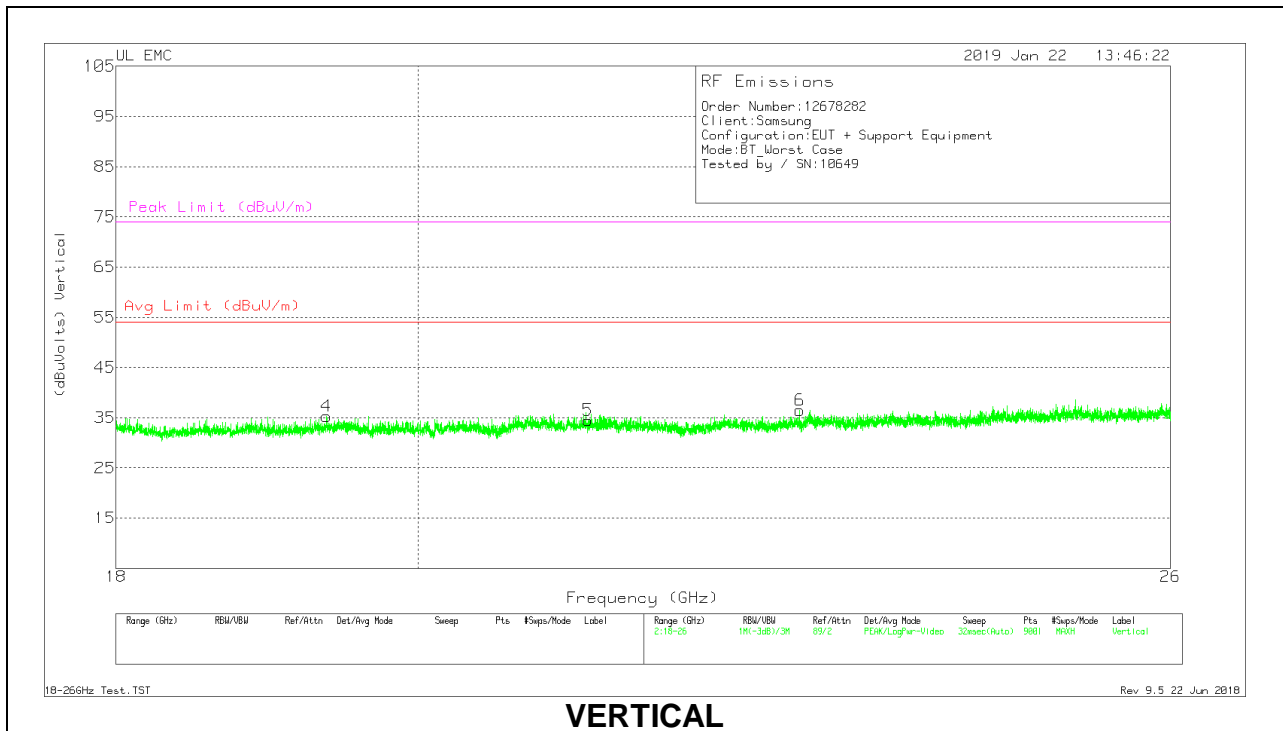
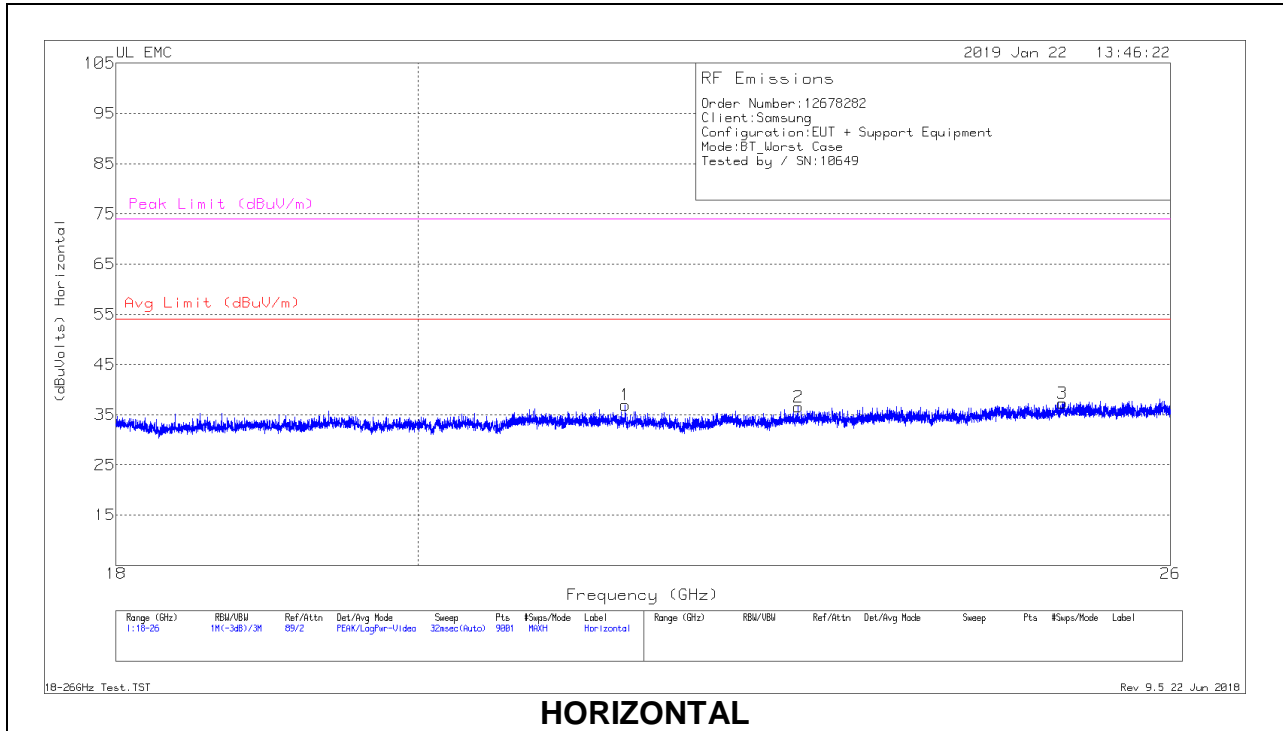

**18 – 26GHz DATA**

Marker	Frequency (GHz)	Meter Reading (dBuV)	Det	T448 AF (dB/m)	Amp/Cbl (dB)	Dist Corr (dB)	Corrected Reading (dBuVolts)	Avg Limit (dBuV/m)	Margin (dB)	Peak Limit (dBuV/m)	PK Margin (dB)
1	21.498	70.13	Pk	33.2	-56.9	-9.5	36.93	54	-17.07	74	-37.07
2	22.835	70.17	Pk	33.5	-57.6	-9.5	36.57	54	-17.43	74	-37.43
3	25.038	66.72	Pk	34.6	-54.5	-9.5	37.32	54	-16.68	74	-36.68
4	19.371	68.99	Pk	32.7	-56.9	-9.5	35.29	54	-18.71	74	-38.71
5	21.221	67.99	Pk	33.1	-57.1	-9.5	34.49	54	-19.51	74	-39.51
6	22.846	69.98	Pk	33.5	-57.5	-9.5	36.48	54	-17.52	74	-37.52

Pk - Peak detector

---

## 11. AC POWER LINE CONDUCTED EMISSIONS

### LIMITS

FCC §15.207 (a)

Frequency of Emission (MHz)	Conducted Limit (dBuV)	
	Quasi-peak	Average
0.15-0.5	66 to 56*	56 to 46*
0.5-5	56	46
5-30	60	50

\*Decreases with the logarithm of the frequency.

### TEST PROCEDURE

The EUT is placed on a non-conducting table 40 cm from the vertical ground plane and 80 cm above the horizontal ground plane. The EUT is configured in accordance with ANSI C63.4.

The receiver is set to a resolution bandwidth of 9 kHz. Peak detection is used unless otherwise noted as quasi-peak or average.

Line conducted data is recorded for both NEUTRAL and HOT lines.

### RESULTS

**AC Power Line Norm**

**LINE 1 RESULTS**

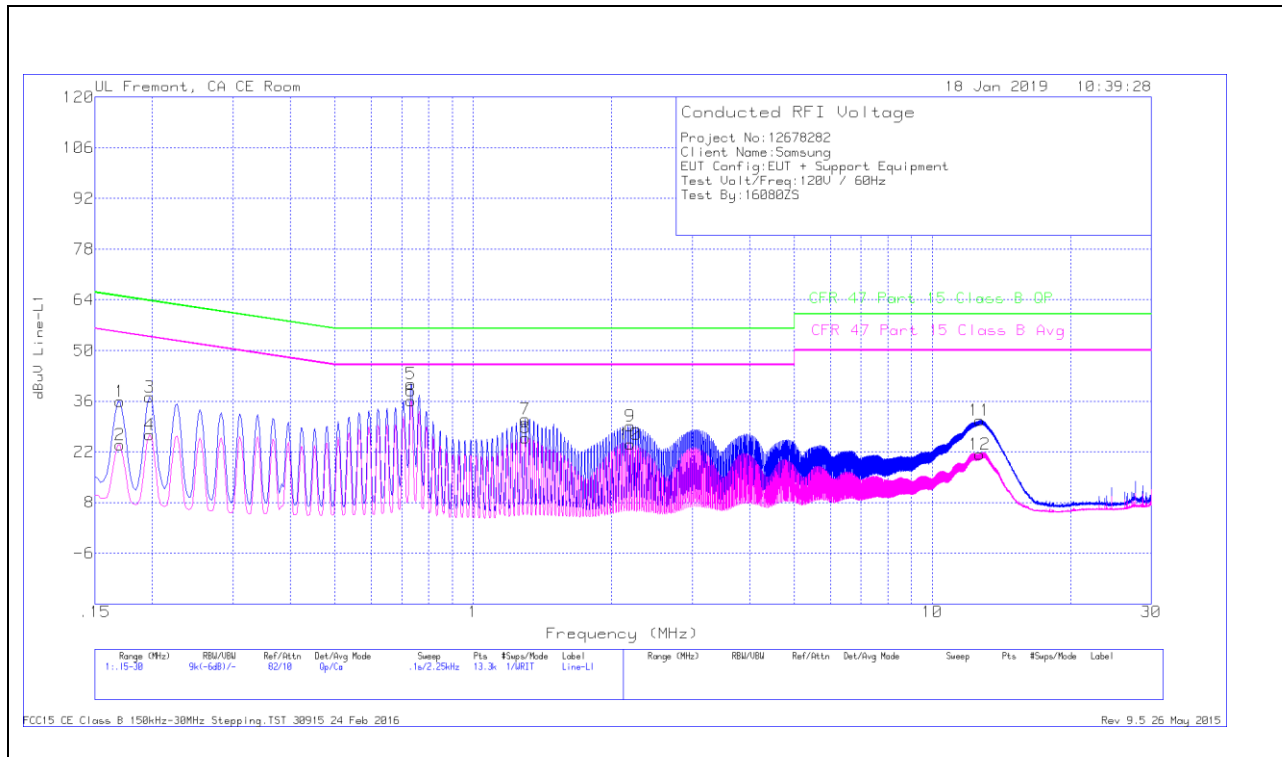

Range 1: Line-L1 .15 - 30MHz											
Marker	Frequency (MHz)	Meter Reading (dBuV)	Det	LISN L1	LC Cables C1&C3	Limiter (dB)	Corrected Reading dBuV	CFR 47 Part 15 Class B QP	QP Margin (dB)	CFR 47 Part 15 Class B Avg	Av(CISPR) Margin (dB)
1	.17025	25.74	Qp	0	0	10.1	35.84	64.95	-29.11	-	-
2	.17025	13.9	Ca	0	0	10.1	24	-	-	54.95	-30.95
3	.19725	26.98	Qp	0	0	10.1	37.08	63.73	-26.65	-	-
4	.19725	16.67	Ca	0	0	10.1	26.77	-	-	53.73	-26.96
5	.73275	30.61	Qp	0	0	10.1	40.71	56	-15.29	-	-
6	.73275	26.04	Ca	0	0	10.1	36.14	-	-	46	-9.86
7	1.2975	20.82	Qp	0	.1	10.1	31.02	56	-24.98	-	-
8	1.2975	15.64	Ca	0	.1	10.1	25.84	-	-	46	-20.16
9	2.202	18.87	Qp	0	.1	10.1	29.07	56	-26.93	-	-
10	2.202	13.97	Ca	0	.1	10.1	24.17	-	-	46	-21.83
11	12.669	20.13	Qp	.1	.2	10.2	30.63	60	-29.37	-	-
12	12.67125	10.83	Ca	.1	.2	10.2	21.33	-	-	50	-28.67

Qp - Quasi-Peak detector

Ca - CISPR average detection



**LINE 2 RESULTS**

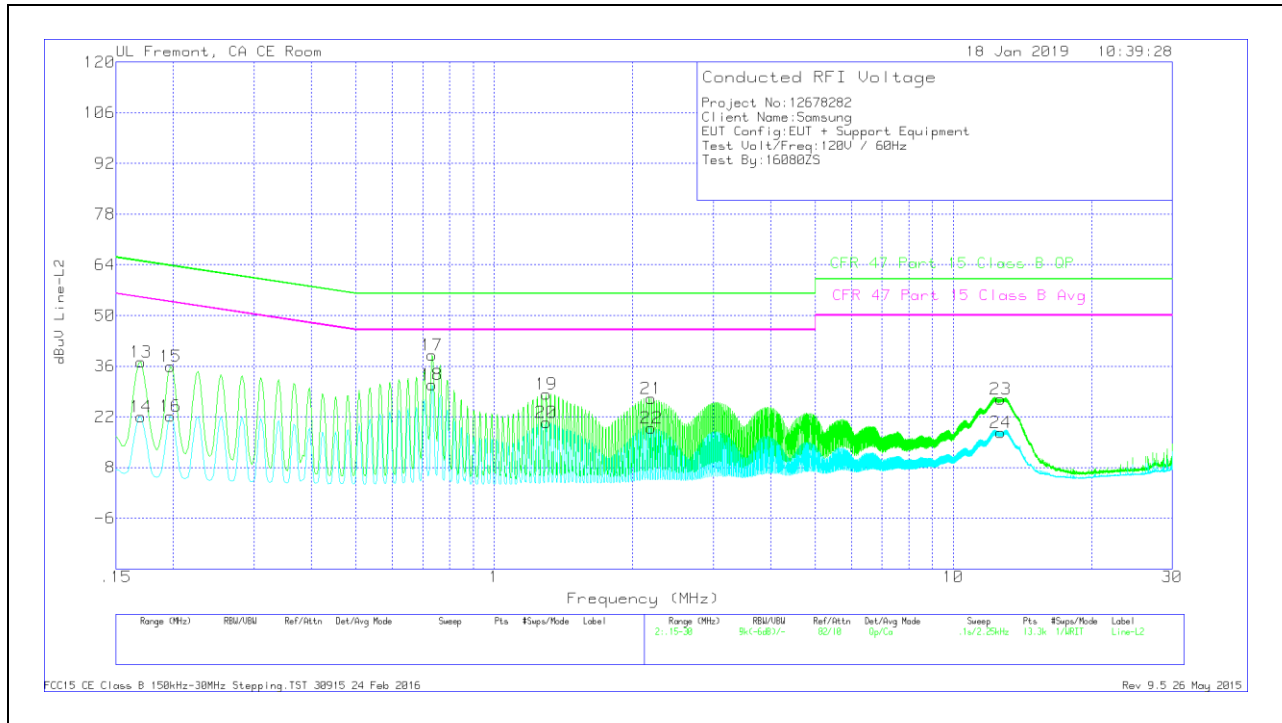

Range 2: Line-L2 .15 - 30MHz											
Marker	Frequency (MHz)	Meter Reading (dBuV)	Det	LISN L2	LC Cables C2&C3	Limiter (dB)	Corrected Reading dBuV	CFR 47 Part 15 Class B QP	QP Margin (dB)	CFR 47 Part 15 Class B Avg	Av(CISPR) Margin (dB)
13	.17025	26.97	Qp	0	0	10.1	37.07	64.95	-27.88	-	-
14	.17025	11.99	Ca	0	0	10.1	22.09	-	-	54.95	-32.86
15	.19725	25.84	Qp	0	0	10.1	35.94	63.73	-27.79	-	-
16	.19725	12.08	Ca	0	0	10.1	22.18	-	-	53.73	-31.55
17	.73275	28.94	Qp	0	0	10.1	39.04	56	-16.96	-	-
18	.73275	20.74	Ca	0	0	10.1	30.84	-	-	46	-15.16
19	1.2975	18.11	Qp	0	.1	10.1	28.31	56	-27.69	-	-
20	1.2975	10.19	Ca	0	.1	10.1	20.39	-	-	46	-25.61
21	2.19975	16.84	Qp	0	.1	10.1	27.04	56	-28.96	-	-
22	2.202	8.64	Ca	0	.1	10.1	18.84	-	-	46	-27.16
23	12.66675	16.44	Qp	.1	.2	10.2	26.94	60	-33.06	-	-
24	12.669	7.17	Ca	.1	.2	10.2	17.67	-	-	50	-32.33

Qp - Quasi-Peak detector

Ca - CISPR average detection