

TEST REPORT

Report Number: 14938215 – E4V2

Applicant: SAMSUNG ELECTRONICS CO., LTD.
129, SAMSUNG-RO, YEONGTONG-GU,
SUWON-SI, GYEONGGI-DO, 16677, KOREA

Model: SM-A256E/DSN and SM-A256E/N

FCC ID: A3LSMA256E

EUT Description: GSM/WCDMA/LTE/5G Phone with BT/BLE,
DTS/UNII a/b/g/n/ac and NFC

Test Standard(s): FCC 47 CFR PART 15 SUBPART C

Date Of Issue:
2023-10-23

Prepared by:
UL Verification Services Inc.
47173 Benicia Street
Fremont, CA 94538 U.S.A.
TEL: (510) 319-4000
FAX: (510) 661-0888



REPORT REVISION HISTORY

Rev.	Issue Date	Revisions	Revised By
V1	2023-10-18	Initial Issue	
V2	2023-10-23	Updated Sections 6.5, 8, 9.1, 10, 11	Benjamin D.

REPORT REVISION HISTORY 2

1. ATTESTATION OF TEST RESULTS 5

2. TEST RESULTS SUMMARY 7

3. TEST METHODOLOGY 7

4. FACILITIES AND ACCREDITATION 8

5. DECISION RULES AND MEASUREMENT UNCERTAINTY 9

 5.1. METROLOGICAL TRACEABILITY 9

 5.2. DECISION RULES 9

 5.3. MEASUREMENT UNCERTAINTY 9

 5.4. SAMPLE CALCULATION 10

6. EQUIPMENT UNDER TEST 11

 6.1. EUT DESCRIPTION 11

 6.2. MAXIMUM OUTPUT POWER 11

 6.3. DESCRIPTION OF AVAILABLE ANTENNAS 12

 6.4. SOFTWARE 12

 6.5. WORST-CASE CONFIGURATION AND MODE 12

 6.6. DESCRIPTION OF TEST SETUP 13

7. MEASUREMENT METHOD 16

8. TEST AND MEASUREMENT EQUIPMENT 17

9. ANTENNA PORT TEST RESULTS 18

 9.1. ON TIME AND DUTY CYCLE 18

 9.2. 99% BANDWIDTH 20

 9.2.1. 802.11b MODE 21

 9.2.2. 802.11g MODE 23

 9.2.3. 802.11n HT20 MODE 25

 9.3. 6 dB BANDWIDTH 27

 9.3.1. 802.11b MODE 28

 9.3.2. 802.11g MODE 30

 9.3.3. 802.11n HT20 MODE 32

 9.4. OUTPUT POWER 34

 9.4.1. 802.11b MODE 35

 9.4.2. 802.11g MODE 36

 9.4.3. 802.11n HT20 MODE 37

 9.5. POWER SPECTRAL DENSITY 38

 9.5.1. 802.11b MODE 38

 9.5.2. 802.11g MODE 40

9.5.3.	802.11n HT20 MODE	42
9.6.	<i>CONDUCTED SPURIOUS EMISSIONS</i>	44
9.6.1.	802.11b MODE	44
9.6.2.	802.11g MODE	46
9.6.3.	802.11n HT20 MODE	48
10.	RADIATED TEST RESULTS	50
10.1.	<i>TRANSMITTER ABOVE 1 GHz</i>	52
10.1.1.	TX ABOVE 1 GHz 802.11b MODE IN THE 2.4 GHz BAND	52
10.1.2.	TX ABOVE 1 GHz 802.11g MODE IN THE 2.4 GHz BAND	70
10.1.3.	TX ABOVE 1 GHz 802.11n HT20 MODE IN THE 2.4 GHz BAND.....	88
10.2.	<i>WORST CASE BELOW 30MHz</i>	106
10.3.	<i>WORST CASE BELOW 1 GHz</i>	108
10.4.	<i>WORST CASE 18-26 GHz</i>	110
11.	AC POWER LINE CONDUCTED EMISSIONS	112
12.	SETUP PHOTOS	115

1. ATTESTATION OF TEST RESULTS

COMPANY NAME: SAMSUNG ELECTRONICS CO., LTD.
129, SAMSUNG-RO, YEONGTONG-GU,
SUWON-SI, GYEONGGI-DO, 16677, KOREA

EUT DESCRIPTION: GSM/WCDMA/LTE/5G Phone with BT/BLE, DTS/UNII a/b/g/n/ac
and NFC

MODEL: SM-A256E/DSN and SM-A256E/N

SERIAL NUMBER: Conducted: R3CW50B1BPM
Radiated: R3CW50B1C2V, R3CW50B1C0J

DATE TESTED: 2023-09-12 – 2023-09-28

APPLICABLE STANDARDS	
STANDARD	TEST RESULTS
CFR 47 Part 15 Subpart C	Complies

UL Verification Services Inc. tested the above equipment in accordance with the requirements set forth in the above standards. The test results show that the equipment tested is capable of demonstrating compliance with the requirements as documented in this report.

The results documented in this report apply only to the tested sample, under the conditions and modes of operation as described herein. It is the manufacturer's responsibility to assure that additional production units of this model are manufactured with identical electrical and mechanical components. All samples tested were in good operating condition throughout the entire test program. Measurement Uncertainties are published for informational purposes only and were not taken into account unless noted otherwise.

This document may not be altered or revised in any way unless done so by UL Verification Services Inc. and all revisions are duly noted in the revisions section. Any alteration of this document not carried out by UL Verification Services Inc. will constitute fraud and shall nullify the document. This report must not be used by the client to claim product certification, approval, or endorsement by A2LA, NIST, any agency of the Federal Government, or any agency of the U.S. government.

Approved & Released For
UL Verification Services Inc. By:

Prepared By:



Dan Corona
Operations Leader
Consumer Technology Division
UL Verification Services Inc.

Benjamin Dobbins
Senior Test Engineer
Consumer Technology Division
UL Verification Services Inc.

1st Reviewed By:

2nd Reviewed By:



Steven Tran
Senior Project Engineer
Consumer Technology Division
UL Verification Services Inc.

Kiya Kedida
Senior Project Engineer
Consumer Technology Division
UL Verification Services Inc.

2. TEST RESULTS SUMMARY

This report contains data provided by the customer which can impact the validity of results. UL Verification Services Inc. is only responsible for the validity of results after the integration of the data provided by the customer.

Below is a list of the data provided by the customer:

1. Antenna gain and type (see section 6.3)

FCC Clause	Requirement	Result	Comment
See Comment	Duty Cycle	Reporting purposes only	ANSI C63.10 Section 11.6.
-	99% OBW	Reporting purposes only	ANSI C63.10 Section 6.9.3.
15.247 (a) (2)	6dB BW	Complies	None.
15.247 (b) (3)	Output Power	Complies	None.
See Comment	Average power	Reporting purposes only	Per ANSI C63.10, Section 11.9.2.3.2.
15.247 (e)	PSD	Complies	None.
15.247 (d)	Conducted Spurious Emissions	Complies	None.
15.209, 15.205	Radiated Emissions	Complies	None.
15.207	AC Mains Conducted Emissions	Complies	None.

3. TEST METHODOLOGY

The tests documented in this report were performed in accordance with FCC CFR 47 Part 2, FCC CFR 47 Part 15, ANSI C63.10-2013, KDB 558074 D01 15.247 Meas Guidance v05r02, KDB 414788 D01 Radiated Test Site v01r01.

4. FACILITIES AND ACCREDITATION

UL Verification Services Inc. is accredited by A2LA, Certificate Number 0751.05, for all testing performed within the scope of this report. Testing was performed at the locations noted below.

	Address	ISED CABID	ISED Company Number	FCC Registration
<input checked="" type="checkbox"/>	Building 1: 47173 Benicia Street Fremont, CA 94538, U.S.A	US0104	2324A	550739
<input checked="" type="checkbox"/>	Building 2: 47266 Benicia Street Fremont, CA 94538, U.S.A			
<input checked="" type="checkbox"/>	Building 3: 843 Auburn Court Fremont, CA 94538, U.S.A			
<input type="checkbox"/>	Building 4: 47658 Kato Rd Fremont, CA 94538, U.S.A			
<input type="checkbox"/>	Building 5: 47670 Kato Rd Fremont, CA 94538, U.S.A			

5. DECISION RULES AND MEASUREMENT UNCERTAINTY

5.1. METROLOGICAL TRACEABILITY

All test and measuring equipment utilized to perform the tests documented in this report are calibrated on a regular basis, with a maximum time between calibrations of one year or the manufacturers' recommendation, whichever is less, and where applicable is traceable to recognized national standards.

5.2. DECISION RULES

The Decision Rule is based on Simple Acceptance in accordance with ISO Guide 98-4:2012 Clause 8.2. (Measurement uncertainty is not taken into account when stating conformity with a specified requirement.)

5.3. MEASUREMENT UNCERTAINTY

Where relevant, the following measurement uncertainty levels have been estimated for tests performed on the apparatus:

PARAMETER	U _{Lab}
Radio Frequency (Spectrum Analyzer)	141.16 Hz
Occupied Bandwidth	1.22%
Power Spectral Density	2.47 dB
RF Power Measurement Direct Method Using Power Meter	1.3 dB (PK) / 0.45 dB (AV)
Unwanted Emissions, Conducted	1.94 dB
Worst Case Conducted Disturbance, 9KHz to 0.15 MHz	3.78 dB
Worst Case Conducted Disturbance, 0.15 to 30 MHz	3.40 dB
Worst Case Radiated Disturbance, 9KHz to 30 MHz	2.87 dB
Worst Case Radiated Disturbance, 30 to 1000 MHz	6.01 dB
Worst Case Radiated Disturbance, 1000 to 18000 MHz	4.73 dB
Worst Case Radiated Disturbance, 18000 to 26000 MHz	4.51 dB
Worst Case Radiated Disturbance, 26000 to 40000 MHz	5.29 dB
Time Domain Measurements	3.39%
Temperature	0.57°C
Humidity	3.39%
DC Supply Voltages	0.57%

Uncertainty figures are valid to a confidence level of 95%.

5.4. SAMPLE CALCULATION

RADIATED EMISSIONS

Where relevant, the following sample calculation is provided:

Field Strength (dBuV/m) = Measured Voltage (dBuV) + Antenna Factor (dB/m) + Cable Loss (dB) – Preamp Gain (dB)

$$36.5 \text{ dBuV} + 18.7 \text{ dB/m} + 0.6 \text{ dB} - 26.9 \text{ dB} = 28.9 \text{ dBuV/m}$$

MAINS CONDUCTED EMISSIONS

Where relevant, the following sample calculation is provided:

Final Voltage (dBuV) = Measured Voltage (dBuV) + Cable Loss (dB) + Limiter Factor (dB) + LISN Insertion Loss.

$$36.5 \text{ dBuV} + 0 \text{ dB} + 10.1 \text{ dB} + 0 \text{ dB} = 46.6 \text{ dBuV}$$

6. EQUIPMENT UNDER TEST

6.1. EUT DESCRIPTION

The EUT is a GSM/WCDMA/LTE/5G Phone with BT/BLE, DTS/UNII a/b/g/n/ac and NFC.

The model SM-A256E/DSN was used for final testing and is representative of the test results in this report.

6.2. MAXIMUM OUTPUT POWER

The transmitter has a maximum conducted output power as follows:

Frequency Range (MHz)	Mode	Output Power (dBm)	Output Power (mW)
1Tx			
2412 - 2472	802.11b	18.25	66.83
2412 - 2472	802.11g	16.31	42.76
2412 - 2472	802.11n HT20	16.39	43.55

6.3. DESCRIPTION OF AVAILABLE ANTENNAS

The antenna(s) gain and type, as provided by the manufacturer' are as follows.

The radio utilizes an MFA antenna, with a maximum gain:

Frequency Band (GHz)	Antenna Gain (dBi)
2412-2472	-7.29

6.4. SOFTWARE

The test utility software used during testing was A256E.001.

6.5. WORST-CASE CONFIGURATION AND MODE

Radiated emissions below 1GHz, above 18GHz, and power line conducted emission were performed with the EUT set to transmit at the channel with highest output power as worst-case scenario.

Band edge and radiated emissions between 1GHz and 18GHz were performed with the EUT set to transmit at the highest power on low, middle, and high channels.

The fundamental of the EUT was investigated in three orthogonal orientations X,Y,Z, it was determined that X orientation was worst-case orientation; therefore, all final radiated testing was performed with the EUT in X orientation.

Worst-case data rates as provided by the client were:

802.11b mode: 1 Mbps

802.11g mode: 6 Mbps

802.11n HT20mode: MCS0

6.6. DESCRIPTION OF TEST SETUP

SUPPORT EQUIPMENT

Support Equipment List				
Description	Manufacturer	Model	Serial Number	FCC ID
AC Adapter	Samsung	EP-TA800	R37MAMT21J2SE3	N/A

I/O CABLES CONDUCTED

I/O Cable List						
Cable No	Port	# of identical ports	Connector Type	Cable Type	Cable Length (m)	Remarks
1	Antenna	1	RF	Shielded	0.2	To spectrum Analyzer
2	USB	1	USB	Un-shielded	1	EUT to AC Mains

I/O CABLES (RADIATED AND CONDUCTED EMISSIONS)

I/O Cable List						
Cable No	Port	# of identical ports	Connector Type	Cable Type	Cable Length (m)	Remarks
1	USB	1	USB	Shielded	1	N/A
2	Earphone	1	3.5mm	Un-shielded	1	N/A

TEST SETUP

The EUT is a stand-alone unit. Test software exercised the radio card.

SETUP DIAGRAM

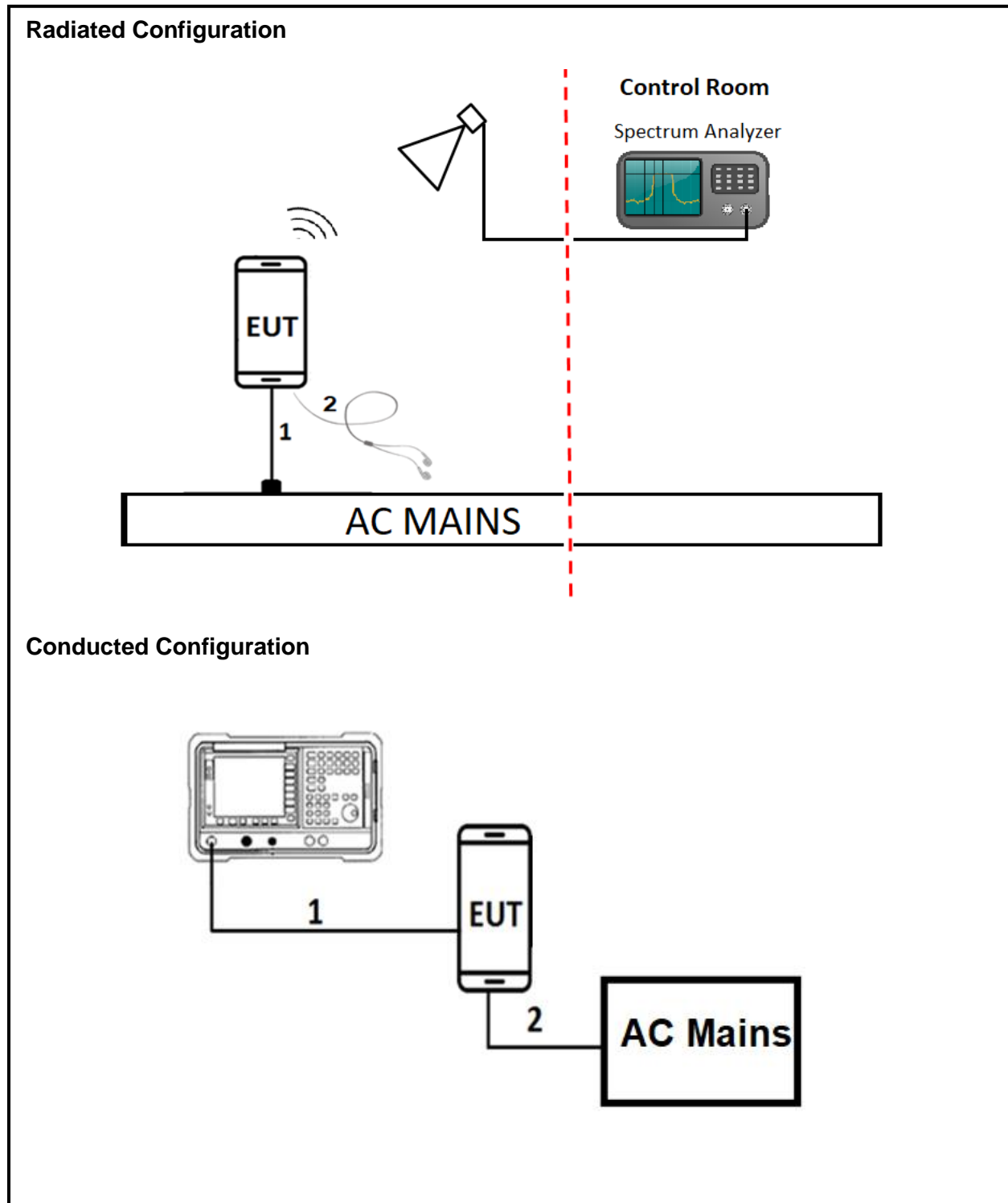

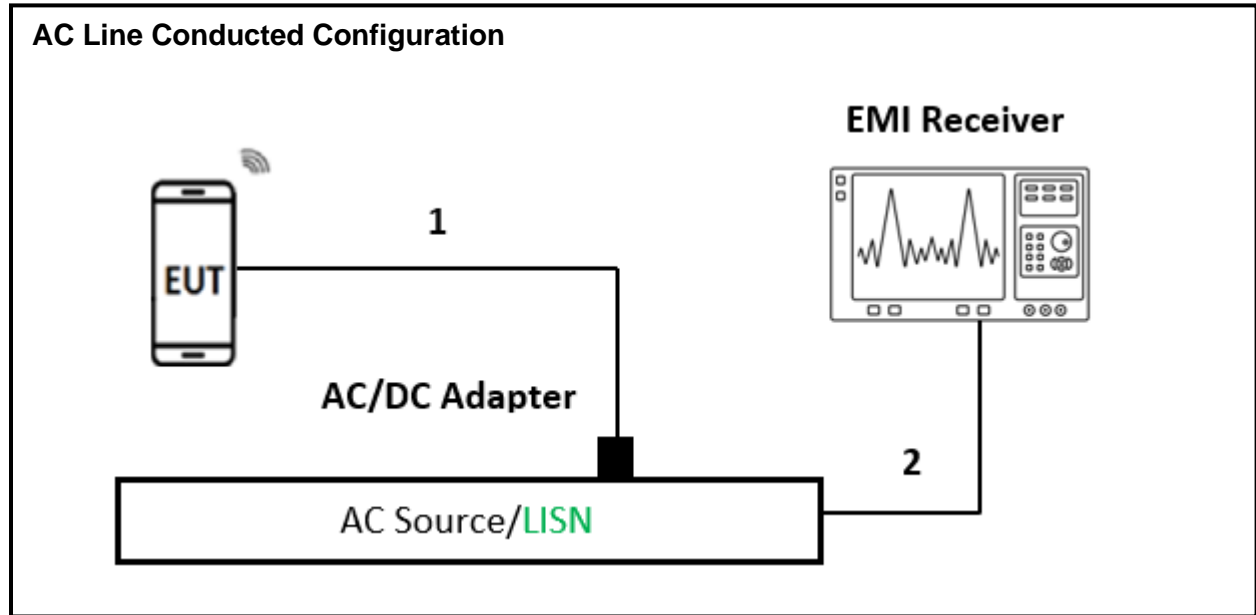

7. MEASUREMENT METHOD

On Time and Duty Cycle: ANSI C63.10 Section 11.6.

6 dB BW: ANSI C63.10 Subclause -11.8.1 RBW \geq DTS BW

Output Power: ANSI C63.10 Subclause -11.9.2.3.2 Method AVGPM-G (Measurement using a gated RF average-reading power meter)

PSD: ANSI C63.10 Subclause -11.10.3 Method AVGPSD-1

Radiated emissions non-restricted frequency bands: ANSI C63.10 Subclause -11.11

Radiated emissions restricted frequency bands: ANSI C63.10 Subclause -11.12.1

Conducted emissions in restricted frequency bands: ANSI C63.10 Subclause -11.12.2

Band-edge: ANSI C63.10 Subclause -11.13.3.2 Integration method -Peak detection

Band-edge: ANSI C63.10 Subclause -11.13.3.3 Integration method -Trace averaging with continuous transmission at full power

AC Power Line Conducted Emissions: ANSI C63.10-2013, Section 6.2.

Radiated Spurious Emissions Below 30MHz: ANSI C63.10-2013 Section 6.4

8. TEST AND MEASUREMENT EQUIPMENT

The following test and measurement equipment was utilized for the tests documented in this report:

TEST EQUIPMENT LIST					
Description	Manufacturer	Model	ID Num	Cal Due	Last Cal
Antenna, Horn 1-18GHz	ETS-Lindgren (Cedar Park, Texas)	3117	81886	03/31/2024	03/20/2023
RF Filter Box, 1-18GHz	UL-FR1	N/A	168534	01/05/2024	01/05/2023
EMI TEST RECEIVER	Rohde & Schwarz	ESW44	223462	04/30/2024	04/30/2023
Antenna, Broadband Hybrid, 30MHz to 3GHz	Sunol Sciences Corp.	JB3	230635	1/31//2024	01/23/2023
EMI TEST RECEIVER	Rohde & Schwarz	ESW44	191428	02/29/2024	02/15/2023
Amplifier, 10KHz to 1GHz, 32dB	SONOMA INSTRUMENT	310N	230310	01/23/2024	01/23/2023
Antenna, Horn 1-18GHz	ETS-Lindgren (Cedar Park, Texas)	3117	230300	01/12/2024	01/12/2023
RF Filter Box, 1-18GHz	UL-FR1	N/A	231875	09/30/2024	09/18/2023
EMI TEST RECEIVER	Rohde & Schwarz	ESW44	170063	02/29/2024	02/27/2023
Antenna, Horn 1-18GHz	ETS-Lindgren (Cedar Park, Texas)	3117	226672	01/09/2024	01/09/2023
RF Filter Box, 1-18GHz	UL-FR1	N/A	225079	04/29/2024	04/21/2023
EMI TEST RECEIVER	Rohde & Schwarz	ESW44	235670	04/30/2024	04/06/2023
Antenna, Passive Loop 30Hz - 1MHz	ELECTRO METRICS	EM-6871	170013	07/31/2024	07/28/2022
Antenna, Passive Loop 100KHz - 30MHz	ELECTRO METRICS	EM-6872	170015	07/31/2024	07/28/2022
Amplifier, 9KHz to 1GHz, 32dB	SONOMA INSTRUMENT	310N	230308	01/10/2024	01/10/2023
EMI TEST RECEIVER	Rohde & Schwarz	ESW44	201499	02/29/2024	02/17/2023
Antenna, Horn 18 to 26.5GHz	A.R.A.	MWH-1826/B	172363	01/31/2024	01/27/2023
Amplifier 18-26.5GHz, +5Vdc, 60dB min	A.R.A.	AMP18G26.5-60	171580	01/31/2024	01/27/2023
Spectrum Analyzer, PXA, 3Hz to 44GHz	Agilent Technologies	N9030A	80397	02/29/2024	02/06/2023
Power Meter, P-series single channel	Keysight Technologies Inc	N1911A	90630	01/31/2024	01/24/2023
Power Sensor, P - series, 50MHz to 18GHz, Wideband	Keysight Technologies Inc	N1921A	90631	01/31/2024	01/24/2023
10dB Fixed Attenuator	Pasternack Enterprises	PE7024-10	236358	08/31/2024	08/22/2023

AC Line Conducted					
Description	Manufacturer	Model	ID Num	Cal Due	Last Cal
EMI Test Receiver	Rohde & Schwarz	ESR	93091	02/29/2024	02/29/2023
LISN for Conducted Emissions CISPR-16	FISCHER CUSTOM COMMUNICATIONS	FCC-LISN-50/250-25-2-01-480V	175764	01/31/2024	01/31/2023
Transient Limiter	TE	TBFL1	207996	08/31/2024	08/10/2023

UL TEST SOFTWARE LIST			
Radiated Software	UL	UL EMC	Version 9.5, 01 May 2023
Conducted Software	UL	UL RF	2022.8.16
AC Line Conducted Software	UL	UL EMC	Version 9.5, 03 March 2023

9. ANTENNA PORT TEST RESULTS

9.1. ON TIME AND DUTY CYCLE

LIMITS

None; for reporting purposes only.

PROCEDURE

KDB 558074 Zero-Span Spectrum Analyzer Method.

ON TIME AND DUTY CYCLE RESULTS

Mode	ON Time B (msec)	Period (msec)	Duty Cycle x (linear)	Duty Cycle (%)	Duty Cycle Correction Factor (dB)	1/B Minimum VBW (kHz)
2.4GHz Band						
802.11b 1TX	8.607	8.839	0.974	97.38	0.12	0.116
802.11g 1TX	1.428	1.623	0.880	87.99	0.56	0.700
802.11n HT20 1TX	1.335	1.513	0.882	88.24	0.54	0.749

DUTY CYCLE PLOTS

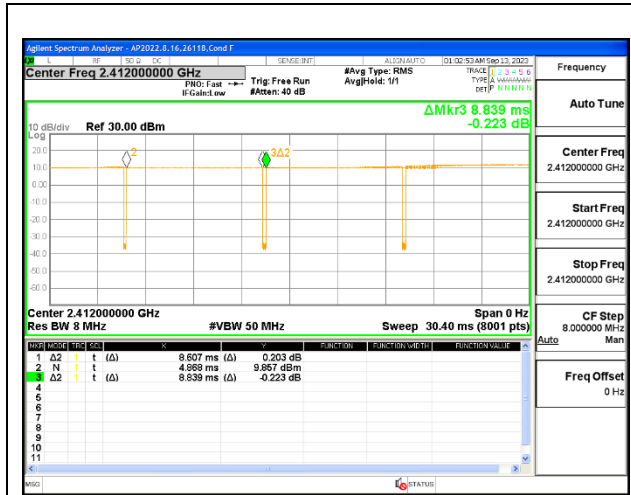

DUTY CYCLE 802.11b 1TX MODE

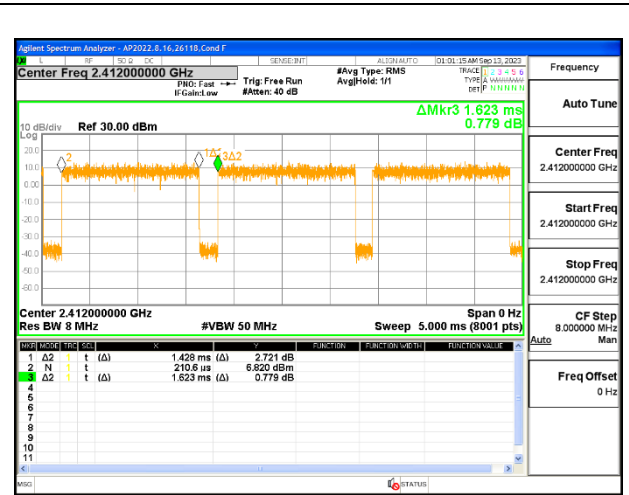

DUTY CYCLE 802.11g 1TX MODE

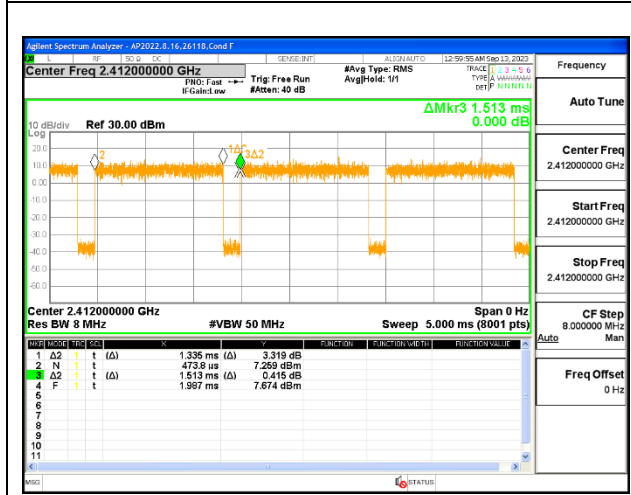

DUTY CYCLE 802.11n 1TX MODE

9.2. 99% BANDWIDTH

LIMITS

None; for reporting purposes only.

RESULTS

9.2.1. 802.11b MODE

1TX Antenna 1 MODE

Channel	Frequency (MHz)	99% Bandwidth (MHz)
Low 1	2412	13.702
Mid 6	2437	13.842
High 11	2462	13.778
High 12	2467	13.596
High 13	2472	13.504



9.2.2. 802.11g MODE

1TX Antenna 1 MODE

Channel	Frequency (MHz)	99% Bandwidth (MHz)
Low 1	2412	16.362
Mid 6	2437	16.370
High 11	2462	16.441
High 12	2467	16.389
High 13	2472	16.325

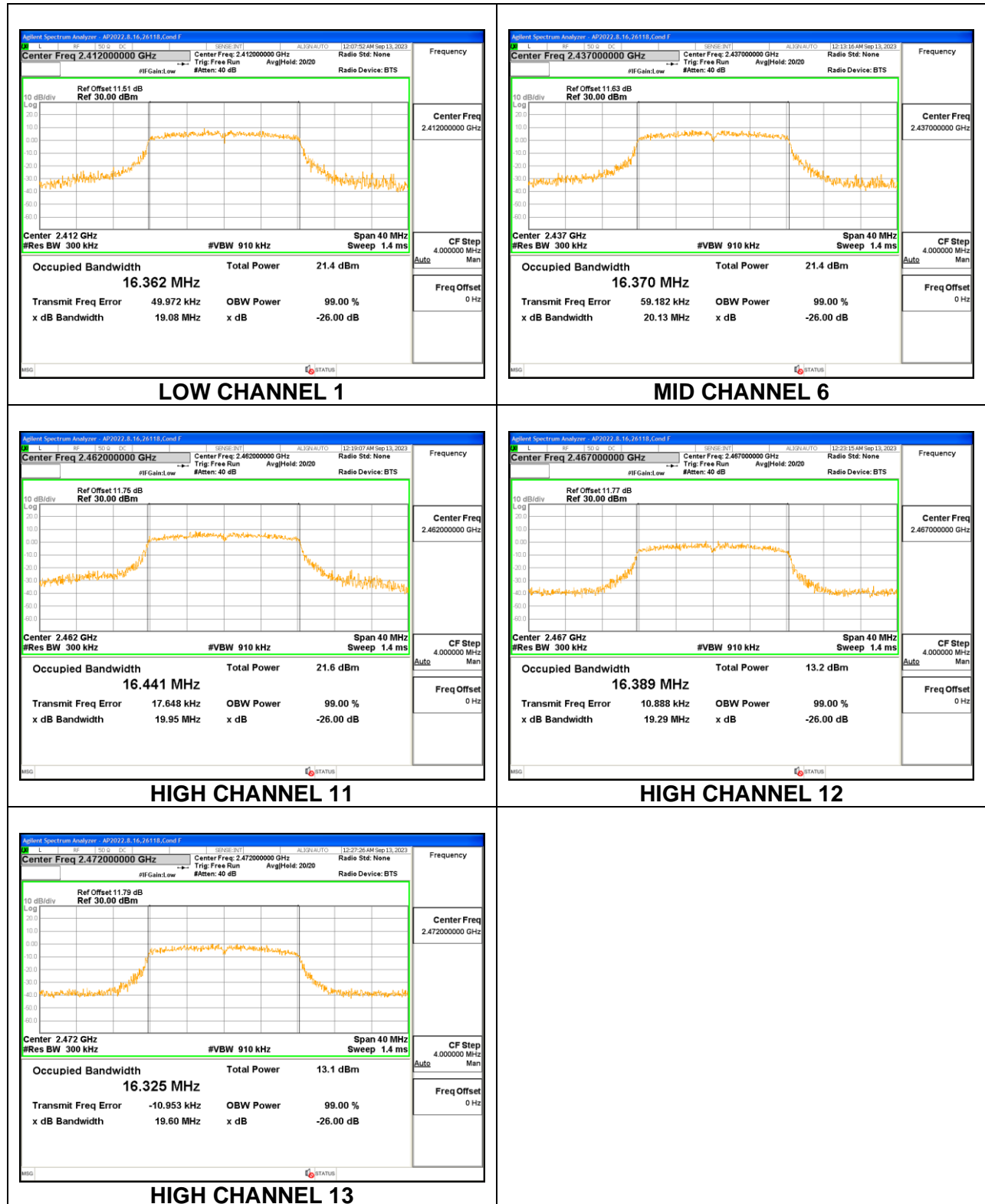

9.2.3. 802.11n HT20 MODE

1TX Antenna 1 MODE

Channel	Frequency (MHz)	99% Bandwidth (MHz)
Low 1	2412	17.472
Mid 6	2437	17.532
High 11	2462	17.421
High 12	2467	17.469
High 13	2472	17.450

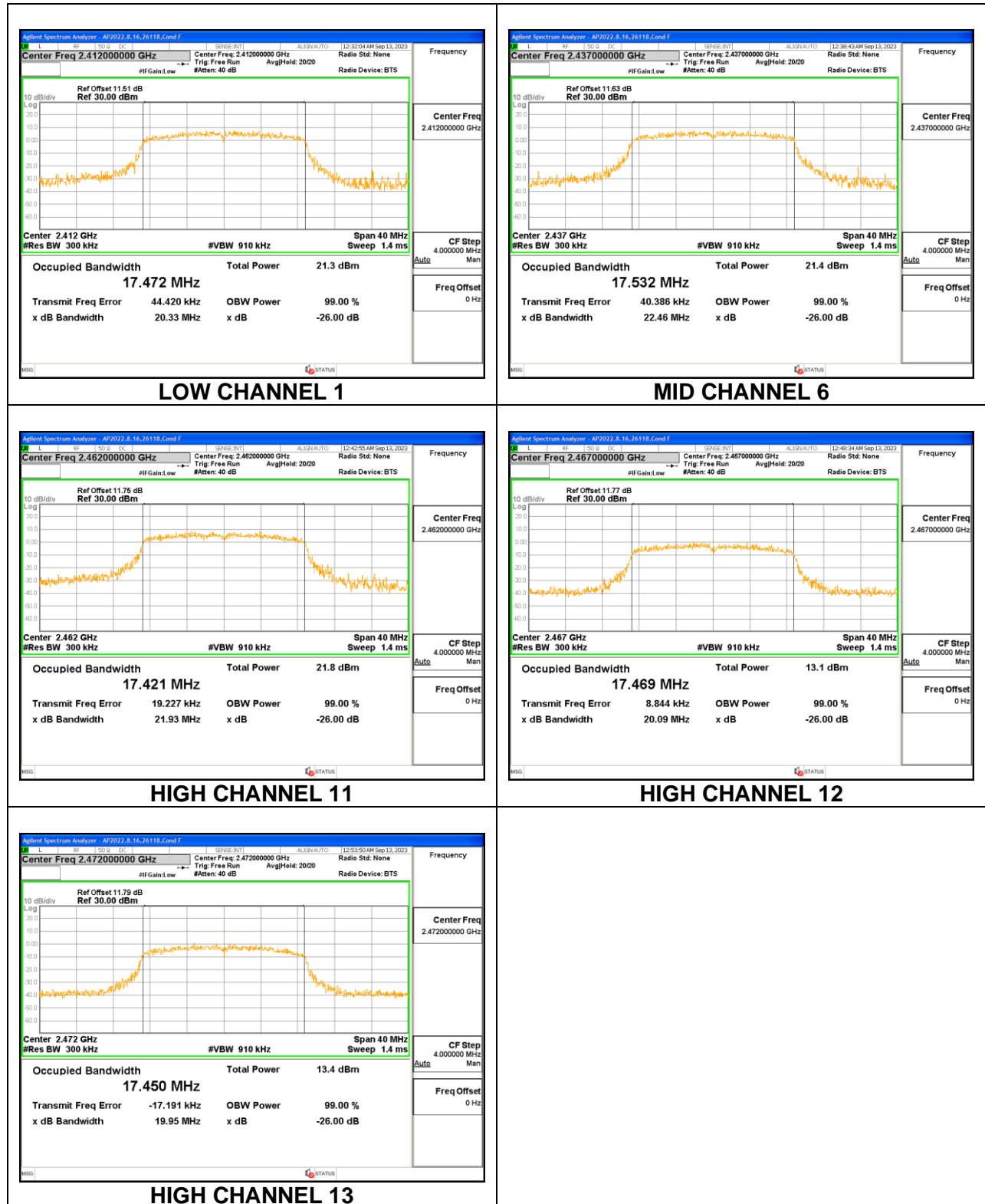

9.3. 6 dB BANDWIDTH

LIMITS

FCC §15.247 (a) (2)

The minimum 6 dB bandwidth shall be at least 500 kHz.

RESULTS

9.3.1. 802.11b MODE

1TX Antenna 1 MODE

Channel	Frequency (MHz)	6 dB Bandwidth (MHz)	Minimum Limit (MHz)
Low 1	2412	9.04	0.5
Mid 6	2437	9.60	0.5
High 11	2462	8.12	0.5
High 12	2467	8.96	0.5
High 13	2472	8.64	0.5

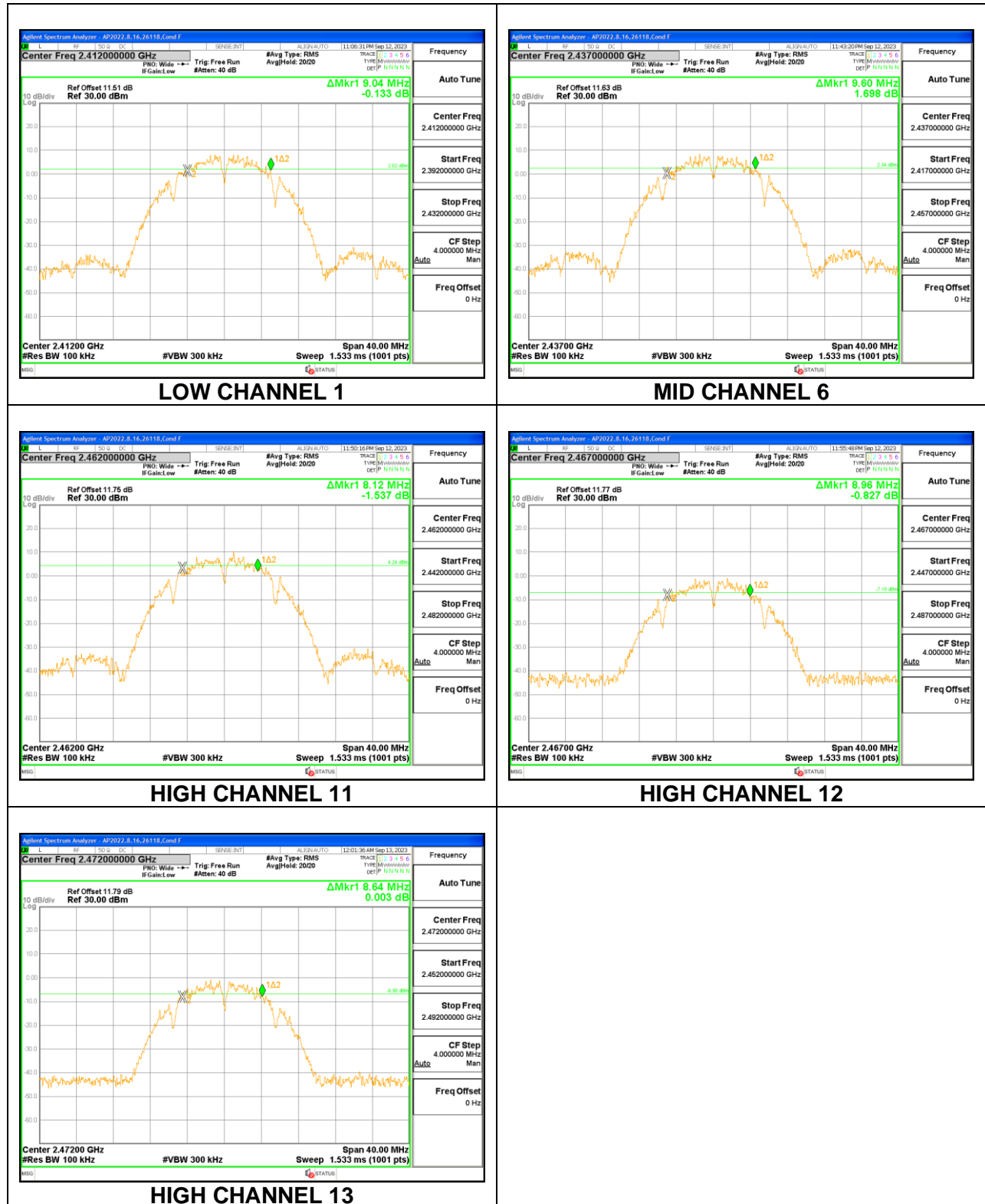

9.3.2. 802.11g MODE

1TX Antenna 1 MODE

Channel	Frequency (MHz)	6 dB Bandwidth (MHz)	Minimum Limit (MHz)
Low 1	2412	16.44	0.5
Mid 6	2437	16.04	0.5
High 11	2462	16.36	0.5
High 12	2467	16.40	0.5
High 13	2472	15.92	0.5

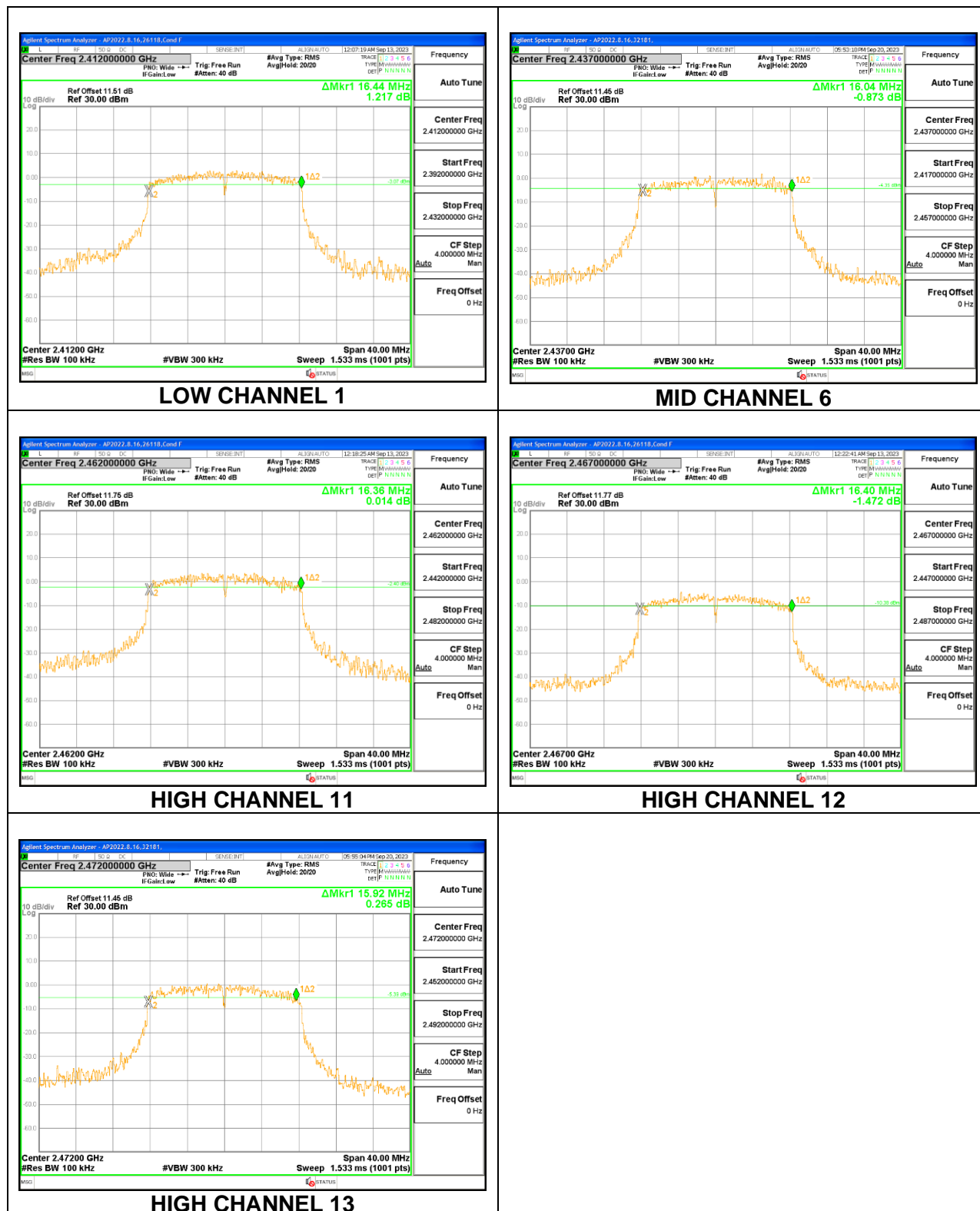

9.3.3. 802.11n HT20 MODE

1TX Antenna 1 MODE

Channel	Frequency (MHz)	6 dB Bandwidth (MHz)	Minimum Limit (MHz)
Low 1	2412	17.20	0.5
Mid 6	2437	17.60	0.5
High 11	2462	17.64	0.5
High 12	2467	17.44	0.5
High 13	2472	17.24	0.5

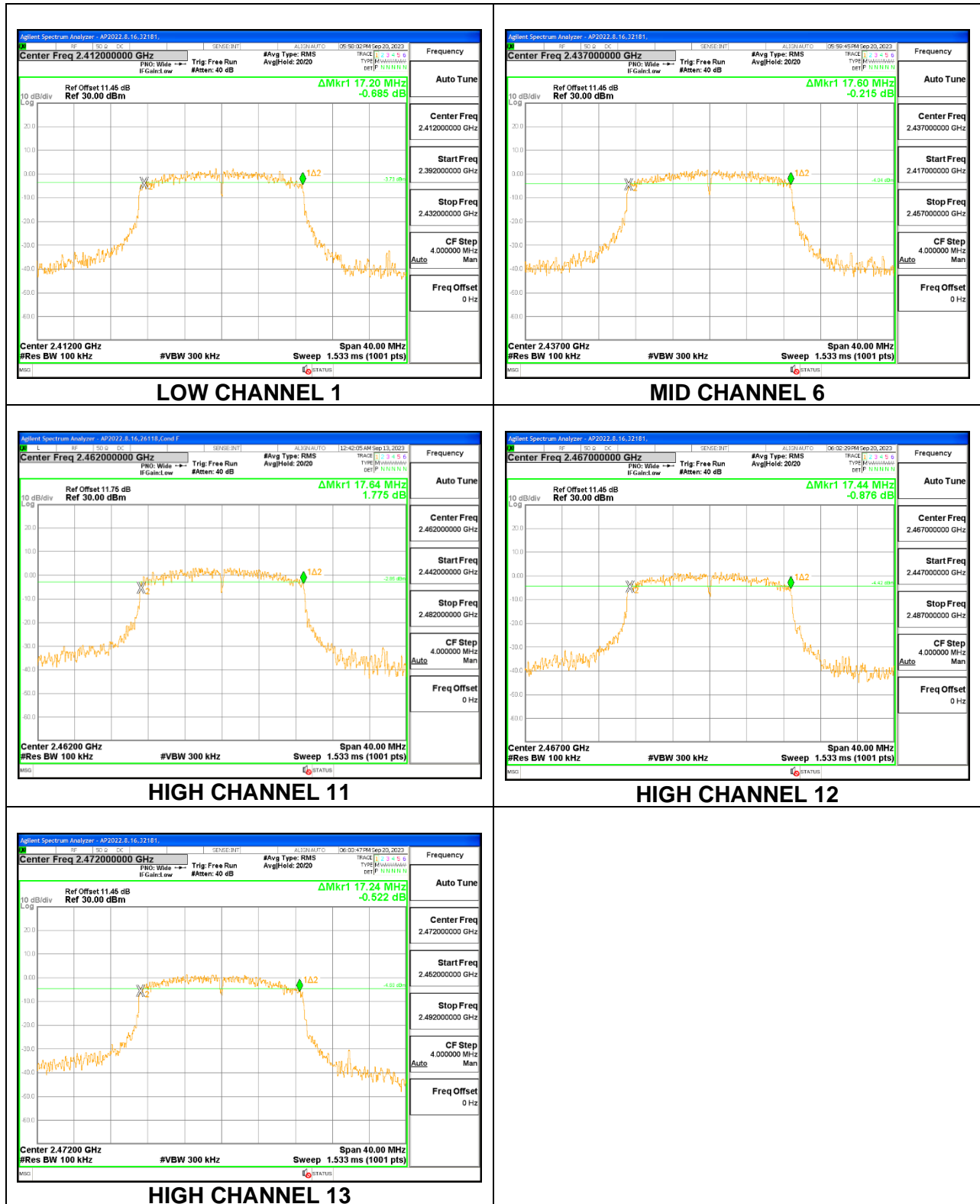

9.4. OUTPUT POWER

LIMITS

FCC §15.247 (b) (3)

For systems using digital modulation in the 902–928 MHz, 2400–2483.5 MHz, and 5725–5850 MHz bands: 1 Watt, based on the use of antennas with directional gains that do not exceed 6 dBi. If transmitting antennas of directional gain greater than 6 dBi are used, the conducted output power from the intentional radiator shall be reduced by the amount in dB that the directional gain of the antenna exceeds 6 dBi.

TEST PROCEDURE

The transmitter output is connected to a power meter.

The power output was measured on the EUT antenna port using SMA cable with 10dB attenuator connected to a power meter via wideband power sensor. Gated average output power was read directly from power meter.

DIRECTIONAL ANTENNA GAIN

For 1 TX:

There is only one transmitter output therefore the directional gain is equal to the antenna gain.

RESULTS

9.4.1. 802.11b MODE

1TX Antenna 1 MODE

Test Engineer:	24971
Test Date:	2023-09-12

Limits

Channel	Frequency (MHz)	Directional Gain (dBi)	FCC Power Limit (dBm)
Low 1	2412	-7.29	30.00
Mid 6	2437	-7.29	30.00
High 11	2462	-7.29	30.00
High 12	2467	-7.29	30.00
High 13	2472	-7.29	30.00

Results

Channel	Frequency (MHz)	Meas Power (dBm)	Total Corr'd Power (dBm)	Power Limit (dBm)	Margin (dB)
Low 1	2412	18.12	18.12	30.00	-11.88
Mid 6	2437	18.03	18.03	30.00	-11.97
High 11	2462	18.25	18.25	30.00	-11.75
High 12	2467	8.17	8.17	30.00	-21.83
High 13	2472	8.34	8.34	30.00	-21.66

9.4.2. 802.11g MODE

1TX Antenna 1 MODE

Test Engineer:	24971
Test Date:	2023-09-12

Limits

Channel	Frequency (MHz)	Directional Gain (dBi)	FCC Power Limit (dBm)
Low 1	2412	-7.29	30.00
Mid 6	2437	-7.29	30.00
High 10	2457	-7.29	30.00
High 11	2462	-7.29	30.00
High 12	2467	-7.29	30.00
High 13	2472	-7.29	30.00

Results

Channel	Frequency (MHz)	Meas Power (dBm)	Total Corr'd Power (dBm)	Power Limit (dBm)	Margin (dB)
Low 1	2412	16.29	16.29	30.00	-13.71
Mid 6	2437	16.31	16.31	30.00	-13.69
High 11	2462	16.03	16.03	30.00	-13.97
High 12	2467	8.16	8.16	30.00	-21.84
High 13	2472	8.04	8.04	30.00	-21.96

9.4.3. 802.11n HT20 MODE

1TX Antenna 1 MODE

Test Engineer:	24971
Test Date:	2023-09-12

Limits

Channel	Frequency (MHz)	Directional Gain (dBi)	FCC Power Limit (dBm)
Low 1	2412	-7.29	30.00
Mid 6	2437	-7.29	30.00
High 10	2457	-7.29	30.00
High 11	2462	-7.29	30.00
High 12	2467	-7.29	30.00
High 13	2472	-7.29	30.00

Results

Channel	Frequency (MHz)	Meas Power (dBm)	Total Corr'd Power (dBm)	Power Limit (dBm)	Margin (dB)
Low 1	2412	16.17	16.17	30.00	-13.83
Mid 6	2437	16.08	16.08	30.00	-13.92
High 11	2462	16.39	16.39	30.00	-13.61
High 12	2467	8.28	8.28	30.00	-21.72
High 13	2472	8.10	8.10	30.00	-21.90

9.5. POWER SPECTRAL DENSITY

LIMITS

FCC §15.247 (e)

The power spectral density conducted from the transmitter to the antenna shall not be greater than 8 dBm in any 3 kHz band during any time interval of continuous transmission.

RESULTS

9.5.1. 802.11b MODE

1TX Antenna 1 MODE

Duty Cycle CF (dB)	0.12	Included in Calculations of Corr'd PSD			
PSD Results					
Channel	Frequency (MHz)	Chain 0 Meas (dBm/3kHz)	Total Corr'd PSD (dBm/3kHz)	Limit (dBm/3kHz)	Margin (dB)
Low 1	2412	-3.08	-2.96	8.0	-11.0
Mid 6	2437	-3.31	-3.19	8.0	-11.2
High 11	2462	-3.12	-3.00	8.0	-11.0
High 12	2467	-12.75	-12.63	8.0	-20.6
High 13	2472	-12.58	-12.46	8.0	-20.5

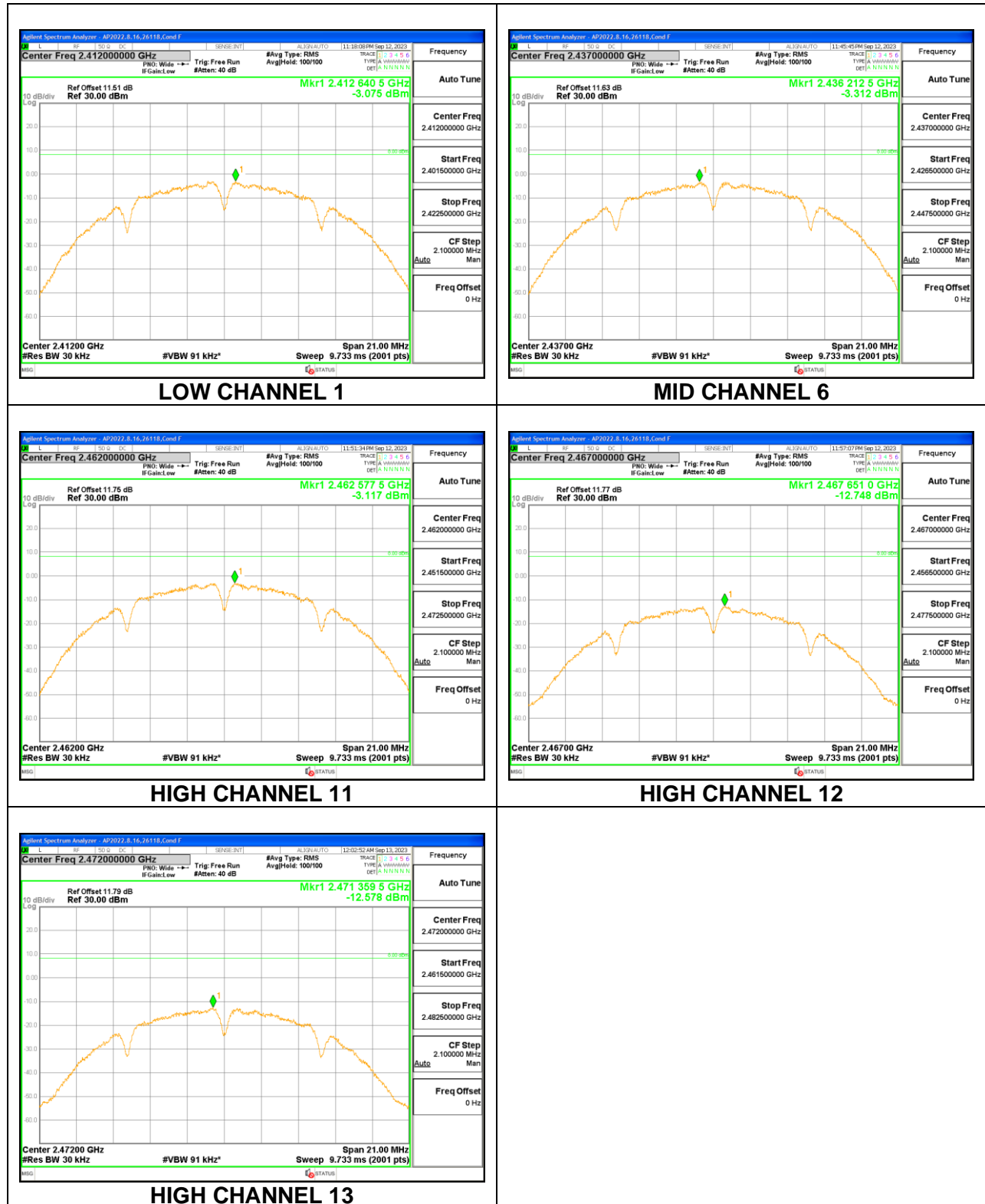

9.5.2. 802.11g MODE

1TX Antenna 1 MODE

Duty Cycle CF (dB)	0.56	Included in Calculations of Corr'd PSD
---------------------------	------	---

PSD Results

Channel	Frequency (MHz)	Chain 0 Meas (dBm/ 3kHz)	Total Corr'd PSD (dBm/ 3kHz)	Limit (dBm/ 3kHz)	Margin (dB)
Low 1	2412	-6.94	-6.38	8.0	-14.4
Mid 6	2437	-6.92	-6.36	8.0	-14.4
High 11	2462	-6.36	-5.80	8.0	-13.8
High 12	2467	-15.02	-14.46	8.0	-22.5
High 13	2472	-15.21	-14.65	8.0	-22.7

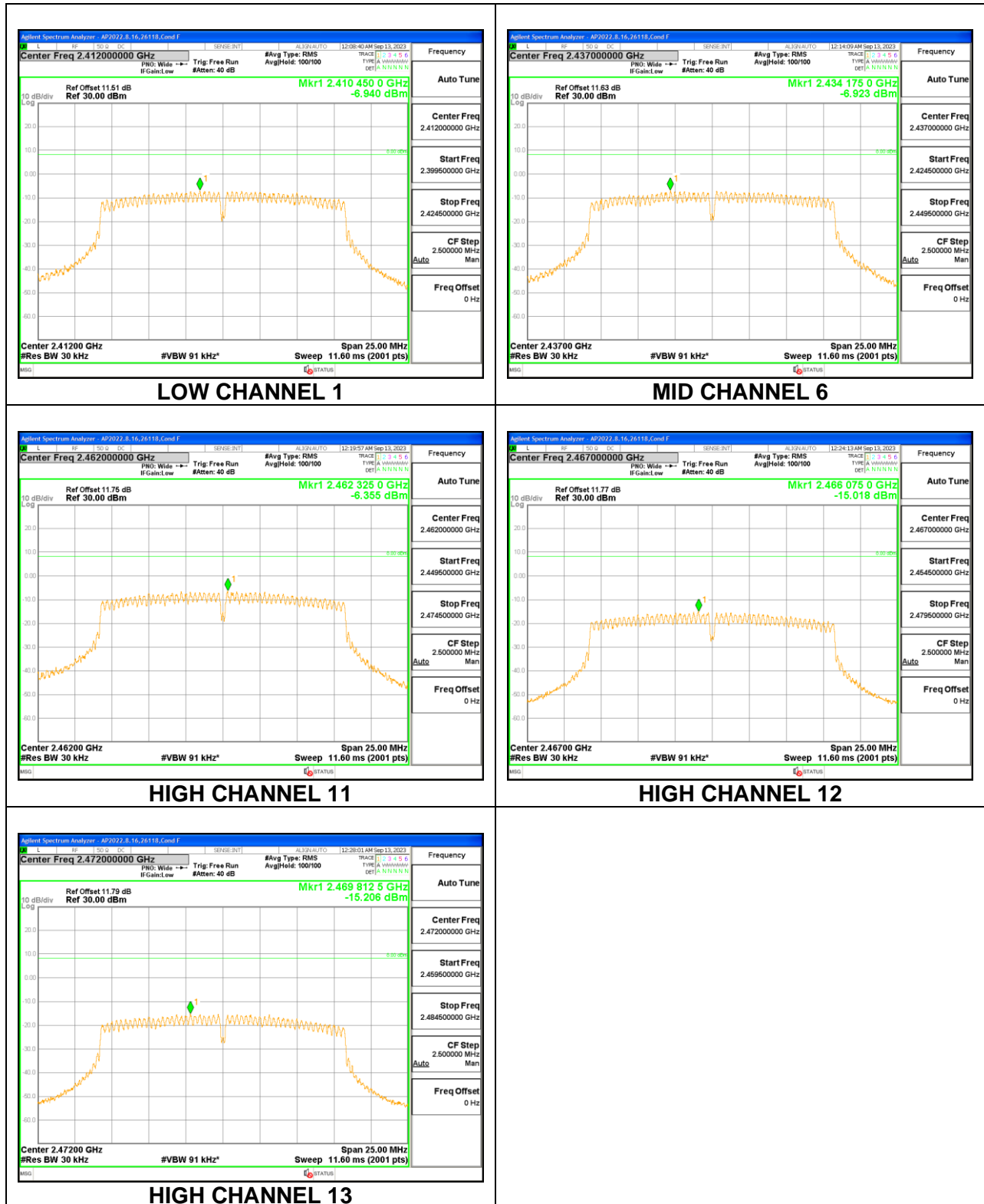

9.5.3. 802.11n HT20 MODE

1TX Antenna 1 MODE

Duty Cycle CF (dB)	0.54	Included in Calculations of Corr'd PSD
---------------------------	------	---

PSD Results

Channel	Frequency (MHz)	Chain 0 Meas (dBm/ 3kHz)	Total Corr'd PSD (dBm/ 3kHz)	Limit (dBm/ 3kHz)	Margin (dB)
Low 1	2412	-6.44	-5.90	8.0	-13.9
Mid 6	2437	-6.21	-5.67	8.0	-13.7
High 11	2462	-7.09	-6.55	8.0	-14.6
High 12	2467	-15.40	-14.86	8.0	-22.9
High 13	2472	-14.74	-14.20	8.0	-22.2

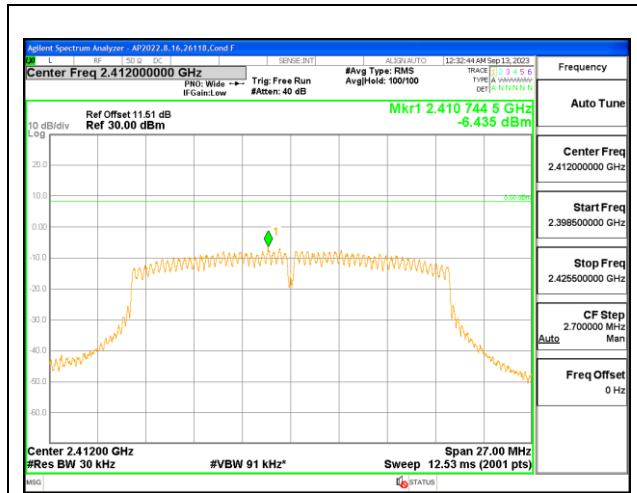

LOW CHANNEL 1

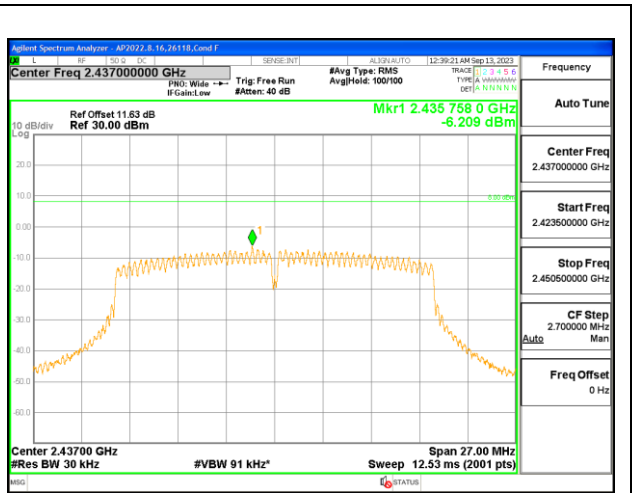

MID CHANNEL 6

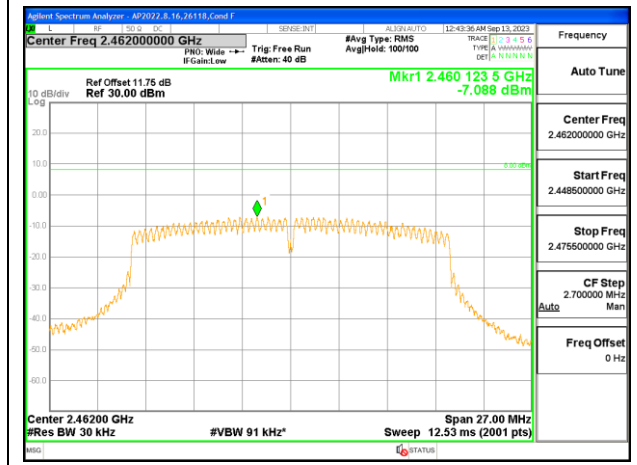

HIGH CHANNEL 11

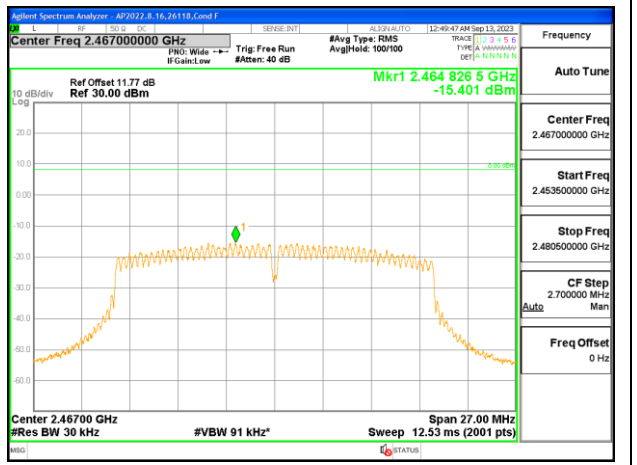

HIGH CHANNEL 12

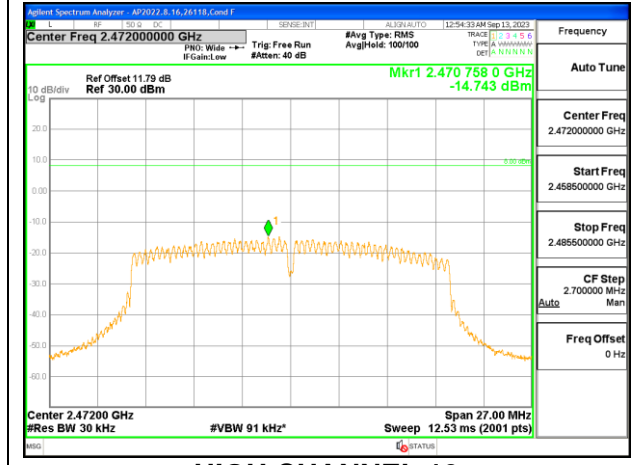

HIGH CHANNEL 13

9.6. CONDUCTED SPURIOUS EMISSIONS

LIMITS

FCC §15.247 (d)

Output power was measured based on the use of average measurement; therefore, the required attenuation is 30 dB.

RESULTS

9.6.1. 802.11b MODE

1TX Antenna 1 MODE

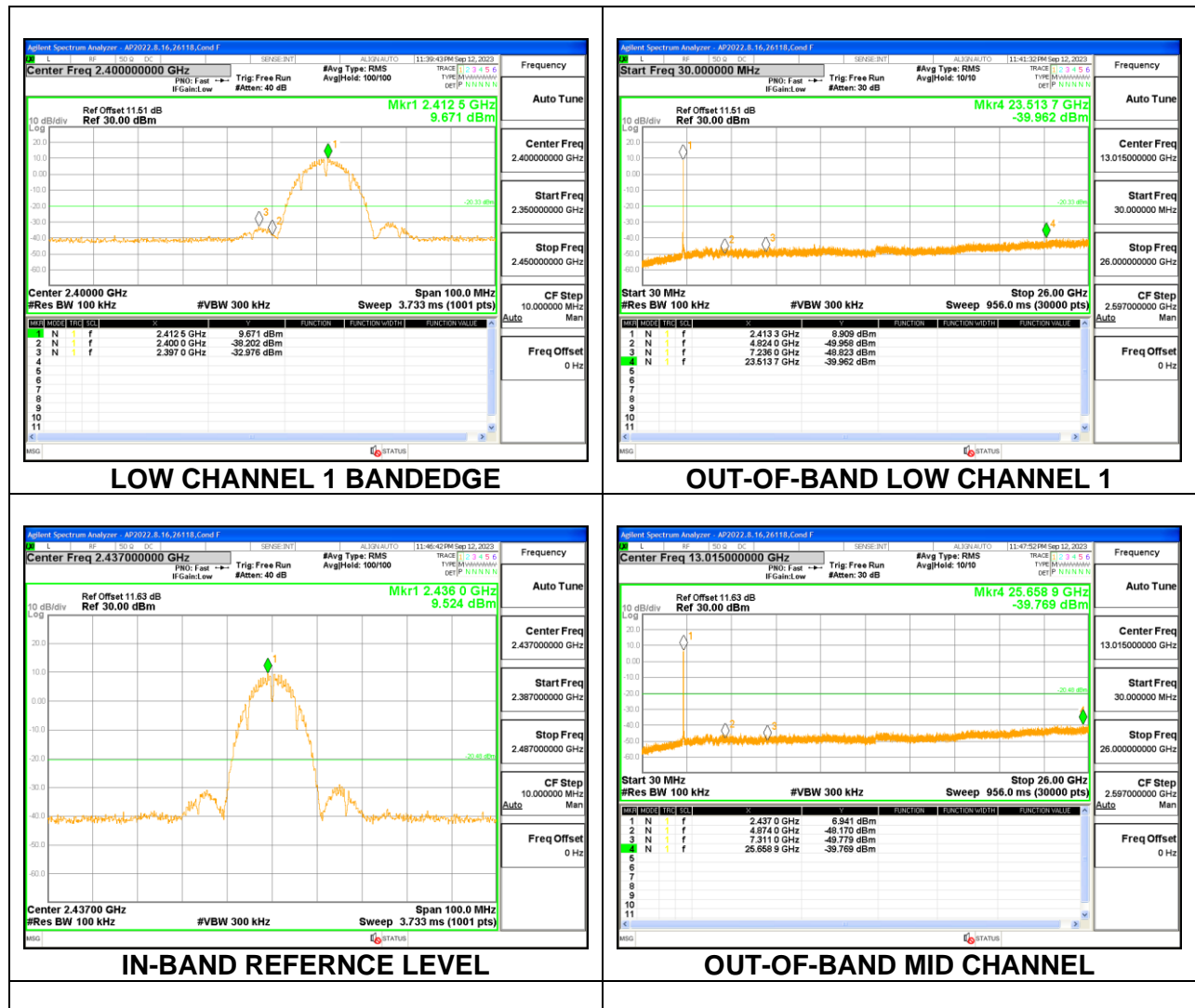

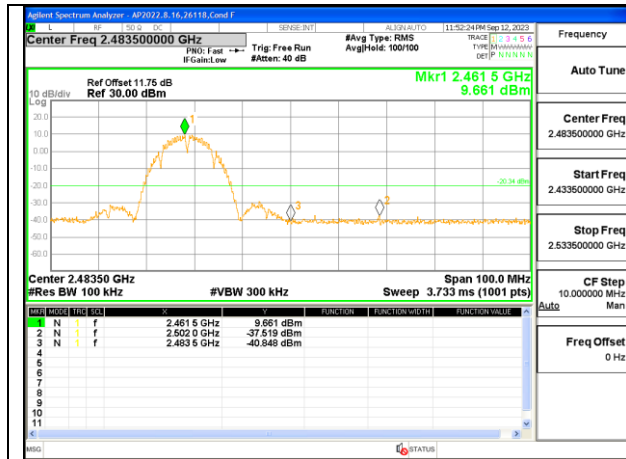

HIGH CHANNEL 11 BANDEDGE

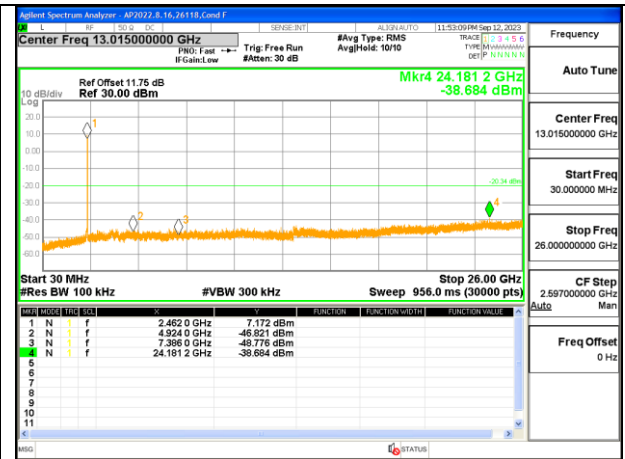

OUT-OF-BAND HIGH CHANNEL 11

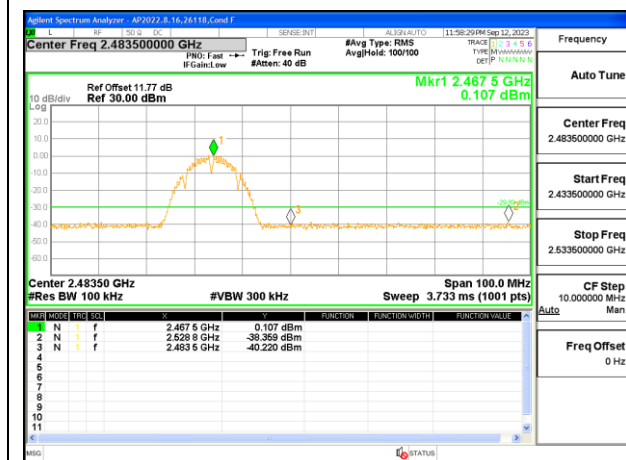

HIGH CHANNEL 12 BANDEDGE

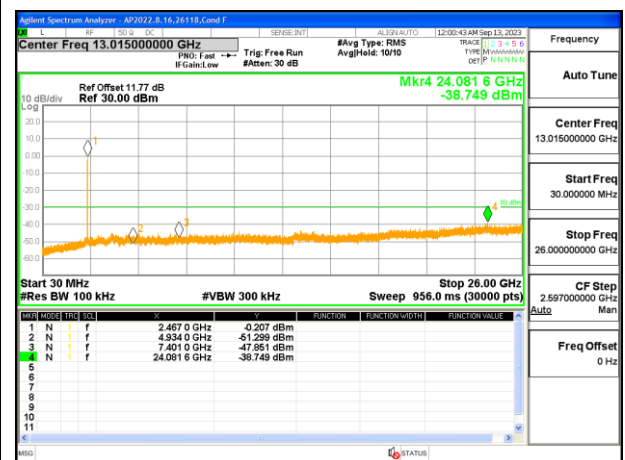

OUT-OF-BAND HIGH CHANNEL 12

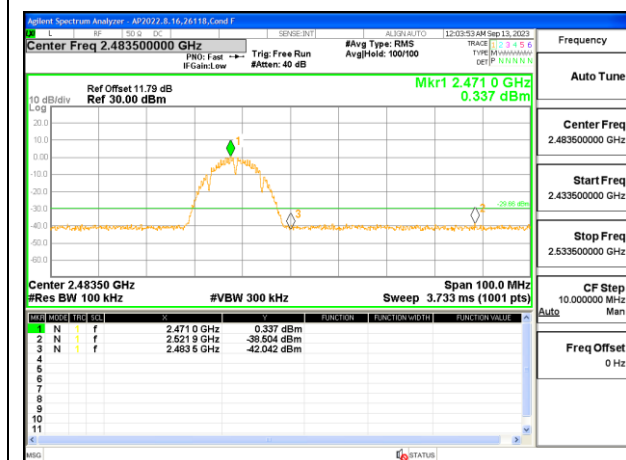

HIGH CHANNEL 13 BANDEDGE

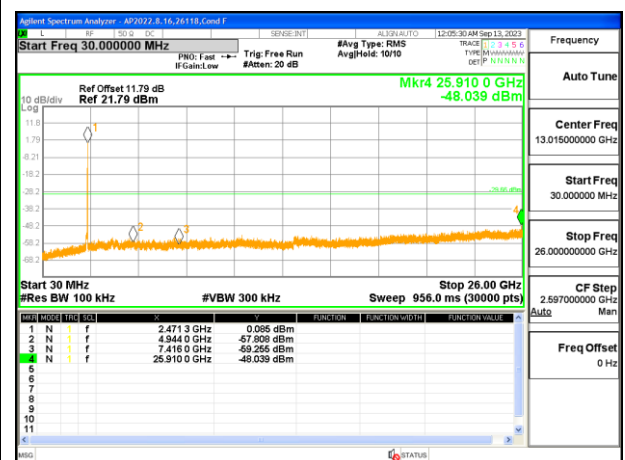

OUT-OF-BAND HIGH CHANNEL 13

9.6.2. 802.11g MODE

1TX Antenna 1 MODE

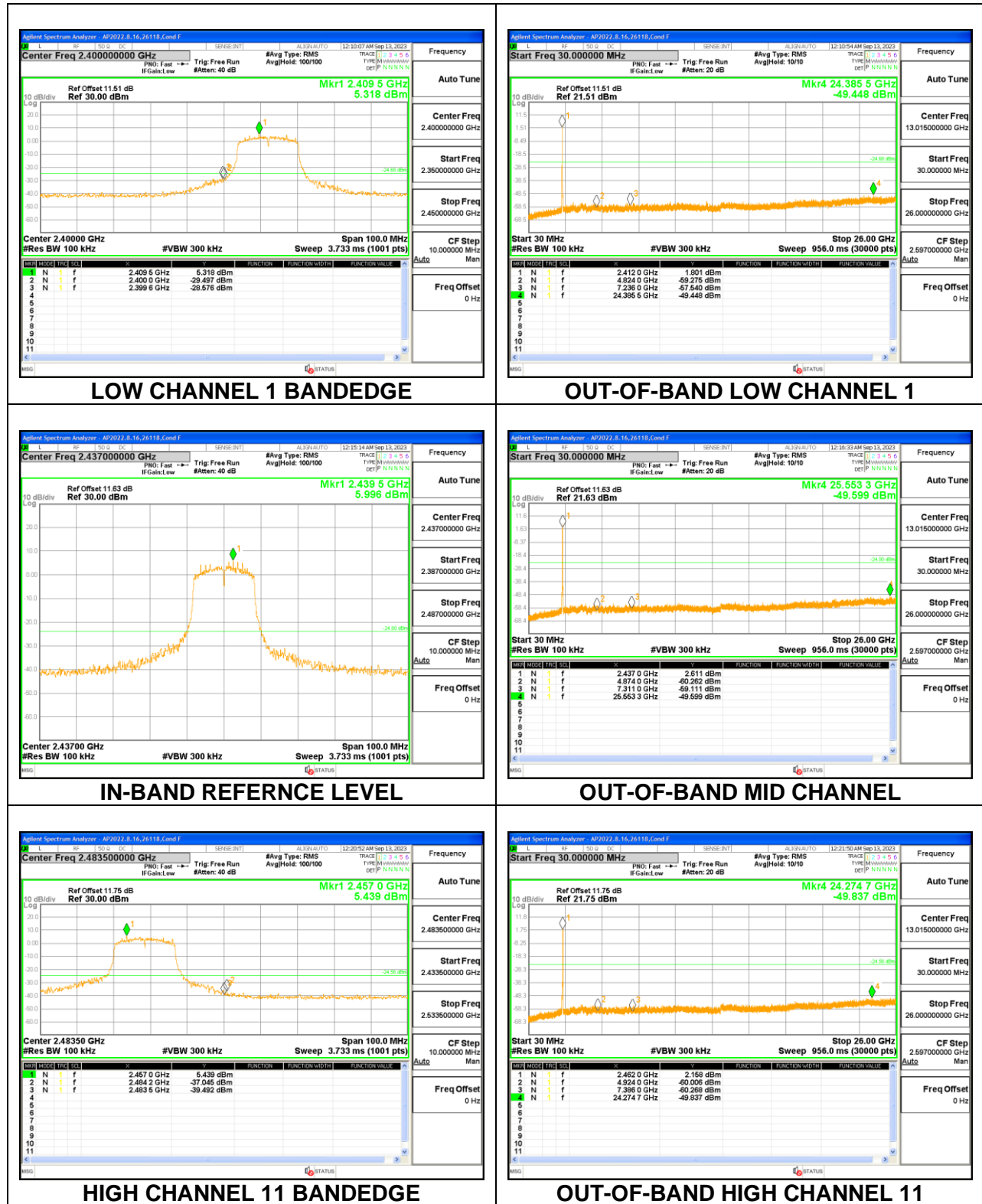

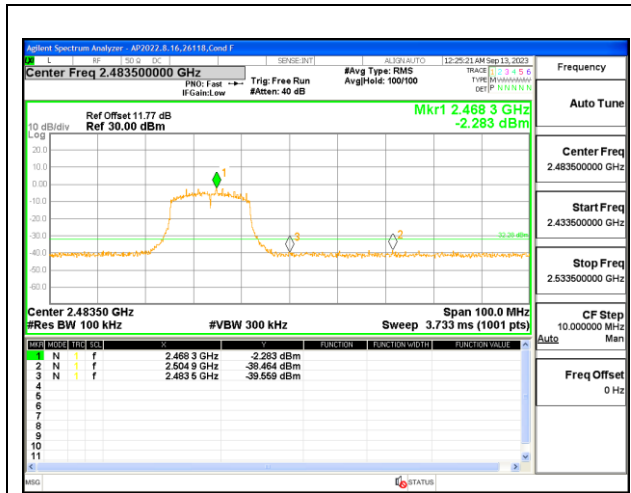

HIGH CHANNEL 12 BANDEDGE

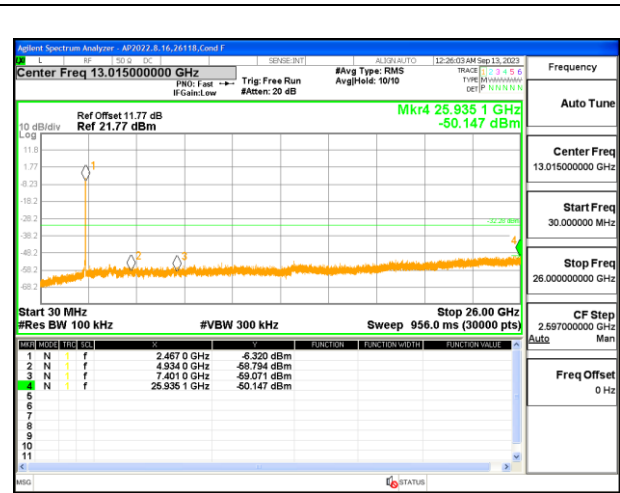

OUT-OF-BAND HIGH CHANNEL 12

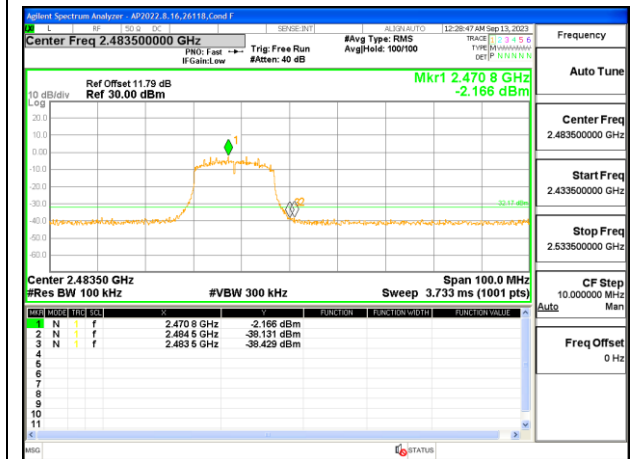

HIGH CHANNEL 13 BANDEDGE

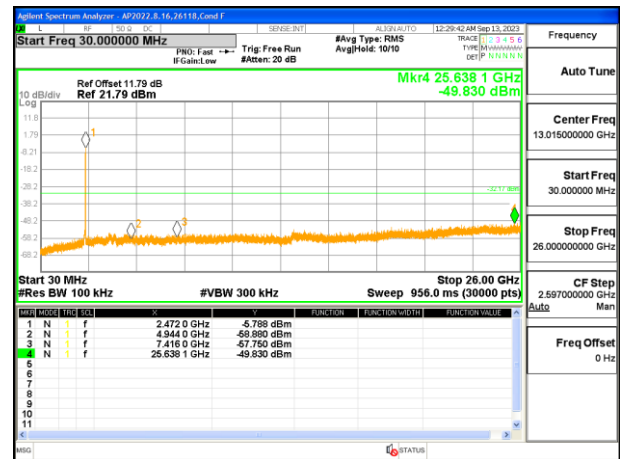

OUT-OF-BAND HIGH CHANNEL 13

9.6.3. 802.11n HT20 MODE

1TX Antenna 1 MODE

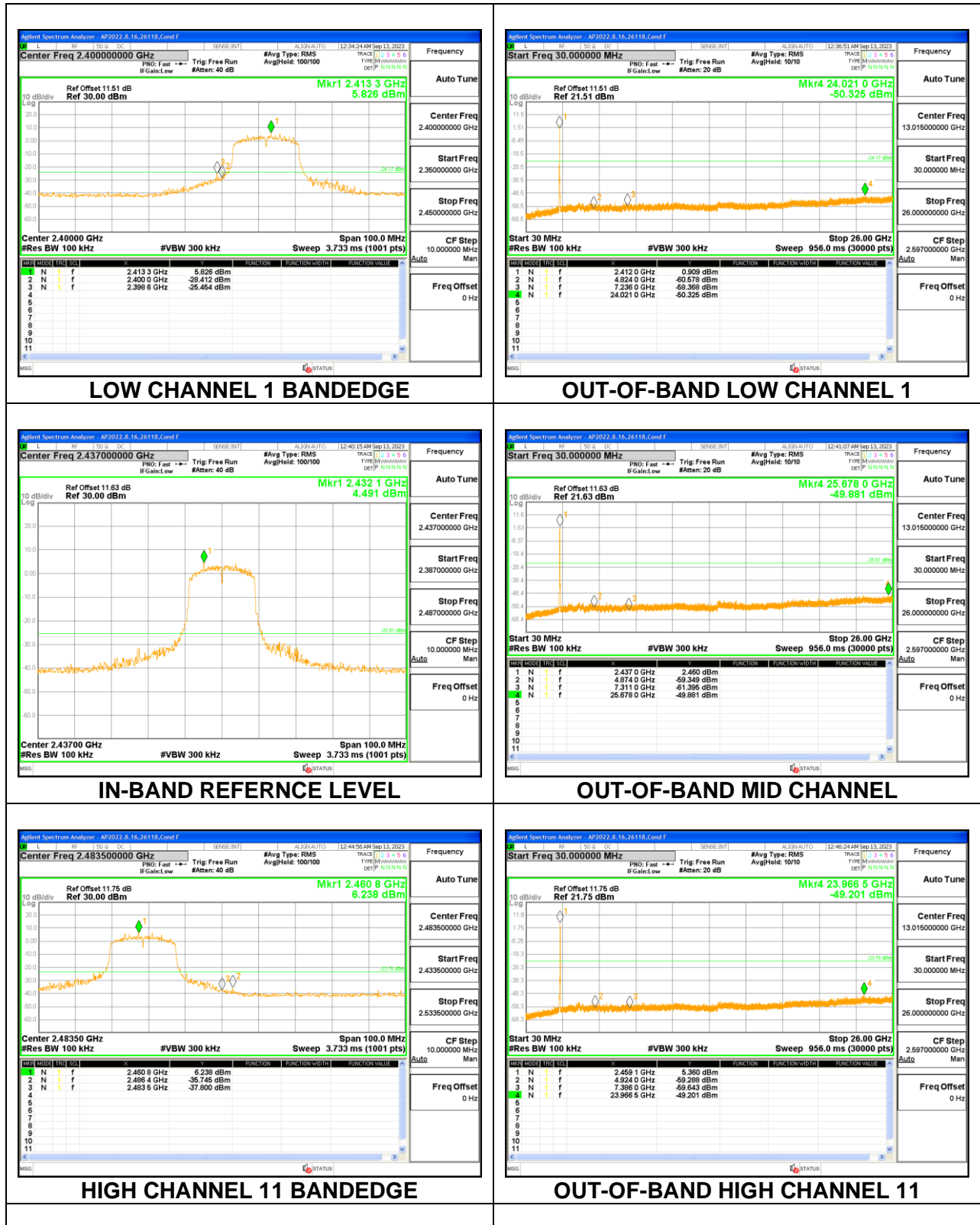

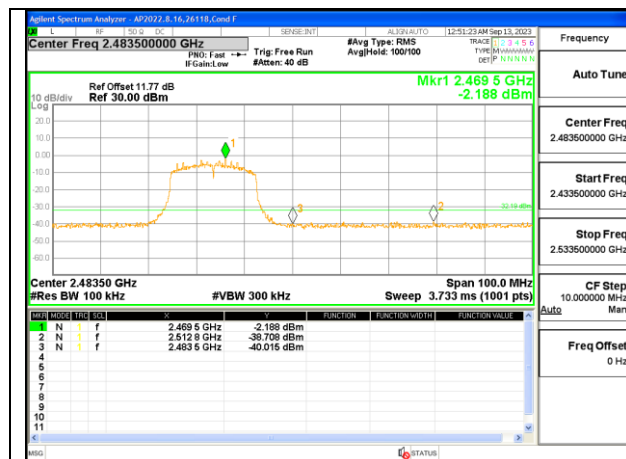

HIGH CHANNEL 12 BANDEDGE

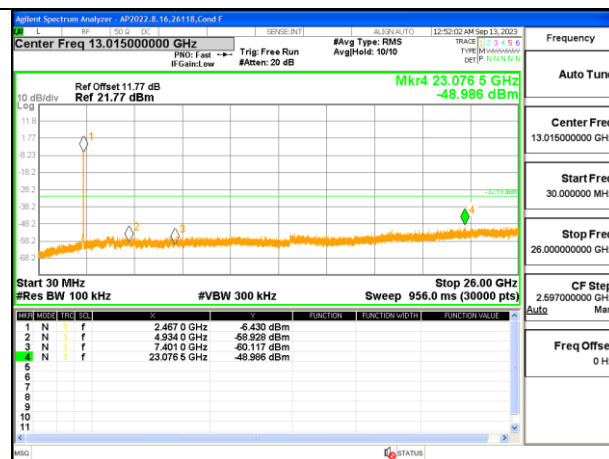

OUT-OF-BAND HIGH CHANNEL 12

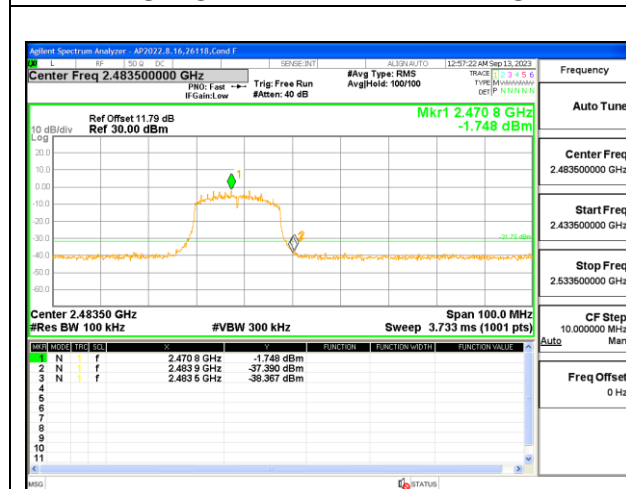

HIGH CHANNEL 13 BANDEDGE

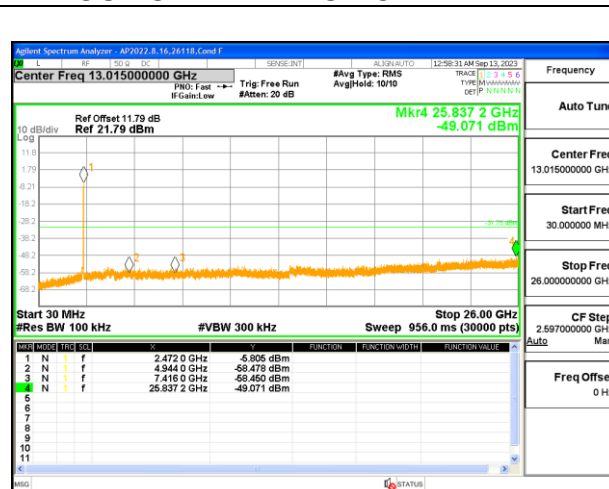

OUT-OF-BAND HIGH CHANNEL 13

10. RADIATED TEST RESULTS

LIMITS

FCC §15.205 and §15.209

Frequency Range (MHz)	Field Strength Limit (uV/m) at 3 m	Field Strength Limit (dBuV/m) at 3 m
0.009-0.490	2400/F(kHz) @ 300 m	-
0.490-1.705	24000/F(kHz) @ 30 m	-
1.705 - 30	30 @ 30m	-
30 - 88	100	40
88 - 216	150	43.5
216 - 960	200	46
Above 960	500	54

TEST PROCEDURE

The EUT is placed on a non-conducting table 80 cm above the ground plane for measurement below 1GHz; 1.5 m above the ground plane for measurement above 1GHz. The antenna to EUT distance is 3 meters. The EUT is configured in accordance with ANSI C63.10. The EUT is set to transmit in a continuous mode.

For measurements below 1 GHz the resolution bandwidth is set to 100 kHz for peak detection measurements or 120 kHz for quasi-peak detection measurements in the 30-1000MHz range, 9kHz for peak and/or quasi-peak detection measurements in the 0.15-30MHz range and 200Hz for peak and/or quasi-peak detection measurements in the 9 to 150kHz range. Peak detection is used unless otherwise noted as quasi-peak or average (9-90kHz and 110-490kHz).

For pre-scans above 1 GHz the resolution bandwidth is set to 1 MHz; the video bandwidth is set to 30 KHz for peak measurements.

For final measurements above 1 GHz the resolution bandwidth is set to 1 MHz; the video bandwidth is set to 3 MHz for peak measurements and as applicable for average measurements.

The spectrum from 1 GHz to 18 GHz is investigated with the transmitter set to the lowest, middle, and highest channels in each applicable band. Below 1GHz and above 18GHz emissions, the channel with the highest output power was tested.

The frequency range of interest is monitored at a fixed antenna height and EUT azimuth. The EUT is rotated through 360 degrees to maximize emissions received. The antenna is scanned from 1 to 4 meters above the ground plane to further maximize the emission. Measurements are made with the antenna polarized in both the vertical and the horizontal positions.

2D antenna use - For below 30MHz testing, investigation was done on three antenna orientations (parallel, perpendicular, and ground-parallel), parallel and perpendicular are the worst orientations, therefore testing was performed on these two orientations only.

Base on FCC 15.31 (f) (2): measurements may be performed at a distance closer than that specified in the regulations; however, an attempt should be made to avoid making measurements in the near field.

KDB 414788 Open Field Site (OFS) and Chamber Correlation Justification

OFS and chamber correlation testing had been performed and chamber measured test result is the worst-case test result.

10.1. TRANSMITTER ABOVE 1 GHz

10.1.1. TX ABOVE 1 GHz 802.11b MODE IN THE 2.4 GHz BAND

1TX Antenna 1 MODE

BANDEDGE (LOW CHANNEL, CH 1)

HORIZONTAL RESULT

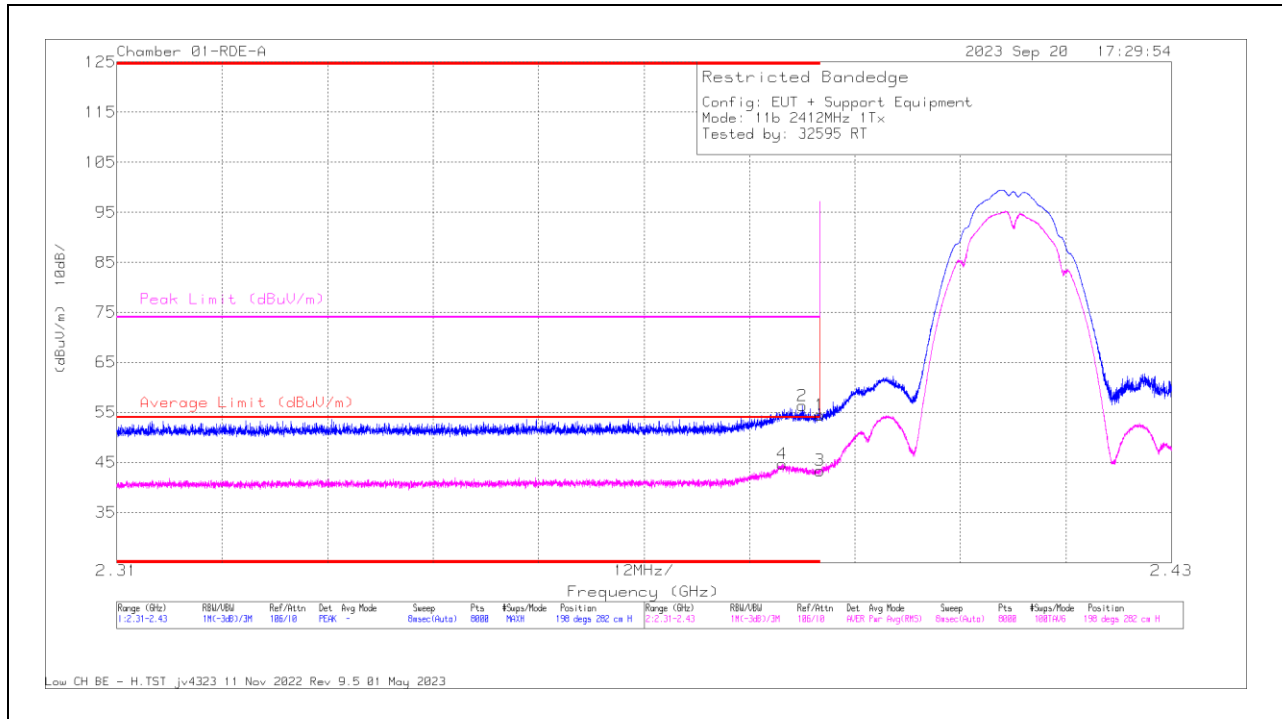

Trace Markers

Marker	Frequency (GHz)	Meter Reading (dBuV)	Det	81886 ACF 3m (dBm)	DCCF (dB)	Gain/Loss (dB)	Corrected Reading (dBuV/m)	Average Limit (dBuV/m)	Margin (dB)	Peak Limit (dBuV/m)	PK Margin (dB)	Azimuth (Degs)	Height (cm)	Polarity
1	* 2.339	41.58	PK	32.2	0	-19.35	54.43	-	-	74	-19.57	198	282	H
2	* 2.38025	43.46	PK	32.2	0	-19.36	56.3	-	-	74	-17.7	198	282	H
3	* 2.39	30.43	RMS	32.2	12	-19.35	43.4	54	-10.6	-	-	198	282	H
4	* 2.385685	31.79	RMS	32.2	12	-19.38	44.73	54	-9.27	-	-	198	282	H

* - indicates frequency in CFR47 Pt 15 / IC RSS-Restricted Band
 Pk - Peak detector
 RMS - RMS detection

VERTICAL RESULT

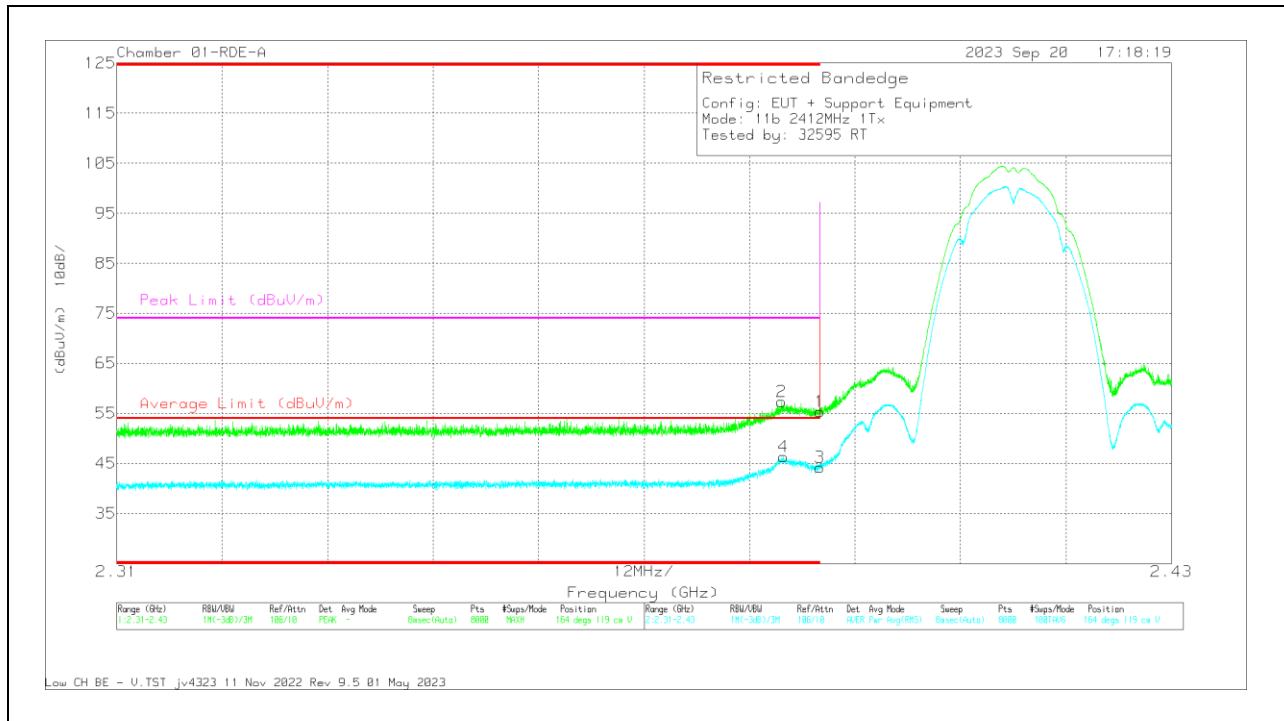

Trace Markers

Marker	Frequency (GHz)	Meter Reading (dBuV)	Det	#1888 ACF 3m (dBm)	DCCF (dB)	Gain/Loss (dB)	Corrected Reading (dBuV/m)	Average Limit (dBuV/m)	Margin (dB)	Peak Limit (dBuV/m)	PK Margin (dB)	Azimuth (Degs)	Height (cm)	Polarity
1	* 2.39	42.46	Pk	32.2	0	-19.35	55.31	-	-	74	-18.69	164	119	V
2	* 2.38564	44.49	Pk	32.2	0	-19.38	57.31	-	-	74	-16.69	164	119	V
3	* 2.39	31.3	RMS	32.2	.12	-19.35	44.27	54	-9.73	-	-	164	119	V
4	* 2.38585	33.35	RMS	32.2	.12	-19.38	46.29	54	-7.71	-	-	164	119	V

* - indicates frequency in CFR47 Pt 15 / IC RSS-Restricted Band
 Pk - Peak detector
 RMS - RMS detection

BANDEDGE (HIGH CHANNEL, CH 11)

HORIZONTAL RESULT

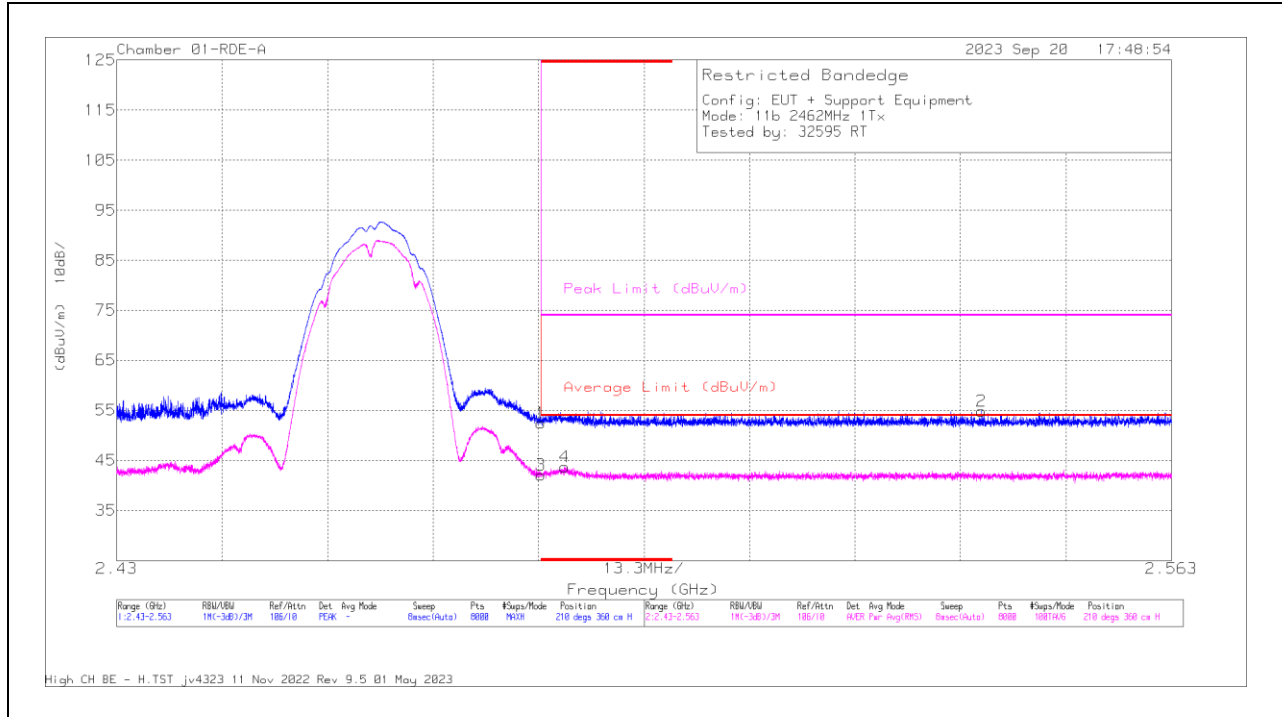

Trace Markers

Marker	Frequency (GHz)	Meter Reading (dBuV)	Det	81896 ACF 3m (dBm)	DCCF (dB)	Gain/Loss (dB)	Corrected Reading (dBuV/m)	Average Limit (dBuV/m)	Margin (dB)	Peak Limit (dBuV/m)	PK Margin (dB)	Azimuth (Degs)	Height (cm)	Polarity
1	* 2.4835	38.89	PK	32.5	0	-18.86	52.52	-	-	74	-21.48	210	360	H
3	* 2.4835	28.37	RMS	32.5	12	-18.86	42.19	54	-11.87	-	-	210	360	H
4	* 2.48615	29.94	RMS	32.5	12	-18.86	43.7	54	-10.3	-	-	210	360	H
2	2.539056	40.98	PK	32.5	0	-18.66	54.82	-	-	74	-19.18	210	360	H

* - indicates frequency in CFR47 Pt 15 / IC RSS-Restricted Band
 PK - Peak detector
 RMS - RMS detection

VERTICAL RESULT

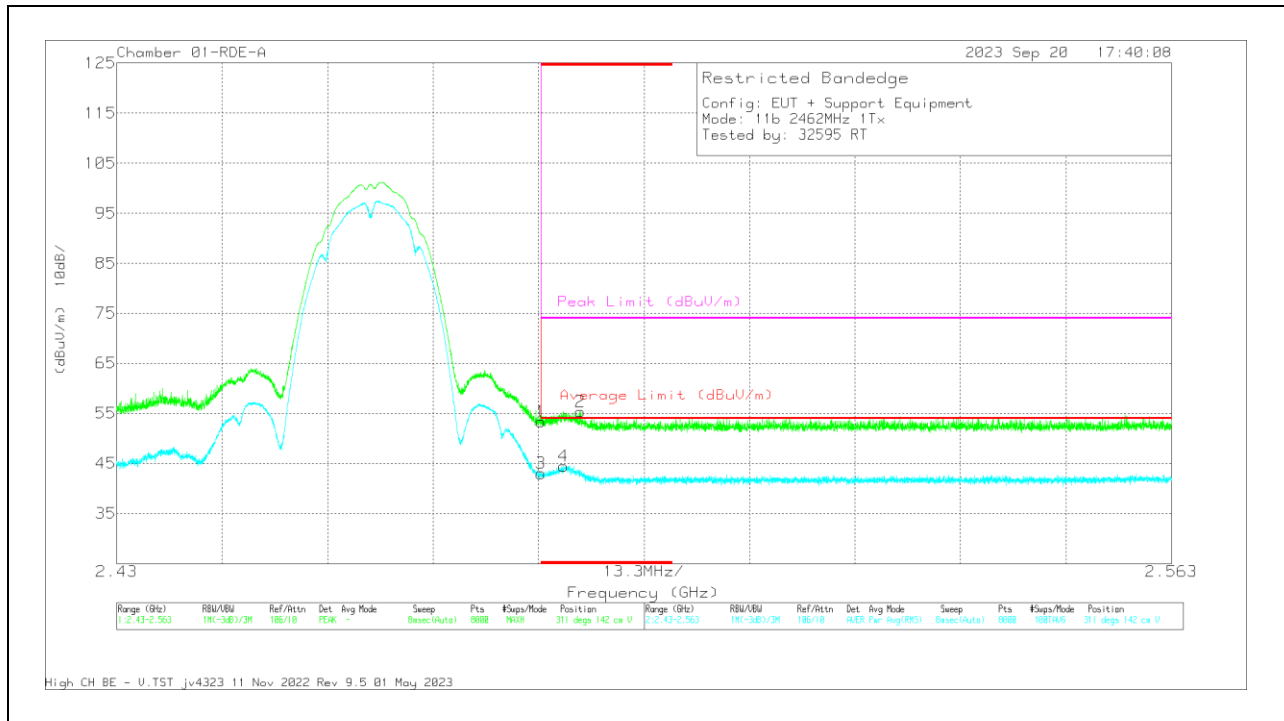

Trace Markers

Marker	Frequency (GHz)	Meter Reading (dBuV)	Det	81880 ACF 3m (dBm)	DCCF (dB)	Gain/Loss (dB)	Corrected Reading (dBuV/m)	Average Limit (dBuV/m)	Margin (dB)	Peak Limit (dBuV/m)	PK Margin (dB)	Azimuth (Degs)	Height (cm)	Polarity
1	* 2.4835	39.66	Pk	32.5	0	-18.86	53.3	-	-	74	-20.7	311	142	V
2	* 2.488444	41.72	Pk	32.5	0	-18.84	55.38	-	-	74	-18.62	311	142	V
3	* 2.4835	29.27	RMS	32.5	12	-18.86	43.03	54	-10.97	-	-	311	142	V
4	* 2.486366	30.73	RMS	32.5	12	-18.85	44.5	54	-9.5	-	-	311	142	V

* - indicates frequency in CFR47 Pt 15 / IC RSS-Restricted Band
 Pk - Peak detector
 RMS - RMS detection

BANDEDGE (HIGH CHANNEL, CH 12)

HORIZONTAL RESULT

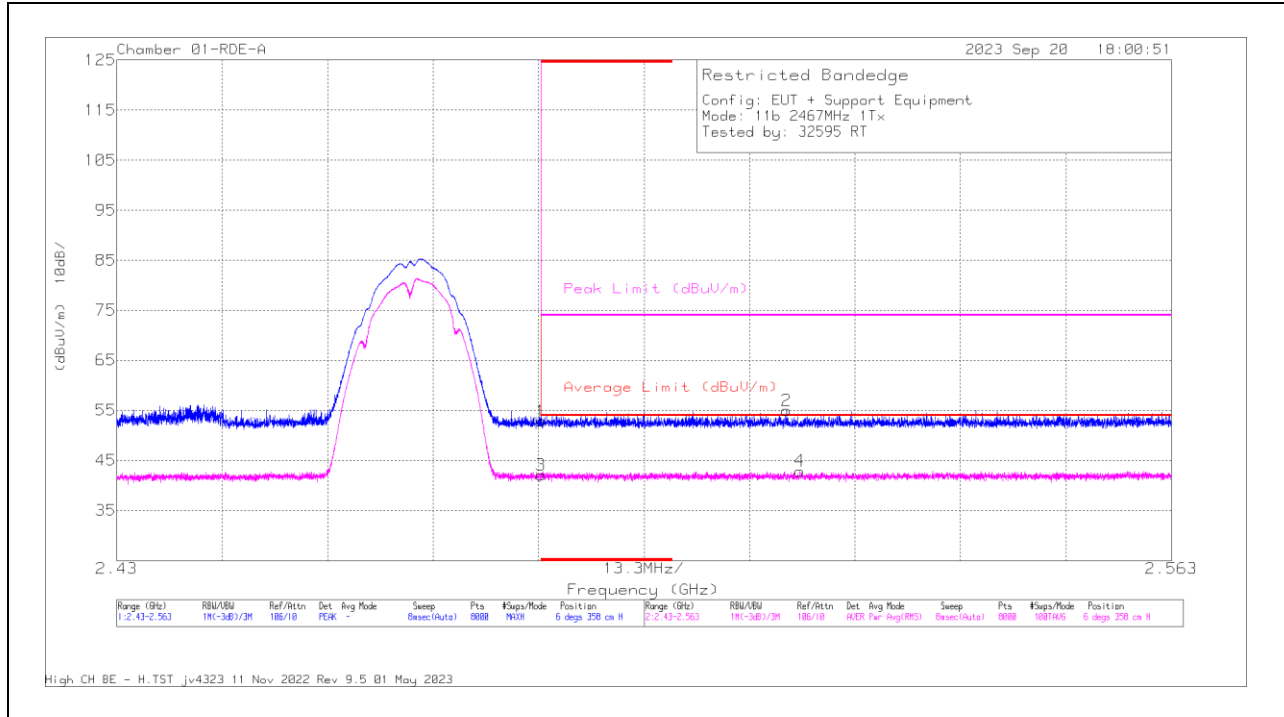

Trace Markers

Marker	Frequency (GHz)	Meter Reading (dBuV)	Det	81888 ACF 3m (dBm)	DCCF (dB)	Gain/Loss (dB)	Corrected Reading (dBuV/m)	Average Limit (dBuV/m)	Margin (dB)	Peak Limit (dBuV/m)	PK Margin (dB)	Azimuth (Degs)	Height (cm)	Polarity
1	2.4835	39.17	Pk	32.5	0	-18.86	52.81	-	-	74	-21.19	6	358	H
3	2.4835	28.33	RMS	32.5	.12	-18.86	42.09	54	-11.91	-	-	6	358	H
2	2.514482	41.12	Pk	32.5	0	-18.7	54.92	-	-	74	-19.08	6	358	H
4	2.516128	28.98	RMS	32.5	.12	-18.7	42.9	54	-11.1	-	-	6	358	H

* - indicates frequency in CFR47 Pt 15 / IC RSS-Restricted Band
 Pk - Peak detector
 RMS - RMS detection

VERTICAL RESULT

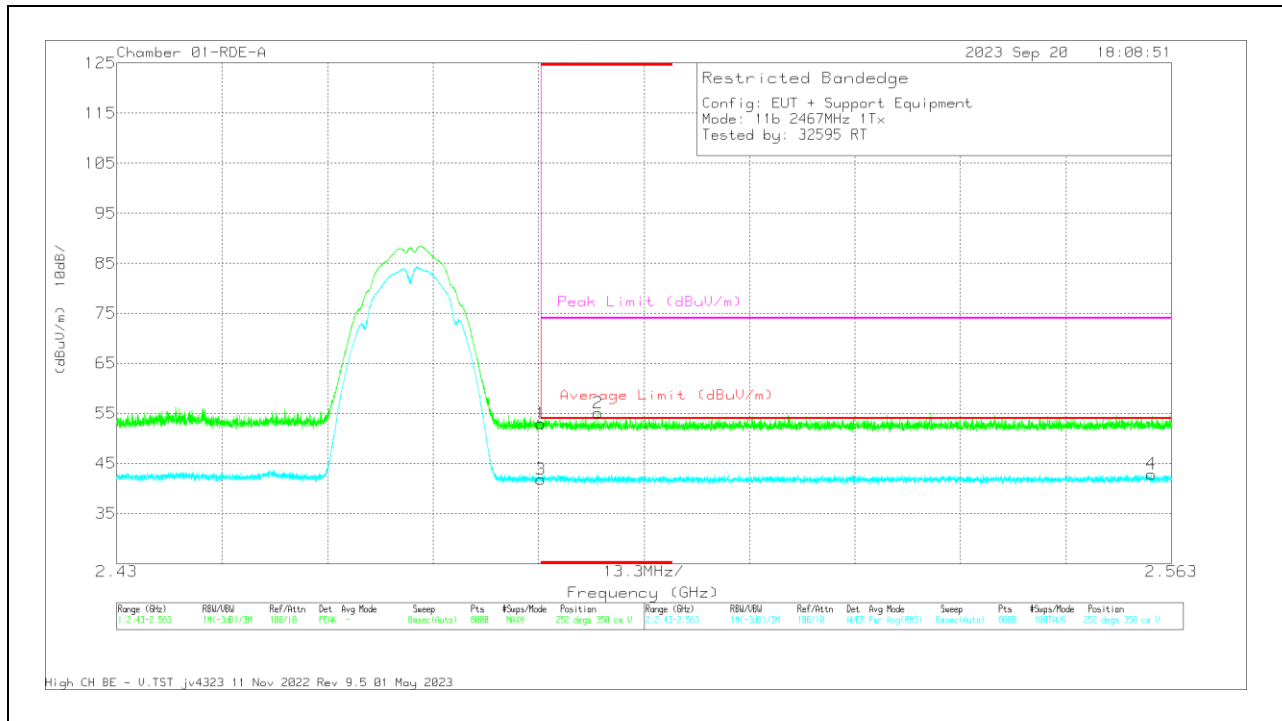

Trace Markers

Marker	Frequency (GHz)	Meter Reading (dBu)	Det	91886 ACF 3m (dB/m)	DCCF (dB)	Gain/Loss (dB)	Corrected Reading (dBu/m)	Average Limit (dBu/m)	Margin (dB)	Peak Limit (dBu/m)	PK Margin (dB)	Azimuth (Degs)	Height (cm)	Polarity
1	* 2.4835	39.34	Pk	32.5	0	-18.86	52.98	-	-	74	-21.02	252	350	V
2	* 2.490689	41.43	Pk	32.5	0	-18.81	55.12	-	-	74	-18.88	252	350	V
3	* 2.4835	28.09	RMS	32.5	12	-18.86	41.85	54	-12.15	-	-	252	350	V
4	2.560489	28.8	RMS	32.5	12	-18.52	42.9	54	-11.1	-	-	252	350	V

* - indicates frequency in CFR47 Pt 15 / IC RSS-Restricted Band
 Pk - Peak detector
 RMS - RMS detection