

# TEST REPORT

**Report Number:** 14938215-E2V3

**Applicant:** SAMSUNG ELECTRONICS CO., LTD.  
129, SAMSUNG-RO, YEONGTONG-GU,  
SUWON-SI, GYEONGGI-DO, 16677, KOREA

**Model:** SM-A256E/DSN and SM-A256E/N

**FCC ID:** A3LSMA256E

**EUT Description:** GSM/WCDMA/LTE/5G Phone with BT/BLE,  
DTS/UNII a/b/g/n/ac, NFC

**Test Standard(s):** FCC 47 CFR PART 15 SUBPART C

**Date Of Issue:**  
2023-10-25

**Prepared by:**  
UL Verification Services Inc.  
47173 Benicia Street  
Fremont, CA 94538 U.S.A.  
TEL: (510) 319-4000  
FAX: (510) 661-0888



---

## REPORT REVISION HISTORY

<u>Rev.</u>	<u>Issue Date</u>	<u>Revisions</u>	<u>Revised By</u>
V1	2023-10-17	Initial Issue	
V2	2023-10-23	Updated Sections 6.5, 6.6, 9.6, 10, 11	Benjamin D.
V3	2023-10-25	Updated Sections 9.6.2, 9.6.3, 10	Chris Xiong

## TABLE OF CONTENTS

<b>REPORT REVISION HISTORY .....</b>	<b>2</b>
<b>TABLE OF CONTENTS .....</b>	<b>3</b>
<b>1. ATTESTATION OF TEST RESULTS .....</b>	<b>5</b>
<b>2. TEST RESULTS SUMMARY .....</b>	<b>7</b>
<b>3. TEST METHODOLOGY .....</b>	<b>8</b>
<b>4. FACILITIES AND ACCREDITATION .....</b>	<b>8</b>
<b>5. DECISION RULES AND MEASUREMENT UNCERTAINTY .....</b>	<b>9</b>
5.1. METROLOGICAL TRACEABILITY .....	9
5.2. DECISION RULES .....	9
5.3. MEASUREMENT UNCERTAINTY.....	9
5.4. SAMPLE CALCULATION .....	10
<b>6. EQUIPMENT UNDER TEST .....</b>	<b>11</b>
6.1. EUT DESCRIPTION .....	11
6.2. MAXIMUM OUTPUT POWER .....	11
6.3. DESCRIPTION OF AVAILABLE ANTENNAS .....	11
6.4. SOFTWARE AND FIRMWARE.....	11
6.5. WORST-CASE CONFIGURATION AND MODE.....	12
6.6. DESCRIPTION OF TEST SETUP.....	13
<b>7. TEST AND MEASUREMENT EQUIPMENT .....</b>	<b>16</b>
<b>8. MEASUREMENT METHODS .....</b>	<b>17</b>
<b>9. ANTENNA PORT TEST RESULTS .....</b>	<b>18</b>
9.1. ON TIME AND DUTY CYCLE.....	18
9.2. 20 dB AND 99% BANDWIDTH .....	19
9.2.1. BLUETOOTH BASIC DATA RATE GFSK MODULATION .....	20
9.2.2. BLUETOOTH ENHANCED DATA RATE 8PSK MODULATION.....	21
9.3. HOPPING FREQUENCY SEPARATION .....	22
9.3.1. BLUETOOTH BASIC DATA RATE GFSK MODULATION .....	23
9.3.2. BLUETOOTH ENHANCED DATA RATE 8PSK MODULATION.....	23
9.4. NUMBER OF HOPPING CHANNELS.....	24
9.4.1. BLUETOOTH BASIC DATA RATE GFSK MODULATION .....	25
9.4.2. BLUETOOTH ENHANCED DATA RATE 8PSK MODULATION.....	26
9.5. AVERAGE TIME OF OCCUPANCY .....	27

---

9.5.1.	BLUETOOTH BASIC DATA RATE GFSK MODULATION .....	28
9.5.2.	BLUETOOTH ENHANCED DATA RATE 8PSK MODULATION.....	30
9.6.	<i>OUTPUT POWER</i> .....	32
9.6.1.	BLUETOOTH BASIC DATA RATE GFSK MODULATION .....	33
9.6.2.	BLUETOOTH ENHANCED DATA RATE DQPSK MODULATION .....	33
9.6.3.	BLUETOOTH ENHANCED DATA RATE 8PSK MODULATION.....	33
9.7.	<i>AVERAGE POWER</i> .....	34
9.7.1.	BLUETOOTH BASIC DATA RATE GFSK MODULATION .....	35
9.7.2.	BLUETOOTH ENHANCED DATA RATE DQPSK MODULATION .....	35
9.7.3.	BLUETOOTH ENHANCED DATA RATE 8PSK MODULATION.....	35
9.8.	<i>CONDUCTED SPURIOUS EMISSIONS</i> .....	36
9.8.1.	BLUETOOTH BASIC DATA RATE GFSK MODULATION .....	37
9.8.2.	BLUETOOTH ENHANCED DATA RATE 8PSK MODULATION.....	39
<b>10.</b>	<b>RADIATED TEST RESULTS</b> .....	<b>41</b>
10.1.	<i>TRANSMITTER ABOVE 1 GHZ</i> .....	43
10.1.1.	BLUETOOTH BASIC DATA RATE GFSK MODULATION .....	43
10.1.2.	BLUETOOTH BASIC DATA RATE 8PSK MODULATION.....	53
10.2.	<i>WORST CASE BELOW 30MHZ</i> .....	63
10.3.	<i>WORST CASE BELOW 1 GHZ</i> .....	65
10.4.	<i>WORST CASE 18-26 GHZ</i> .....	67
<b>11.</b>	<b>AC POWER LINE CONDUCTED EMISSIONS</b> .....	<b>69</b>
<b>12.</b>	<b>SETUP PHOTOS</b> .....	<b>72</b>

# 1. ATTESTATION OF TEST RESULTS

**COMPANY NAME:** SAMSUNG ELECTRONICS CO., LTD.  
129, SAMSUNG-RO, YEONGTONG-GU,  
SUWON-SI, GYEONGGI-DO, 16677, KOREA

**EUT DESCRIPTION:** GSM/WCDMA/LTE/5G Phone with BT/BLE, DTS/UNII a/b/g/n/ac, NFC

**MODEL:** SM-A256E/DSN and SM-A256E/N

**SERIAL NUMBER:** Conducted: R3CW50B1BPM  
Radiated: R3CW50B1C2V, R3CW50B1C0J

**DATE TESTED:** 2023-09-13 – 2023-10-05

APPLICABLE STANDARDS	
STANDARD	TEST RESULTS
CFR 47 Part 15 Subpart C	Complies

UL Verification Services Inc. tested the above equipment in accordance with the requirements set forth in the above standards. The test results show that the equipment tested is capable of demonstrating compliance with the requirements as documented in this report.

The results documented in this report apply only to the tested sample, under the conditions and modes of operation as described herein. It is the manufacturer's responsibility to assure that additional production units of this model are manufactured with identical electrical and mechanical components. All samples tested were in good operating condition throughout the entire test program. Measurement Uncertainties are published for informational purposes only and were not taken into account unless noted otherwise.

This document may not be altered or revised in any way unless done so by UL Verification Services Inc. and all revisions are duly noted in the revisions section. Any alteration of this document not carried out by UL Verification Services Inc. will constitute fraud and shall nullify the document. This report must not be used by the client to claim product certification, approval, or endorsement by A2LA, NIST, any agency of the Federal Government, or any agency of the U.S. government.

Approved & Released For  
UL Verification Services Inc. By:



---

Dan Corona  
Operations Leader  
Consumer Technology Division  
UL Verification Services Inc.

1<sup>st</sup> Reviewed By:



---

Kiya Kedida  
Senior Project Engineer  
Consumer Technology Division  
UL Verification Services Inc.

Prepared By:



---

Chris Xiong  
Senior Test Engineer  
Consumer Technology Division  
UL Verification Services Inc.

2<sup>nd</sup> Reviewed By:



---

Steven Tran  
Senior Project Engineer  
Consumer Technology Division  
UL Verification Services Inc.

## 2. TEST RESULTS SUMMARY

This report contains data provided by the customer which can impact the validity of results. UL Verification Services Inc. is only responsible for the validity of results after the integration of the data provided by the customer.

FCC Clause	Requirement	Result	Comment
See Comment	Duty Cycle	Reporting purposes only	Per ANSI C63.10, Section 11.6.
See Comment	20dB BW/99% OBW	Reporting purposes only	ANSI C63.10 Sections 6.9.2 and 6.9.3
15.247 (a)(1)	Hopping Frequency Separation	Complies	None.
15.247 (a)(1)(iii)	Number of Hopping Channels	Complies	None.
15.247 (a)(1)(iii)	Average Time of Occupancy	Complies	None.
15.247 (b)(1)	Output Power	Complies	None.
See Comment	Average Power	Reporting purposes only	Per ANSI C63.10, Section 11.9.2.3.2.
15.247 (d)	Conducted Spurious Emissions	Complies	None.
15.209, 15.205	Radiated Emissions	Complies	None.
15.207	AC Mains Conducted Emissions	Complies	None.

### 3. TEST METHODOLOGY

The tests documented in this report were performed in accordance with FCC CFR 47 Part 2, FCC CFR 47 Part 15, ANSI C63.10-2013, KDB 558074 D01 15.247 Meas Guidance v05r02 and KDB 414788 D01 Radiated Test Site v01r01.

### 4. FACILITIES AND ACCREDITATION

UL Verification Services Inc. is accredited by A2LA, Certificate Number 0751.05, for all testing performed within the scope of this report. Testing was performed at the locations noted below.

	Address	ISED CABID	ISED Company Number	FCC Registration
<input type="checkbox"/>	Building 1: 47173 Benicia Street, Fremont, CA 94538 USA	US0104	2324A	550739
<input checked="" type="checkbox"/>	Building 2: 47266 Benicia Street, Fremont, CA 94538 USA			
<input checked="" type="checkbox"/>	Building 3: 843 Auburn Court, Fremont, CA 94538 USA			
<input checked="" type="checkbox"/>	Building 4: 47658 Kato Rd, Fremont, CA 94538 USA			
<input type="checkbox"/>	Building 5: 47670 Kato Rd, Fremont, CA 94538 USA			



## 5. DECISION RULES AND MEASUREMENT UNCERTAINTY

### 5.1. METROLOGICAL TRACEABILITY

All test and measuring equipment utilized to perform the tests documented in this report are calibrated on a regular basis, with a maximum time between calibrations of one year or the manufacturers' recommendation, whichever is less, and where applicable is traceable to recognized national standards.

### 5.2. DECISION RULES

The Decision Rule is based on Simple Acceptance in accordance with ISO Guide 98-4:2012 Clause 8.2. (Measurement uncertainty is not taken into account when stating conformity with a specified requirement.)

### 5.3. MEASUREMENT UNCERTAINTY

Where relevant, the following measurement uncertainty levels have been estimated for tests performed on the apparatus:

PARAMETER	U <sub>Lab</sub>
Radio Frequency (Spectrum Analyzer)	141.16 Hz
Occupied Bandwidth	1.22%
Power Spectral Density	2.47 dB
RF Power Measurement Direct Method Using Power Meter	1.3 dB (PK) / 0.45 dB (AV)
Unwanted Emissions, Conducted	1.94 dB
Worst Case Conducted Disturbance, 9KHz to 0.15 MHz	3.78 dB
Worst Case Conducted Disturbance, 0.15 to 30 MHz	3.40 dB
Worst Case Radiated Disturbance, 9KHz to 30 MHz	2.87 dB
Worst Case Radiated Disturbance, 30 to 1000 MHz	6.01 dB
Worst Case Radiated Disturbance, 1000 to 18000 MHz	4.73 dB
Worst Case Radiated Disturbance, 18000 to 26000 MHz	4.51 dB
Worst Case Radiated Disturbance, 26000 to 40000 MHz	5.29 dB
Time Domain Measurements	3.39%
Temperature	0.57°C
Humidity	3.39%
DC Supply Voltages	0.57%

Uncertainty figures are valid to a confidence level of 95%.

## 5.4. SAMPLE CALCULATION

### **RADIATED EMISSIONS**

Where relevant, the following sample calculation is provided:

Field Strength (dBuV/m) = Measured Voltage (dBuV) + Antenna Factor (dB/m) + Cable Loss (dB)  
– Preamp Gain (dB)

$36.5 \text{ dBuV} + 18.7 \text{ dB/m} + 0.6 \text{ dB} - 26.9 \text{ dB} = 28.9 \text{ dBuV/m}$

### **MAINS CONDUCTED EMISSIONS**

Where relevant, the following sample calculation is provided:

Final Voltage (dBuV) = Measured Voltage (dBuV) + Cable Loss (dB) + Limiter Factor (dB) + LISN  
Insertion Loss.

$36.5 \text{ dBuV} + 0 \text{ dB} + 10.1 \text{ dB} + 0 \text{ dB} = 46.6 \text{ dBuV}$

## 6. EQUIPMENT UNDER TEST

### 6.1. EUT DESCRIPTION

The EUT is a GSM/WCDMA/LTE/5G Phone with BT/BLE, DTS/UNII a/b/g/n/ac and NFC.

The model SM-A256E/DSN was used for final testing and is representative of the test results in this report.

### 6.2. MAXIMUM OUTPUT POWER

The transmitter has a maximum peak conducted output power as follows:

Frequency Range (MHz)	Mode	Output Power (dBm)	Output Power (mW)
2402 - 2480	Basic GFSK	10.87	12.22
2402 - 2480	Enhanced DQPSK	10.43	11.04
2402 - 2480	Enhanced 8PSK	10.32	10.76

Note: GFSK, DQPSK, 8PSK average Power are all investigated, The GFSK & 8PSK Power are the worst case. Testing is based on these modes to showing compliance. For average power data please refer to section 9.7.

### 6.3. DESCRIPTION OF AVAILABLE ANTENNAS

The antenna(s) gain and type, as provided by the manufacturer' are as follows:

The radio utilizes a MFA antenna, with a maximum gain of -7.29 dBi.

### 6.4. SOFTWARE AND FIRMWARE

The test utility software used during testing was A256E.001.

---

## 6.5. WORST-CASE CONFIGURATION AND MODE

Radiated emissions below 1GHz, above 18GHz, and power line conducted emission were performed with the EUT set to transmit at the channel with highest output power as worst-case scenario.

Band edge and radiated emissions between 1GHz and 18GHz were performed with the EUT set to transmit at the highest power on low, middle, and high channels.

The fundamental of the EUT was investigated in three orthogonal orientations X,Y,Z, it was determined that X orientation was worst-case orientation; therefore, all final radiated testing was performed with the EUT in X orientation.

Worst-case data rates as provided by the client were:

GFSK Mode: DH5  
QPSK Mode : 2-DH5  
8PSK Mode: 3-DH5

The final testing was done using GFSK and 8PSK modes.

## 6.6. DESCRIPTION OF TEST SETUP

SUPPORT TEST EQUIPMENT				
Description	Manufacturer	Model	Serial Number	FCC ID/ DoC
AC Adapter	Samsung	EP-TA800	R37TC7A00EBDKA	N/A

I/O CABLES (RF CONDUCTED TEST)						
Cable No.	Port	# of Identical Ports	Connector Type	Cable Type	Cable Length (m)	Remarks
1	Antenna	3	RF	Shielded	0.2	
2	USB-C	1	USB-C	Un-Shielded	1	EUT to AC Mains

I/O CABLES (RF RADIATED and AC LINE CONDUCTED TEST)						
Cable No.	Port	# of Identical Ports	Connector Type	Cable Type	Cable Length (m)	Remarks
1	USB-C	1	USB-C	Shielded	1	N/A

### TEST SETUP

The EUT is a stand-alone device configured and tested in a worst-case setup. Worst case is using worst case orientation with AC charger attached to the EUT. Test software exercised the radio card.

**SETUP DIAGRAMS**

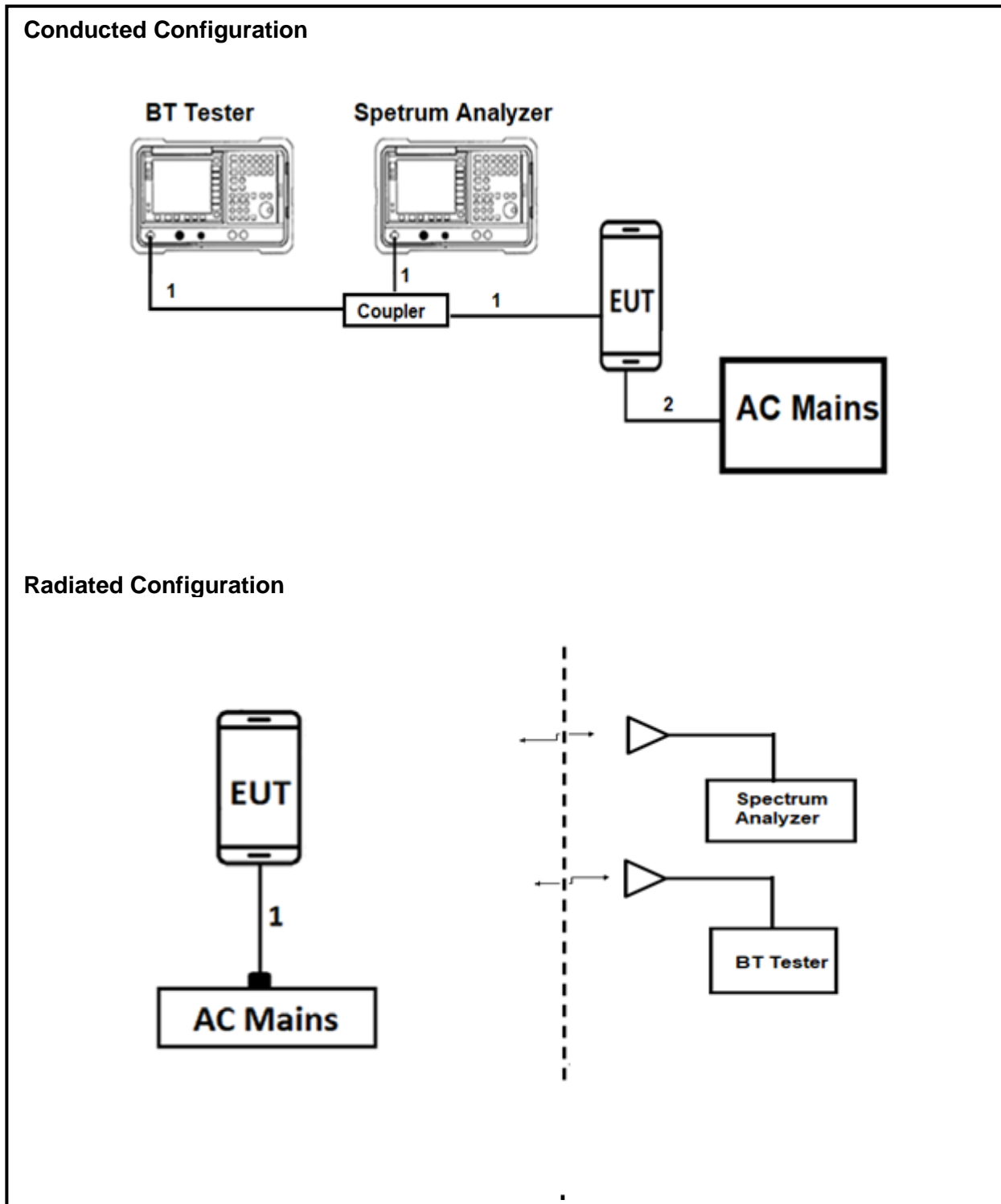

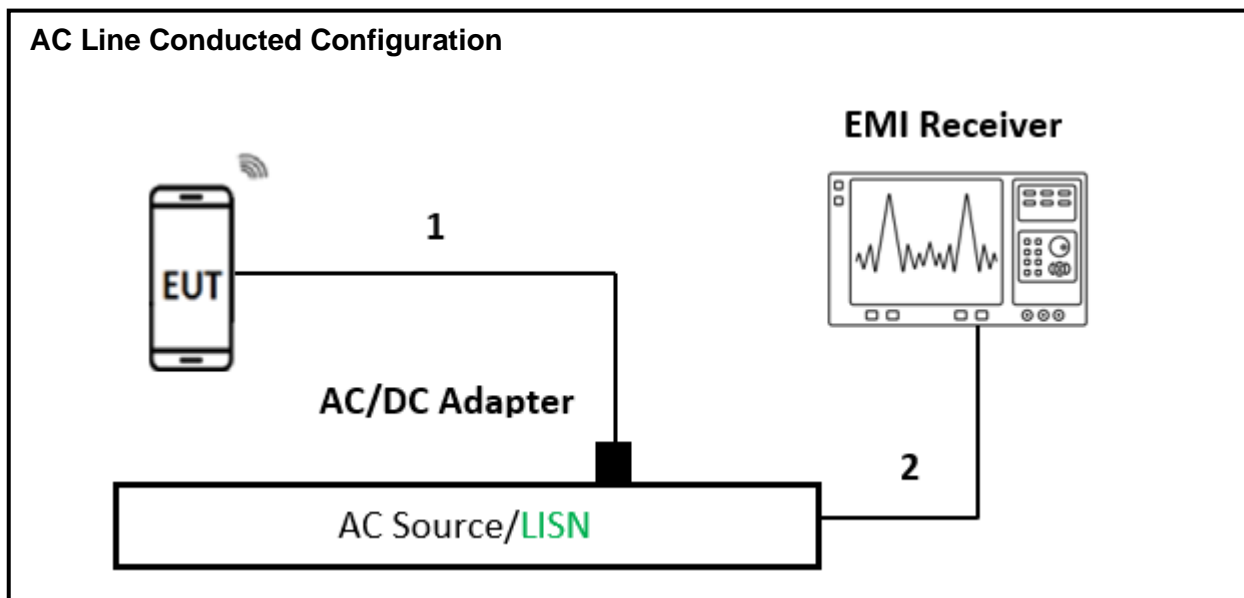

## 7. TEST AND MEASUREMENT EQUIPMENT

The following test and measurement equipment was utilized for the tests documented in this report:

TEST EQUIPMENT LIST					
Description	Manufacturer	Model	ID Num	Cal Due	Last Cal
Spectrum Analyzer, PXA, 3Hz to 44GHz	Keysight Technologies Inc	N9030A	85214	02/29/2024	02/06/2023
10dB Fixed Attenuator, 2 Watts Up to 26.5 GHz	Pasternack Enterprises	PE7024-10	236358	Verified/Characterized before use	
EMI TEST RECEIVER	Rohde & Schwarz	ESW44	PRE0179372	02/29/2024	02/17/2023
Antenna, Horn 1-18GHz	ETS-Lindgren (Cedar Park, Texas)	3117	230299	01/12/2024	01/12/2023
RF Filter Box, 1-18GHz, 12 Port.	UL-FR1	Frankenstein	231874	08/30/2024	08/23/2023
EMI TEST RECEIVER	Rohde & Schwarz	ESW44	170063	02/29/2024	02/27/2023
Antenna, Horn 1-18GHz	ETS-Lindgren (Cedar Park, Texas)	3117	230300	01/12/2024	01/12/2023
RF Filter Box, 1-18GHz, 12 Port.	UL-FR1	Frankenstein	231875	04/30/2024	04/14/2023
EMI TEST RECEIVER	Rohde & Schwarz	ESW44	191428	02/29/2024	02/15/2023
Antenna, BroadBand Hybrid 30 MHz - 3 GHz	SUNOL SCIENCES CORP.	JB3	230635	01/31/2024	01/23/2023
Amplifier 9 KHz - 1 GHz	SONOMA INSTRUMENT	310N	230310	02/02/2024	02/02/2023
EMI TEST RECEIVER	Rohde & Schwarz	ESW44	201499	02/29/2024	02/27/2023
Antenna, Horn 18 to 26.5GHz	A.R.A.	MWH-1826/B	172363	01/31/2024	01/27/2023
Amplifier Assembly, 18-26.5GHz, 60dB Gain	AMPLICAL	AMP18G26.5-60	171580	05/31/2025	05/19/2023
Antenna, Passive Loop 30Hz - 1MHz	ELECTRO-METRICS	EM-6871	170013	07/31/2024	07/28/2022
Antenna, Passive Loop 100KHz - 30MHz	ELECTRO-METRICS	EM-6872	170015	07/31/2024	07/28/2022
Power Meter, P-series single channel	Keysight Technologies Inc	N1912A	90630	01/31/2024	01/24/2023
Power Sensor, P - series, 50MHz to 18GHz, Wideband	Keysight Technologies Inc	N1921A	90391	01/31/2024	01/25/2023
AC Line Conducted					
EMI Test Receiver 9kHz-7GHz	Rohde & Schwarz	ESR	93091	02/29/2024	02/29/2023
LISN for Conducted Emissions CISPR-16	FISCHER CUSTOM COMMUNICATIONS	FCC-LISN-50/250-25-2-01-480V	175764	01/31/2024	01/31/2023
Transient Limiter	TE	TBFL1	207996	08/31/2024	08/10/2023
UL TEST SOFTWARE LIST					
Radiated Software	UL	UL EMC	Version 9.5, 01 May 2023		
Conducted Software	UL	UL EMC	2022.8.16		
AC Line Conducted Software	UL	UL EMC	Version 9.5, 03 March 2023		



## 8. MEASUREMENT METHODS

On Time and Duty Cycle: ANSI C63.10-2013 Section 11.6

Occupied BW (20dB): ANSI C63.10-2013 Section 6.9.2

Occupied BW (99%): ANSI C63.10-2013 Section 6.9.3

Carrier Frequency Separation: ANSI C63.10-2013 Section 7.8.2

Number of Hopping Frequencies: ANSI C63.10-2013 Section 7.8.3

Time of Occupancy (Dwell Time): ANSI C63.10-2013 Section 7.8.4

Peak Output Power: ANSI C63.10-2013 Section 7.8.5

Conducted Spurious Emissions: ANSI C63.10-2013 Section 7.8.8

Conducted Band-Edge: ANSI C63.10-2013 Section 6.10.4

Radiated Spurious Emissions Below 30MHz: ANSI C63.10-2013 Section 6.4

Radiated Spurious Emissions 30-1000MHz: ANSI C63.10-2013 Section 6.3 and 6.5

Radiated Spurious Emissions above 1GHz: ANSI C63.10-2013 Section 6.3 and 6.6

Radiated Band-edge: ANSI C63.10-2013 Section 6.10.5

AC Power-line conducted emissions: ANSI C63.10-2013, Section 6.2.

## 9. ANTENNA PORT TEST RESULTS

### 9.1. ON TIME AND DUTY CYCLE

#### LIMITS

None; for reporting purposes only.

#### PROCEDURE

ANSI C63.10, Section 11.6: Zero-Span Spectrum Analyzer Method.

#### ON TIME AND DUTY CYCLE RESULTS

Mode	ON Time B (msec)	Period (msec)	Duty Cycle x (linear)	Duty Cycle (%)	Duty Cycle Correction Factor (dB)	1/T Minimum VBW (kHz)
BLUETOOTH GFSK	2.880	3.750	0.768	76.80	1.15	0.347
BLUETOOTH 8PSK	2.880	3.750	0.768	76.80	1.15	0.347

#### DUTY CYCLE PLOTS

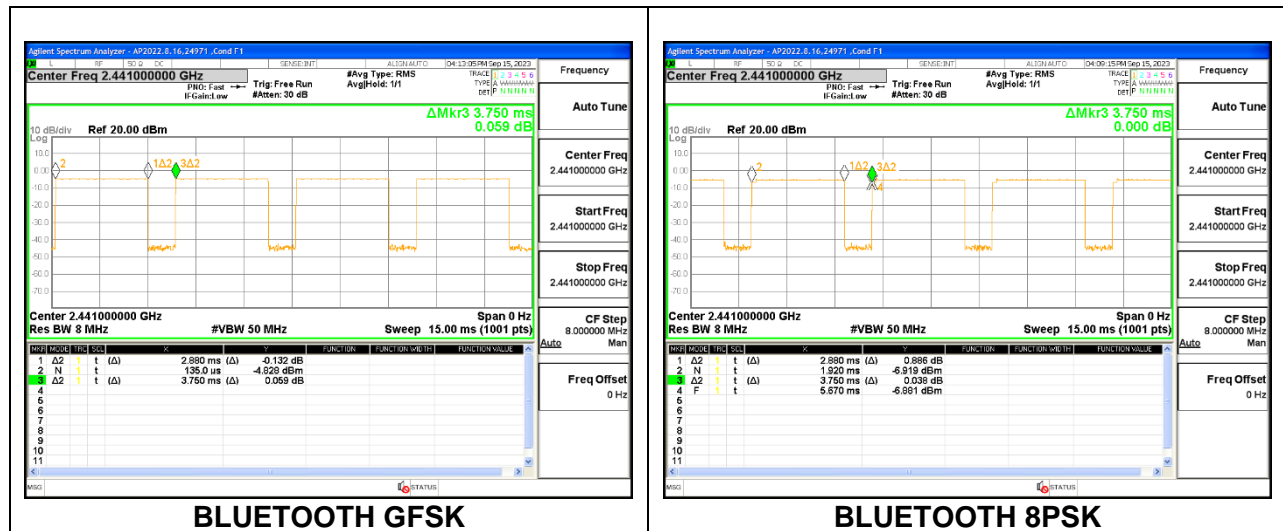

## **9.2. 20 dB AND 99% BANDWIDTH**

### **LIMITS**

None; for reporting purposes only.

### **TEST PROCEDURE**

The transmitter output is connected to a spectrum analyzer. The RBW is set to  $\geq 1\%$  of the 20 dB bandwidth. The VBW is set to  $\geq$  RBW. The sweep time is coupled.

### **RESULTS**

### 9.2.1. BLUETOOTH BASIC DATA RATE GFSK MODULATION

Channel	Frequency (MHz)	20dB Bandwidth (KHz)	99% Bandwidth (KHz)
Low	2402	934.5	884.48
Mid	2441	933.3	885.93
High	2480	933.6	883.05

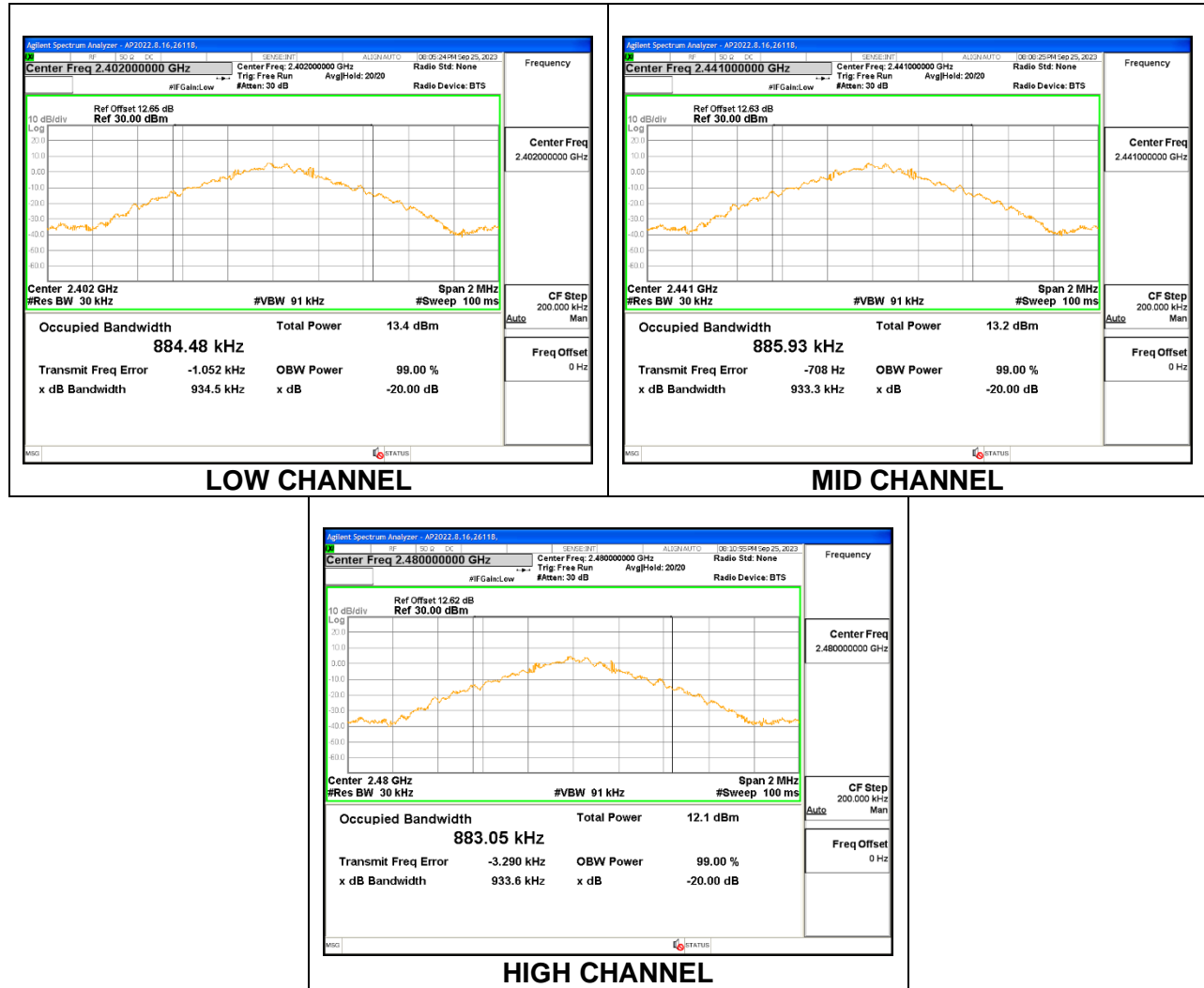

### 9.2.2. BLUETOOTH ENHANCED DATA RATE 8PSK MODULATION

Channel	Frequency (MHz)	20dB Bandwidth (KHz)	99% Bandwidth (KHz)
Low	2402	1.313	1.2045
Mid	2441	1.322	1.2019
High	2480	1.312	1.2072

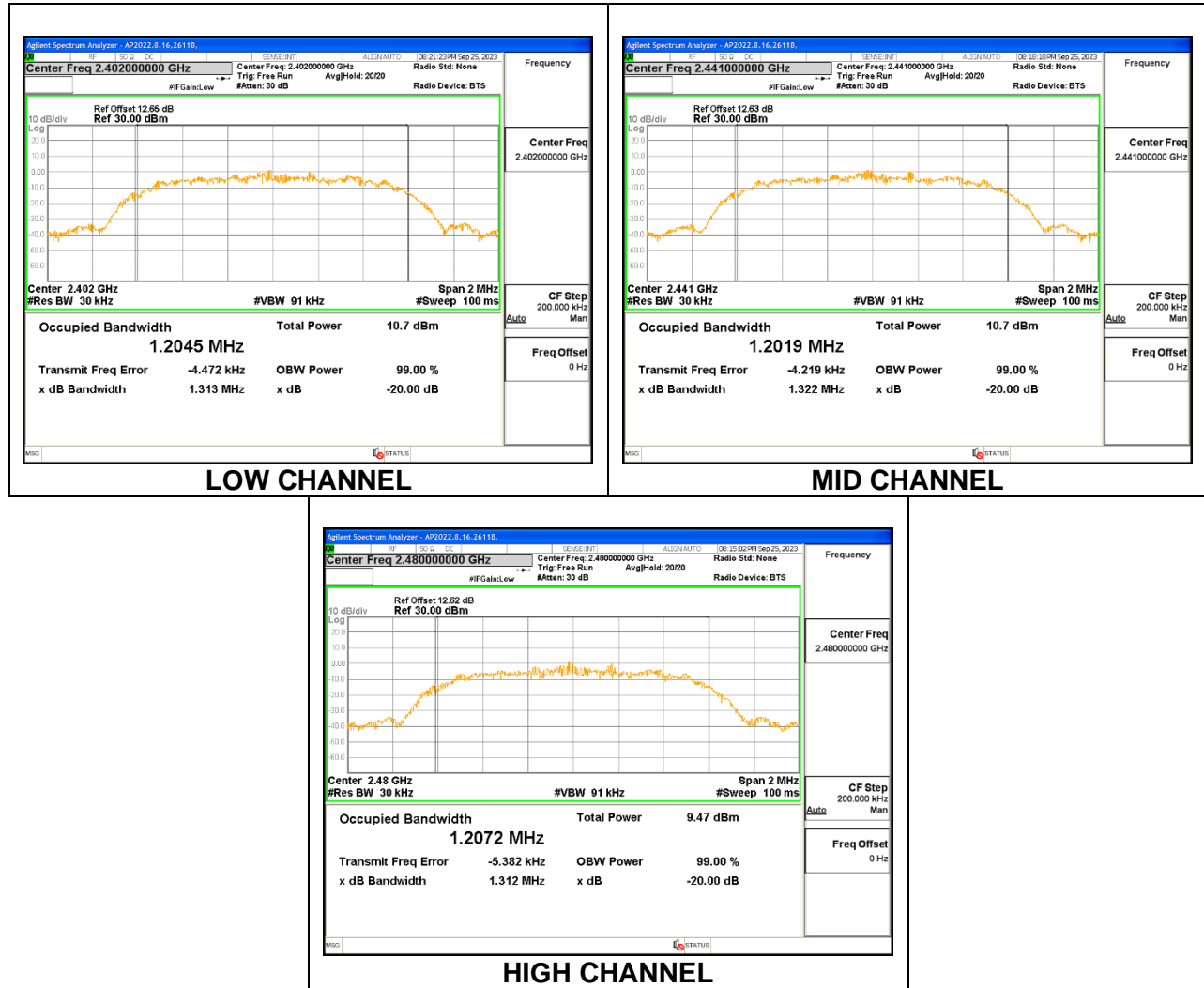

---

### **9.3. HOPPING FREQUENCY SEPARATION**

#### **LIMITS**

FCC §15.247 (a) (1)

Frequency hopping systems shall have hopping channel carrier frequencies separated by a minimum of 25 kHz or the 20 dB bandwidth of the hopping channel, whichever is greater.

Alternatively, frequency hopping systems operating in the 2400-2483.5 MHz band may have hopping channel carrier frequencies that are separated by 25 kHz or two-thirds of the 20 dB bandwidth of the hopping channel, whichever is greater, provided the systems operate with an output power no greater than 125 mW.

#### **TEST PROCEDURE**

The transmitter output is connected to a spectrum analyzer. The RBW is set to 300 kHz and the VBW is set to  $VBW \geq RBW$ . The sweep time is coupled.

#### **RESULTS**

### 9.3.1. BLUETOOTH BASIC DATA RATE GFSK MODULATION

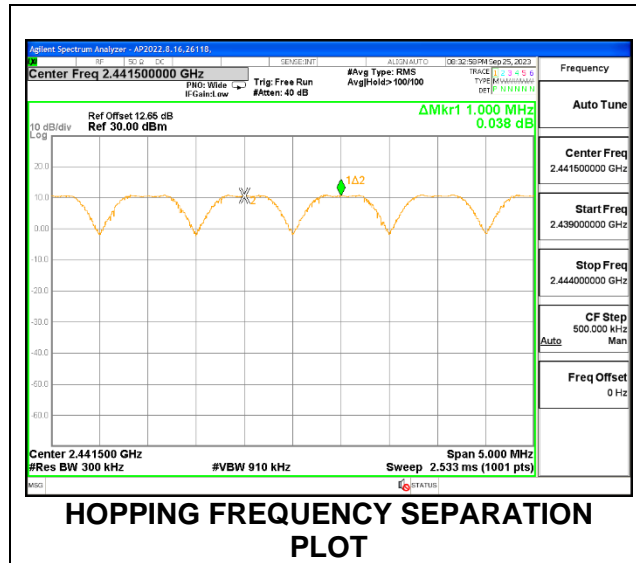

### 9.3.2. BLUETOOTH ENHANCED DATA RATE 8PSK MODULATION

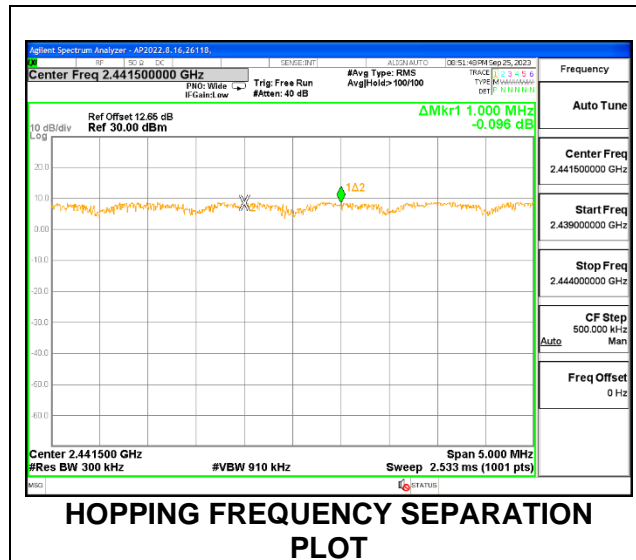

## **9.4. NUMBER OF HOPPING CHANNELS**

### **LIMITS**

FCC §15.247 (a) (1) (iii)

Frequency hopping systems in the 2400 – 2483.5 MHz band shall use at least 15 non-overlapping channels.

### **TEST PROCEDURE**

The transmitter output is connected to a spectrum analyzer. The span is set to cover the entire authorized band, in either a single sweep or in multiple contiguous sweeps. The RBW is set to a maximum of 1 % of the span. The analyzer is set to Max Hold.

### **RESULTS**

Normal Mode: 79 Channels Observed



### 9.4.1. BLUETOOTH BASIC DATA RATE GFSK MODULATION

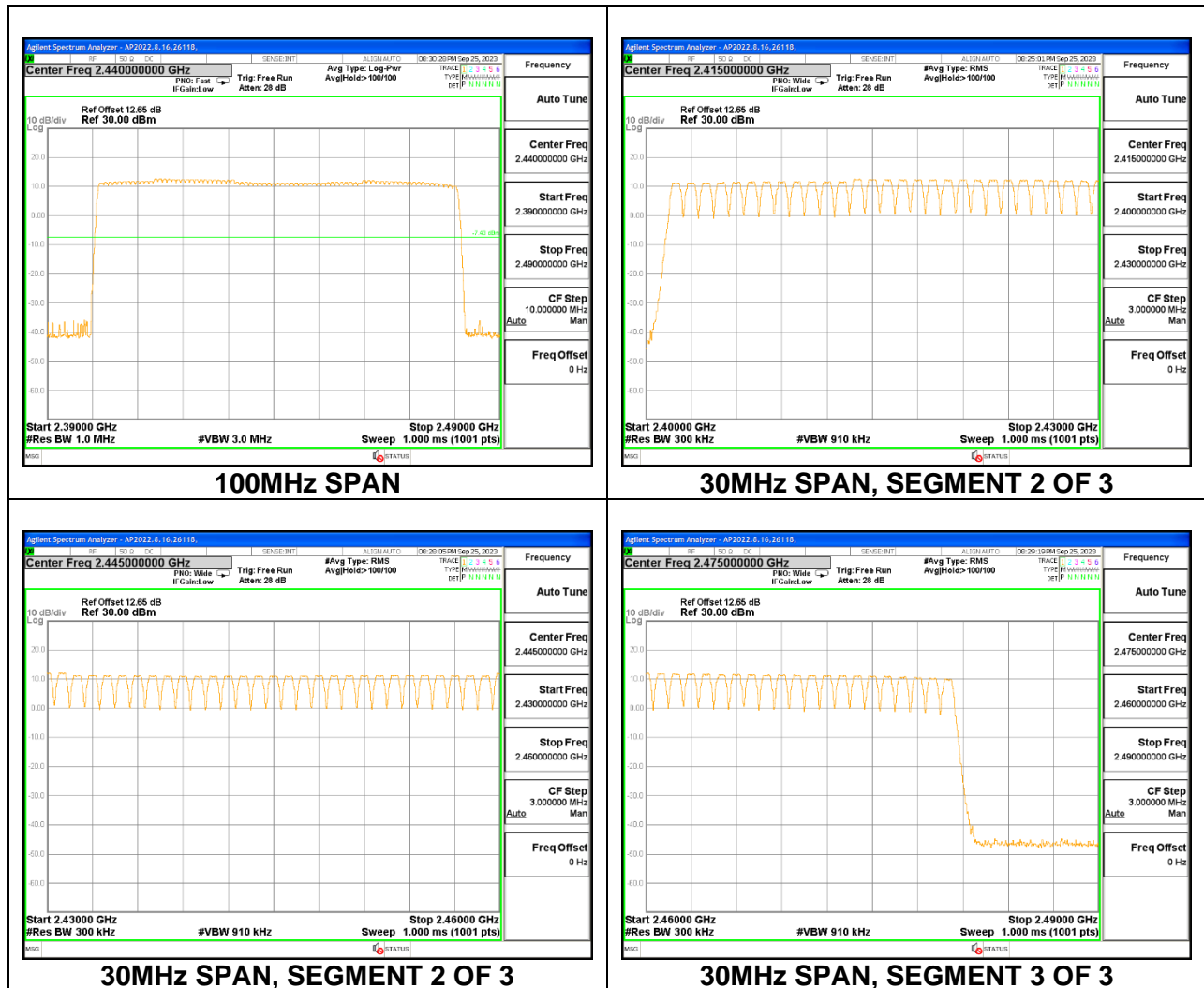

### 9.4.2. BLUETOOTH ENHANCED DATA RATE 8PSK MODULATION

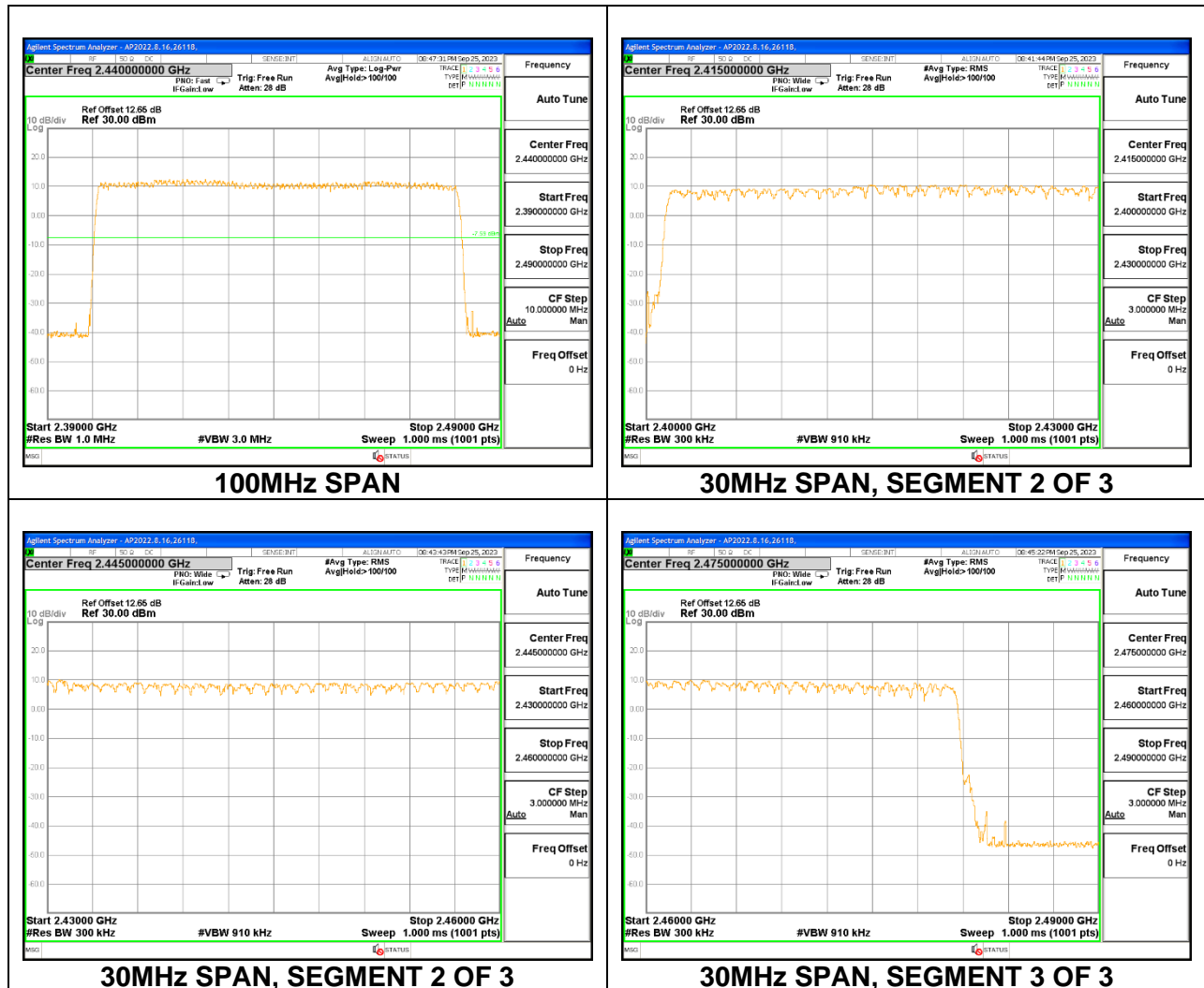

---

## 9.5. AVERAGE TIME OF OCCUPANCY

### LIMITS

FCC §15.247 (a) (1) (iii)

The average time of occupancy on any channel shall not be greater than 0.4 seconds within a period of 0.4 seconds multiplied by the number of hopping channels employed.

### TEST PROCEDURE

The transmitter output is connected to a spectrum analyzer. The span is set to 0 Hz, centered on a single, selected hopping channel. The width of a single pulse is measured in a fast scan. The number of pulses is measured in a 3.16 second scan, to enable resolution of each occurrence.

The average time of occupancy in the specified 3.16 second period (79 channels \* 0.4 s) is equal to  $10 * (\# \text{ of pulses in } 3.16 \text{ s}) * \text{ pulse width}$ .

For AFH mode, the average time of occupancy in the specified 8 second period (20 channels \* 0.4 seconds) is equal to  $10 * (\# \text{ of pulses in } 0.8 \text{ s}) * \text{ pulse width}$ .

### 9.5.1. BLUETOOTH BASIC DATA RATE GFSK MODULATION

DH Packet	Pulse Width (msec)	Number of Pulses in 3.16 seconds	Average Time of Occupancy (sec)	Limit (sec)	Margin (sec)
GFSK Normal Mode					
DH1	0.372	32	0.1190	0.4	-0.2810
DH3	1.626	20	0.3252	0.4	-0.0748
DH5	2.868	11	0.3155	0.4	-0.0845
DH Packet	Pulse Width (sec)	Number of Pulses in 0.8 seconds	Average Time of Occupancy (sec)	Limit (sec)	Margin (sec)
GFSK AFH Mode					
DH1	0.372	8	0.02976	0.4	-0.3702
DH3	1.626	5	0.08130	0.4	-0.3187
DH5	2.868	2.75	0.07887	0.4	-0.3211

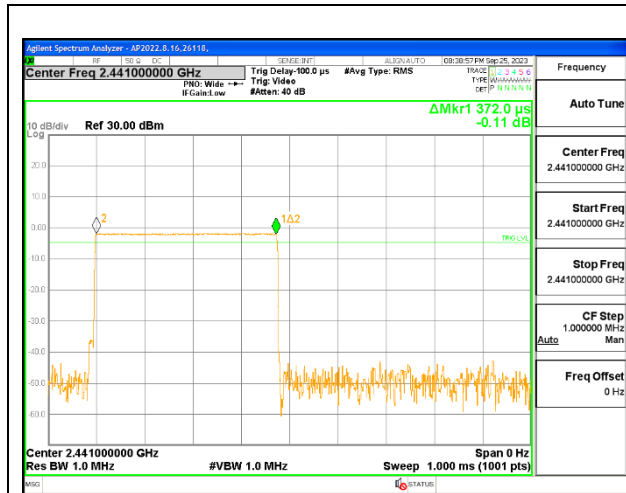

**PULSE WIDTH - DH1**

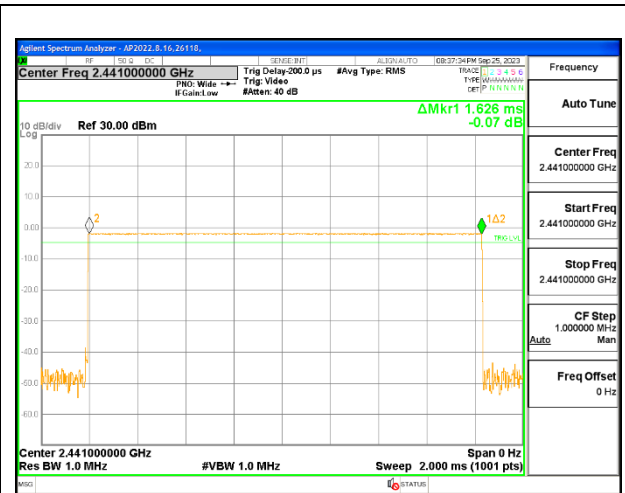

**PULSE WIDTH - DH3**



**PULSE WIDTH - DH5**

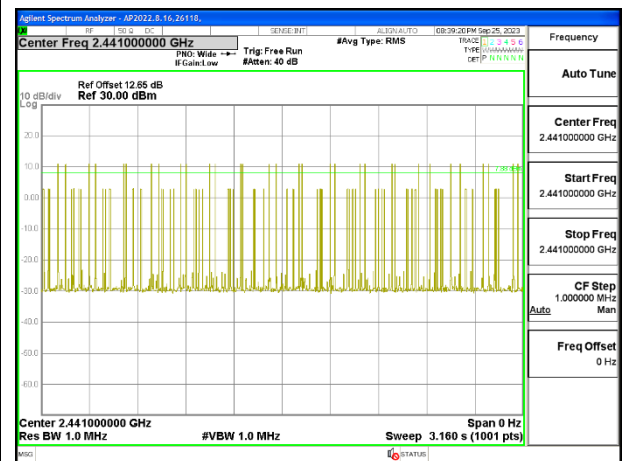

**NUMBER OF PULSES IN 3.16 SECOND OBSERVATION PERIOD - DH1**

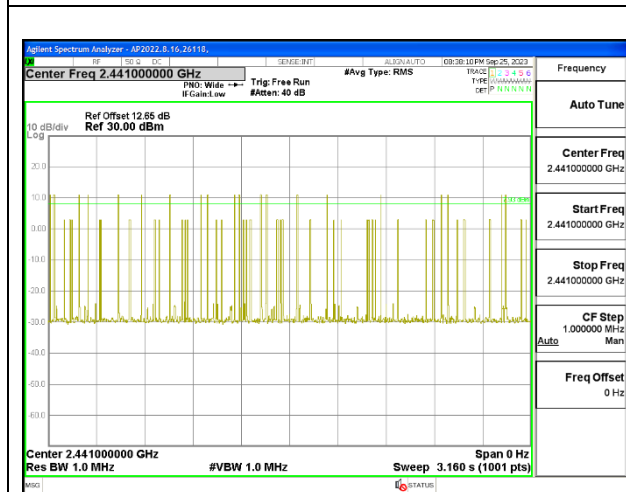

**NUMBER OF PULSES IN 3.16 SECOND OBSERVATION PERIOD - DH3**

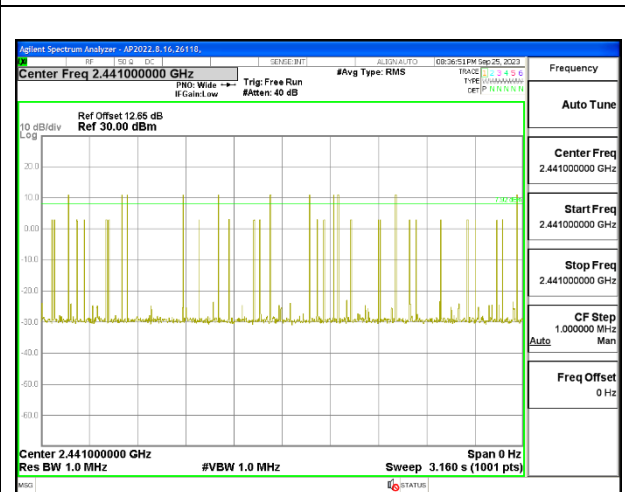

**NUMBER OF PULSES IN 3.16 SECOND OBSERVATION PERIOD - DH5**

### 9.5.2. BLUETOOTH ENHANCED DATA RATE 8PSK MODULATION

DH Packet	Pulse Width (msec)	Number of Pulses in 3.16 seconds	Average Time of Occupancy (sec)	Limit (sec)	Margin (sec)
8PSK Normal Mode					
3DH1	0.383	30	0.1149	0.4	-0.2851
3DH3	1.632	18	0.29376	0.4	-0.10624
3DH5	2.876	11	0.31636	0.4	-0.08364

Note: for AFH(8PSK) mode, please refer to the results of AFH(GFSK) mode; the channel selection and hopping rate are the same for both EDR and Basic Rate operation, data for Basic Rate demonstrates compliance with channel occupancy when AFH is employed.

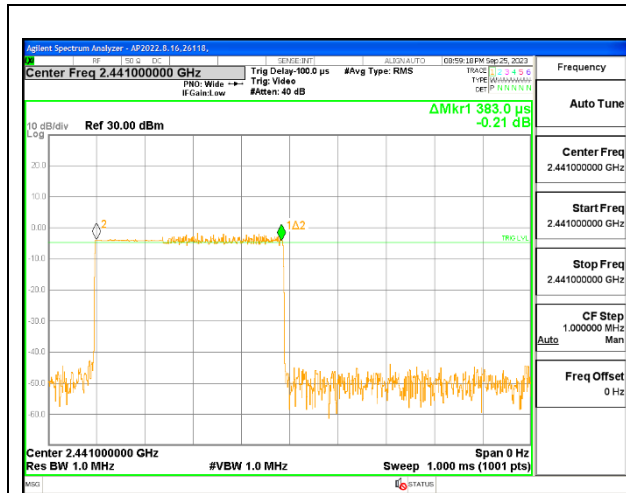

**PULSE WIDTH – 3DH1**

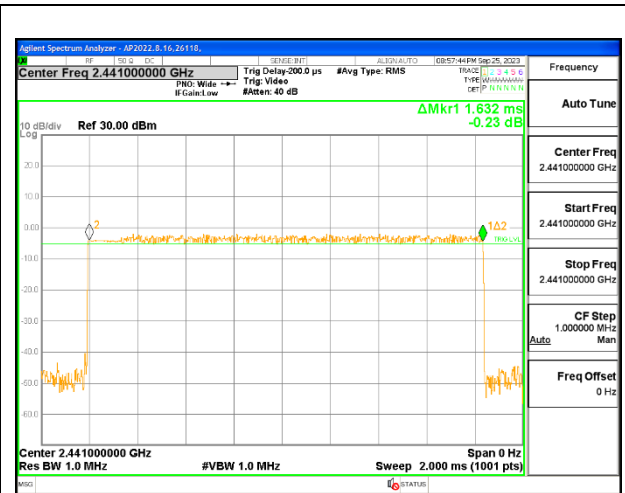

**PULSE WIDTH – 3DH3**

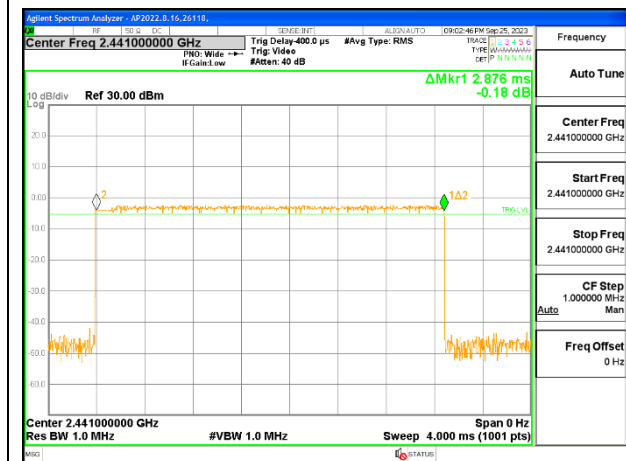

**PULSE WIDTH – 3DH5**

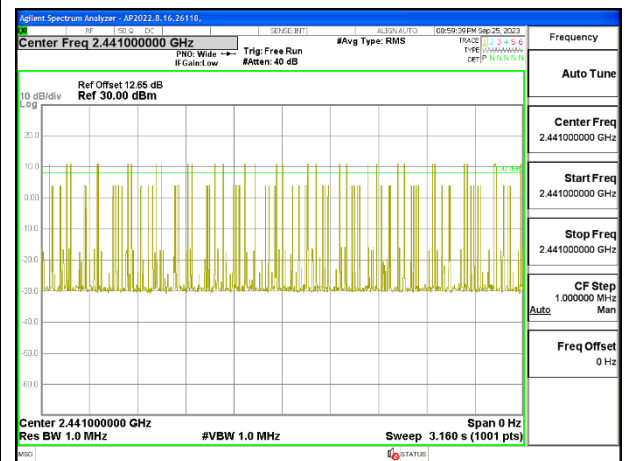

**NUMBER OF PULSES IN 3.16 SECOND  
OBSERVATION PERIOD – 3DH1**



**NUMBER OF PULSES IN 3.16 SECOND  
OBSERVATION PERIOD – 3DH3**



**NUMBER OF PULSES IN 3.16 SECOND  
OBSERVATION PERIOD – 3DH5**

## 9.6. OUTPUT POWER

### LIMITS

§15.247 (b) (1)

The maximum antenna gain is less than 6 dBi, therefore the limit is 30 dBm. Alternatively, frequency hopping systems operating in the 2400-2483.5 MHz band may have hopping channel carrier frequencies that are separated by 25 kHz or two-thirds of the 20 dB bandwidth of the hopping channel, whichever is greater, provided the systems operate with an output power no greater than 125 mW.

For frequency hopping systems operating in the 2400-2483.5 MHz band employing at least 75 non-overlapping hopping channels, and all frequency hopping systems in the 5725-5850 MHz band: 1 watt.  
For all other frequency hopping systems in the 2400-2483.5 MHz band: 0.125 watts

### TEST PROCEDURE

The transmitter output is connected to a power meter.

The power output was measured on the EUT antenna port using SMA cable with 10dB attenuator connected to a power meter via wideband power sensor. Peak output power was read directly from power meter.

### RESULTS



### 9.6.1. BLUETOOTH BASIC DATA RATE GFSK MODULATION

Tested By:	26118
Date:	2023-09-25

Channel	Frequency (MHz)	Output Power (dBm)	Limit (dBm)	Margin (dB)
Low	2402	10.59	21	-10.41
Middle	2441	10.87	21	-10.13
High	2480	9.56	21	-11.44

### 9.6.2. BLUETOOTH ENHANCED DATA RATE DQPSK MODULATION

Tested By:	26118
Date:	2023-09-25

Channel	Frequency (MHz)	Output Power (dBm)	Limit (dBm)	Margin (dB)
Low	2402	10.43	21	-10.57
Middle	2441	10.28	21	-10.72
High	2480	9.16	21	-11.84

### 9.6.3. BLUETOOTH ENHANCED DATA RATE 8PSK MODULATION

Tested By:	26118
Date:	2023-09-25

Channel	Frequency (MHz)	Output Power (dBm)	Limit (dBm)	Margin (dB)
Low	2402	10.26	21	-10.74
Middle	2441	10.32	21	-10.68
High	2480	9.45	21	-11.55

## **9.7. AVERAGE POWER**

### **LIMITS**

None; for reporting purposes only

### **TEST PROCEDURE**

The transmitter output is connected to a power meter.

The power output was measured on the EUT antenna port using SMA cable with 10dB attenuator connected to a power meter via wideband power sensor. Gated average output power was read directly from power meter.

### **RESULTS**

### 9.7.1. BLUETOOTH BASIC DATA RATE GFSK MODULATION

Tested By:	26118
Date	2023-09-25

Channel	Frequency (MHz)	Average Power (dBm)
Low	2402	10.33
Middle	2441	10.67
High	2480	9.29

### 9.7.2. BLUETOOTH ENHANCED DATA RATE DQPSK MODULATION

Tested By:	26118
Date	2023-09-25

Channel	Frequency (MHz)	Average Power (dBm)
Low	2402	7.83
Middle	2441	7.78
High	2480	6.69

### 9.7.3. BLUETOOTH ENHANCED DATA RATE 8PSK MODULATION

Tested By:	26118
Date	2023-09-25

Channel	Frequency (MHz)	Average Power (dBm)
Low	2402	7.90
Middle	2441	7.91
High	2480	6.94

---

## 9.8. CONDUCTED SPURIOUS EMISSIONS

### LIMITS

FCC §15.247 (d)

Limit = -20 dBc

### TEST PROCEDURE

The transmitter output is connected to a spectrum analyzer. The resolution bandwidth is set to 100 kHz. The video bandwidth is set to 300 kHz.

The spectrum from 30 MHz to 26 GHz is investigated with the transmitter set to the lowest, middle, and highest channels.

The band edges at 2.4 and 2.4835 GHz are investigated with the transmitter set to the normal hopping mode.

### 9.8.1. BLUETOOTH BASIC DATA RATE GFSK MODULATION

#### SPURIOUS EMISSIONS, NON-HOPPING

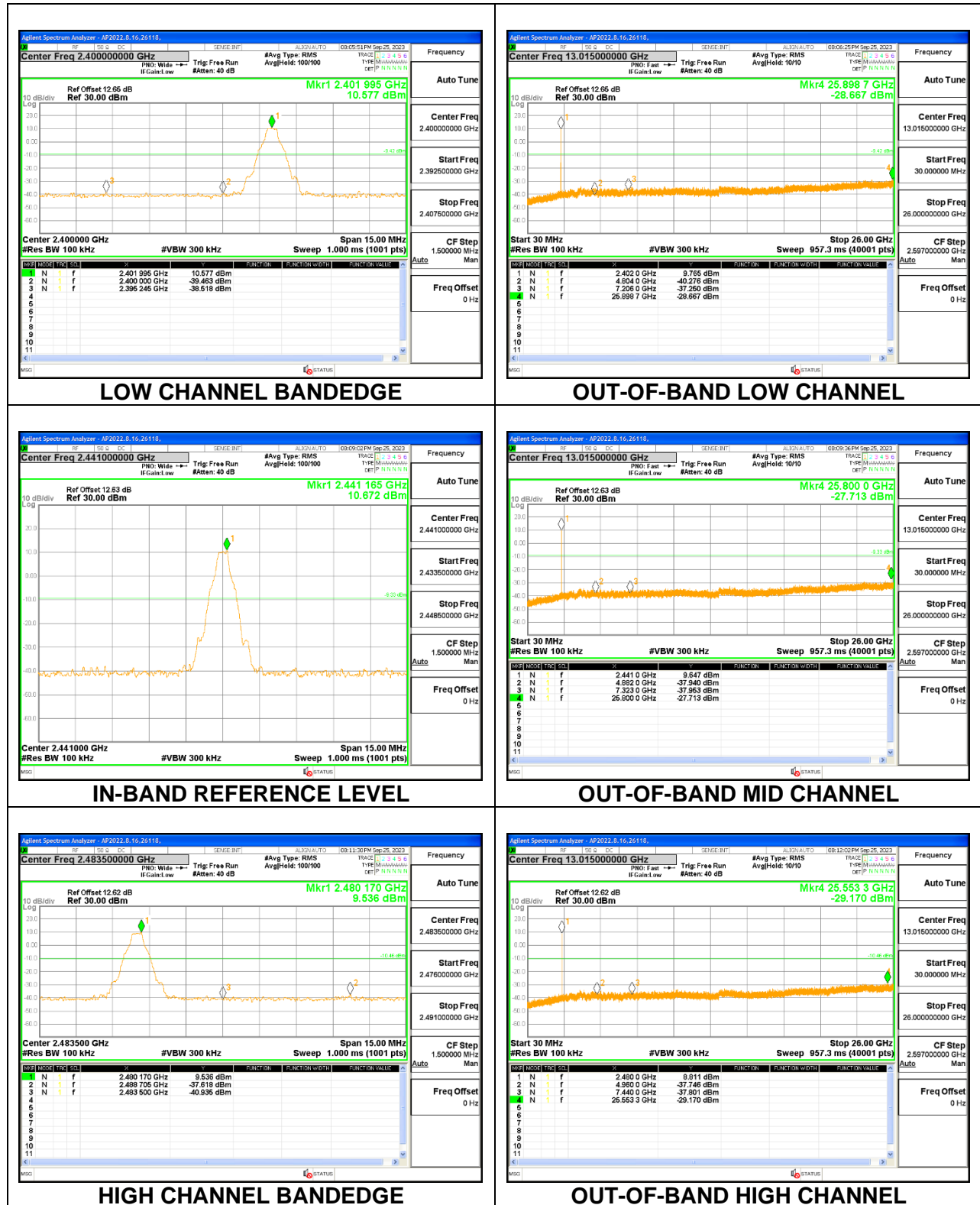

**SPURIOUS BANDEDGE EMISSIONS WITH HOPPING ON**

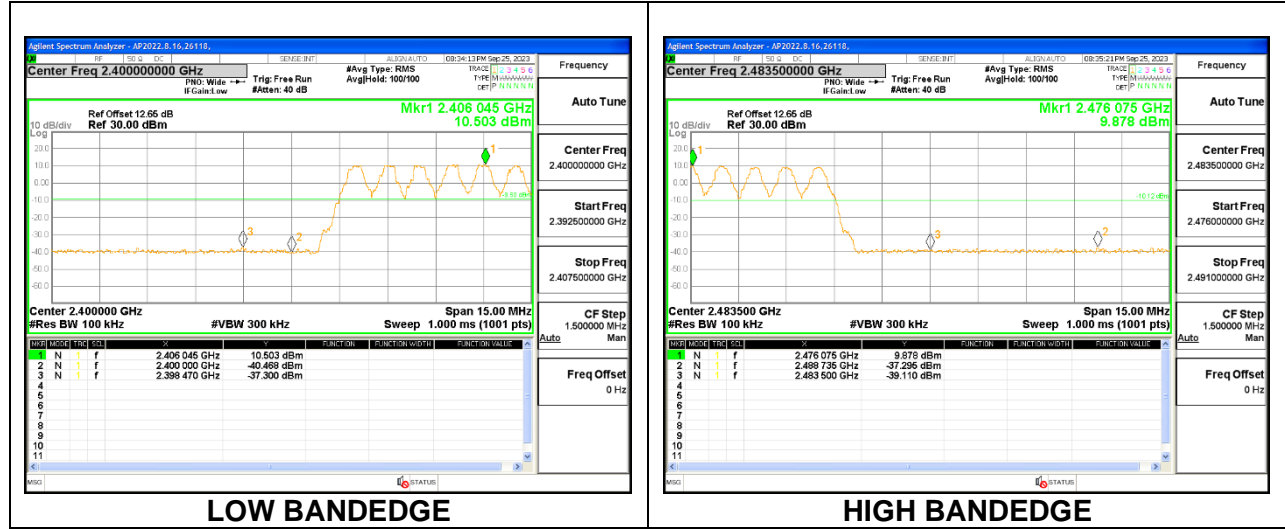

## 9.8.2. BLUETOOTH ENHANCED DATA RATE 8PSK MODULATION

### SPURIOUS EMISSIONS, NON-HOPPING

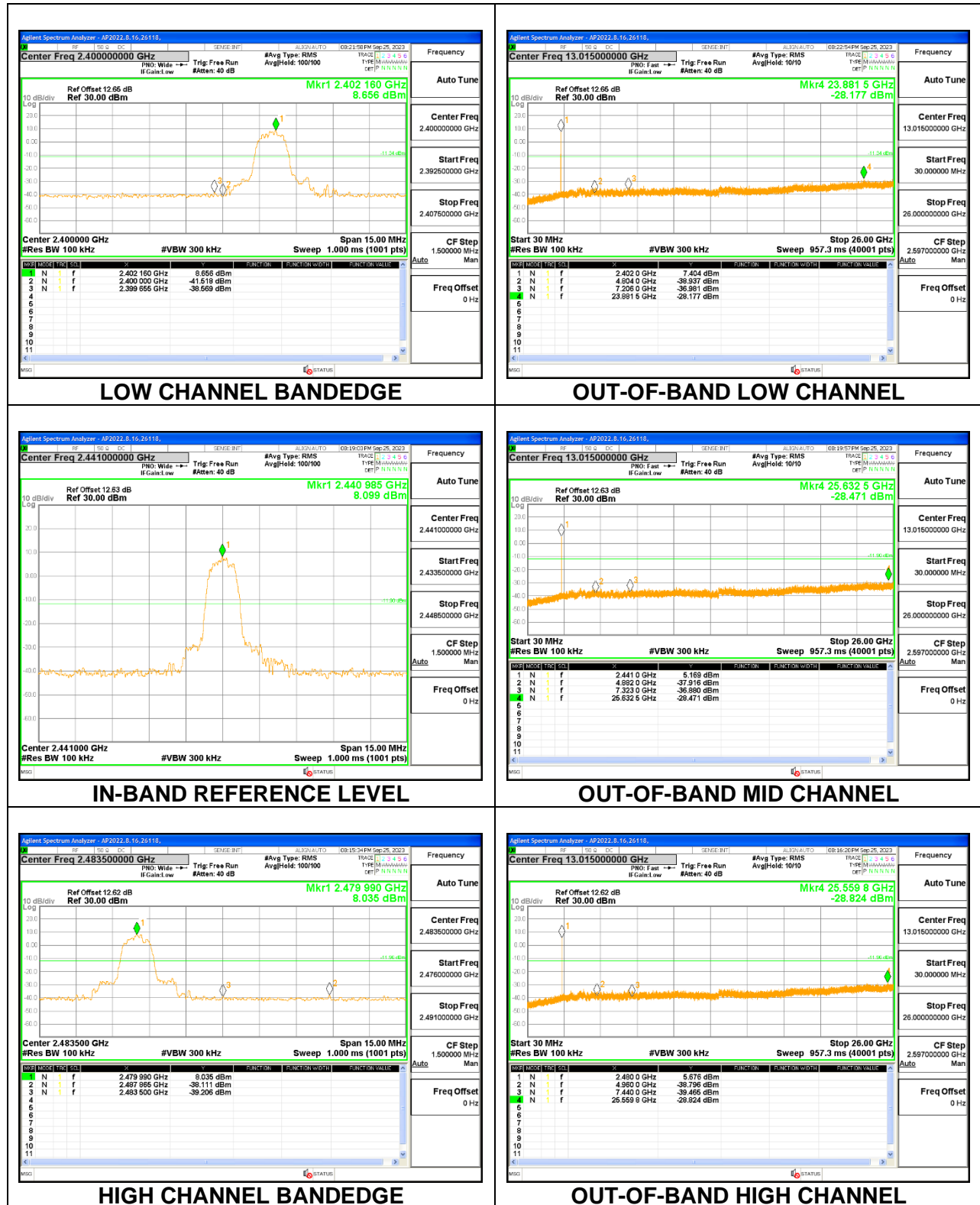

**SPURIOUS BANDEDGE EMISSIONS WITH HOPPING ON**

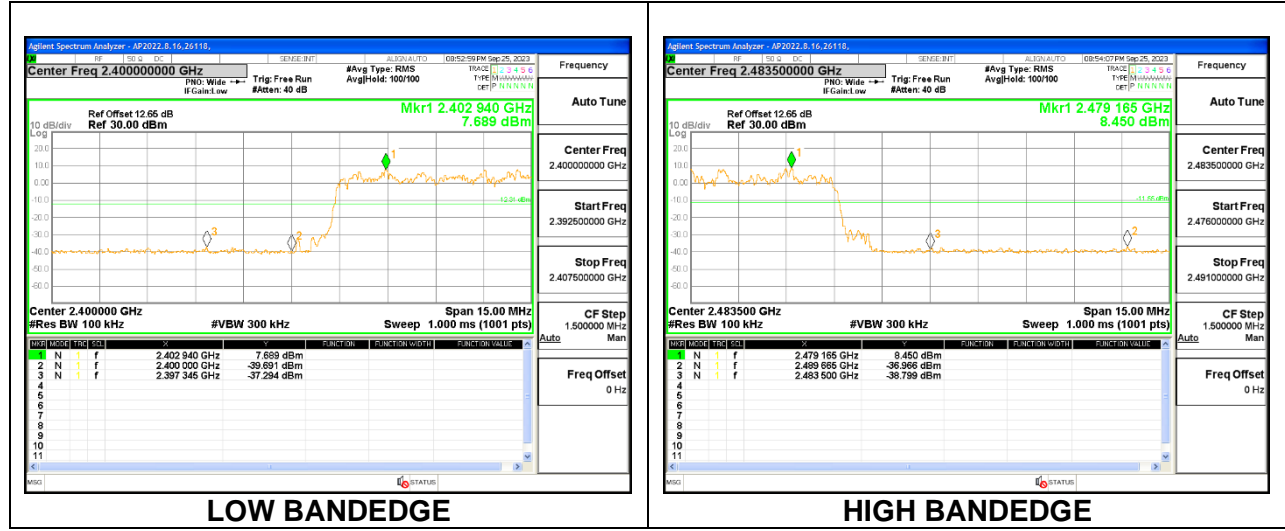



## 10. RADIATED TEST RESULTS

### LIMITS

FCC §15.205 and §15.209

Frequency Range (MHz)	Field Strength Limit (uV/m) at 3 m	Field Strength Limit (dBuV/m) at 3 m
0.009-0.490	2400/F(kHz) @ 300 m	-
0.490-1.705	24000/F(kHz) @ 30 m	-
1.705 - 30	30 @ 30m	-
30 - 88	100	40
88 - 216	150	43.5
216 - 960	200	46
Above 960	500	54

### TEST PROCEDURE

The EUT is placed on a non-conducting table 80 cm above the ground plane for measurement below 1GHz; 1.5 m above the ground plane for measurement above 1GHz. The antenna to EUT distance is 3 meters. The EUT is configured in accordance with ANSI C63.10. The EUT is set to transmit in a continuous mode.

For measurements below 1 GHz the resolution bandwidth is set to 100 kHz for peak detection measurements or 120 kHz for quasi-peak detection measurements in the 30-1000MHz range, 9kHz for peak and/or quasi-peak detection measurements in the 0.15-30MHz range and 200Hz for peak and/or quasi-peak detection measurements in the 9 to 150kHz range. Peak detection is used unless otherwise noted as quasi-peak or average (9-90kHz and 110-490kHz).

For pre-scans above 1 GHz the resolution bandwidth is set to 1 MHz; the video bandwidth is set to 30 KHz for peak measurements.

For final measurements above 1 GHz the resolution bandwidth is set to 1 MHz; the video bandwidth is set to 3 MHz for peak measurements and 1 MHz resolution bandwidth with 1/T (500 Hz) video bandwidth with peak detector for average measurements.

The spectrum from 1 GHz to 18 GHz is investigated with the transmitter set to the lowest, middle, and highest channels in each applicable band. Below 1GHz and above 18GHz emissions, the channel with the highest output power was tested.

The frequency range of interest is monitored at a fixed antenna height and EUT azimuth. The EUT is rotated through 360 degrees to maximize emissions received. The antenna is scanned from 1 to 4 meters above the ground plane to further maximize the emission. Measurements are made with the antenna polarized in both the vertical and the horizontal positions.

2D antenna use - For below 30MHz testing, investigation was done on three antenna orientations (parallel, perpendicular, and ground-parallel), parallel and perpendicular are the worst orientations, therefore testing was performed on these two orientations only.

Base on FCC 15.31 (f) (2): measurements may be performed at a distance closer than that specified in the regulations; however, an attempt should be made to avoid making measurements in the near field.

**KDB 414788 Open Field Site(OFS) and Chamber Correlation Justification**

OFS and chamber correlation testing had been performed and chamber measured test result is the worst case test result.

**KDB 558074 D01 15.247 Meas Guidance v05r02**

Use of a duty cycle correction factor (DCCF) is permitted for calculating average radiated field strength emission levels for an FHSS device in 15.247. This DCCF can be applied when the field strength limit (e.g., within a Government Restricted band) and the conditions specified in Section 15.35(c) can be satisfied. The average radiated field strength is calculated by subtracting the DCCF from the maximum radiated field strength level as determined through measurement. The maximum radiated field strength level represents the worst-case (maximum amplitude) RMS measurement of the emission(s) during continuous transmission (i.e., not including any time intervals during which the transmitter is off or is transmitting at a reduced power level). It is also acceptable to apply the DCCF to a measurement performed with a peak detector instead of the specified RMS power averaging detector. Note that Section 15.35(c) specifies that the DCCF shall represent the worst-case (greatest duty cycle) over any 100 msec transmission period.

**Note:** The limits in CFR 47, Part 15, Subpart C, paragraph 15.209(a), are identical to those in RSS-Gen section 8.9, Table 6, since the measurements are performed in terms of magnetic field strength and converted to electric field strength levels (as reported in the table), using the free space impedance of 377 Ohms. For example, the measurement at frequency X kHz resulted in a level of Y dBuV/m, which is equivalent to  $Y - 51.5 = Z$  dBuA/m, which has the same margin, W dB, to the corresponding RSS-Gen Table 6 limit as it has to 15.209(a) limit.

## 10.1. TRANSMITTER ABOVE 1 GHz

### 10.1.1. BLUETOOTH BASIC DATA RATE GFSK MODULATION

#### BANDEDGE (LOW CHANNEL)

#### HORIZONTAL RESULT

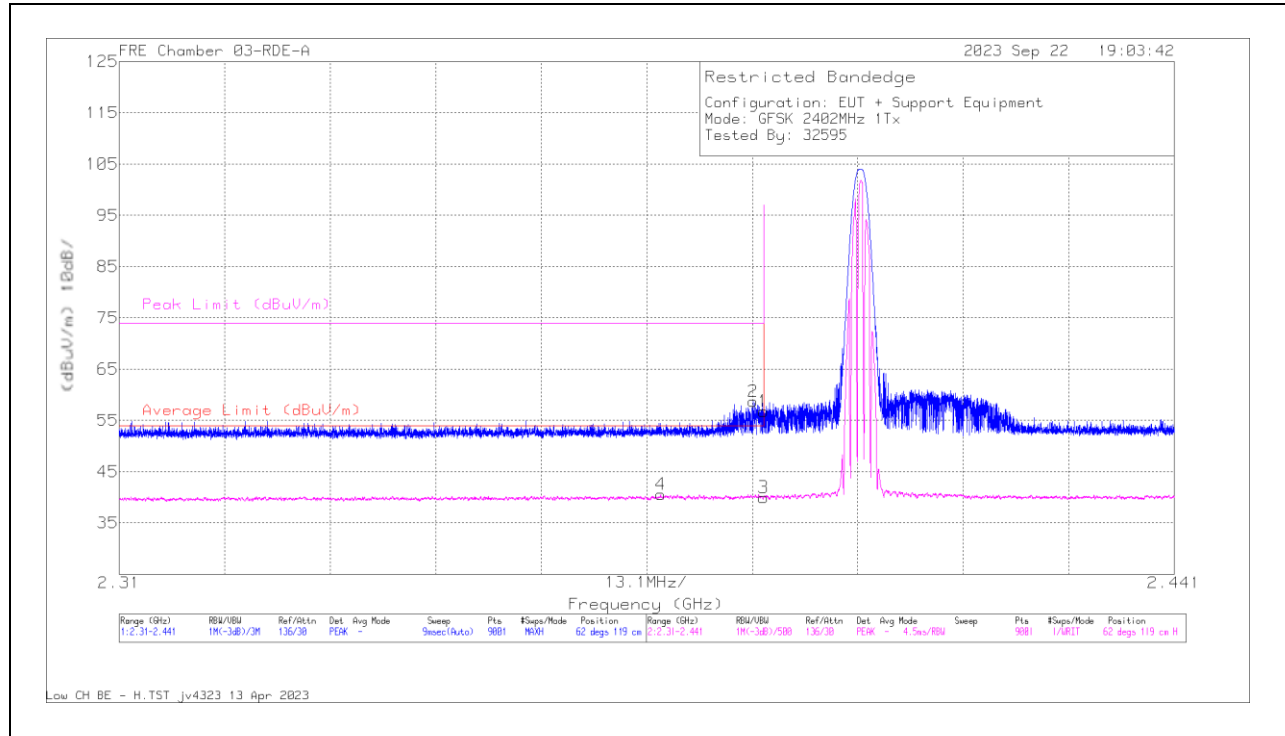

Marker	Frequency (GHz)	Meter Reading (dBuV)	Det	200897 ACF 3m (dB/m)	Gain/Loss (dB)	Corrected Reading (dBuV/m)	Average Limit (dBuV/m)	Margin (dB)	Peak Limit (dBuV/m)	PK Margin (dB)	Azimuth (Degs)	Height (cm)	Polarity
1	* 2.39	64.93	Pk	31.9	-40.07	56.76	-	-	74	-17.24	62	119	H
2	* 2.388704	66.86	Pk	31.9	-40.05	58.71	-	-	74	-15.29	62	119	H
3	* 2.39	48.13	VA1T	31.9	-40.07	39.96	54	-14.04	-	-	62	119	H
4	* 2.377234	48.73	VA1T	31.9	-40.07	40.56	54	-13.44	-	-	62	119	H

\* - indicates frequency in CFR47 Pt 15 / IC RSS-Restricted Band  
 Pk - Peak detector  
 VA1T - FHSS: Linear Voltage Average VB=1/Ton where: Ton is transmit duration

### VERTICAL RESULT

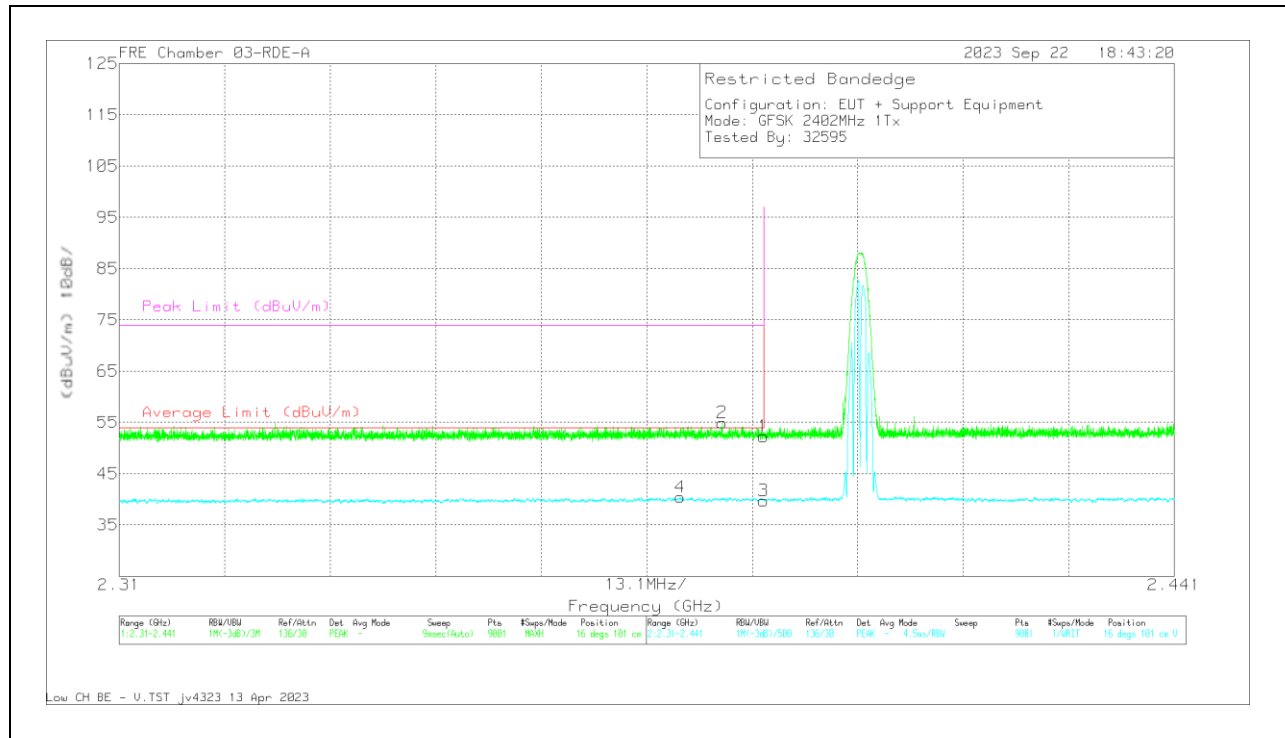

Marker	Frequency (GHz)	Meter Reading (dBuV)	Det	200897 ACF 3m (dB/m)	Gain/Loss (dB)	Corrected Reading (dBuV/m)	Average Limit (dBuV/m)	Margin (dB)	Peak Limit (dBuV/m)	PK Margin (dB)	Azimuth (Degs)	Height (cm)	Polarity
1	* 2.39	60.47	Pk	31.9	-40.07	52.3	-	-	74	-21.7	16	101	V
2	* 2.384862	63.14	Pk	31.9	-40.1	54.94	-	-	74	-19.06	16	101	V
3	* 2.39	47.9	VA1T	31.9	-40.07	39.73	54	-14.27	-	-	16	101	V
4	* 2.379665	48.58	VA1T	31.9	-40.07	40.41	54	-13.59	-	-	16	101	V

\* - indicates frequency in CFR47 Pt 15 / IC RSS-Restricted Band  
 Pk - Peak detector  
 VA1T - FHSS: Linear Voltage Average VB=1/Ton where: Ton is transmit duration

**BANDEDGE (HIGH CHANNEL)**

**HORIZONTAL RESULT**

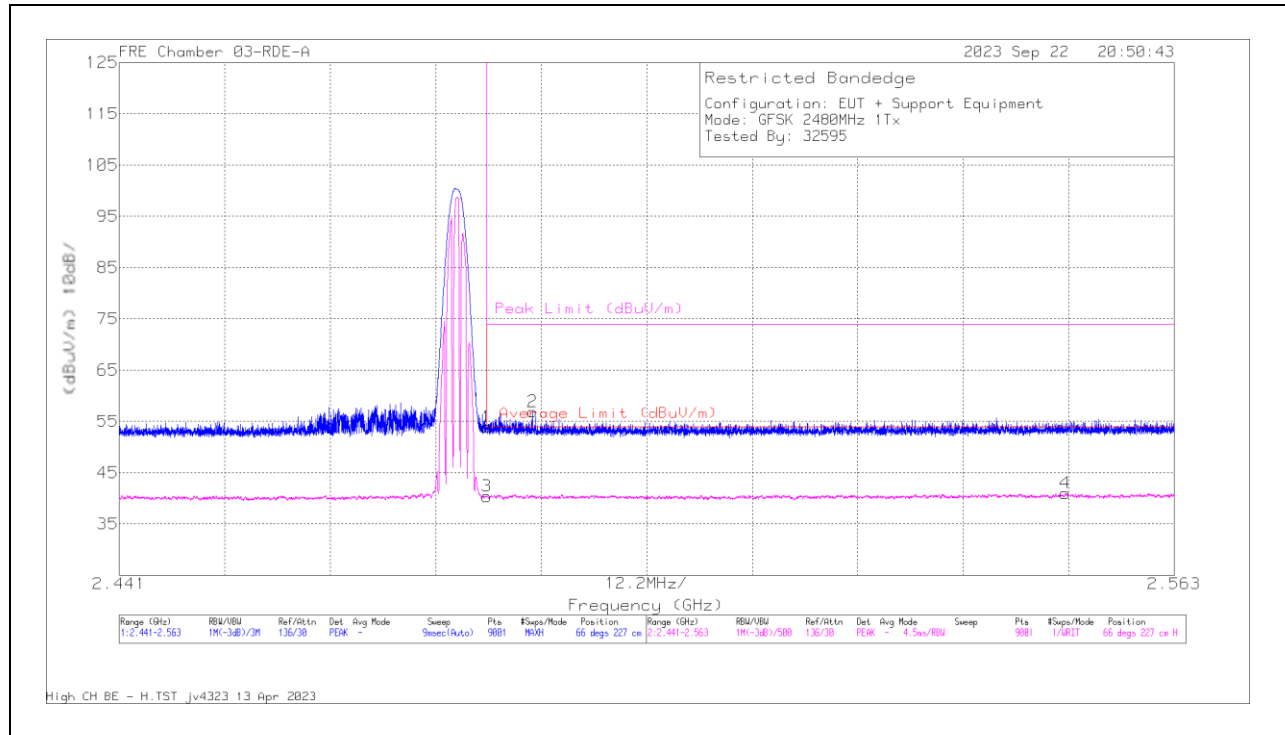

Marker	Frequency (GHz)	Meter Reading (dBuV)	Det	200897 ACF 3m (dB/m)	Gain/Loss (dB)	Corrected Reading (dBuV/m)	Average Limit (dBuV/m)	Margin (dB)	Peak Limit (dBuV/m)	PK Margin (dB)	Azimuth (Degs)	Height (cm)	Polarity
1	* 2.4835	61.55	Pk	32.2	-39.84	53.91	-	-	74	-20.09	66	227	H
2	* 2.488785	64.44	Pk	32.2	-39.76	56.88	-	-	74	-17.12	66	227	H
3	* 2.4835	48.02	VA1T	32.2	-39.84	40.38	54	-13.62	-	-	66	227	H
4	2.550383	48.4	VA1T	32.2	-39.61	40.99	54	-13.01	-	-	66	227	H

\* - indicates frequency in CFR47 Pt 15 / IC RSS-Restricted Band  
 Pk - Peak detector  
 VA1T - FHSS: Linear Voltage Average VB=1/Ton where: Ton is transmit duration

### VERTICAL RESULT

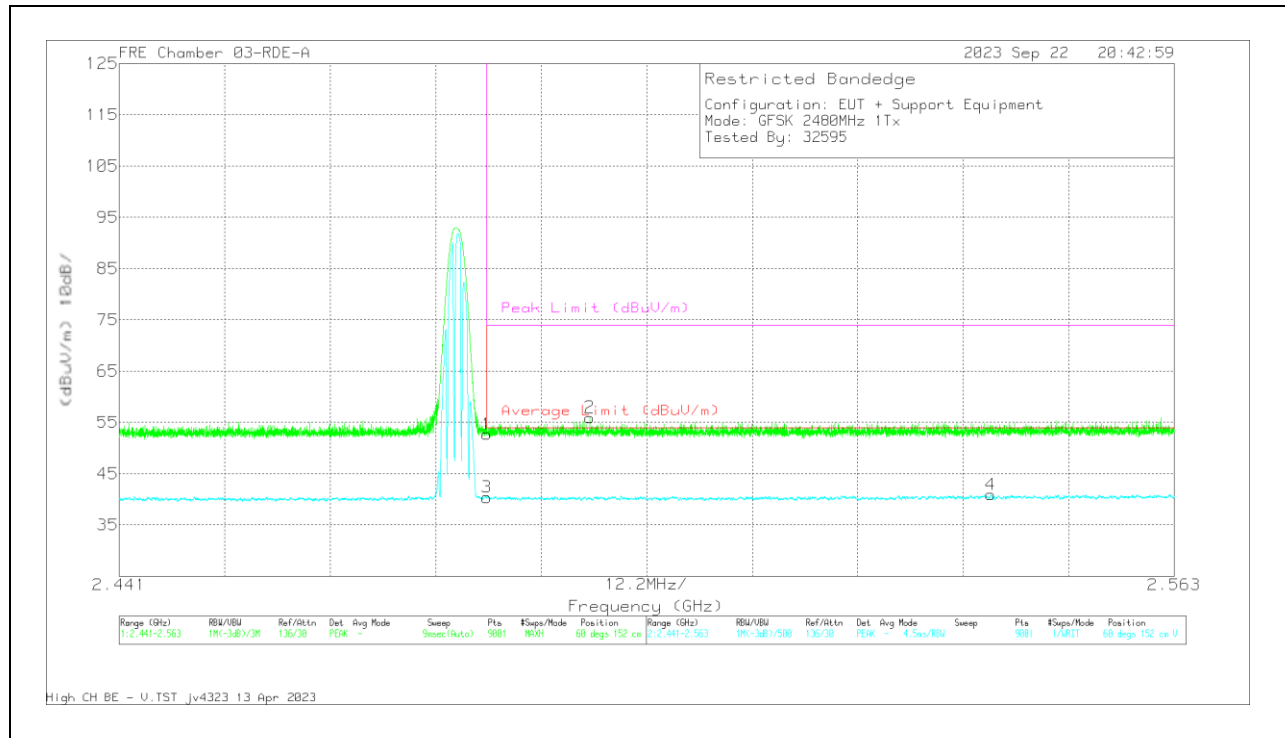

Marker	Frequency (GHz)	Meter Reading (dBuV)	Det	200897 ACF 3m (dB/m)	Gain/Loss (dB)	Corrected Reading (dBuV/m)	Average Limit (dBuV/m)	Margin (dB)	Peak Limit (dBuV/m)	PK Margin (dB)	Azimuth (Degs)	Height (cm)	Polarity
1	* 2.4835	60.32	Pk	32.2	-39.84	52.68	-	-	74	-21.32	60	152	V
2	* 2.495414	63.46	Pk	32.2	-39.73	55.93	-	-	74	-18.07	60	152	V
3	* 2.4835	48.01	VA1T	32.2	-39.84	40.37	54	-13.63	-	-	60	152	V
4	2.541789	48.34	VA1T	32.2	-39.62	40.92	54	-13.08	-	-	60	152	V

\* - indicates frequency in CFR47 Pt 15 / IC RSS-Restricted Band  
 Pk - Peak detector  
 VA1T - FHSS: Linear Voltage Average VB=1/Ton where: Ton is transmit duration

**HARMONICS AND SPURIOUS EMISSIONS**

**LOW CHANNEL RESULTS**

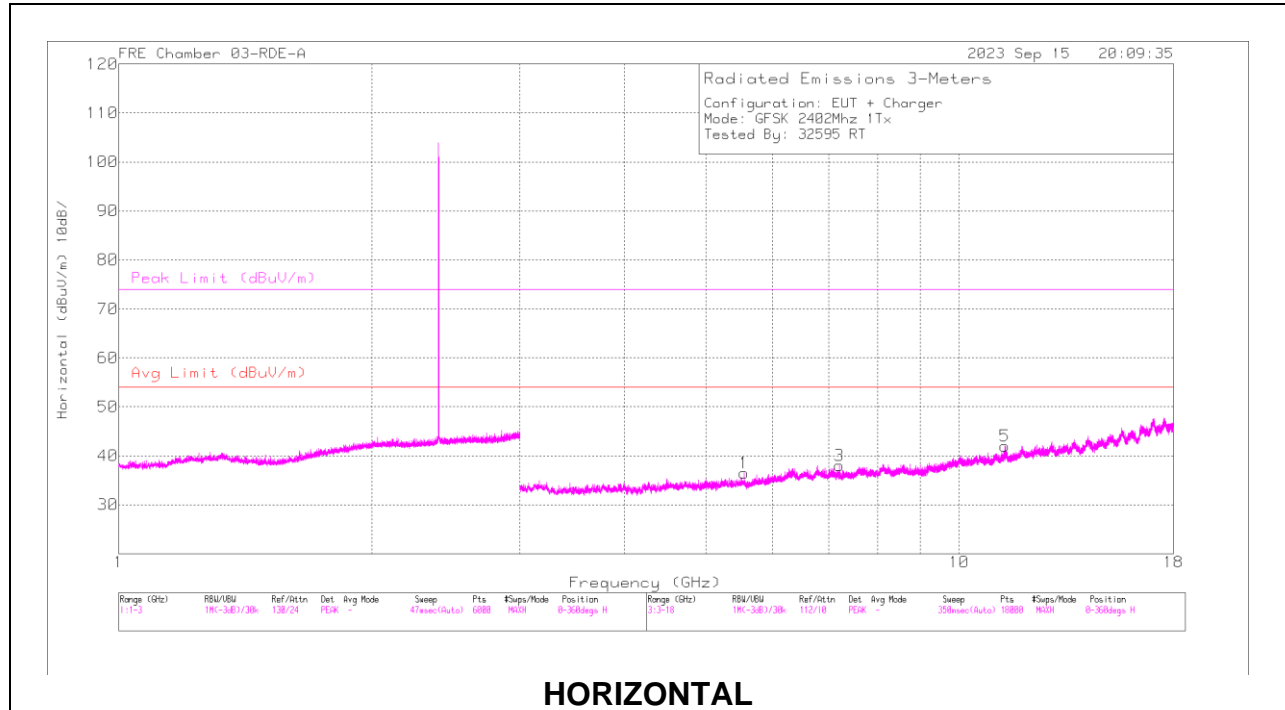

**HORIZONTAL**

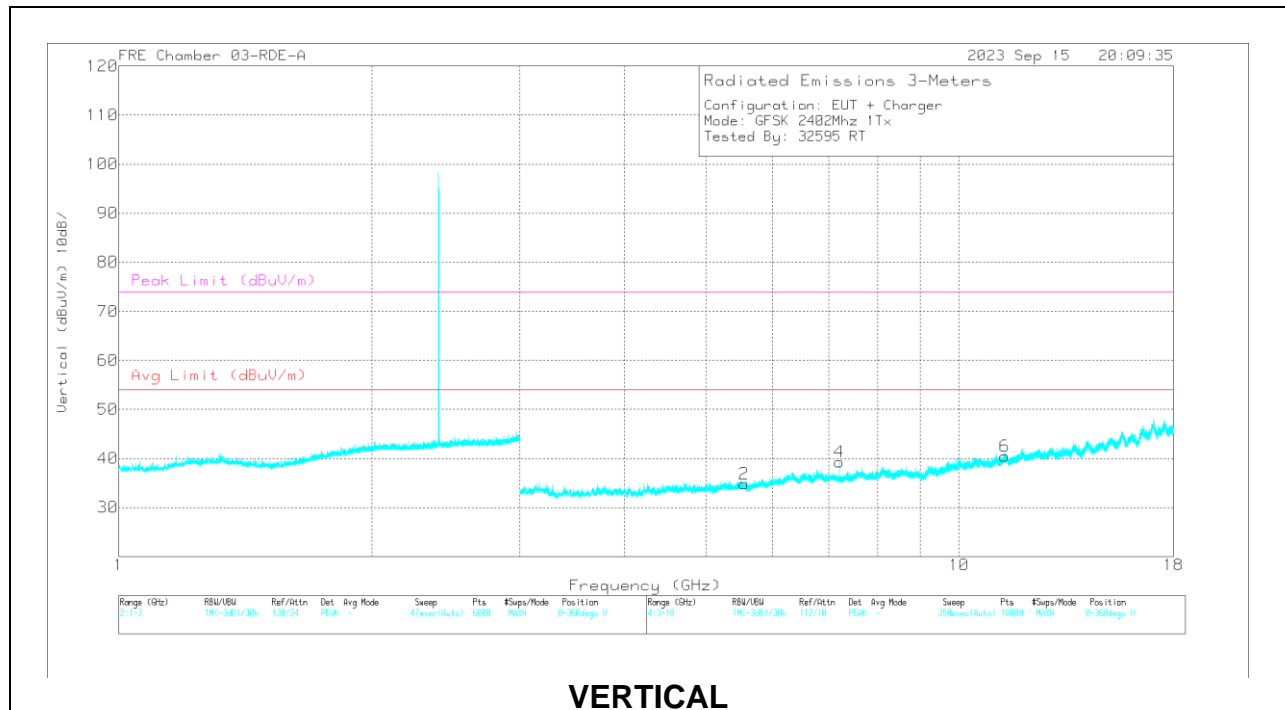

**VERTICAL**

**RADIATED EMISSIONS**

Marker	Frequency (GHz)	Meter Reading (dBuV)	Det	200897 ACF 3m (dB/m)	DCCF (dB)	Gain/Loss (dB)	Corrected Reading (dBuV/m)	Avg Limit (dBuV/m)	Margin (dB)	Peak Limit (dBuV/m)	PK Margin (dB)	Azimuth (Degs)	Height (cm)	Polarity
5	* 11.33652	53.88	PKFH	37.7	0	-43.14	48.44	-	-	74	-25.56	317	254	H
	* 11.33575	40.73	VA1T	37.7	0	-43.14	35.29	54	-18.71	-	-	317	254	H
6	* 11.33550	54.27	PKFH	37.7	0	-43.14	48.83	-	-	74	-25.17	203	230	V
	* 11.33618	40.61	VA1T	37.7	0	-43.14	35.17	54	-18.83	-	-	203	230	V
2	5.548764	55.86	PKFH	34.4	0	-46.91	43.35	-	-	-	-	10	321	H
1	5.549035	56	PKFH	34.4	0	-46.9	43.5	-	-	-	-	27	280	V
4	7.205506	55.02	PKFH	35.6	0	-45.86	44.76	-	-	-	-	71	189	V
3	7.206243	55.16	PKFH	35.6	0	-45.87	44.89	-	-	-	-	13	248	H

\* - indicates frequency in CFR47 Pt 15 / IC RSS-Restricted Band  
 PKFH FHSS/BT RB=100k for Frequencies<1GHz / RB=1MHz for Frequencies>1GHz, VB=3 x RB, Peak  
 VA1T - FHSS: Linear Voltage Average VB=1/Ton where: Ton is transmit duration



### MID CHANNEL RESULTS

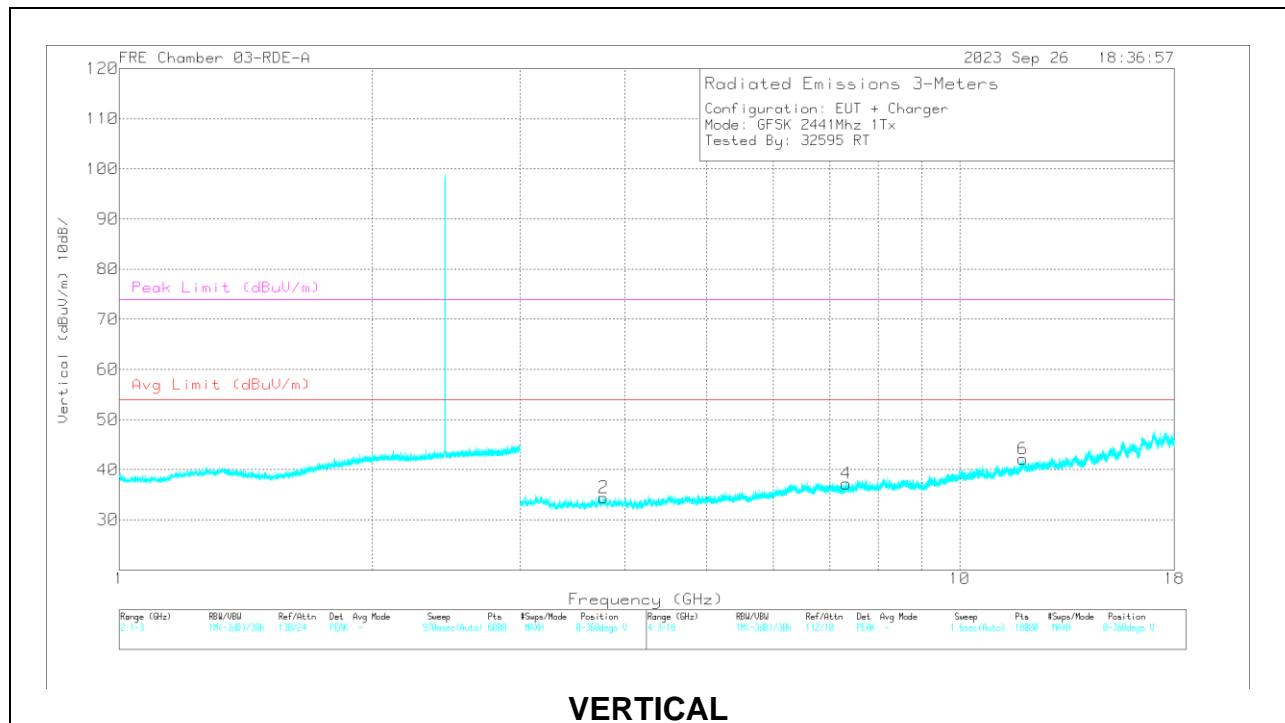
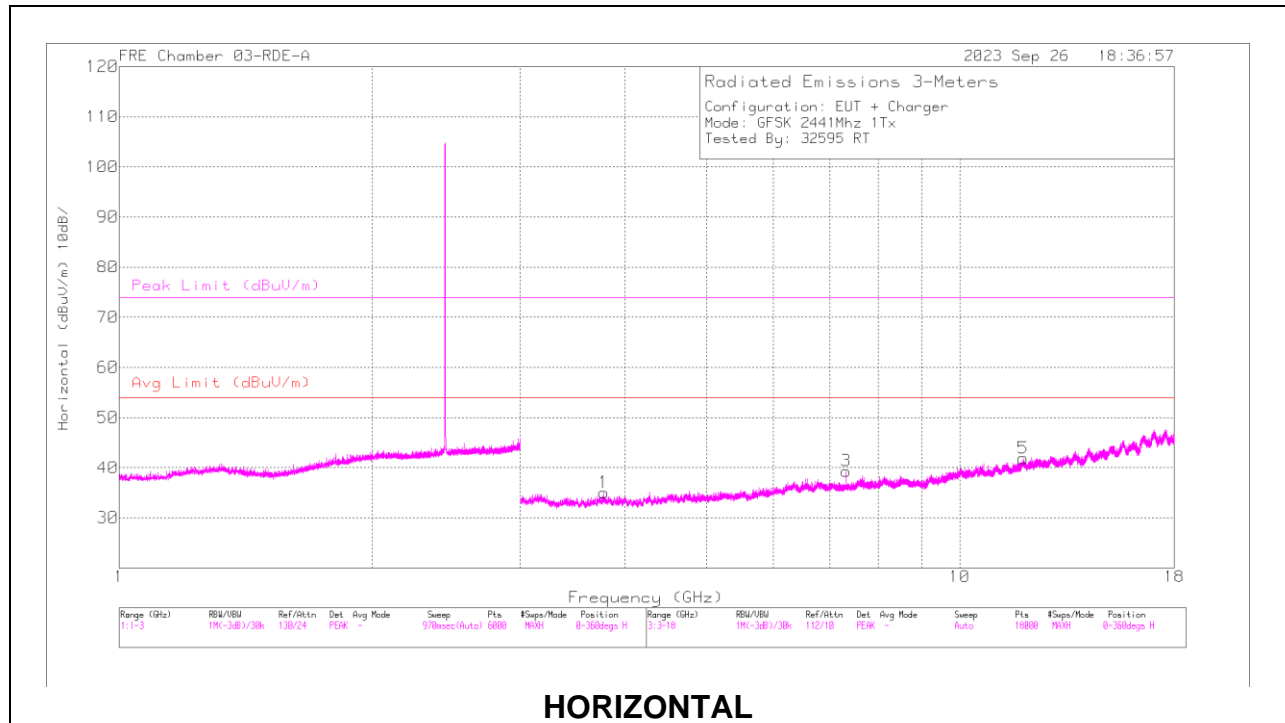

**RADIATED EMISSIONS**

Marker	Frequency (GHz)	Meter Reading (dBuV)	Det	230300 ACF (dB/m)	DCCF (dB)	Gain/Loss (dB)	Corrected Reading (dBuV/m)	Avg Limit (dBuV/m)	Margin (dB)	Peak Limit (dBuV/m)	PK Margin (dB)	Azimuth (Degs)	Height (cm)	Polarity
1	* 7.323047	57.25	PKFH	35.8	0	-47.7	45.35	-	-	74	-28.65	52	167	H
	* 7.322969	45.63	VA1T	35.8	0	-47.7	33.73	54	-19.12	-	-	52	167	H
5	* 4.793171	57.84	PKFH	34.2	0	-49	43.04	-	-	74	-30.96	52	101	H
	* 4.790803	44.25	VA1T	34.2	0	-49.2	29.25	54	-23.6	-	-	52	101	H
2	* 7.351583	57.79	PKFH	35.8	0	-47.5	46.09	-	-	74	-27.91	81	104	V
	* 7.322961	46.7	VA1T	35.8	0	-47.7	34.8	54	-18.05	-	-	81	104	V
3	* 12.18496	57.2	PKFH	38.8	0	-45.6	50.4	-	-	74	-23.6	55	391	V
	* 12.25470	43	VA1T	38.9	0	-45.6	36.3	54	-16.55	-	-	55	391	V
4	* 4.805197	57.11	PKFH	34.2	0	-49.02	42.29	-	-	74	-31.71	55	101	V
	* 4.802835	44.52	VA1T	34.2	0	-49	29.72	54	-23.13	-	-	55	101	V
6	9.775071	57.23	PKFH	37.3	0	-47.5	47.03	-	-	74	-26.97	52	101	H

\* - indicates frequency in CFR47 Pt 15 / IC RSS-Restricted Band  
 PKFH FHSS/BT RB=100k for Frequencies<1GHz / RB=1MHz for Frequencies>1GHz, VB=3 x RB, Peak  
 VA1T - FHSS: Linear Voltage Average VB=1/Ton where: Ton is transmit duration

### HIGH CHANNEL RESULTS

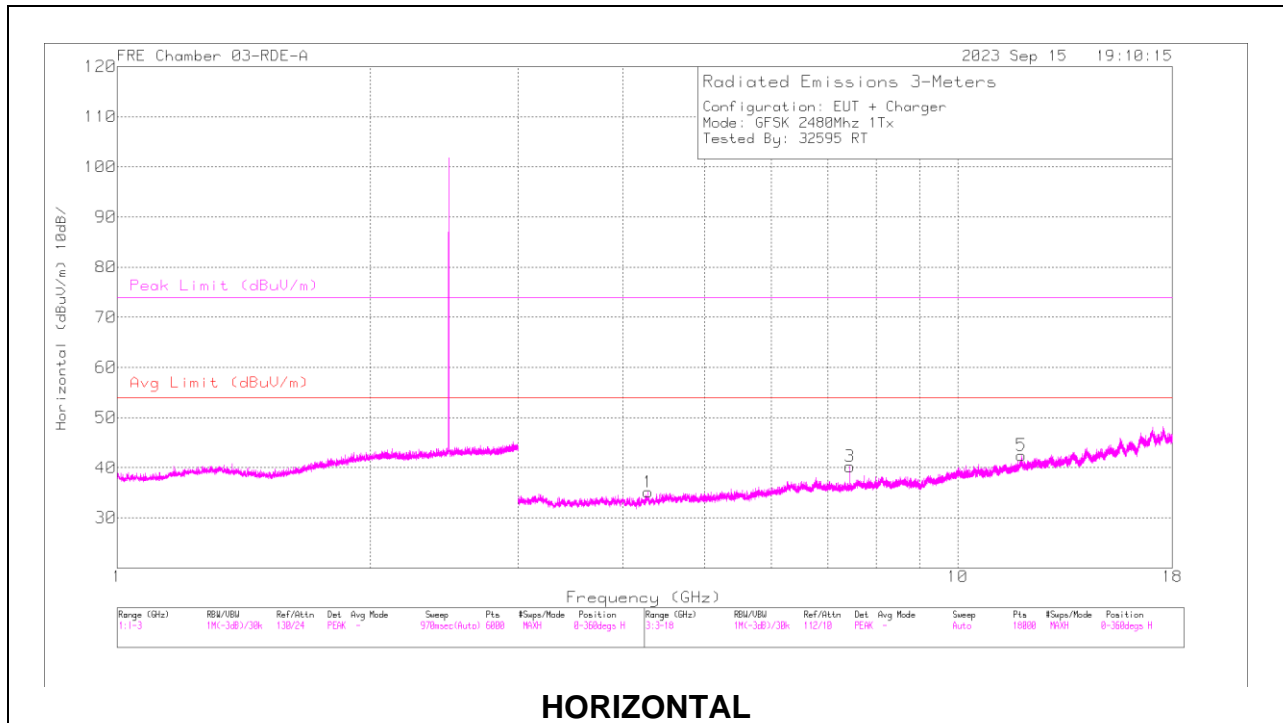

**HORIZONTAL**

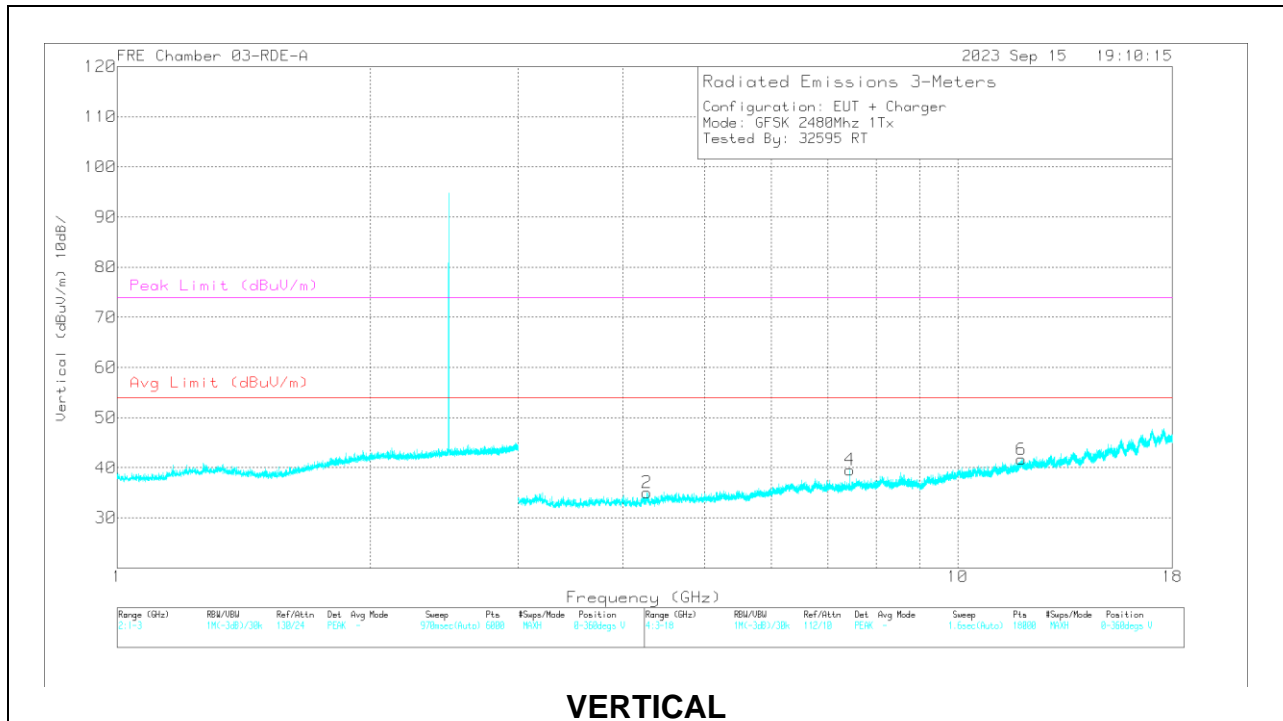

**VERTICAL**

**RADIATED EMISSIONS**

Marker	Frequency (GHz)	Meter Reading (dBuV)	Det	200897 ACF 3m (dB/m)	DCCF (dB)	Gain/Loss (dB)	Corrected Reading (dBuV/m)	Avg Limit (dBuV/m)	Margin (dB)	Peak Limit (dBuV/m)	PK Margin (dB)	Azimuth (Degs)	Height (cm)	Polarity
1	* 4.284721	55.6	PKFH	33.4	0	-46.94	42.06	-	-	74	-31.94	295	244	H
	* 4.284072	42.79	VA1T	33.4	0	-46.96	29.23	54	-24.77	-	-	295	244	H
3	* 7.440614	57.12	PKFH	35.6	0	-45.79	46.93	-	-	74	-27.07	228	375	H
	* 7.440057	45.58	VA1T	35.6	0	-45.8	35.38	54	-18.62	-	-	228	375	H
5	* 11.90768	53.51	PKFH	38.5	0	-42.27	49.74	-	-	74	-24.26	108	359	H
	* 11.90726	39.88	VA1T	38.5	0	-42.27	36.11	54	-17.89	-	-	108	359	H
2	* 4.265069	56.6	PKFH	33.4	0	-47.29	42.71	-	-	74	-31.29	196	251	V
	* 4.265457	43.07	VA1T	33.4	0	-47.26	29.21	54	-24.79	-	-	196	251	V
4	* 7.439803	56.88	PKFH	35.6	0	-45.8	46.68	-	-	74	-27.32	251	121	V
	* 7.440064	46.1	VA1T	35.6	0	-45.8	35.9	54	-18.1	-	-	251	121	V
6	* 11.90174	53.17	PKFH	38.5	0	-42.25	49.42	-	-	74	-24.58	290	339	V
	* 11.90088	40.04	VA1T	38.5	0	-42.24	36.3	54	-17.7	-	-	290	339	V

\* - indicates frequency in CFR47 Pt 15 / IC RSS-Restricted Band  
 PKFH FHSS/BT RB=100k for Frequencies<1GHz / RB=1MHz for Frequencies>1GHz, VB=3 x RB, Peak  
 VA1T - FHSS: Linear Voltage Average VB=1/Ton where: Ton is transmit duration

### 10.1.2. BLUETOOTH BASIC DATA RATE 8PSK MODULATION

#### BANDEDGE (LOW CHANNEL)

#### HORIZONTAL RESULT

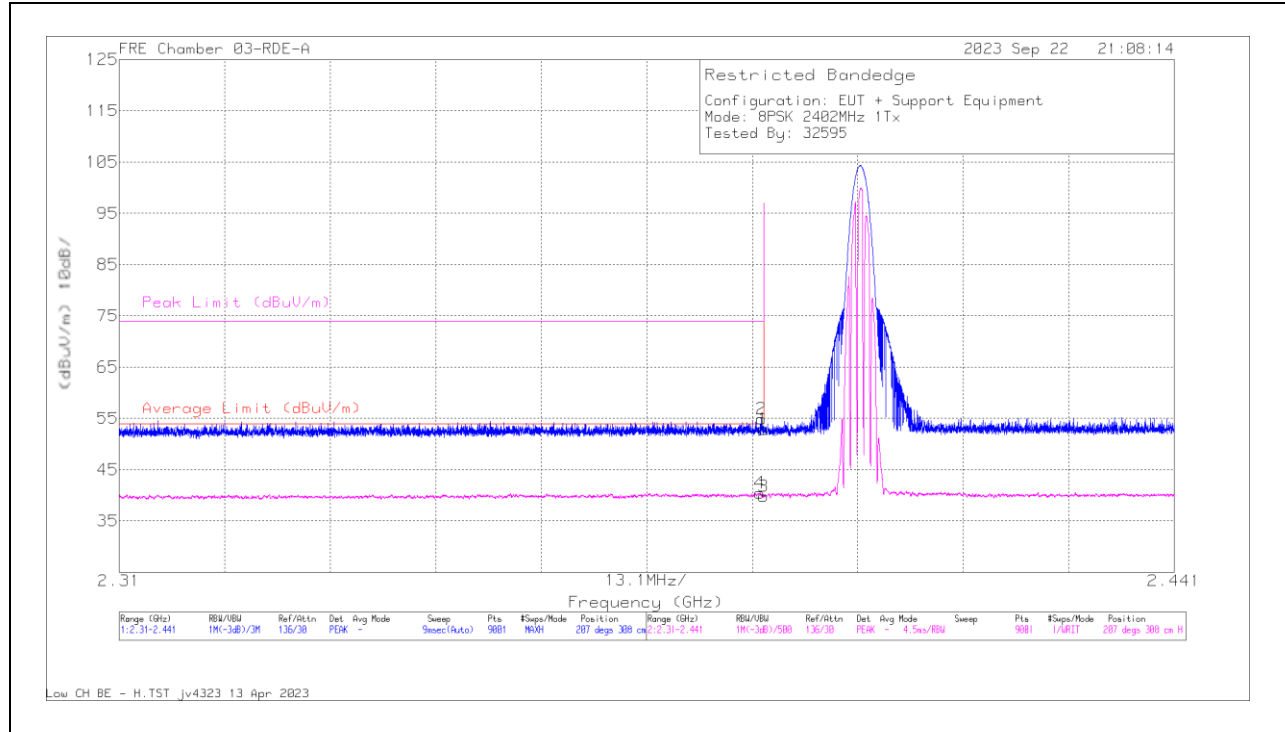

Marker	Frequency (GHz)	Meter Reading (dBuV)	Det	200897 ACF 3m (dB/m)	Gain/Loss (dB)	Corrected Reading (dBuV/m)	Average Limit (dBuV/m)	Margin (dB)	Peak Limit (dBuV/m)	PK Margin (dB)	Azimuth (Degs)	Height (cm)	Polarity
1	* 2.39	61.01	Pk	31.9	-40.07	52.84	-	-	74	-21.16	207	308	H
2	* 2.389723	63.07	Pk	31.9	-40.06	54.91	-	-	74	-19.09	207	308	H
3	* 2.39	47.98	VA1T	31.9	-40.07	39.81	54	-14.19	-	-	207	308	H
4	* 2.389534	48.62	VA1T	31.9	-40.06	40.46	54	-13.54	-	-	207	308	H

\* - indicates frequency in CFR47 Pt 15 / IC RSS-Restricted Band  
 Pk - Peak detector  
 VA1T - FHSS: Linear Voltage Average VB=1/Ton where: Ton is transmit duration

### VERTICAL RESULT

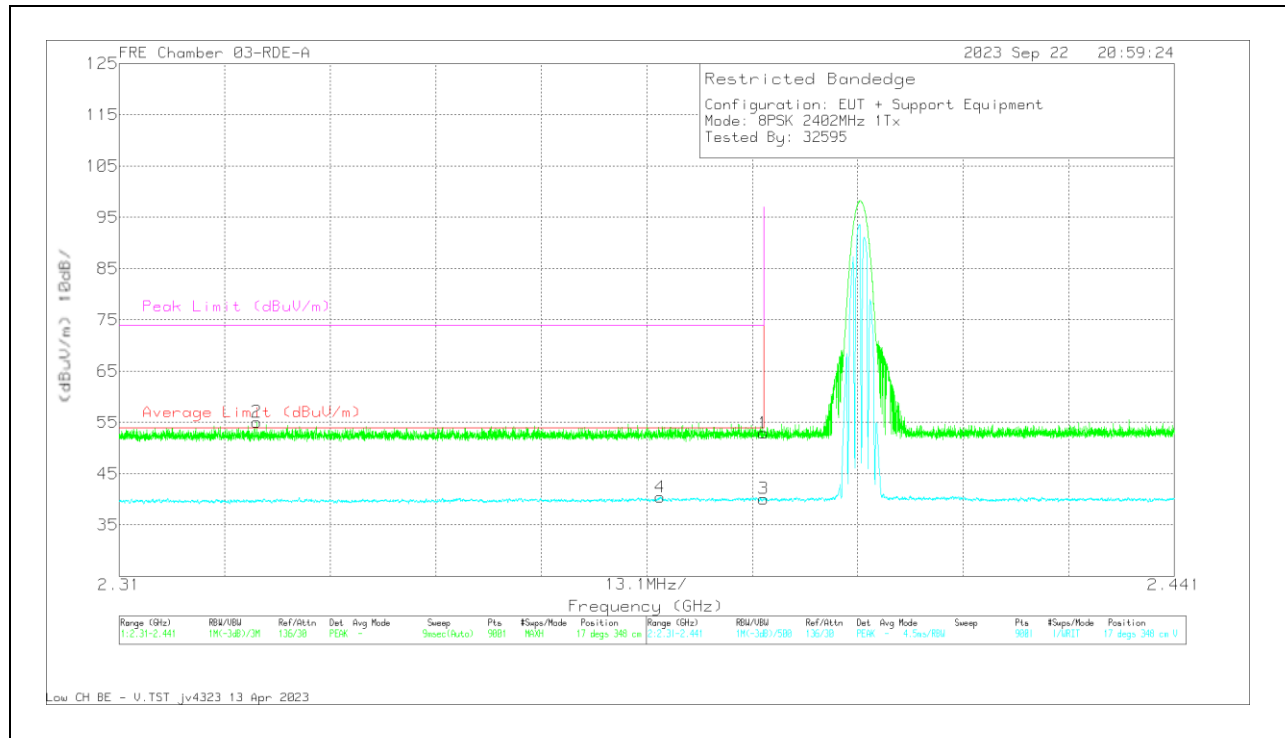

Marker	Frequency (GHz)	Meter Reading (dBuV)	Det	200897 ACF 3m (dB/m)	Gain/Loss (dB)	Corrected Reading (dBuV/m)	Average Limit (dBuV/m)	Margin (dB)	Peak Limit (dBuV/m)	PK Margin (dB)	Azimuth (Degs)	Height (cm)	Polarity
1	* 2.39	61.11	Pk	31.9	-40.07	52.94	-	-	74	-21.06	17	348	V
2	* 2.32706	63.57	Pk	31.7	-40.2	55.07	-	-	74	-18.93	17	348	V
3	* 2.39	48.29	VA1T	31.9	-40.07	40.12	54	-13.88	-	-	17	348	V
4	* 2.377191	48.6	VA1T	31.9	-40.07	40.43	54	-13.57	-	-	17	348	V

\* - indicates frequency in CFR47 Pt 15 / IC RSS-Restricted Band  
 Pk - Peak detector  
 VA1T - FHSS: Linear Voltage Average VB=1/Ton where: Ton is transmit duration

**BANDEDGE (HIGH CHANNEL)**

**HORIZONTAL RESULT**

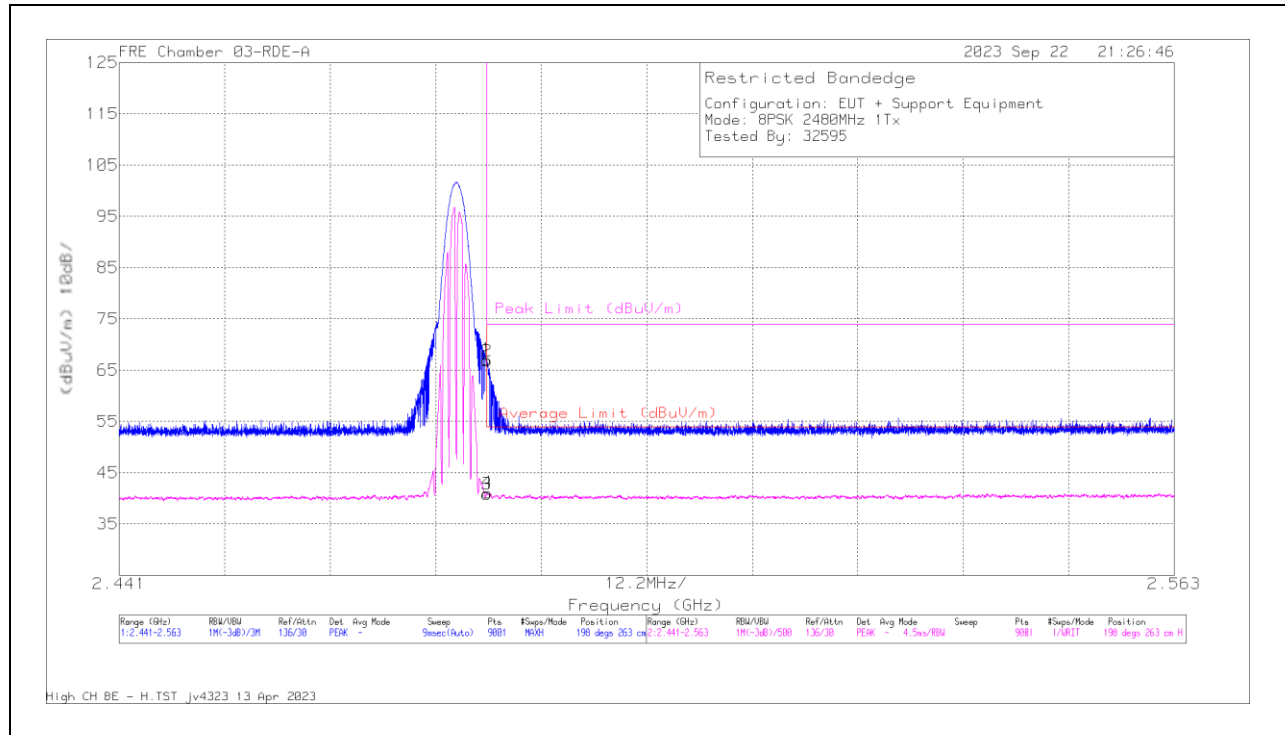

Marker	Frequency (GHz)	Meter Reading (dBuV)	Det	200897 ACF 3m (dB/m)	Gain/Loss (dB)	Corrected Reading (dBuV/m)	Average Limit (dBuV/m)	Margin (dB)	Peak Limit (dBuV/m)	PK Margin (dB)	Azimuth (Degs)	Height (cm)	Polarity
1	* 2.4835	74.76	Pk	32.2	-39.84	67.12	-	-	74	-6.88	198	263	H
2	* 2.483525	74.42	Pk	32.2	-39.83	66.79	-	-	74	-7.21	198	263	H
3	* 2.4835	48.46	VA1T	32.2	-39.84	40.82	54	-13.18	-	-	198	263	H
4	* 2.483552	48.72	VA1T	32.2	-39.83	41.09	54	-12.91	-	-	198	263	H

\* - indicates frequency in CFR47 Pt 15 / IC RSS-Restricted Band  
 Pk - Peak detector  
 VA1T - FHSS: Linear Voltage Average VB=1/Ton where: Ton is transmit duration

### VERTICAL RESULT

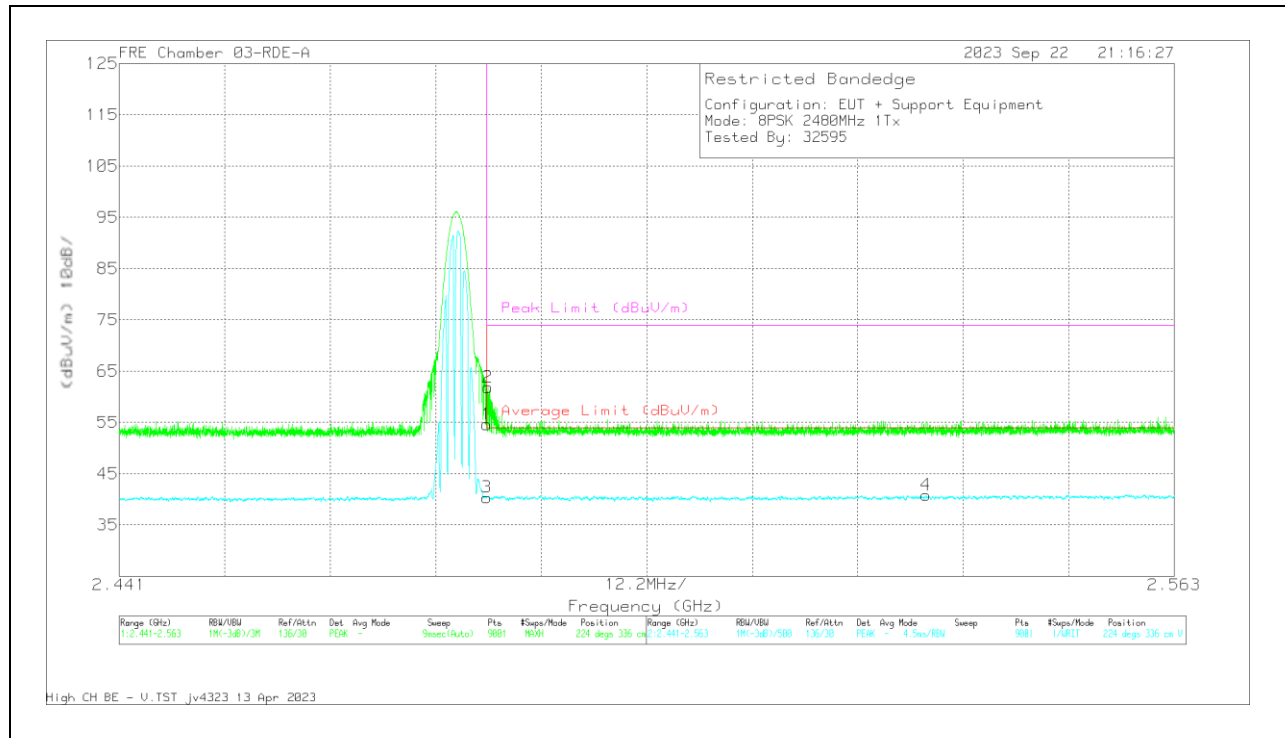

Marker	Frequency (GHz)	Meter Reading (dBuV)	Det	200897 ACF 3m (dB/m)	Gain/Loss (dB)	Corrected Reading (dBuV/m)	Average Limit (dBuV/m)	Margin (dB)	Peak Limit (dBuV/m)	PK Margin (dB)	Azimuth (Degs)	Height (cm)	Polarity
1	* 2.4835	62.27	Pk	32.2	-39.84	54.63	-	-	74	-19.37	224	336	V
2	* 2.48362	69.49	Pk	32.2	-39.83	61.86	-	-	74	-12.14	224	336	V
3	* 2.4835	48	VA1T	32.2	-39.84	40.36	54	-13.64	-	-	224	336	V
4	2.534306	48.31	VA1T	32.2	-39.67	40.84	54	-13.16	-	-	224	336	V

\* - indicates frequency in CFR47 Pt 15 / IC RSS-Restricted Band  
 Pk - Peak detector  
 VA1T - FHSS: Linear Voltage Average VB=1/Ton where: Ton is transmit duration



**HARMONICS AND SPURIOUS EMISSIONS**

**LOW CHANNEL RESULTS**

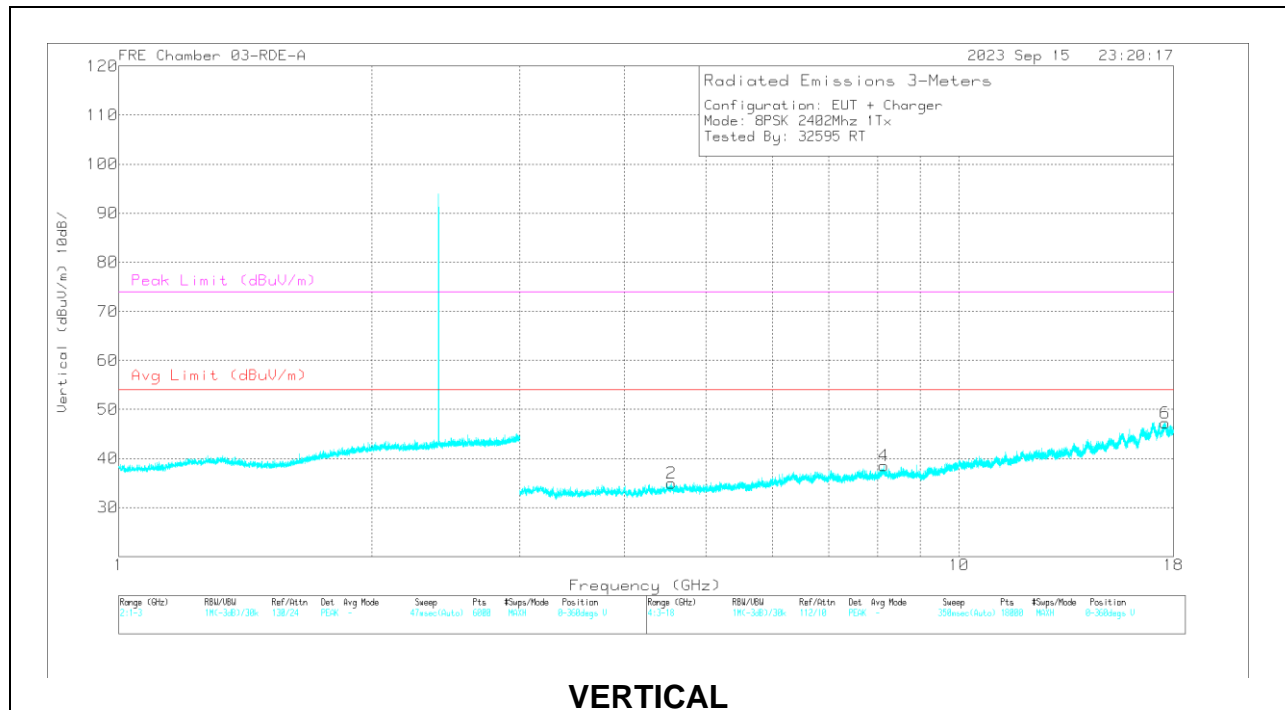
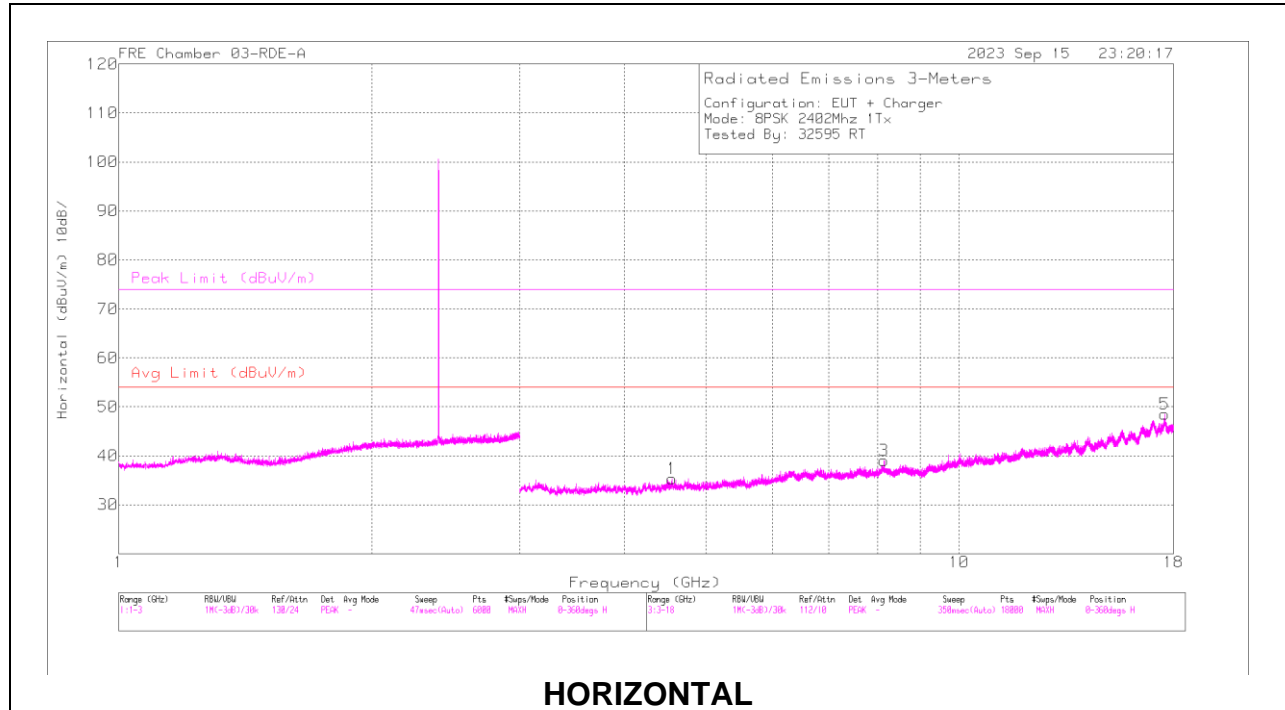

**RADIATED EMISSIONS**

Marker	Frequency (GHz)	Meter Reading (dBuV)	Det	200897 ACF 3m (dB/m)	DCCF (dB)	Gain/Loss (dB)	Corrected Reading (dBuV/m)	Avg Limit (dBuV/m)	Margin (dB)	Peak Limit (dBuV/m)	PK Margin (dB)	Azimuth (Degs)	Height (cm)	Polarity
1	* 4.55774	56.33	PKFH	33.8	0	-47.52	42.61	-	-	74	-31.39	3	337	H
	* 4.557711	43.24	VA1T	33.8	0	-47.52	29.52	54	-24.48	-	-	3	337	H
3	* 8.143111	55.09	PKFH	35.6	0	-44.41	46.28	-	-	74	-27.72	85	312	H
	* 8.14487	41.42	VA1T	35.6	0	-44.41	32.61	54	-21.39	-	-	85	312	H
2	* 4.542644	56.43	PKFH	33.8	0	-47.57	42.66	-	-	74	-31.34	174	230	V
	* 4.542659	43.46	VA1T	33.8	0	-47.57	29.69	54	-24.31	-	-	174	230	V
4	* 8.147167	54.55	PKFH	35.7	0	-44.43	45.82	-	-	74	-28.18	63	301	V
	* 8.147357	41.5	VA1T	35.7	0	-44.43	32.77	54	-21.23	-	-	63	301	V
5	17.580564	51.12	PKFH	41.6	0	-37.72	55	-	-	74	-19	326	361	H
6	17.589392	50.59	PKFH	41.6	0	-37.88	54.31	-	-	74	-19.69	34	291	V

\* - indicates frequency in CFR47 Pt 15 / IC RSS-Restricted Band  
 PKFH FHSS/BT RB=100k for Frequencies<1GHz / RB=1MHz for Frequencies>1GHz, VB=3 x RB, Peak  
 VA1T - FHSS: Linear Voltage Average VB=1/Ton where: Ton is transmit duration

### MID CHANNEL RESULTS

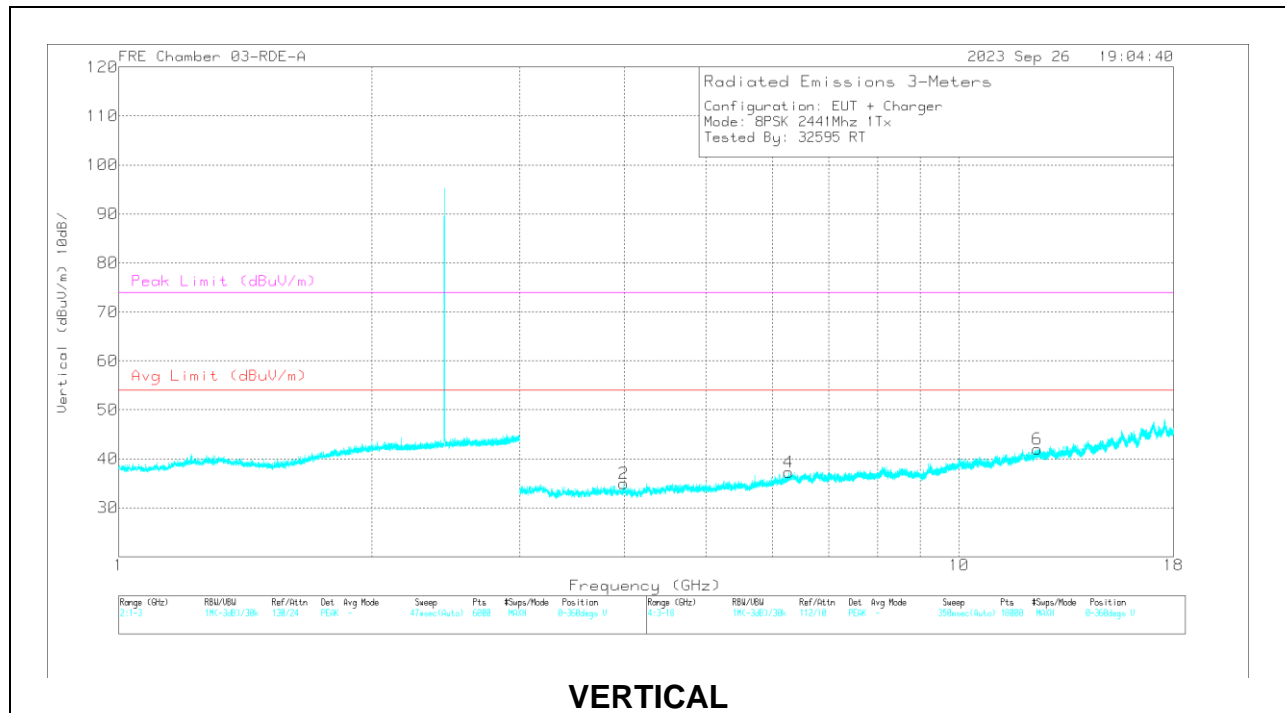
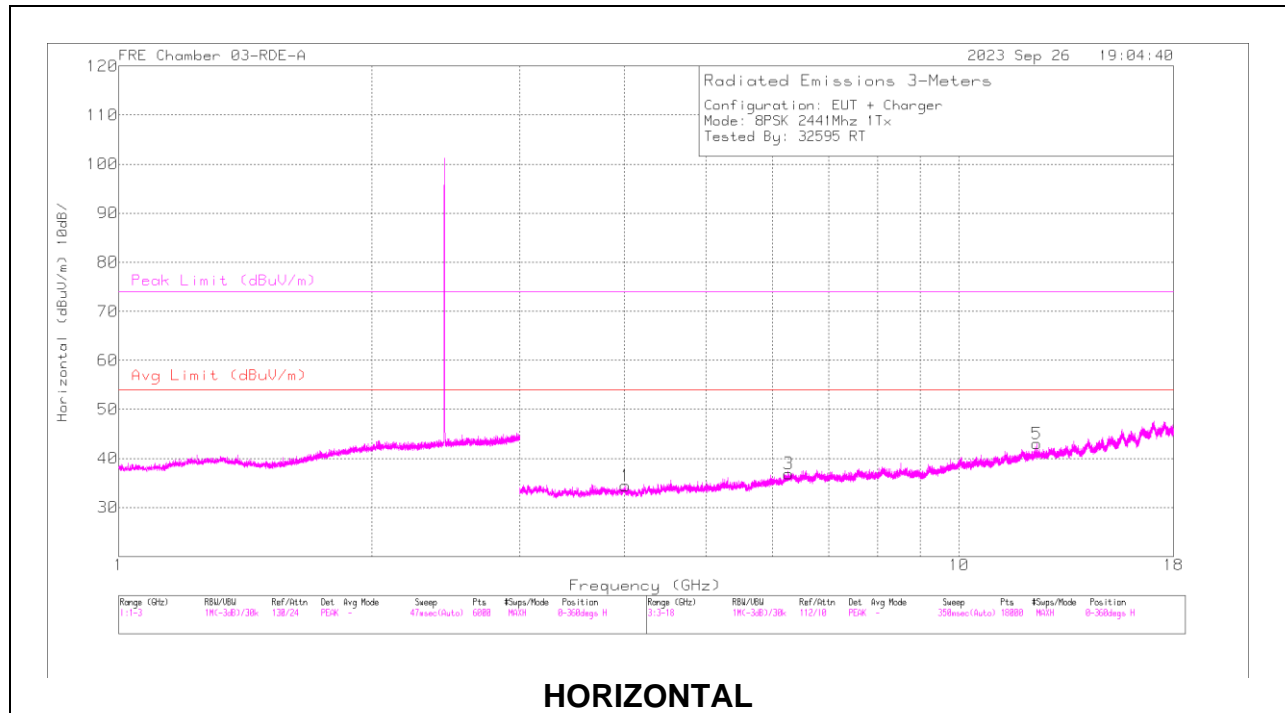

**RADIATED EMISSIONS**

Marker	Frequency (GHz)	Meter Reading (dBuV)	Det	200897 ACF 3m (dB/m)	DCCF (dB)	Gain/Loss (dB)	Corrected Reading (dBuV/m)	Avg Limit (dBuV/m)	Margin (dB)	Peak Limit (dBuV/m)	PK Margin (dB)	Azimuth (Degs)	Height (cm)	Polarity
1	* 4.705785	57.67	PKFH	34	0	-47.91	43.76	-	-	74	-30.24	358	323	H
	* 4.705641	43.47	VA1T	34	0	-47.9	29.57	54	-24.43	-	-	358	323	H
3	* 7.323355	55.98	PKFH	35.6	0	-45.6	45.98	-	-	74	-28.02	299	133	H
	* 7.322905	41.73	VA1T	35.6	0	-45.6	31.73	54	-22.27	-	-	299	133	H
5	* 9.363291	54.72	PKFH	36.2	0	-44.85	46.07	-	-	74	-27.93	179	107	H
	* 9.364777	41.48	VA1T	36.2	0	-44.86	32.82	54	-21.18	-	-	179	107	H
2	* 4.715622	57.38	PKFH	34	0	-48.05	43.33	-	-	74	-30.67	19	186	V
	* 4.716967	43.79	VA1T	34	0	-48.18	29.61	54	-24.39	-	-	19	186	V
4	* 7.324022	54.98	PKFH	35.6	0	-45.59	44.99	-	-	74	-29.01	243	204	V
	* 7.324189	41.68	VA1T	35.6	0	-45.59	31.69	54	-22.31	-	-	243	204	V
6	* 9.344841	54.17	PKFH	36.2	0	-44.69	45.68	-	-	74	-28.32	284	180	V
	* 9.343732	41.31	VA1T	36.2	0	-44.68	32.83	54	-21.17	-	-	284	180	V

\* - indicates frequency in CFR47 Pt 15 / IC RSS-Restricted Band  
 PKFH FHSS/BT RB=100k for Frequencies<1GHz / RB=1MHz for Frequencies>1GHz, VB=3 x RB, Peak  
 VA1T - FHSS: Linear Voltage Average VB=1/Ton where: Ton is transmit duration

### HIGH CHANNEL RESULTS

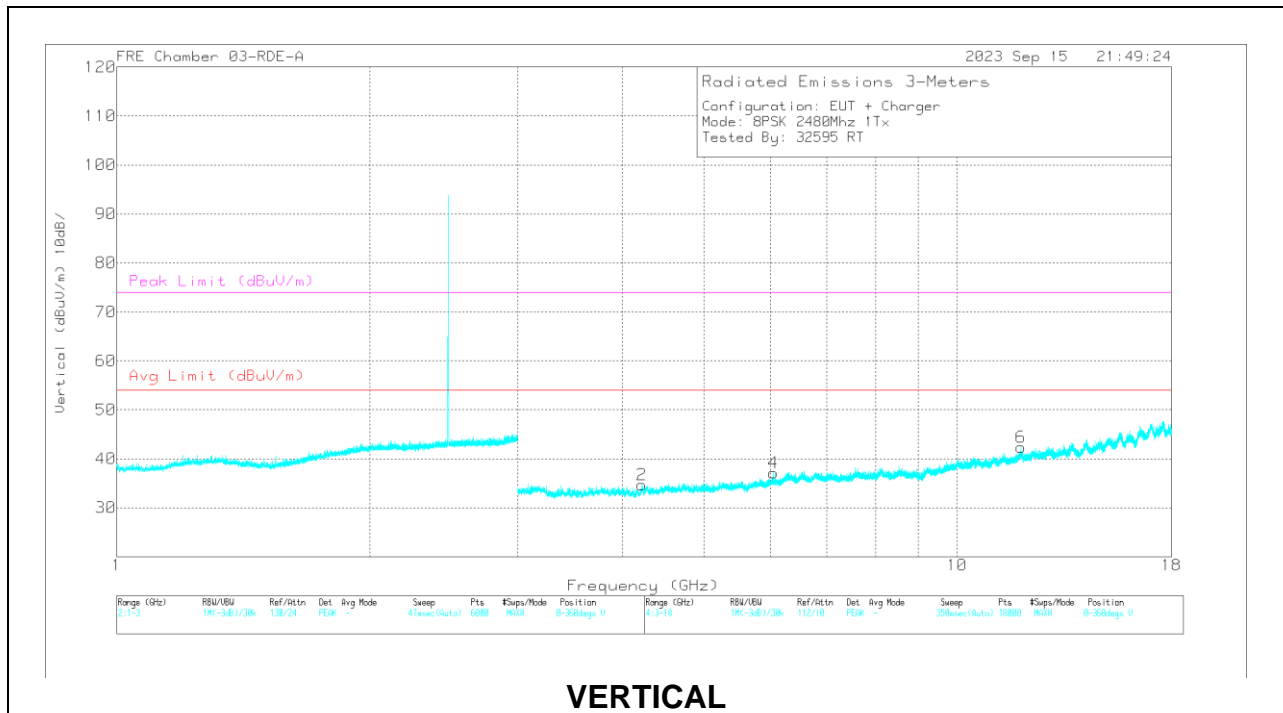
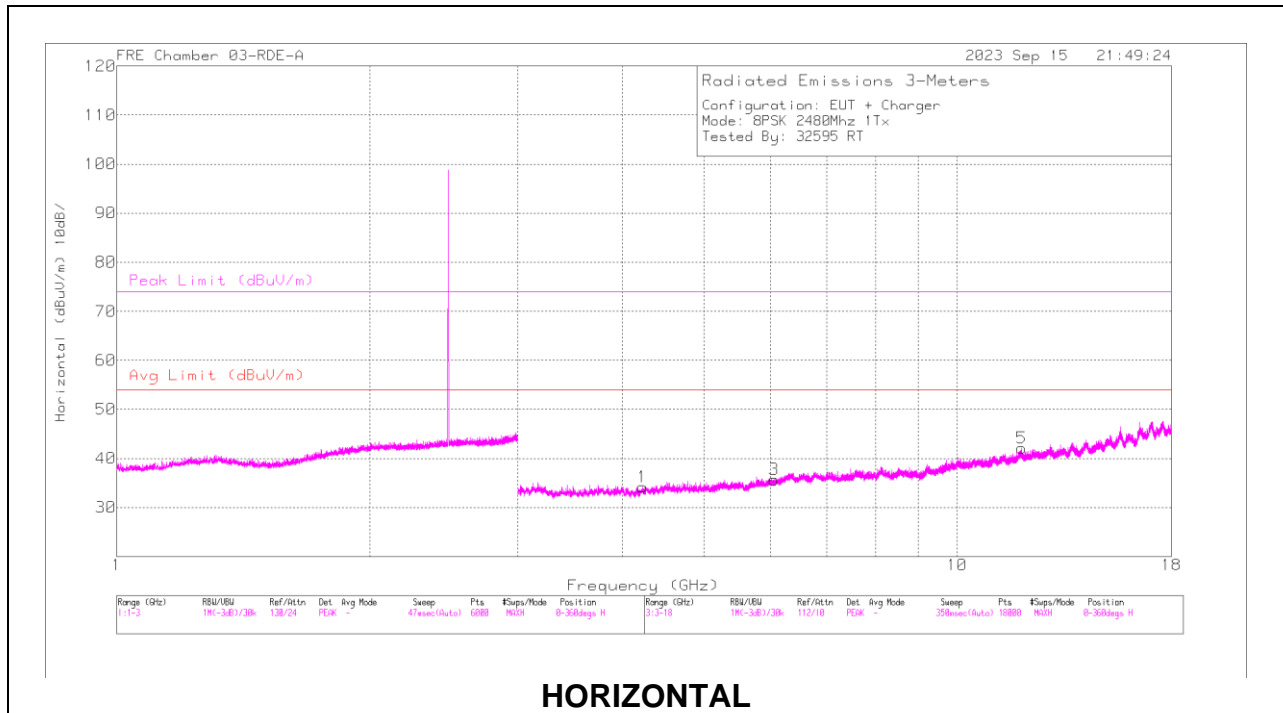

**RADIATED EMISSIONS**

Marker	Frequency (GHz)	Meter Reading (dBuV)	Det	200897 ACF 3m (dB/m)	DCCF (dB)	Gain/Loss (dB)	Corrected Reading (dBuV/m)	Avg Limit (dBuV/m)	Margin (dB)	Peak Limit (dBuV/m)	PK Margin (dB)	Azimuth (Degs)	Height (cm)	Polarity
1	* 4.222283	55.66	PKFH	33.3	0	-47.08	41.88	-	-	74	-32.12	181	282	H
	* 4.223736	43.01	VA1T	33.3	1.12	-46.98	30.45	54	-23.55	-	-	181	282	H
5	* 11.93329	53.67	PKFH	38.5	0	-42.41	49.76	-	-	74	-24.24	17	259	H
	* 11.93347	39.85	VA1T	38.5	1.12	-42.41	37.06	54	-16.94	-	-	17	259	H
2	* 4.213051	56.47	PKFH	33.3	0	-47.05	42.72	-	-	74	-31.28	256	153	V
	* 4.214079	42.84	VA1T	33.3	1.12	-47.04	30.22	54	-23.78	-	-	256	153	V
6	* 11.91765	53.05	PKFH	38.5	0	-42.18	49.37	-	-	74	-24.63	319	275	V
	* 11.91777	39.84	VA1T	38.5	1.12	-42.18	37.28	54	-16.72	-	-	319	275	V
4	6.039653	54.79	PKFH	35.2	0	-45.89	44.1	-	-	74	-29.9	310	206	V
3	6.057305	55.12	PKFH	35.2	0	-45.87	44.45	-	-	74	-29.55	308	207	H

\* - indicates frequency in CFR47 Pt 15 / IC RSS-Restricted Band  
 PKFH FHSS/BT RB=100k for Frequencies<1GHz / RB=1MHz for Frequencies>1GHz, VB=3 x RB, Peak  
 VA1T - FHSS: Linear Voltage Average VB=1/Ton where: Ton is transmit duration

## 10.2. WORST CASE BELOW 30MHZ

### SPURIOUS EMISSIONS BELOW 30 MHz (WORST-CASE CONFIGURATION)

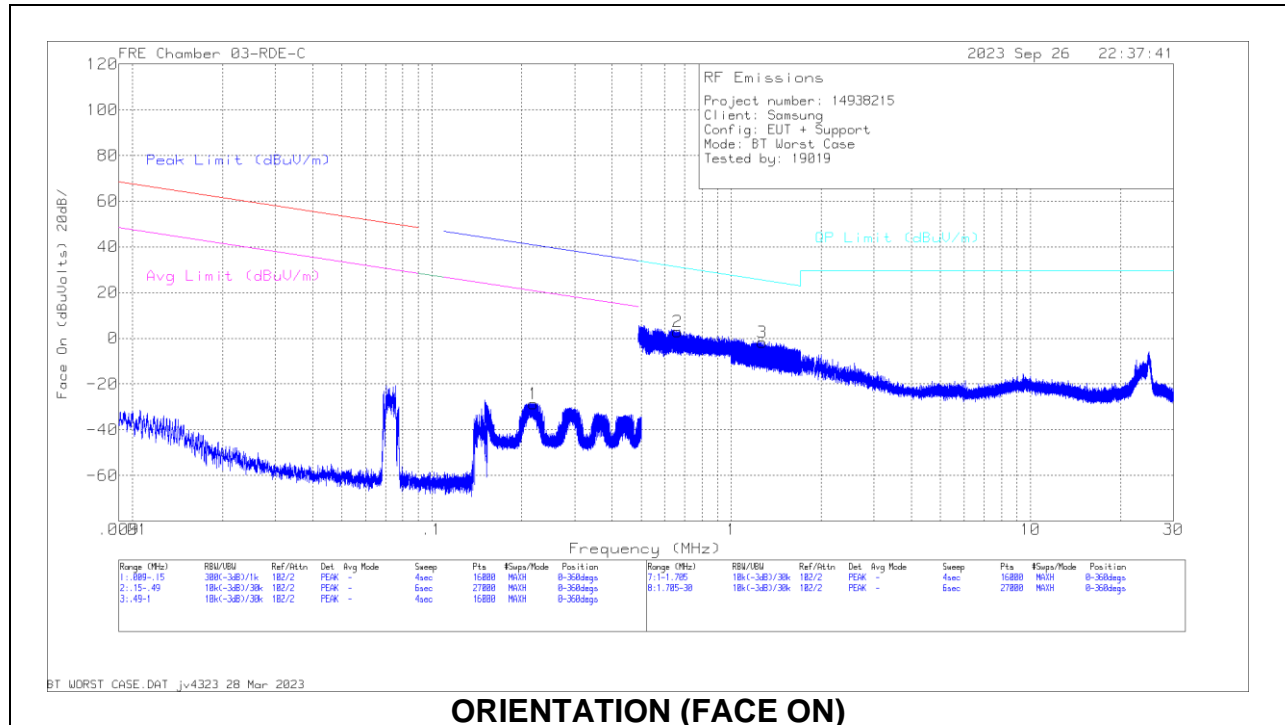

**ORIENTATION (FACE ON)**

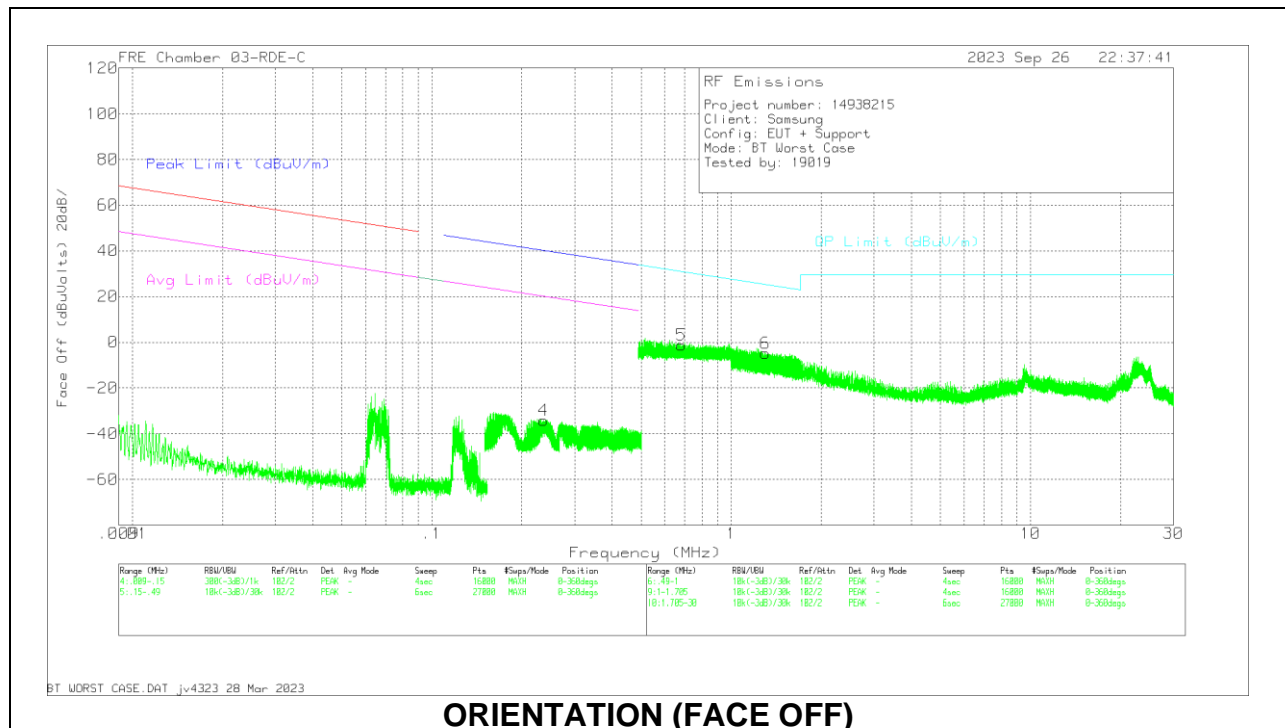

**ORIENTATION (FACE OFF)**

**Below 30MHz Data**

Marker	Frequency (MHz)	Meter Reading (dBuV)	Det	Loop Antenna E(ACF) (dB)	Cbl (dB)	Dist Corr 300m (dB)	Corrected Reading (dBuVolts)	Peak Limit (dBuV/m)	Margin (dB)	Avg Limit (dBuV/m)	Margin (dB)	Azimuth (Degs)
1	.2192	27.81	Pk	56.4	-32.8	-80	-28.59	40.8	-69.39	20.8	-49.39	0-360
4	.2364	22.19	Pk	56.4	-32.8	-80	-34.21	40.14	-74.35	20.14	-54.35	0-360

Marker	Frequency (MHz)	Meter Reading (dBuV)	Det	Loop Antenna E(ACF) (dB)	Cbl (dB)	Dist Corr 30m (dB) 40Log	Corrected Reading (dBuVolts)	QP Limit (dBuV/m)	Margin (dB)	Azimuth (Degs)
2	.6638	19.27	Pk	56.3	-32.6	-40	2.97	31.17	-28.2	0-360
5	.6809	15.2	Pk	56.3	-32.7	-40	-1.2	30.95	-32.15	0-360
3	1.2684	25.37	Pk	45.4	-32.6	-40	-1.83	25.56	-27.39	0-360
6	1.303	22.5	Pk	45.2	-32.6	-40	-4.9	25.33	-30.23	0-360

Pk - Peak detector



### 10.3. WORST CASE BELOW 1 GHZ

#### SPURIOUS EMISSIONS 30 TO 1000 MHz (WORST-CASE CONFIGURATION)

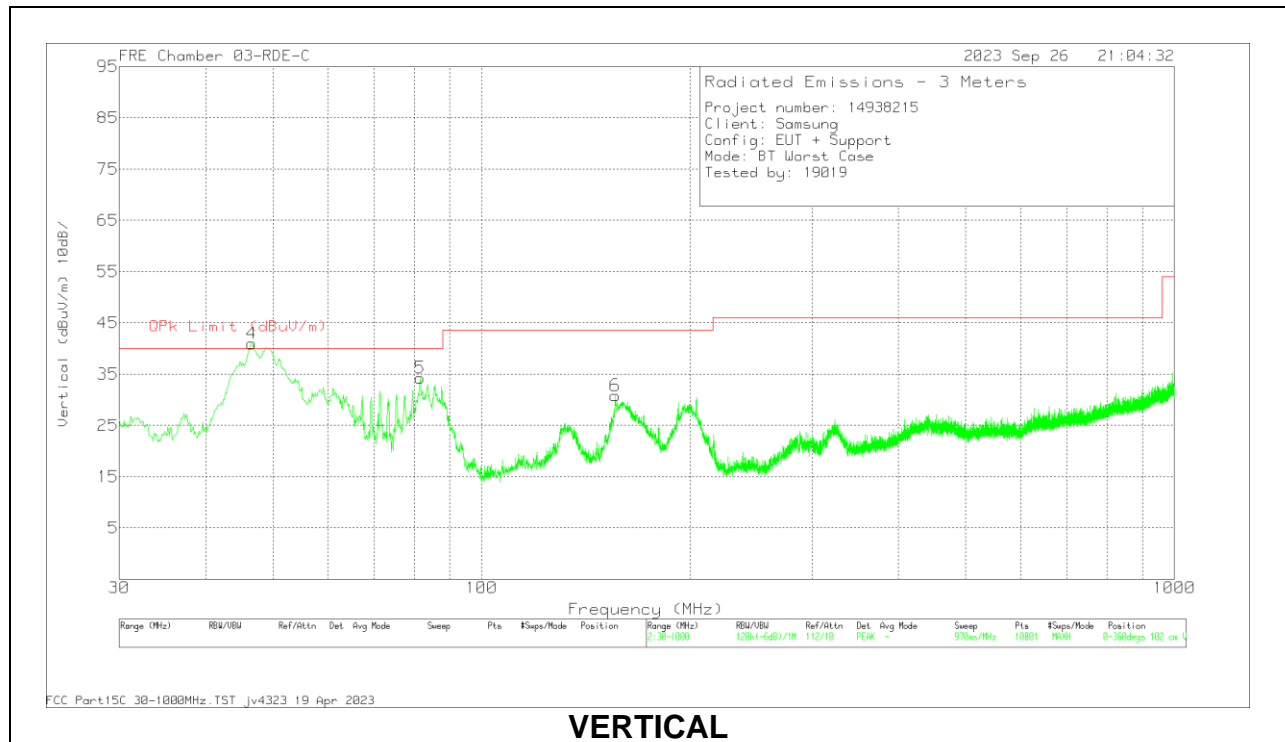
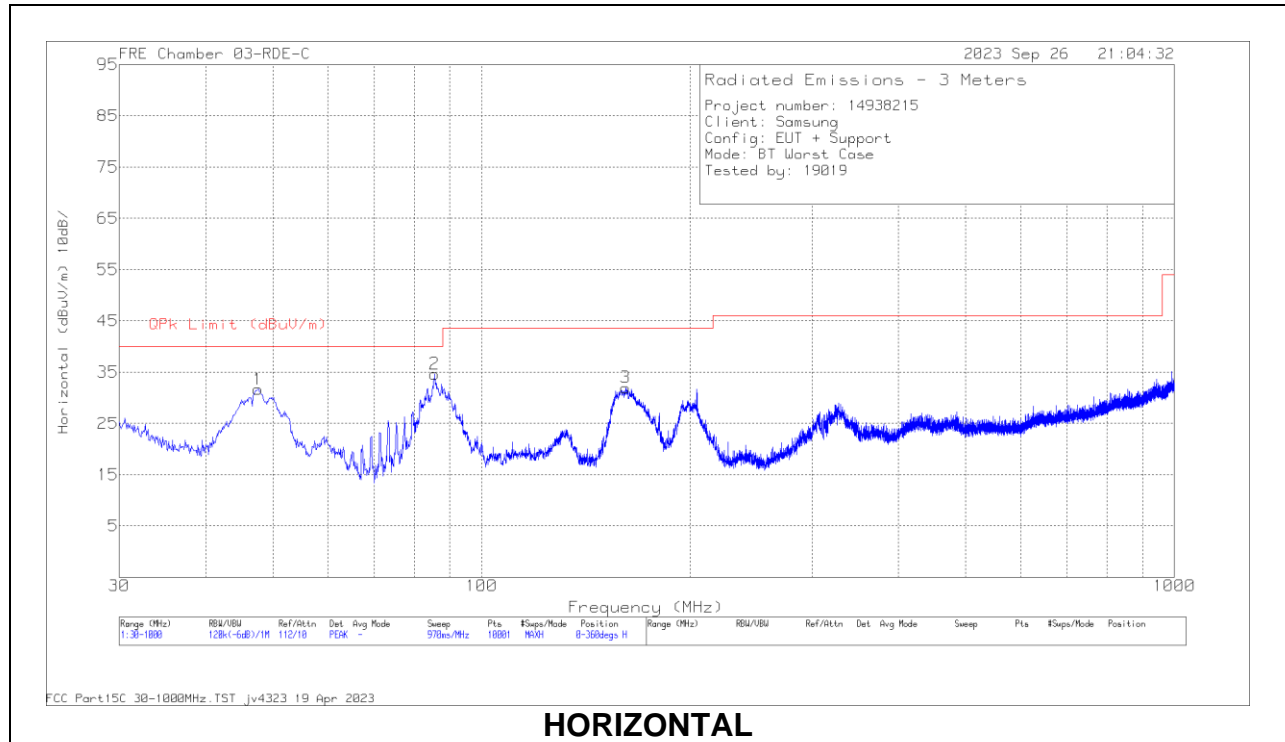

**Below 1GHz Data**

Marker	Frequency (MHz)	Meter Reading (dBuV)	Det	235174 ACF (dB) 10m H	Cbl (dB)	Corrected Reading (dBuV/m)	QPk Limit (dBuV/m)	Margin (dB)	Azimuth (Degs)	Height (cm)	Polarity
4	46.587	57.04	Pk	15.2	-31.3	40.94	40	.94	0-360	102	V
	48.4374	52.13	Qp	14.4	-31.3	35.23	40	-4.77	132	185	V
1	47.6055	48.15	Pk	14.8	-31.3	31.65	40	-8.35	0-360	399	H
5	81.604	51.76	Pk	13.4	-30.9	34.26	40	-5.74	0-360	102	V
	81.851	44.68	Qp	13.4	-30.9	27.18	40	-12.82	23	109	V
2	85.581	52.14	Pk	13.4	-30.9	34.64	40	-5.36	0-360	299	H
	85.6286	49.49	Qp	13.4	-30.9	31.99	40	-8.01	197	248	H
6	156.003	43.01	Pk	18.3	-30.5	30.81	43.52	-12.71	0-360	198	V
3	161.338	44.27	Pk	18.2	-30.5	31.97	43.52	-11.55	0-360	199	H

Pk - Peak detector  
 Qp - Quasi-Peak detector

### 10.4. WORST CASE 18-26 GHZ

#### SPURIOUS EMISSIONS 18-26 GHZ (WORST-CASE CONFIGURATION)

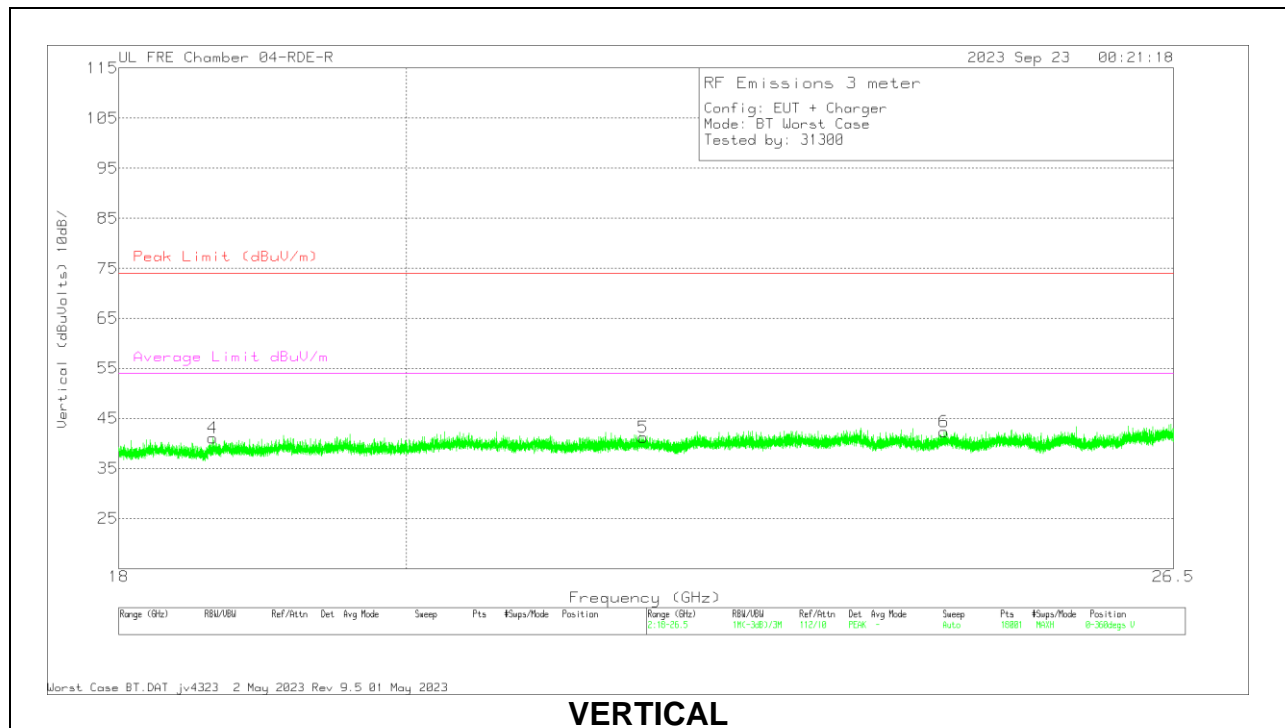
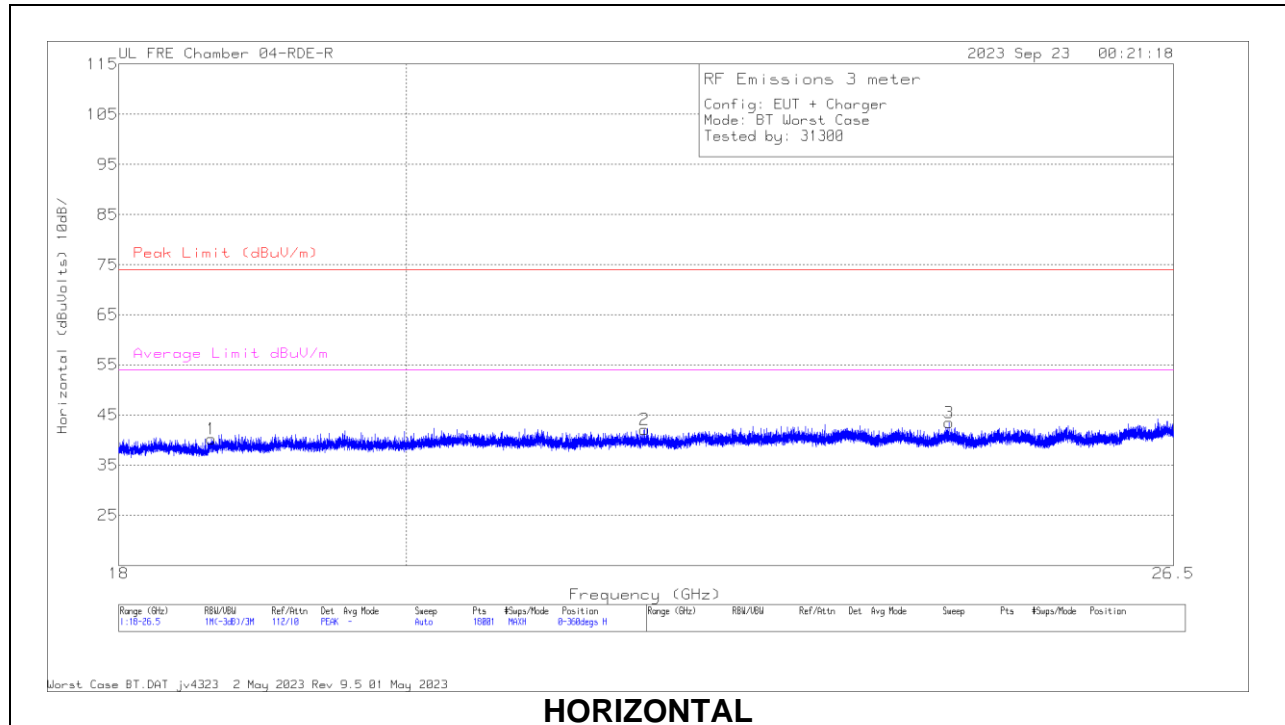

**18 – 26GHz Data**

Marker	Frequency (GHz)	Meter Reading (dBuV)	Det	172363 ACF 3m (dB/m)	171580 Amp (dB)	Cables (dB)	Corrected Reading (dBuVolts)	Peak Limit (dBuV/m)	PK Margin (dB)	Average Limit dBuV/m	Margin (dB)	Azimuth (Degs)	Height (cm)	Polarity
1	* 18.62333	56.5	Pk	32.2	-63.7	15.2	40.2	74	-33.8	-	-	0-360	100	H
4	* 18.62994	57.45	Pk	32.2	-63.7	15.2	41.15	74	-32.85	-	-	0-360	99	V
5	21.818859	54.99	Pk	32.9	-63.3	16.6	41.19	74	-32.81	-	-	0-360	99	V
2	21.824998	55.95	Pk	32.9	-63.3	16.6	42.15	74	-31.85	-	-	0-360	100	H
6	24.361303	54.12	Pk	33.5	-62.8	17.5	42.32	74	-31.68	-	-	0-360	99	V
3	24.406164	55.23	Pk	33.5	-62.8	17.5	43.43	74	-30.57	-	-	0-360	100	H

\* - indicates frequency in CFR47 Pt 15 / IC RSS-Restricted Band  
 Pk - Peak detector

## 11. AC POWER LINE CONDUCTED EMISSIONS

### LIMITS

FCC §15.207 (a)

Frequency of Emission (MHz)	Conducted Limit (dBuV)	
	Quasi-peak	Average
0.15-0.5	66 to 56 *	56 to 46 *
0.5-5	56	46
5-30	60	50

\* Decreases with the logarithm of the frequency.

### TEST PROCEDURE

The EUT is placed on a non-conducting table 40 cm from the vertical ground plane and 80 cm above the horizontal ground plane. The EUT is configured in accordance with ANSI C63.10.

The receiver is set to a resolution bandwidth of 9 kHz. Peak detection is used unless otherwise noted as quasi-peak or average.

Line conducted data is recorded for both NEUTRAL and HOT lines.

### RESULTS

### LINE 1 RESULTS

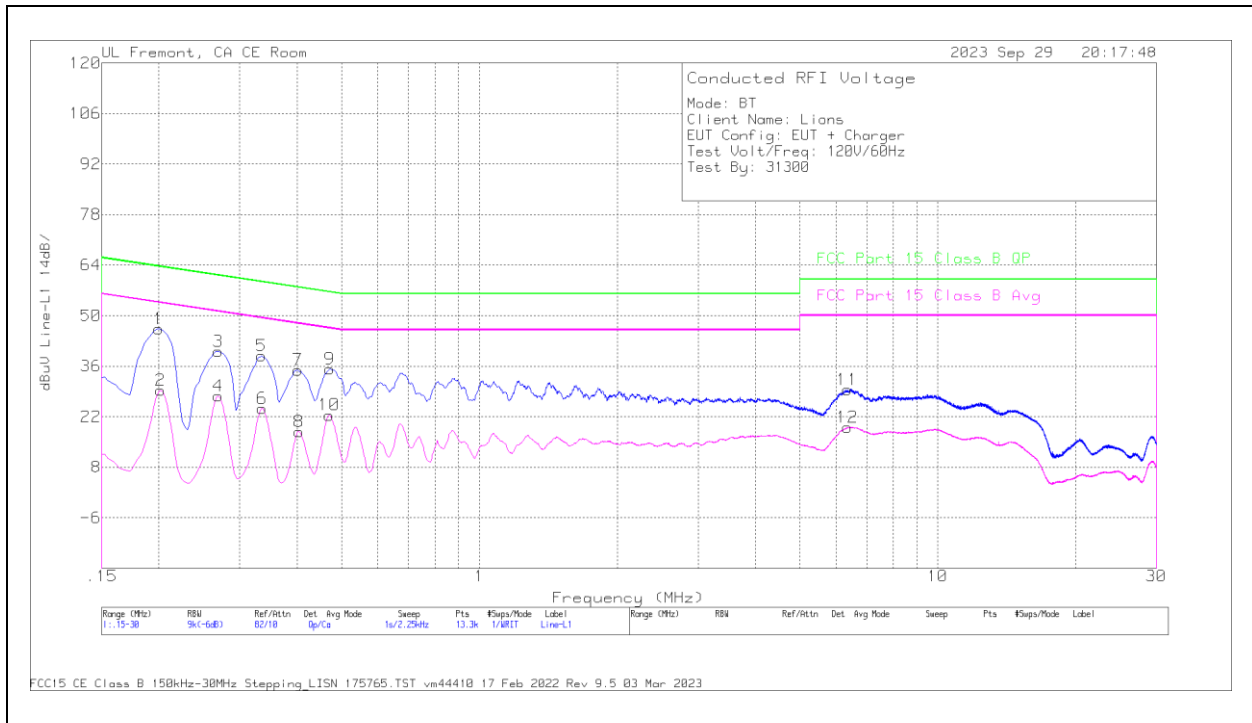

### DATA

Range 1: Line-L1 .15 - 30MHz											
Marker	Frequency (MHz)	Meter Reading (dBuV)	Det	LISN (dB)	Cbl (dB)	Trns Limiter (dB)	Corrected Reading dBuV	FCC Part 15 Class B QP (dBuV)	QP Margin (dB)	FCC Part 15 Class B Avg (dBuV)	Av(CISPR)Margin (dB)
2	.1568	18.54	Ca	0	0	9.5	28.04	-	-	55.63	-27.59
4	.3075	12.67	Ca	0	.1	9.4	22.17	-	-	50.04	-27.87
6	.3818	9.09	Ca	0	0	9.4	18.49	-	-	48.24	-29.75
8	.546	7.81	Ca	0	.1	9.3	17.21	-	-	46	-28.79
10	13.56	32.84	Ca	.1	.3	9.5	42.74	-	-	50	-7.26
12	27.1208	.85	Ca	.3	.3	9.4	10.85	-	-	50	-39.15
1	.1523	34.22	Qp	0	0	9.5	43.72	65.88	-22.16	-	-
3	.3075	26.82	Qp	0	.1	9.4	36.32	60.04	-23.72	-	-
5	.3773	25.18	Qp	0	0	9.4	34.58	58.34	-23.76	-	-
7	.5505	24.92	Qp	0	.1	9.3	34.32	56	-21.68	-	-
9	13.56	37.82	Qp	.1	.3	9.5	47.72	60	-12.28	-	-
11	27.1208	6.84	Qp	.3	.3	9.4	16.84	60	-43.16	-	-

Qp - Quasi-Peak detector  
 Ca - CISPR average detection

### LINE 2 RESULTS

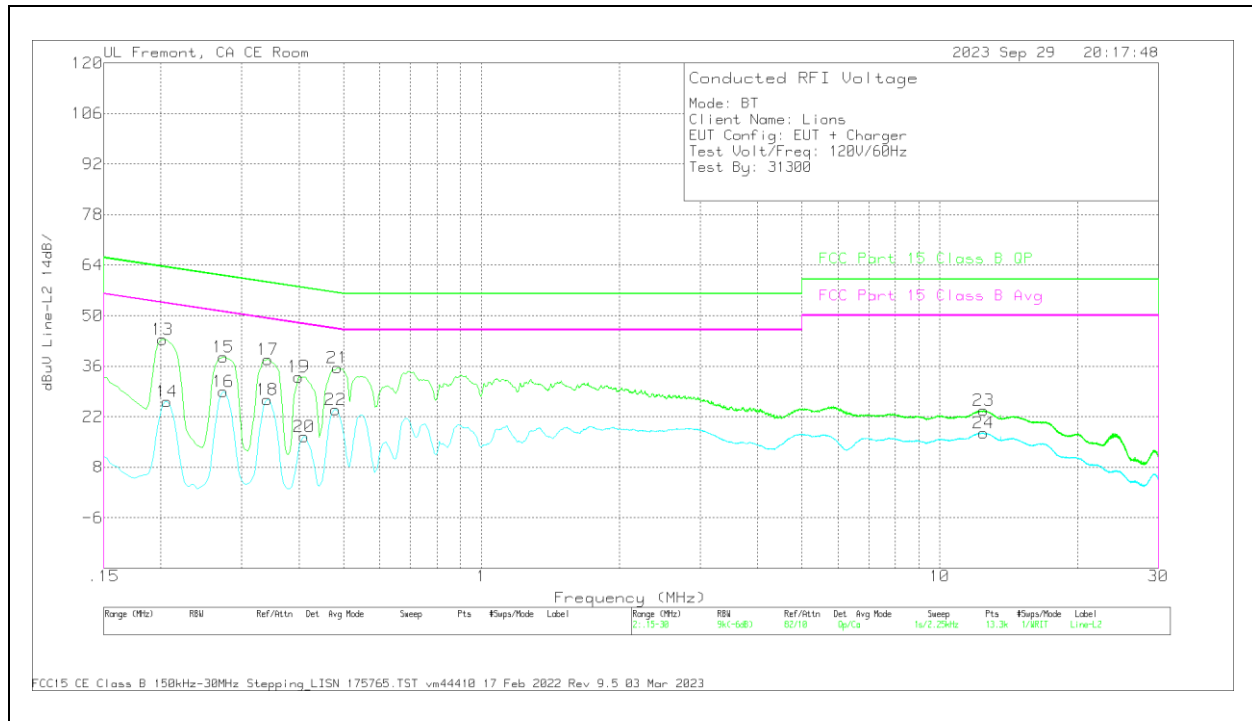

### DATA

Range 2: Line-L2 .15 - 30MHz											
Marker	Frequency (MHz)	Meter Reading (dBuV)	Det	LISN (dB)	Cbl (dB)	Trns Limiter (dB)	Corrected Reading dBuV	FCC Part 15 Class B QP (dBuV)	QP Margin (dB)	FCC Part 15 Class B Avg (dBuV)	Av(CISPR)Margin (dB)
14	.1568	21.87	Ca	0	0	9.5	31.37	-	-	55.63	-24.26
16	.3075	16.83	Ca	0	.1	9.4	26.33	-	-	50.04	-23.71
18	.3818	14.68	Ca	0	.1	9.4	24.18	-	-	48.24	-24.06
20	.5438	12.06	Ca	0	0	9.3	21.36	-	-	46	-24.64
22	13.56	33.1	Ca	.1	.2	9.5	42.9	-	-	50	-7.1
24	27.1208	-2.46	Ca	.3	.3	9.4	7.54	-	-	50	-42.46
13	.1523	33.89	Qp	0	0	9.5	43.39	65.88	-22.49	-	-
15	.321	27.49	Qp	0	.1	9.4	36.99	59.68	-22.69	-	-
17	.402	26.27	Qp	0	.1	9.4	35.77	57.81	-22.04	-	-
19	.564	26.77	Qp	0	0	9.3	36.07	56	-19.93	-	-
21	13.56	35.69	Qp	.1	.2	9.5	45.49	60	-14.51	-	-
23	27.1208	5.06	Qp	.3	.3	9.4	15.06	60	-44.94	-	-

Qp - Quasi-Peak detector  
 Ca - CISPR average detection

## 12. SETUP PHOTOS

Please refer to 14938215 – E11V1 for setup photos.

**END OF TEST REPORT**