



FCC 47 CFR § 2.1093

**RF EXPOSURE EVALUATION REPORT
(Part 2: Test Under Dynamic Transmission Condition)**

FOR

GSM/WCDMA/LTE/5G NR Phone + BT/BLE, DTS/UNII a/b/g/n/ac, and NFC

MODEL NUMBER: SM-A236U, SM-A236U1/DS, SM-S236DL

FCC ID: A3LSMA236U

REPORT NUMBER: 4790379967-S1V3

ISSUE DATE: 12/21/2022

Prepared for
**SAMSUNG ELECTRONICS CO., LTD.
129 SAMSUNG-RO, YEONGTONG-GU, SUWON-SI,
GYEONGGI-DO, 16677, KOREA**

Prepared by
**UL Korea, Ltd.
26th floor, 152, Teheran-ro, Gangnam-gu Seoul, 06236, Korea**

**Suwon Test Site: UL Korea, Ltd. Suwon Laboratory
218 Maeyeong-ro, Yeongtong-gu,
Suwon-si, Gyeonggi-do, 16675, Korea
TEL: (031) 337-9902
FAX: (031) 213-5433**



Testing Laboratory

TL-637

Revision History

Rev.	Date	Revisions	Revised By
V1	6/29/2022	Initial Issue	--
V2	7/5/2022	Revised NR Band n48-SRS2's Plimit in Table 5-1 of Sec.4.1.	Sunghoon Kim
V3	12/21/2022	Revised section 4.1 SAR characterization table based on updates to part 0 SAR report for 10g SAR DSI=0 target power values.	Jeongyeon Won

Table of Contents

Attestation of Test Results	5
1. Introduction	6
2. Tx Varying Transmission Test Cases and Test Proposal	7
3. SAR Time Averaging Validation Test Procedures	9
3.1. <i>Test sequence determination for validation</i>	9
3.2. <i>Test configuration selection criteria for validation Smart Transmit feature</i>	9
3.2.1 <i>Test configuration selection for time-varying Tx power transmission</i>	9
3.2.2 <i>Test configuration selection for change in call</i>	10
3.2.3 <i>Test configuration selection for change in technology/band</i>	10
3.2.4 <i>Test configuration selection for change in antenna</i>	10
3.2.5 <i>Test configuration selection for change in DSI</i>	11
3.2.6 <i>Test configuration selection for change in time window</i>	11
3.2.7 <i>Test configuration selection for SAR exposure switching</i>	11
3.3. <i>Test procedures for conducted power measurements</i>	12
3.3.1 <i>Time-varying Tx power transmission scenario</i>	12
3.3.2 <i>Change in call scenario</i>	14
3.3.3 <i>Change in technology and band</i>	14
3.3.4 <i>Change in antenna</i>	15
3.3.5 <i>Change in DSI</i>	16
3.3.6 <i>Change in time window</i>	16
3.3.7 <i>SAR exposure switching</i>	18
3.4. <i>Test procedures for time-varying SAR measurements</i>	19
4. Test Configurations	20
4.1. <i>WWAN (sub-6) transmission</i>	20
5. Conducted Power Test Results for Sub-6 Smart Transmit Feature Validation	23
5.1. <i>Measurement setup</i>	23
5.2. <i>P_{limit} and P_{max} measurement results</i>	26
5.3. <i>Time-varying Tx power measurement results (test case 1 - 7 in Table 5-2)</i>	27
5.3.1 <i>GSM 1900</i>	28
5.3.2 <i>WCDMA Band II</i>	30
5.3.3 <i>WCDMA Band IV</i>	32
5.3.4 <i>LTE Band 25</i>	34
5.3.5 <i>LTE Band 48</i>	36
5.3.6 <i>NR Band n70</i>	38

5.3.7 NR Band n77..... 40

5.4 Change in Call Test Results (test case 8 in Table 5-2)..... 42

5.5 Change in technology/band test results (test case 9 in Table 5-2) 44

5.6 Change in Time Window/Antenna test results (test case 10 in Table 5-2)..... 46

5.7 Change in DSI test results (test case 11 in Table 5-2) 50

5.8 Switch in SAR exposure test results (test case 12 in Table 5-2) 52

6 SAR Test Results for Sub-6 Smart Transmit Feature Validation..... 54

6.1 Dielectric Property Measurements & System Check 54

6.1.1 Dielectric Property Measurements..... 54

6.1.2 SAR system check 55

6.2 Measurement setup 55

6.3 SAR measurement results for time-varying Tx power transmission scenario 56

6.3.1 GSM 1900..... 57

6.3.2 WCDMA Band II..... 58

6.3.3 WCDMA Band IV..... 59

6.3.4 LTE Band 25 60

6.3.5 LTE Band 48 61

6.3.6 NR Band n70..... 62

6.3.7 NR Band n77..... 63

7 Test Equipment 64

8 Measurement Uncertainty..... 65

8.1 SAR..... 65

9 Conclusions..... 65

Section A. Test Sequences 66

Section B. Test Procedures for sub6 NR + LTE Radio 68

Appendixes 70



4790379967-S1 FCC Report RF exposure_App A_Test setup photos 70

Attestation of Test Results

Applicant Name	SAMSUNG ELECTRONICS CO.,LTD.
FCC ID	A3LSMA236U
Model Number	SM- A236U, SM-A236U1/DS, SM-S236DL
Applicable Standards	FCC 47 CFR § 2.1093
Date Tested	6/20/2022 to 7/5/2022
Test Results	Pass

UL Korea, Ltd. tested the above equipment in accordance with the requirements set forth in the above standards. All indications of Pass/Fail in this report are opinions expressed by UL Korea, Ltd. based on interpretations and/or observations of test results. Measurement Uncertainties were not taken into account and are published for informational purposes only. The test results show that the equipment tested is capable of demonstrating compliance with the requirements as documented in this report.

Note: The results documented in this report apply only to the tested sample, under the conditions and modes of operation as described herein. This document may not be altered or revised in any way unless done so by UL Korea, Ltd. and all revisions are duly noted in the revisions section. Any alteration of this document not carried out by UL Korea, Ltd. will constitute fraud and shall nullify the document. This report must not be used by the client to claim product certification, approval, or endorsement by IAS, any agency of the Federal Government, or any agency of any government.

Approved & Released By: 	Prepared By: 
Justin Park Operations Leader UL Korea, Ltd. Suwon Laboratory	Sunghoon Kim Senior Laboratory Engineer UL Korea, Ltd. Suwon Laboratory

1. Introduction

The equipment under test (EUT) is SM-A236U (FCC ID : A3LSMA236U), it contains the Qualcomm modems supporting 2G/3G/4G technologies and 5G NR bands (Sub-6). these modems are enabled with Qualcomm Smart Transmit feature to control and manage transmitting power in real time and to ensure at all times the time-averaged RF exposure is in compliance with the FCC requirement.

DUT contains embedded file system (EFS) version 16 configured for the Second generation (GEN2).

EFS v16 Verification

Per Qualcomm's 80-w2112-5 document, embedded file system (EFS) version 16 products are required to be verified for Smart Tx generation for relevant MCC setting. It was confirmed that this DUT contains embedded file system (EFS) version 16 configured for Smart Tx Second generation (GEN2) with MCC settings for the US market.

EFS v16 Generation	MCC
GEN2	310

This purpose of the Part 2 report is to demonstrate the EUT complies with FCC RF exposure requirement under Tx varying transmission scenarios, thereby validity of Qualcomm Smart Transmit feature for FCC equipment authorization of A3LSMA236U.

The P_{limit} (For 2G/3G/4G and 5G NR Sub-6) used in this report is determined in Part 0 and Part 1 reports.

Refer to Compliance summary report for product description and terminology used in this report.

2. Tx Varying Transmission Test Cases and Test Proposal

To validate time averaging feature and demonstrate the compliance in Tx varying transmission conditions, the following transmission scenarios are covered in Part 2 test:

1. During a time-varying Tx power transmission: To prove that the Smart Transmit feature accounts for Tx power variations in time accurately.
2. During a call disconnected and re-establish scenario: To prove that the Smart Transmit feature accounts for history of past Tx power transmissions accurately.
3. During technology/band handover: To prove that the Smart Transmit feature functions correctly during transitions in technology/band.
4. During DSI (Device State Index) change: To prove that The Smart Transmit feature functions correctly during transition from one device state (DSI) to another.
5. During antenna (or beam) switch: To prove that the Smart Transmit feature functions correctly during transitions in antenna (Such as AsDiv scenario) or beams (different antenna array configurations).
6. During time window switch: To prove that the Smart Transmit feature correctly handles the transition from one time window to another specified by FCC, and maintains the normalized time-averaged RF exposure to be less than normalized FCC limit of 1.0 at all times.
7. SAR exposure switching between two active radios (radio1 and radio2): To prove that the Smart Transmit feature functions correctly and ensures total RF exposure compliance when exposure varies among SAR_radio1 only, SAR_radio1 + SAR_radio2, and SAR_radio2 only scenarios.

As described in Part 0 report, the RF exposure is proportional to the Tx power for a SAR-characterized wireless device. Thus, feature validation in Part 2 can be effectively performed through conducted (for $f < 6\text{GHz}$) power measurement.

Therefore, the compliance demonstration under dynamic transmission conditions and feature validation are done in conducted/radiated power measurement setup for transmission scenario 1 through 7.

To add confidence in the feature validation, the time-averaged SAR measurements are also performed but only performed for transmission scenario 1 to avoid the complexity in SAR measurement (such as, for scenario 3 requiring change in SAR probe calibration file to accommodate different bands and/or tissue simulating liquid).

The strategy for testing in Tx varying transmission condition is outlined as follows:

- Demonstrate the total RF exposure averaged over FCC defined time windows does not exceed FCC's SAR limits, through time-averaged power measurements.
 - Measure conducted Tx power (for $< 6\text{GHz}$) versus time.
 - Convert it into RF exposure and divide by respective FCC limits to get normalized exposure versus time.
 - Perform running time-averaging over FCC defined time windows.
 - Demonstrate that the total normalized time-averaged RF exposure is less than 1 for all transmission scenarios (i.e., transmission scenarios 1, 2, 3, 4, 5, 6, and 7) at all times.

Mathematical expression:

- For sub-6 transmission only:

$$1g_or_10gSAR(t) = \frac{conducted_Tx_power(t)}{conducted_Tx_power_P_{limit}} * 1g_or_10gSAR_P_{limit} \quad (1a)$$

$$\frac{\frac{1}{T_{SAR}} \int_{t-T_{SAR}}^t 1g_or_10gSAR(t) dt}{FCC\ SAR\ limit} \leq 1 \quad (1b)$$

Where, $conducted_Tx_power(t)$, $conducted_Tx_power_P_{limit}$, and $1g_or_10gSAR_P_{limit}$ correspond to the measured instantaneous conducted Tx power, measured conducted Tx power at P_{limit} , and measured $1gSAR$ or $10gSAR$ values at P_{limit} corresponding to sub-6 transmission. P_{limit} are the parameters pre-defined in Part 0 and loaded via Embedded File System (EFS) onto the EUT, T_{SAR} is the FCC defined time window for sub-6 radio

- Demonstrate the total RF exposure averaged over FCC defined time windows does not exceed FCC's SAR limits, through time-averaged SAR measurements. Note as mentioned earlier, this measurement is performed for transmission scenario 1 only.
 - For sub-6 transmission only, measure instantaneous SAR versus time; for LTE+sub6 NR transmission, request low power (or all-down bits) on LTE so that measured SAR predominantly corresponds to sub6 NR.
 - Convert it into RF exposure and divide by respective FCC limits to obtain normalized exposure versus time.
 - Perform time averaging over FCC defined time window.
 - Demonstrate that the total normalized time-averaged RF exposure is less than 1 for transmission scenario 1 at all times.

Mathematical expression:

- For sub-6 transmission only:

$$1g_or_10gSAR(t) = \frac{pointSAR(t)}{pointSAR_P_{limit}} * 1g_or_10gSAR_P_{limit} \quad (3a)$$

$$\frac{\frac{1}{T_{SAR}} \int_{t-T_{SAR}}^t 1g_or_10gSAR(t) dt}{FCC\ SAR\ limit} \leq 1 \quad (3b)$$

Where, $pointSAR(t)$, $pointSAR_P_{limit}$, and $1g_or_10gSAR_P_{limit}$ correspond to the measured instantaneous point SAR, measured point SAR at P_{limit} and measured $1gSAR$ or $10gSAR$ values at P_{limit} corresponding to sub-6 transmission.

3. SAR Time Averaging Validation Test Procedures

This chapter provides the test plan and test procedures for validating Qualcomm Smart Transmit feature for sub-6 transmission. The 100 seconds time window for operating $f < 3\text{GHz}$ is used as an example to detail the test procedures in this chapter. The same test plan and test procedures described in this chapter apply to 60 seconds time window for operating $f \geq 3\text{GHz}$.

3.1. Test sequence determination for validation

Following the FCC recommendation, two test sequences having time-variation in Tx power are predefined for sub-6 ($f < 6\text{GHz}$) validation:

- Test sequence 1 : request EUT's Tx power to be at maximum power, measured P_{max} , for 80s, then requesting for half of the maximum power, i.e., measured $P_{max}/2$, for the rest of the time.
- Test sequence 2 : request EUT's Tx power to vary with time. This sequence is generated relative to measured P_{max} , measured P_{limit} and Calculated $P_{reserve}$ (= measured P_{limit} in dBm – Reserve_power_margin in dB) of EUT based on measured P_{limit} .

The details for generating these two test sequences is described and listed in Section A.

Note: For test sequence generation, “measured P_{limit} ” and “measured P_{max} ” are used instead of the “ P_{limit} ” specified in EFS entry and “ P_{max} ” specified for the device, because Smart Transmit feature operates against the actual power level of the “ P_{limit} ” that was calibrated for the EUT. The “measured P_{limit} ” accurately reflects what the feature is referencing to, therefore, it should be used during feature validation testing. The RF tune up and device-to-device variation are already considered in Part 0 report prior to determining P_{limit} .

3.2. Test configuration selection criteria for validation Smart Transmit feature

For validating Smart Transmit feature, this section provides a general guidance to select test cases. In practice, an adjustment can be made in test case selection. The justification/clarification may be provide.

3.2.1 Test configuration selection for time-varying Tx power transmission

The Smart Transmit time averaging feature operation is independent of bands, modes, and channels for a given technology. Hence, validation of Smart Transmit on one band/mode/channel per technology is sufficient. Two bands per technology are proposed and selected for this testing to provide high confidence in this validation.

The criteria for the selection are based on the P_{limit} values determined in Part 0 report. Select two bands* in each supported technology that correspond to least** and highest*** P_{limit} values that are less than P_{max} for validating Smart Transmit.

- * If one P_{limit} level applies to all the bands within a technology, then only one band needs to be tested. In this case, within the bands having the same P_{limit} , the radio configuration (e.g., # of RBs, channel#) and device position that correspond to the highest measured 1gSAR at P_{limit} shown in Part 1 report is selected.
- ** In case of multiple bands having the same least P_{limit} within the technology, then select the band having the highest measured 1gSAR at P_{limit} .

- *** The band having a higher P_{limit} needs to be properly selected so that the power limiting enforced by Smart Transmit can be validated using the pre-defined test sequences. If the highest P_{limit} in a technology is too high where the power limiting enforcement is not needed when testing with the pre-defined test sequences, then the next highest level is checked. This process is continued within the technology until second band for validation test is determined.

3.2.2 Test configuration selection for change in call

The criteria to select a test configuration for call-drop measurement is:

- Select technology/band with least P_{limit} among all supported technologies/bands, and select the radio configuration (e.g., # of RBs, channel#) in this technology/band that corresponds to the highest *measured 1gSAR* at P_{limit} listed in Part 1 report.
- In case of multiple bands having same least P_{limit} , then select the band having the highest *measured 1gSAR* at P_{limit} in Part 1 report.

This test is performed with the EUT's Tx power requested to be at maximum power, the above band selection will result in Tx power enforcement (i.e., during the time when EUT is forced to have Tx power at $P_{reserve}$) for longest duration in one FCC defined window. The call change (call drop/reestablish) is performed during the Tx power enforcement duration (i.e., during the time when EUT is forced to have Tx power at $P_{reserve}$). One test is sufficient as the feature operation is independent of technology and band.

3.2.3 Test configuration selection for change in technology/band

The selection criteria for this measurement is, for a given antenna, to have EUT switch from a technology/band with lowest P_{limit} within the technology group (in case of multiple bands having the same P_{limit} , then select the band with highest *measured 1gSAR* at P_{limit}) to a technology/band with highest P_{limit} within the technology group, in case of multiple bands having the same P_{limit} , then select the band with lowest *measured 1gSAR* at P_{limit} in Part 1 report, or vice versa.

This test is performed with the EUT's Tx power requested to be at maximum power, the technology/band switch is performed during Tx power enforcement duration (i.e., during the time when EUT is forced to have Tx power at $P_{reserve}$).

3.2.4 Test configuration selection for change in antenna

The criteria to select a test configuration for antenna switch measurement is:

- Whenever possible and supported by the EUT, first antenna switch configuration within the same technology/band (i.e., same technology and band combination).
- Then, select any technology/band that supports multiple Tx antennas, and has the highest difference in P_{limit} among all supported antennas.
- In case of multiple bands having same difference in P_{limit} among supported antennas, then select the band having the highest *measured 1gSAR* at P_{limit} in Part 1 report.

This test is performed with the EUT's Tx power requested to be at maximum power in selected technology/band, and antenna change is conducted during Tx power enforcement duration (i.e., during the time when EUT is forced to have Tx power at $P_{reserve}$).

3.2.5 Test configuration selection for change in DSI

The criteria to select a test configuration for DSI change test is:

- Select a technology/band having the $P_{limit} < P_{max}$ within any technology and DSI group, and for same technology/band having a different P_{limit} in any other DSI group. Note that the selected DSI transition need to be supported by the device.

This test is performed with the EUT's Tx power requested to be at maximum power in selected technology/band, and DSI change is conducted during Tx power enforcement duration (i.e., during the time when EUT is forced to have Tx power at $P_{reserve}$).

3.2.6 Test configuration selection for change in time window

FCC specifies different time window for time averaging based on operation frequency. The criteria to select a test configuration for validating Smart Transmit feature and demonstrating the compliance during the change in time window is:

- Select any technology/band that has operation frequency classified in a different time window defined by FCC (such as 100-seconds time window), and its corresponding P_{limit} is less than P_{max} if possible.
- Select the 2nd technology/band that has operation frequency classified in a different time window defined by FCC (such as 60-seconds time window), and its corresponding P_{limit} is less than P_{max} if possible.
- Note it is preferred both P_{limit} values of two selected technology/band less than corresponding P_{max} , but if not possible, at least one of technologies/bands has its P_{limit} less than P_{max} .

This test is performed with the EUT's Tx power requested to be at maximum power in selected technology/band. Test for one pair of time windows selected is sufficient as the feature operation is the same.

3.2.7 Test configuration selection for SAR exposure switching

If supported, the test configuration for SAR exposure switching should cover:

1. SAR exposure switch when two active radios are in the same time window
2. SAR exposure switch when two active radios are in different time windows. One test with two active radios in any two different time windows is sufficient as Smart Transmit operation is the same for RF exposure switch in any combination of two different time windows.

The Smart Transmit time averaging operation is independent of the source of SAR exposure (for example, LTE vs. Sub6 NR) and ensures total time-averaged RF exposure compliance. Hence, validation of Smart Transmit in any one simultaneous SAR transmission scenario (i.e., one combination for LTE + Sub6 NR transmission) is sufficient, where the SAR exposure varies among SAR_{radio1} only, $SAR_{radio1} + SAR_{radio2}$, and SAR_{radio2} only scenarios.

The criteria to select a test configuration for validating Smart Transmit feature during SAR exposure switching scenarios is:

- Select any two < 6GHz technologies/bands that the EUT supports simultaneous transmission (for example, LTE + Sub NR)
- Among all supported simultaneous transmission configurations, the selection order is
 1. Select one configuration where both P_{limit} of radio1 and radio2 is less than their corresponding P_{max} , preferably, with different P_{limits} . If this configuration is not available, then,
 2. Select one configuration that has P_{limit} less than its P_{max} for at least one radio. If this cannot be found, then.
 3. Select one configuration that has P_{limit} of radio1 and radio2 greater than P_{max} but with least $(P_{limit} - P_{max})$ delta.

Test for one simultaneous transmission scenario is sufficient as the feature operation is the same.

3.3. Test procedures for conducted power measurements

This section provides general conducted power measurement procedures to perform compliance test under dynamic transmission scenarios described in Section 2. In practice, an adjustment can be made in these procedures. The justification/clarification may be provide.

3.3.1 Time-varying Tx power transmission scenario

This test is performed with the two pre-defined test sequences described in Section 3.1 for all the technologies and bands selected in Section 3.2.1. The purpose of the test is to demonstrate the effectiveness of power limiting enforcement and that the time-averaged SAR (corresponding time averaged Tx power) does not exceed the FCC limit at all times (see Eq. (1a) and (1b)).

Test procedure:

1. Measure P_{max} , measure P_{limit} and calculate $Reserve_power_margin$ (= measured P_{limit} in dBm – $Reserve_power_margin$ in dB) and follow Section 3.1 to generate the test sequences for all the technologies and bands selected in Section 3.2.1. Both test sequence 1 and test sequency 2 are created based on measured P_{max} and measured P_{limit} of the EUT. Test condition to measure P_{max} and P_{limit} is:
 - Measure P_{max} with Smart Transmit disable and callbox set to request maximum power.
 - Measure P_{limit} with Smart Transmit enable and $Reserve_power_margin$ set to 0 dB; callbox set to request maximum power.

2. Set *Rerve_power_margin* to actual (intended) value (3dB for this EUT based on Part 1 report) and reset power on EUT to enable Smart Transmit, establish radio link in desired radio configuration, with callbox requesting the EUT’s Tx power to be at pre-defined test sequence 1, measure and record Tx power versus time, and then convert the conducted Tx power into 1gSAR or 10gSAR value (see Eq. (1a)) using measured P_{limit} from above Step 1. Perform running time average to determine time-averaged power and 1gSAR or 10gSAR versus time as illustrated in Figure A-1 where using 100-secnods time window as an example.

Note: In Eq.(1a), instantaneous Tx power is converted into instantaneous 1gSAR or 10gSAR value by applying the measured worst-case 1gSAR or 10gSAR value at P_{limit} for the corresponding technology/band/antenna/DSI reported in Part 1 report.

Note: For an easier computation of the running time average, 0 dBm can be added at the beginning of the test sequences the length of the responding time window, for example, add 0 dBm for 100-seconds so the running time average can be directly performed starting with the first 100-seconds data using excel spreadsheet. This technique applies to all tests performed in this Part 2 report for easier time-averaged computation using excel spreadsheet.

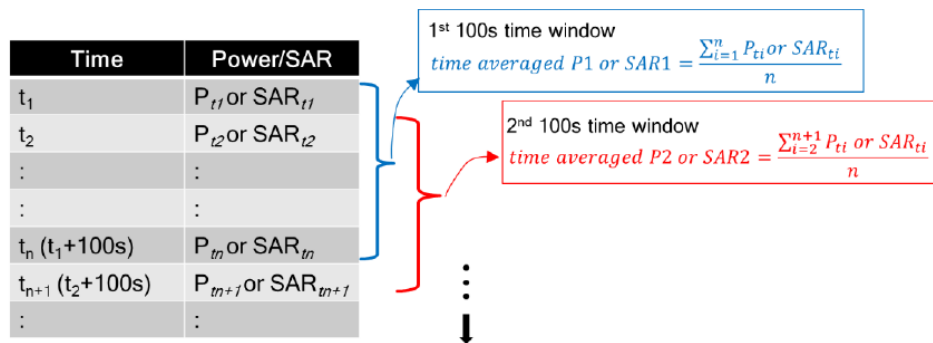

Figure A-1 100s running average illustration

3. Make one plot containing:
 - a. Instantaneous Tx power versus time measured in Step 2,
 - b. Requested Tx power used in Step 2 (Test sequence 1),
 - c. Computed time-averaged power versus time determined in Step 2,
 - d. Time-averaged power limit (corresponding to FCC SAR limit of 1.6 W/kg for 1gSAR or 4.0W/kg for 10gSAR) given by:

$$Time\ avearged\ power\ limit = meas.P_{limit} + 10 \times \log\left(\frac{FCC\ SAR\ limit}{meas.SAR_P_{limit}}\right) \quad (5a)$$

Where $meas.P_{limit}$ and $meas.SAR_P_{limit}$ correspond to measured power at P_{limit} and measured SAR at P_{limit} .

4. Make another plot containing:
 - a. Computed time-averaged 1gSAR or 10gSAR versus time determined in Step 2
 - b. FCC $1gSAR_{limit}$ of 1.6W/kg or $10gSAR_{limit}$ of 4.0W/kg.
5. Repeated Steps 2 ~ 4 for pre-defined test sequence 2 and replace the requested Tx power (test sequence 1) in Step 2 with test sequence 2.
6. Repeat Steps 2 ~ 5 for all the selected technologies and bands. The validation criteria are, at all times, the time-averaged power versus time shown in Step 3 plot shall not exceed the time-averaged power limit (defined in Eq. (5a)), in turn, the time-averaged 1gSAR or 10gSAR versus time shown in Step 4 plot shall not exceed the FCC limit of 1.6 W/kg for 1gSAR or 4.0W/kg for 10gSAR (i.e., Eq. (1b)).

3.3.2 Change in call scenario

This test is to demonstrate that Smart Transmit feature accurately accounts for the past Tx powers during time-averaging when a new call is established.

The call disconnects and re-establishment needs to be performed during power limit enforcement, i.e., when the EUT's Tx power is at $P_{reserve}$ level, to demonstrate the continuity of RF exposure management and limiting in call change scenario. In other words, the RF exposure averaged over any FCC defined time window (including the time windows containing the call change) doesn't exceed FCC limit of 1.6 W/kg for 1gSAR or 4.0W/kg for 10gSAR.

Test procedure:

1. Measure P_{limit} for the technology/band selected in Section 3.2.2. measure P_{limit} with Smart Transmit enable and *Reserve_power_margin* set to 0 dB; callbox set to request maximum power.
2. Set *Reserve_power_margin* to actual (intended) value and reset power on EUT to enable Smart Transmit.
3. Establish radio link with callbox in the selected technology/band.
4. Request EUT's Tx power at 0 dBm for at least one time window specified for the selected technology/band, followed by requesting EUT's Tx power to be at maximum power for about ~60 seconds, and then drop the call for ~10 seconds. Afterwards, re-establish another call in the same radio configuration (i.e., same technology/band/channel) and continue callbox requesting EUT's Tx power to be at maximum power for the remaining time of at least another full duration of the specified time window. Measure and record Tx power versus time, Once the measurement is done, extract instantaneous Tx power versus time, convert the measured conducted Tx power into 1gSAR or 10gSAR value using Eq.(1a), and then perform the running time average to determine time-averaged power and 1gSAR or 10gSAR versus time.
Note: In Eq.(1a), instantaneous Tx power is converted into instantaneous 1gSAR or 10gSAR value by applying the measured worst-case 1gSAR or 10gSAR value at P_{limit} for the corresponding technology/band/antenna/DSI reported in Part 1 report.
5. Make one plot containing: (a) instantaneous Tx power versus time, (b) requested power, (c) computed time-averaged power, (d) time-averaged power limit calculated using Eq.(5a).
6. Make another plot containing: (a) computed time-averaged 1gSAR or 10gSAR versus time, and (b) FCC limit of 1.6 W/kg for 1gSAR or 4.0 W/kg for 10gSAR.

The validation criteria are, at all times, the time-averaged power versus time shall not exceed the time-averaged power limit (defined in Eq.(5a)), in turn, the time-averaged 1gSAR or 10gSAR versus time shall not exceed the FCC limit of 1.6W/kg for 1gSAR or 4.0W/kg for 10gSAR (i.e., Eq.(1b)).

3.3.3 Change in technology and band

This test is to demonstrate the correct power control by Smart Transmit during technology and/or band handovers.

Similar to the change in call test in Section 3.3.2, to validate the continuity of RF exposure limiting during the transition, the technology and band handover needs to be performed when EUT's Tx power is at $P_{reserve}$ level (i.e., during Tx power enforcement) to make sure that the EUT's Tx power from previous $P_{reserve}$ level to the new $P_{reserve}$ level (corresponding to new technology/band). Since the P_{limit} could vary with technology and band, Eq.(1a) can be written as follows to convert the instantaneous Tx power in 1gSAR or 10gSAR exposure for the two given radios, respectively:

$$1g_or_10gSAR_1(t) = \frac{conducted_Tx_power_1(t)}{conducted_Tx_power_P_{limit_1}} * 1g_or_10gSAR_P_{limit_1} \quad (6a)$$

$$1g_or_10gSAR_2(t) = \frac{conducted_Tx_power_2(t)}{conducted_Tx_power_P_{limit_2}} * 1g_or_10gSAR_P_{limit_2} \quad (6b)$$

$$\frac{1}{T_{SAR}} \left[\int_{t-T_{SAR}}^{t_1} \frac{1g_or_10gSAR_1(t)}{FCC\ SAR\ limit} dt + \int_{t-T_{SAR}}^t \frac{1g_or_10gSAR_2(t)}{FCC\ SAR\ limit} dt \right] \leq 1 \quad (6c)$$

where, $conducted_Tx_power_1(t)$, $conducted_Tx_power_P_{limit_1}$, and $1g_or_10gSAR_P_{limit_1}$ correspond to the measured instantaneous conducted Tx power, measured conducted Tx power at P_{limit} , and measured $1g$ SAR or $10g$ SAR value at technology1/band1; $conducted_Tx_power_2(t)$, $conducted_Tx_power_P_{limit_2}$, and $1g_or_10gSAR_P_{limit_2}$ correspond to the measured instantaneous conducted Tx power, measured conducted Tx power at P_{limit} , and measured $1g$ SAR or $10g$ SAR value at P_{limit} of technology2/band2. Transition from technology1/band1 to the technology2/band2 happens at time-instant 't₁'.

Test procedure:

1. Measure P_{limit} for both the technologies and bands selected in Section 3.2.3. Measure P_{limit} with Smart Transmit enabled and *Reserve_power_margin* set to 0 dB; callbox set to request maximum power.
2. Set *Reserve_power_margin* to actual(intended) value and reset power on EUT to enable Smart Transmit.
3. Establish radio link with callbox in first technology/band selected.
4. Request EUT's Tx power at 0 dBm for at least one time window specified for the selected technology/band, followed by requesting EUT's Tx power to be at maximum power for about ~60 second, and then switch to second technology/band selected. Continue with callbox requesting EUT's Tx power to be at maximum power for the remaining time of least another full duration of the specified time window. Measure and record Tx power versus time for the full duration of the test.
5. Once the measurement is done, extract instantaneous Tx power versus time, and convert the conducted Tx power into $1g$ SAR or $10g$ SAR value using Eq.(6a) and (6b) and corresponding measured P_{limit} values from Step 1 of this section. Perform the running time average to determine time-averaged power and $1g$ SAR or $10g$ SAR versus time.
Note: In Eq.(6a) & (6b), instantaneous Tx power is converted into instantaneous $1g$ SAR or $10g$ SAR value by applying the measured the measured worst-case $1g$ SAR or $10g$ SAR value at P_{limit} for the corresponding technology/band/antenna/DSI reported in Part 1 report.
6. Make one plot containing: (a) instantaneous Tx power versus time, (b) requested power, (c) computed time-averaged power, (d) time-averaged power limit calculated using Eq.(5a).
7. Make another plot containing: (a) computed time-averaged $1g$ SAR or $10g$ SAR versus time, and (b) FCC limit of 1.6W/kg for $1g$ SAR or 4.0 W/kg for $10g$ SAR. (i.e., Eq.(6c)).

3.3.4 Change in antenna

This test is to demonstrate the correct power control by Smart Transmit during antenna switches from one antenna to another. The test procedure is identical to Section 3.3.3, by replacing technology/band switch operation with antenna switch. The validation criteria are, at all times, the time-average $1g$ SAR or $10g$ SAR versus time shall not exceed FCC limit of 1.6 W/kg for $1g$ SAR or 4.0 W/kg for $10g$ SAR.

Note: If the EUT does not support antenna switch within the same technology/band, but has multiple antennas to support different frequency bands, then the antenna switch test is included as part of change in technology and band (Section 3.3.3) test.

3.3.5 Change in DSI

This test is to demonstrate the correct power control by Smart Transmit during DSI switches from one DSI to another. The test procedure is identical to Section 3.3.3, by replacing technology/band switch operation with DSI switch. The validation criteria are, at all times, the time-averaged 1gSAR or 10gSAR versus time shall not exceed FCC limit of 1.6 W/kg for 1gSAR or 4.0W/kg for 10gSAR.

3.3.6 Change in time window

This test is to demonstrate the correct power control by Smart Transmit during the change in averaging time window when a specific band handover occurs. FCC specifies time-averaging window of 100s for Tx frequency < 3GHz, and 60s for Tx frequency between 3GHz and 6Ghz. To validate the continuity of RF exposure limiting during the transition, the band handover test needs to be performed when EUT handovers from operation band less than 3GHz to greater than 3GHz and vice versa. The equations (3a) and (3b) in Section 2 can be written as follows for transmission scenario having change in time window:

$$1gSAR_1(t) = \frac{\text{conducted_Tx_power_1}(t)}{\text{conducted_Tx_power_P}_{limit_1}} * 1g_or\ 10g_SAR_P_{limit_1} \quad (7a)$$

$$1gSAR_2(t) = \frac{\text{conducted_Tx_power_2}(t)}{\text{conducted_Tx_power_P}_{limit_2}} * 1g_or\ 10g_SAR_P_{limit_2} \quad (7b)$$

$$\frac{1}{T1_{SAR}} \left[\int_{t-T1_{SAR}}^{t_1} \frac{1g_or\ 10g_SAR_1(t)}{FCC\ SAR\ limit} dt \right] + \frac{1}{T2_{SAR}} \left[\int_{t-T2_{SAR}}^t \frac{1g_or\ 10g_SAR_2(t)}{FCC\ SAR\ limit} dt \right] \leq 1 \quad (7c)$$

Where, $\text{conducted_Tx_power_1}(t)$, $\text{conducted_Tx_power_P}_{limit_1}(t)$, and $1g_or\ 10g_SAR_P_{limit_1}$ correspond to the instantaneous Tx power, conducted Tx power at P_{limit}, and compliance $1g_or\ 10g_SAR$ values at P_{limit_1} of band1 with time-averaging window ' $T1_{SAR}$ '; $\text{conducted_Tx_power_2}(t)$, Conducted Tx power at P_{limit} , and compliance $1g_or\ 10g_SAR$ values at P_{limit_2} of Band2 with time-averaging window ' $T2_{SAR}$ '. One of the two bands is less than 3GHz, another is greater than 3GHz. Transition from first band with time-averaging window ' $T1_{SAR}$ ' to the second band with time-averaging window ' $T2_{SAR}$ ' happens at time-instant ' t_1 '.

Test procedure:

1. Measure P_{limit} for both the technologies and bands selected in Section 3.2.6 Measure P_{limit} with Smart Transmit enabled and *Reserve_power_margin* set to 0 dB, callbox set to request maximum power.
2. Set *Reserve_power_margin* to actual (intended) value and enable Smart Transmit.

Transition from 100s time window to 60s time window, and vice versa

3. Establish radio link with callbox in the technology/band having 100s time window selected in Section 3.2.6.
4. Request EUT's Tx power to be at 0 dBm for at least 100 seconds, followed by requesting EUT's Tx power to be at maximum power for about ~140 seconds, and then switch to second technology/band (having 60s time window) selected in Section 3.2.6. Continue with callbox requesting EUT's Tx power to be at maximum power for at least another 100s. Measure and record Tx power versus time for the entire duration of the test.

5. Once the measurement is done, extract instantaneous Tx power versus time, and convert the conducted Tx power into 1gSAR or 10gSAR value (see Eq.(7a) and (7b)) using corresponding technology/band Step 1 result, and then perform 100s average to determine time-averaged 1gSAR or 10gSAR versus time. Note that in Eq.(7a) & (7B), instantaneous Tx power is converted into instantaneous 1gSAR or 10gSAR value by applying the worst-case 1gSAR or 10gSAR value tested in Part 1 for the selected technologies/bands at P_{limit} .
6. Make one plot containing: (a) instantaneous Tx power versus time measured in Step 4.
7. Make another plot containing: (a) instantaneous 1gSAR versus time determined in Step 5, (b) computed time-averaged 1gSAR versus time determined in Step 5, and (c) corresponding regulatory $1gSAR_{limit}$ of 1.6W/kg or $10gSAR_{limit}$ of 4.0W/kg.

Transition from 60s time window to 100s time window, and vice versa

8. Establish radio link with callbox in the technology/band having 60s time window selected in Section 3.2.6.
9. Request EUT's Tx power to be at 0 dBm for at least 60 seconds, followed by requesting EUT's Tx power to be at maximum power for about ~80 seconds, and then switch to second technology/band (having 100s time window) selected in Section 3.2.6. Continue with callbox requesting EUT's Tx power to be at maximum power for the remaining time for a total test time of 500 seconds. Measure and record Tx power versus time for the entire duration of the test.
10. Repeat above Step 5~7 to generate the plots

The validation criteria is, at all times, the time-averaged 1gSAR or 10gSAR versus time shall not exceed the regulatory $1gSAR_{limit}$ of 1.6W/kg or $10gSAR_{limit}$ of 4.0W/kg.

3.3.7 SAR exposure switching

This test is to demonstrate that Smart Transmit feature is accurately accounts for switching in exposures among SAR from radio1 only, SAR from both radio1 and radio2, and SAR from radio2 only scenarios, and ensures total time-averaged RF exposure complies with the FCC limit. Here, radio1 represents primary radio (for example, sub6 NR). The detailed test procedure for SAR exposure switching in the case of LTE + Sub6 NR non-standalone mode transmission scenario is provided in Section B.2.

Test procedure:

1. Measure conducted Tx power corresponding to P_{limit} for radio 1 and radio 2 in selected band. Test condition to measure conducted P_{limit} is:
 - Establish device in call with the callbox for radio1 technology/band. Measure conducted Tx power corresponding to radio 1 P_{limit} with Smart Transmit enable and *Reserve_Power_margin* set to 0 dB, callbox set to request maximum power.
 - Repeat above step to measure conducted Tx power corresponding to radio2 P_{limit} . If radio2 is dependent on radio1 (for example, non-standalone mode of Sub6 NR requiring radio1 LTE as anchor), then establish radio1 + radio2 call with callbox, and request all down bits for radio1 LTE. In this scenario, with callbox requesting maximum power from radio2 Sub6 NR, measured conducted Tx power corresponds to radio2 P_{limit} (as radio1 LTE is at all-down bits)
2. Set *Reserve_power_margin* to actual (intended) value, with EUT setup for radio1 + radio2 call. In this description, it is assumed that radio2 has lower priority than radio1. Establish device in radio1 + radio2 call, and request all-down bits or low power on radio1, with callbox requesting EUT's Tx power to be at maximum power in radio2 for at least one time window. After one time window, set callbox to request EUT's Tx power to be at maximum power on radio1, i.e., all-up bits. Continue radio1 + radio2 call with both radios at maximum power for at least one time window, and drop (or request all-down bits on) radio2. Continue radio1 at maximum power for at least one time window. Record the conducted Tx power for both radio1 and radio2 for the entire duration of this test.
3. Once the measurement is done, extract instantaneous Tx power versus time for both radio1 and radio2 links. Convert the conducted Tx power for both these radios into 1gSAR or 10gSAR value (see Eq.(6a) and (6b)) using corresponding technology/band P_{limit} measured in Step 1, and then perform the running time average to determine time-averaged 1gSAR or 10gSAR versus time.
4. Make one plot containing: (a) instantaneous Tx power versus time measured in Step 2.
5. Make another plot containing: (a) instantaneous 1gSAR versus time determined in Step 3, (b) computed time-averaged 1gSAR versus time determined in Step 3, and (c) corresponding regulatory $1gSAR_{limit}$ or 1.6W/kg or $10gSAR_{limit}$ of 4.0W/kg.

The validation criteria is, at all times, the time-averaged 1gSAR or 10gSAR versus time shall not exceed the regulatory $1gSAR_{limit}$ or 1.6W/kg or $10gSAR_{limit}$ of 4.0W/kg.

3.4. Test procedures for time-varying SAR measurements

This section provides general time-varying SAR measurement procedures to perform compliance test under dynamic transmission scenarios described in Section 2. In practice, an adjustment can be made in these procedures. The justification/clarification may be provided.

To perform the validation through SAR measurement for transmission scenario 1 described in Section 2, the “path loss” between callbox antenna and EUT needs to be calibrated to ensure that the EUT Tx power reacts to the requested power from callbox in a radiated call. It should be noted that when signaling in closed loop mode, protocol-level power control is in play, resulting in EUT not solely following callbox TPC (Tx power control) commands. In other words, EUT response has many dependencies (RSSI, quality of signal, path loss variation, fading, etc.,) other than just TPC commands. These dependencies have less impact in conducted setup (as it is a controlled environment and the path loss can be very well calibrated) but have significant impact on radiated testing in an uncontrolled environment, such as SAR test setup. Therefore, the deviation in EUT Tx power from callbox requested power is expected, however the time-averaged SAR should not exceed FCC SAR requirement at all times as Smart Transmit controls Tx power at EUT.

The following steps are for time averaging feature validation through SAR measurement:

1. “Path Loss” calibration: Place the EUT against the phantom in the worst-case position determined based on Section 3.2.1. For each band selected, prior to SAR measurement, perform “path loss” calibration between callbox antenna and EUT. Since the SAR test environment is not controlled and well calibrated for OTA (Over the Air) test, extreme care needs to be taken to avoid the influence from reflections. The test setup is described in Section 7.1.
2. Time averaging feature validation:
 - i. For a given radio configuration (technology/band) selected in Section 3.2.1, enable Smart Transmit and set *Reserve_power_margin* to 0 dB, with callbox to request maximum power, perform area scan, conduct point SAR measurement at peak location of the area scan. This point SAR value, *pointSAR_{P_{limit}}*, corresponds to point SAR at the measured *P_{limit}* (i.e., measured *P_{limit}* from the EUT in Step 1 of Section 3.3.1).
 - ii. Set *Reserve_power_margin* to actual (intended) value and reset power on EUT to enable Smart Transmit. Note, if *Reserve_power_margin* cannot be set wirelessly, care must be taken to re-position the EUT in the exact same position relative to the SAM phantom as in above Step 2.i. Establish radio link in desired radio configuration, with callbox requesting the EUT’s Tx power at power levels described by test sequence 1 generated in Step 1 of Section 3.3.1, conducted point SAR measurement versus time at peak location is done, extract instantaneous point SAR vs time data, *pointSAR(t)*, and convert it into instantaneous 1gSAR or 10gSAR vs. time using Eq. (3a), re-written below:

$$1g_or_10gSAR(t) = \frac{pointSAR(t)}{pointSAR_{P_{limit}}} * 1g_or_10gSAR_{P_{limit}}$$

Where, *pointSAR_{P_{limit}}* is the value determined in Step 2.i, and *pointSAR(t)* is the instantaneous point SAR measured in Step 2.ii, *1g_or_10g_SAR_{P_{limit}}* is the measured 1gSAR or 10gSAR value listed in Part 1 report.

- iii. Perform 100s running average to determine time-averaged 1gSAR or 10gSAR versus time.
- iv. Make one plot containing: (a) time-average 1gSAR or 10gSAR versus time determined in Step 2.iii of this section, (b) FCC limit of 1.6 W/kg for 1gSAR or 4.0 W/kg for 10gSAR.
- v. Repeat 2.ii ~ 2.iv for test sequence 2 generated in Step 1 of Section 3.3.1.
- vi. Repeat 2.i ~ 2.v for all the technologies and bands selected in Section 3.2.1.

The time-averaging validation criteria for SAR measurement is that, at all times, the time-averaged 1gSAR or 10gSAR versus time shall not exceed FCC limit of 1.6 W/kg for 1gSAR or 4.0 W/kg for 10gSAR (i.e., Eq.(3b)).

4. Test Configurations

4.1. WWAN (sub-6) transmission

This P_{limit} values, corresponding to 1.0 W/kg (1gSAR) of SAR_{design_target} , for technologies and bands supported by EUT are derived in Part 0 report and summarized in Table 5-1. Note all P_{limit} power levels entered in Table 5-1 correspond to average power levels plus tolerance after accounting for duty cycle in the case of TDD modulation schemes (for e.g., GSM, LTE TDD & Sub6 NR TDD).

Table 5-1 : P_{limit} for supported technologies and bands (P_{limit} in EFS file)

Exposure condition			Body-Worn	Product Specific 10-g Without triggering sensor	Product Specific 10-g With triggering sensor	Head (RCV)	Hotspot	Ear-jack	Pmax (Maximum tune-up Power) (dBm)
Spatial-average			1g	10g	10g	1g	1g	10g	
Test distance (mm)			15	13/ 0/ 6/ 7	0	0	10	0	
DSI:			0	0	1	2	3	4	
RF Air Interface	Antenna	Antenn Group	P _{limit} corresponding to 1.0 W/kg (SAR _{design_target}) (1g) / 2.5 W/kg (SAR _{design_target}) (10g)						
GSM 850	Main.1	AG0	29.29	32.32	29.62	30.54	26.08	29.62	25.48
GSM 1900	Main.2	AG0	29.12	26.22	17.48	31.63	17.48	17.48	21.98
WCDMA Band II	Main.2	AG0	28.85	25.53	20.50	31.77	20.50	20.50	23.50
WCDMA Band IV	Main.2	AG0	22.50	25.57	20.50	22.50	20.50	20.50	23.50
WCDMA Band V	Main.1	AG0	29.90	32.21	28.25	30.30	26.33	28.25	24.20
LTE Band 7	Main.2	AG0	22.00	23.44	20.50	22.00	20.50	20.50	23.50
LTE Band 12	Main.1	AG0	30.47	32.01	29.61	32.08	27.38	29.61	24.50
LTE Band 13	Main.1	AG0	28.84	31.14	28.77	30.91	27.17	28.77	24.50
LTE Band 14	Main.1	AG0	29.18	33.30	29.57	31.28	27.04	29.57	24.50
LTE Band 25/2	Main.2	AG0	29.25	25.24	21.00	32.26	21.00	21.00	24.00
LTE Band 25/2	Sub.1	AG1	29.47	25.21	25.21	18.50	26.70	25.21	22.50
LTE Band 26/5	Main.1	AG0	29.81	31.71	28.59	30.24	26.17	28.59	24.50
LTE Band 30	Main.2	AG0	30.17	27.55	20.00	31.46	20.00	20.00	23.00
LTE Band 40	Main.2	AG0	19.15	21.81	20.93	20.10	26.47	20.93	10.00
LTE Band 66/4	Main.2	AG0	23.00	23.00	21.00	23.00	21.00	21.00	23.50
LTE Band 66/4	Sub.1	AG1	33.17	26.98	26.98	20.50	28.91	26.98	22.50
LTE Band 71	Main.1	AG0	30.47	32.39	28.99	32.43	28.09	28.99	24.50
LTE Band 41/38 PC3	Main.2	AG0	26.03	22.84	20.00	28.12	20.00	20.00	22.00
LTE Band 41 PC2	Main.2	AG0	26.34	24.11	20.00	27.99	20.00	20.00	21.90
LTE Band 48	Sub.3	AG1	17.00	17.00	17.00	17.00	17.00	17.00	20.50
NR Band n5	Main.1	AG0	29.27	31.50	28.70	30.83	26.11	28.70	24.50
NR Band n25/n2	Main.2	AG0	28.33	24.91	21.00	31.70	21.00	21.00	24.00
NR Band n30	Main.2	AG0	30.48	27.15	20.00	31.94	20.00	20.00	23.00
NR Band n66	Main.2	AG0	29.22	24.47	21.00	31.32	21.00	21.00	24.00
NR Band n70	Main.2	AG0	28.03	24.61	20.00	31.55	20.00	20.00	22.00
NR Band n71	Main.1	AG0	29.57	32.53	29.48	31.23	27.15	29.48	23.50
NR Band n41 PC3/PC2	Main.2	AG0	19.50	19.50	17.00	19.50	19.50	17.00	25.50
NR Band n48-SRS 0	Sub.3	AG0	16.00	16.00	16.00	16.00	16.00	16.00	20.50
NR Band n48-SRS 1	Sub.5	AG1	9.50	9.50	9.50	9.50	9.50	9.50	10.50
NR Band n48-SRS 2	Sub.2	AG1	12.00	16.50	16.50	12.00	12.00	12.00	19.50
NR Band n48-SRS 3	Main.2	AG1	16.50	16.50	16.50	16.50	16.50	16.50	20.50
NR Band n77-SRS 0-PC3	Sub.3	AG0	17.00	17.00	17.00	17.00	17.00	17.00	24.00
NR Band n77-SRS 0-PC2	Sub.3	AG0	17.00	17.00	17.00	17.00	17.00	17.00	25.50
NR Band n77-SRS 1-PC/3PC2	Sub.5	AG1	9.50	9.50	9.50	9.50	9.50	9.50	15.50
NR Band n77-SRS 2-PC/3PC2	Sub.2	AG1	11.00	11.00	11.00	11.00	11.00	11.00	22.00
NR Band n77-SRS 3-PC/3PC2	Main.2	AG1	16.00	16.00	16.00	16.00	16.00	16.00	22.00

* Maximum Tune-up Target Power, P_{max} is configured in NV settings in DUT to limit maximum average transmitting power. This Power is converted into peak power in NV settings for TDD schemes. The DUT maximum allowed output power is equal to $P_{max} + 1.0$ dB device uncertainty.

Based on selection criteria described in Section 3.2.1, the selected technologies/bands for testing time-varying test sequences are highlighted in Table 5-1. During Part 2 testing, the *Reserve_power_margin* (dB) is set to 3dB in EFS according to the manufacturer guide.

As Part 1 and Part 2 testing took place in parallel the selected technologies/bands were chosen based upon anticipated values encountered during pretesting before Tx powers were finalized.

The radio configurations used in Part 2 test for selected technologies, bands, DSIs and antennas are listed in Table 5-2. The corresponding worst-case radio configuration 1g SAR values for selected technology/band/DSI are extracted from Part 1 report and are listed in the last column of Table 5-2.

Based on equations (1a), (2a), (3a) and (4a), it is clear that Part 2 testing outcome is normalized quantity, which implies that it can be applied to any radio configuration within a selected technology/band/DSI. Thus, as long as applying the worst-case SAR obtained from the worst radio configuration in Part 1 testing to calculate time-varying SAR exposure in equations (1a), (2a), (3a) and (4a), the accuracy in compliance demonstrate remains the same.

Table 5-2 : Radio configurations selected for Part 2 test

Test Case	Test Scenario	Tech	Band	Antenna	DSI	Channel	Freq. (MHz)	RB/RB Offset/Bandwidth (MHz)	Mode	SAR Exposure Scenario	Worst configurations	Part 1 Worst Case Measured SAR at P _{limit} (W/kg)
1	Test Sequence 1	GSM	1900	Main.2	3	661	1880.0	-	GPRS 4Slots	Hotspot	Rear - 10mm	0.161
	Test Sequence 2					661	1880.0	-	GPRS 4Slots			
2	Test Sequence 1	WCDMA	II	Main.2	3	9400	1880.0	-	RMC	Hotspot	Edge 2 - 10mm	0.321
	Test Sequence 2					9400	1880.0	-	RMC			
3	Test Sequence 1		IV	Main.2	3	1413	1732.6	-	RMC	Hotspot	Rear - 10mm	0.355
	Test Sequence 2					1413	1732.6	-	RMC			
4	Test Sequence 1	LTE	25	Main.2	3	26365	1882.5	1/99/20 MHz	QPSK	Hotspot	Rear - 10mm	0.315
	Test Sequence 2					26365	1882.5	1/99/20 MHz	QPSK			
5	Test Sequence 1		48	Sub.3	3	56207	3646.7	1/0/20 MHz	QPSK	Hotspot	Rear - 10mm	0.533
	Test Sequence 2					56207	3646.7	1/0/20 MHz	QPSK			
6	Test Sequence 1	NR	n70	Main.2	3	340500	1702.5	1/77/15 MHz	DFT-s-OFDM QPSK	Hotspot	Rear - 10mm	0.274
	Test Sequence 2					340500	1702.5	1/77/15 MHz	DFT-s-OFDM QPSK			
7	Test Sequence 1		n77-PC3	Sub.3	3	662000	3930.0	1/271/100 MHz	DFT-s-OFDM QPSK	Hotspot	Rear - 10 mm	0.441
	Test Sequence 2					662000	3930.0	1/271/100 MHz	DFT-s-OFDM QPSK			
8	Change in Call	LTE	48	Sub.3	3	56207	3646.7	1/0/20 MHz	QPSK	Hotspot	Rear - 10mm	0.533
9	Tech/Band Switch	GSM	1900	Main.2	3	661	1880.0	-	GPRS 4Slots	Hotspot	Rear - 10mm	0.161
		WCDMA	II	Main.2	3	9400	1880.0	-	RMC	Hotspot	Edge2 - 10mm	0.321
10	Time Window/ Antenna Switch	LTE	25	Main.2	3	26365	1882.5	1/99/20 MHz	QPSK	Hotspot	Rear - 10mm	0.315
		LTE	48	Sub.3	3	56207	3646.7	1/0/20 MHz	QPSK	Hotspot	Rear - 10mm	0.533
11	DSI Switch	LTE	7	Main.2	3	21100	2535.0	50/24/20 MHz	QPSK	Hotspot	Rear - 10mm	0.605
				Main.2	0	21100	2535.0	50/24/20 MHz	QPSK	Body-worn	Rear - 15mm	0.447
12	SAR1 vs SAR2 (EN-DC)	LTE	12	Main.1	3	23095	707.5	1/49/10MHz	QPSK	Hotspot	Rear - 10mm	0.549
		NR	n25	Main.2	3	376500	1882.5	1/1/40MHz	QPSK	Hotspot	Rear-10mm	0.414

Notes:

Reported SAR values in Part 1 SAR report are tested at $P_{limit} +$ tolerance. Therefore, 100s(or 60s) average SAR is shown to be ± 1.0 dB from SAR design target.

Based on the selection criteria described in Section 3.2, the radio configurations for the Tx varying transmission test cases listed in Section 2 are:

1. Technologies and bands for time-varying Tx power transmission: The test case 1 ~ 7 listed in Table 5-2 are selected to test with the test sequences defined in Section 3.1 in both time-varying conducted power measurement and time-varying SAR measurement.
2. Technology and band for change in call test: LTE Band 48 having the lowest P_{limit} among all technologies and bands (test case 8 in Table 5-2) is selected for performing the call drop test in conducted power setup.
3. Technologies and bands for change in technology/band test: Following the guidelines in Section 3.2.3, test case 9 in Table 5-2 is selected for handover test from a technology/band in Within one technology group (GSM1900, DSI=3, Main.2 Ant), to a technology/band in the same DSI within another technology group (WCDMA Band II, DSI=3, Main.2 Ant) in conducted power setup.
4. Technologies and bands for change in time-window/antenna: Based on selection criteria in Section 3.2.6 and 3.2.4 for a given DSI=3, test case 10 in Table 5-2 is selected for time window switch between 100s window (LTE Band 25, Main.2 Ant) and 60s window (LTE Band 48, Sub.3 Ant) in conducted power setup.
5. Technologies and bands for change in DSI: Based on selection criteria in Section 3.2.5, for a given technology and band, test case 11 in Table 5-2 is selected for DSI switch test by establishing a call in LTE Band 7 in DSI=0, and then handing over to DSI =3 exposure scenario in conducted power setup.
6. Technologies and bands for switch in SAR exposure: Based on selection criteria in Section 3.2.7 Scenario 1, test case 12 in Table 5-2 is selected for SAR exposure switching test in one of the supported simultaneous WWAN transmission scenario, i.e., LTE + Sub6 NR active in the same 100s time window, in conducted power setup.

5. Conducted Power Test Results for Sub-6 Smart Transmit Feature Validation

5.1. Measurement setup

GSM / WCDMA / LTE test setup using The Rohde & Schwarz CMW500 callbox

The Rohde & Schwarz CMW500 callbox is used in this test.

Test setup Schematic	Test item(s)	Description(s)	Test setup photo
Figure B-1(a)	Time-varying Tx power transmission test (Section 3.3.1)	Single antenna measurement, one port (RF1 COM) of callbox	A.1
	Change in Call test (Section 3.3.2)		
	Change in DSI test (Section 3.3.5)		
	Change in technology and band test (Section 3.3.3)		
Figure B-1(c)	Change in antenna (Section 3.3.4)	two different antennas measurement, two ports (RF1 & RF3 COM) of callbox	A.2
	Change in time window (Section 3.3.6)		

LTE + Sub6 NR(NSA mode) / Sub6 NR (SA mode) test setup using The UXM callbox

The UXM callbox is used in this test.

Test setup Schematic	Test item(s)	Description(s)	Test setup photo
Figure B-1(a)	Time-varying Tx power transmission test (Section 3.3.1) -SA mode-	Single tech measurement, one port (RF1 COM) of callbox	A.3
Figure B-1(d)	SAR exposure switch test (Section 3.3.7) -NSA mode-	two different techs measurement, two ports (RF1 & RF3 COM) of callbox	A.4

All the path losses from RF port of DUT to the callbox RF COM port and to the power meter are calibrated and automatically entered as offsets in the callbox and the power meter via test scripts on the PC used to control callbox and power meter.

Setup photos of Test setup Schematic are list in Appendix A.

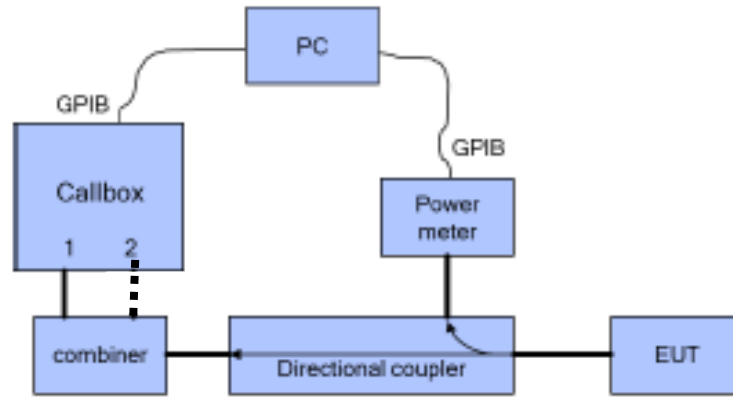

Figure B-1 (a) & Figure B-1 (b)

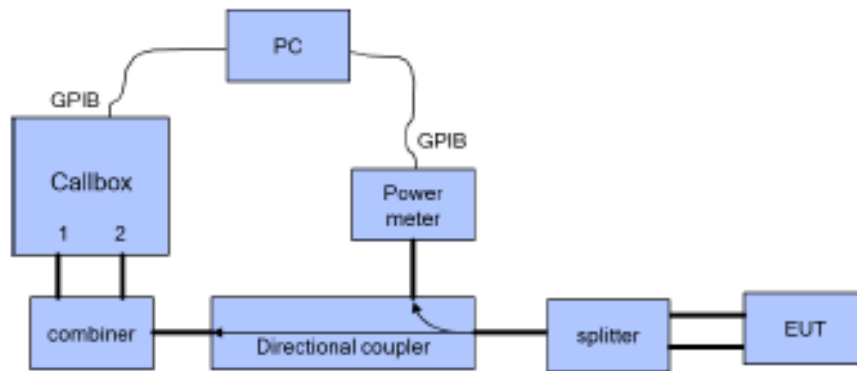

Figure B-1 (c)

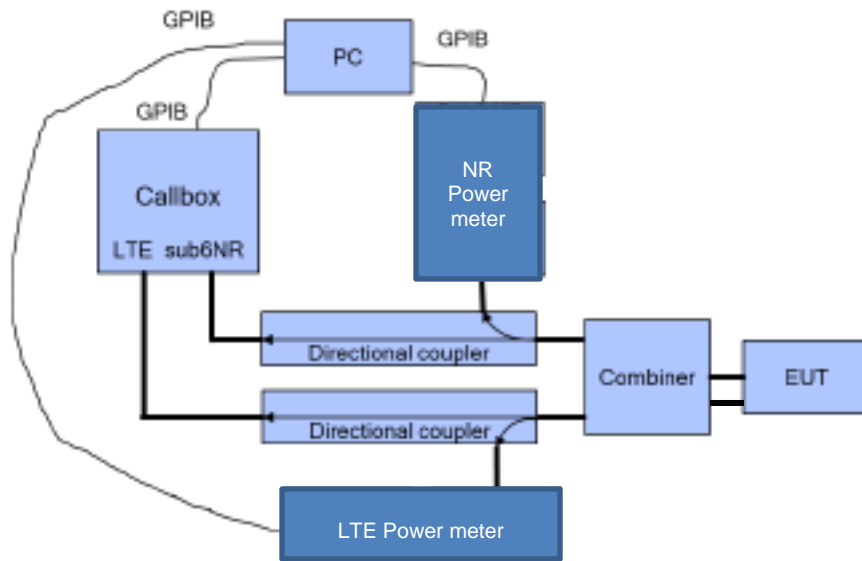

Figure B-1 (d)

Both the callbox and power meter are connected to the PC using GPIB cables. Two test scripts are custom made for automation, and the test duration set in the test scripts is 500 seconds.

For time-varying Tx power measurement, the PC runs the 1st test script to send GPIB commands to control the callbox's requested power versus time, while at the same time to record the conducted power measured at EUT RF port using the power meter. The commands sent to the callbox to request power are:

- 0 dBm for 100 seconds
- Test sequence 1 or test sequence 2 (defined in Section 3.1 and generated in Section 3.2.1), For 360 seconds
- Stay at the last power level of test sequence 1 or sequence 2 for the remaining time. Power meter readings are periodically recorded every 100ms. A running average of this measured Tx power over 100 seconds is performed in the post-data processing to determine the 100s-time averaged power.

For call drop, technology/band/antenna switch, and DSI switch tests, after the call is established, the callbox is set to request the EUT's Tx power at 0dBm for 100 seconds while simultaneously starting the 2nd test script runs at the same time to start recording the Tx power measured at EUT RF port using the power meter. After the initial 100 seconds since starting the Tx power recording, the callbox is set to request maximum power from the EUT for the rest of the test. Note that the call drop/re-establish, or technology/band/antenna switch or DSI switch is manually performed when the Tx power of EUT is at $P_{reserve}$ level. See Section 3.3 for detailed test procedure of call drop test, technology/band/antenna switch test and DSI switch test.

5.2. P_{limit} and P_{max} measurement results

This measured P_{limit} for all the selected radio configurations given in Table 5-2 are listed in below Table 6-1. P_{max} was also measured for radio configurations selected for testing time-varying Tx power transmission scenarios in order to generate test sequences following the test procedures in Section 3.1.

Table 6-1 : Measured P_{limit} and P_{max} of selected radio configurations
 Note: the device uncertainty of P_{max} is +1.0dB/-1.5dB as provided by manufacturer.

Test Case	Test Scenario	Tech	Band	Antenna	DSI	Channel	Freq. (MHz)	RB/RB Offset/Bandwidth (MHz)	Mode	SAR Exposure Scenario	Worst configurations	Part 1 Worst Case Measured SAR at P_{limit} (W/kg)	P_{limit} (dBm)	measured P_{limit} (dBm)	Tune-up P_{max} (dBm)	Measured P_{max} (dBm)
1	Test Sequence 1	GSM	1900	Main.2	3	661	1880.0	-	GPRS 4Slots	Hotspot	Rear - 10mm	0.161	17.48	17.70	21.98	21.26
	661					1880.0	-	GPRS 4Slots								
2	Test Sequence 1	WCDMA	II	Main.2	3	9400	1880.0	-	RMC	Hotspot	Edge 2 - 10mm	0.321	20.50	20.20	23.50	23.21
	9400					1880.0	-	RMC								
3	Test Sequence 1		IV	Main.2	3	1413	1732.6	-	RMC	Hotspot	Rear - 10mm	0.355	20.50	20.54	23.50	22.56
	Test Sequence 2					1413	1732.6	-	RMC							
4	Test Sequence 1	LTE	25	Main.2	3	26365	1882.5	1/99/20 MHz	QPSK	Hotspot	Rear - 10mm	0.315	21.00	20.37	24.00	24.00
	Test Sequence 2					26365	1882.5	1/99/20 MHz	QSPK							
5	Test Sequence 1		48	Sub.3	3	56207	3646.7	1/0/20 MHz	QPSK	Hotspot	Rear - 10mm	0.533	17.00	17.13	20.50	20.37
	Test Sequence 2					56207	3646.7	1/0/20 MHz	QPSK							
6	Test Sequence 1	NR	n70	Main.2	3	340500	1702.5	1/77/15 MHz	DFT-s-OFDM QPSK	Hotspot	Rear - 10mm	0.274	20.00	19.39	22.00	22.23
	Test Sequence 2					340500	1702.5	1/77/15 MHz	DFT-s-OFDM QPSK							
7	Test Sequence 1		n77-PC3	Sub.3	3	662000	3930.0	1/271/100 MHz	DFT-s-OFDM QPSK	Hotspot	Rear - 10 mm	0.441	17.00	16.54	24.00	23.98
	Test Sequence 2					662000	3930.0	1/271/100 MHz	DFT-s-OFDM QPSK							
8	Change in Call	LTE	48	Sub.3	3	56207	3646.7	1/0/20 MHz	QPSK	Hotspot	Rear - 10mm	0.533	17.00	17.13	20.50	20.37
9	Tech/Band Switch	GSM	1900	Main.2	3	661	1880.0	-	GPRS 4Slots	Hotspot	Rear - 10mm	0.161	17.48	17.70	21.98	21.26
		WCDMA	II	Main.2	3	9400	1880.0	-	RMC	Hotspot	Edge2 - 10mm	0.321	20.50	20.20	23.50	23.21
10	Time Window/ Antenna Switch	LTE	25	Main.2	3	26365	1882.5	1/99/20 MHz	QPSK	Hotspot	Rear - 10mm	0.315	21.00	20.37	24.00	24.00
		LTE	48	Sub.3	3	56207	3646.7	1/0/20 MHz	QPSK	Hotspot	Rear - 10mm	0.533	17.00	17.13	20.50	20.37
11	DSI Switch	LTE	7	Main.2	3	21100	2535.0	50/24/20 MHz	QPSK	Hotspot	Rear - 10mm	0.605	20.50	19.72	23.50	22.71
				Main.2	0	21100	2535.0	50/24/20 MHz	QPSK	Body-worn	Rear - 15mm	0.447	22.00	21.20	23.50	22.71
12	SAR1 vs SAR2 (EN-DC)	LTE	12	Main.1	3	23095	707.5	1/49/10MHz	QPSK	Hotspot	Rear - 10mm	0.549	24.50	24.43	24.50	24.43
		NR	n25	Main.2	3	376500	1882.5	1/1/40MHz	QPSK	Hotspot	Rear-10mm	0.414	21.00	20.37	24.00	24.00

Notes:

1. Tests including duty-cycle transmit are normalized to frame average.
2. Due to a limitation of the available test equipment, a modified procedure was used for Sub6 NR TDD Cases. The relevant parameters are shown below. On the above table, NR Band n77 measured P_{max} and Measured P_{limit} values represent $P_{max_sequence}$ and $P_{limit_sequence}$. Section B.3 contains more details about the modified procedure used for NR Band n77 evaluation.

Table 6-1-1 : Parameter for NR Band n77 Testing

Modified Procedure lists	Output power
$P_{max_online_avg_dBm}$	23.45 dBm
$P_{limit_ftm_dBm}$	10.54 dBm
$P_{limit_online_avg_dBm}$	16.01 dBm
DutyCycle_dB	0.53 dB
$P_{max_Sequence}$	23.98 dBm
$P_{limit_Sequence}$	16.54 dBm

5.3. Time-varying Tx power measurement results (test case 1 - 7 in Table 5-2)

The measurement setup is shown in Figures A-1(a) and A-1(c). The purpose of the time-varying Tx power measurement is to demonstrate the effectiveness of power limiting enforcement and that the time-averaged Tx power when represented in time-averaged 1gSAR or 10gSAR values does not exceed FCC limit as shown in Eq.(1a) and (1b), rewritten below:

$$1g_or_10gSAR(t) = \frac{\text{conducted_Tx_power}(t)}{\text{conducted_Tx_power_P}_{limit}} * 1g_or_10gSAR_P_{limit} \quad (1a)$$

$$\frac{\frac{1}{T_{SAR}} \int_{t-T_{SAR}}^t 1g_or_10gSAR(t) dt}{FCC\ SAR\ limit} \leq 1 \quad (1b)$$

Where, *conducted_Tx_power(t)*, *conducted_Tx_power_P_{limit}*, and *1g_or_10gSAR_P_{limit}* correspond to the measured instantaneous conducted Tx power, measured conducted Tx power at *P_{limit}*, and measured 1gSAR and 10gSAR value at *P_{limit}* reported in Part 1 test (listed in Table 5-2 of this report as well). Following the test procedure in Section 3.3, the conducted Tx power measurement for all selected configurations are reported in this section. In all the conducted Tx power plots, the dotted line represents the requested power by callbox (test sequence 1 or test sequence 2), the blue curve represents the instantaneous conducted Tx power measured using power meter, the green curve represents time-averaged power and red line represents the conducted power limit that corresponds to FCC limit of 1.6 W/kg for 1gSAR or 4.0 W/kg for 10gSAR.

Similarly, in all the 1g or 10gSAR plots (when converted using Eq. (1a)), the green curve represents the 100s/60s-time averaged 1gSAR or 10gSAR value calculated based on instantaneous 1gSAR or 10gSAR; and the red line limit represents the FCC limit of 1.6 W/kg for 1gSAR or 4.0 W/kg for 10gSAR.

Time-varying Tx power measurements were conducted on test case #1 ~ #7 in Table 5-2, by generating test sequence 1 and test sequence 2 given in Section A using measured *P_{limit}* and measured Pmax (last two columns of Table 6-1) for each of these test cases. Measurement results for test cases #1 ~ #7 are given in Sections 5.3.1 – 5.3.7.

5.3.1 GSM 1900

Test result for test sequence 1:

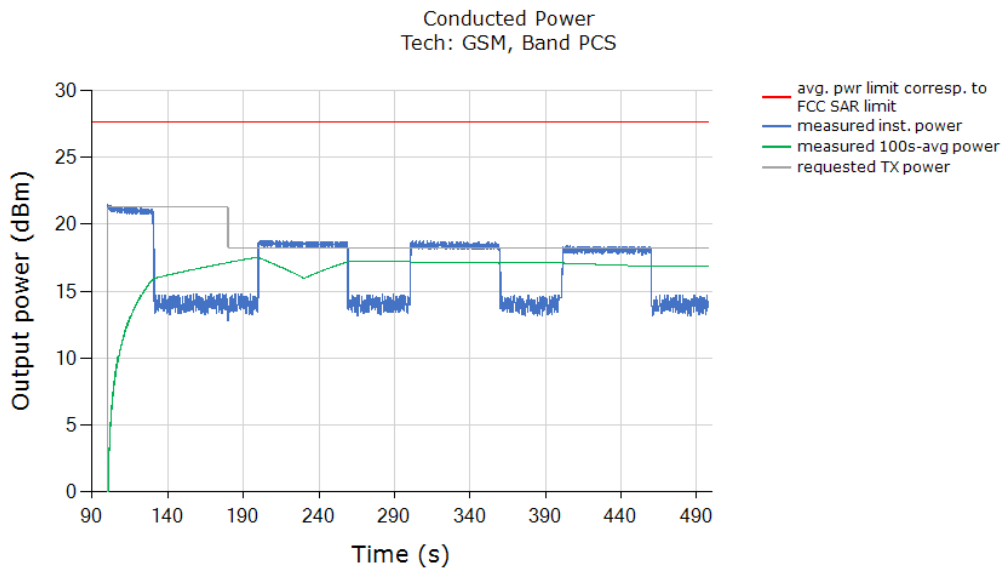

Above time-averaged conducted Tx power is converted/calculated into time-averaged SAR using Equation (1a) and plotted below to demonstrate that the time-averaged SAR versus time does not exceed the FCC limit for SAR (1.6W/kg for 1g SAR):

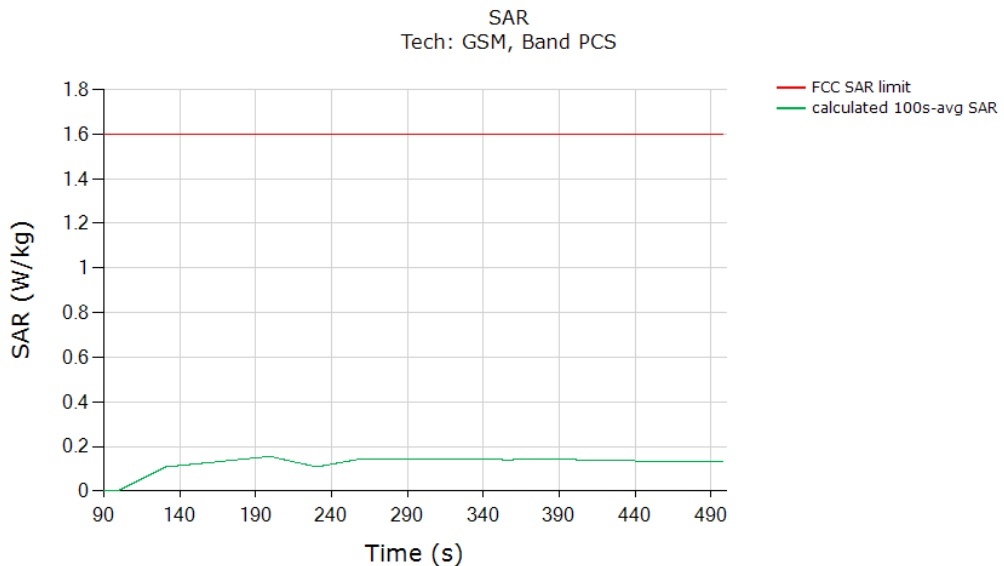

	(W/kg)
FCC 1gSAR limit	1.6
Max 100s-time averaged 1gSAR (green curve)	0.155
Validated : Max time averaged SAR (green curve) is within 1 dB device uncertainty of measured SAR at P_{limit} (Table 5-2).	

Test result for test sequence 2:

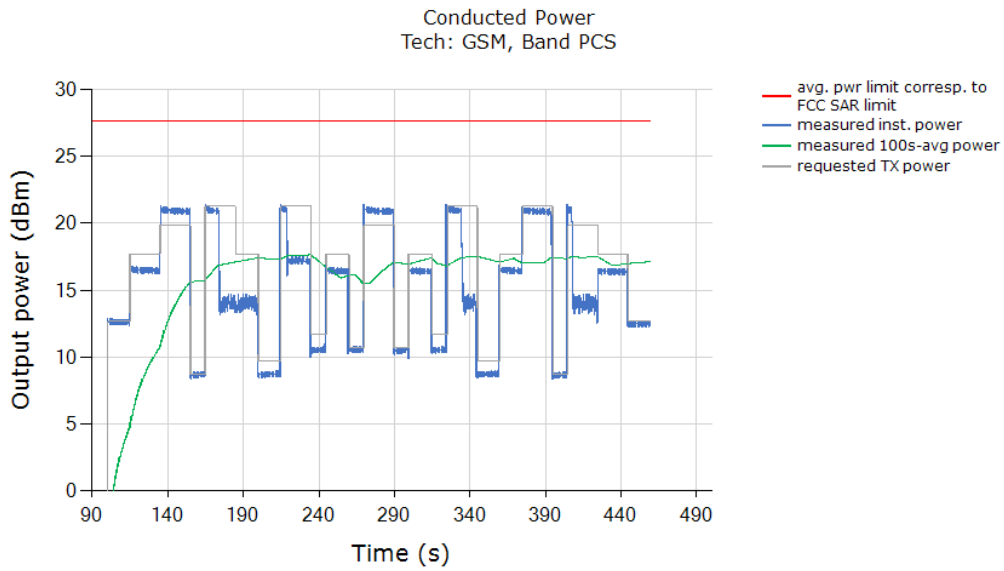

Above time-averaged conducted Tx power is converted/calculated into time-averaged SAR using Equation (1a) and plotted below to demonstrate that the time-averaged SAR versus time does not exceed the FCC limit for SAR (1.6W/kg for 1g SAR or 4.0W/kg for 10g SAR):

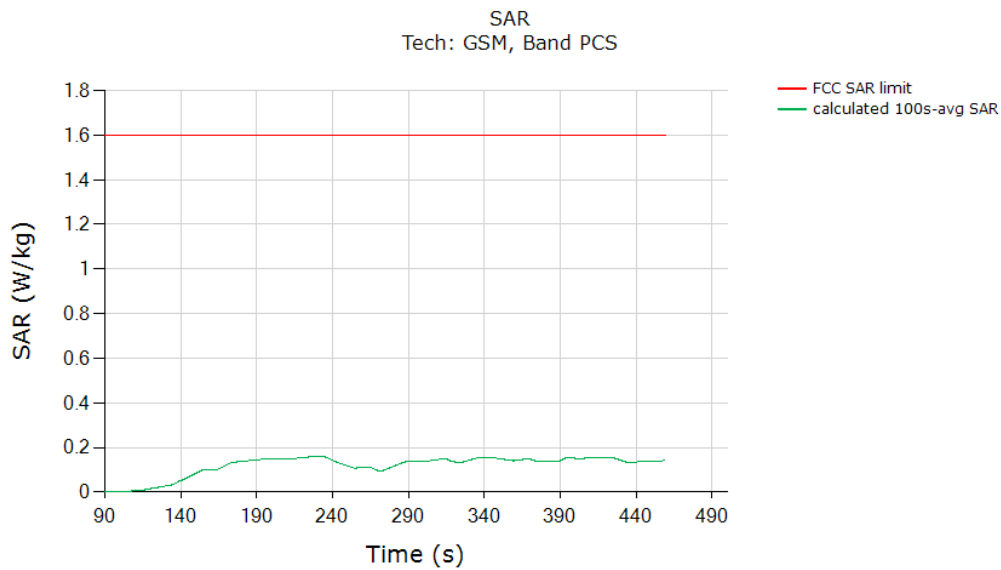

	(W/kg)
FCC 1gSAR limit	1.6
Max 100s-time averaged 1gSAR (green curve)	0.159
Validated : Max time averaged SAR (green curve) is within 1 dB device uncertainty of measured SAR at P_{limit} (Table 5-2).	

5.3.2 WCDMA Band II

Test result for test sequence 1:

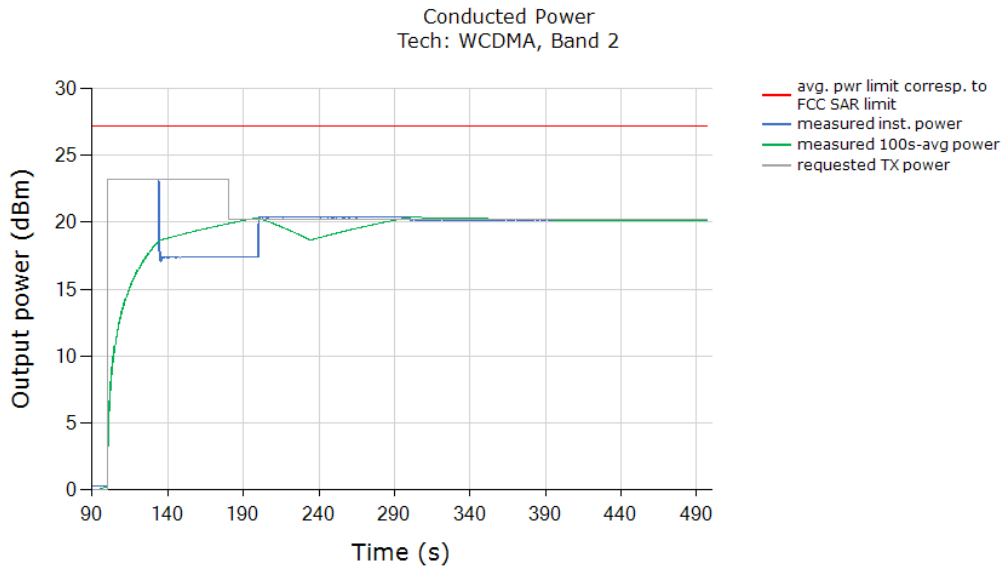

Above time-averaged conducted Tx power is converted/calculated into time-averaged SAR using Equation (1a) and plotted below to demonstrate that the time-averaged SAR versus time does not exceed the FCC limit for SAR (1.6W/kg for 1g SAR):

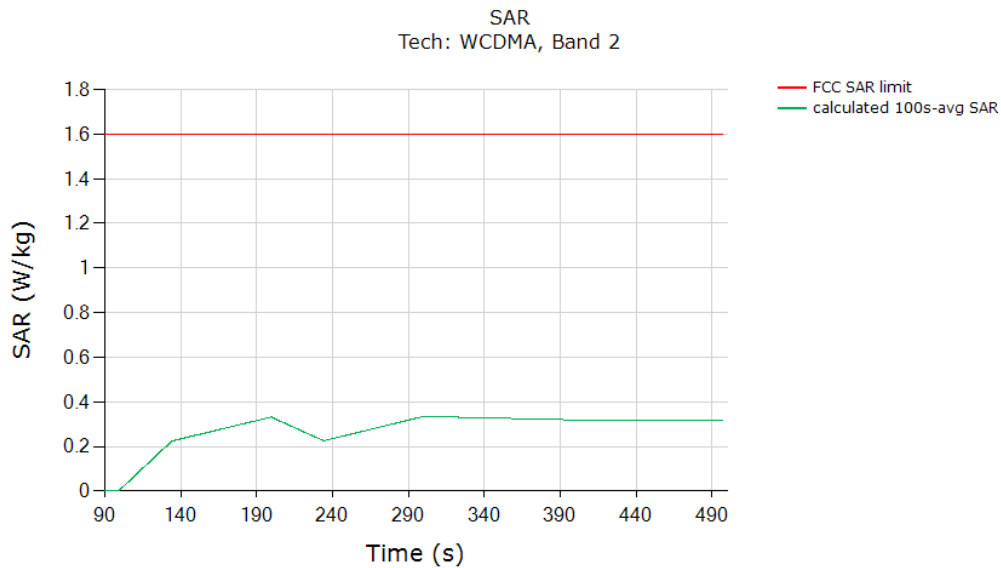

	(W/kg)
FCC 1gSAR limit	1.6
Max 100s-time averaged 1gSAR (green curve)	0.334
Validated : Max time averaged SAR (green curve) is within 1 dB device uncertainty of measured SAR at P_{limit} (Table 5-2).	

Test result for test sequence 2:

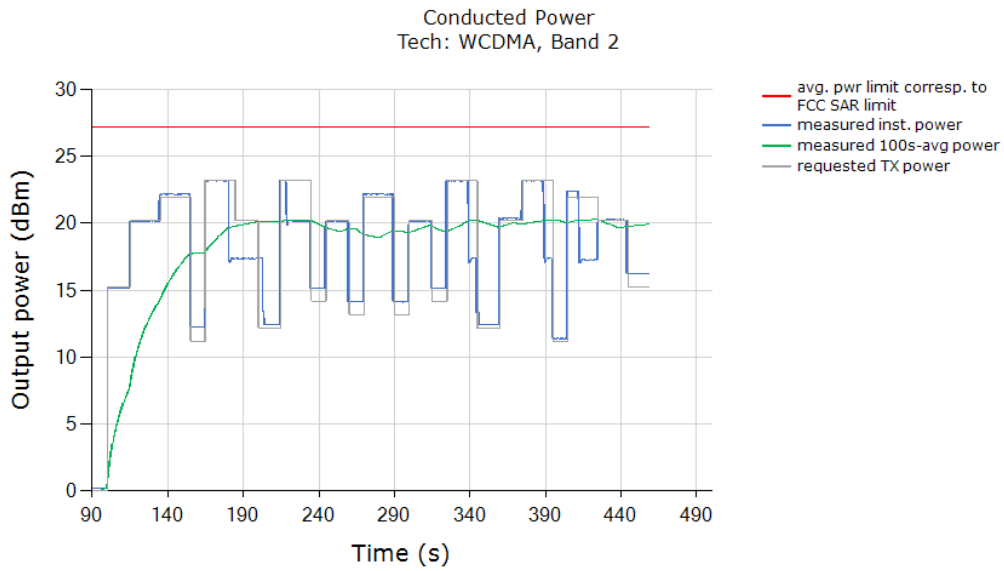

Above time-averaged conducted Tx power is converted/calculated into time-averaged SAR using Equation (1a) and plotted below to demonstrate that the time-averaged SAR versus time does not exceed the FCC limit for SAR (1.6W/kg for 1g SAR):

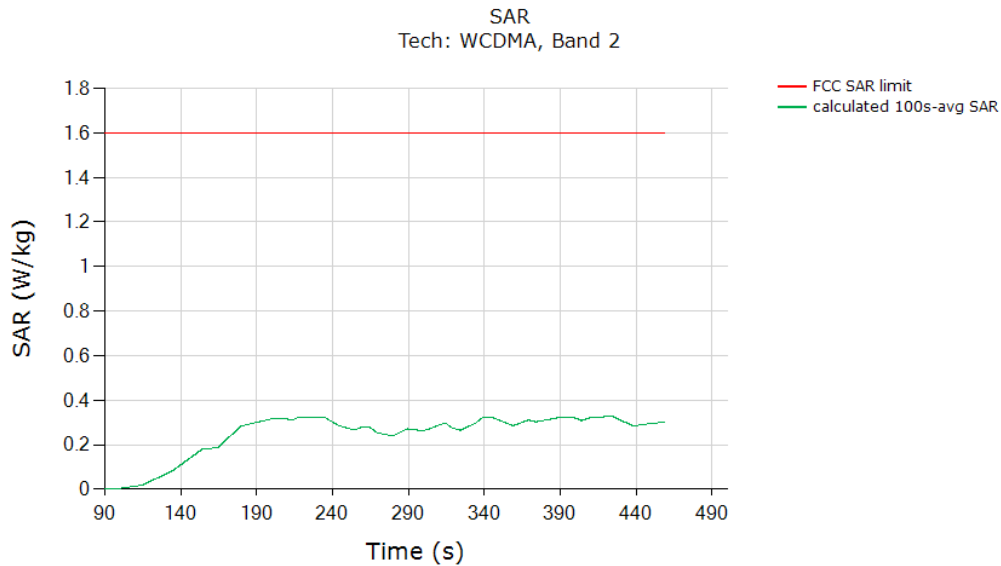

FCC 1gSAR limit	(W/kg)
Max 100s-time averaged 1gSAR (green curve)	1.6
Validated : Max time averaged SAR (green curve) is within 1 dB device uncertainty of measured SAR at P_{limit} (Table 5-2).	0.328

5.3.3 WCDMA Band IV

Test result for test sequence 1:

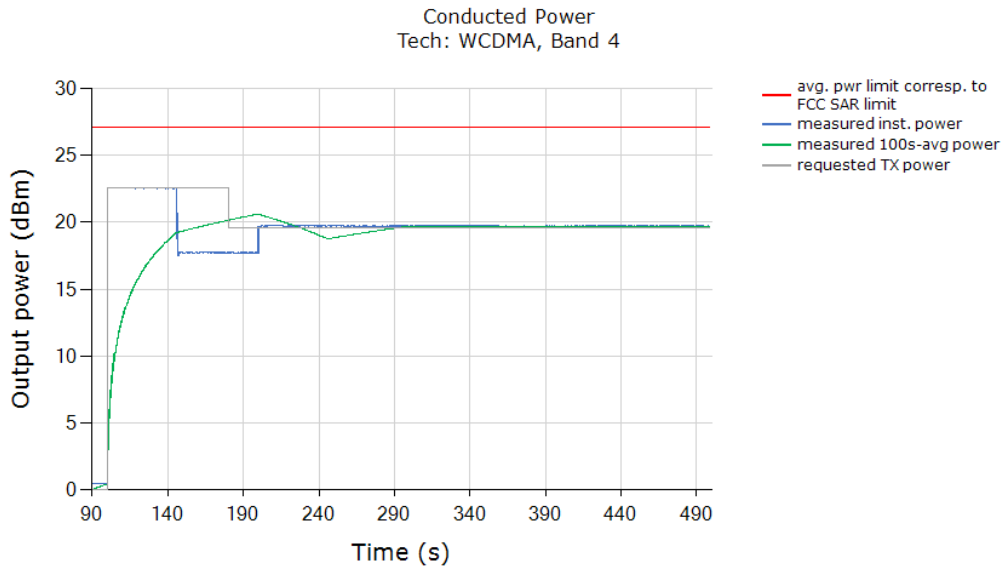

Above time-averaged conducted Tx power is converted/calculated into time-averaged SAR using Equation (1a) and plotted below to demonstrate that the time-averaged SAR versus time does not exceed the FCC limit for SAR (1.6W/kg for 1g SAR):

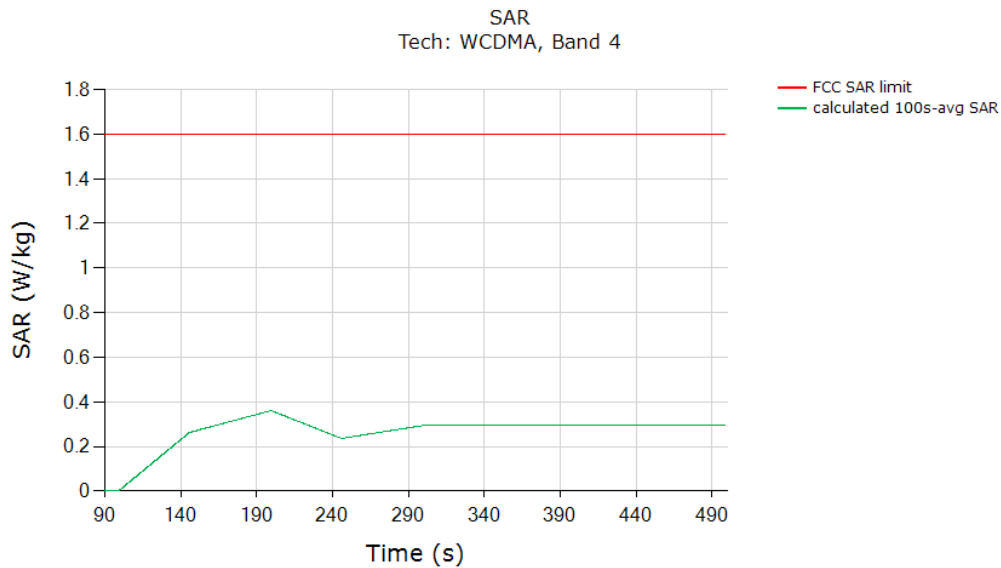

	(W/kg)
FCC 1gSAR limit	1.6
Max 100s-time averaged 1gSAR (green curve)	0.361
Validated : Max time averaged SAR (green curve) is within 1 dB device uncertainty of measured SAR at P_{limit} (Table 5-2).	

Test result for test sequence 2:

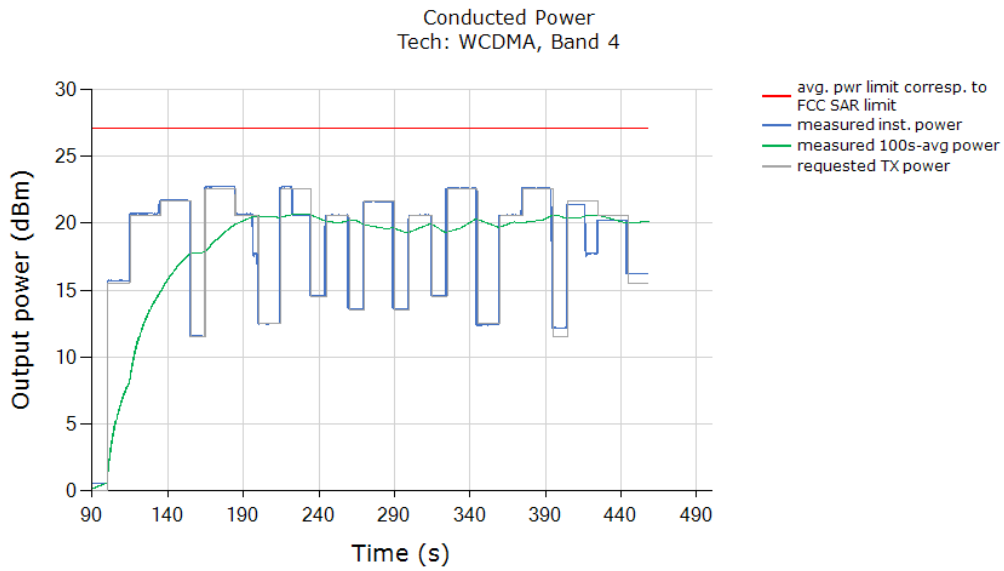

Above time-averaged conducted Tx power is converted/calculated into time-averaged SAR using Equation (1a) and plotted below to demonstrate that the time-averaged SAR versus time does not exceed the FCC limit for SAR (1.6W/kg for 1g SAR):

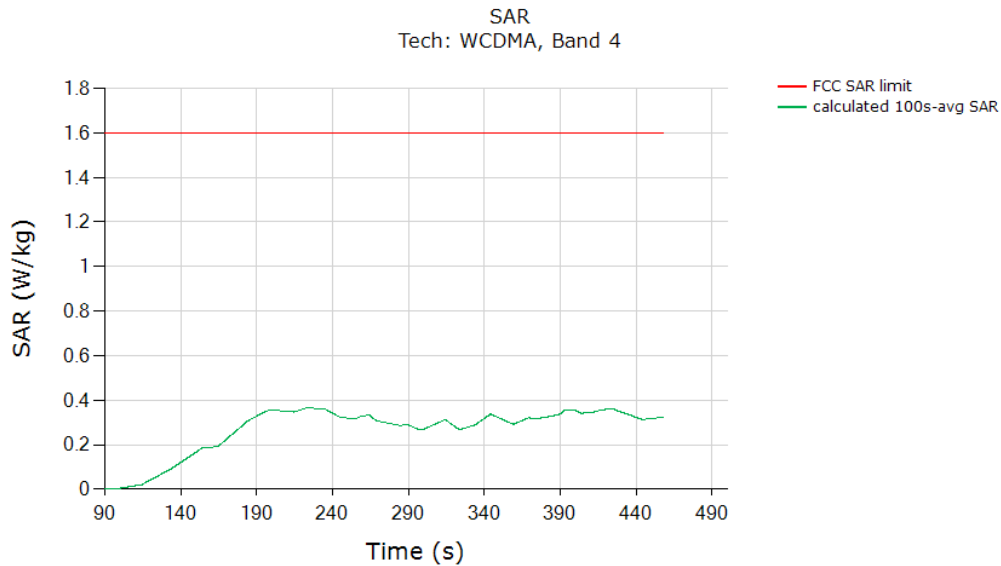

FCC 1gSAR limit	(W/kg)
	1.6
Max 100s-time averaged 1gSAR (green curve)	0.355
Validated : Max time averaged SAR (green curve) is within 1 dB device uncertainty of measured SAR at P_{limit} (Table 5-2).	

5.3.4 LTE Band 25

Test result for test sequence 1:

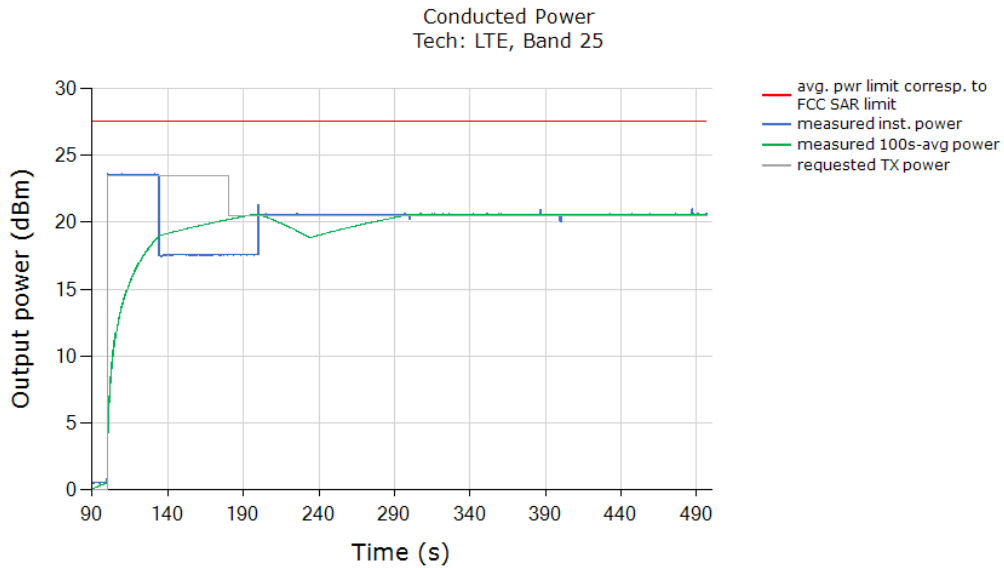

Above time-averaged conducted Tx power is converted/calculated into time-averaged SAR using Equation (1a) and plotted below to demonstrate that the time-averaged SAR versus time does not exceed the FCC limit for SAR (1.6W/kg for 1g SAR):

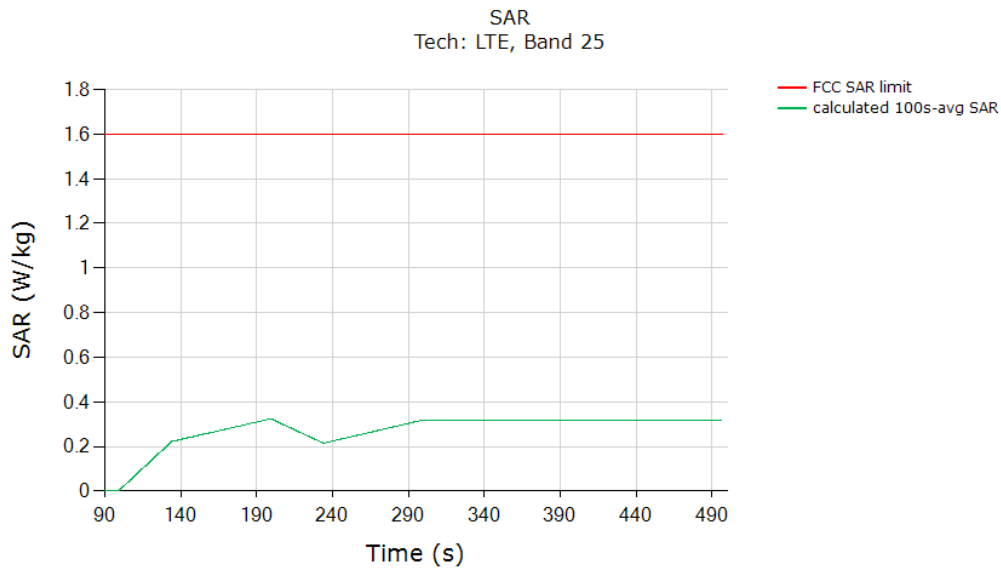

	(W/kg)
FCC 1gSAR limit	1.6
Max 100s-time averaged 1gSAR (green curve)	0.324
Validated : Max time averaged SAR (green curve) is within 1 dB device uncertainty of measured SAR at P_{limit} (Table 5-2).	

Test result for test sequence 2:

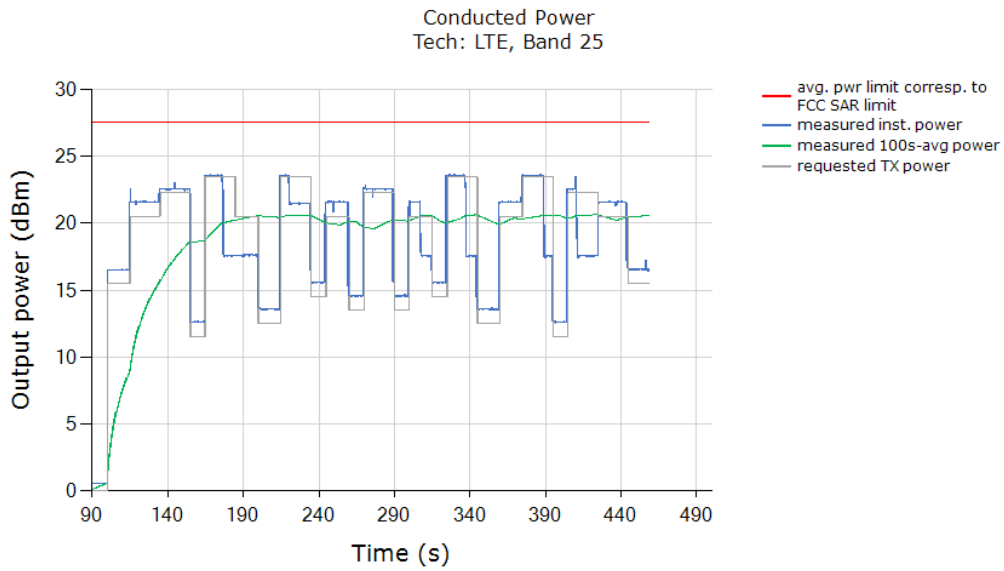

Above time-averaged conducted Tx power is converted/calculated into time-averaged SAR using Equation (1a) and plotted below to demonstrate that the time-averaged SAR versus time does not exceed the FCC limit for SAR (1.6W/kg for 1g SAR):

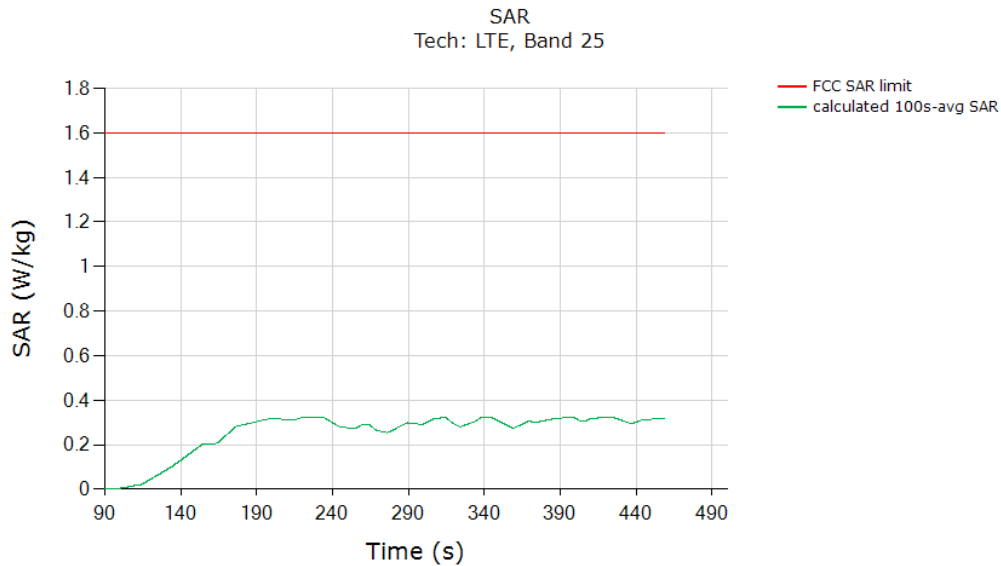

	(W/kg)
FCC 1gSAR limit	1.6
Max 100s-time averaged 1gSAR (green curve)	0.325
Validated : Max time averaged SAR (green curve) is within 1 dB device uncertainty of measured SAR at P_{limit} (Table 5-2).	

5.3.5 LTE Band 48

Test result for test sequence 1:

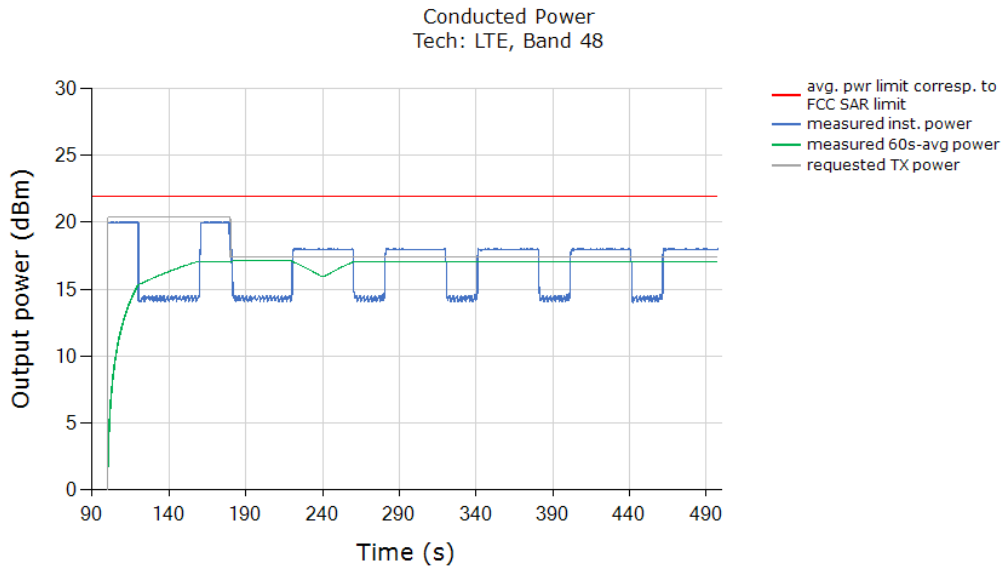

Above time-averaged conducted Tx power is converted/calculated into time-averaged SAR using Equation (1a) and plotted below to demonstrate that the time-averaged SAR versus time does not exceed the FCC limit for SAR (1.6W/kg for 1g SAR):

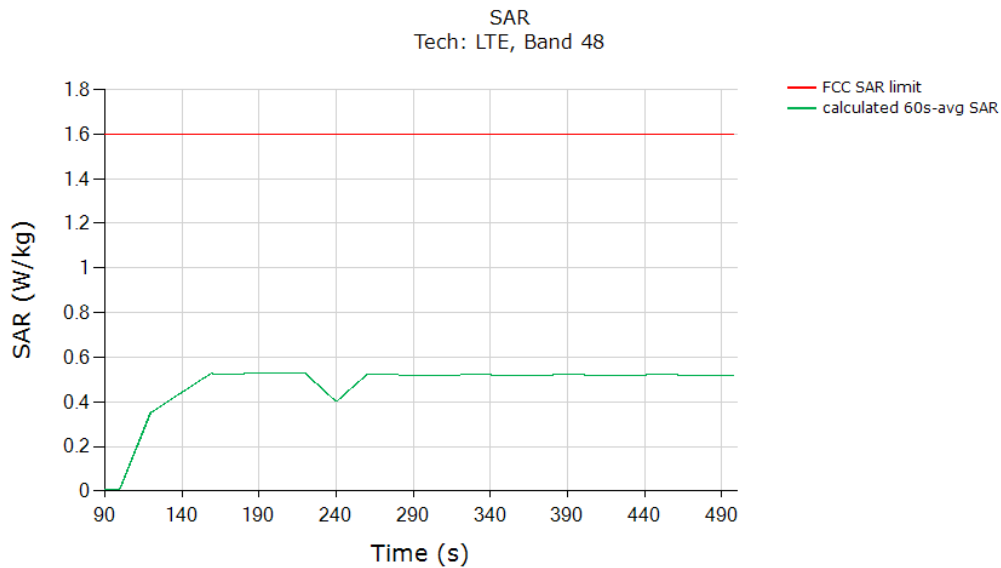

	(W/kg)
FCC 1gSAR limit	1.6
Max 100s-time averaged 1gSAR (green curve)	0.530
Validated : Max time averaged SAR (green curve) is within 1 dB device uncertainty of measured SAR at P_{limit} (Table 5-2).	

Test result for test sequence 2:

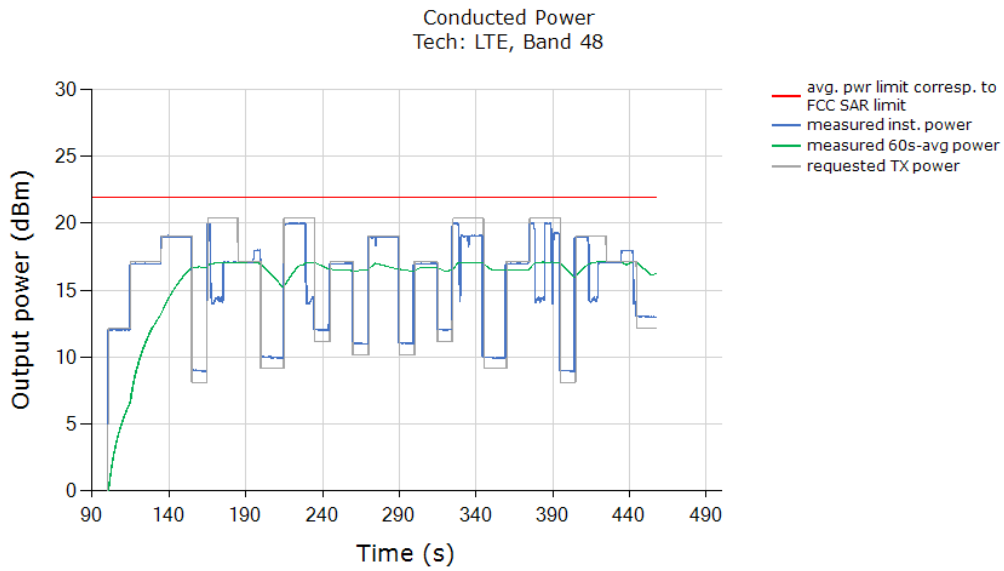

Above time-averaged conducted Tx power is converted/calculated into time-averaged SAR using Equation (1a) and plotted below to demonstrate that the time-averaged SAR versus time does not exceed the FCC limit for SAR (1.6W/kg for 1g SAR):

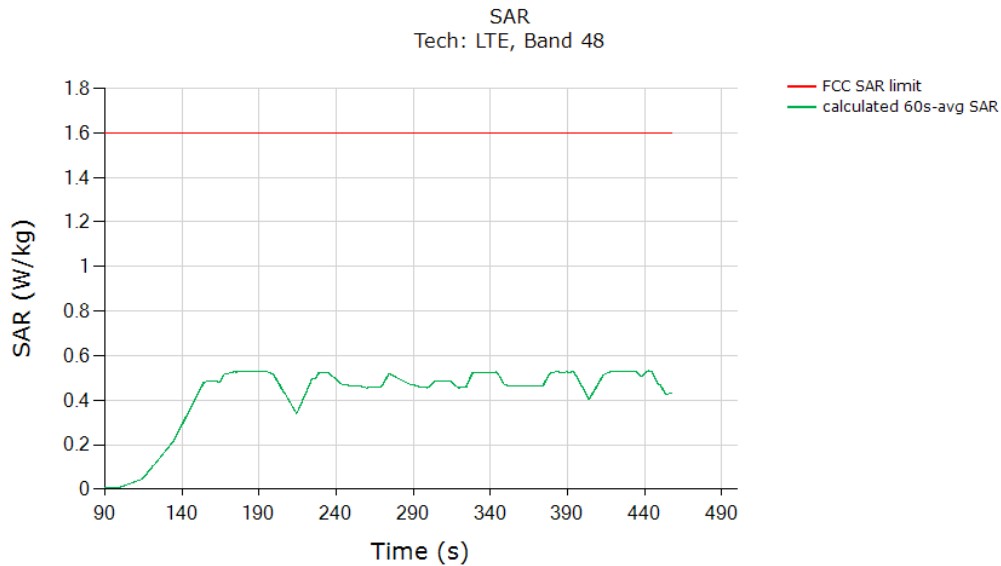

	(W/kg)
FCC 1gSAR limit	1.6
Max 100s-time averaged 1gSAR (green curve)	0.532
Validated : Max time averaged SAR (green curve) is within 1 dB device uncertainty of measured SAR at P_{limit} (Table 5-2).	

5.3.6 NR Band n70

Test result for test sequence 1:

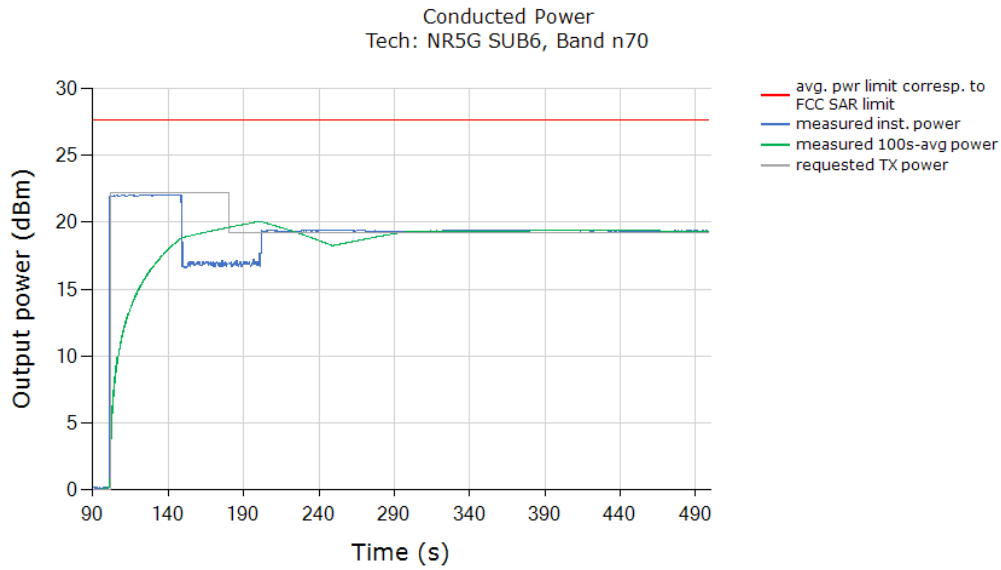

Above time-averaged conducted Tx power is converted/calculated into time-averaged SAR using Equation (1a) and plotted below to demonstrate that the time-averaged SAR versus time does not exceed the FCC limit for SAR (1.6W/kg for 1g SAR):

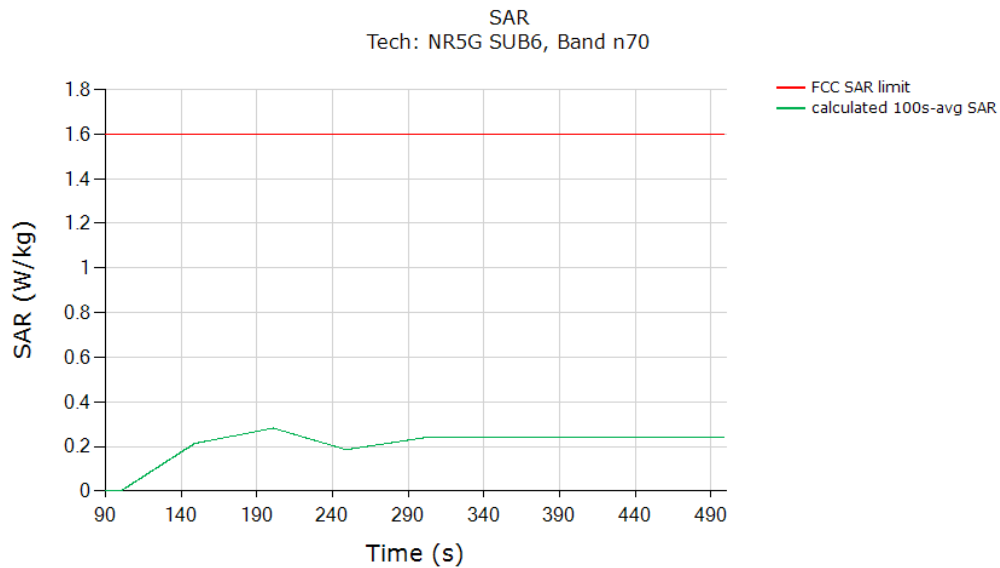

	(W/kg)
FCC 1gSAR limit	1.6
Max 60s-time averaged 1gSAR (green curve)	0.282
Validated : Max time averaged SAR (green curve) is within 1 dB device uncertainty of measured SAR at P_{limit} (Table 5-2).	

Test result for test sequence 2:

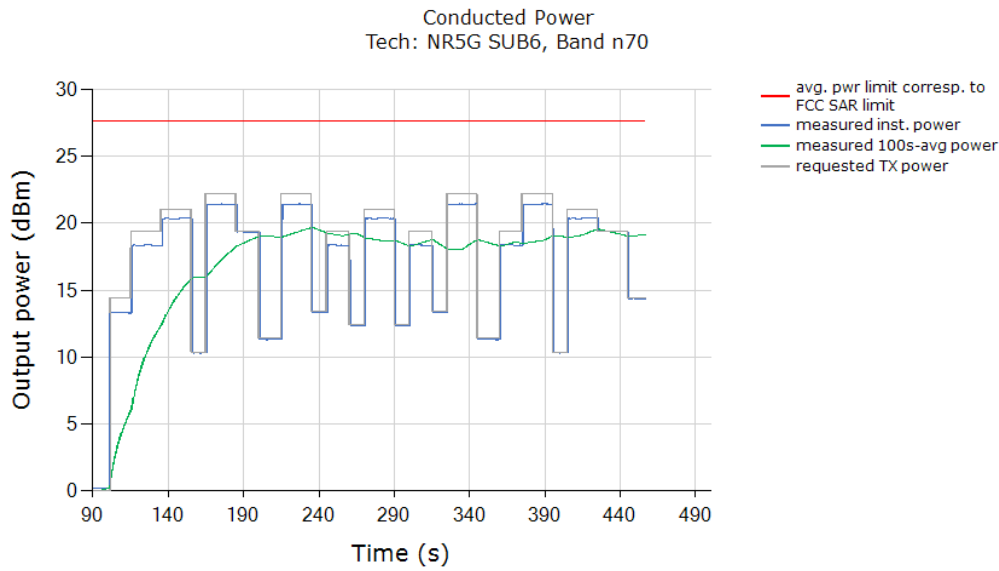

Above time-averaged conducted Tx power is converted/calculated into time-averaged SAR using Equation (1a) and plotted below to demonstrate that the time-averaged SAR versus time does not exceed the FCC limit for SAR (1.6W/kg for 1g SAR):

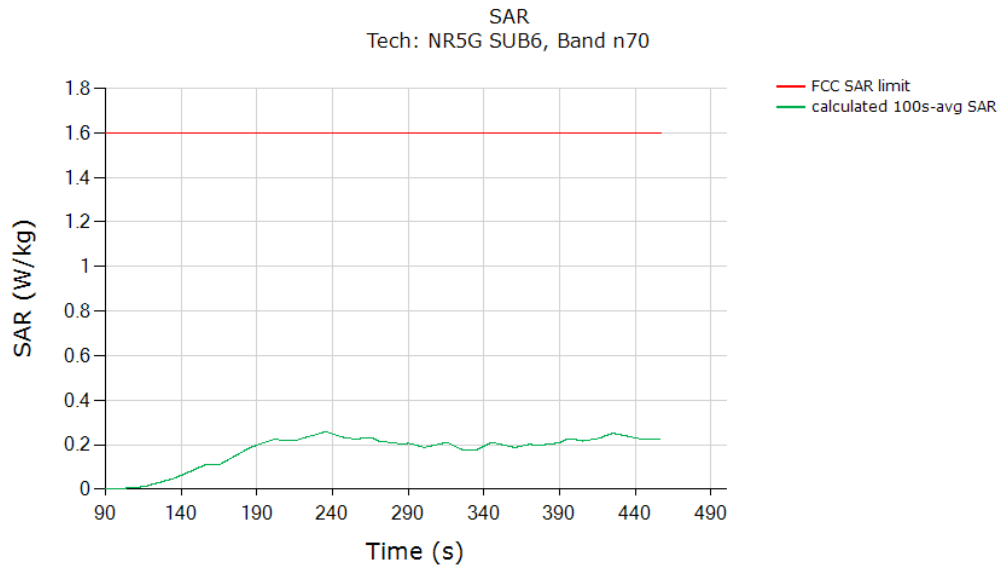

	(W/kg)
FCC 1gSAR limit	1.6
Max 60s-time averaged 1gSAR (green curve)	0.258
Validated : Max time averaged SAR (green curve) is within 1 dB device uncertainty of measured SAR at P_{limit} (Table 5-2).	

5.3.7 NR Band n77

Test result for test sequence 1:

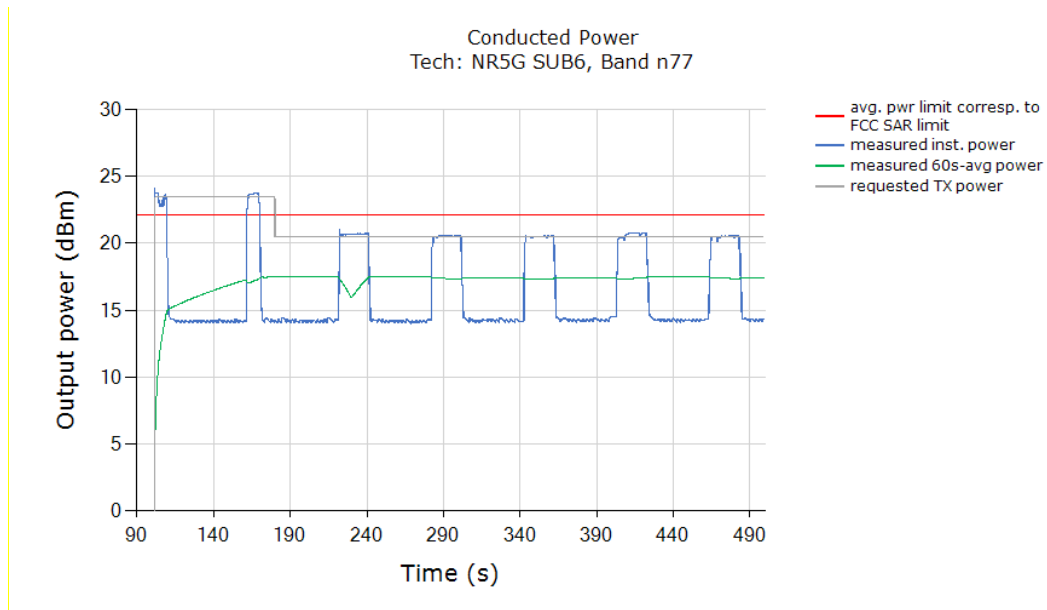

Above time-averaged conducted Tx power is converted/calculated into time-averaged SAR using Equation (1a) and plotted below to demonstrate that the time-averaged SAR versus time does not exceed the FCC limit for SAR (1.6W/kg for 1g SAR):

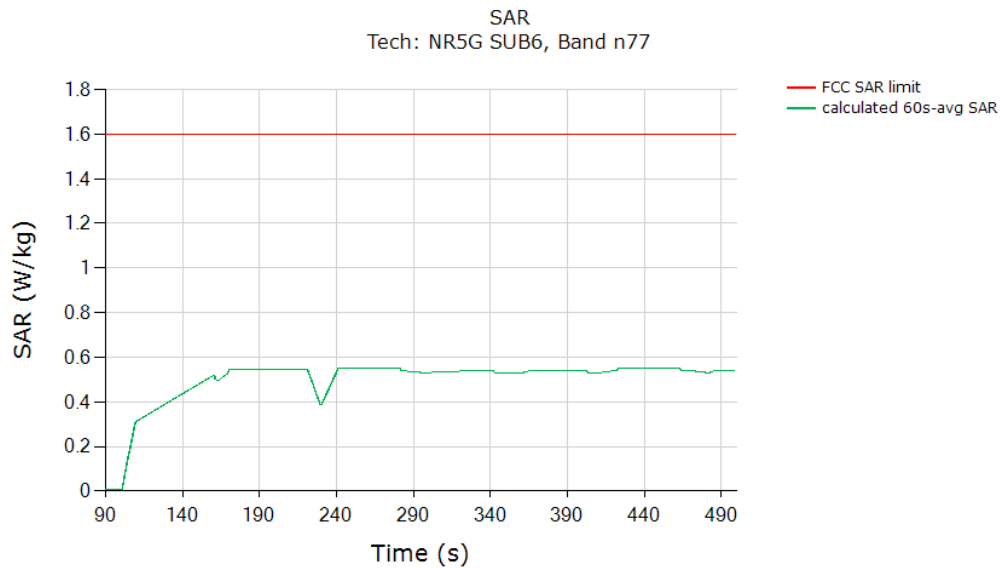

	(W/kg)
FCC 1gSAR limit	1.6
Max 60s-time averaged 1gSAR (green curve)	0.551
Validated : Max time averaged SAR (green curve) is within 1 dB device uncertainty of measured SAR at P_{limit} (Table 5-2).	

Test result for test sequence 2:

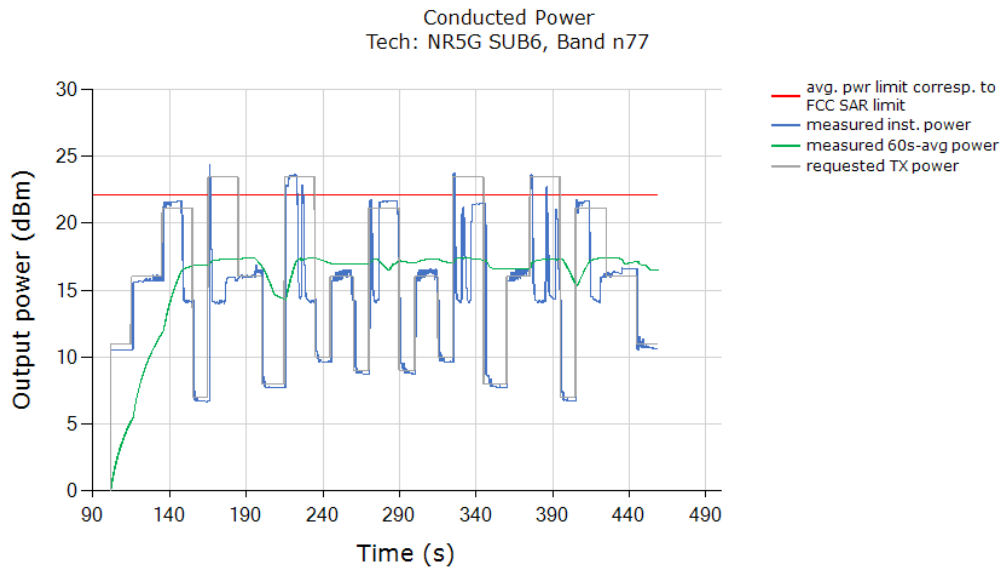

Above time-averaged conducted Tx power is converted/calculated into time-averaged SAR using Equation (1a) and plotted below to demonstrate that the time-averaged SAR versus time does not exceed the FCC limit for SAR (1.6W/kg for 1g SAR):

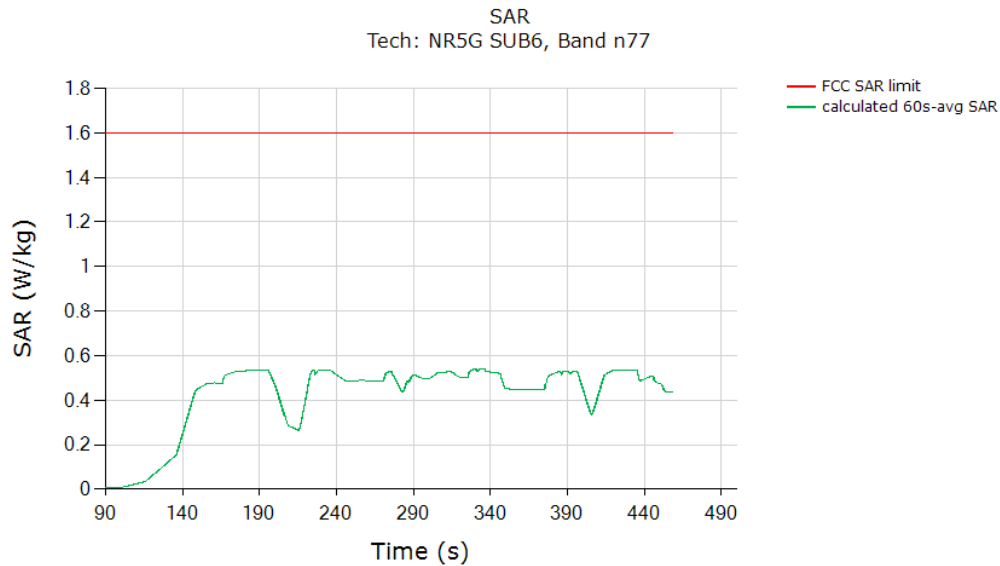

	(W/kg)
FCC 1gSAR limit	1.6
Max 60s-time averaged 1gSAR (green curve)	0.542
Validated : Max time averaged SAR (green curve) is within 1 dB device uncertainty of measured SAR at P_{limit} (Table 5-2).	

5.4 Change in Call Test Results (test case 8 in Table 5-2)

This test was measured with LTE Band 48, Sub.3 Ant, DSI =3, and with callbox requesting maximum power. The call drop was manually performed when the EUT is transmitting at $P_{reserve}$ level as shown in the plot below (dotted black region). The measurement setup is shown in Figure B-1(a). The detailed test procedures is described in Section 3.3.2.

Call drop test result:

Plot 1 : Measured Tx power (dBm) versus time shows that the transmitting power kept the same $P_{reserve}$ level of LTE Band 48 after the call was re-established:

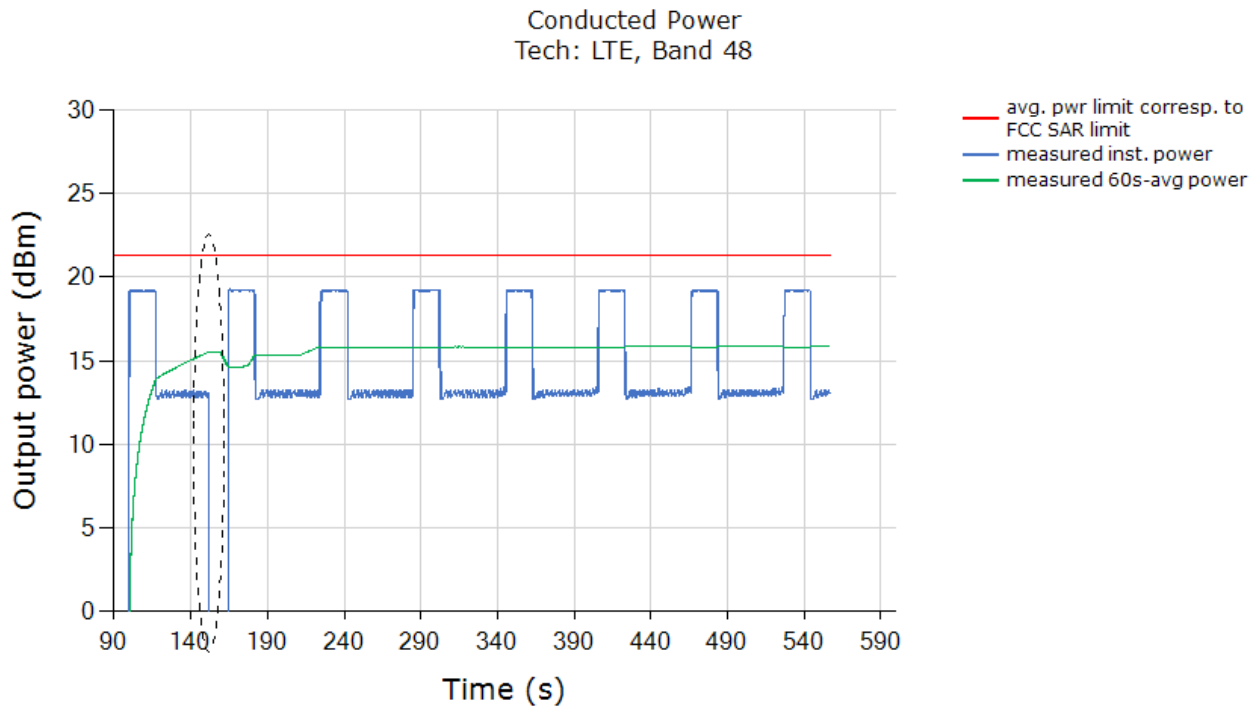

Plot Notes: The power level after the change in call kept the same $P_{reserve}$ level of LTE Band 48. The conducted power plot shows expected Tx transition.

Plot 2 : Above time-averaged conducted Tx power is converted/calculated into time-averaged SAR using Equation (1a) and plotted below to demonstrate that the time-averaged SAR versus time does not exceed the FCC limit for SAR(1.6W/kg for 1g SAR):

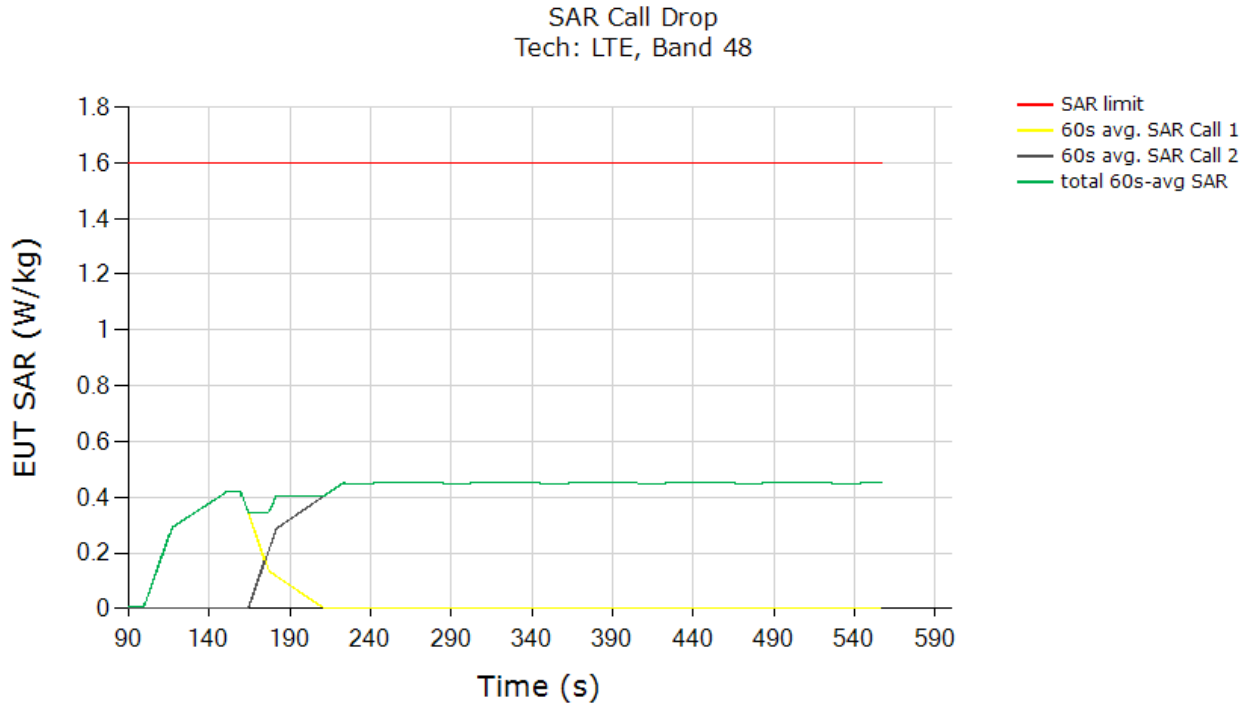

	(W/kg)
FCC 1gSAR limit	1.6
Max 60s-time averaged 1gSAR (green curve)	0.454
Validated	

The test result validated the continuity of power limiting in call change scenario.

5.5 Change in technology/band test results (test case 9 in Table 5-2)

This test was conducted with callbox requesting maximum power, and with antenna & technology switch from GSM1900, Main.2 Ant, DSI = 3 to WCDMA Band II, Main.2 Ant, DSI =3. Following procedure detailed in Section 3.3.3, and using the measurement setup shown in Figure B-1 (a), the technology/band switch was performed when the EUT is transmitting at $P_{reserve}$ level as shown in the plot below (dotted black region).

Test result for change in technology/band:

Plot 1 : Measured Tx power (dBm) versus time shows that the transmitting power changed from GSM1900, Main.2 Ant, DSI = 3 $P_{reserve}$ level to WCDMA Band II, Main.2 Ant, DSI = 3 $P_{reserve}$ level (within 1dB device uncertainty):

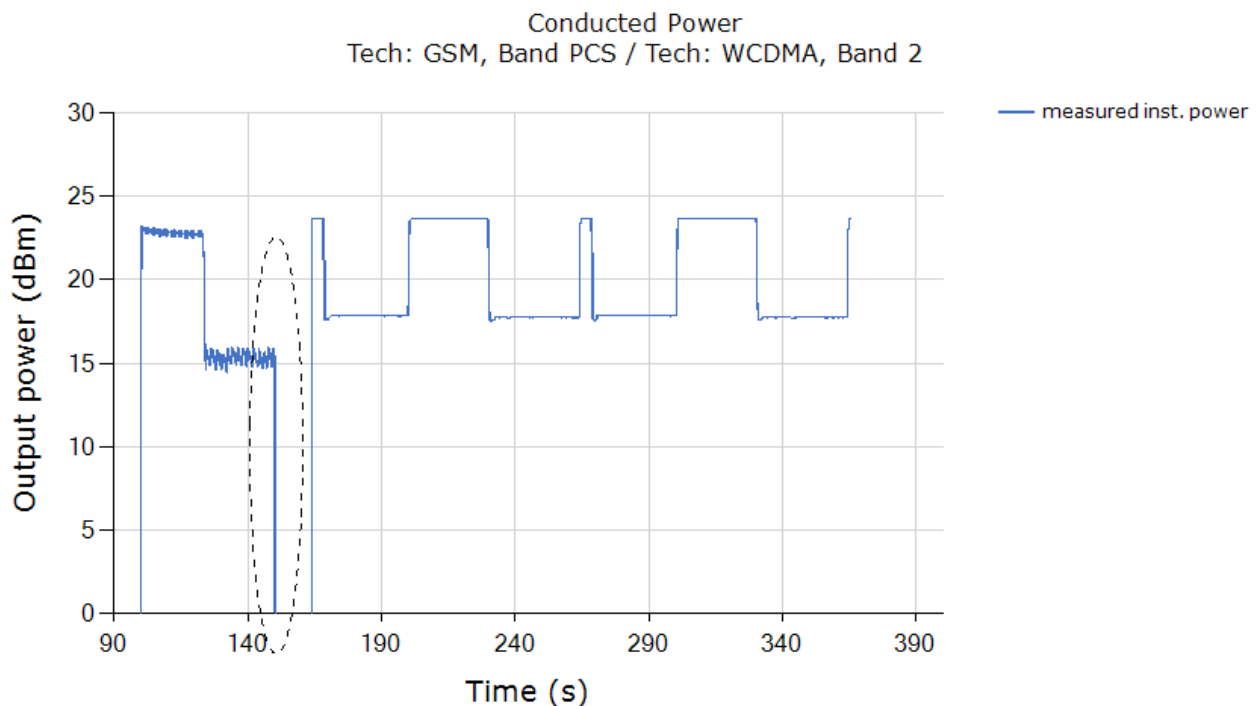

Plot Notes : $Reserve_power_margin = 3\text{dB}$ according to the manufacturer. Based on Table 5-1,
 $P_{limit} = 17.5\text{ dBm}$ for GSM1900 (DSI = 3), and
 $P_{limit} = 20.5\text{ dBm}$ for WCDMA Band II (DSI = 3)

It can be calculated that $P_{reserve} (P_{limit} - Reserve_pwer_margin) = 14.5\text{ dBm}$ and 17.5 dBm For GSM1900 and WCDMA Band II, respectively.

Plot 2: All the time-averaged conducted Tx power measurement results were converted into time-averaged normalized SAR values using Equation (6a), (6b) and (6c), and plotted below to demonstrate that the time-average normalized SAR versus time does not exceed the normalized FCC limit of 1.0:

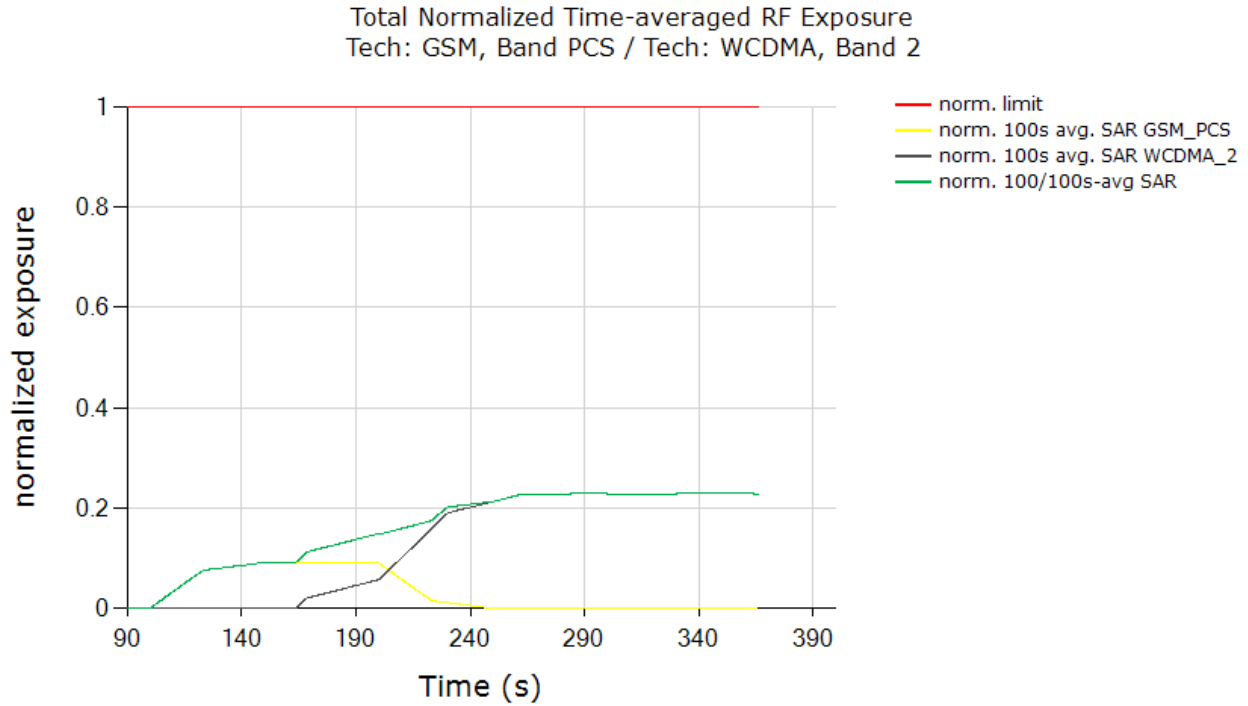

	(W/kg)
FCC normalized SAR limit	1.0
Max 100s-time averaged normalized SAR (green curve)	0.229
Validated	

The test result validated the continuity of power limiting in technology/band switch scenario.

5.6 Change in Time Window/Antenna test results (test case 10 in Table 5-2)

This test was conducted with callbox requesting maximum power, and with time-window/antenna switch between LTE Band 25, Main.2 Ant, DSI = 3 (100s window) and LTE Band 48, Sub.3 Ant, DSI = 3 (60s window). Following procedure detailed in Section 3.3.6, and using the measurement setup shown in Figure B-1(C), the time-window switch via tech/band/antenna switch was performed when the EUT is transmitting at $P_{reserve}$ level.

Test case.1) Test result for change in time-window (from 100s to 60s to 100s):

Plot 1 : Measured Tx power (dBm) versus time shows that the transmitting power changed when LTE Band 25 (100s window) switches to LTE Band 48 (60s window) and switches back to LTE Band 25 (100s window).

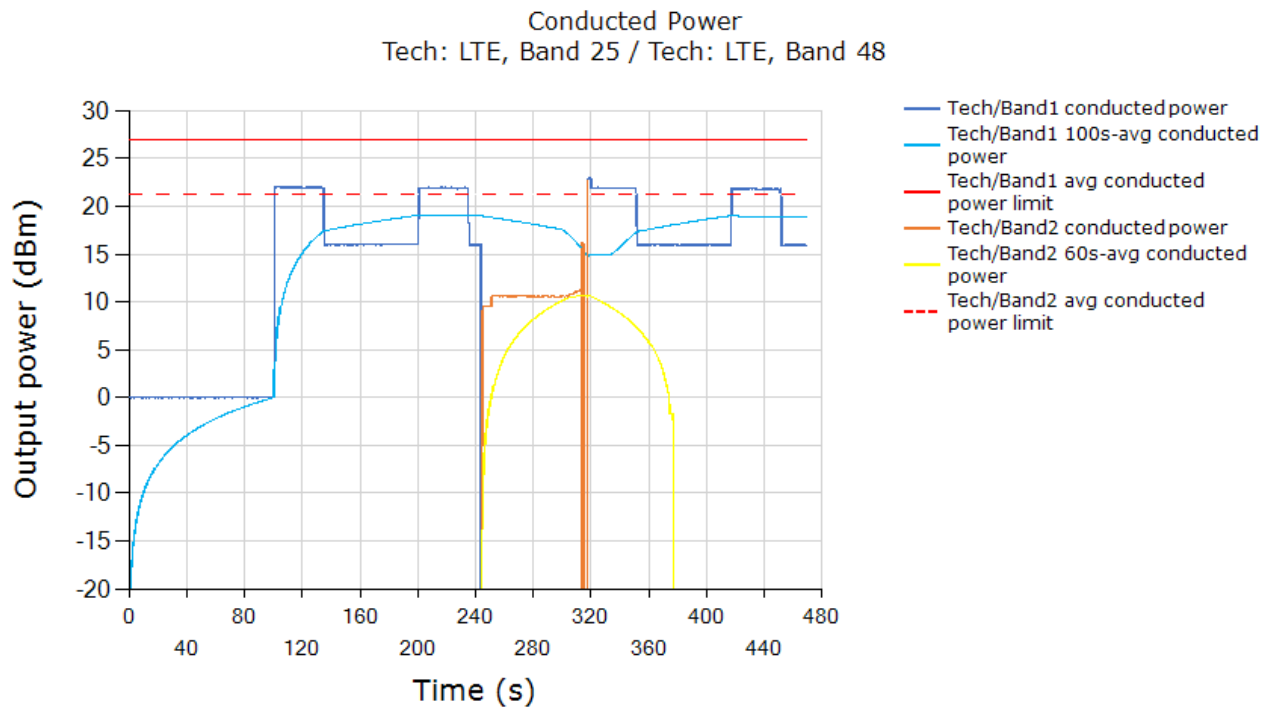

Plot Notes : $Reserve_power_margin = 3\text{dB}$ according to the manufacturer,

$P_{limit} = 21.0\text{ dBm}$ for LTE Band 25, and $P_{limit} = 17.0\text{ dBm}$ for LTE Band 48 according to Table 5.1.

The conducted power plot shows expected transitions in Tx power at ~245 seconds (100s-to-60s transition) and at ~318 seconds (60s-to-100s transition) in order to maintain total time-averaged RF exposure compliance across time windows, as show in next plot.

Plot 2: All the conducted Tx power measurement results were converted into time-averaged normalized SAR values using Equation (7a), (7b) and (7c), and plotted below to demonstrate that the time-averaged normalized SAR versus time does not exceed the FCC limit of 1.0 unit. Equation (7a) is used to convert the Tx power of device to obtain 100s-averaged normalized SAR in LTE Band 25 as shown in black curve. Similarly, equation (7b) is used to obtain 60s-averaged normalized SAR in LTE Band 48 as shown in orange curve. Equation (7c) is used to obtain total time-averaged normalized SAR as shown in green curve (i.e., sum of black and orange curves).

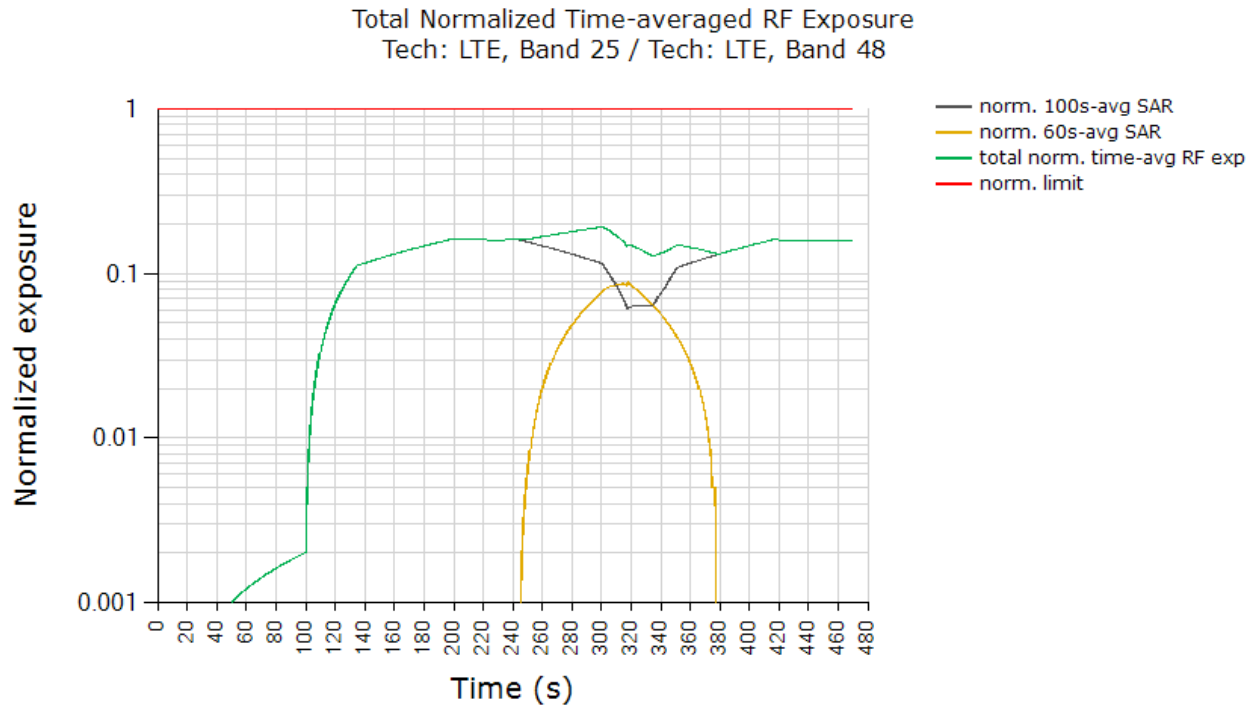

	(W/kg)
FCC normalized total exposure limit	1.0
Max 100s-time averaged normalized SAR (green curve)	0.192
Validated	

Plot Notes: Maximum power is requested by callbox for the entire duration of the test, with tech/band switches from 100s-to-60s window at ~245s time stamp, and from 60s-to-100s window at ~318s time stamp. Smart Transmit controls the Tx power during these time-window switches to ensure total time-averaged RF exposure, i.e., sum of black and orange curves given by equation (7c), is always compliant. In time-window switch test, at all times the total time-averaged normalized RF exposure (green curve) should not exceed normalized SAR_{design target} + 1.0 dB device uncertainty. In this test, with a maximum normalized SAR of 0.192 being ≤ 0.79 (=1.0/1.6 + 1.0 dB device uncertainty), the above test result validated the continuity of power limiting in time=window switch scenario.

Test case.2) Test result for change in time-window (from 60s to 100s to 60s):

Plot 1 : Measured Tx power (dBm) versus time shows that the transmitting power changed when LTE Band 48 (60s window) switches to LTE Band 25 (100s window) and switches back to LTE Band 48 (60s window).

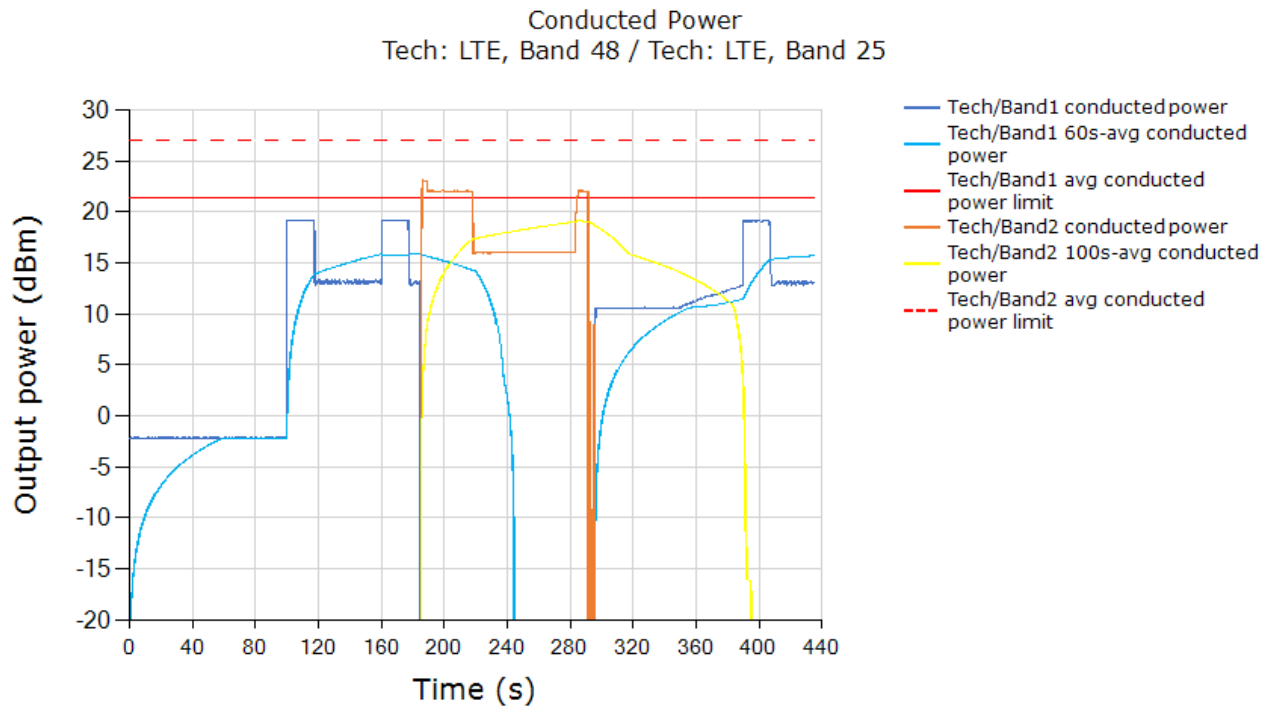

Plot Notes : *Reserve_power_margin* = 3dB according to the manufacturer,

P_{limit} = 21.0 dBm for LTE Band 25, and P_{limit} = 17.0 dBm for LTE Band 48 according to Table 5.1. The conducted power plot shows expected transitions in Tx power at ~194 seconds (60s-to-100s transition) and at ~297 seconds (100s-to-60s transition) in order to maintain total time-averaged RF exposure compliance across time windows, as show in next plot.

Plot 2: All the conducted Tx power measurement results were converted into time-averaged normalized SAR values using Equation (7a), (7b) and (7c), and plotted below to demonstrate that the time-averaged normalized SAR versus time does not exceed the FCC limit of 1.0 unit. Equation (7a) is used to convert the Tx power of device to obtain 60s-averaged normalized SAR in LTE Band 48 as shown in black curve. Similarly, equation (7b) is used to obtain 100s-averaged normalized SAR in LTE Band 71 as shown in orange curve. Equation (7c) is used to obtain total time-averaged normalized SAR as shown in green curve (i.e., sum of black and orange curves).

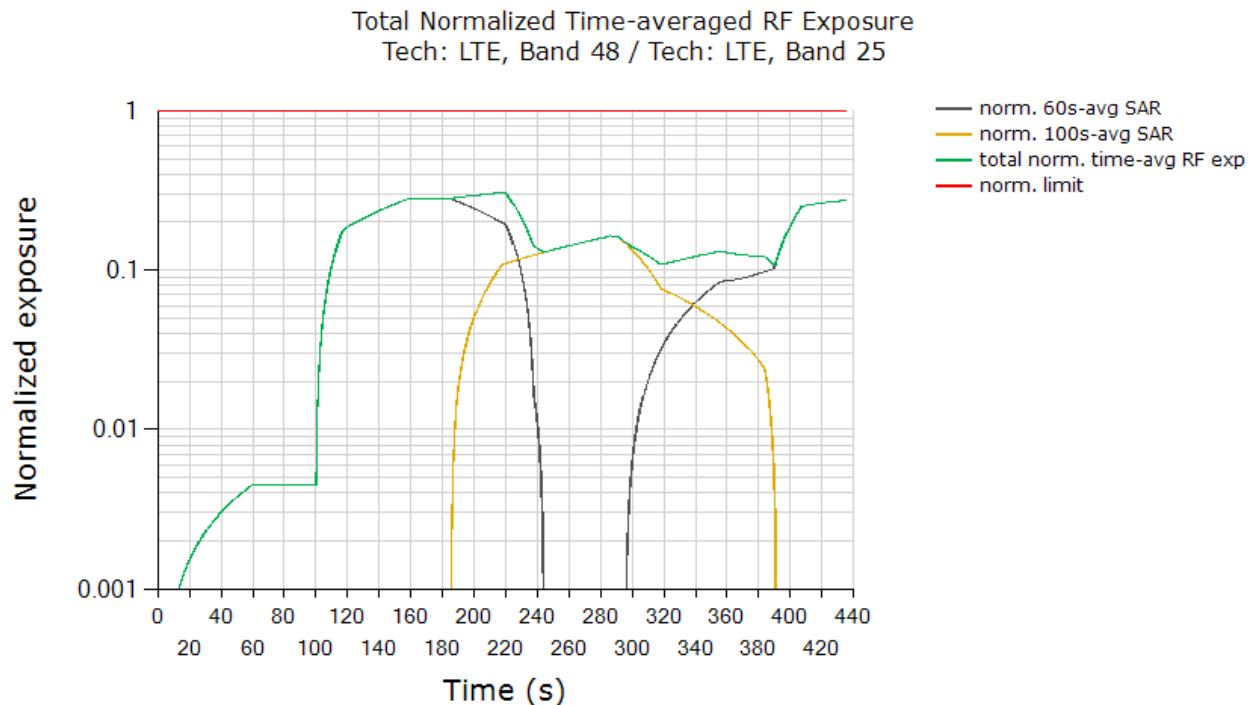

	(W/kg)
FCC normalized total exposure limit	1.0
Max 100s-time averaged normalized SAR (green curve)	0.306
Validated	

Plot Notes: Maximum power is requested by callbox for the entire duration of the test, with tech/band switches from 60s-to-100s window at ~245s time stamp, and from 100s-to-60s window at ~330s time stamp. Smart Transmit controls the Tx power during these time-window switches to ensure total time-averaged RF exposure, i.e., sum of black and orange curves given by equation (7c), is always compliant. In time-window switch test, at all times the total time-averaged normalized RF exposure (green curve) should not exceed normalized SAR_{design_target} + 1.0 dB device uncertainty. In this test, with a maximum normalized SAR of 0.306 being $\leq 0.79 (=1.0/1.6 + 1.0 \text{ dB device uncertainty})$, the above test result validated the continuity of power limiting in time=window switch scenario.

5.7 Change in DSI test results (test case 11 in Table 5-2)

This test was conducted with callbox requesting maximum power, and with DSI switch from LTE Band 7 DSI = 3 to DSI = 0. Following procedure detailed in Section 3.3.5 using the measurement setup shown in Figure B-1(d), the DSI switch was performed when the EUT is transmitting at $P_{reserve}$ level as shown in the plot below (dotted black circle).

Test result for change in DSI:

Plot 1 : Measured Tx power (dBm) versus time shows that the transmitting power changed when DSI = 3 switches to DSI = 0:

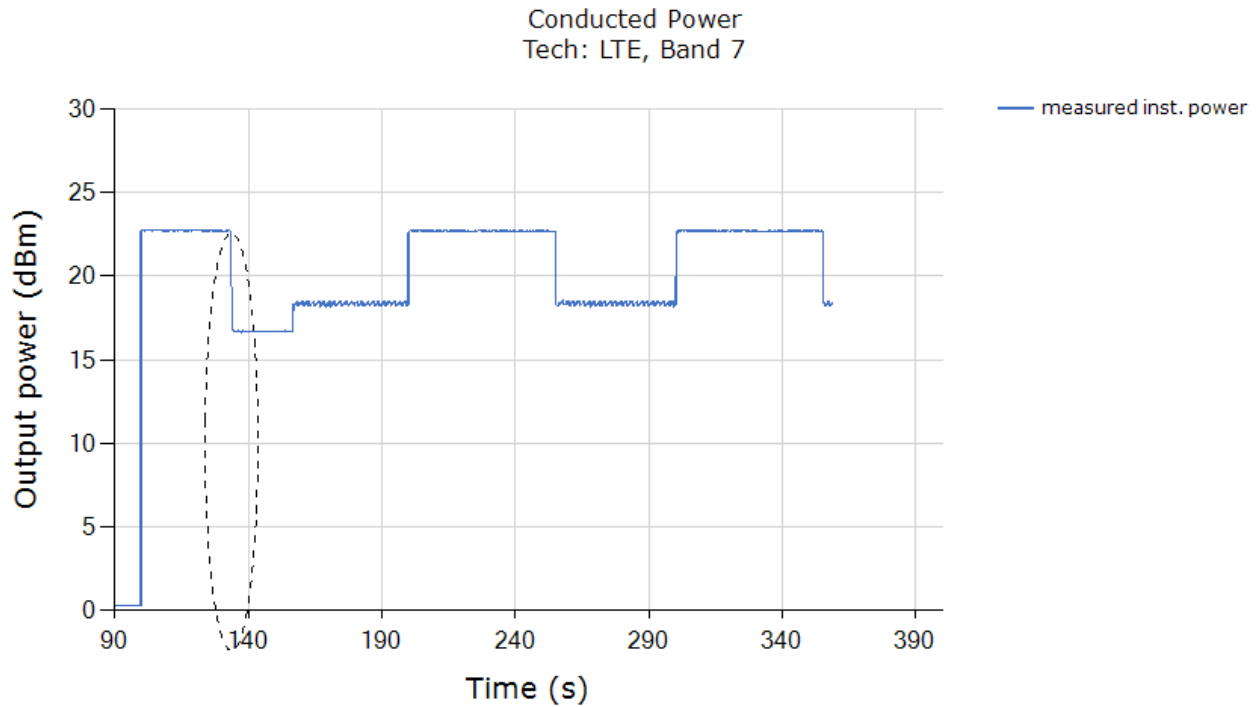

Plot Notes : $Reserve_power_margin = 3\text{dB}$ according to the manufacturer,
 $P_{limit} = 20.5\text{ dBm}$ for DSI = 3, and $P_{limit} = 22.0\text{ dBm}$ for DSI = 0 according to Table 5.1.

Plot 2: All the time-averaged conducted Tx power measurement results were converted into time-averaged normalized SAR values using Equation (6a), (6b) and (6c), and plotted below to demonstrate that the time-average normalized SAR versus time does not exceed the normalized FCC limit of 1.0 unit.

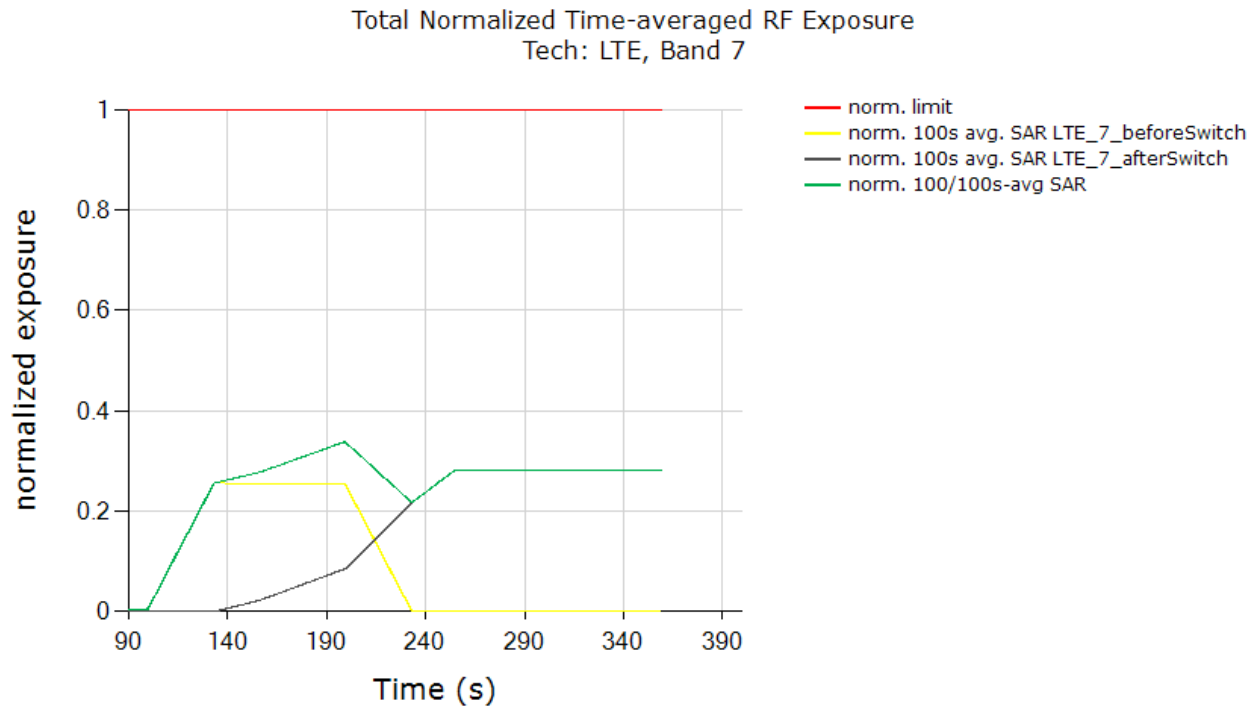

	(W/kg)
FCC normalized SAR limit	1.0
Max 60s-time averaged normalized SAR (green curve)	0.339
Validated	

The test result validated the continuity of power limiting in DSI scenario.

5.8 Switch in SAR exposure test results (test case 12 in Table 5-2)

This test was conducted with callbox requesting maximum power, and with the EUT in LTE Band 12 + Sub6 NR Band n25 call. Following procedure detailed in Section 3.3.7 and Section B.2, and using the Measurement setup shown in Figure B-1(d) since LTE and Sub6 NR are sharing the same antenna port, the SAR exposure switch measurement is performed with the EUT in various SAR exposure scenarios,

Plot 1: SAR_{sub6NR} only scenario (t = 0s ~ 120s), SAR_{sub6NR} + SAR_{LTE} scenario (t =120s ~240s) and SAR_{LTE} only scenario (t > 240s).

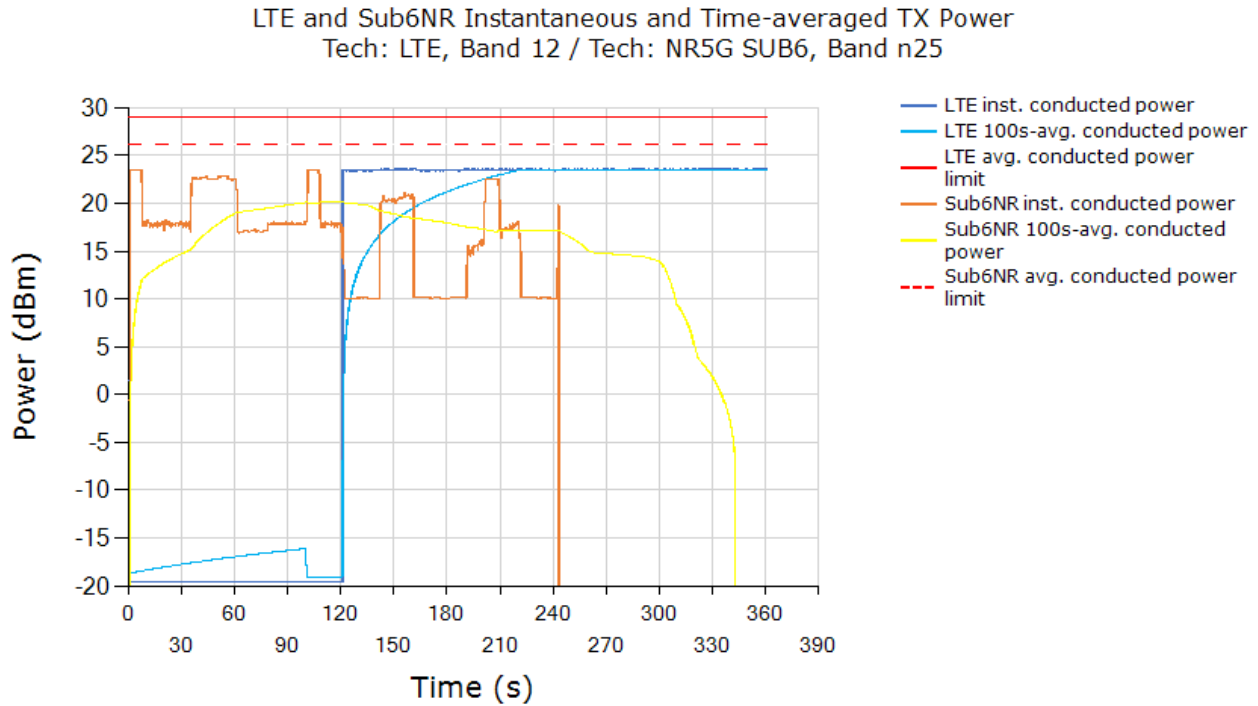

Plot 2: All the conducted Tx power measurement results were converted into time-averaged normalized SAR values using Equation (7a), (7b) and (7c), and plotted below to demonstrate that the time-averaged normalized SAR versus time does not exceed the FCC limit of 1.0 unit. Equation (7a) is used to convert the LTE Tx power of device to obtain 100s-averaged normalized SAR in LTE Band 66 as show in black curve. Similarly, equation (7b) is used to obtain 100s-averaged normalized SAR in Sub6 NR Band n71 as shown in orange curve. Equation (7c) is used to obtain total time-averaged normalized SAR as shown in green curve (i.e., sum of black and orange curves).

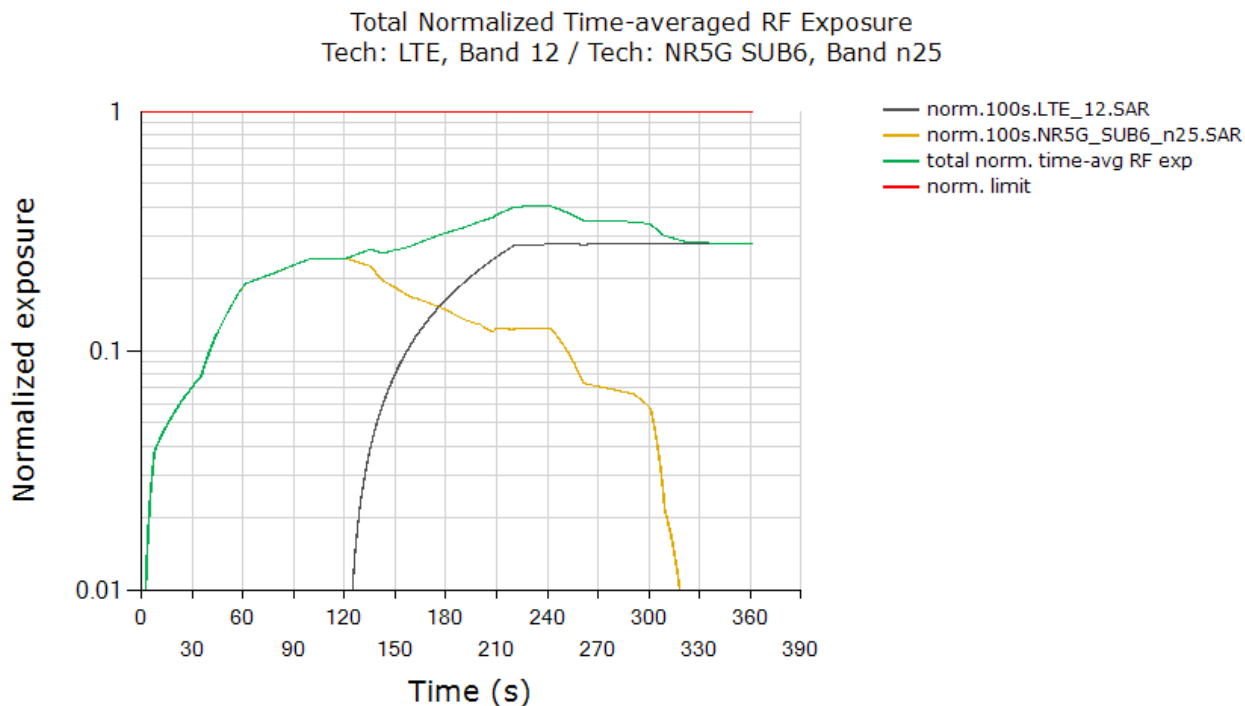

	(W/kg)
FCC normalized total exposure limit	1.0
Max 100s-time averaged normalized SAR (green curve)	0.402
Validated	

Plot Notes: Device starts predominantly in Sub6 NR SAR exposure scenario between 0s and 120s, and LTE SAR + Sub6 NR SAR exposure scenario between 120s and 240s, and in predominantly in LTE SAR exposure scenario after t=240s, Here, Smart Transmit allocates a maximum of 100% of exposure margin for Sub6 NR. This corresponds to a normalized 1gSAR exposure value = 100% * 0.414 W/kg measured SAR at Sub6 NR $P_{limit} / 1.6$ W/kg limit = 0.259 ± 1.0 dB device related uncertainty (see orange curve between 10s~125s). For predominantly LTE SAR exposure scenario, maximum normalized 1gSAR exposure should correspond to 100% exposure margin = 0.549 W/kg measured SAR at LTE $P_{limit} / 1.6$ W/kg limit = 0.343 ± 1.0 dB device related uncertainty (see orange black between after t = 240s). Additionally, in SAR exposure switch test, at all times the total time-averaged normalized RF exposure (green curve) should not exceed normalized $SAR_{design_target} + 1.0$ dB device uncertainty. In this test, with a maximum normalized SAR of 0.402 being ≤ 0.79 (= $1.0/1.6 + 1.0$ dB device uncertainty), the above test result validated the continuity of power limiting in SAR exposure switch scenario.

6 SAR Test Results for Sub-6 Smart Transmit Feature Validation

6.1 Dielectric Property Measurements & System Check

Please detail of explain refer to Sec.8 in SAR part.1 report.

6.1.1 Dielectric Property Measurements

Dielectric Property Measurements Results:

SAR 1 Room

Date	Freq. (MHz)	Liquid Parameters		Measured	Target	Delta (%)	Limit ±(%)	
2022-06-27	Head 1750	e'	38.2000	Relative Permittivity (ϵ_r):	38.20	40.08	-4.70	5
		e"	13.7800	Conductivity (σ):	1.34	1.37	-2.05	5
	Head 1710	e'	38.2600	Relative Permittivity (ϵ_r):	38.26	40.15	-4.70	5
		e"	13.9200	Conductivity (σ):	1.32	1.35	-1.70	5
	Head 1755	e'	38.1900	Relative Permittivity (ϵ_r):	38.19	40.08	-4.71	5
		e"	13.7600	Conductivity (σ):	1.34	1.37	-2.12	5
2022-06-27	Head 1900	e'	38.2200	Relative Permittivity (ϵ_r):	38.22	40.00	-4.45	5
		e"	13.5300	Conductivity (σ):	1.43	1.40	2.10	5
	Head 1850	e'	38.2200	Relative Permittivity (ϵ_r):	38.22	40.00	-4.45	5
		e"	13.6000	Conductivity (σ):	1.40	1.40	-0.07	5
	Head 1910	e'	38.2200	Relative Permittivity (ϵ_r):	38.22	40.00	-4.45	5
		e"	13.5300	Conductivity (σ):	1.44	1.40	2.64	5
2022-06-27	Head 3500	e'	37.1500	Relative Permittivity (ϵ_r):	37.15	37.93	-2.06	5
		e"	14.4200	Conductivity (σ):	2.81	2.91	-3.62	5
	Head 3560	e'	37.0300	Relative Permittivity (ϵ_r):	37.03	37.86	-2.20	5
		e"	14.4400	Conductivity (σ):	2.86	2.97	-3.86	5
	Head 3600	e'	36.9800	Relative Permittivity (ϵ_r):	36.98	37.82	-2.21	5
		e"	14.5000	Conductivity (σ):	2.90	3.01	-3.70	5
	Head 3690	e'	36.8100	Relative Permittivity (ϵ_r):	36.81	37.71	-2.39	5
		e"	14.5100	Conductivity (σ):	2.98	3.11	-4.15	5
	Head 3700	e'	36.8000	Relative Permittivity (ϵ_r):	36.80	37.70	-2.39	5
		e"	14.5300	Conductivity (σ):	2.99	3.12	-4.07	5
2022-06-27	Head 3600	e'	36.9800	Relative Permittivity (ϵ_r):	36.98	37.82	-2.21	5
		e"	14.5000	Conductivity (σ):	2.90	3.01	-3.70	5
	Head 3650	e'	36.9200	Relative Permittivity (ϵ_r):	36.92	37.76	-2.22	5
		e"	14.4800	Conductivity (σ):	2.94	3.07	-4.12	5
	Head 3700	e'	36.8000	Relative Permittivity (ϵ_r):	36.80	37.70	-2.39	5
		e"	14.5300	Conductivity (σ):	2.99	3.12	-4.07	5
	Head 3750	e'	36.7700	Relative Permittivity (ϵ_r):	36.77	37.64	-2.32	5
		e"	14.5500	Conductivity (σ):	3.03	3.17	-4.22	5
	Head 3800	e'	36.6500	Relative Permittivity (ϵ_r):	36.65	37.59	-2.49	5
		e"	14.5700	Conductivity (σ):	3.08	3.22	-4.35	5
2022-06-27	Head 3750	e'	36.7700	Relative Permittivity (ϵ_r):	36.77	37.64	-2.32	5
		e"	14.5500	Conductivity (σ):	3.03	3.17	-4.22	5
	Head 3800	e'	36.6500	Relative Permittivity (ϵ_r):	36.65	37.59	-2.49	5
		e"	14.5700	Conductivity (σ):	3.08	3.22	-4.35	5
	Head 3900	e'	36.4800	Relative Permittivity (ϵ_r):	36.48	37.47	-2.65	5
		e"	14.6300	Conductivity (σ):	3.17	3.32	-4.47	5
	Head 3930	e'	36.3900	Relative Permittivity (ϵ_r):	36.39	37.44	-2.80	5
		e"	14.6500	Conductivity (σ):	3.20	3.35	-4.48	5
	Head 3950	e'	36.3600	Relative Permittivity (ϵ_r):	36.36	37.42	-2.82	5
		e"	14.6700	Conductivity (σ):	3.22	3.37	-4.45	5

6.1.2 SAR system check

Reference Target SAR Values

The reference SAR values can be obtained from the calibration certificate of system validation dipoles.

System Dipole	Serial No.	Cal. Date	Cal. Due.Date	Freq. (MHz)	Target SAR Values (W/kg)	
					1g/10g	Head
D1750V2	1125	2022-02-24	2023-02-24	1750	1g	36.80
					10g	19.40
D1900V2	5d190	2020-11-24	2022-11-24	1900	1g	40.10
					10g	20.70
D3500V2	1121	2021-04-21	2023-04-21	3500	1g	66.30
					10g	25.00
D3700V2	1036	2021-05-21	2023-05-21	3700	1g	67.90
					10g	24.30
D3900V2	1069	2021-04-21	2023-04-21	3900	1g	70.10
					10g	24.30

System Check Results

The 1-g and 10-g SAR measured with a reference dipole, using the required tissue-equivalent medium at the test frequency, must be within 10% of the manufacturer calibrated dipole SAR target.

SAR 5 Room

Date Tested	System Dipole		T.S. Liquid	Measured Results		Target (Ref. Value)	Delta $\pm 10\%$	
	Type	Serial #		Zoom Scan to 100 mW	Normalize to 1 W			
2022-06-27	D1750V2	1125	Head	1g	3.89	38.9	36.80	5.71
				10g	2.06	20.6	19.40	6.19
2022-06-27	D1900V2	5d190	Head	1g	4.11	41.1	40.10	2.49
				10g	2.11	21.1	20.70	1.93
2022-06-27	D3500V2	1121	Head	1g	6.67	66.7	66.30	0.60
				10g	2.58	25.8	25.00	3.20
2022-06-27	D3700V2	1036	Head	1g	6.66	66.6	67.90	-1.91
				10g	2.51	25.1	24.30	3.29
2022-06-27	D3900V2	1069	Head	1g	7.19	71.9	70.10	2.57
				10g	2.57	25.7	24.30	5.76

6.2 Measurement setup

This measurement setup is similar to normal SAR measurements. The difference in SAR measurement setup for time averaging feature validation is that the callbox is signaling in close loop power control mode (instead of requesting maximum power in open loop control mode) and callbox is connected to the PC using GPIB so that the test script executed on PC can send GPIB commands to control the callbox's requested power over time (test sequence). The same test script used in conducted setup for time-varying Tx power measurements is also used in this section for running the test sequences during SAR measurements, and the recorded values from the disconnected power meter by the test script were discarded.

As mentioned in Section 3.4, for EUT to follow TPC command sent from the callbox wirelessly, the "path loss" between callbox antenna and the EUT needs to be very well calibrated. Since the SAR chamber is in uncontrolled environment, precautions must be taken to minimize the environmental influences on "path loss". Similarly, in the case of time-varying SAR measurements in Sub6 NR (with LTE as anchor), "path loss" between callbox antenna and the EUT needs to be carefully calibrated for both LTE link as well as for Sub6 NR link.

The EUT is placed in Worst-case position against flat section of SAM Twin phantom as shown in Appendix A.

6.3 SAR measurement results for time-varying Tx power transmission scenario

Following Section 3.4 procedure, time-averaged SAR measurements are conducted using EX3DV4 probe at peak location of area scan over 500 seconds. cDASY6 system validation for SAR measurement is provided in Section 7.1, and the associated SPEAG certificates are attached in Appendix E(Probes) & F(Dipoles) in SAR part 1 report. SAR probe integration times depend on the communication signal being tested. Integration times used by SPEAG for their probe calibrations can be downloaded from here (integration time is listed on the bottom of the first page for each tech):

http://www.speag.com/assets/downloads/services/cs/UIDSummary_171205.pdf

Since the sampling rate used by cDASY6 for pointSAR measurements is not in user control, the number of points in 100s or 60s interval is determined from the scan duration setting in cDASY6 time-average pointSAR measurement by (100s or 60s / cDASY6_scan_duration * total number of pointSAR values recorded). Running average is performed over these number of points in excel spreadsheet to obtain 100s-/60s-averaged pointSAR.

Following Section 3.4, for each of selected technology/band (listed in Table 5-2):

1. With *Reserve_power_margin* set to 0 dB, area scan is performed at P_{limit} and time-averaged pointSAR measurements are conducted to determine the pointSAR at P_{limit} at peak location, denoted as $pointSAR_{P_{limit}}$.
2. With *Reserve_power_margin* set to actual (intended) value, two more time-averaged pointSAR measurements are performed at the same peak location for test sequences 1 and 2. To demonstrate compliance, all the pointSAR measurement results were converted into 1gSAR or 10gSAR values by using Equation (3a), rewritten below:

$$1g_or_10gSAR(t) = \frac{pointSAR(t)}{pointSAR_{P_{limit}}} * 1g_or_10gSAR_{P_{limit}} \quad (3a)$$

Where, $pointSAR(t)$, $pointSAR_{P_{limit}}$, and $1g_or_10gSAR_{P_{limit}}$ correspond to the measured instantaneous point SAR, measured point SAR at P_{limit} from above step 1 and 2, and measured 1gSAR or 10gSAR values at P_{limit} obtained from Part 1 report and listed in Table 5-2 in Section 5.1 of this report.

6.3.1 GSM 1900

Test result for test sequence 1:

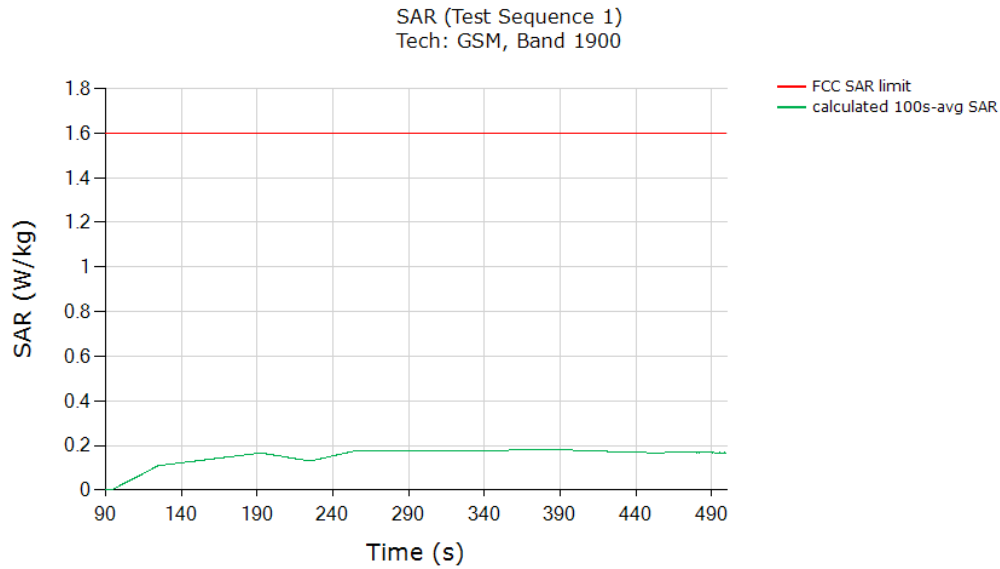

Test result for test sequence 2:

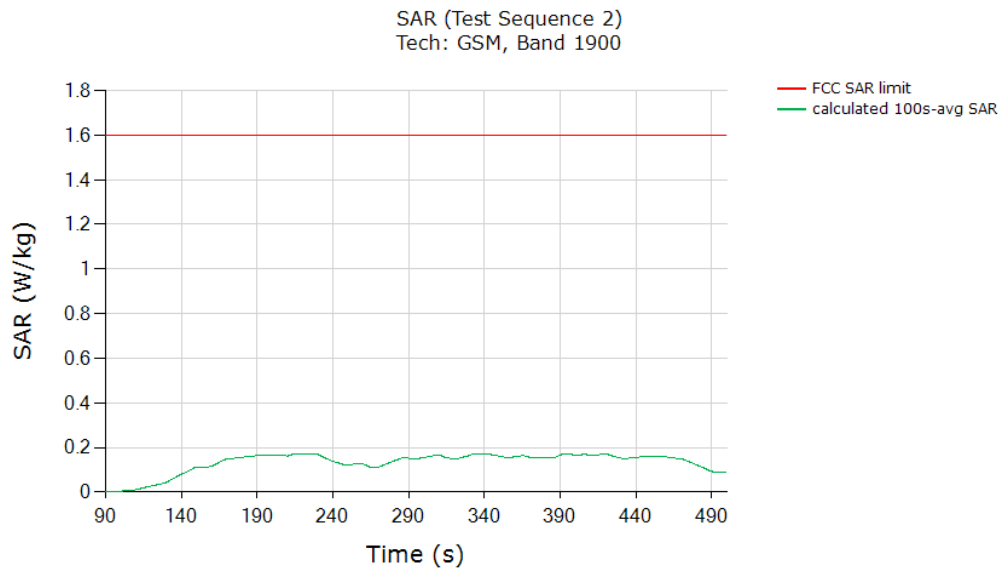

	Test sequence 1	Test sequence 2
	(W/kg)	(W/kg)
FCC 1gSAR limit	1.6	1.6
Max 100s-time averaged 1gSAR (green curve)	0.181	0.172
Validated : Max time averaged SAR (green curve) is within 1 dB device uncertainty of measured SAR at P_{limit} (Table 5-2).		

6.3.2 WCDMA Band II

Test result for test sequence 1:

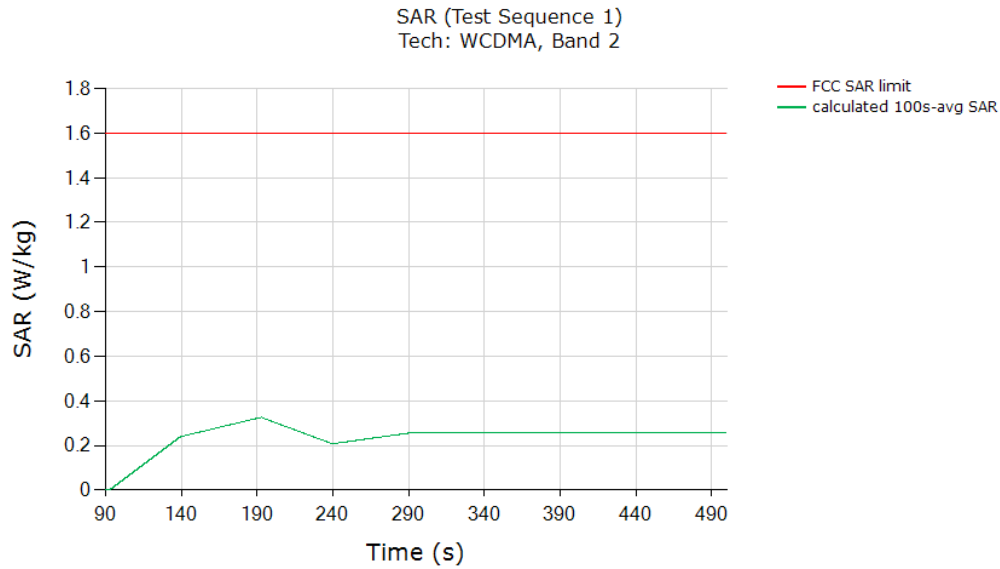

Test result for test sequence 2:

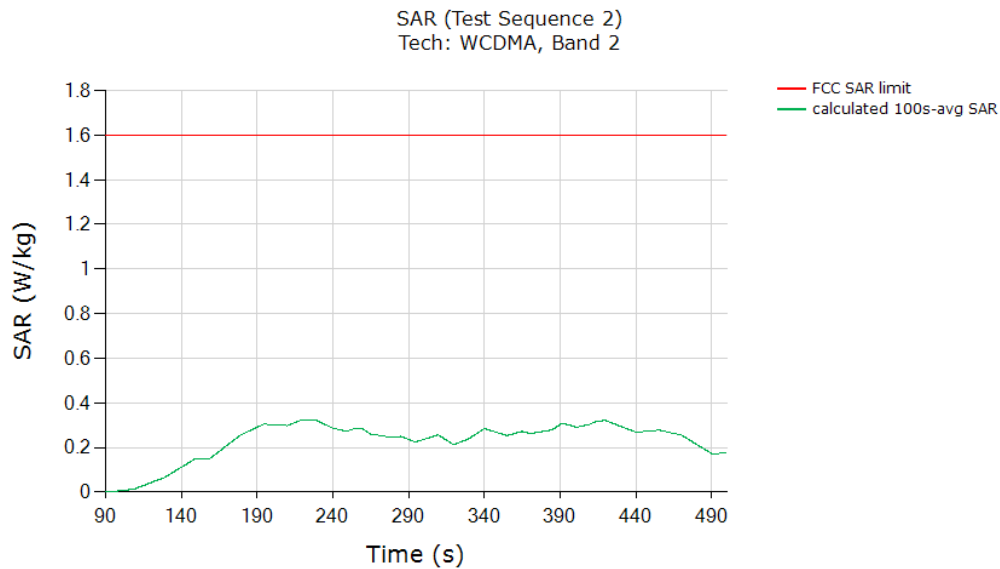

	Test sequence 1	Test sequence 2
	(W/kg)	(W/kg)
FCC 1gSAR limit	1.6	1.6
Max 100s-time averaged 1gSAR (green curve)	0.326	0.321
Validated : Max time averaged SAR (green curve) is within 1 dB device uncertainty of measured SAR at P_{limit} (Table 5-2).		

6.3.3 WCDMA Band IV

Test result for test sequence 1:

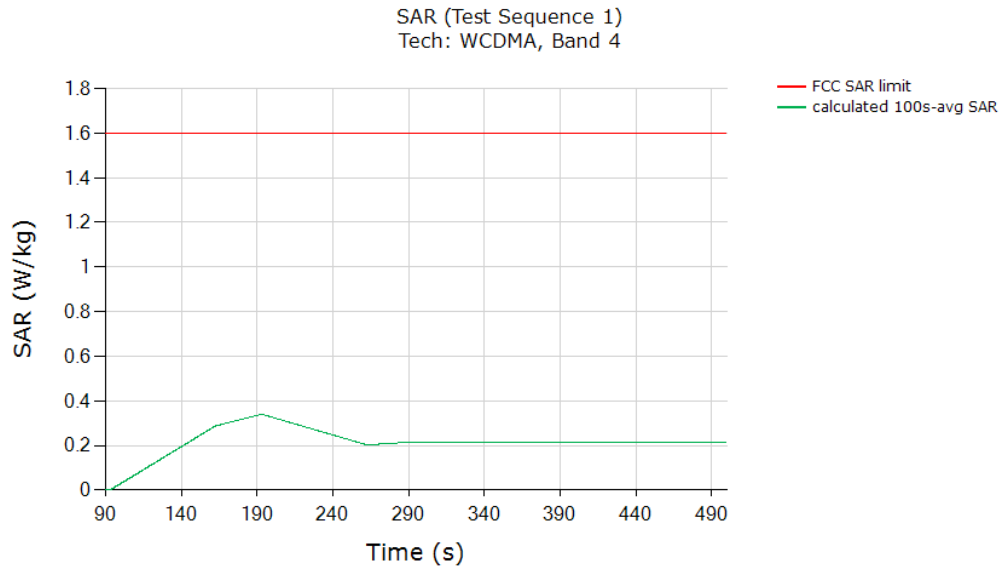

Test result for test sequence 2:

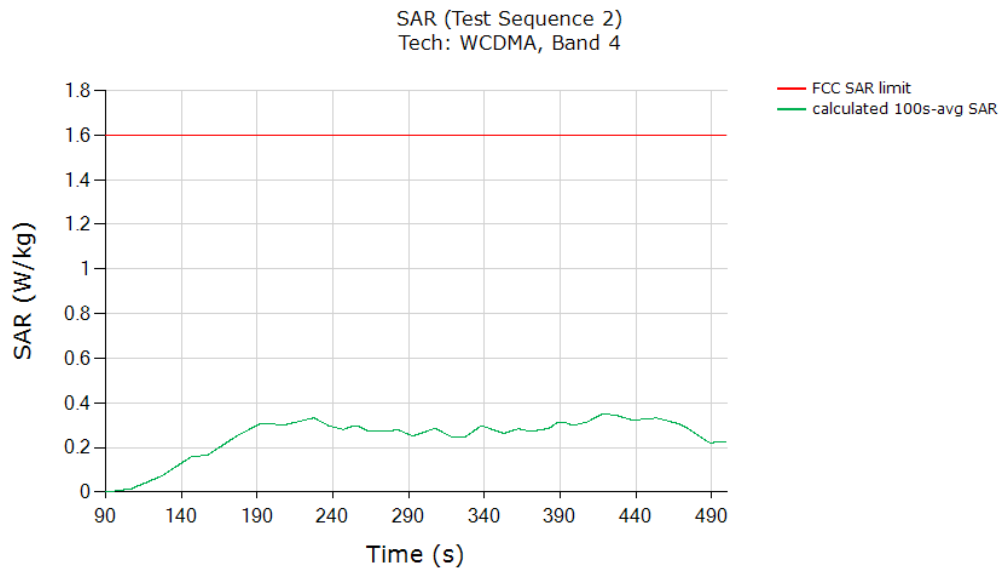

	Test sequence 1	Test sequence 2
	(W/kg)	(W/kg)
FCC 1gSAR limit	1.6	1.6
Max 100s-time averaged 1gSAR (green curve)	0.339	0.350
Validated : Max time averaged SAR (green curve) is within 1 dB device uncertainty of measured SAR at P_{limit} (Table 5-2).		

6.3.4 LTE Band 25

Test result for test sequence 1:

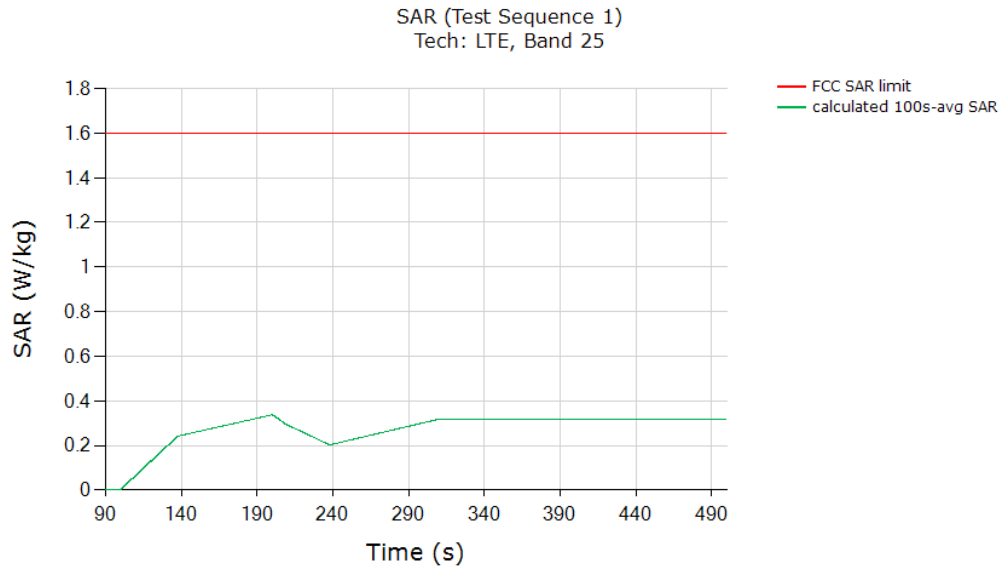

Test result for test sequence 2:

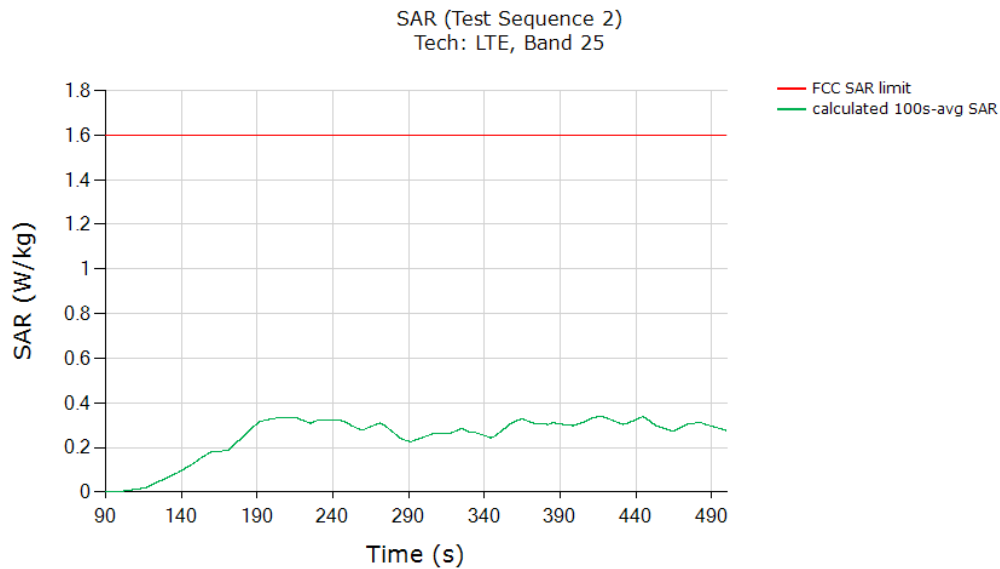

	Test sequence 1	Test sequence 2
	(W/kg)	(W/kg)
FCC 1gSAR limit	1.6	1.6
Max 100s-time averaged 1gSAR (green curve)	0.338	0.339
Validated : Max time averaged SAR (green curve) is within 1 dB device uncertainty of measured SAR at P_{limit} (Table 5-2).		

6.3.5 LTE Band 48

Test result for test sequence 1:

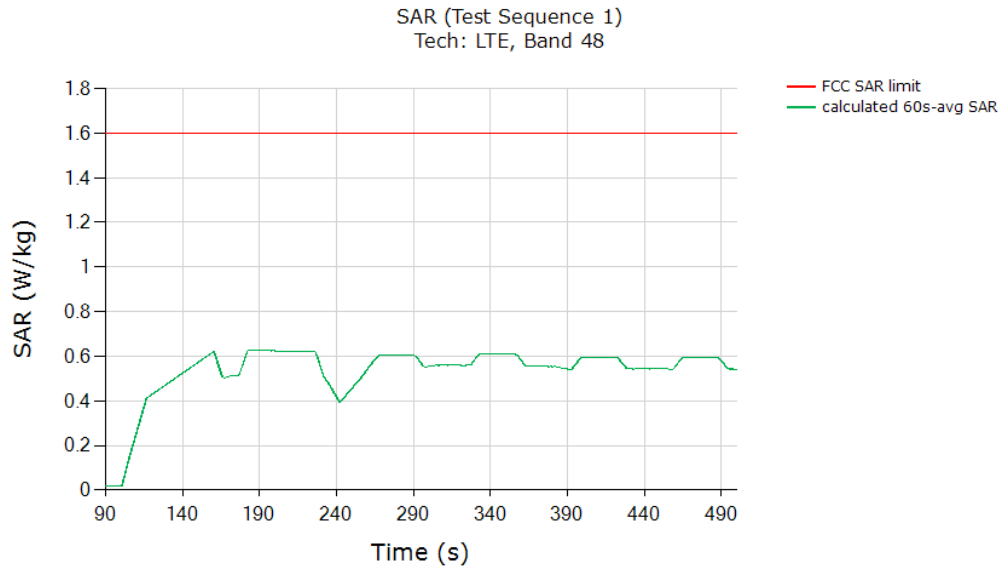

Test result for test sequence 2:

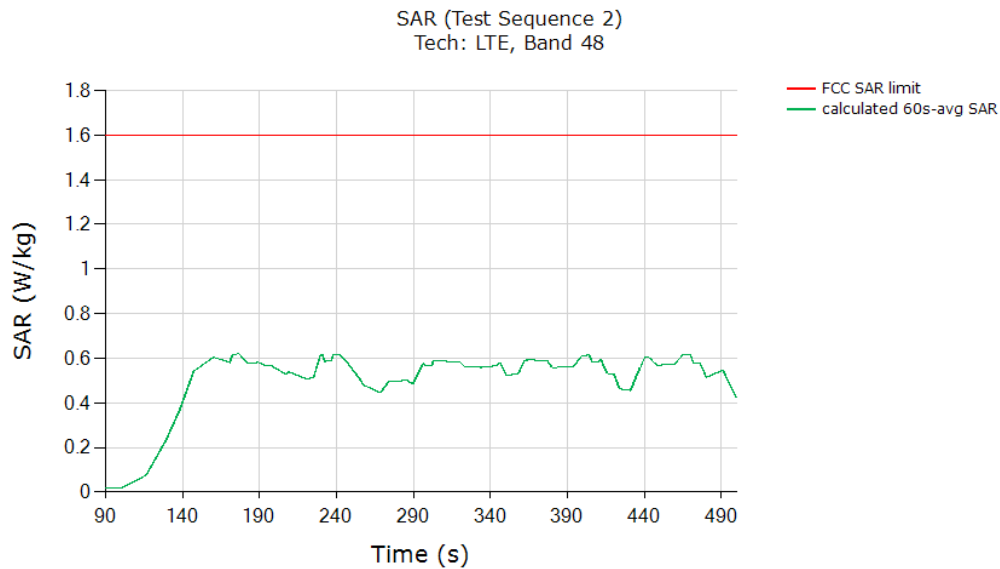

	Test sequence 1	Test sequence 2
	(W/kg)	(W/kg)
FCC 1gSAR limit	1.6	1.6
Max 100s-time averaged 1gSAR (green curve)	0.626	0.620
Validated : Max time averaged SAR (green curve) is within 1 dB device uncertainty of measured SAR at P_{limit} (Table 5-2).		

6.3.6 NR Band n70

Test result for test sequence 1:

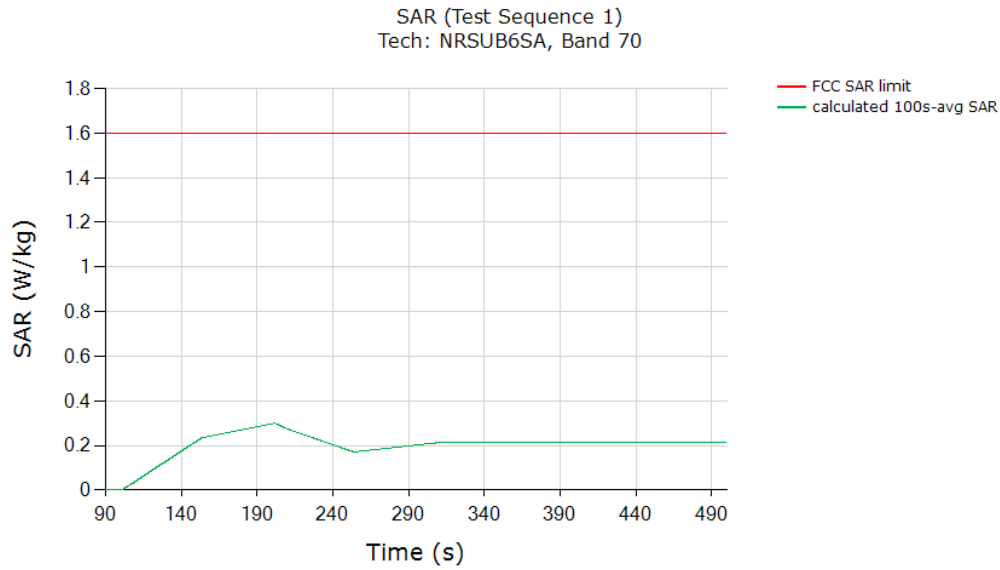

Test result for test sequence 2:

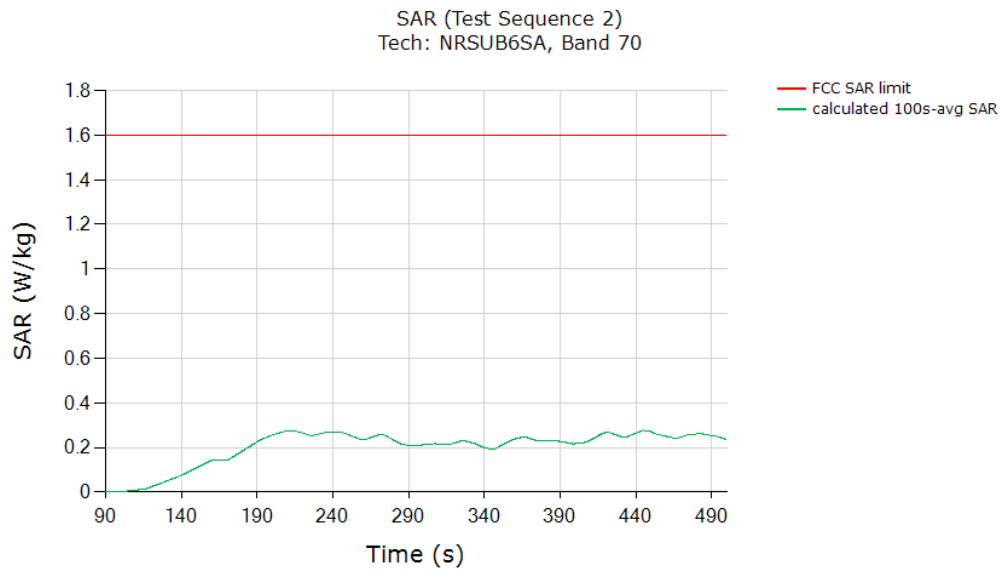

	Test sequence 1	Test sequence 2
	(W/kg)	(W/kg)
FCC 1gSAR limit	1.6	1.6
Max 60s-time averaged 1gSAR (green curve)	0.300	0.276
Validated : Max time averaged SAR (green curve) is within 1 dB device uncertainty of measured SAR at P_{limit} (Table 5-2).		

6.3.7 NR Band n77

Test result for test sequence 1:

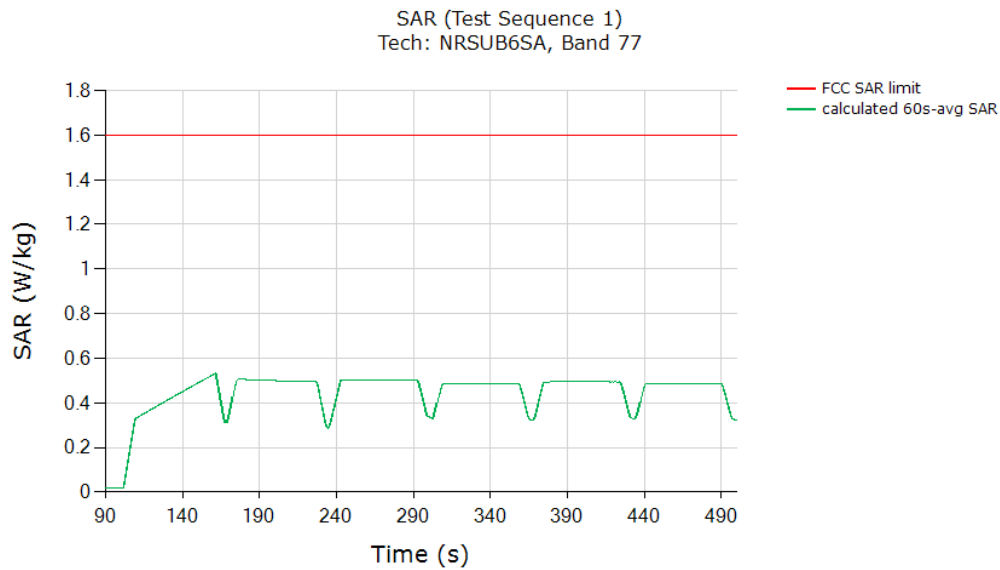

Test result for test sequence 2:

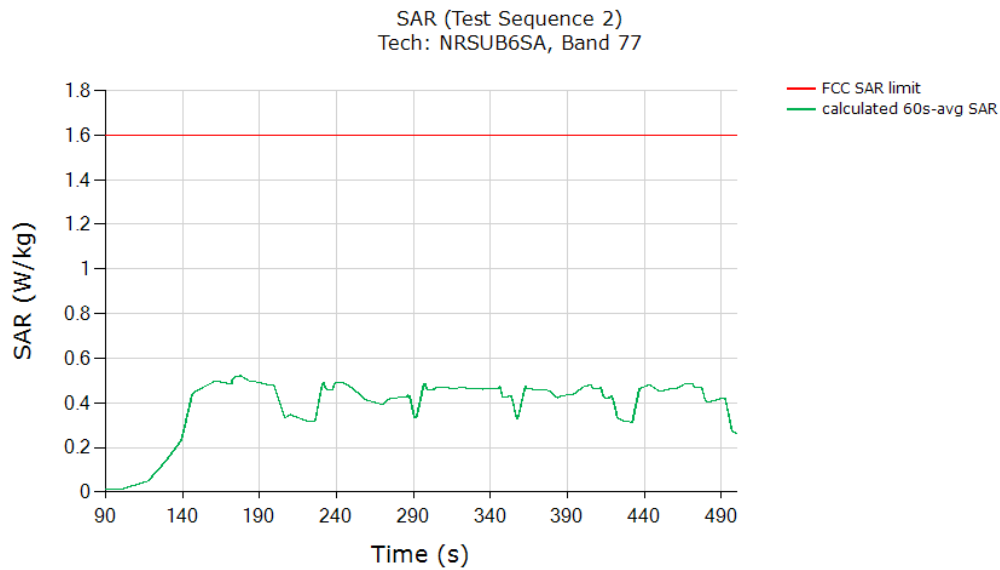

	Test sequence 1	Test sequence 2
	(W/kg)	(W/kg)
FCC 1gSAR limit	1.6	1.6
Max 60s-time averaged 1gSAR (green curve)	0.533	0.521
Validated : Max time averaged SAR (green curve) is within 1 dB device uncertainty of measured SAR at P_{limit} (Table 5-2).		

7 Test Equipment

The measuring equipment used to perform the tests documented in this report has been calibrated in accordance with the manufacturers' recommendations, and is traceable to recognized national standards.

Conducted test

System Check

Name of Equipment	Manufacturer	Type/Model	Serial No.	Cal. Due Date
Power Sensor	ROHDE & SCHWARZ	NRP8S	104520	8-4-2022
Power Sensor	ROHDE & SCHWARZ	NRP8S	104521	8-4-2022
Directional Coupler	NARDA	4216-10	02835	8-3-2022
Directional Coupler	NARDA	4216-10	02836	8-3-2022
Power Divider	Weinschel	WA1575-1313	N/A	8-4-2022

Others

Name of Equipment	Manufacturer	Type/Model	Serial No.	Cal. Due Date
Base Station Simulator	R & S	CMW500	169797	8-3-2022
UXM 5G Wireless Test Platform	Keysight	E7515B	MY59150850	12-13-2022

SAR test

Dielectric Property Measurements

Name of Equipment	Manufacturer	Type/Model	Serial No.	Cal. Due Date
Network Analyzer	Agilent	E5071C	MY46522054	8-6-2022
Dielectric Assessment Kit	SPEAG	DAK-3.5	1196	7-21-2022
Dielectric Assessment Kit	SPEAG	DAK-3.5	1158	10-20-2022
Dielectric Assessment Kit	SPEAG	DAKS_VNA R140	0050221	4-22-2023
Shorting block	SPEAG	DAK-3.5 Short	SM DAK 200 BA	N/A
Thermometer	LKM	DTM3000	3851	8-4-2022

System Check

Name of Equipment	Manufacturer	Type/Model	Serial No.	Cal. Due Date
MXG Analog Signal Generator	Agilent	N5181A	MY50145882	8-4-2022
Power Sensor	Keysight	U2000A	MY60180020	8-4-2022
Power Sensor	Agilent	U2000A	MY54260007	8-4-2022
Power Sensor	Agilent	U2000A	MY54260010	8-4-2022
Power Amplifier	EXODUS	1410025-AMP2027-10003	10003	8-4-2022
Power Amplifier	EXODUS	AMP2027ADB	10002	8-4-2022
Directional Coupler	Agilent	772D	MY52180193	8-3-2022
Directional Coupler	HP	778D	16133	8-3-2022
Low Pass Filter	FILTRON	L14012FL	1410003S	8-3-2022
Low Pass Filter	MICROLAB	LA-60N	3942	8-3-2022
Attenuator	KEYSIGHT	8491B/003	VE2017A0283	8-4-2022
Attenuator	KEYSIGHT	8491B/010	MY39271981	8-4-2022
Attenuator	KEYSIGHT	8491B/010	MY39272011	8-4-2022
Attenuator	KEYSIGHT	8491B/020	MY39271973	8-4-2022
E-Field Probe (SAR1)	SPEAG	EX3DV4	7376	7-30-2022
Data Acquisition Electronics	SPEAG	DAE4	1591	3-24-2023
System Validation Dipole	SPEAG	D1750V2	1125	2-24-2023
System Validation Dipole	SPEAG	D1900V2	5d190	11-24-2022
System Validation Dipole	SPEAG	D3500V2	1121	4-21-2023
System Validation Dipole	SPEAG	D3700V2	1036	5-21-2023
System Validation Dipole	SPEAG	D3900V2	1069	4-21-2023
Thermometer (SAR1)	Lutron	MHB-382SD	AH.91463	8-4-2022

Others

Name of Equipment	Manufacturer	Type/Model	Serial No.	Cal. Due Date
Base Station Simulator	R & S	CMW500	169797	8-3-2022
UXM 5G Wireless Test Platform	Keysight	E7515B	MY58460570	12-13-2022

8 Measurement Uncertainty

8.1 SAR

Per KDB 865664 D01 SAR Measurement 100 MHz to 6 GHz, when the highest measured 1-g SAR within a frequency band is < 1.5 W/kg and the measured 10-g SAR within a frequency band is < 3.75 W/kg. The expanded SAR measurement uncertainty must be $\leq 30\%$, for a confidence interval of $k = 2$. If these conditions are met, extensive SAR measurement uncertainty analysis described in IEEE Std 1528-2013 is not required in SAR reports submitted for equipment approval.

9 Conclusions

Qualcomm Smart Transmit feature employed in Samsung device (FCC ID: A3LSMA236U) has been validated through the conducted power measurement (as demonstrated in Section 5), as well as SAR measurement (as demonstrated in chapters 6).

As demonstrated in this report, the power limiting enforcement is effective and the total normalized time-averaged RF exposure does not exceed 1.0 for all the transmission scenarios described in Section 2. Therefore, the EUT complies with FCC RF exposure requirement.

Section A. Test Sequences

1. Test sequence is generated based on below parameters of the EUT:
 - a. Measured maximum power (P_{max})
 - b. Measured Tx_power_at_SAR_design_target (P_{limit})
 - c. Reserve_power_margin (dB)
 - $P_{reserve}$ (dBm) = measured P_{limit} (dBm) – Reserve_power_margin (dB)
 - d. SAR_time_window (100s for FCC)
2. **Test Sequence 1** Waveform:

Based on the parameter above, the Test Sequence 1 is generated with one transmission between high and low Tx powers. Here, high power = P_{max} ; low power = $P_{max}/2$, and the transition occurs after 80 seconds at high power P_{max} . As long as the power enforcement is taking into effective during one 100s/60s time window, the validation test with this defined test sequence 1 is valid, otherwise, select other radio configuration (band/DSI within the same technology group) having lower P_{limit} for this test. The test sequence 1 waveform is shown below:

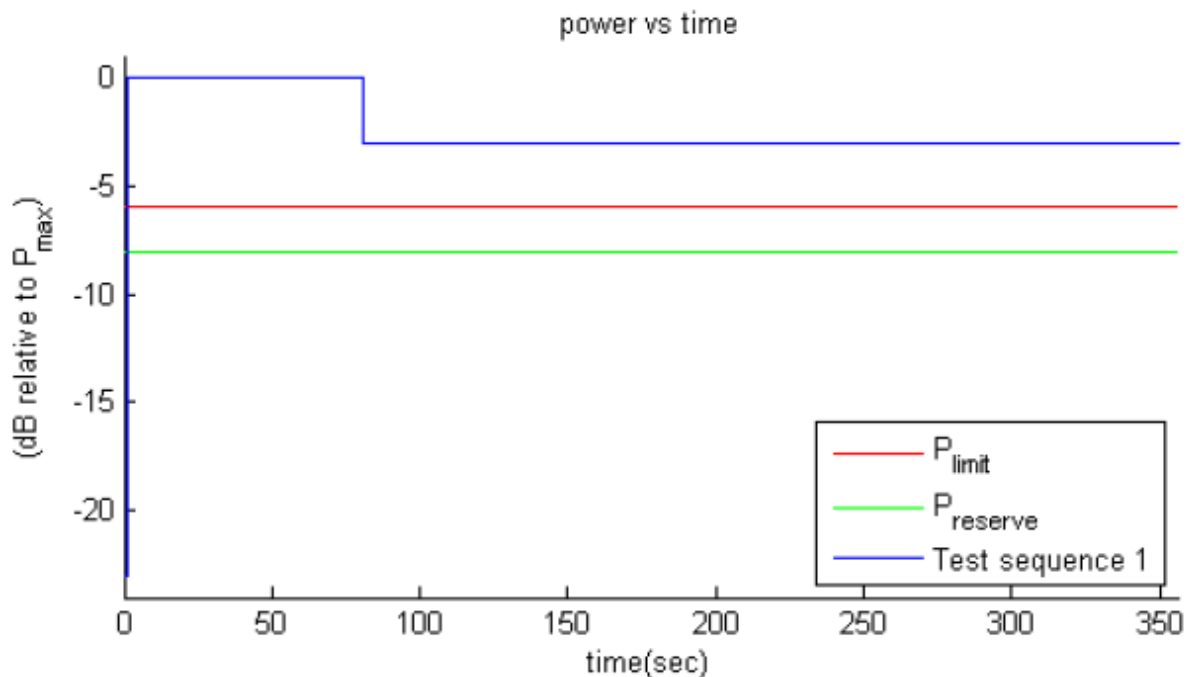

Figure A-1: Test sequence 1 waveform

3. **Test Sequence 2** Waveform:

Based on the parameters in Figure A-1, the Test Sequence 2 is generated as described in Table A-1, which contains two 170 second-long sequences (yellow and green highlighted rows) that are mirrored around the center row of 20s, resulting in a total duration of 360 seconds:

Table A-1: Test sequence 2

Time duration (seconds)	dB relative to P_{limit} or $P_{reserve}$
15	$P_{reserve} - 2$
20	P_{limit}
20	$(P_{limit} + P_{max})/2$ averaged in mW and rounded to nearest 0.1 dB step
10	$P_{reserve} - 6$
20	P_{max}
15	P_{limit}
15	$P_{reserve} - 5$
20	P_{max}
10	$P_{reserve} - 3$
15	P_{limit}
10	$P_{reserve} - 4$
20	$(P_{limit} + P_{max})/2$ averaged in mW and rounded to nearest 0.1 dB step
10	$P_{reserve} - 4$
15	P_{limit}
10	$P_{reserve} - 3$
20	P_{max}
15	$P_{reserve} - 5$
15	P_{limit}
20	P_{max}
10	$P_{reserve} - 6$
20	$(P_{limit} + P_{max})/2$ averaged in mW and rounded to nearest 0.1 dB step
20	P_{limit}
15	$P_{reserve} - 2$

The test Sequence 2 waveform is shown in Figure A-2.

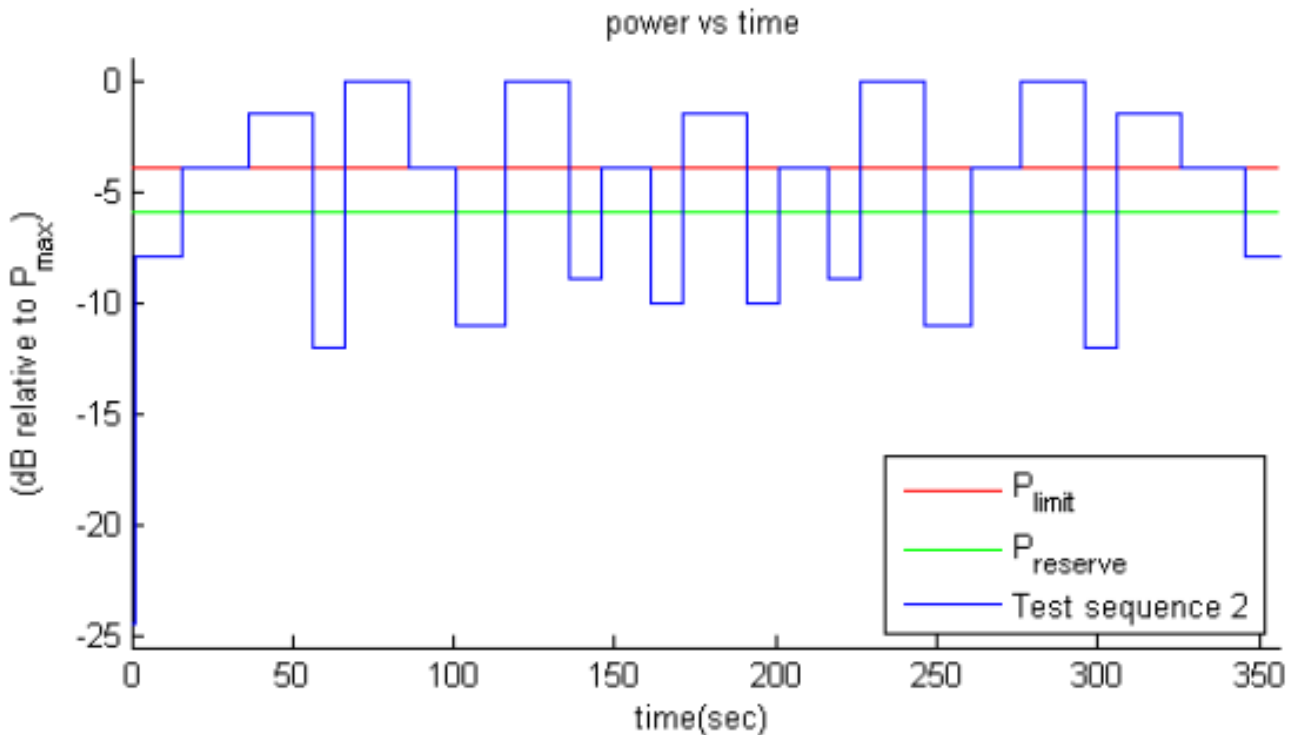

Figure A-2: Test sequence 2 waveform

Section B. Test Procedures for sub6 NR + LTE Radio

Section B provides the test procedures for validating Qualcomm Smart Transmit feature for LTE + Sub6 NR non-standalone (NSA) mode transmission scenario, where sub-6GHz LTE link acts as an anchor, and Sub6 NR standalone mode (SA) transmission scenario.

B.1 Time-varying Tx power test for sub6 NR in NSA mode and SA mode

Follows Section 3.2.1 to select test configurations for time-varying test. This test is performed with two pre-defined test sequences (described in Section 3.1) applied to Sub6 NR (with LTE on all-down bits or low power for the entire test after establishing the LTE + Sub6 NR call with the callbox). Follow the test procedures described in Section 3.3.1 to demonstrate the effectiveness of power limiting enforcement and that the time averaged Tx power of Sub6 NR when converted into 1gSAR values does not exceed the regulatory limit at all times (See Eq. (1a) and (1b)). Sub6 NR response to test sequence 1 and test sequence 2 will be similar to other technologies (say, LTE), and are shown in Sections 6.3.7 and 6.3.8.

B.2 Switch in SAR exposure between LTE vs. Sub6 NR during transmission

This test is to demonstrate that Smart Transmit feature accurately accounts for switching in exposures among SAR for LTE radio only, SAR from both LTE radio and sub6 NR, and SAR from sub6 NR only scenarios, and ensures total time-averaged RF exposure compliance with FCC limit.

Test procedure:

1. Measure conducted Tx power corresponding to P_{limit} for LTE and sub6 NR in selected band. Test condition to measure conducted P_{limit} is:
 - Establish device in call with the callbox for LTE in desired band. Measure conducted Tx power corresponding to LTE P_{limit} with Smart Transmit enable and *Reserve_power_margin* set to 0 dB, callbox set to request maximum power.
 - Repeat above step to measure conducted Tx power corresponding to Sub6 NR P_{limit} . If testing LTE + Sub6 NR in non-standalone mode, then establish LTE + Sub6 NR call with callbox and request all down bits for radio1 LTE. In this scenario, with callbox requesting maximum power from Sub6 NR, measured conducted Tx power corresponds to radio2 P_{limit} (as radio1 LTE is at all-down bits).
2. Set *Reserve_power_margin* to actual (intended) value with EUT setup for LTE_Sub6 NR call. First, establish LTE connection in all-up bits with the callbox, and then Sub6 NR connection is added with callbox requesting UE to transmit at maximum power in Sub6 NR. As soon as the Sub6 NR connection is established, request all-down bits on LTE link (otherwise, Sub6 NR will not have sufficient RF exposure margin to sustain the call with LTE in all-up bits). Continue LTE(all-down bits) + Sub6 NR transmission for more than one time-window duration to test predominantly Sub6 NR SAR exposure scenario (as SAR exposure is negligible from all-down bits in LTE). After at least one time-window, request LTE to go all-up bits to test LTE SAR and Sub6 NR SAR exposure scenario. After at least one more time-window, drop (or request all-down bits) Sub6 NR transmission to test predominantly LTE SAR exposure scenario. Continue the test for at least one more time-window. Record the conducted Tx powers for both LTE and Sub6 NR for the entire duration of this test.

3. Once the measurement is done, extract instantaneous Tx power versus time for both LTE and Sub6 NR links. Similar to technology/band switch test in Section 3.3.3, convert the conducted Tx power for both these radios into 1gSAR value (see Eq. (6a) and (6b)) using corresponding technology/band P_{limit} measured in Step 1, and then perform 100s running average to determine time-averaged 1gSAR versus time as illustrated in Figure A-1. Note that here it is assumed both radios have Tx frequencies < 3GHz, otherwise, 60s running average should be performed for radios having Tx frequency between 3GHz and 6GHz.
4. Make one plot containing: (a) instantaneous Tx power versus time measured in Step 2.
5. Make another plot containing: (a) instantaneous 1gSAR versus time determined in Step 3, (b) computed time-averaged 1gSAR versus time determined in Step 3, and (c) corresponding regulatory $1gSAR_{limit}$ of 1.6 W/kg.

The validation criteria is, at all times, the time-averaged 1gSAR versus time shall not exceed the regulatory $1gSAR_{limit}$ of 1.6 W/kg.

B.3 Switch in SAR exposure between LTE vs. Sub6 NR during transmission

For Sub6 NR TDD test cases, a modified procedure was used due to a limitation of the available test equipment.

Test procedure for Conducted Test Sequences:

1. Measure P_{max} , measure P_{limit} and calculate $P_{reserve}$ (= measured P_{limit} in dBm = $Reserve_power_margin$ in dB) and follow Section 3.1 to generate the test sequences for all the technologies and bands selected in Section 3.2.1. Both test sequence 1 and test sequence 2 are created based on generated Pmax_sequences of the DUT as described below. Test condition to measure P_{max} and P_{limit} is:
 - a. Measure Pmax_online_avg_dBm with Smart Transmit disabled and callbox set to request maximum power.
 - b. Measure Plimit_online_avg_dBm with Smart Transmit enabled and $Reserve_power_margin$ set to 0 dB, callbox set to request maximum power.
 - c. Measure Plimit_ftm_dBm in FTM Mode at 25% Duty Cycle.
 - d. Calculate the DutyCycle_dB = $Plimit_ftm_dBm - Plimit_online_avg_dBm + 6$ dB
 - e. Calculate Pmax_sequence = $Pmax_online_avg_dBm + DutyCycle_dB$
 - f. Calculate Plimit_sequence = $Plimit_online_avg_dBm + DutyCycle_dB$
2. Follow remaining steps in Section 3.3.1 to complete time-varying Tx test cases

For the SAR test cases, the procedure in Section 3.4 applies however the initial area scan as described in section 3.4 step 2) i) is performed with the device in FTM mode.

Appendixes

Refer to separated files for the following appendixes.

4790379967-S1 FCC Report RF exposure_App A_Test setup photos

End OF REPORT