



CERTIFICATION TEST REPORT

Report Number. : 4790379967-E7V2

Applicant : SAMSUNG ELECTRONICS CO., LTD.
129 SAMSUNG-RO, YEONGTONG-GU, SUWON-SI,
GYEONGGI-DO, 16677, KOREA

Model : SM-A236U, SM-A236U1/DS, SM-S236DL

FCC ID : A3LSMA236U

EUT Description : GSM/WCDMA/LTE/5G NR Phone + BT/BLE, DTS/UNII a/b/g/n/ac
and NFC

Test Standard(s) : FCC 47 CFR PART 15 SUBPART C

Date Of Issue:

2022-07-07

Prepared by:

UL Korea, Ltd.

26th floor, 152, Teheran-ro, Gangnam-gu Seoul, 06236, Korea

Suwon Test Site: UL Korea, Ltd. Suwon Laboratory

218 Maeyeong-ro, Yeongtong-gu,
Suwon-si, Gyeonggi-do, 16675, Korea

TEL: (031) 337-9902

FAX: (031) 213-5433



ACCREDITED

Testing Laboratory

TL-637

Revision History

<u>Rev.</u>	<u>Issue Date</u>	<u>Revisions</u>	<u>Revised By</u>
V1	2022-06-24	Initial issue	Dexter(Hyunsik) Yun
V2	2022-07-07	Updated to address TCB's question	Dexter(Hyunsik) Yun

TABLE OF CONTENTS

1. ATTESTATION OF TEST RESULTS	4
2. TEST METHODOLOGY	5
3. FACILITIES AND ACCREDITATION	5
4. CALIBRATION AND UNCERTAINTY	6
4.1. MEASURING INSTRUMENT CALIBRATION.....	6
4.2. SAMPLE CALCULATION.....	6
4.3. MEASUREMENT UNCERTAINTY	6
4.4. DECISION RULE	6
5. EQUIPMENT UNDER TEST.....	7
5.1. DESCRIPTION OF EUT.....	7
5.2. MAXIMUM E-FIELD STRENGTH.....	7
5.3. WORST-CASE CONFIGURATION AND MODE	7
5.4. DESCRIPTION OF TEST SETUP	8
6. 20dB BANDWIDTH	10
7. RADIATED EMISSION TEST RESULTS.....	11
7.1. LIMITS AND PROCEDURE	11
7.1.1. FUNDAMENTAL AND SPURIOUS EMISSIONS (0.15 – 30 MHz)	13
7.1.2. SPURIOUS EMISSION 0.009 TO 30 MHz.....	14
7.1.3. TX SPURIOUS EMISSION 30 TO 1000 MHz	15
7.1.4. FUNDAMENTAL AND SPURIOUS EMISSIONS (0.15 – 30 MHz) [EUT with passive TAG mode]	16
7.1.5. SPURIOUS EMISSION 0.09 TO 30 MHz [EUT with passive TAG mode].....	17
8. AC MAINS LINE CONDUCTED EMISSIONS.....	19
9. FREQUENCY STABILITY	24

1. ATTESTATION OF TEST RESULTS

COMPANY NAME: SAMSUNG ELECTRONICS CO., LTD.
EUT DESCRIPTION: GSM/WCDMA/LTE/5G NR Phone + BT/BLE, DTS/UNII a/b/g/n/ac and NFC
MODEL NUMBER: SM-A236U, SM-A236U1/DS, SM-S236DL
SERIAL NUMBER: R3CT50DASKA, R3CT50DATQX(Radiated),
DATE TESTED: 2022-04-18 ~ 2022-06-24;

APPLICABLE STANDARDS	
STANDARD	TEST RESULTS
CFR 47 Part 15 Subpart C	Pass

UL Korea, Ltd. tested the above equipment in accordance with the requirements set forth in the above standards. All indications of Pass/Fail in this report are opinions expressed by UL Korea, Ltd. based on interpretations and/or observations of test results. Measurement Uncertainties were not taken into account and are published for informational purposes only. The test results show that the equipment tested is capable of demonstrating compliance with the requirements as documented in this report.

Note: The results documented in this report apply only to the tested sample, under the conditions and modes of operation as described herein. This document may not be altered or revised in any way unless done so by UL Korea, Ltd. and all revisions are duly noted in the revisions section. Any alteration of this document not carried out by UL Korea, Ltd. will constitute fraud and shall nullify the document. This report must not be used by the client to claim product certification, approval, or endorsement by IAS, any agency of the Federal Government, or any agency of any government.

Approved & Released For
UL Korea, Ltd. By:



Seokhwan Hong
Suwon Lab Engineer
UL Korea, Ltd.

Tested By:



Dexter(Hyunsik) Yun
Suwon Lab Engineer
UL Korea, Ltd.

2. TEST METHODOLOGY

The tests documented in this report were performed in accordance with following methods.

1. FCC CFR 47 Part 2.
2. FCC CFR 47 Part 15.
3. ANSI C63.10-2013.
4. KDB 414788 D01 Radiated Test Site v01r01

3. FACILITIES AND ACCREDITATION

The test sites and measurement facilities used to collect data are located at 218 Maeyeong-ro, Yeongtong-gu, Suwon-si, Gyeonggi-do, 16675, Korea. Line conducted emissions are measured only at the 218 address. The following table identifies which facilities were utilized for radiated emission measurements documented in this report. Specific facilities are also identified in the test results sections.

218 Maeyeong-ro	
<input checked="" type="checkbox"/>	Chamber 1
<input checked="" type="checkbox"/>	Chamber 2
<input type="checkbox"/>	Chamber 3

UL Korea, Ltd. is accredited by IAS, Laboratory Code TL-637. The full scope of accreditation can be viewed at <https://www.iasonline.org/wp-content/uploads/2017/05/TL-637-cert-New.pdf>.

4. CALIBRATION AND UNCERTAINTY

4.1. MEASURING INSTRUMENT CALIBRATION

The measuring equipment utilized to perform the tests documented in this report has been calibrated in accordance with the manufacturer's recommendations, and is traceable to recognized national standards.

4.2. SAMPLE CALCULATION

Where relevant, the following sample calculation is provided:

$$\begin{aligned} \text{Field Strength (dBuV/m)} &= \text{Measured Voltage (dBuV)} + \text{Antenna Factor (dB/m)} + \\ &\text{Cable Loss (dB)} - \text{Preamp Gain (dB)} \\ 36.5 \text{ dBuV} + 18.7 \text{ dB/m} + 0.6 \text{ dB} - 26.9 \text{ dB} &= 28.9 \text{ dBuV/m} \end{aligned}$$

4.3. MEASUREMENT UNCERTAINTY

Where relevant, the following measurement uncertainty levels have been estimated for tests performed on the apparatus:

PARAMETER	UNCERTAINTY
Conducted Disturbance, 0.15 to 30 MHz	3.02 dB
Radiated Disturbance, 9 kHz to 30 MHz	1.72 dB
Radiated Disturbance, 30 MHz to 1 GHz	4.05 dB

Uncertainty figures are valid to a confidence level of 95%.

4.4. DECISION RULE

Decision rule for statement(s) of conformity is based on Procedure 2, Clause 4.4.3 in IEC Guide 115:2007.

5. EQUIPMENT UNDER TEST

5.1. DESCRIPTION OF EUT

The EUT is a GSM/WCDMA/LTE/5G NR Phone + BT/BLE, DTS/UNII a/b/g/n/ac/ax and NFC. This test report addresses the DXX (NFC) operational mode.

This report covers the Samsung models SM-A236U, SM-A236U1/DS, SM-S236DL. These models are identical in hardware except SM-A236U1/DS is supported dual SIM tray and SM-A236U has single SIM tray, SM-S236DL is same hardware.

All series model was same hardware thus, SM-A236U was set for final test.

5.2. MAXIMUM E-FIELD STRENGTH

The testing was performed at 3 meter. The transmitter maximum E-field at 30m distance is 15.76 dBuV/m which convert from 3 meter data.

5.3. WORST-CASE CONFIGURATION AND MODE

The NFC function was tested at its' fundamental and only operational frequency of 13.56 MHz.

The NFC with tag mode's fundamental of the EUT was investigated in three orthogonal orientations X, Y and Z. It was determined that the Z orientation was the worst-case orientation; therefore all final radiated testing was performed with the EUT in the Z orientation while generating continuous emissions.

The NFC without tag mode's fundamental of the EUT was investigated in three orthogonal orientations X, Y and Z. It was determined that the Z orientation was the worst-case orientation; therefore all final radiated testing was performed with the EUT in the Y orientation while generating continuous emissions.

The fundamental level of the EUT was investigated each type and bitrate. All test was performed worst case condition(type A and bit rate 106 kbps).

Radiated(fundamental level and spurious emissions) tests were performed both without reading a passive tag condition[test mode] and with reading a passive tag condition.

5.4. DESCRIPTION OF TEST SETUP

SUPPORT EQUIPMENT

Support Equipment List				
Description	Manufacturer	Model	Serial Number	FCC ID
Charger	SAMSUNG	EP-TA800	R37MANQ1E72SE3	N/A
Data Cable	SAMSUNG	EP-DN980	GH39-02115A BWE	N/A
Earphone	SAMSUNG	GH59-15055A	EHS64AVFWE	N/A

I/O CABLE

I/O Cable List						
Cable No.	Port	# of identical ports	Connector Type	Cable Type	Cable Length (m)	Remarks
1	DC Power	1	C to C Type	Shielded	1.0 m	N/A
2	Audio	2	Mini-jack	Unshielded	0.7m	N/A

The EUT is a stand-alone device configured and tested in a worst-case setup.

Note: Worst case is using worst case orientation with AC charger attached to the EUT with NFC signal continuously transmitting.

SETUP DIAGRAM FOR TESTS (RADIATED TEST SETUP)

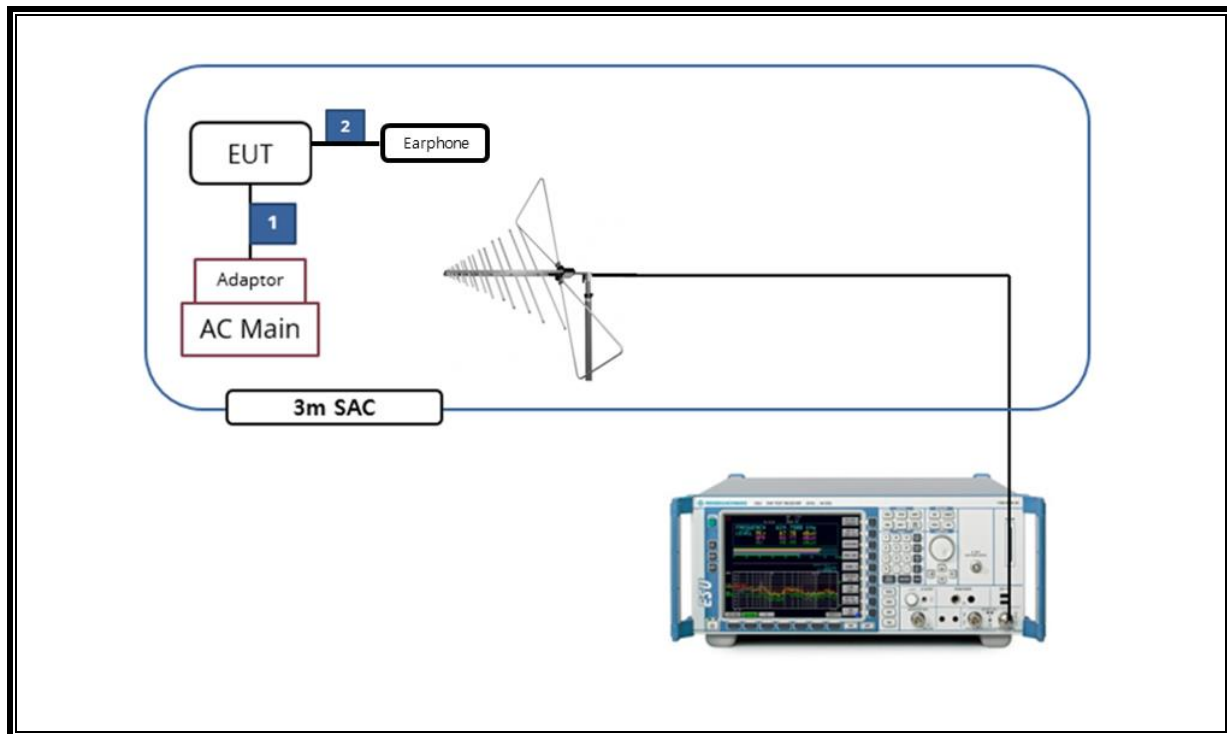

TEST AND MEASUREMENT EQUIPMENT

The following test and measurement equipment was utilized for the tests documented in this report:

Test Equipment List				
Description	Manufacturer	Model	S/N	Cal Due
Antenna, Bilog, 30MHz-1GHz	SCHWARZBECK	VULB9163	845	2022-08-13
Antenna, Bilog, 30MHz-1GHz	SCHWARZBECK	VULB9163	749	2022-08-13
Preamplifier, 1000 MHz	Sonoma	310N	341282	2022-08-02
Preamplifier, 1000 MHz	Sonoma	310N	351741	2022-08-02
Spectrum Analyzer, 7 GHz	Agilent / HP	N9010A	MY54200580	2022-08-02
EMI Test Receive, 3 GHz	R&S	ESR3	101832	2022-08-02
DC Power Supply	Agilent / HP	E3640A	MY54226395	2022-08-02
Temperature Chamber	ESPEC	SH-642	93001109	2022-08-02
LISN	R&S	ENV216	101837	2022-08-05
Antenna, Loop, 9kHz-30MHz	R&S	HFH2-Z2	100418	2023-10-06
UL Software				
Description	Manufacturer	Model	Version	
Radiated software	UL	UL EMC	Ver 9.5	
AC Line Conducted software	UL	UL EMC	Ver 9.5	

6. 20dB BANDWIDTH

LIMITS

§15.215

(c) Intentional radiators operating under the alternative provisions to the general emission limits, as contained in §§15.217 through 15.257 and in subpart E of this part, must be designed to ensure that the 20 dB bandwidth of the emission, or whatever bandwidth may otherwise be specified in the specific rule section under which the equipment operates, is contained within the frequency band designated in the rule section under which the equipment is operated

§15.225

Operation within the band 13.110 – 14.010MHz

TEST PROCEDURE

The spectrum analyzer connected receive antenna and the EUT placed on near the receive antenna. The RBW is set to 10kHz. The VBW is set to 3 times the RBW. The sweep time is coupled.

RESULTS

Frequency [MHz]	20 dB Bandwidth [kHz]
13.56	435.30

20dB Bandwidth Plot



7. RADIATED EMISSION TEST RESULTS

7.1. LIMITS AND PROCEDURE

LIMIT

§15.225

(a) The field strength of any emissions within the band 13.553–13.567 MHz shall not exceed 15,848 microvolts/ meter at 30 meters.

(b) Within the bands 13.410–13.553 MHz and 13.567–13.710 MHz, the field strength of any emissions shall not exceed 334 microvolts/meter at 30 meters.

(c) Within the bands 13.110–13.410 MHz and 13.710–14.010 MHz the field strength of any emissions shall not exceed 106 microvolts/meter at 30 meters.

(d) The field strength of any emissions appearing outside of the 13.110– 14.010 MHz and shall not exceed the general radiated emission limits in § 15.209 as follows:

§15.209 (a) Except as provided elsewhere in this subpart, the emissions from an intentional radiator shall not exceed the field strength levels specified in the following table:

Limits for radiated disturbance of an intentional radiator		
Frequency range (MHz)	Limits (µV/m)	Measurement Distance (m)
0.009 – 0.490	2400 / F (kHz)	300
0.490 – 1.705	24000 / F (kHz)	30
1.705 – 30.0	30	30
30 – 88	100**	3
88 - 216	150**	3
216 – 960	200**	3
Above 960	500	3

** Except as provided in paragraph (g), fundamental emissions from intentional radiators operating under this section shall not be located in the frequency bands 54-72 MHz, 76-88 MHz, 174-216 MHz or 470-806 MHz. However, operation within these frequency bands is permitted under other sections of this part, e.g. §§ 15.231 and 15.241.

§15.209 (b) In the emission table above, the tighter limit applies at the band edges.

Formula for converting the filed strength from uV/m to dBuV/m is:

Limit (dBuV/m) = 20 log limit (uV/m)

In addition:

§15.209 (d) The emission limits shown the above table are based on measurements employing a CISPR quasi-peak detector except for the frequency bands 9-90 kHz, 110-490 kHz and above 1000 MHz. Radiated emissions limits in these three bands are based on measurements employing an average detector.

§15.209 (d) The provisions in §§ 15.225, measuring emissions at distances other than the distances specified in the above table, determining the frequency range over which radiated emissions are to be measured, and limiting peak emissions apply to all devices operated under this part.

TEST PROCEDURE

ANSI C63.10-2013

The EUT is an intentional radiator that incorporates a digital device. The highest fundamental frequency generated or used in the device is 13.56 MHz. The frequency range was investigated from 0.15 MHz to the 10th harmonic of the highest fundamental frequency, or 1000 MHz, whichever is greater (1000MHz)

RESULTS

No non-compliance noted:

7.1.1. FUNDAMENTAL AND SPURIOUS EMISSIONS (0.15 – 30 MHz) [EUT without passive TAG mode]

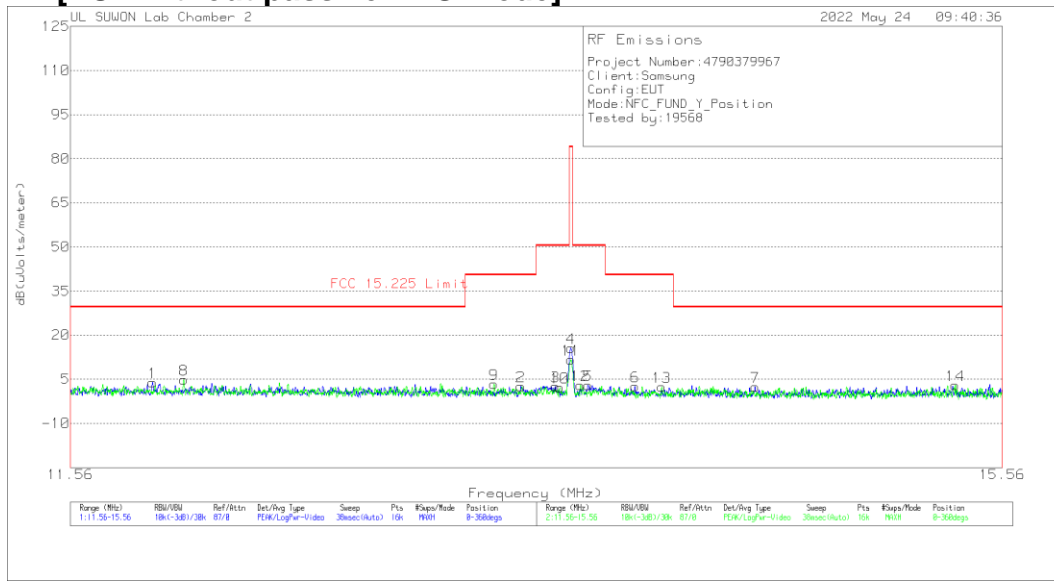

Trace Markers Face on

Marker	Frequency (MHz)	Meter Reading (dBuV)	Det	HFH2-Z2_Loop Antenna	Dist Corr 30m	Cable Loss	Corrected Reading dB(uVolts/meter)	FCC 15.225 Limit	Margin (dB)	Azimuth (Degs)
1	11.86688	23.37	Pk	20	-40	.5	3.87	29.54	-25.67	0-360
2	13.34538	22.17	Pk	20	-40	.5	2.67	40.51	-37.84	0-360
3	13.49363	22.04	Pk	20	-40	.5	2.54	50.5	-47.96	0-360
**4	13.56	35.16	Pk	20	-40	.5	15.66	84	-68.34	0-360
5	13.63475	22.38	Pk	20	-40	.6	2.98	50.5	-47.52	0-360
6	13.83988	21.92	Pk	20	-40	.6	2.52	40.51	-37.99	0-360
7	14.38038	21.86	Pk	20	-40	.6	2.46	29.54	-27.08	0-360

Face off

Marker	Frequency (MHz)	Meter Reading (dBuV)	Det	HFH2-Z2_Loop Antenna	Dist Corr 30m	Cable Loss	Corrected Reading dB(uVolts/meter)	FCC 15.225 Limit	Margin (dB)	Azimuth (Degs)
8	11.98563	24.35	Pk	20	-40	.5	4.85	29.54	-24.69	0-360
9	13.23188	22.88	Pk	20	-40	.5	3.38	40.51	-37.13	0-360
10	13.51275	21.75	Pk	20	-40	.5	2.25	50.5	-48.25	0-360
**11	13.56088	31.06	Pk	20	-40	.5	11.56	84	-72.44	0-360
12	13.60213	22.38	Pk	20	-40	.6	2.98	50.5	-47.52	0-360
13	13.95888	21.76	Pk	20	-40	.6	2.36	40.51	-38.15	0-360
14	15.32938	22.36	Pk	20	-40	.6	2.96	29.54	-26.58	0-360

Pk - Peak detector
 **Fundamental

Note 1 : Although these tests were performed other than open filed test site, adequate comparison measurements were confirmed against 30 m open are test site.

Therefore sufficient tests were made to demonstrate that the alternative site produces results that correlate with the ones of tests made in an open field based on KDB 414788.

Note 2: Radiated test were investigated with three receiving antenna axes: Face-on, Face-off and horizontal (parallel to the ground plane) and the worse orientations of Face-on and Face-off were set for final test.

7.1.2. SPURIOUS EMISSION 0.009 TO 30 MHz

[EUT without passive TAG mode]

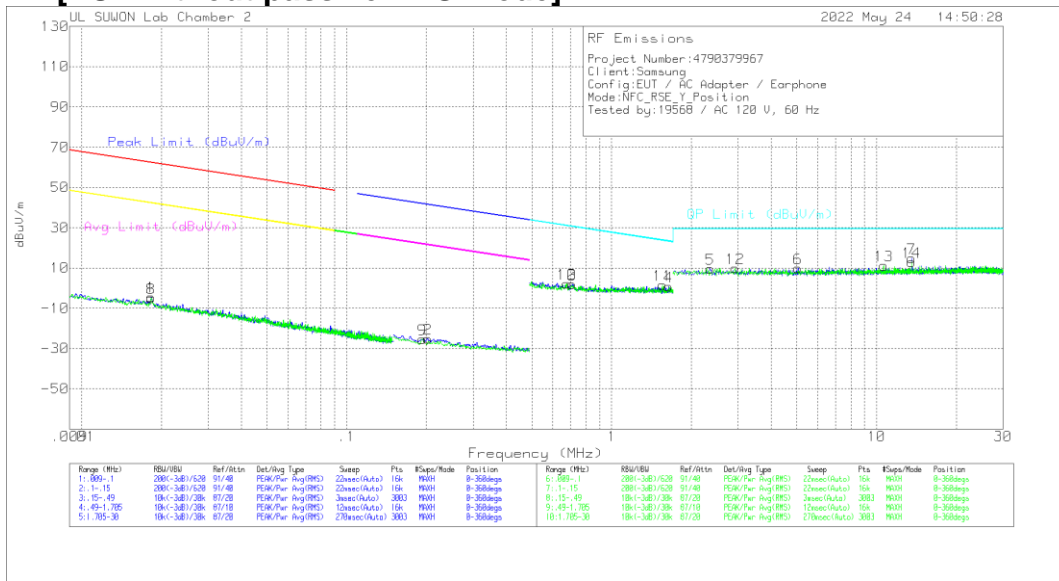

Trace Markers

Face on

Marker	Frequency (MHz)	Meter Reading (dBuV)	Det	HFH2-Z2_Loop Antenna	Cable Loss	Dist Corr 300m	Corrected Reading dBuV/m	Peak Limit (dBuV/m)	Margin (dB)	Avg Limit (dBuV/m)	Margin (dB)	Azimuth (Degs)
1	.01831	55.43	Pk	20.2	.1	-80	-4.27	62.33	-66.6	42.33	-46.6	0-360
2	.20204	35.14	Pk	19.7	.1	-80	-25.06	41.51	-66.57	21.51	-46.57	0-360

Marker	Frequency (MHz)	Meter Reading (dBuV)	Det	HFH2-Z2_Loop Antenna	Cable Loss	Dist Corr 30m	Corrected Reading dBuV/m	QP Limit (dBuV/m)	Margin (dB)	Azimuth (Degs)
3	.71013	22.12	Pk	19.7	.1	-40	1.92	30.59	-28.67	0-360
4	1.64037	20.83	Pk	19.8	.2	-40	.83	23.33	-22.5	0-360
5	2.35061	29.61	Pk	19.9	.2	-40	9.71	29.5	-19.79	0-360
6	5.05088	29.91	Pk	19.8	.3	-40	10.01	29.5	-19.49	0-360
**7	13.56165	34.48	Pk	20	.5	-40	14.98	29.5	-14.52	0-360

Face off

Marker	Frequency (MHz)	Meter Reading (dBuV)	Det	HFH2-Z2_Loop Antenna	Cable Loss	Dist Corr 300m	Corrected Reading dBuV/m	Peak Limit (dBuV/m)	Margin (dB)	Avg Limit (dBuV/m)	Margin (dB)	Azimuth (Degs)
8	.01831	54.86	Pk	20.2	.1	-80	-4.84	62.33	-67.17	42.33	-47.17	0-360
9	.19322	34.85	Pk	19.8	.1	-80	-25.25	41.9	-67.15	21.9	-47.15	0-360

Marker	Frequency (MHz)	Meter Reading (dBuV)	Det	HFH2-Z2_Loop Antenna	Cable Loss	Dist Corr 30m	Corrected Reading dBuV/m	QP Limit (dBuV/m)	Margin (dB)	Azimuth (Degs)
10	.67715	22.37	Pk	19.7	.1	-40	2.17	31	-28.83	0-360
11	1.55373	21.65	Pk	19.8	.2	-40	1.65	23.8	-22.15	0-360
12	2.93025	29.69	Pk	19.9	.3	-40	9.89	29.5	-19.61	0-360
13	10.62105	30.67	Pk	20	.5	-40	11.17	29.5	-18.33	0-360
**14	13.56165	32.57	Pk	20	.5	-40	13.07	29.5	-16.43	0-360

Pk - Peak detector

**Fundamental

Note 1: The data for marker number 7 and 14 are the fundamental signal.

Please refer to section 8.1.1 about the fundamental level.

Frequency range 0.009MHz ~ 0.490MHz, only noise floor level and more than 20dB margin.

Note 2: Radiated test were investigated with three receiving antenna axes: Face-on, Face-off and horizontal (parallel to the ground plane) and the worse orientations of Face-on and Face-off were set for final test.

7.1.3. TX SPURIOUS EMISSION 30 TO 1000 MHz [EUT without passive TAG mode]

HORIZONTAL

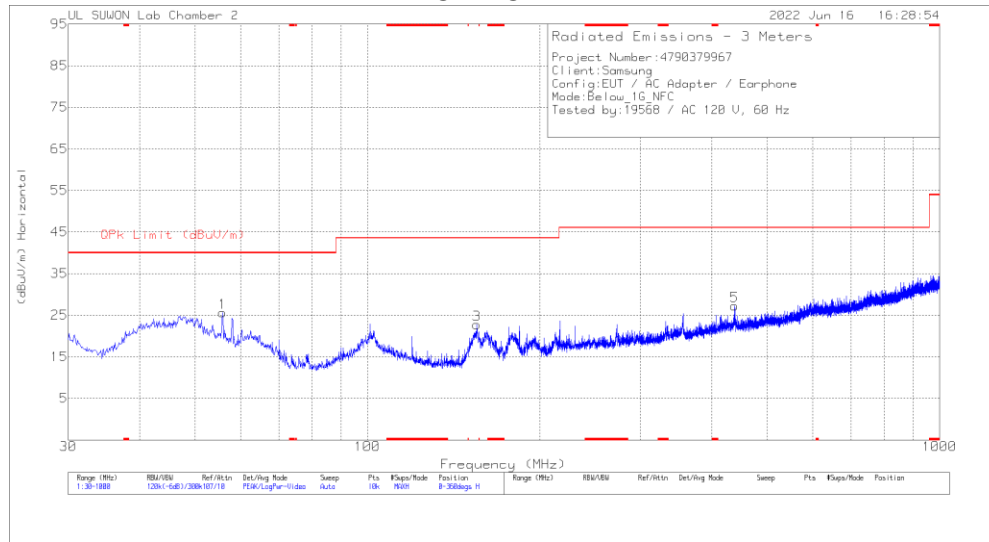

VERTICAL

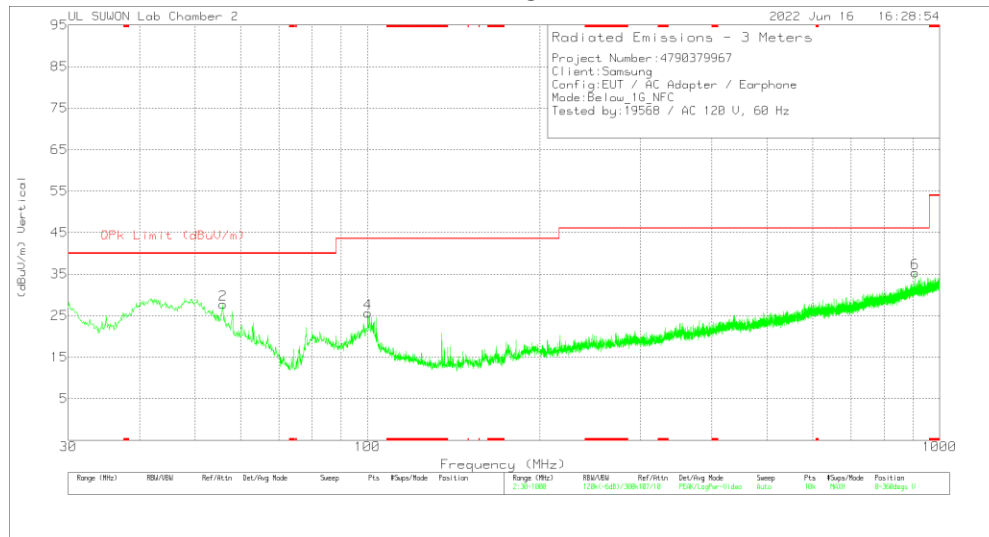

Trace Markers

Marker	Frequency (MHz)	Meter Reading (dBuV)	Det	VULB9163_749	Below 1G[dB]	DC Corr (dB)	Corrected Reading (dBuV/m)	OPK Limit (dBuV/m)	Margin (dB)	Azimuth (Degs)	Height (cm)	Polarity
1	55.802	37.6	Pk	19.2	-31.2	0	25.6	40	-14.4	0-360	300	H
3	155.324	38.74	Pk	14	-30	0	22.74	43.52	-20.78	0-360	100	H
5	438.37	33.43	Pk	22	-28.2	0	27.23	46.02	-18.79	0-360	100	H
2	55.899	39.78	Pk	19.2	-31.2	0	27.78	40	-12.22	0-360	100	V
4	100.131	38.76	Pk	17.4	-30.6	0	25.56	43.52	-17.96	0-360	100	V
6	907.365	32.97	Pk	28.1	-25.7	0	35.37	46.02	-10.65	0-360	100	V

Pk - Peak detector

7.1.4. FUNDAMENTAL AND SPURIOUS EMISSIONS (0.15 – 30 MHz) [EUT with passive TAG mode]

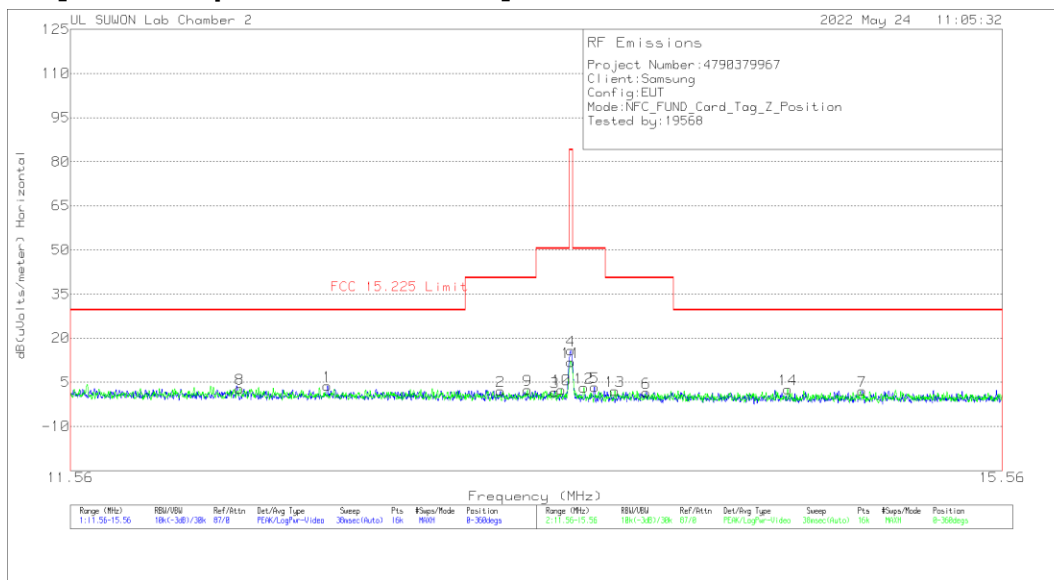

Trace Markers

Face on

Marker	Frequency (MHz)	Meter Reading (dBuV)	Det	HFH2-Z2_Loop Antenna	Dist Corr 30m	Cable Loss	Corrected Reading dB(uVolts/meter)	FCC 15.225 Limit	Margin (dB)	Azimuth (Degs)
1	12.5475	23.19	Pk	20	-40	.5	3.69	29.54	-25.85	0-360
2	13.259	21.47	Pk	20	-40	.5	1.97	40.51	-38.54	0-360
3	13.49075	21.14	Pk	20	-40	.5	1.64	50.5	-48.86	0-360
**4	13.5605	35.26	Pk	20	-40	.5	15.76	84	-68.24	0-360
5	13.66275	22.74	Pk	20	-40	.6	3.34	50.5	-47.16	0-360
6	13.891	20.95	Pk	20	-40	.6	1.55	40.51	-38.96	0-360
7	14.8805	21.5	Pk	20	-40	.6	2.1	29.54	-27.44	0-360

Face off

Marker	Frequency (MHz)	Meter Reading (dBuV)	Det	HFH2-Z2_Loop Antenna	Dist Corr 30m	Cable Loss	Corrected Reading dB(uVolts/meter)	FCC 15.225 Limit	Margin (dB)	Azimuth (Degs)
8	12.20225	22.23	Pk	20	-40	.5	2.73	29.54	-26.81	0-360
9	13.37425	21.86	Pk	20	-40	.5	2.36	40.51	-38.15	0-360
10	13.51925	22.01	Pk	20	-40	.5	2.51	50.5	-47.99	0-360
**11	13.56025	31.36	Pk	20	-40	.5	11.86	84	-72.14	0-360
12	13.61675	22.54	Pk	20	-40	.6	3.14	50.5	-47.36	0-360
13	13.752	21.45	Pk	20	-40	.6	2.05	40.51	-38.46	0-360
14	14.53125	22.05	Pk	20	-40	.6	2.65	29.54	-26.89	0-360

Pk - Peak detector

**Fundamental

Note 1: Although these tests were performed other than open filed test site, adequate comparison measurements were confirmed against 30 m open are test site.

Therefore sufficient tests were made to demonstrate that the alternative site produces results that correlate with the ones of tests made in an open field based on KDB 414788.

Note 2: Radiated test were investigated with three receiving antenna axes: Face-on, Face-off and horizontal (parallel to the ground plane) and the worse orientations of Face-on and Face-off were set for final test.

7.1.5. SPURIOUS EMISSION 0.09 TO 30 MHz [EUT with passive TAG mode]

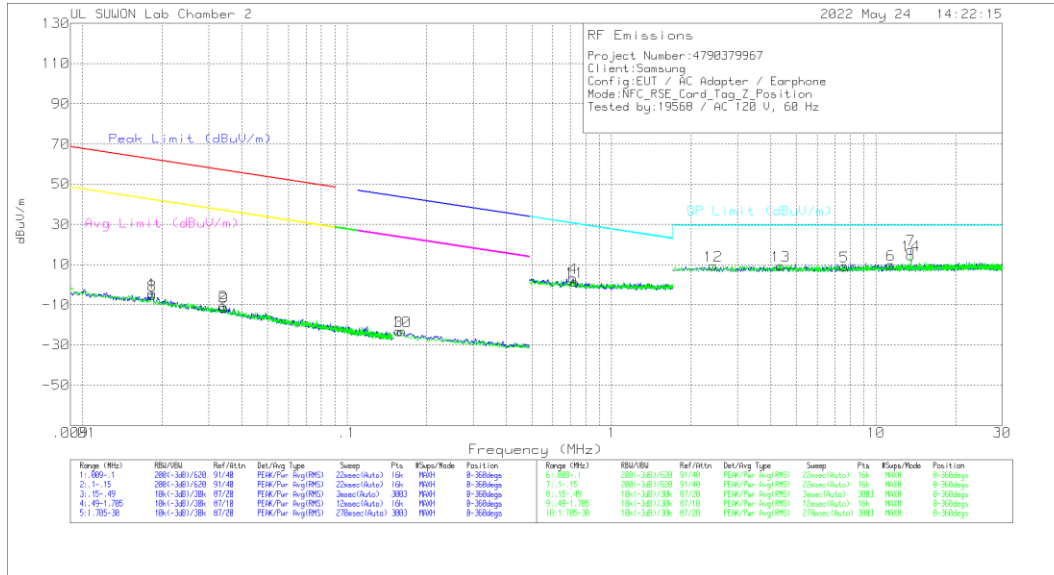

Trace Markers

Face on

Marker	Frequency (MHz)	Meter Reading (dBuV)	Det	HFH2-Z2_Loop Antenna	Cable Loss	Dist Corr 300m	Corrected Reading dBuV/m	Peak Limit (dBuV/m)	Margin (dB)	Avg Limit (dBuV/m)	Margin (dB)	Azimuth (Degs)
1	.01832	55.49	Pk	20.2	.1	-80	-4.21	62.33	-66.54	42.33	-46.54	0-360
2	.0341	49.45	Pk	20	.1	-80	-10.45	56.93	-67.38	36.93	-47.38	0-360
3	.15644	37.04	Pk	19.8	.1	-80	-23.06	43.74	-66.8	23.74	-46.8	0-360

Marker	Frequency (MHz)	Meter Reading (dBuV)	Det	HFH2-Z2_Loop Antenna	Cable Loss	Dist Corr 30m	Corrected Reading dBuV/m	QP Limit (dBuV/m)	Margin (dB)	Azimuth (Degs)
4	.71602	23.42	Pk	19.7	.1	-40	3.22	30.51	-27.29	0-360
5	7.59563	28.85	Pk	19.9	.4	-40	9.15	29.5	-20.35	0-360
6	11.37034	29.45	Pk	20	.5	-40	9.95	29.5	-19.55	0-360
**7	13.56165	36.76	Pk	20	.5	-40	17.26	29.5	-12.24	0-360

Face off

Marker	Frequency (MHz)	Meter Reading (dBuV)	Det	HFH2-Z2_Loop Antenna	Cable Loss	Dist Corr 300m	Corrected Reading dBuV/m	Peak Limit (dBuV/m)	Margin (dB)	Avg Limit (dBuV/m)	Margin (dB)	Azimuth (Degs)
8	.01835	54.43	Pk	20.2	.1	-80	-5.27	62.31	-67.58	42.31	-47.58	0-360
9	.03427	48.5	Pk	20	.1	-80	-11.4	56.89	-68.29	36.89	-48.29	0-360
10	.16141	36.99	Pk	19.8	.1	-80	-23.11	43.46	-66.57	23.46	-46.57	0-360

Marker	Frequency (MHz)	Meter Reading (dBuV)	Det	HFH2-Z2_Loop Antenna	Cable Loss	Dist Corr 30m	Corrected Reading dBuV/m	QP Limit (dBuV/m)	Margin (dB)	Azimuth (Degs)
11	.7259	21.68	Pk	19.7	.1	-40	1.48	30.4	-28.92	0-360
12	2.4213	29.32	Pk	19.9	.2	-40	9.42	29.5	-20.08	0-360
13	4.35343	29.32	Pk	19.8	.3	-40	9.42	29.5	-20.08	0-360
**14	13.56165	33.99	Pk	20	.5	-40	14.49	29.5	-15.01	0-360

Pk - Peak detector

**Fundamental

Note 1: The data for marker number 7 and 14 are the fundamental signal.

Please refer to section 8.1.4 about the fundamental level.

Frequency range 0.009MHz ~ 0.490MHz, only noise floor level and more than 20dB margin.

Note 2: Radiated test were investigated with three receiving antenna axes: Face-on, Face-off and horizontal (parallel to the ground plane) and the worse orientations of Face-on and Face-off were set for final test.

7.1.6. TX SPURIOUS EMISSION 30 TO 1000 MHz [EUT with passive TAG mode]

HORIZONTAL

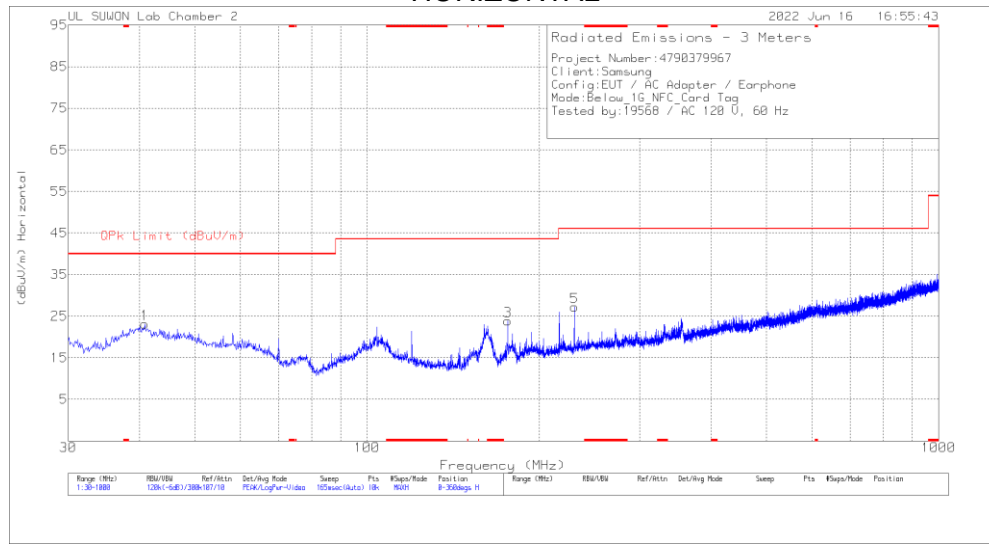

VERTICAL

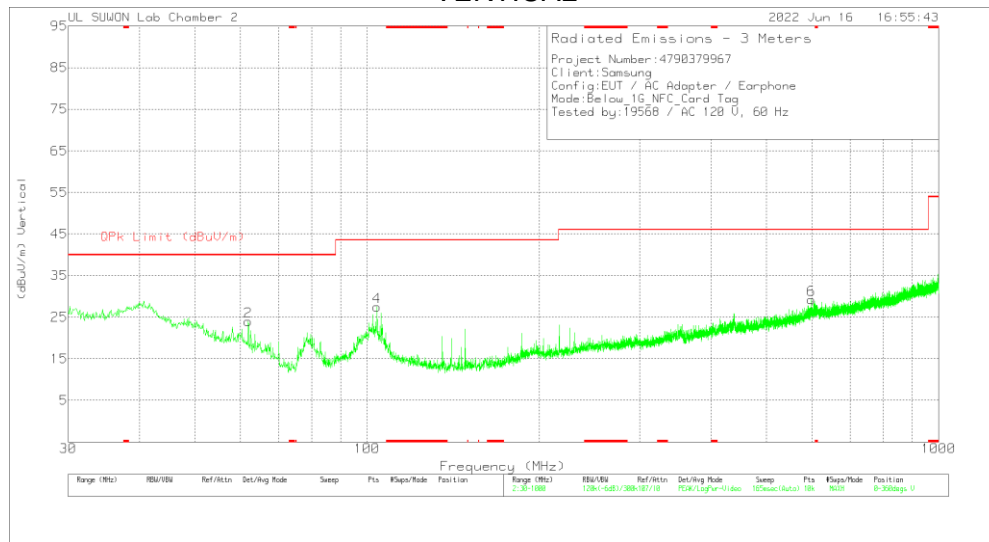

Trace Markers

Marker	Frequency (MHz)	Meter Reading (dBuV)	Det	VULB9163_749	Below 1G[dB]	DC Corr (dB)	Corrected Reading (dBuV/m)	OPk Limit (dBuV/m)	Margin (dB)	Azimuth (Degs)	Height (cm)	Polarity
1	40.864	35.58	Pk	18.9	-31.3	0	23.18	40	-16.82	0-360	300	H
3	176.276	38.88	Pk	14.9	-29.9	0	23.88	43.52	-19.64	0-360	100	H
5	230.499	39.17	Pk	17.6	-29.5	0	27.27	46.02	-18.75	0-360	100	H
2	61.913	37.08	Pk	18	-31.1	0	23.98	40	-16.02	0-360	100	V
4	104.108	40.46	Pk	17.6	-30.6	0	27.46	43.52	-16.06	0-360	100	V
6	599.099	31.84	Pk	25	-27.6	0	29.24	46.02	-16.78	0-360	100	V

Pk - Peak detector

8. AC MAINS LINE CONDUCTED EMISSIONS

LIMITS

§15.207

(a) Except as shown in paragraphs (b) and (c) of this section, for an intentional radiator that is designed to be connected to the public utility (AC) power line, the radio frequency voltage that is conducted back onto the AC power line on any frequency or frequencies, within the band 150 kHz to 30 MHz, shall not exceed the limits in the following table, as measured using a 50 μ H/50 ohms line impedance stabilization network (LISN). Compliance with the provisions of this paragraph shall be based on the measurement of the radio frequency voltage between each power line and ground at the power terminal. The lower limit applies at the band edges.

Frequency range (MHz)	Limits (dB μ V)	
	Quasi-peak	Average
0.15 to 0.50	66 to 56	56 to 46
0.50 to 5	56	46
5 to 30	60	50

Notes:

1. The lower limit shall apply at the transition frequencies
2. The limit decreases linearly with the logarithm of the frequency in the range 0.15 MHz to 0.50 MHz.

TEST PROCEDURE

The EUT is placed on a non-conducting table 40 cm from the vertical ground plane and 80 cm above the horizontal ground plane. The EUT is configured in accordance with ANSI C63.10.

The receiver is set to a resolution bandwidth of 9 kHz. Peak detection is used unless otherwise noted as quasi-peak or average.

Line conducted data is recorded for both NEUTRAL and HOT lines.

RESULTS

No non-compliance noted:

WORST EMISSIONS(Terminated EUT's loop antenna)

LINE 1 PLOT

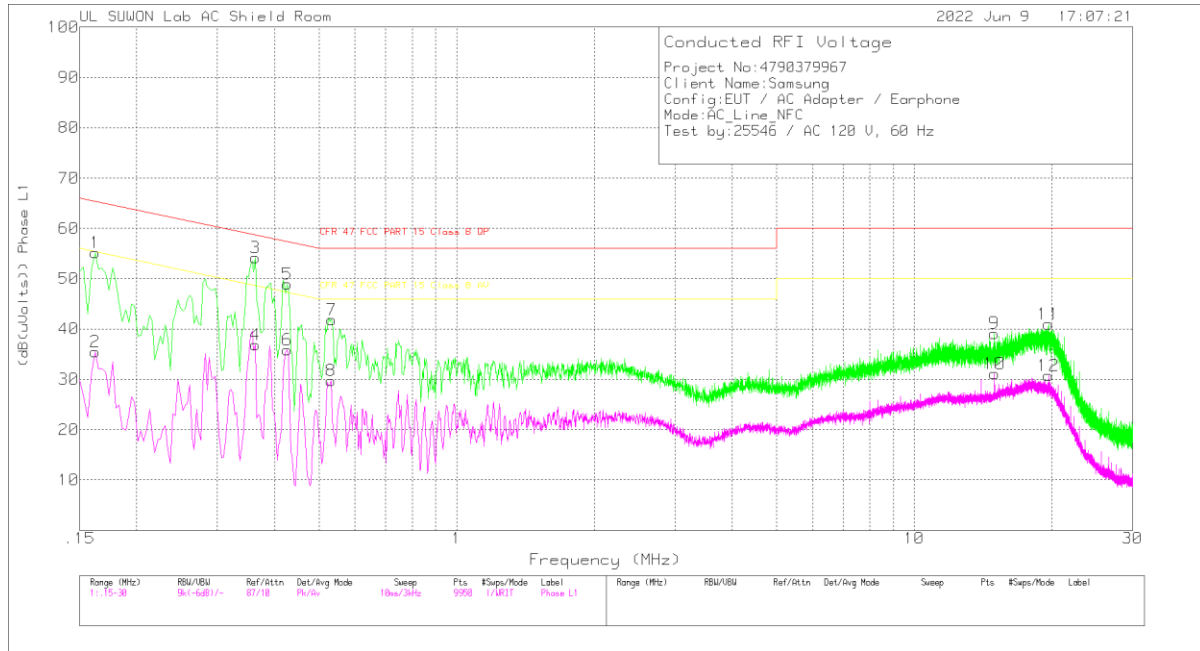

LINE 1 RESULTS

Trace Markers

Range 1: Phase L1 .15 - 30MHz

Marker	Frequency (MHz)	Meter Reading (dBuV)	Det	101836_With EX_L1[dB]	CABLELOS S(dB)	Corrected Reading (dB(uVolts))	CFR 47 FCC PART 15 Class B QP	Margin (dB)	CFR 47 FCC PART 15 Class B AV	Margin (dB)
1	.162	45.19	Pk	9.9	.1	55.19	65.36	-10.17	-	-
2	.162	25.43	Av	9.9	.1	35.43	-	-	55.36	-19.93
3	.363	44.21	Pk	9.8	.2	54.21	58.66	-4.45	-	-
4	.363	26.84	Av	9.8	.2	36.84	-	-	48.66	-11.82
5	.426	38.96	Pk	9.8	.2	48.96	57.33	-8.37	-	-
6	.426	25.81	Av	9.8	.2	35.81	-	-	47.33	-11.52
7	.5325	31.71	Pk	9.9	.2	41.81	56	-14.19	-	-
8	.531	19.66	Av	9.9	.2	29.76	-	-	46	-16.24
9	14.979	28.75	Pk	10	.4	39.15	60	-20.85	-	-
10	14.982	20.66	Av	10	.4	31.06	-	-	50	-18.94
11	19.641	30.43	Pk	10.1	.4	40.93	60	-19.07	-	-
12	19.641	20.19	Av	10.1	.4	30.69	-	-	50	-19.31

Pk - Peak detector
 Av - Average detection

Quasi-Peak Emissions

Range 1: Phase L1 .15 - 30MHz

Frequency (MHz)	Meter Reading (dBuV)	Det	101836_With EX_L1[dB]	CABLELOS S(dB)	Corrected Reading (dB(uVolts))	CFR 47 FCC PART 15 Class B QP	Margin (dB)	CFR 47 FCC PART 15 Class B AV	Margin (dB)
.363	40.98	Qp	9.8	.2	50.98	58.66	-7.68	-	-
.426	37.04	Qp	9.8	.2	47.04	57.33	-10.29	-	-

Qp - Quasi-Peak detector

LINE 2 PLOT

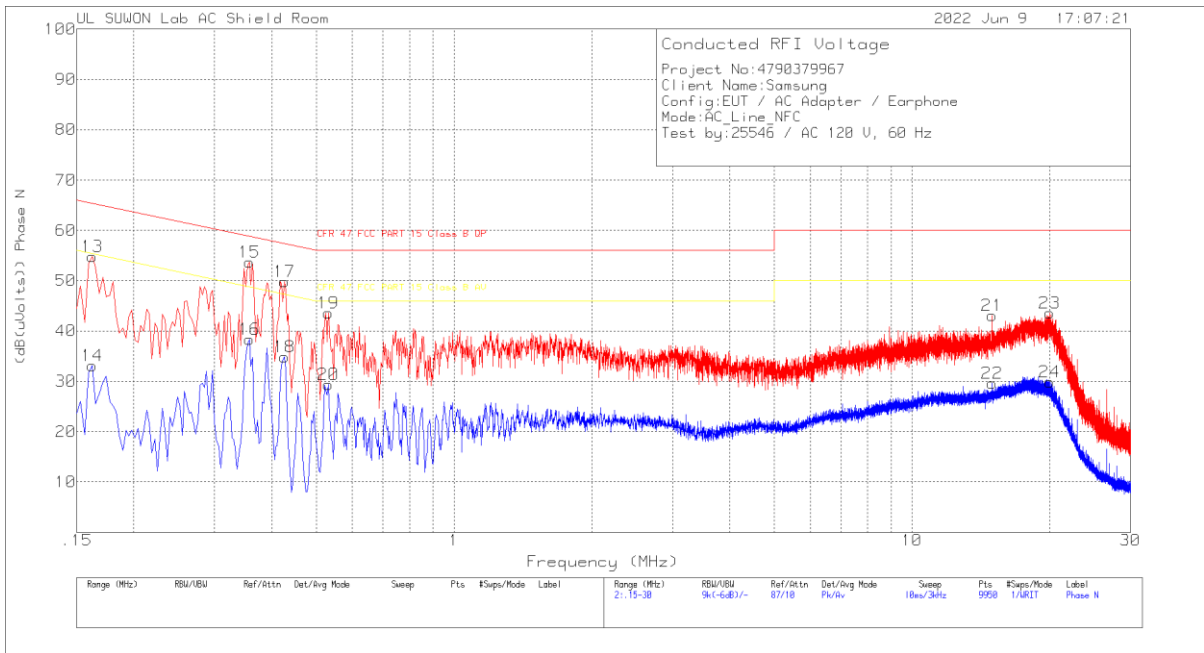

LINE 2 RESULTS

Trace Markers

Range 2: Phase N .15 - 30MHz

Marker	Frequency (MHz)	Meter Reading (dBuV)	Det	101836_With EX_N[dB]	CABLELOSS S(dB)	Corrected Reading (dB(uVolts))	CFR 47 FCC PART 15 Class B QP	Margin (dB)	CFR 47 FCC PART 15 Class B AV	Margin (dB)
13	.162	44.82	Pk	9.9	.1	54.82	65.36	-10.54	-	-
14	.162	23.1	Av	9.9	.1	33.1	-	-	55.36	-22.26
15	.357	43.68	Pk	9.8	.2	53.68	58.8	-5.12	-	-
16	.357	28.32	Av	9.8	.2	38.32	-	-	48.8	-10.48
17	.426	39.79	Pk	9.8	.2	49.79	57.33	-7.54	-	-
18	.426	24.82	Av	9.8	.2	34.82	-	-	47.33	-12.51
19	.531	33.47	Pk	9.9	.2	43.57	56	-12.43	-	-
20	.531	19.3	Av	9.9	.2	29.4	-	-	46	-16.6
21	14.979	32.56	Pk	10.1	.4	43.06	60	-16.94	-	-
22	14.979	19.17	Av	10.1	.4	29.67	-	-	50	-20.33
23	19.98	32.93	Pk	10.2	.4	43.53	60	-16.47	-	-
24	19.98	19.24	Av	10.2	.4	29.84	-	-	50	-20.16

Pk - Peak detector

Av - Average detection

Quasi-Peak Emissions

Range 2: Phase N .15 - 30MHz

Frequency (MHz)	Meter Reading (dBuV)	Det	101836_With EX_N[dB]	CABLELOSS (dB)	Corrected Reading (dB(uVolts))	CFR 47 FCC PART 15 Class B QP	Margin (dB)	CFR 47 FCC PART 15 Class B AV	Margin (dB)
.357	41.81	Qp	9.8	.2	51.81	58.8	-6.99	-	-
.426	37.76	Qp	9.8	.2	47.76	57.33	-9.57	-	-

Qp - Quasi-Peak detector

WORST EMISSIONS(Not Terminated)

LINE 1 PLOT

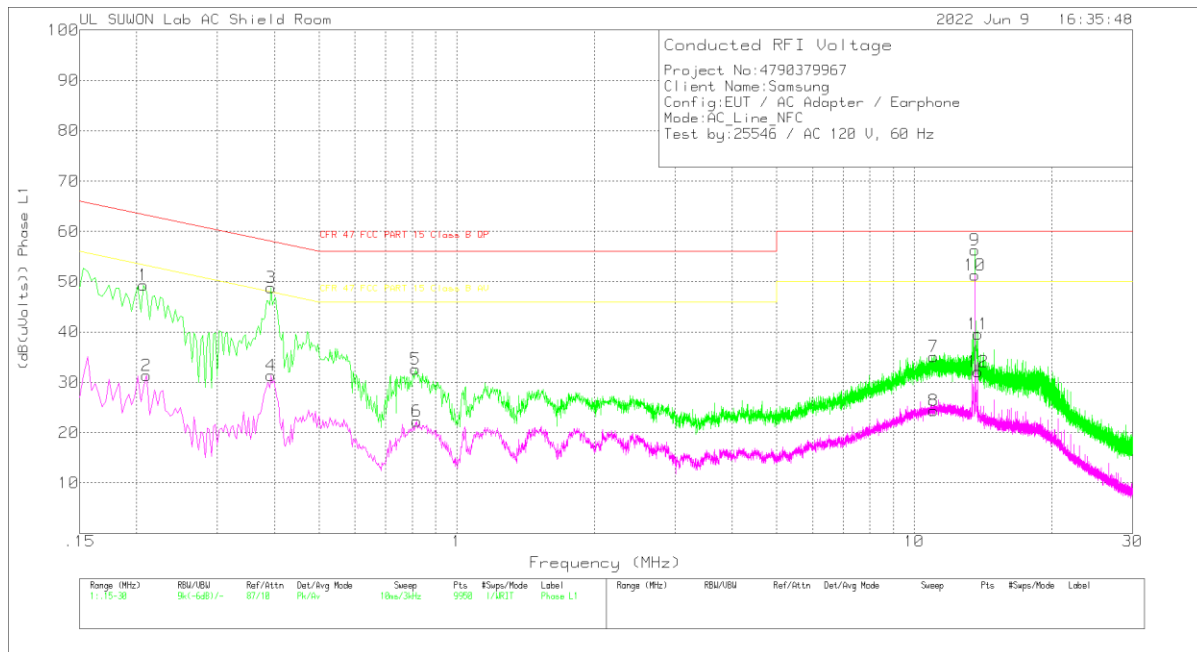

LINE 1 RESULTS

Trace Markers

Range 1: Phase L1 .15 - 30MHz

Marker	Frequency (MHz)	Meter Reading (dBuV)	Det	101836_With EX_L1[dB]	CABLELOS S(dB)	Corrected Reading (dB(uVolts))	CFR 47 FCC PART 15 Class B QP	Margin (dB)	CFR 47 FCC PART 15 Class B AV	Margin (dB)
1	.207	39.3	Pk	9.8	.2	49.3	63.32	-14.02	-	-
2	.21	21.33	Av	9.8	.2	31.33	-	-	53.21	-21.88
3	.393	38.79	Pk	9.8	.2	48.79	58	-9.21	-	-
4	.393	21.35	Av	9.8	.2	31.35	-	-	48	-16.65
5	.813	22.62	Pk	9.8	.2	32.62	56	-23.38	-	-
6	.819	12.21	Av	9.8	.2	22.21	-	-	46	-23.79
7	11.025	24.85	Pk	9.9	.3	35.05	60	-24.95	-	-
8	11.025	14.21	Av	9.9	.3	24.41	-	-	50	-25.59
9	13.56	45.91	Pk	10	.4	56.31	60	-3.69	-	-
10	13.56	40.96	Av	10	.4	51.36	-	-	50	1.36
11	13.773	29.16	Pk	10	.4	39.56	60	-20.44	-	-
12	13.773	21.7	Av	10	.4	32.1	-	-	50	-17.9

Pk - Peak detector
 Av - Average detection

Quasi-Peak Emissions

Range 1: Phase L1 .15 - 30MHz

Frequency (MHz)	Meter Reading (dBuV)	Det	101836_With EX_L1[dB]	CABLELOS S(dB)	Corrected Reading (dB(uVolts))	CFR 47 FCC PART 15 Class B QP	Margin (dB)	CFR 47 FCC PART 15 Class B AV	Margin (dB)
.393	34.98	Qp	9.8	.2	44.98	58	-13.02	-	-
13.5602	43.99	Qp	10	.4	54.39	60	-5.61	-	-

Qp - Quasi-Peak detector

LINE 2 PLOT

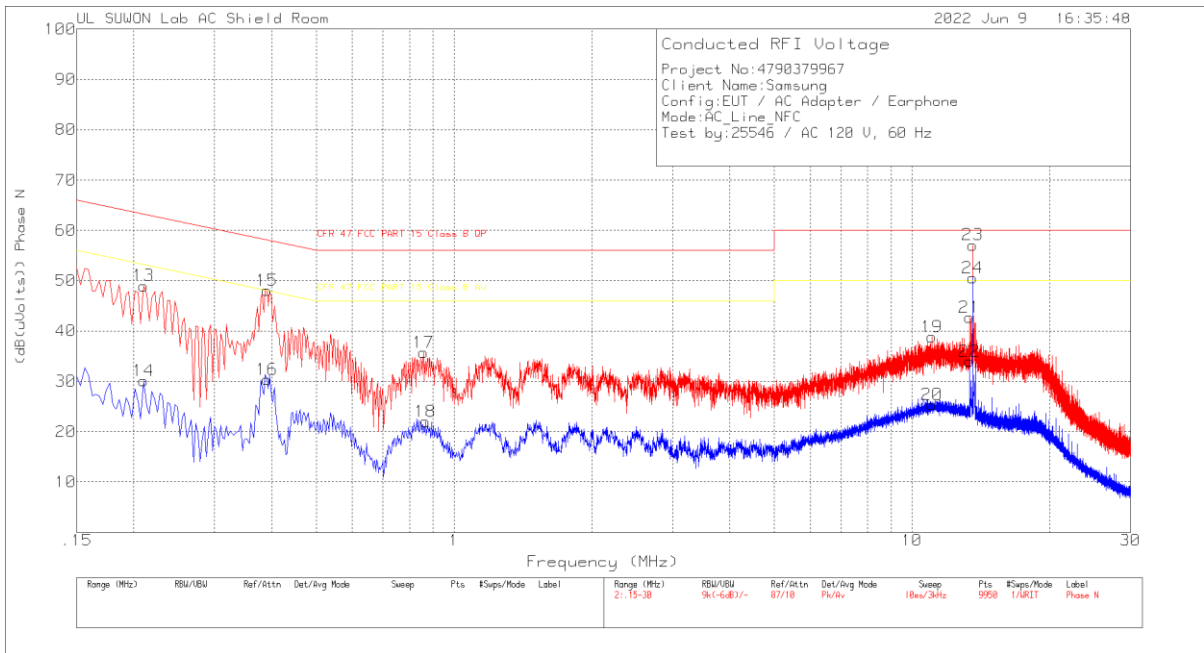

LINE 2 RESULTS

Trace Markers

Range 2: Phase N .15 - 30MHz

Marker	Frequency (MHz)	Meter Reading (dBuV)	Det	101836_With EX_N[dB]	CABLELOS S(dB)	Corrected Reading (dB(uVolts))	CFR 47 FCC PART 15 Class B QP	Margin (dB)	CFR 47 FCC PART 15 Class B AV	Margin (dB)
13	.21	39	Pk	9.8	.2	49	63.21	-14.21	-	-
14	.21	20.07	Av	9.8	.2	30.07	-	-	53.21	-23.14
15	.39	38.09	Pk	9.8	.2	48.09	58.06	-9.97	-	-
16	.39	20.33	Av	9.8	.2	30.33	-	-	48.06	-17.73
17	.858	25.62	Pk	9.8	.3	35.72	56	-20.28	-	-
18	.867	11.94	Av	9.8	.3	22.04	-	-	46	-23.96
19	11.049	28.59	Pk	9.9	.3	38.79	60	-21.21	-	-
20	11.052	15.2	Av	9.9	.3	25.4	-	-	50	-24.6
21	13.347	32.29	Pk	10	.4	42.69	60	-17.31	-	-
22	13.347	23.6	Av	10	.4	34	-	-	50	-16
23	13.56	46.7	Pk	10	.4	57.1	60	-2.9	-	-
24	13.56	40.21	Av	10	.4	50.61	-	-	50	.61

Pk - Peak detector
 Av - Average detection

Quasi-Peak Emissions

Range 2: Phase N .15 - 30MHz

Frequency (MHz)	Meter Reading (dBuV)	Det	101836_With EX_N[dB]	CABLELOS S(dB)	Corrected Reading (dB(uVolts))	CFR 47 FCC PART 15 Class B QP	Margin (dB)	CFR 47 FCC PART 15 Class B AV	Margin (dB)
.39	35.15	Qp	9.8	.2	45.15	58.06	-12.91	-	-
13.56	46.09	Qp	10	.4	56.49	60	-3.51	-	-

Qp - Quasi-Peak detector

9. FREQUENCY STABILITY

LIMIT

§15.225 (e) The frequency tolerance of the carrier signal shall be maintained within $\pm 0.01\%$ of the operating frequency, over a temperature variation of -20 degrees to +50 degrees C at normal supply voltage, and for a variation in the primary supply voltage from 85% to 115% of the rated supply voltage at a temperature of 20 degrees C. For battery operated equipment, the equipment tests shall be performed using a new battery.

TEST PROCEDURE

ANSI C63.10 §6.8

RESULTS

Reference Frequency: EUT Channel 13.56 MHz @ 20°C Limit: ± 100 ppm = 1.356 kHz										
Power Supply (Vdc)	Envir. Temp (°C)	Frequency Deviation Measured with Time Elapse								
		Start up (MHz)	Delta (ppm)	@ 2mins (MHz)	Delta (ppm)	@ 5mins (MHz)	Delta (ppm)	@ 10 mins (MHz)	Delta (ppm)	Limit (ppm)
3.88	50	13.559915462	-4.815	13.559910566	-5.176	13.559906719	-5.460	13.559904964	-5.589	100
3.88	40	13.559957401	-1.722	13.559945189	-2.623	13.559933871	-3.457	13.559922475	-4.298	100
3.88	30	13.560039300	4.318	13.560014756	2.508	13.559988562	0.576	13.559966616	-1.043	100
3.88	20	13.559980753	0	13.559980539	-0.016	13.559981020	0.020	13.559981197	0.033	100
3.88	10	13.559990358	0.708	13.559998168	1.284	13.560004002	1.715	13.560009929	2.152	100
3.88	0	13.560005638	1.835	13.560011843	2.293	13.560018072	2.752	13.560024296	3.211	100
3.88	-10	13.560062405	6.022	13.560062556	6.033	13.560062579	6.034	13.560062689	6.042	100
3.88	-20	13.560067100	6.368	13.560068154	6.446	13.560068939	6.503	13.560069411	6.538	100
3.88	-30	13.560063947	6.135	13.560031358	3.732	13.560058002	5.697	13.560055343	5.501	100

Reference Frequency: EUT Channel 13.56 MHz @ 20°C Limit: ± 100 ppm = 1.356 kHz										
Power Supply (Vdc)	Envir. Temp (°C)	Frequency Deviation Measured with Time Elapse								
		Start up (MHz)	Delta (ppm)	@ 2mins (MHz)	Delta (ppm)	@ 5mins (MHz)	Delta (ppm)	@ 10 mins (MHz)	Delta (ppm)	Limit (ppm)
3.88	20	13.559930819	0	13.559937661	0.505	13.559943850	0.961	13.559947750	1.249	100
4.47	20	13.559948270	1.287	13.559948959	1.338	13.559950605	1.459	13.559951163	1.500	100
3.65	20	13.559950976	1.487	13.559949576	1.383	13.559948525	1.306	13.559948774	1.324	100

No non-compliance noted.

END OF TEST REPORT