

# KCTL Inc.

65, Sinwon-ro, Yeongtong-gu,  
Suwon-si, Gyeonggi-do, 16677, Korea  
TEL: 82-31-285-0894 FAX: 82-505-299-8311  
[www.kctl.co.kr](http://www.kctl.co.kr)

Report No.:  
KR21-SRF0236  
Page (81) of (104)



## 15M BW QPSK Low ch. 1RB

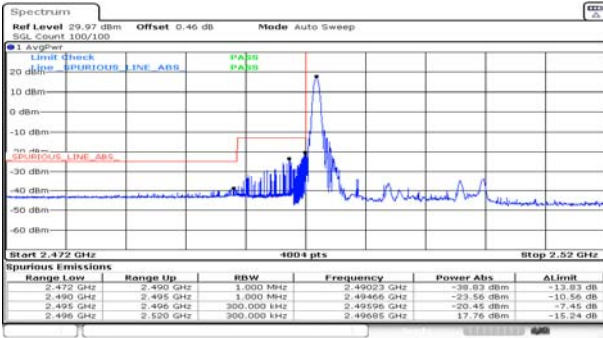

## 15M BW QPSK High ch. 1RB

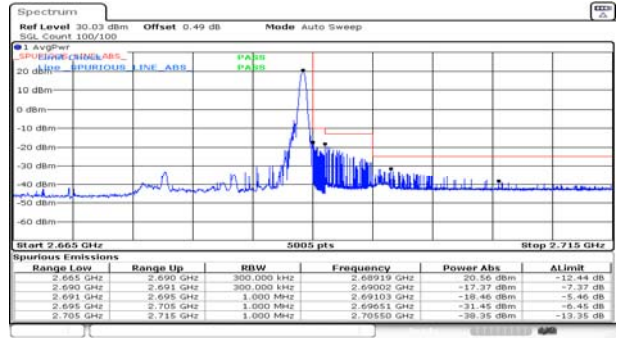

## 15M BW / QPSK / Low ch. / FRB

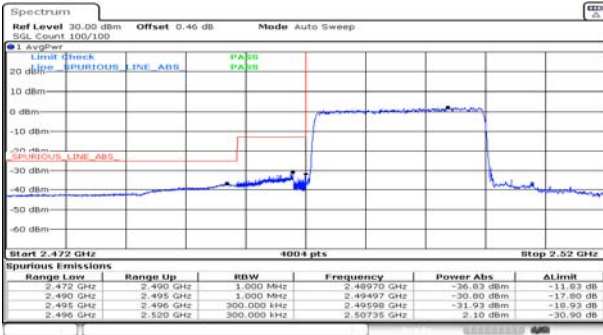

## 15M BW / QPSK / High ch. / FRB

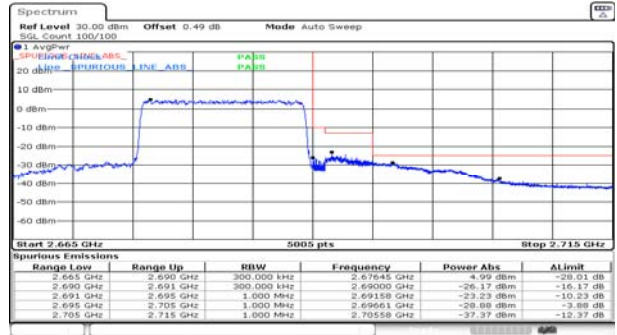

## 15M BW 16QAM Low ch. 1RB

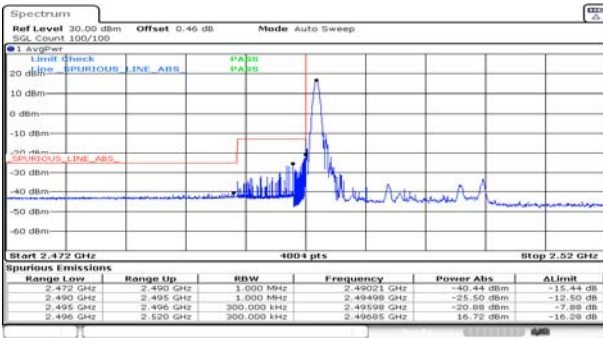

## 15M BW 16QAM High ch. 1RB

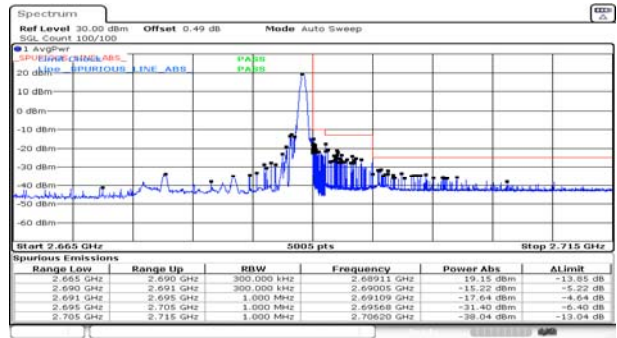

## 15M BW 16QAM Low ch. FRB

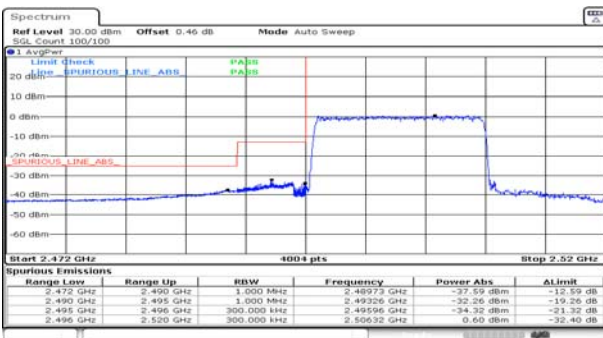

## 15M BW 16QAM High ch. FRB

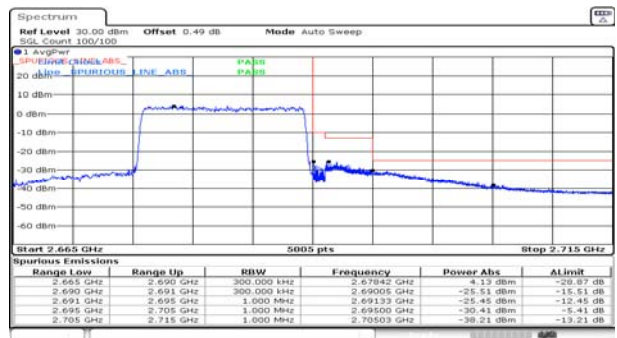

# KCTL Inc.

65, Sinwon-ro, Yeongtong-gu,  
Suwon-si, Gyeonggi-do, 16677, Korea  
TEL: 82-31-285-0894 FAX: 82-505-299-8311  
[www.kctl.co.kr](http://www.kctl.co.kr)

Report No.:  
KR21-SRF0236  
Page (82) of (104)



## 20M BW QPSK Low ch. 1RB

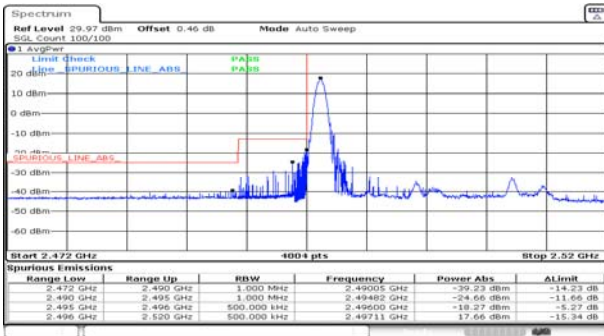

## 20M BW QPSK High ch. 1RB

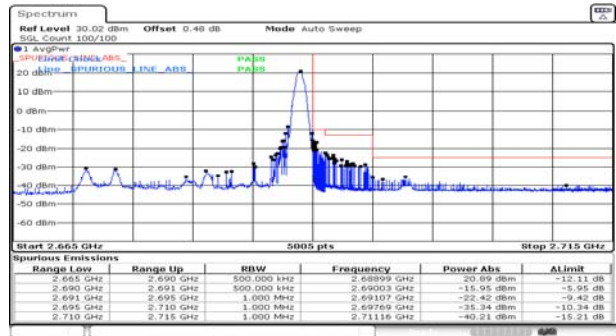

## 20M BW QPSK Low ch. FRB

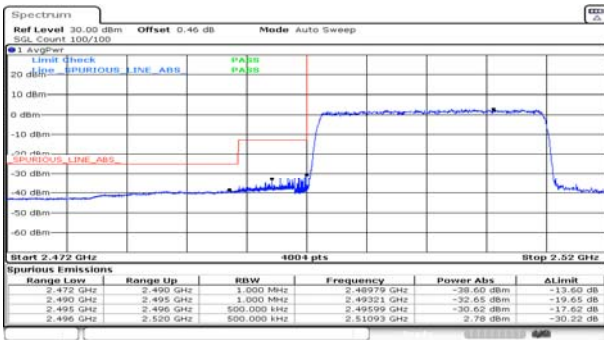

## 20M BW QPSK High ch. FRB

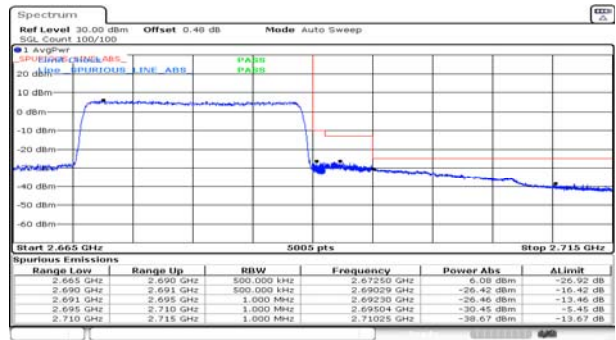

## 20M BW 16QAM Low ch. 1RB

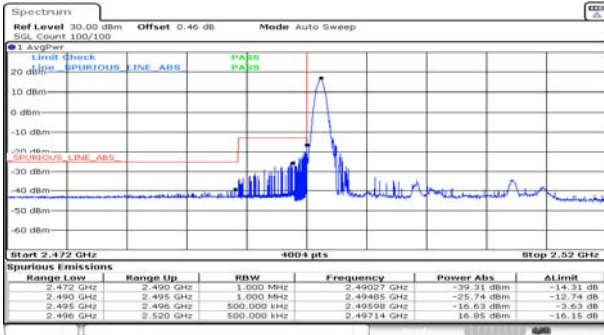

## 20M BW 16QAM High ch. 1RB

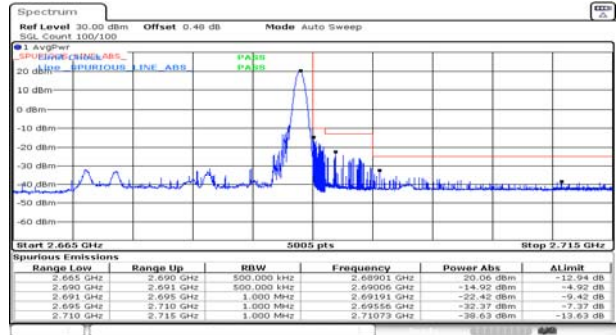

## 20M BW 16QAM Low ch. FRB

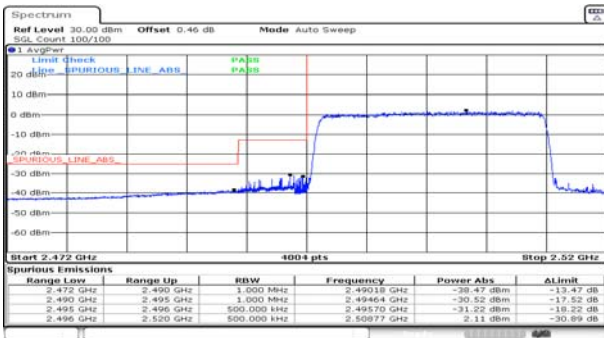

## 20M BW 16QAM High ch. FRB

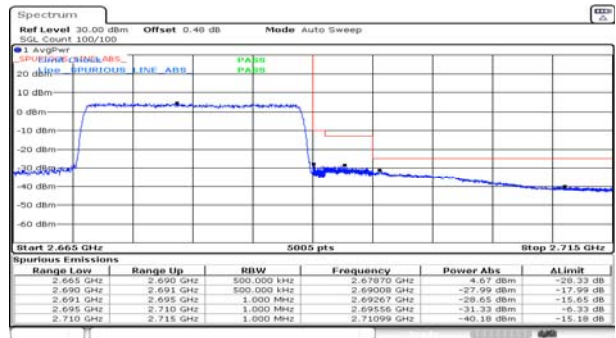

## 7.5. Peak to Average Power Ratio (PAPR)

### Test setup

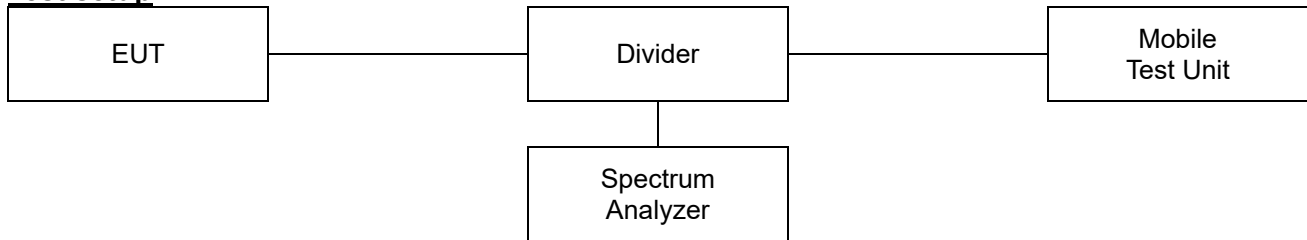

### Limit

According to §27.50(d)(5), the peak-to-average ratio(PAR) of the transmission must not exceed 13 dB.

### Test procedure

971168 D01 v03r01 - Section 5.7.2

ANSI 63.26-2015 – Section 5.2.3.4

### Test settings

#### 5.2.3.4 Measurement of peak power in a broadband noise-like signal using CCDF

- 1) Set resolution/measurement bandwidth  $\geq$  OBW or specified reference bandwidth
- 2) Set the number of counts to a value that stabilizes the measured CCDF curve.
- 3) Set the measurement interval as follows:
  - a) For continuous transmissions, set to the greater of [10 x (number of points in sweep) x (transmission symbol period)] or 1 ms .
  - b) For burst transmissions, employ an external trigger that is synchronized with the EUT burst timing sequence, or use the internal burst trigger with a trigger level that allows the burst to stabilize. Set the measurement interval to a time that is less than or equal to the burst duration.
  - c) If there are several carriers in a single antenna port, the peak power shall be determined for each individual carrier (by disabling the other carriers while measuring the required carrier) and the total peak power calculated from the sum of the individual carrier peak powers.
- 4) Record the maximum PAPR level associated with a probability of 0.1%

#### 5.2.6 Peak-to-average power ratio

Use one of the procedures presented in 5.2(ANSI C63.26-2015) to measure the total peak power and record as  $P_{PK}$ .

Use one of the applicable procedure presented 5.2(ANSI C63.26-2015) to measure the total average power and record as  $P_{AG}$ . Determine the P.A.P.R from:

$$PAPR(\text{dB}) = P_{PK}(\text{dBm or dBW}) - P_{AG}(\text{dBm or dBW})$$



# KCTL Inc.

65, Sinwon-ro, Yeongtong-gu,  
Suwon-si, Gyeonggi-do, 16677, Korea  
TEL: 82-31-285-0894 FAX: 82-505-299-8311  
[www.kctl.co.kr](http://www.kctl.co.kr)

Report No.:  
KR21-SRF0236  
Page (84) of (104)



## Test results

### Test mode: LTE Band 41

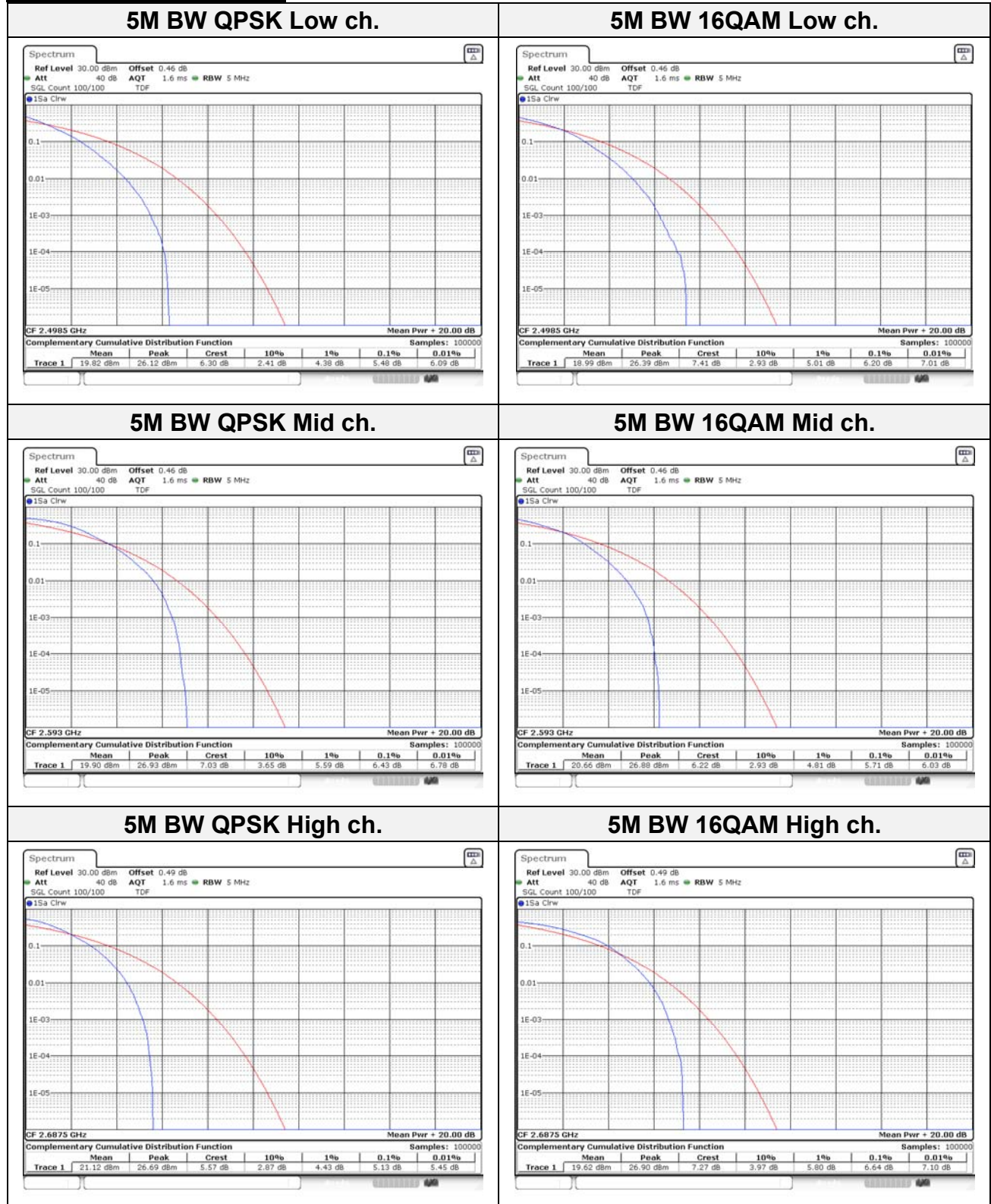

# KCTL Inc.

65, Sinwon-ro, Yeongtong-gu,  
Suwon-si, Gyeonggi-do, 16677, Korea  
TEL: 82-31-285-0894 FAX: 82-505-299-8311  
[www.kctl.co.kr](http://www.kctl.co.kr)

Report No.:  
KR21-SRF0236  
Page (85) of (104)



## 10M BW QPSK Low ch.

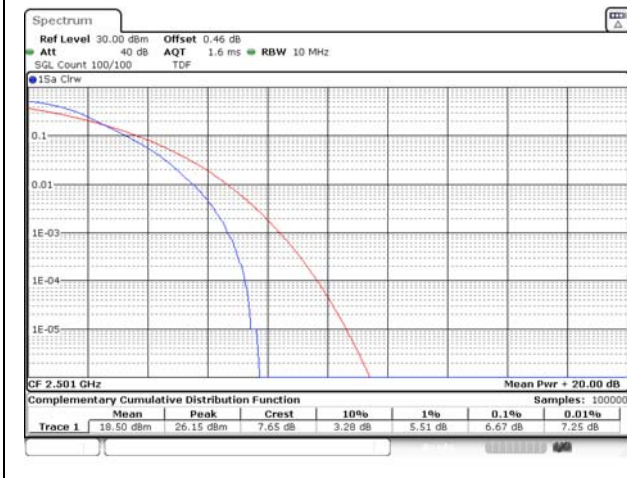

## 10M BW 16QAM Low ch.

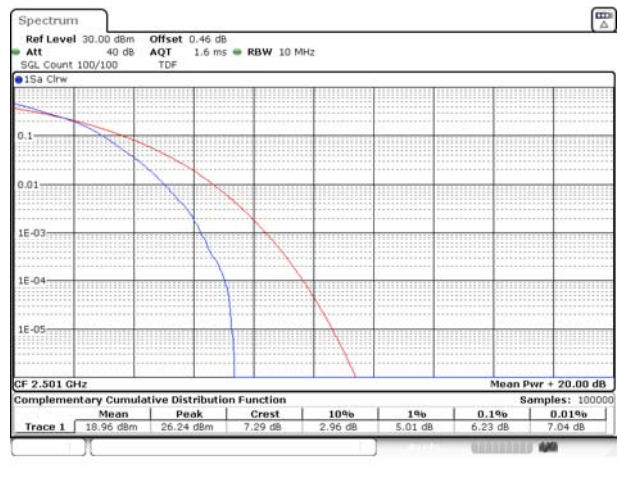

## 10M BW QPSK Mid ch.

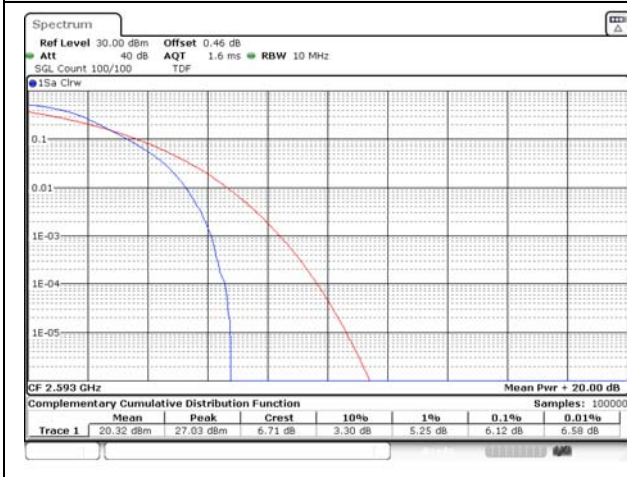

## 10M BW 16QAM Mid ch.

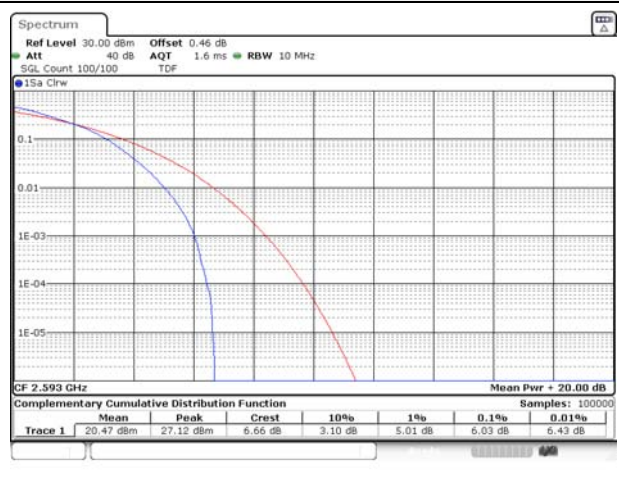

## 10M BW QPSK High ch.

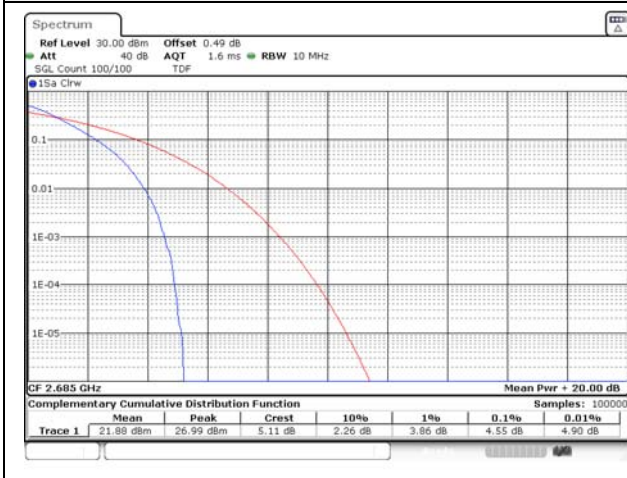

## 10M BW 16QAM High ch.

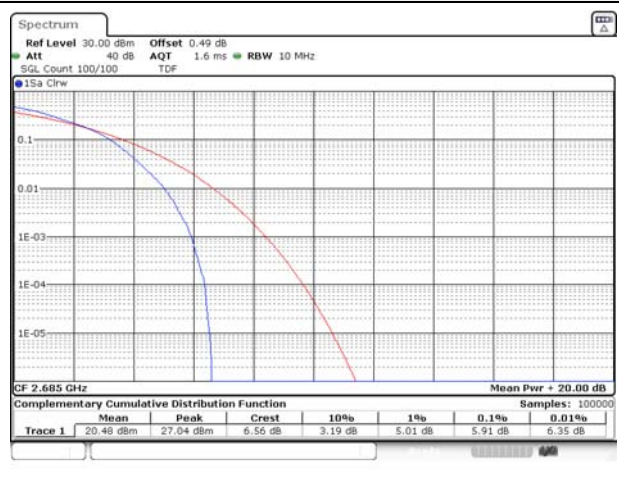

# KCTL Inc.

65, Sinwon-ro, Yeongtong-gu,  
Suwon-si, Gyeonggi-do, 16677, Korea  
TEL: 82-31-285-0894 FAX: 82-505-299-8311  
[www.kctl.co.kr](http://www.kctl.co.kr)

Report No.:  
KR21-SRF0236  
Page (86) of (104)



## 15M BW QPSK Low ch.

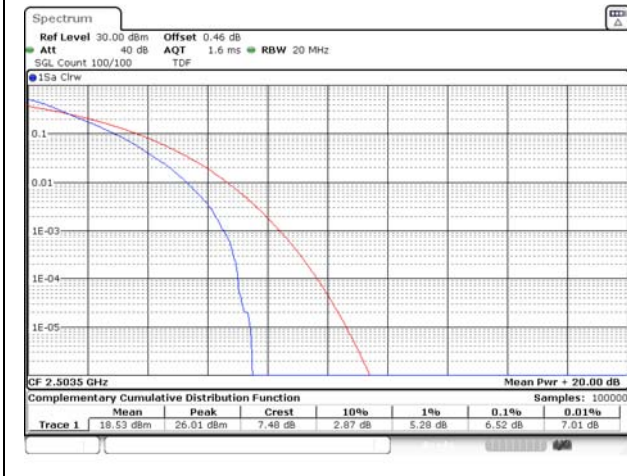

## 15M BW 16QAM Low ch.

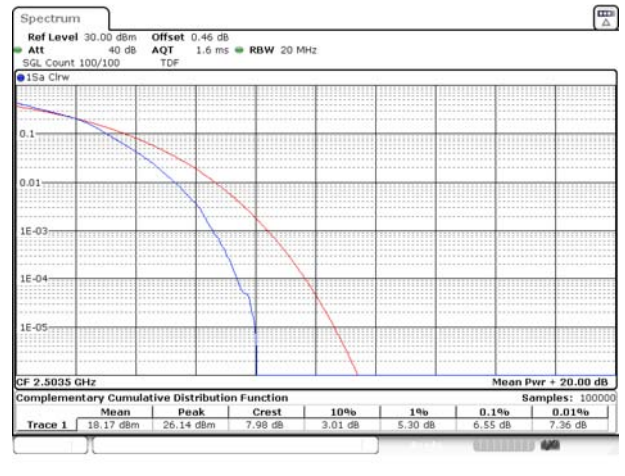

## 15M BW QPSK Mid ch.

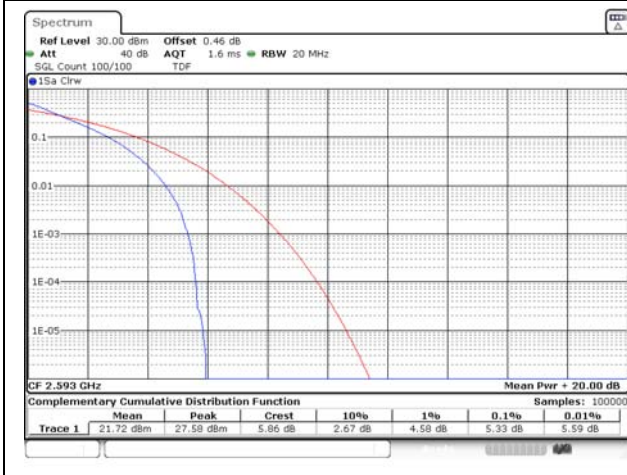

## 15M BW 16QAM Mid ch.

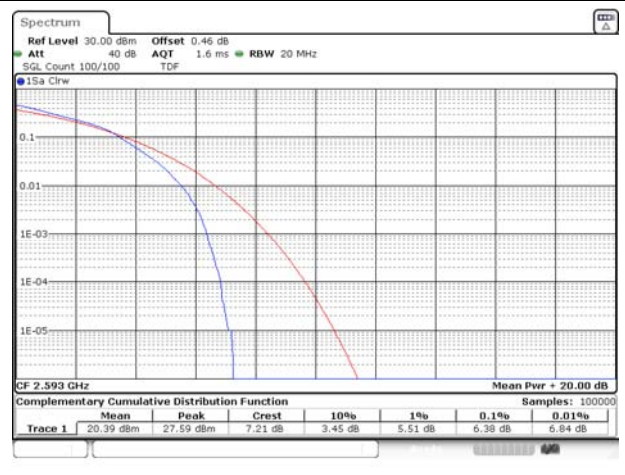

## 15M BW QPSK High ch.

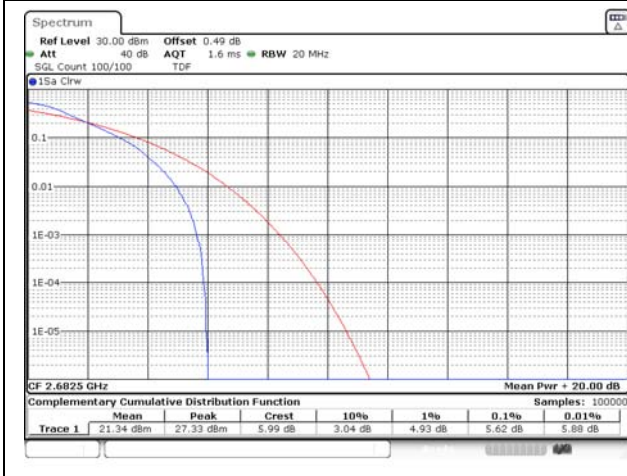

## 15M BW 16QAM High ch.

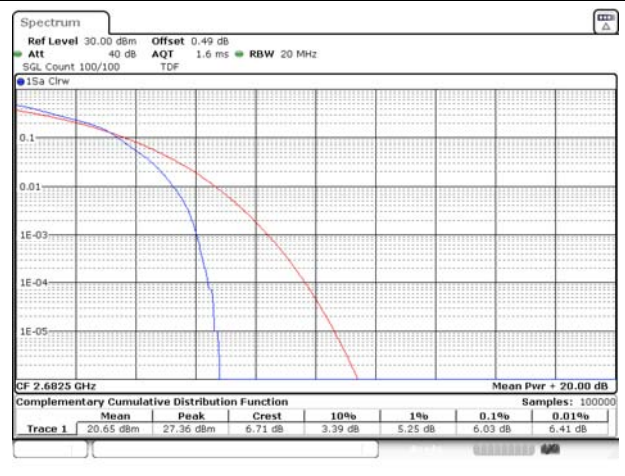



# KCTL Inc.

65, Sinwon-ro, Yeongtong-gu,  
Suwon-si, Gyeonggi-do, 16677, Korea  
TEL: 82-31-285-0894 FAX: 82-505-299-8311  
[www.kctl.co.kr](http://www.kctl.co.kr)

Report No.:  
KR21-SRF0236  
Page (87) of (104)



## 20M BW QPSK Low ch.

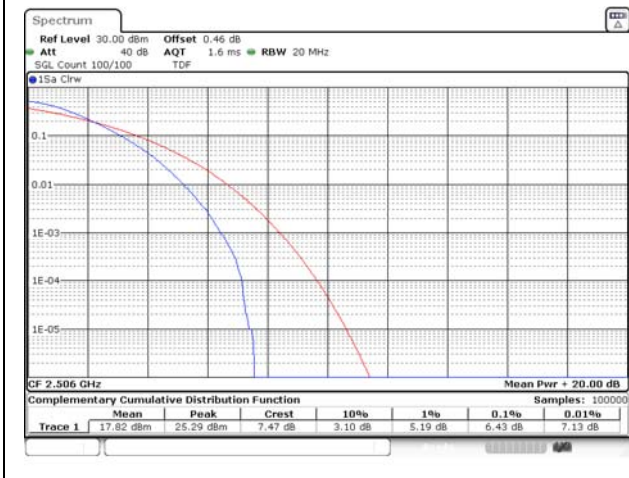

## 20M BW 16QAM Low ch.

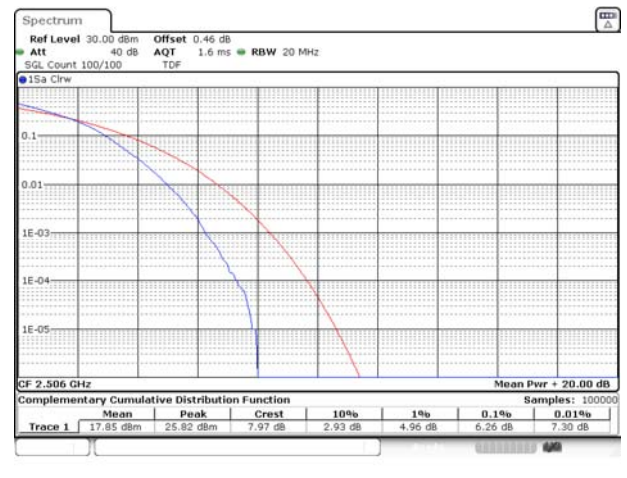

## 20M BW QPSK Mid ch.

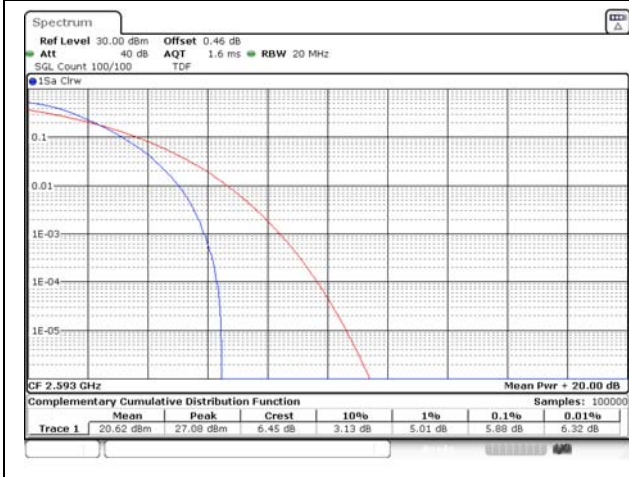

## 20M BW 16QAM Mid ch.

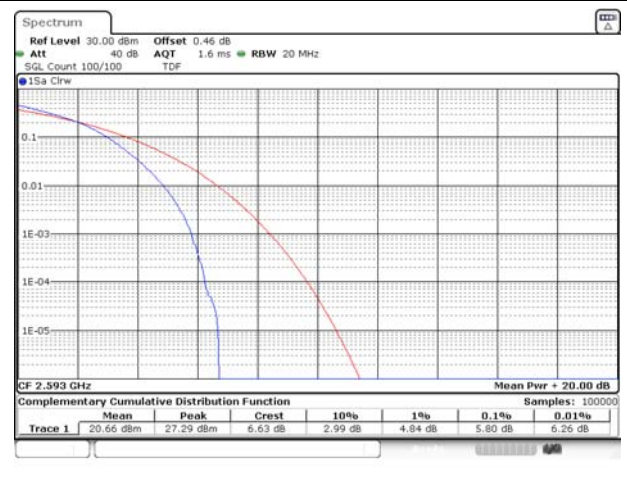

## 20M BW QPSK High ch.

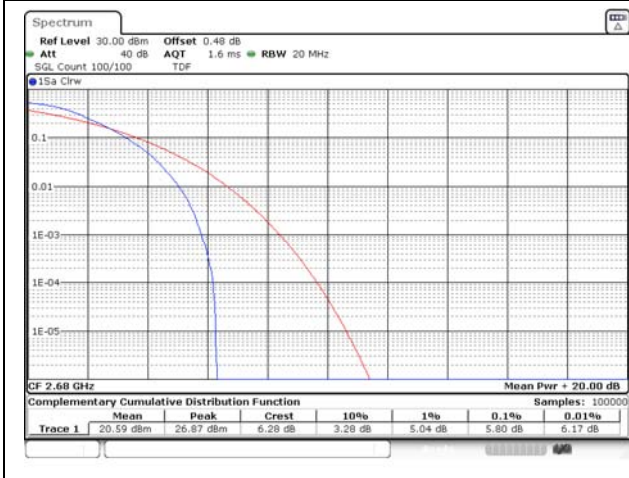

## 20M BW 16QAM High ch.

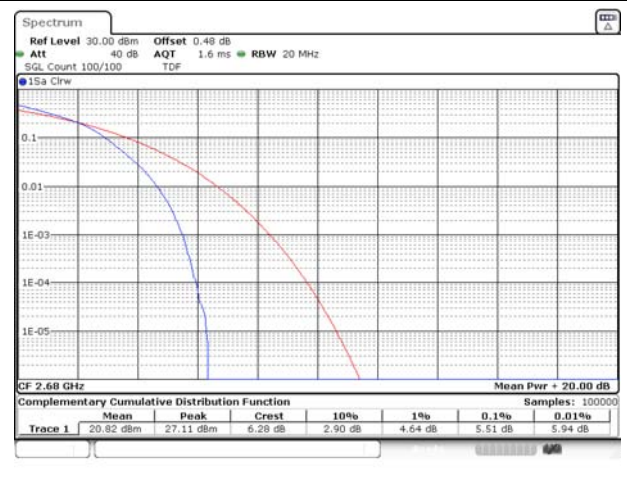

## 7.6. Frequency stability

### Test setup

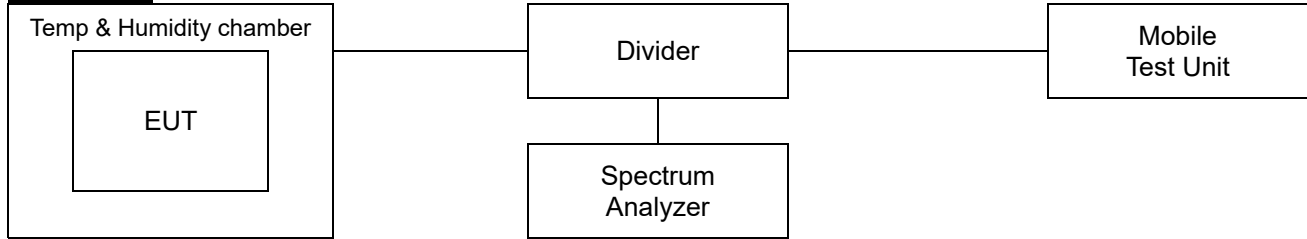

### Limit

#### According to §2.1055(a),

The frequency stability shall be measured with variation of ambient temperature as follows:

- 1) From  $-30^{\circ}$  to  $+50^{\circ}$  centigrade for all equipment except that specified in paragraphs (a) (2) and (3) of this section.
- 2) From  $-20^{\circ}$  to  $+50^{\circ}$  centigrade for equipment to be licensed for use in the maritime services under part 80 of this chapter, except for class A, B, and S emergency position indicating radiobeacons (EPIRBS), and equipment to be licensed for use above 952 MHz at operational fixed stations in all services, stations in the local television transmission service and point-to-point microwave radio service under part 21 of this chapter, equipment licensed for use aboard aircraft in the aviation services under part 87 of this chapter, and equipment authorized for use in the family radio service under part 95 of this chapter.
- 3) From  $0^{\circ}$  to  $+50^{\circ}$  centigrade for equipment to be licensed for use in the radio broadcast Services under part 73 of this chapter.

#### According to §2.1055(d),

The frequency stability shall be measured with variation of primary supply Voltage as follows:

- 1) Vary primary supply voltage from 85 to 115 percent of the nominal value for other than hand carried battery equipment.
- 2) For hand carried, battery powered equipment, reduce primary supply voltage to the battery operating and point which shall be specified by the manufacturer.
- 3) The supply voltage shall be measured at the input to the cable normally provided with the equipment, or at the power supply terminals if cables are not normally provided. Effects on frequency of transmitter keying (except for broadcast transmitters) and any heating element cycling at the nominal supply voltage and at each extreme also shall be shown.

#### According to §22.355,

The carrier frequency of each transmitter in the public mobile services must be maintained within the tolerances given in Table of this section.

For mobile devices operating in the 824 to 849 MHz band at a power level than or equal to 3 Watts, the limit specified in Table C-1 is  $\pm 2.5$  ppm.

#### According to §27.54,

The frequency stability shall be sufficient to ensure that the fundamental emission stays within the authorized frequency block.



**KCTL Inc.**

65, Sinwon-ro, Yeongtong-gu,  
Suwon-si, Gyeonggi-do, 16677, Korea  
TEL: 82-31-285-0894 FAX: 82-505-299-8311  
[www.kctl.co.kr](http://www.kctl.co.kr)

Report No.:  
KR21-SRF0236  
Page (89) of (104)

**Test procedure**

ANSI 63.26-2015 – Section 5.6

**Test settings**

- 1) The carrier frequency of the transmitter is measured at room temperature.  
(20°C to provide a reference)
- 2) The equipment is turned on in a “standby” condition for one minute before applying power to the transmitter. Measurement of the carrier frequency of the transmitter is made within one minute after applying power to the transmitter.
- 3) Frequency measurements are made at 10°C intervals ranging from -30°C to +50°C.  
A period of at least one half-hour is provided to allow stabilization of the equipment at each Temperature level.

**KCTL Inc.**

65, Sinwon-ro, Yeongtong-gu,  
Suwon-si, Gyeonggi-do, 16677, Korea  
TEL: 82-31-285-0894 FAX: 82-505-299-8311  
[www.kctl.co.kr](http://www.kctl.co.kr)

Report No.:  
KR21-SRF0236  
Page (90) of (104)

**Test results**

Test mode : LTE Band 5  
Frequency (Hz) : 836 500 000  
Channel : 20525  
Deviation limit : ±0.00025% or 2.5ppm

Voltage (%)	Power (V)	Temp. (°C)	Frequency (Hz)	Frequency error (Hz)	Deviation	
					(ppm)	(%)
100%	3.88	+22(Ref)	836,499,996	-4.31	0.0	-0.000001
		-30	836,499,996	-4.18	0.0	0.000000
		-20	836,499,992	-8.41	0.0	-0.000001
		-10	836,499,993	-6.78	0.0	-0.000001
		0	836,499,997	-3.33	0.0	0.000000
		+10	836,499,998	-1.66	0.0	0.000000
		+20	836,499,998	-2.19	0.0	0.000000
		+30	836,500,000	0.34	0.0	0.000000
		+40	836,500,002	1.66	0.0	0.000000
		+50	836,500,003	2.97	0.0	0.000000
115%	4.46	+22(Ref)	836,499,996	-3.81	0.0	0.000000
End point	3.40	+22(Ref)	836,499,995	-4.51	0.0	-0.000001

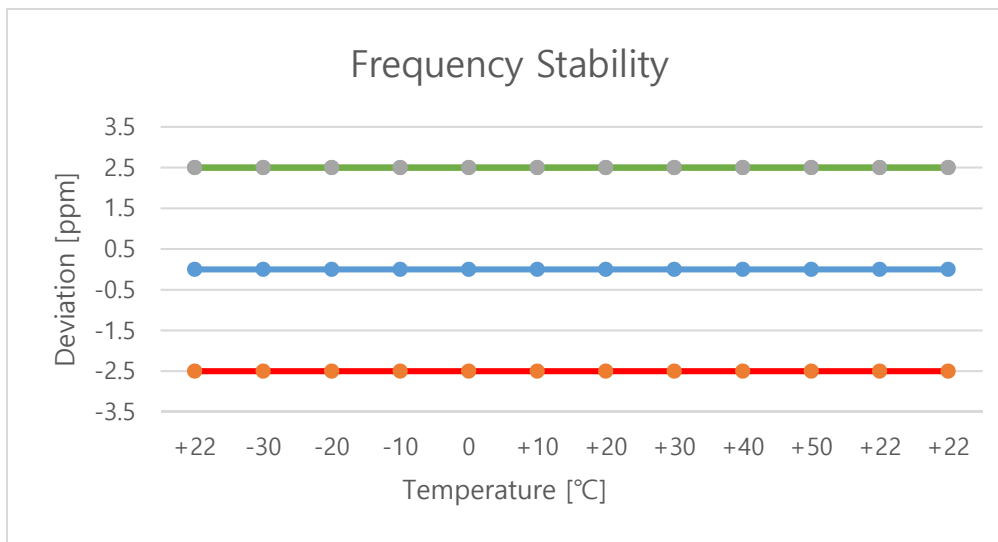

**KCTL Inc.**

65, Sinwon-ro, Yeongtong-gu,  
Suwon-si, Gyeonggi-do, 16677, Korea  
TEL: 82-31-285-0894 FAX: 82-505-299-8311  
[www.kctl.co.kr](http://www.kctl.co.kr)

Report No.:  
KR21-SRF0236  
Page (91) of (104)



Test mode : LTE Band 12  
 Frequency (Hz) : 707 500 000  
 Channel : 23095  
 Deviation limit : The frequency stability shall be sufficient to ensure that the fundamental emission stays within the authorized bands of operation

Voltage (%)	Power (V)	Temp. (°C)	Frequency (Hz)	Frequency error (Hz)	Deviation	
					(ppm)	(%)
100%	3.88	+22(Ref)	707,500,004	4.41	0.0	0.000001
		-30	707,499,999	-0.93	0.0	0.000000
		-20	707,499,999	-1.10	0.0	0.000000
		-10	707,499,996	-4.11	0.0	-0.000001
		0	707,499,997	-2.88	0.0	0.000000
		+10	707,500,000	0.34	0.0	0.000000
		+20	707,500,002	1.55	0.0	0.000000
		+30	707,500,005	5.41	0.0	0.000001
		+40	707,500,003	3.44	0.0	0.000000
		+50	707,500,005	4.55	0.0	0.000001
115%	4.46	+22(Ref)	707,500,003	2.96	0.0	0.000000
End point	3.40	+22(Ref)	707,500,003	2.59	0.0	0.000000

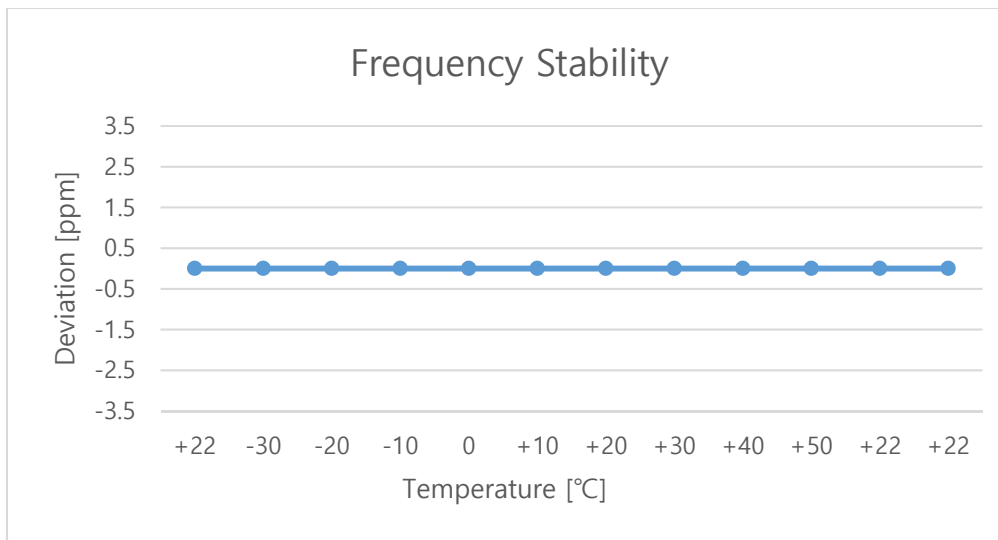



**KCTL Inc.**

65, Sinwon-ro, Yeongtong-gu,  
Suwon-si, Gyeonggi-do, 16677, Korea  
TEL: 82-31-285-0894 FAX: 82-505-299-8311  
[www.kctl.co.kr](http://www.kctl.co.kr)

Report No.:  
KR21-SRF0236  
Page (92) of (104)



Test mode : LTE Band 41  
 Frequency (Hz) : 2 593 000 000  
 Channel : 40620  
 Deviation limit : The frequency stability shall be sufficient to ensure that the fundamental emission stays within the authorized bands of operation.

Voltage (%)	Power (V)	Temp. (°C)	Frequency (Hz)	Frequency error (Hz)	Deviation	
					(ppm)	(%)
100%	3.88	+22(Ref)	2,592,999,995	-5.16	0.0	0.000000
		-30	2,593,000,008	7.82	0.0	0.000000
		-20	2,593,000,005	5.44	0.0	0.000000
		-10	2,593,000,006	6.13	0.0	0.000000
		0	2,593,000,002	2.08	0.0	0.000000
		+10	2,592,999,997	-3.19	0.0	0.000000
		+20	2,592,999,996	-4.09	0.0	0.000000
		+30	2,592,999,998	-2.19	0.0	0.000000
		+40	2,592,999,999	-1.37	0.0	0.000000
115%	4.46	+22	2,592,999,994	-6.44	0.0	0.000000
End point	3.40	+22	2,592,999,994	-5.77	0.0	0.000000

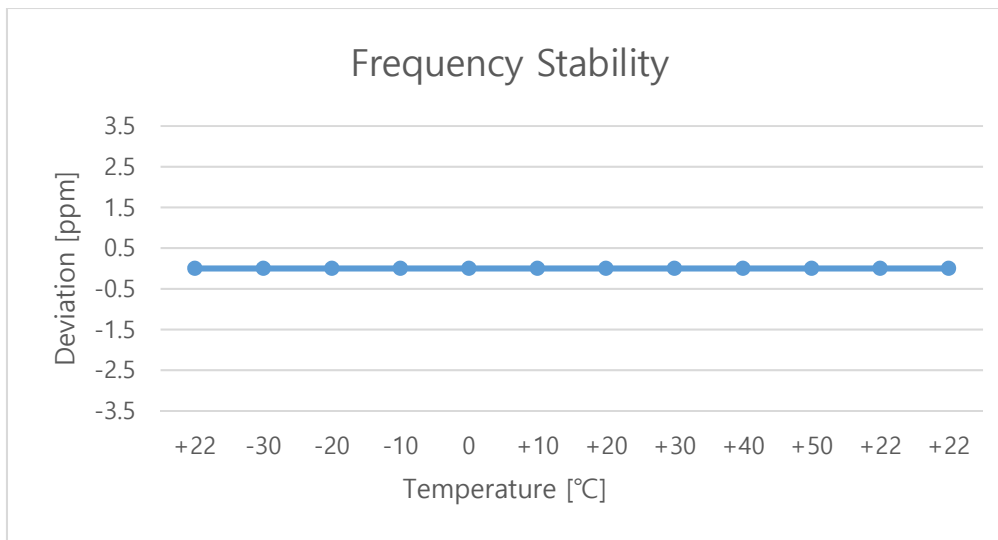

## 7.7. Radiated Power (ERP/EIRP)

### Test setup

The diagram below shows the test setup that is utilized to make the measurements for emission from 30 MHz to 1 GHz emissions.

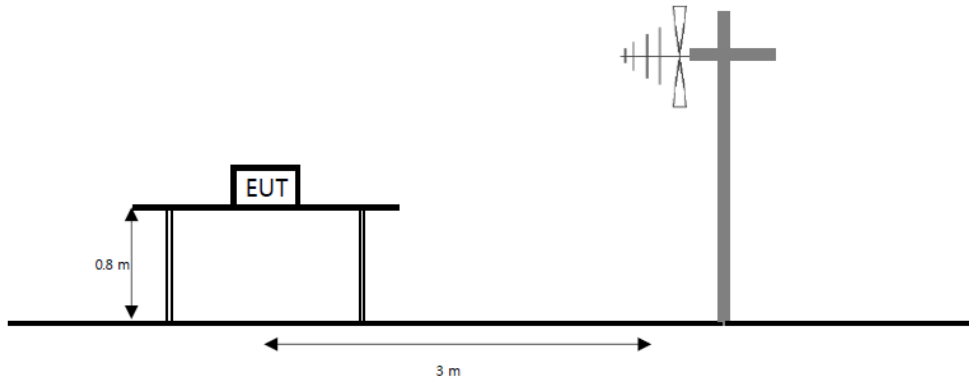

The diagram below shows the test setup that is utilized to make the measurements for emission from 1 GHz to the tenth harmonic of the highest fundamental frequency or to 40 GHz emissions, whichever is lower.

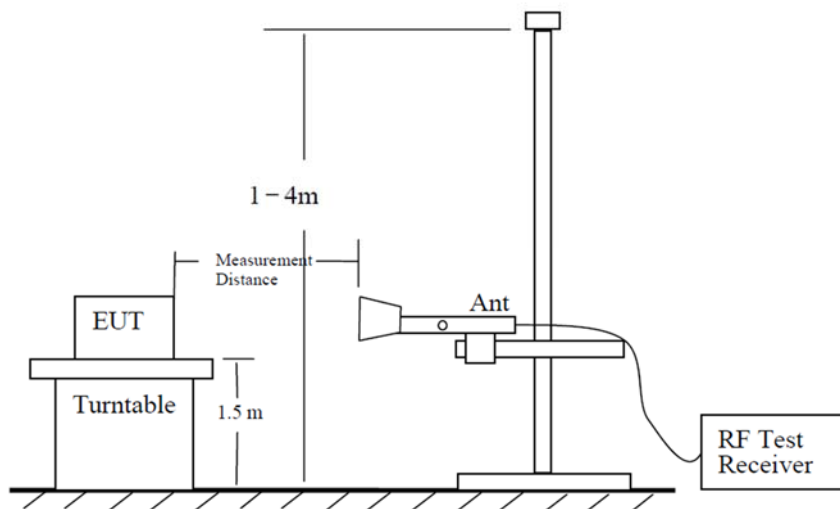

The diagram below shows the test setup for substituted method.

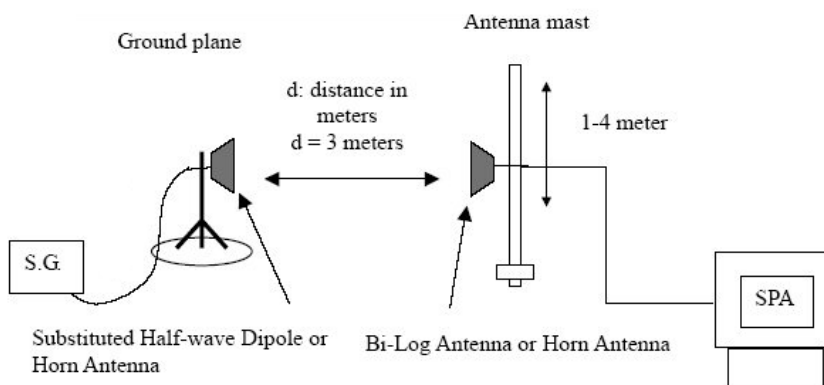

## KCTL Inc.

65, Sinwon-ro, Yeongtong-gu,  
Suwon-si, Gyeonggi-do, 16677, Korea  
TEL: 82-31-285-0894 FAX: 82-505-299-8311  
[www.kctl.co.kr](http://www.kctl.co.kr)

Report No.:  
KR21-SRF0236  
Page (94) of (104)

# KCTL

### Limit

According to §22.913(a)(5), The ERP of mobile transmitters and auxiliary test transmitters must not exceed 7 watts.

According to §27.50(c)(10), Portable stations (hand-held devices) in the 600 MHz uplink band and the 698-746 MHz band, and fixed and mobile stations in the 600 MHz uplink band are limited to 3 watts ERP.

According to §27.50(h)(2), the Mobile stations are limited to 2.0 watts EIRP. All user stations are limited to 2.0 watts transmitter output power.

### Test procedure

971168 D01 v03r01 - Section 5.2 and 5.8, 412172 D01 v01r01  
ANSI 63.26-2015 – Section 5.2  
ANSI/TIA-603-E-2016 - Section 2.2.17

### Test settings

- 1) RBW = 1 % to 5 % of the OBW.
- 2) VBW  $\geq 3 \times$  RBW.
- 3) SPAN = 2  $\times$  to 3  $\times$  the OBW.
- 4) Number of measurement points in sweep  $\geq 2 \times$  span / RBW.
- 5) Sweep time :
  - 1) Auto couple, or
  - 2)  $\geq [10 \times (\text{number of points in sweep}) \times (\text{transmission period})]$  for single sweep (automation-compatible) measurement. Transmission period is the on and off time of the transmitter.
- 6) Detector = RMS
- 7) If the EUT can be configured to transmit continuously, then set the trigger to free run.
- 8) If the EUT cannot be configured to transmit continuously, then use a sweep trigger with the level set to enable triggering only on full power bursts and configure the EUT to transmit at full power for the entire duration of each sweep. Verify that the sweep time is less than or equal to the transmission burst duration. Time gating can also be used under similar constraints (i.e., configured such that measurement data is collected only during active full-power transmissions).
- 9) Trace mode = trace averaging (RMS) over 100 sweeps.
- 10) Compute the power by integrating the spectrum across the OBW of the signal using the instrument's band or channel power measurement function, with the band/channel limits set equal to the OBW band edges. If the instrument does not have a band or channel power function, then sum the spectrum levels (in linear power units) at intervals equal to the RBW extending across the entire OBW of the spectrum.
- 11) Allow trace to fully stabilize.



**KCTL Inc.**

65, Sinwon-ro, Yeongtong-gu,  
Suwon-si, Gyeonggi-do, 16677, Korea  
TEL: 82-31-285-0894 FAX: 82-505-299-8311  
[www.kctl.co.kr](http://www.kctl.co.kr)

Report No.:  
KR21-SRF0236  
Page (95) of (104)

**Notes:**

1. On a test site, the EUT shall be placed at 80 cm or 1.5 m height on a turn table, and in the position close to normal use as declared by the applicant.
2. The test antenna shall be oriented initially for vertical polarization located 3 m from EUT to correspond to the fundamental frequency of the transmitter.
3. The turntable is rotated through 360°, and the receiving antenna scans in order to determine the Level of the maximized emission.
4. The test antenna shall be raised and lowered again through the specified range of height until the maximum signal level is detected by the measuring receiver.
5. The maximum signal level detected by the measuring receiver shall be noted.
6. The EUT was replaced by half-wave dipole (1 GHz below) or horn antenna (1 GHz above) connected to a signal generator.  
The power is calculated by the following formula;  
$$Pd(\text{dBm}) = Pg(\text{dBm}) - \text{Cable loss (dB)} + \text{Antenna gain (dB)}$$
  
Note. Pd is the dipole equivalent power and Pg is the generator output power into the substitution antenna.
7. The test antenna shall be raised and lowered through the specified range of height to ensure that The maximum signal is received.
8. The input signal to the substitution antenna shall be adjusted to the level that produces a level Detected by the measuring corrected for the change of input attenuator setting of the measuring Receiver.
9. The input level to the substitution antenna shall be recorded as power level in dBm, corrected for Any change of input attenuator setting of the measuring receiver.
10. The measurement shall be repeated with the test antenna and the substitution antenna Orientated for horizontal polarization.

**KCTL Inc.**

65, Sinwon-ro, Yeongtong-gu,  
Suwon-si, Gyeonggi-do, 16677, Korea  
TEL: 82-31-285-0894 FAX: 82-505-299-8311  
[www.kctl.co.kr](http://www.kctl.co.kr)

Report No.:  
KR21-SRF0236  
Page (96) of (104)

**Test results****Test mode: LTE Band 5**

Bandwidth	Modulation	Frequency	Pol.	Antenna Gain	C.L	Substitute Level	ERP	
		[MHz]	[V/H]	[dBd]	[dB]	[dBm]	[dBm]	[W]
1.4 M	QPSK	824.7	V	-1.98	5.31	27.34	20.05	0.101
		836.5	V	-2.43	5.40	26.72	18.89	0.077
		848.3	V	-2.78	5.45	27.86	19.63	0.092
	16QAM	824.7	V	-1.98	5.31	26.34	19.05	0.080
		836.5	V	-2.43	5.40	25.75	17.92	0.062
		848.3	V	-2.78	5.45	26.78	18.55	0.072
3 M	QPSK	825.5	V	-1.90	5.33	27.52	20.29	0.107
		836.5	V	-2.43	5.40	26.71	18.88	0.077
		847.5	V	-2.80	5.45	28.09	19.84	0.096
	16QAM	825.5	V	-1.90	5.33	26.69	19.46	0.088
		836.5	V	-2.43	5.40	25.69	17.86	0.061
		847.5	V	-2.80	5.45	27.21	18.96	0.079
5 M	QPSK	826.5	V	-1.80	5.33	27.56	20.43	0.110
		836.5	V	-2.43	5.40	26.75	18.92	0.078
		846.5	V	-2.82	5.44	27.81	19.55	0.090
	16QAM	826.5	V	-1.80	5.33	26.95	19.82	0.096
		836.5	V	-2.43	5.40	26.16	18.33	0.068
		846.5	V	-2.82	5.44	26.89	18.63	0.073
10 M	QPSK	829.0	V	-1.55	5.34	27.61	20.72	0.118
		836.5	V	-2.43	5.40	26.90	19.07	0.081
		844.0	V	-2.87	5.43	27.50	19.20	0.083
	16QAM	829.0	V	-1.55	5.34	26.57	19.68	0.093
		836.5	V	-2.43	5.40	26.22	18.39	0.069
		844.0	V	-2.87	5.43	26.84	18.54	0.071

Note.

1. E.R.P & E.I.R.P(dBm) = Substitute Level(dB) + Antenna gain(dBi&dBd) - C.L(Cable loss) (dB)

**KCTL Inc.**

65, Sinwon-ro, Yeongtong-gu,  
Suwon-si, Gyeonggi-do, 16677, Korea  
TEL: 82-31-285-0894 FAX: 82-505-299-8311  
[www.kctl.co.kr](http://www.kctl.co.kr)

Report No.:  
KR21-SRF0236  
Page (97) of (104)

**KCTL****Test mode: LTE Band 12**

Bandwidth	Modulation	Frequency	Pol.	Antenna Gain	C.L	Substitute Level	ERP	
		[MHz]	[V/H]	[dBd]	[dB]	[dBm]	[dBm]	[W]
1.4 M	QPSK	699.7	V	-2.85	4.87	22.49	14.77	0.030
		707.5	V	-2.55	4.89	21.61	14.17	0.026
		715.3	V	-2.66	4.91	21.77	14.20	0.026
	16QAM	699.7	V	-2.85	4.87	21.25	13.53	0.023
		707.5	V	-2.55	4.89	20.80	13.36	0.022
		715.3	V	-2.66	4.91	20.81	13.24	0.021
3 M	QPSK	700.5	V	-2.83	4.86	22.26	14.57	0.029
		707.5	V	-2.55	4.89	22.01	14.57	0.029
		714.5	V	-2.63	4.91	21.90	14.36	0.027
	16QAM	700.5	V	-2.83	4.86	21.40	13.71	0.023
		707.5	V	-2.55	4.89	21.00	13.56	0.023
		714.5	V	-2.63	4.91	21.03	13.49	0.022
5 M	QPSK	701.5	V	-2.79	4.87	22.62	14.96	0.031
		707.5	V	-2.55	4.89	22.01	14.57	0.029
		713.5	V	-2.59	4.91	21.90	14.40	0.028
	16QAM	701.5	V	-2.79	4.87	21.91	14.25	0.027
		707.5	V	-2.55	4.89	21.23	13.79	0.024
		713.5	V	-2.59	4.91	21.27	13.77	0.024
10 M	QPSK	704.0	V	-2.69	4.89	22.12	14.54	0.028
		707.5	V	-2.55	4.89	21.97	14.53	0.028
		711.0	V	-2.49	4.90	22.46	15.07	0.032
	16QAM	704.0	V	-2.69	4.89	21.33	13.75	0.024
		707.5	V	-2.55	4.89	21.35	13.91	0.025
		711.0	V	-2.49	4.90	21.72	14.33	0.027

Note.

1. E.R.P & E.I.R.P(dBm) = Substitute Level(dB) + Antenna gain(dBi&dBd) - C.L(Cable loss) (dB)



**KCTL Inc.**

65, Sinwon-ro, Yeongtong-gu,  
Suwon-si, Gyeonggi-do, 16677, Korea  
TEL: 82-31-285-0894 FAX: 82-505-299-8311  
[www.kctl.co.kr](http://www.kctl.co.kr)

Report No.:  
KR21-SRF0236  
Page (98) of (104)

**Test mode: LTE Band 41**

Bandwidth	Modulation	Frequency	Pol.	Antenna Gain	C.L	Substitute Level	EIRP	
		[MHz]	[V/H]	[dBi]	[dB]	[dBm]	[dBm]	[W]
5 M	QPSK	2 498.5	H	6.00	9.21	22.23	19.02	0.080
		2 593.0	H	6.19	9.39	22.60	19.40	0.087
		2 687.5	H	6.38	9.59	19.10	15.88	0.039
	16QAM	2 498.5	H	6.00	9.21	18.71	15.50	0.035
		2 593.0	H	6.19	9.39	22.16	18.96	0.079
		2 687.5	H	6.38	9.59	16.03	12.81	0.019
10 M	QPSK	2 501.0	H	6.00	9.22	21.81	18.59	0.072
		2 593.0	H	6.19	9.39	22.75	19.55	0.090
		2 685.0	H	6.37	9.58	20.45	17.24	0.053
	16QAM	2 501.0	H	6.00	9.22	19.77	16.55	0.045
		2 593.0	H	6.19	9.39	21.01	17.81	0.060
		2 685.0	H	6.37	9.58	18.73	15.52	0.036
15 M	QPSK	2 503.5	H	6.01	9.21	21.05	17.85	0.061
		2 593.0	H	6.19	9.39	23.26	20.06	0.101
		2 682.5	H	6.37	9.59	20.27	17.04	0.051
	16QAM	2 503.5	H	6.01	9.21	21.56	18.36	0.069
		2 593.0	H	6.19	9.39	21.78	18.58	0.072
		2 682.5	H	6.37	9.59	18.79	15.56	0.036
20 M	QPSK	2 506.0	H	6.01	9.24	21.49	18.26	0.067
		2 593.0	H	6.19	9.39	23.02	19.82	0.096
		2 680.0	H	6.36	9.58	20.14	16.92	0.049
	16QAM	2 506.0	H	6.01	9.24	20.33	17.10	0.051
		2 593.0	H	6.19	9.39	22.43	19.23	0.084
		2 680.0	H	6.36	9.58	18.90	15.68	0.037

Note.

1. E.R.P & E.I.R.P(dBm) = Substitute Level(dB) + Antenna gain(dBi&dBd) - C.L(Cable loss) (dB)

## 7.8. Radiated Spurious Emissions

### Test setup

The diagram below shows the test setup that is utilized to make the measurements for emission from 30 MHz to 1 GHz emissions.

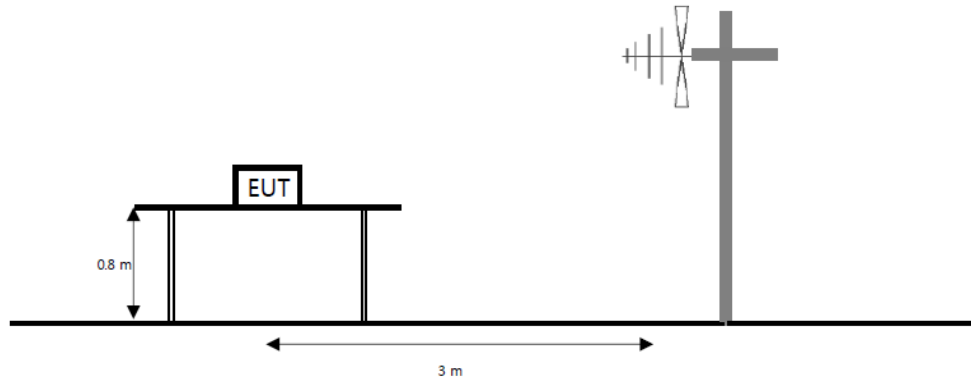

The diagram below shows the test setup that is utilized to make the measurements for emission from 1 GHz to the tenth harmonic of the highest fundamental frequency or to 40 GHz emissions, whichever is lower.

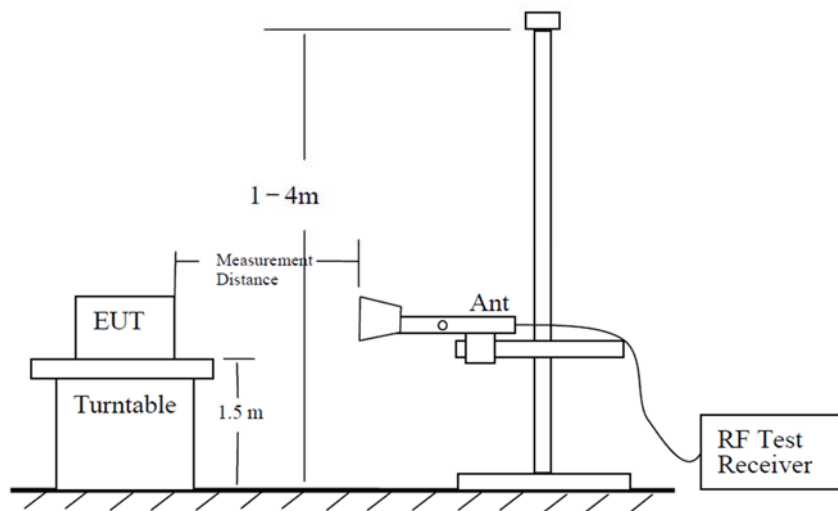

The diagram below shows the test setup for substituted method.

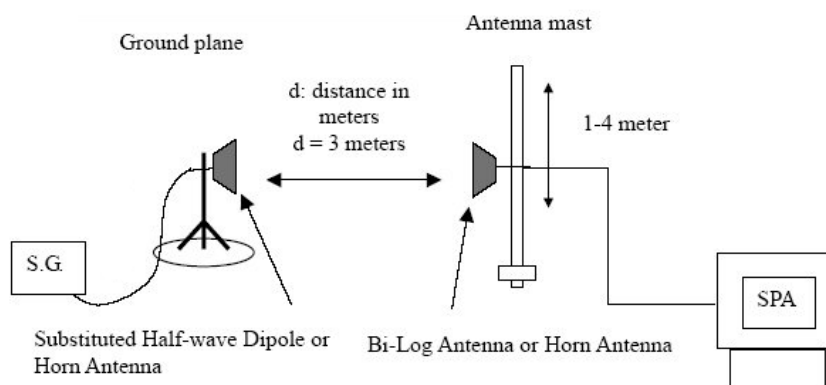

## KCTL Inc.

65, Sinwon-ro, Yeongtong-gu,  
Suwon-si, Gyeonggi-do, 16677, Korea  
TEL: 82-31-285-0894 FAX: 82-505-299-8311  
[www.kctl.co.kr](http://www.kctl.co.kr)

Report No.:  
KR21-SRF0236  
Page (100) of (104)

# KCTL

### Limit

According to §22.917(a), the power of any emission outside of the authorized operating frequency ranges must be attenuated below the transmitting power (P) by a factor of at least  $43 + 10\log(P_{\text{Watts}})$  dB.

According to §27.53(g), for operations in the 600 MHz band and the 698-746 MHz band, the power of any emission outside a licensee's frequency band(s) of operation shall be attenuated below the transmitter power (P) within the licensed band(s) of operation, measured in watts, by at least  $43 + 10\log(P_{\text{Watts}})$  dB.

According to §27.53(m)(4), the minimum permissible attenuation level of any spurious emission is  $55 + 10\log(P_{\text{Watts}})$  dB.

### Test procedure

971168 D01 v03r01 - Section 6.2  
ANSI 63.26-2015 – Section 5.5  
ANSI/TIA-603-E-2016 - Section 2.2.12

### Test settings

- 1) RBW = 100 kHz for below 1 GHz and 1 MHz for above 1 GHz.
- 2) VBW  $\geq 3 \times$  RBW.
- 3) Detector = RMS
- 4) Trace mode = Max hold
- 5) Sweep time = Auto couple
- 6) Number of sweep points  $\geq 2 \times$  span / RBW
- 7) Allow trace to fully stabilize.

### Notes:

1. On a test site, the EUT shall be placed at 80 cm or 1.5 m height on a turn table, and in the position close to normal use as declared by the applicant.
2. The test antenna shall be oriented initially for vertical polarization located 3 m from EUT to correspond to the fundamental frequency of the transmitter.
3. The turntable is rotated through 360°, and the receiving antenna scans in order to determine the level of the maximized emission.
4. The test antenna shall be raised and lowered again through the specified range of height until the maximum signal level is detected by the measuring receiver.
5. The maximum signal level detected by the measuring receiver shall be noted.
6. The EUT was replaced by half-wave dipole (1 GHz below) or horn antenna (1 GHz above) connected to a signal generator.
7. The test antenna shall be raised and lowered through the specified range of height to ensure that the maximum signal is received.
8. The input signal to the substitution antenna shall be adjusted to the level that produces a level detected by the measuring corrected for the change of input attenuator setting of the measuring receiver.
9. The input level to the substitution antenna shall be recorded as power level in dBm, corrected for any change of input attenuator setting of the measuring receiver.
10. The measurement shall be repeated with the test antenna and the substitution antenna orientated for horizontal polarization.

**KCTL Inc.**

65, Sinwon-ro, Yeongtong-gu,  
Suwon-si, Gyeonggi-do, 16677, Korea  
TEL: 82-31-285-0894 FAX: 82-505-299-8311  
[www.kctl.co.kr](http://www.kctl.co.kr)

Report No.:  
KR21-SRF0236  
Page (101) of (104)

**KCTL****Test results (Above 1 000 MHz)**Test mode : LTE Band 5Frequency(MHz) : 829.0Channel : 20450Bandwidth(MHz) : 10

Mode	Frequency	Pol.	Antenna Gain	Cable loss	Substitute Level	Level	Limit	Margin
	[MHz]	[V/H]	[dBi]	[dB]	[dBm]	[dBm]	[dBm]	[dB]
QPSK	1 648.65	V	5.35	7.51	-60.04	-62.20	-13.00	49.20
	2 473.72	V	5.95	9.17	-44.88	-48.10	-13.00	35.10
	3 295.91	H	7.59	10.82	-52.37	-55.60	-13.00	42.60
	4 119.34	V	8.97	12.25	-49.52	-52.80	-13.00	39.80

Test mode : LTE Band 5Frequency(MHz) : 836.5Channel : 20525Bandwidth(MHz) : 10

Mode	Frequency	Pol.	Antenna Gain	Cable loss	Substitute Level	Level	Limit	Margin
	[MHz]	[V/H]	[dBi]	[dB]	[dBm]	[dBm]	[dBm]	[dB]
QPSK	1 683.52	H	5.32	7.53	-59.59	-61.80	-13.00	48.80
	2 524.59	H	6.05	9.29	-53.06	-56.30	-13.00	43.30
	3 366.07	V	7.73	10.96	-52.37	-55.60	-13.00	42.60
	4 207.55	V	9.09	12.15	-49.94	-53.00	-13.00	40.00

Test mode : LTE Band 5Frequency(MHz) : 844.0Channel : 20600Bandwidth(MHz) : 10

Mode	Frequency	Pol.	Antenna Gain	Cable loss	Substitute Level	Level	Limit	Margin
	[MHz]	[V/H]	[dBi]	[dB]	[dBm]	[dBm]	[dBm]	[dB]
QPSK	1 688.45	V	5.31	7.54	-57.57	-59.80	-13.00	46.80
	2 532.39	V	6.06	9.30	-51.66	-54.90	-13.00	41.90
	3 376.33	H	7.75	10.98	-53.17	-56.40	-13.00	43.40
	4 220.27	V	9.11	12.18	-51.33	-54.40	-13.00	41.40

Note.

1. E.R.P &amp; E.I.R.P(dB m) = Substitute Level(dB) + Antenna gain(dB i&amp;dB d) - C.L(Cable loss) (dB)

**KCTL Inc.**

65, Sinwon-ro, Yeongtong-gu,  
Suwon-si, Gyeonggi-do, 16677, Korea  
TEL: 82-31-285-0894 FAX: 82-505-299-8311  
[www.kctl.co.kr](http://www.kctl.co.kr)

Report No.:  
KR21-SRF0236  
Page (102) of (104)

**KCTL**

Test mode : LTE Band 12

Frequency(MHz) : 704.0

Channel : 23060

Bandwidth(MHz) : 10

Mode	Frequency	Pol.	Antenna Gain	Cable loss	Substitute Level	Level	Limit	Margin
	[MHz]	[V/H]	[dBi]	[dB]	[dBm]	[dBm]	[dBm]	[dB]
QPSK	1 398.79	H	5.01	6.89	-54.52	-56.40	-13.00	43.40
	2 097.72	H	5.20	8.39	-52.51	-55.70	-13.00	42.70
	2 795.78	H	6.59	9.81	-54.68	-57.90	-13.00	44.90
	3 495.08	V	7.99	11.22	-51.97	-55.20	-13.00	42.20

Test mode : LTE Band 12

Frequency(MHz) : 707.5

Channel : 23095

Bandwidth(MHz) : 10

Mode	Frequency	Pol.	Antenna Gain	Cable loss	Substitute Level	Level	Limit	Margin
	[MHz]	[V/H]	[dBi]	[dB]	[dBm]	[dBm]	[dBm]	[dB]
QPSK	1 405.76	H	5.05	6.92	-55.73	-57.60	-13.00	44.60
	2 107.34	H	5.21	8.41	-53.30	-56.50	-13.00	43.50
	2 810.61	V	6.62	9.84	-51.88	-55.10	-13.00	42.10
	3 512.54	H	8.02	11.25	-51.77	-55.00	-13.00	42.00

Test mode : LTE Band 12

Frequency(MHz) : 711.0

Channel : 23130

Bandwidth(MHz) : 10

Mode	Frequency	Pol.	Antenna Gain	Cable loss	Substitute Level	Level	Limit	Margin
	[MHz]	[V/H]	[dBi]	[dB]	[dBm]	[dBm]	[dBm]	[dB]
QPSK	1 411.92	H	5.08	6.94	-59.04	-60.90	-13.00	47.90
	2 118.01	H	5.24	8.43	-52.41	-55.60	-13.00	42.60
	2 824.09	V	6.65	9.87	-53.78	-57.00	-13.00	44.00
	3 530.59	H	8.05	11.29	-50.16	-53.40	-13.00	40.40

Note.

1. E.R.P & E.I.R.P(dB m) = Substitute Level(dB) + Antenna gain(dB i&dB d) - C.L(Cable loss) (dB)



**KCTL Inc.**

65, Sinwon-ro, Yeongtong-gu,  
Suwon-si, Gyeonggi-do, 16677, Korea  
TEL: 82-31-285-0894 FAX: 82-505-299-8311  
[www.kctl.co.kr](http://www.kctl.co.kr)

Report No.:  
KR21-SRF0236  
Page (103) of (104)

**KCTL**

Test mode : LTE Band 41

Frequency(MHz) : 2 503.5

Channel : 39725

Bandwidth(MHz) : 15

Mode	Frequency	Pol.	Antenna Gain	Cable loss	Substitute Level	Level	Limit	Margin
	[MHz]	[V/H]	[dBi]	[dB]	[dBm]	[dBm]	[dBm]	[dB]
QPSK	5 022.21	V	10.32	13.14	-51.38	-54.20	-25.00	29.20
	7 533.38	H	12.33	16.83	-45.00	-49.50	-25.00	24.50
	10 044.55	V	12.80	19.42	-44.58	-51.20	-25.00	26.20
	12 555.09	V	13.06	21.75	-40.51	-49.20	-25.00	24.20

Test mode : LTE Band 41

Frequency(MHz) : 2 593.0

Channel : 40620

Bandwidth(MHz) : 15

Mode	Frequency	Pol.	Antenna Gain	Cable loss	Substitute Level	Level	Limit	Margin
	[MHz]	[V/H]	[dBi]	[dB]	[dBm]	[dBm]	[dBm]	[dB]
QPSK	5 186.26	H	10.45	14.96	-47.29	-51.80	-25.00	26.80
	7 779.14	H	12.52	18.10	-43.22	-48.80	-25.00	23.80
	10 372.65	V	12.80	20.52	-36.98	-44.70	-25.00	19.70
	12 965.53	H	13.47	22.50	-35.97	-45.00	-25.00	20.00

Test mode : LTE Band 41

Frequency(MHz) : 2 682.5

Channel : 41515

Bandwidth(MHz) : 15

Mode	Frequency	Pol.	Antenna Gain	Cable loss	Substitute Level	Level	Limit	Margin
	[MHz]	[V/H]	[dBi]	[dB]	[dBm]	[dBm]	[dBm]	[dB]
QPSK	5 365.63	V	10.59	14.16	-47.73	-51.30	-25.00	26.30
	8 047.87	V	12.74	17.29	-40.35	-44.90	-25.00	19.90
	10 730.75	V	12.94	20.20	-31.74	-39.00	-25.00	14.00
	13 412.36	H	13.83	22.39	-38.24	-46.80	-25.00	21.80

Note.

1. E.R.P & E.I.R.P(dB m) = Substitute Level(dB) + Antenna gain(dB i&dB d) - C.L(Cable loss) (dB)

**KCTL Inc.**

65, Sinwon-ro, Yeongtong-gu,  
Suwon-si, Gyeonggi-do, 16677, Korea  
TEL: 82-31-285-0894 FAX: 82-505-299-8311  
[www.kctl.co.kr](http://www.kctl.co.kr)

Report No.:  
KR21-SRF0236  
Page (104) of (104)



## 8. Measurement equipment

Equipment Name	Manufacturer	Model No.	Serial No.	Next Cal. Date
Spectrum Analyzer	R&S	FSV30	100732	22.01.20
Spectrum Analyzer	KEYSIGHT	N9040B	US55230151	22.07.28
Vector Signal Generator	R&S	SMBV100A	257566	22.07.29
Signal Generator	R&S	SMB100A	176206	22.01.20
Power Divider	AGILENT	11636B	54456	21.12.31
DC Power Supply	AGILENT	E3632A	MY40027567	22.05.10
Wideband Radio Communication Tester	R&S	CMW500	141780	22.04.01
Temp & Humid Chamber	ESPEC CORP.	SH-642	93016978	22.03.04
Biconical VHF-UHF Broadband Antenna	SCHWARZBECK	VUBA9117	275	22.04.09
Bilog Antenna	ETS.LINDGREN	3143B	00228420	21.09.30
Horn Antenna	ETS.lindgren	3115	62589	22.07.09
Horn Antenna	ETS.LINDGREN	3117	00227509	21.09.23
Horn Antenna	ETS.lindgren	3116	00086632	22.01.29
Horn Antenna	ETS.lindgren	3116	00086635	22.05.17
High pass Filter	Wainwright Instruments GmbH	WHKX12-2805-3000-18000-40SS	32	22.08.20*
High pass Filter	Wainwright Instruments GmbH	WHKX10-900-1000-15000-40SS	11	22.08.20*
Broadband Amplifier	SONOMA INSTRUMENT	310N	186280	22.08.20*
Amplifier	LTC MICROWAVE	LLA01185522Q-B	141	22.07.19
Amplifier	L-3 Narda-MITEQ	JS44-18004000-33-8P	2000996	22.01.21
Antenna Stand	innco systems GmbH	AS1500-EP-10kg	N/A	N/A
Antenna Stand	innco systems GmbH	AS1500-EP-10kg	N/A	N/A
Turn Device	innco systems GmbH	DE3700-RH	N/A	N/A

\* Tests related to this equipment were progressed after the calibration was completed.

**End of test report**