





TEST REPORT

KCTL Inc. 65, Sinwon-ro, Yeongtong-gu, Suwon-si, Gyeonggi-do, 16677, Korea TEL: 82-31-285-0894 FAX: 82-505-299-8311 www.kctl.co.kr	Report No.: KR21-SRF0237-A Page (1) of (45)	
1. Client		
<ul style="list-style-type: none"> ◦ Name : Samsung Electronics Co., Ltd. ◦ Address : 129, Samsung-ro, Yeongtong-gu, Suwon-si, Gyeonggi-do, 16677, Rep. of Korea ◦ Date of Receipt : 2021-08-09 		
2. Use of Report : Certification		
3. Name of Product / Model : Mobile phone / SC-56B		
4. Manufacturer / Country of Origin : Samsung Electronics Co., Ltd. / Vietnam		
5. FCC ID : A3LSMA223JPN		
7. Date of Test : 2021-08-17 to 2021-09-16		
8. Location of Test : <input checked="" type="checkbox"/> Permanent Testing Lab <input type="checkbox"/> On Site Testing (Address:65, Sinwon-ro, Yeongtong-gu, Suwon-si, Gyeonggi-do, 16677, Korea)		
9. Test method used : FCC Part 2 FCC Part 22 Subpart H FCC Part 24 Subpart E		
10. Test Result : Refer to the test result in the test report		
Affirmation	Tested by Name : Kwonse Kim  (Signature)	Technical Manager Name : Seungyong Kim  (Signature)
2021-10-05		
<h2>KCTL Inc.</h2>		
As a test result of the sample which was submitted from the client, this report does not guarantee the whole product quality. This test report should not be used and copied without a written agreement by KCTL Inc.		

REPORT REVISION HISTORY

Date	Revision	Page No
2021-09-29	Originally issued	-
2021-10-05	Output power and MPR level a typo	11

This report shall not be reproduced except in full, without the written approval of KCTL Inc. This document may be altered or revised by KCTL Inc. personnel only, and shall be noted in the revision section of the document. Any alteration of this document not carried out by KCTL Inc. will constitute fraud and shall nullify the document. This test report is a general report that does not use the KOLAS accreditation mark and is not related to KS Q ISO/IEC 17025 and KOLAS accreditation.

Note. The report No. KR21-SRF0237 is superseded by the report No. KR21-SRF0237-A.

General remarks for test reports

Statement concerning the uncertainty of the measurement systems used for the tests

(may be required by the product standard or client)

Internal procedure used for type testing through which traceability of the measuring uncertainty has been established:

Procedure number, issue date and title:

Calculations leading to the reported values are on file with the testing laboratory that conducted the testing.

Statement not required by the standard or client used for type testing

KCTL Inc.

65, Sinwon-ro, Yeongtong-gu,
Suwon-si, Gyeonggi-do, 16677, Korea
TEL: 82-31-285-0894 FAX: 82-505-299-8311
www.kctl.co.kr

Report No.:
KR21-SRF0237-A
Page (3) of (45)



CONTENTS

1.	General information	4
2.	Device information	4
2.1.	Frequency/channel operations.....	6
3.	Maximum ERP/EIRP power.....	6
4.	Summary of tests	7
4.1.	Worst case orientation	7
5.	Measurement uncertainty	8
6.	Measurement results explanation example	9
7.	Test results	10
7.1.	Conducted output power.....	10
7.2.	99% Occupied Bandwidth & 26dB Bandwidth	12
7.3.	Spurious Emissions at Antenna Terminal.....	21
7.4.	Band Edge Emissions at Antenna Terminal	25
7.5.	Peak to Average Power Ratio (PAPR)	29
7.6.	Frequency stability	31
7.7.	Radiated Power (ERP/EIRP)	36
7.8.	Radiated Spurious Emissions	40
8.	Measurement equipment	45

KCTL Inc.

65, Sinwon-ro, Yeongtong-gu,
Suwon-si, Gyeonggi-do, 16677, Korea
TEL: 82-31-285-0894 FAX: 82-505-299-8311
www.kctl.co.kr

Report No.:
KR21-SRF0237-A
Page (4) of (45)

KCTL

1. General information

Client : Samsung Electronics Co., Ltd.
Address : 129, Samsung-ro, Yeongtong-gu, Suwon-si, Gyeonggi-do, 16677,
Rep. of Korea
Manufacturer : Samsung Electronics Co., Ltd.
Address : 129, Samsung-ro, Yeongtong-gu, Suwon-si, Gyeonggi-do, 16677,
Rep. of Korea
Laboratory : KCTL Inc.
Address : 65, Sinwon-ro, Yeongtong-gu, Suwon-si, Gyeonggi-do, 16677, Korea
Accreditations : FCC Site Designation No: KR0040, FCC Site Registration No: 687132
VCCI Registration No. : R-20080, G-20078, C-20059, T-20056
CAB Identifier: KR0040
ISED Number: 8035A
KOLAS No.: KT231

2. Device information

Equipment under test : Mobile phone
Model : SC-56B
Modulation technique : Bluetooth(BDR/EDR)_GFSK, $\pi/4$ DQPSK, 8DPSK
Bluetooth(BLE)_GFSK
WIFI(802.11a/b/g/n/ac)_DSSS, OFDM
LTE_QPSK, 16QAM, 64QAM
WCDMA_QPSK
NFC_ASK
Number of channels : Bluetooth(BDR/EDR)_79 ch / Bluetooth(BLE)_40 ch
802.11b/g/n_HT20 : 13 ch
UNII-1: 4 ch (20 MHz), 2 ch (40 MHz), 1 ch (80 MHz)
UNII-2A: 4 ch (20 MHz), 2 ch (40 MHz), 1 ch (80 MHz)
UNII-2C: 12 ch (20 MHz), 6 ch (40 MHz), 3 ch (80 MHz)
UNII-3: 5 ch (20 MHz), 2 ch (40 MHz), 1 ch (80 MHz)
NFC: 1 ch
Power source : DC 3.88 V
Antenna specification : LTE/WCDMA_Metal Antenna
WIFI/Bluetooth(BDR/EDR/BLE)_LDS Antenna
NFC_LDS Antenna
Antenna gain : WIFI/Bluetooth(BDR/EDR/BLE)_-2.95 dBi
UNII-1 : -3.06 dBi
UNII-2A : -3.06 dBi
UNII-2C : -4.03 dBi
UNII-3 : -4.80 dBi

KCTL Inc.

65, Sinwon-ro, Yeongtong-gu,
Suwon-si, Gyeonggi-do, 16677, Korea
TEL: 82-31-285-0894 FAX: 82-505-299-8311
www.kctl.co.kr

Report No.:
KR21-SRF0237-A
Page (5) of (45)



Frequency range : Bluetooth(BDR/EDR/BLE)_2 402 MHz ~ 2 480 MHz
2 412 MHz ~ 2 472 MHz (802.11b/g/n_HT20)
UNII-1: 5 180 MHz ~ 5 240 MHz (802.11a/n/ac_HT20/VHT20)
UNII-1: 5 190 MHz ~ 5 230 MHz (802.11n/ac_HT40/VHT40)
UNII-1: 5 210 MHz (802.11ac_VHT80)
UNII-2A: 5 260 MHz ~ 5 320 MHz (802.11a/n/ac_HT20/VHT20)
UNII-2A: 5 270 MHz ~ 5 310 MHz (802.11n/ac_HT40/VHT40)
UNII-2A: 5 290 MHz (802.11ac_VHT80)
UNII-2C: 5 500 MHz ~ 5 720 MHz (802.11a/n/ac_HT20/VHT20)
UNII-2C: 5 510 MHz ~ 5 710 MHz (802.11n/ac_HT40/VHT40)
UNII-2C: 5 530 MHz ~ 5 690 MHz (802.11ac_VHT80)
UNII-3: 5 745 MHz ~ 5 825 MHz (802.11a/n/ac_HT20/VHT20)
UNII-3: 5 755 MHz ~ 5 795 MHz (802.11n/ac_HT40/VHT40)
UNII-3: 5 775 MHz (802.11ac_VHT80)
LTE Band 5_824.7 MHz ~ 848.3 MHz
LTE Band 12_699.7 MHz ~ 715.3 MHz
LTE Band 41_2 498.5 MHz ~ 2 687.5 MHz
GSM 850_824.2 MHz ~ 848.8 MHz
GSM 1900_1 850.2 MHz ~ 1 909.8 MHz
WCDMA 850_826.4 MHz ~ 846.6 MHz
NFC_13.56 MHz

Software version : A223D.001

Hardware version : REV1.0

Test device serial No. : Conducted(R3CR70CAFJT, FD100000211C7ECE, R3CR70CAFGE,
R3CR70CALHR)
Radiated(R3CR70CAPCH, R3CR70CAPAA, R3CR70C6NHV)

Operation temperature : -30 °C ~ 50 °C

2.1. Frequency/channel operations

This device contains the following capabilities:

WiFi (802.11a/b/g/n/ac), Bluetooth (BDR/EDR/BLE), NFC, LTE Band 5, LTE Band 12, LTE Band 41
 GSM 850, GSM 1900, WCDMA 850

GSM 850	
Ch.	Frequency (MHz)
4132	826.4
4183	836.6
4233	846.6

Table 2.1.1.
Voice/GPRS/EGPRS

GSM 1900	
Ch.	Frequency (MHz)
1312	1 712.4
1412	1 732.4
1513	1 752.6

Table 2.1.2.
Voice/GPRS/EGPRS

WCDMA 850	
Ch.	Frequency (MHz)
4132	826.4
4183	836.6
4233	846.6

Table 2.1.3.
RMC/HSDPA/HSUPA/
DC-HSDPA

3. Maximum ERP/EIRP power

GSM 850 / WCDMA 850

Mode	Tx frequency (MHz)	Emission designator	ERP	
			Max. power (dBm)	Max. power (W)
GSM 850 (GPRS)	824.2 ~ 848.8	248KGXW	27.42	0.552
GSM 850 (EDGE)	824.2 ~ 848.8	248KG7W	27.37	0.546
WCDMA 850 (RMC)	826.4 ~ 846.6	4M17F9W	19.53	0.090

GSM 1900

Mode	Tx frequency (MHz)	Emission designator	EIRP	
			Max. power (dBm)	Max. power (W)
GSM 1900 (Voice)	1 850.2 ~ 1 909.8	248KGXW	26.88	0.488
GSM 1900 (EDGE)	1 850.2 ~ 1 909.8	248KG7W	26.82	0.481

4. Summary of tests

FCC Part Section(s)	Parameter	Test Limit	Test Condition	Test results
2.1046	Conducted Output Power	N/A	Conducted	Pass
2.1049	Occupied Bandwidth & 26 dB Bandwidth	N/A		Pass
2.1051 22.917(a) 24.238(a)	Band Edge Emissions at Antenna Terminal	<43 + 10Log ₁₀ (P) dB		Pass
	Spurious Emissions at Antenna Terminal			Pass
24.232(d)	Peak to Average Power Ratio	< 13 dB		Pass
2.1055 22.355	Frequency stability	< 2.5 ppm		Pass
24.235		Emission must remain in band		
22.913(a)(5)	Effective Radiated Power	< 7 Watts max. ERP	Radiated	Pass
24.232(c)	Equivalent Isotropic Radiated Power	< 2 Watts max. EIRP		Pass
2.1053 22.917(a) 24.238(a)	Radiated Spurious Emissions	<43 + 10Log ₁₀ (P) dB		Pass

Notes:

- The test procedure(s) in this report were performed in accordance as following.
 - ◆ ANSI C63.26-2015
 - ◆ ANSI/TIA-603-E-2016
 - ◆ KDB 971168 D01 v03r01

4.1. Worst case orientation

- All modes of operation were investigated and the worst case emissions are reported with the EUT positioning, modulations and paging service configurations in the test data.
- For **GSM 850 and WCDMA 850**, the fundamental of the EUT was investigated in three orthogonal orientations X, Y and Z. It was determined that **Y** orientation was worst-case orientation. Therefore, all final radiated testing was performed with the EUT in **Y** orientation.
- For **GSM 1900**, the fundamental of the EUT was investigated in three orthogonal orientations X, Y and Z. It was determined that **Z** orientation was worst-case orientation. Therefore, all final radiated testing was performed with the EUT in **Z** orientation.

Test condition	Modulation	Mode
Radiated	GMSK	GSM 850 (GPRS), GSM 1900 (Voice)
Conducted	GMSK, 8-PSK	GSM 850 (GPRS & EDGE(1 Tx Slot)), GSM 1900 (Voice & EDGE(1 Tx Slot))
Radiated & Conducted	QPSK	RMC (12.2 kbps)

5. Measurement uncertainty

The measurement uncertainties shown below were calculated in accordance with the requirements of ANSI C63.4-2014.

All measurement uncertainty values are shown with a coverage factor of $k=2$ to indicate a 95 % level of confidence. The measurement data shown herein meets or exceeds the U_{CISPR} measurement uncertainty values specified in CISPR 16-4-2 and thus, can be compared directly to specified limits to determine compliance.

Parameter	Expanded uncertainty (\pm)	
Conducted RF power	0.9 dB	
Conducted spurious emissions	1.6 dB	
Radiated spurious emissions	Below 1 000 MHz	4.3 dB
	1 000 MHz ~ 18 000 MHz	3.8 dB
	Above 1 8000 MHz	3.8 dB

KCTL Inc.

65, Sinwon-ro, Yeongtong-gu,
Suwon-si, Gyeonggi-do, 16677, Korea
TEL: 82-31-285-0894 FAX: 82-505-299-8311
www.kctl.co.kr

Report No.:
KR21-SRF0237-A
Page (9) of (45)



6. Measurement results explanation example

Frequency (MHz)	Factor(dB)	Frequency (MHz)	Factor(dB)
30	6.28	11 000	9.23
50	6.33	12 000	9.19
100	6.42	13 000	9.76
200	6.55	14 000	9.81
300	6.65	15 000	9.95
400	6.73	16 000	10.23
500	6.79	17 000	10.67
600	6.83	18 000	10.89
700	6.89	19 000	11.05
800	6.94	20 000	10.60
900	6.98	21 000	10.70
1 000	7.01	22 000	11.22
2 000	7.30	23 000	11.27
3 000	7.63	24 000	11.46
4 000	7.97	25 000	11.32
5 000	8.22	26 000	11.56
6 000	8.31	26 500	12.05
7 000	8.41	27 000	12.05
8 000	8.76	28 000	11.80
9 000	8.98	29 000	12.03
10 000	8.99	30 000	12.18

Note.

Offset(dB) = RF cable loss(dB) + Divider (dB)

KCTL Inc.

65, Sinwon-ro, Yeongtong-gu,
Suwon-si, Gyeonggi-do, 16677, Korea
TEL: 82-31-285-0894 FAX: 82-505-299-8311
www.kctl.co.kr

Report No.:
KR21-SRF0237-A
Page (10) of (45)

KCTL

7. Test results

7.1. Conducted output power

Test setup

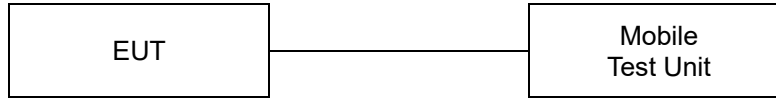

Test procedure

971168 D01 v03r01 – Section 5.2
ANSI C63.26-2015 – Section 5.2.4.2
CFR 47, - Section §2.1046

Test settings

When an average power meter is used to perform RF output power measurements, the fundamental condition that measurement be performed only over durations of active transmissions at maximum output power level applies. Thus, an average power meter can always be used to perform the measurement when the EUT can be configured to transmit continuously.

If the EUT cannot be configured to transmit continuously (i.e., burst duty cycle < 98%), then the following options can be implemented to facilitate measurement of the average power with an average power meter:

- a) A gated average power meter can be used to perform the measurement if the gating parameters can be adjusted such that the power is measured only during active transmission bursts at maximum output power levels.
- b) A conventional average power meter with no signal gating capability can also be used if the measured burst duty cycle is constant (i.e., duty cycle variations are less than or equal to $\pm 2\%$) by performing the measurement over the on/off burst cycles and then correcting (increasing) the measured level by a factor equal to $[10\log(1/\text{duty cycle})]$. See 5.2.4.3.4 for guidance with respect to measuring the transmitter duty cycle.

See item r) of 4.1 for more information regarding power meter functional requirements and limitations, and consult the instrumentation-specific application literature for proper set-up and use.

Notes:

1. Offset(dB) = RF cable loss(dB)

KCTL Inc.

65, Sinwon-ro, Yeongtong-gu,
Suwon-si, Gyeonggi-do, 16677, Korea
TEL: 82-31-285-0894 FAX: 82-505-299-8311
www.kctl.co.kr

Report No.:
KR21-SRF0237-A
Page (11) of (45)

KCTL**Test results**

Maximum Burst-Average Output Power (dBm)										
Test Band	Channel	GSM	GPRS				EDGE			
		Voice	1Tx	2Tx	3Tx	4Tx	1Tx	2Tx	3Tx	4Tx
GSM850	128	31.98	31.99	30.30	28.01	26.79	26.15	23.56	21.41	20.16
	190	32.18	32.18	30.44	28.14	26.92	26.17	23.59	21.42	20.20
	251	31.96	31.96	30.23	27.92	26.69	26.04	23.45	21.32	20.19
GSM1900	512	27.76	27.75	25.10	22.82	21.58	24.44	21.79	19.99	18.63
	661	28.00	27.99	25.31	23.08	21.88	24.51	21.91	20.18	18.74
	810	28.10	28.10	25.45	23.23	22.01	24.48	21.93	20.21	18.82

Test Band	Test mode	Average Conducted Power (dBm)			MPR (dB)
		Frequency (MHz)			
		Low	Middle	High	
WCDMA 850	RMC	22.94	23.03	22.78	-
	HSDPA-Subtest 1	21.94	22.04	21.79	0
	HSDPA-Subtest 2	21.19	21.32	21.04	0
	HSDPA-Subtest 3	20.58	20.59	20.53	0.5
	HSDPA-Subtest 4	20.56	20.54	20.58	0.5
	HSUPA-Subtest 1	21.05	21.15	21.05	0
	HSUPA-Subtest 2	19.84	19.95	19.76	2
	HSUPA-Subtest 3	20.55	20.63	20.46	1
	HSUPA-Subtest 4	19.83	19.93	19.97	2
	HSUPA-Subtest 5	21.47	21.53	21.29	0
	DC-HSDPA-Subtest 1	21.89	22.01	21.79	0
	DC-HSDPA-Subtest 2	21.95	22.05	21.80	0
	DC-HSDPA-Subtest 3	21.43	21.52	21.25	0.5
	DC-HSDPA-Subtest 4	21.44	21.50	21.27	0.5

7.2. 99% Occupied Bandwidth & 26dB Bandwidth

Test setup

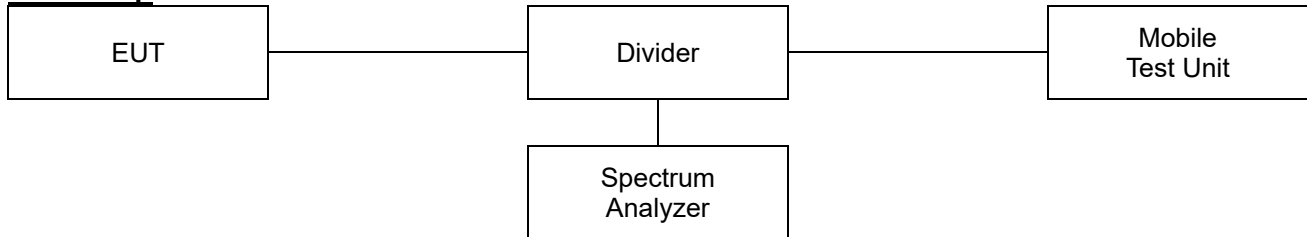

Limit

According to §2.1049 and RSS-GEN 6.7, RSS-132(2.3), the occupied bandwidth, that is the frequency bandwidth such that, below its lower and above its upper frequency limits, the mean powers radiated are each equal to 0.5 percent of the total mean power radiated by a given emission shall be measured.

Test procedure

971168 D01 v03r01 – Section 4.2 and 4.3
ANSI C63.26-2015 – Section 5.4.3 and 5.4.4

Test settings

◆ 26dB Bandwidth

- a) The spectrum analyzer center frequency is set to the nominal EUT channel center frequency. The span range for the spectrum analyzer shall be wide enough to see sufficient roll off of the signal to make the measurement.
- b) The nominal RBW shall be in the range of 1% to 5% of the anticipated OBW, and the VBW shall be set $\geq 3 \times$ RBW.
- c) Set the reference level of the instrument as required to prevent the signal amplitude from exceeding the maximum spectrum analyzer input mixer level for linear operation. See guidance provided in 4.2.3.
- d) The dynamic range of the spectrum analyzer at the selected RBW shall be more than 10 dB below the target “-X dB” requirement, i.e., if the requirement calls for measuring the -26 dB OBW, the spectrum analyzer noise floor at the selected RBW shall be at least 36 dB below the reference level.
- e) Set spectrum analyzer detection mode to peak, and the trace mode to max hold.
- f) Determine the reference value by either of the following:
 - 1) Set the EUT to transmit a modulated signal. Allow the trace to stabilize. Set the spectrum analyzer marker to the highest level of the displayed trace (this is the reference value).
 - 2) Set the EUT to transmit an unmodulated carrier. Set the spectrum analyzer marker to the level of the carrier.
- g) Determine the “-X dB amplitude” as equal to (Reference Value - X). Alternatively, this calculation can be performed on the spectrum analyzer using the delta-marker measurement function.
- h) If the reference value was determined using an unmodulated carrier, turn the EUT modulation on, then either clear the existing trace or start a new trace on the spectrum analyzer and allow the new trace to stabilize. Otherwise the trace from step f) shall be used for step i).

- i) Place two markers, one at the lowest and the other at the highest frequency of the envelope of the spectral display such that each marker is at or slightly below the “-X dB amplitude” determined in step f). If a marker is below this “-X dB amplitude” value it should be as close as possible to this value. The OBW is the positive frequency difference between the two markers.
- j) The spectral envelope can cross the “-X dB amplitude” at multiple points. The lowest or highest frequency shall be selected as the frequencies that are the farthest away from the center frequency at which the spectral envelope crosses the “-X dB amplitude.”
- k) The OBW shall be reported by providing plot(s) of the measuring instrument display, to include markers depicting the relevant frequency and amplitude information (e.g., marker table). The frequency and amplitude axis and scale shall be clearly labeled. Tabular data may be reported in addition to the plot(s).

◆ 99% Occupied Bandwidth

- a) The spectrum analyzer center frequency is set to the nominal EUT channel center frequency. The frequency span for the spectrum analyzer shall be set wide enough to capture all modulation products including the emission skirts (typically a span of $1.5 \times \text{OBW}$ is sufficient).
- b) The nominal IF filter 3 dB bandwidth (RBW) shall be in the range of 1% to 5% of the anticipated OBW, and the VBW shall be set $\geq 3 \times \text{RBW}$.
- c) Set the reference level of the instrument as required to prevent the signal amplitude from exceeding the maximum spectrum analyzer input mixer level for linear operation. See guidance provided in 4.2.3.
- d) Set the detection mode to peak, and the trace mode to max-hold.
- e) If the instrument does not have a 99% OBW function, recover the trace data points and sum directly in linear power terms. Place the recovered amplitude data points, beginning at the lowest frequency, in a running sum until 0.5% of the total is reached. Record that frequency as the lower OBW frequency. Repeat the process until 99.5% of the total is reached and record that frequency as the upper OBW frequency. The 99% power OBW can be determined by computing the difference these two frequencies.
- f) The OBW shall be reported and plot(s) of the measuring instrument display shall be provided with the test report. The frequency and amplitude axis and scale shall be clearly labeled. Tabular data can be reported in addition to the plot(s).

KCTL Inc.

65, Sinwon-ro, Yeongtong-gu,
Suwon-si, Gyeonggi-do, 16677, Korea
TEL: 82-31-285-0894 FAX: 82-505-299-8311
www.kctl.co.kr

Report No.:
KR21-SRF0237-A
Page (14) of (45)

**Test results**

Test mode		Frequency (MHz)	26 dB bandwidth (MHz)	99 % bandwidth (MHz)
GSM 850	GPRS	824.2	0.316	0.246
		836.6	0.320	0.248
		848.8	0.320	0.246
	EDGE	824.2	0.314	0.248
		836.6	0.304	0.246
		848.8	0.318	0.244
GSM 1900	Voice	1 850.2	0.318	0.244
		1 880.0	0.314	0.248
		1 909.8	0.316	0.244
	EDGE	1 850.2	0.314	0.248
		1 880.0	0.312	0.248
		1 909.8	0.314	0.248
WCDMA 850	RMC	826.4	4.71	4.12
		836.6	4.71	4.17
		846.6	4.72	4.15

KCTL Inc.

65, Sinwon-ro, Yeongtong-gu,
Suwon-si, Gyeonggi-do, 16677, Korea
TEL: 82-31-285-0894 FAX: 82-505-299-8311
www.kctl.co.kr

Report No.:
KR21-SRF0237-A
Page (15) of (45)



26dB Bandwidth

Test mode: GSM 850

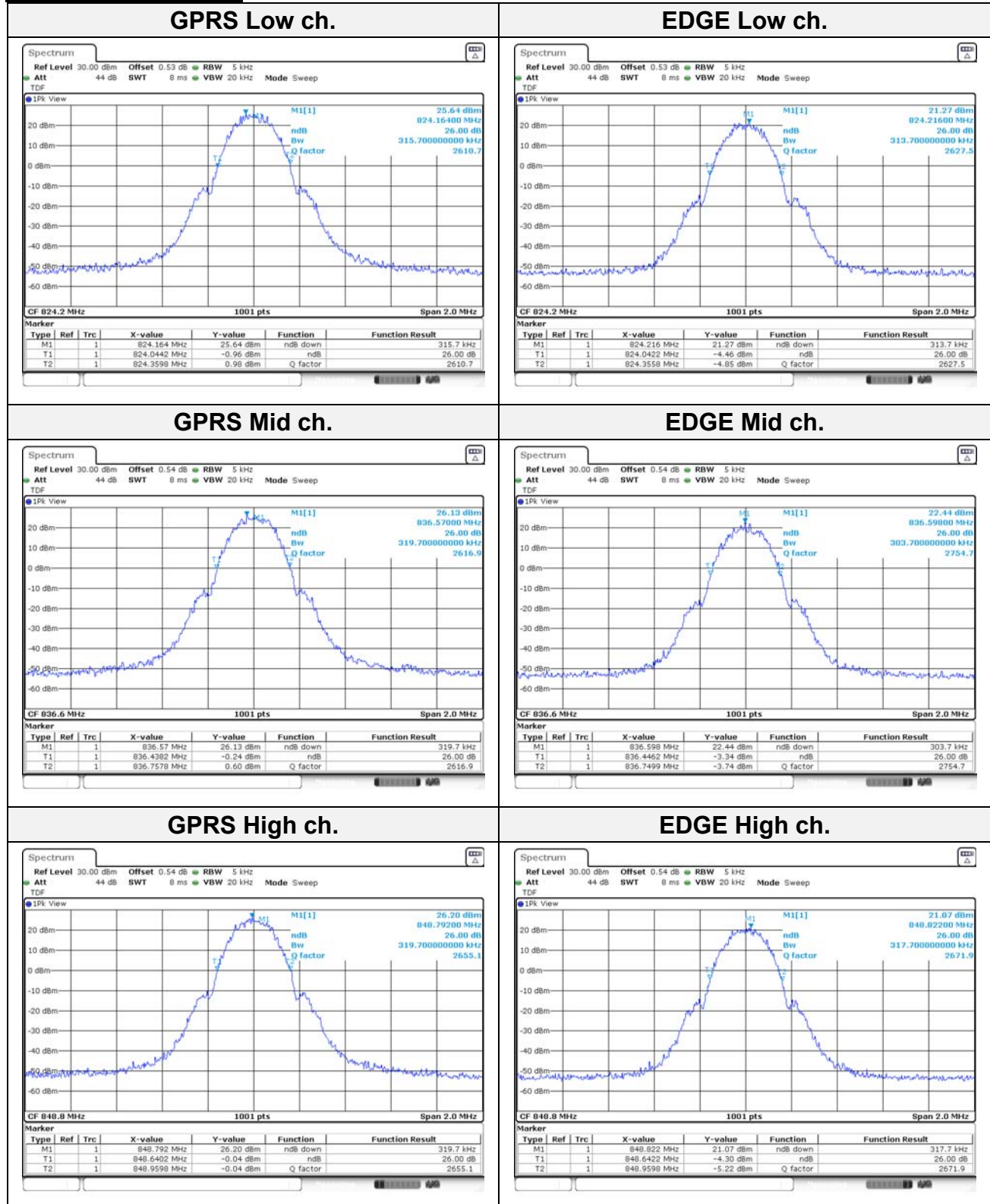

KCTL Inc.

65, Sinwon-ro, Yeongtong-gu,
Suwon-si, Gyeonggi-do, 16677, Korea
TEL: 82-31-285-0894 FAX: 82-505-299-8311
www.kctl.co.kr

Report No.:
KR21-SRF0237-A
Page (16) of (45)



Test mode: GSM 1900

Voice Low ch.

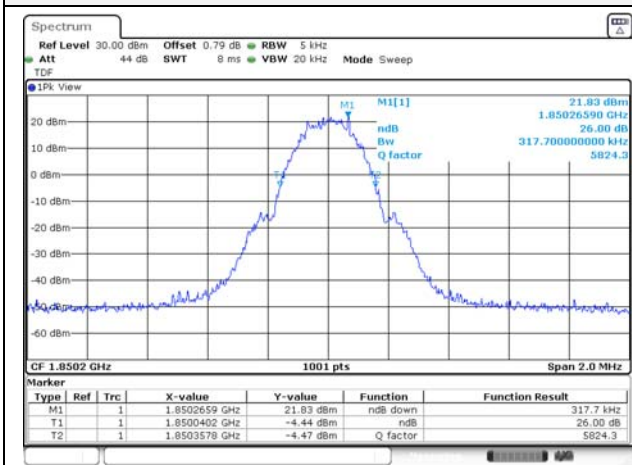

EDGE Low ch.

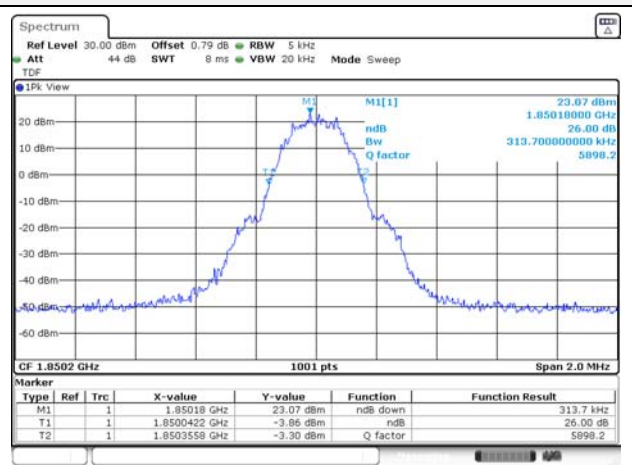

Voice Mid ch.

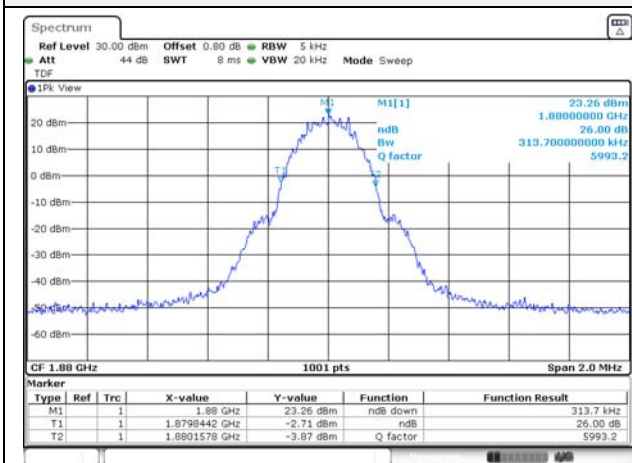

EDGE Mid ch.

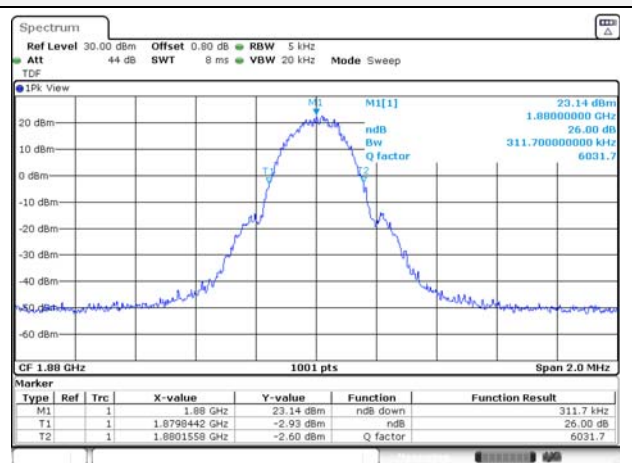

Voice High ch.

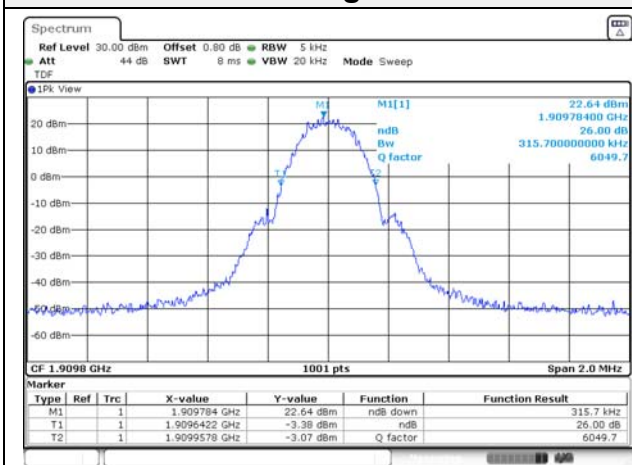

EDGE High ch.

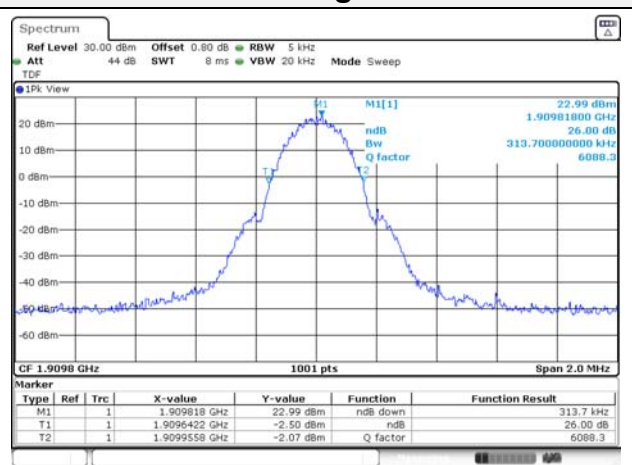

KCTL Inc.

65, Sinwon-ro, Yeongtong-gu,
Suwon-si, Gyeonggi-do, 16677, Korea
TEL: 82-31-285-0894 FAX: 82-505-299-8311
www.kctl.co.kr

Report No.:
KR21-SRF0237-A
Page (17) of (45)



Test mode: WCDMA 850

RMC Low ch.

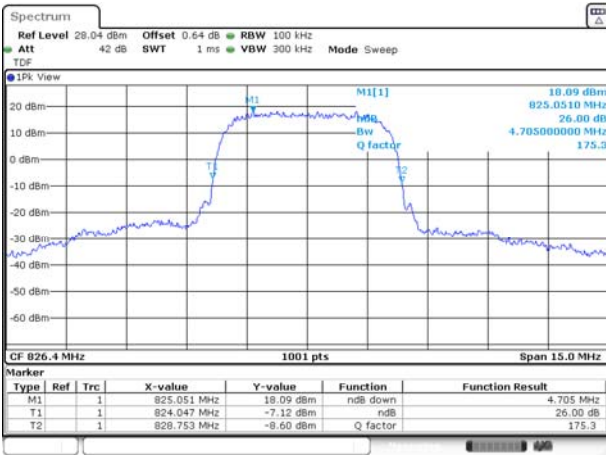

RMC Mid ch.

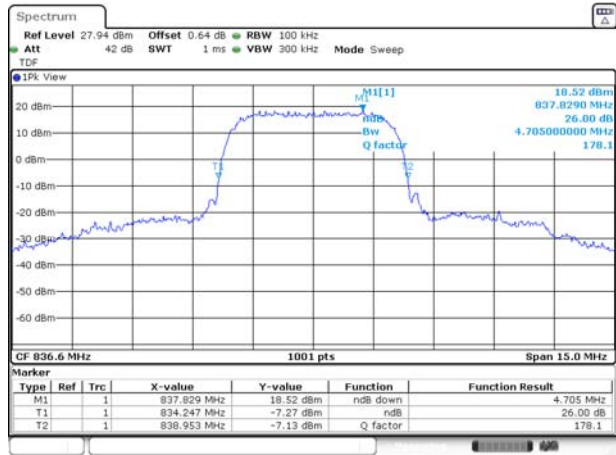

RMC High ch.

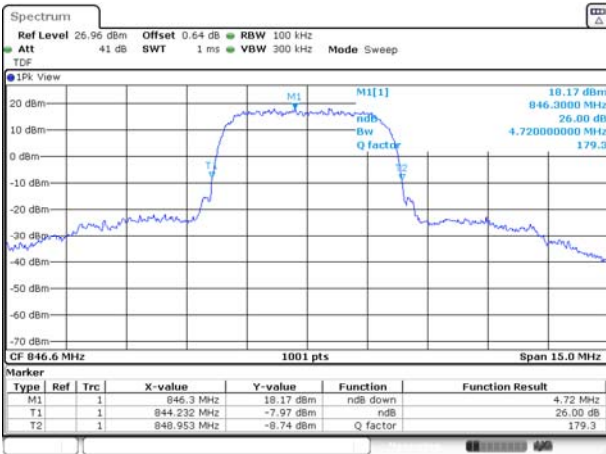

Blank

KCTL Inc.

65, Sinwon-ro, Yeongtong-gu,
Suwon-si, Gyeonggi-do, 16677, Korea
TEL: 82-31-285-0894 FAX: 82-505-299-8311
www.kctl.co.kr

Report No.:
KR21-SRF0237-A
Page (18) of (45)



99% Occupied Bandwidth

Test mode: GSM 850

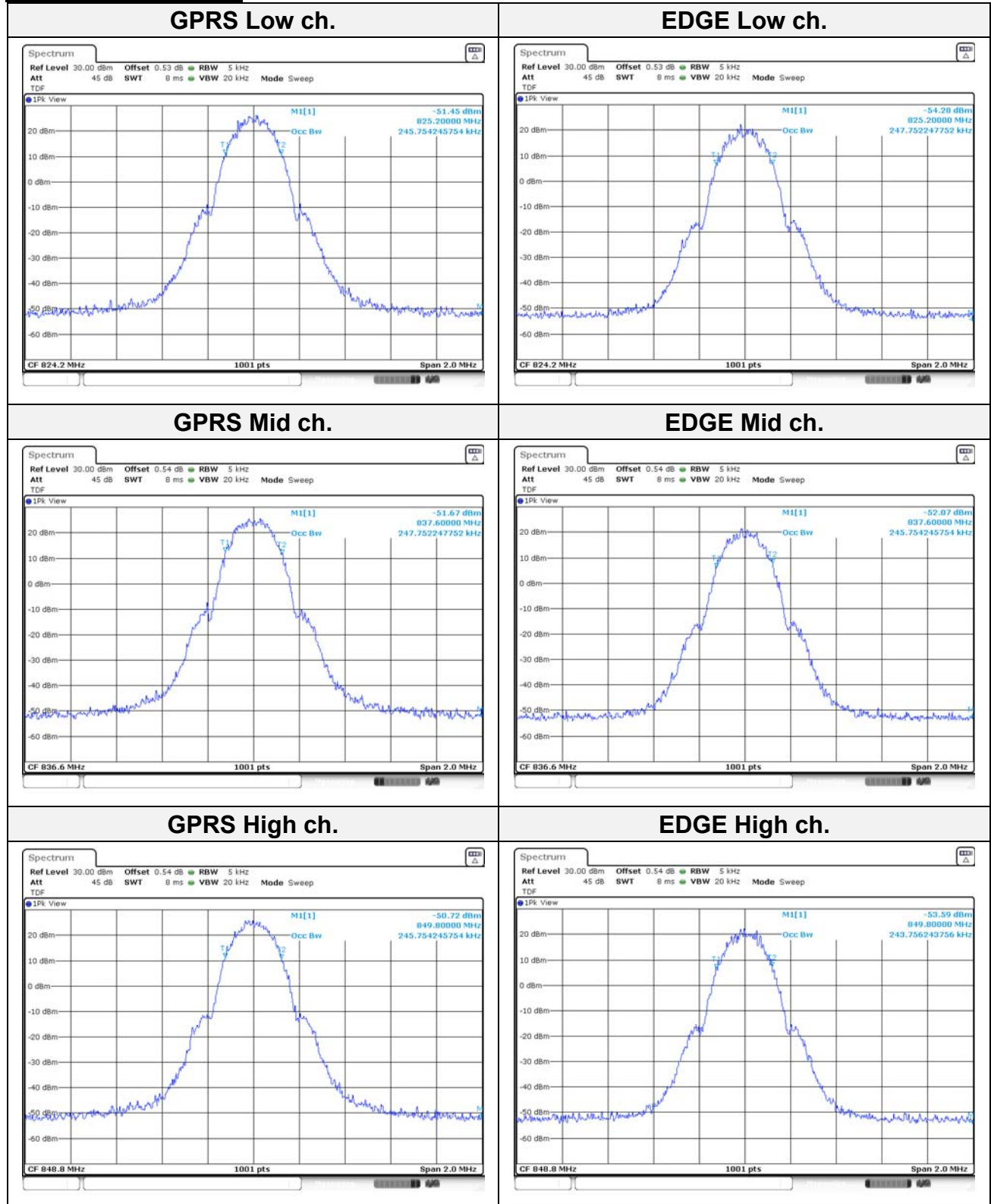

KCTL Inc.

65, Sinwon-ro, Yeongtong-gu,
Suwon-si, Gyeonggi-do, 16677, Korea
TEL: 82-31-285-0894 FAX: 82-505-299-8311
www.kctl.co.kr

Report No.:
KR21-SRF0237-A
Page (19) of (45)



Test mode: GSM 1900

GPRS Low ch.

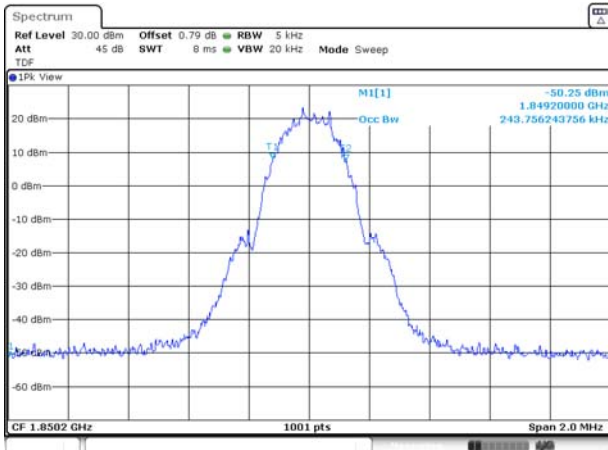

EDGE Low ch.

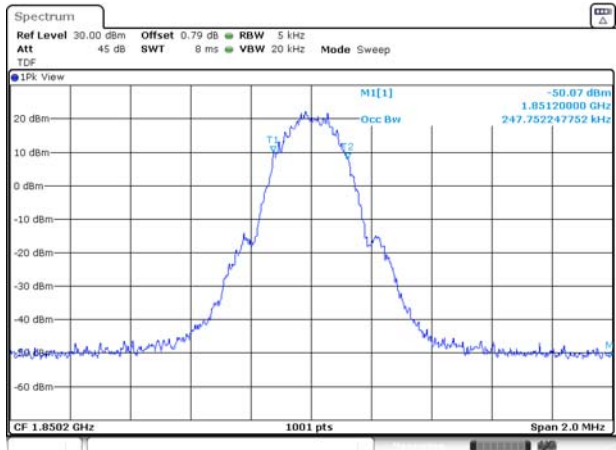

GPRS Mid ch.

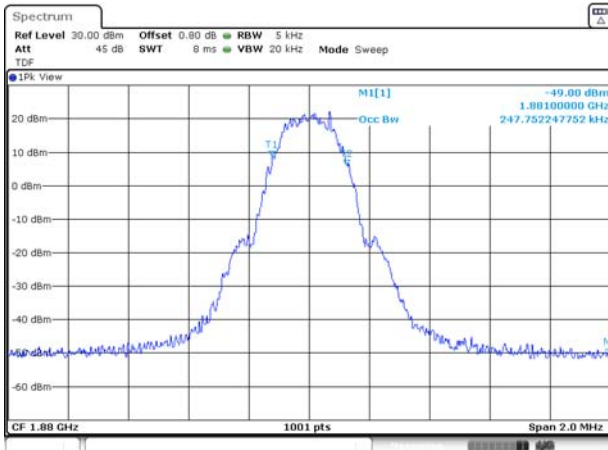

EDGE Mid ch.

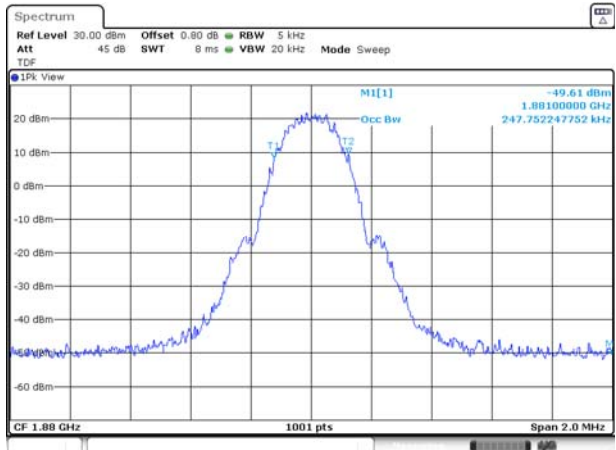

GPRS High ch.

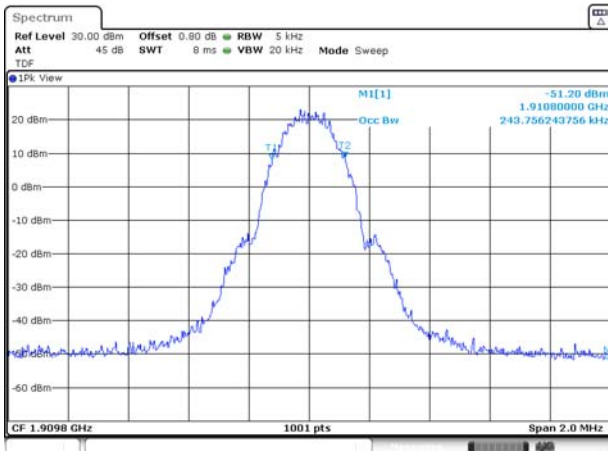

EDGE High ch.

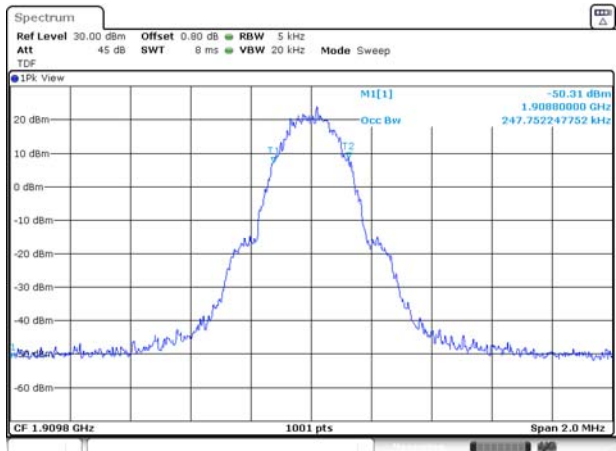

KCTL Inc.

65, Sinwon-ro, Yeongtong-gu,
Suwon-si, Gyeonggi-do, 16677, Korea
TEL: 82-31-285-0894 FAX: 82-505-299-8311
www.kctl.co.kr

Report No.:
KR21-SRF0237-A
Page (20) of (45)



Test mode: WCDMA 850

RMC Low ch.

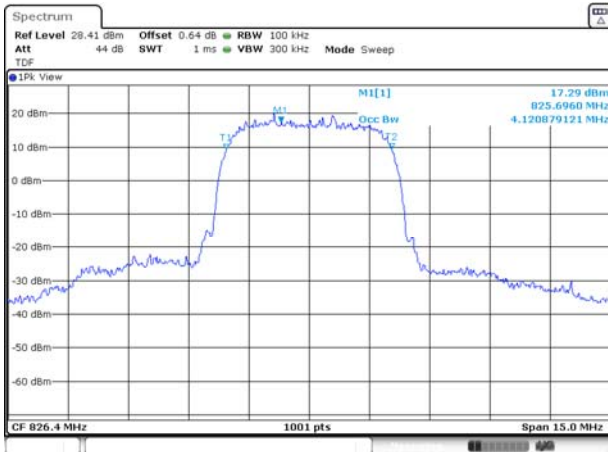

RMC Mid ch.

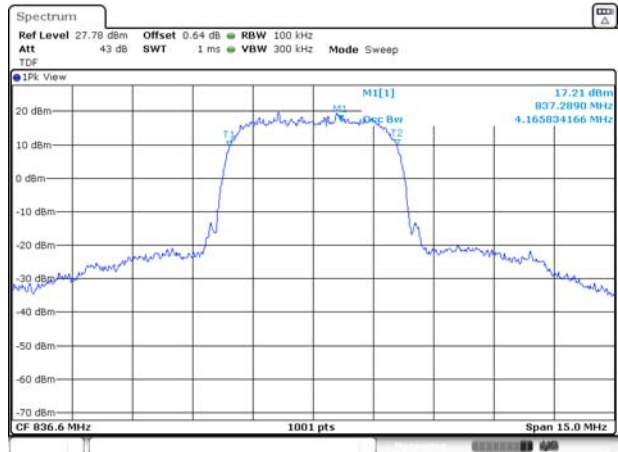

RMC High ch.

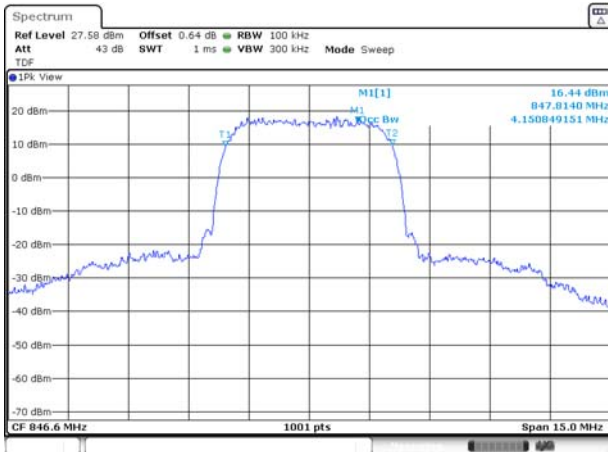

Blank

7.3. Spurious Emissions at Antenna Terminal

Test setup

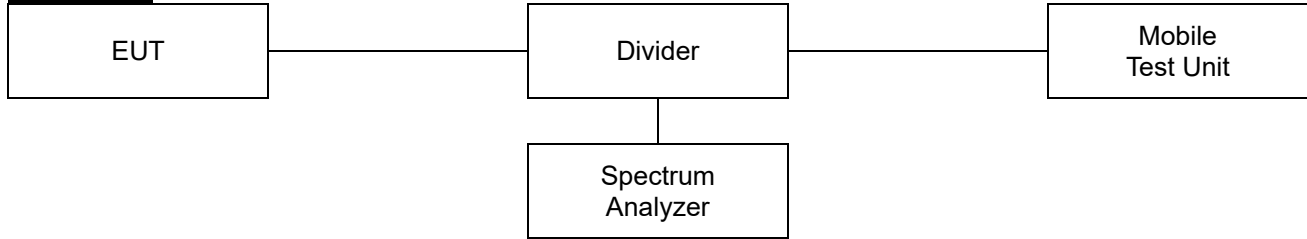

Limit

According to §22.917(a), §24.238(a) and RSS-132(5.5), RSS-133(6.5), the power of any emission outside of the authorized operating frequency ranges must be attenuated below the transmitting power (P) by a factor of at least $43 + 10\log(P)$ dB.

Test procedure

971168 D01 v03r01 - Section 6
ANSI 63.26-2015 – Section 5.7

Test settings

- 1) Start frequency was set to 30 MHz and stop frequency was set to at least 10th the fundamental frequency.
- 2) Detector = RMS
- 3) Sweep time = auto couple.
- 4) Trace mode = trace average
- 5) Allow trace to fully stabilize.
- 6) Please see test notes below RBW and VBW settings.

Notes:

1. Per 22.917(b), 24.238(b), 27.53(h) and RSS-132(5.5), RSS-133(6.5), RSS-139(6.6) compliance with these provisions is based on the use of measurement instrumentation employing a resolution bandwidth of 100 kHz or greater for frequencies less than 1 GHz and 1 MHz or greater for frequencies greater than 1 GHz.

The emission bandwidth is defined as the width of the signal between two points, one below the carrier center frequency and one above the carrier center frequency, outside of which all emissions are attenuated at least 26 dB below the transmitter power.

KCTL Inc.

65, Sinwon-ro, Yeongtong-gu,
Suwon-si, Gyeonggi-do, 16677, Korea
TEL: 82-31-285-0894 FAX: 82-505-299-8311
www.kctl.co.kr

Report No.:
KR21-SRF0237-A
Page (22) of (45)



Test results

Test mode: GSM 850

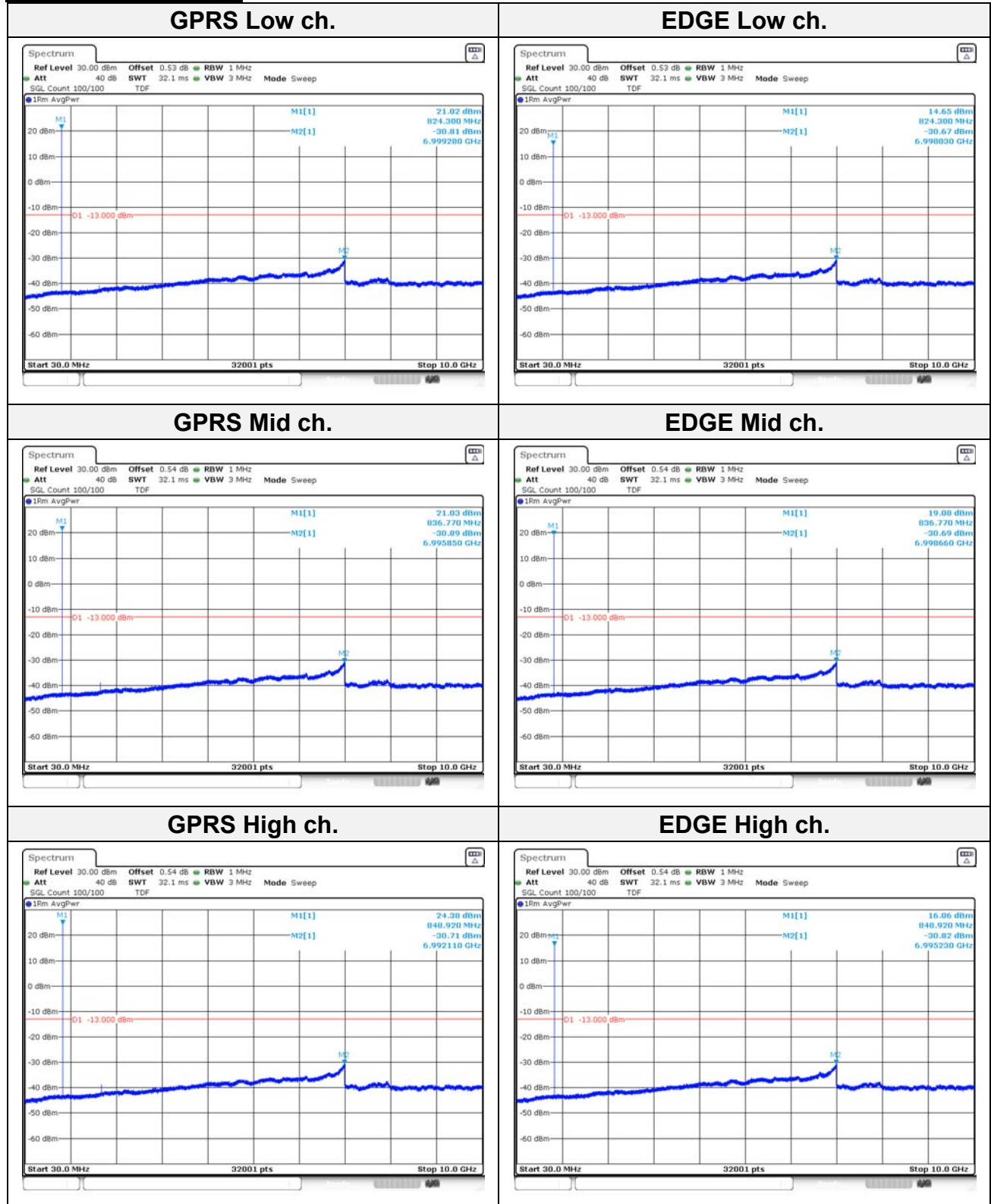

KCTL Inc.

65, Sinwon-ro, Yeongtong-gu,
Suwon-si, Gyeonggi-do, 16677, Korea
TEL: 82-31-285-0894 FAX: 82-505-299-8311
www.kctl.co.kr

Report No.:
KR21-SRF0237-A
Page (23) of (45)



Test mode: GSM 1900

GPRS Low ch.

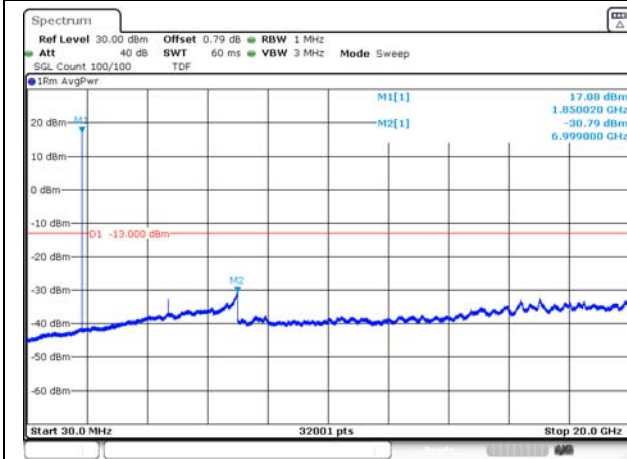

EDGE Low ch.

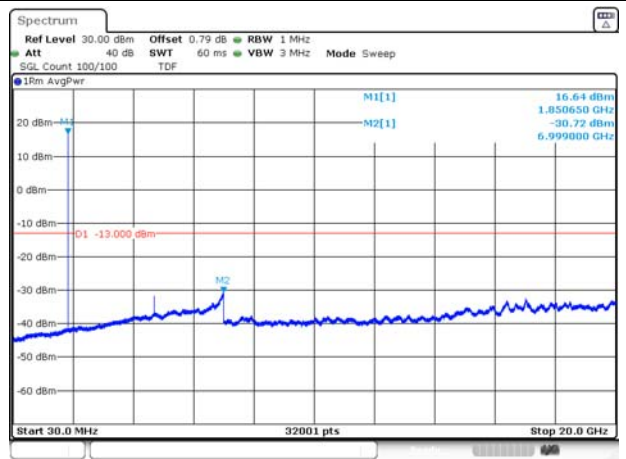

GPRS Mid ch.

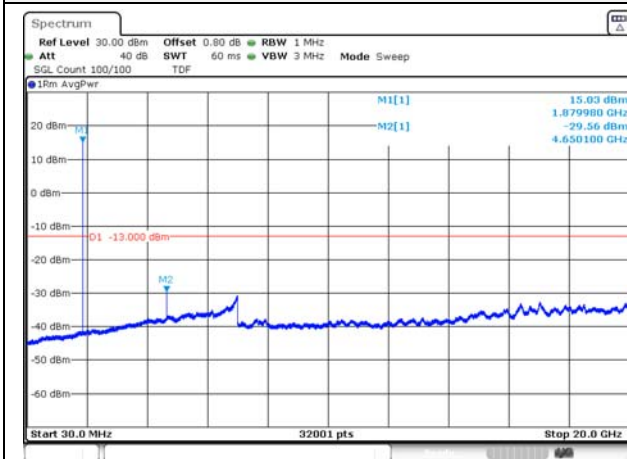

EDGE Mid ch.

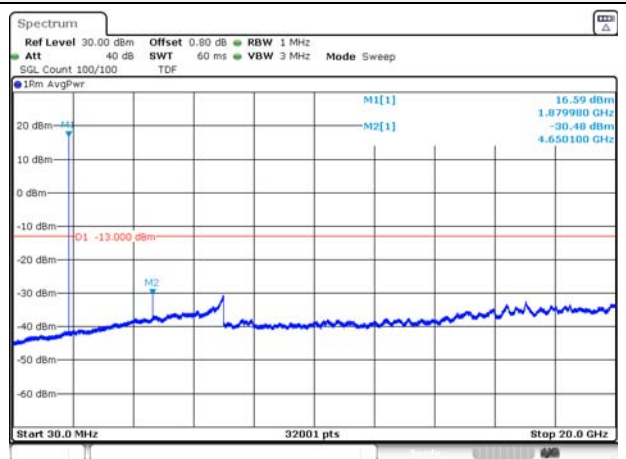

GPRS High ch.

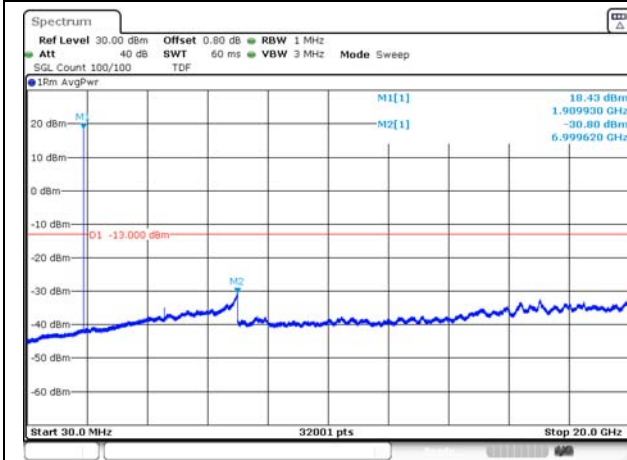

EDGE High ch.

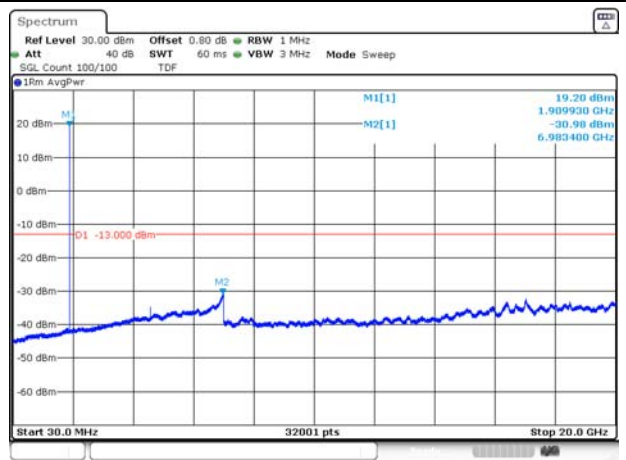

KCTL Inc.

65, Sinwon-ro, Yeongtong-gu,
Suwon-si, Gyeonggi-do, 16677, Korea
TEL: 82-31-285-0894 FAX: 82-505-299-8311
www.kctl.co.kr

Report No.:
KR21-SRF0237-A
Page (24) of (45)



Test mode: WCDMA 850

RMC Low ch.

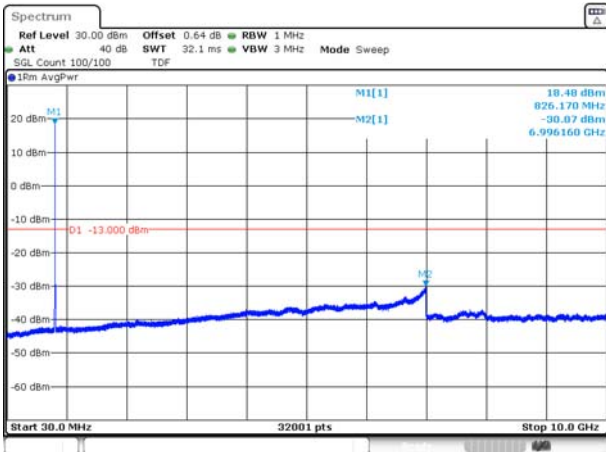

RMC Mid ch.

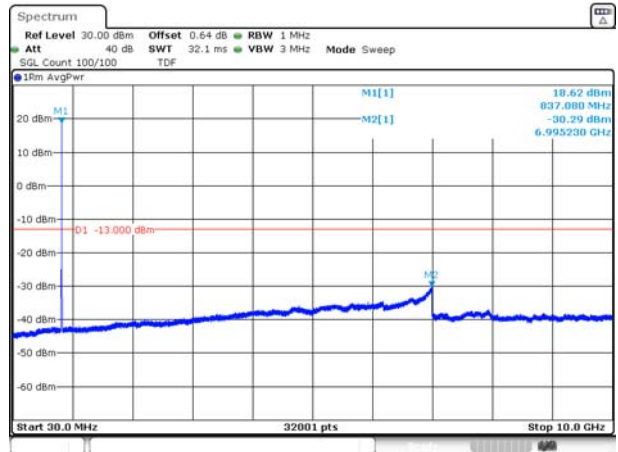

RMC High ch.

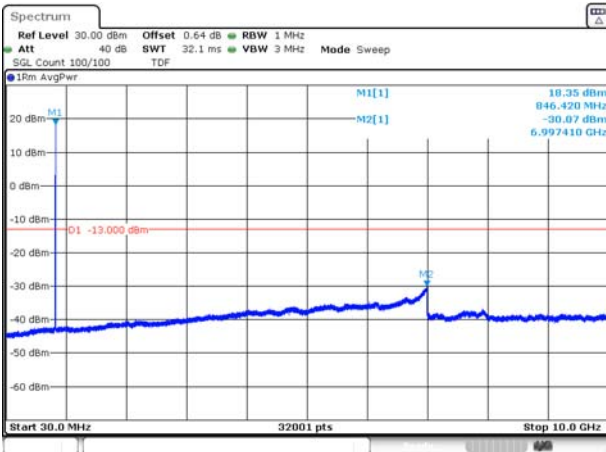

Blank

7.4. Band Edge Emissions at Antenna Terminal

Test setup

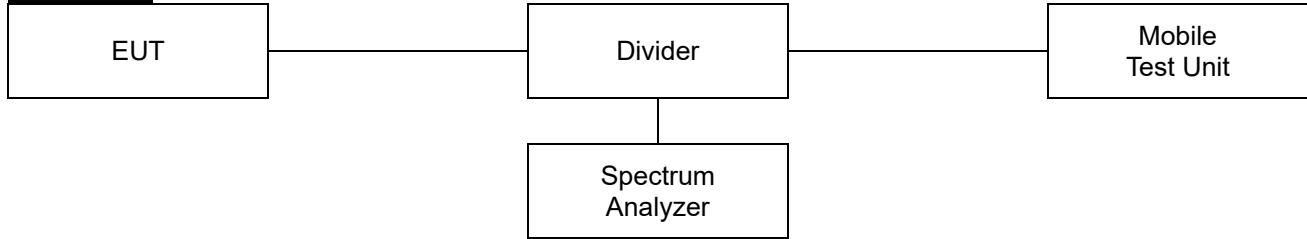

Limit

According to §22.917(a), §24.238(a), the power of any emission outside of the authorized operating frequency ranges must be attenuated below the transmitting power (P) by a factor of at least $43 + 10\log(P)$ dB.

Test procedure

971168 D01 v03r01 - Section 6

ANSI C63.26-2015 – Section 5.7

Test settings

- 1) Start frequency was set to 30 MHz and stop frequency was set to at least 10th the fundamental frequency.
- 2) Span was set large enough so as to capture all out of band emissions near the band edge.
- 3) Set the RBW > 1% of the emission bandwidth.
- 4) Set the VBW $\geq 3 \times$ RBW.
- 5) Set the number of sweep points $\geq 2 \times$ Span/RBW
- 6) Detector = RMS
- 7) Trace mode = trace average
- 8) Sweep time should be auto for peak detection. For RMS detection the sweep time should be set as follows:
 - a) If the device can be configured to transmit continuously (duty cycle $\geq 98\%$), set the (sweep time) > (number of points in sweep) \times (symbol period) (e.g., by a factor of 10 \times symbol period \times number of points) Increasing the sweep time (i.e., slowing the sweep speed) will allow for averaging over multiple symbols.
 - b) If the device cannot transmit continuously (duty cycle < 98%), a gated sweep shall be used when possible (i.e., gate triggered such that the analyzer only sweeps when the device is transmitting at full power), set the sweep time > (number of points in sweep) \times (symbol period) but the sweep time shall always be maintained at a value that is less than or equal to the minimum transmission time
 - c) If the device cannot be configured to transmit continuously (duty cycle > 98%), and a free-running sweep must be used, set the sweep time so that the averaging is performed over multiple on/off cycles by setting the sweep time > (number of points in sweep) \times (transmitter period) (i.e., the transmit on-time + the off-time). The spectrum analyzer readings shall subsequently be corrected by $[10 \log (1/\text{duty cycle})]$. This assumes that the transmission period and duty cycle is relatively constant (duty cycle variation $\leq \pm 2\%$).
 - d) If the device cannot be configured to transmit continuously and a free-running

KCTL Inc.

65, Sinwon-ro, Yeongtong-gu,
Suwon-si, Gyeonggi-do, 16677, Korea
TEL: 82-31-285-0894 FAX: 82-505-299-8311
www.kctl.co.kr

Report No.:
KR21-SRF0237-A
Page (26) of (45)



sweep must be used, and if the transmissions exhibit a non-constant duty cycle (duty cycle variations $> \pm 2\%$), set the sweep time so that the averaging is performed over the on-period by setting the sweep time $> (\text{symbol period}) \times (\text{number of points})$, while also maintaining the sweep time $< (\text{transmitter on-time})$. The trace mode shall be set to max hold, since not every display point will be averaged only over just the on-time. Thus, multiple sweeps (e.g., 100) in maximum hold are necessary to ensure that the maximum power is measured.

- 9) Allow trace to fully stabilize.

Notes:

1. Per 22.917(b), 24.238(b), compliance with these rules is based on the use of measurement instrumentation employing a resolution bandwidth of 1 MHz or greater. However in the 1 MHz bands immediately outside and adjacent to the frequency block a resolution bandwidth of at least one percent of the emission bandwidth of the fundamental emission of the transmitter may be employed. The emission bandwidth is defined as the width of the signal between two points, one below the carrier center frequency and one above the carrier center frequency, outside of which all emissions are attenuated at least 26 dB below the transmitter power.

KCTL Inc.

65, Sinwon-ro, Yeongtong-gu,
Suwon-si, Gyeonggi-do, 16677, Korea
TEL: 82-31-285-0894 FAX: 82-505-299-8311
www.kctl.co.kr

Report No.:
KR21-SRF0237-A
Page (27) of (45)



Test results

Test mode: GSM 850

GPRS Low ch.

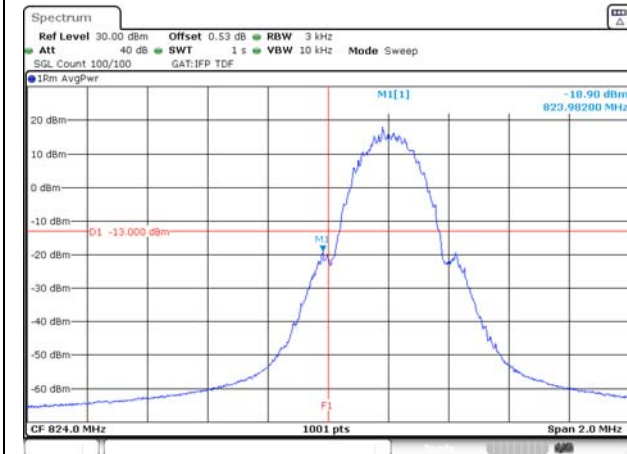

GPRS High ch.

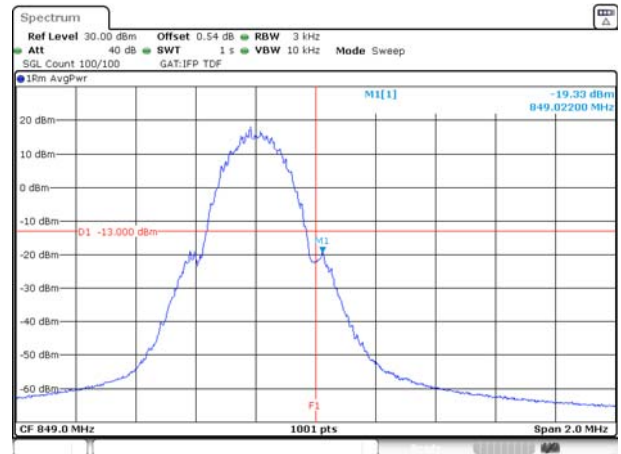

EDGE Low ch.



EDGE High ch.

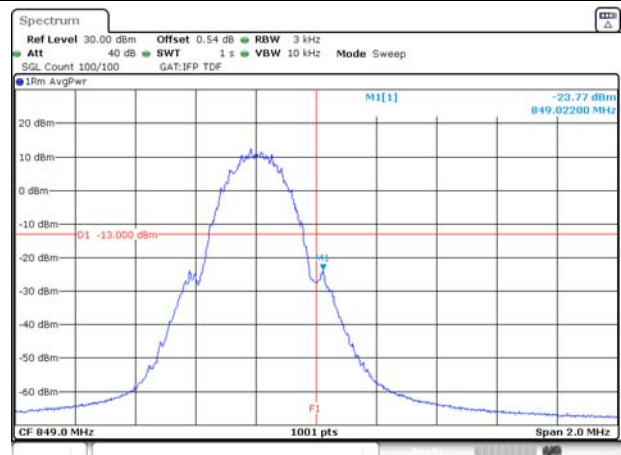

KCTL Inc.

65, Sinwon-ro, Yeongtong-gu,
Suwon-si, Gyeonggi-do, 16677, Korea
TEL: 82-31-285-0894 FAX: 82-505-299-8311
www.kctl.co.kr

Report No.:
KR21-SRF0237-A
Page (28) of (45)



Test mode: GSM 1900

Voice Low ch.

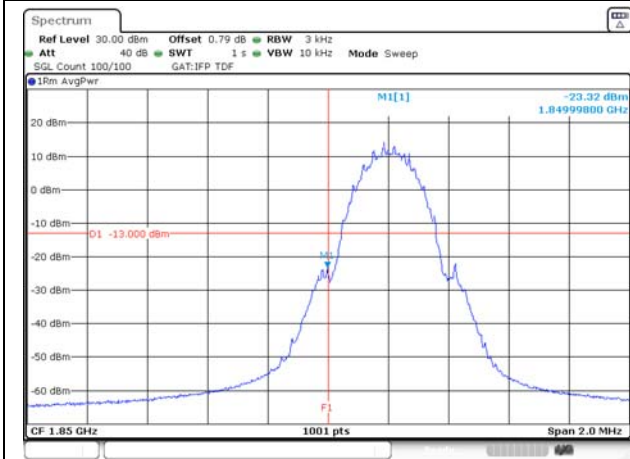

Voice High ch.

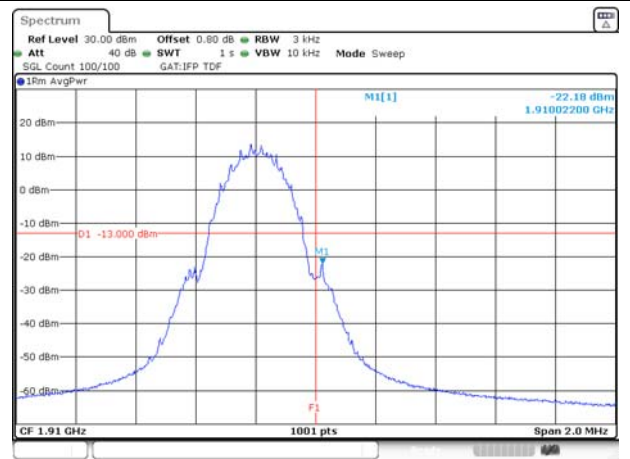

EDGE Low ch.

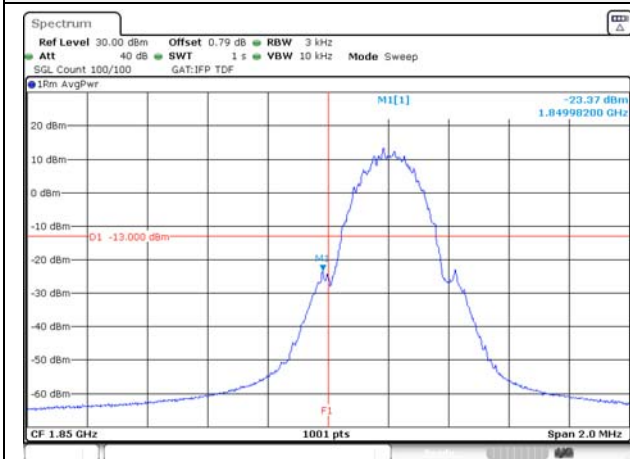

EDGE High ch.

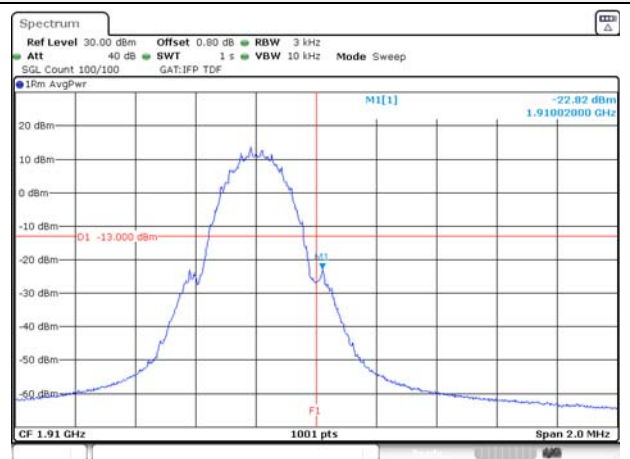

Test mode: WCDMA 850

RMC Low ch.

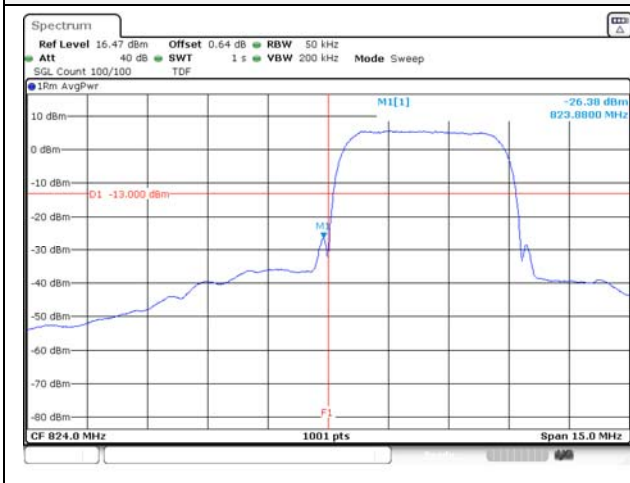

RMC High ch.

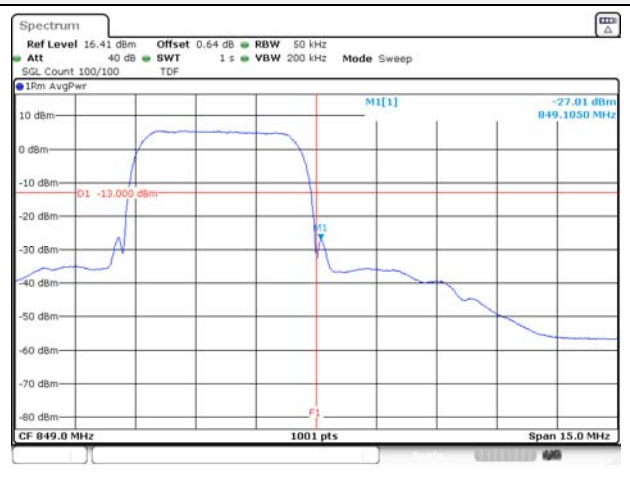

7.5. Peak to Average Power Ratio (PAPR)

Test setup

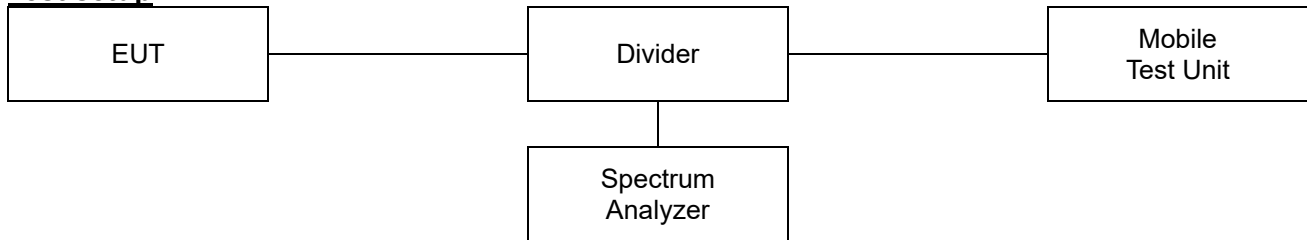

Limit

According to §24.232(d), the peak-to-average ratio(PAR) of the transmission must not exceed 13 dB.

Test procedure

971168 D01 v03r01 - Section 5.7.2 or 5.7.3
ANSI 63.26-2015 – Section 5.2.3.4 or 5.2.6

Test settings

5.2.3.4 Measurement of peak power in a broadband noise-like signal using CCDF

- 1) Set resolution/measurement bandwidth \geq OBW or specified reference bandwidth
- 2) Set the number of counts to a value that stabilizes the measured CCDF curve.
- 3) Set the measurement interval as follows:
 - a) For continuous transmissions, set to the greater of [10 x (number of points in sweep) x (transmission symbol period)] or 1 ms .
 - b) For burst transmissions, employ an external trigger that is synchronized with the EUT burst timing sequence, or use the internal burst trigger with a trigger level that allows the burst to stabilize. Set the measurement interval to a time that is less than or equal to the burst duration.
 - c) If there are several carriers in a single antenna port, the peak power shall be determined for each individual carrier (by disabling the other carriers while measuring the required carrier) and the total peak power calculated from the sum of the individual carrier peak powers.
- 4) Record the maximum PAPR level associated with a probability of 0.1%

5.2.6 Peak-to-average power ratio

Use one of the procedures presented in 5.2(ANSI C63.26-2015) to measure the total peak power and record as P_{PK} .

Use one of the applicable procedure presented 5.2(ANSI C63.26-2015) to measure the total average power and record as P_{AG} . Determine the P.A.P.R from:

$$PAPR(dB) = P_{PK}(dBm \text{ or } dBW) - P_{AG}(dBm \text{ or } dBW)$$

KCTL Inc.

65, Sinwon-ro, Yeongtong-gu,
Suwon-si, Gyeonggi-do, 16677, Korea
TEL: 82-31-285-0894 FAX: 82-505-299-8311
www.kctl.co.kr

Report No.:
KR21-SRF0237-A
Page (30) of (45)



Test results

Test mode: GSM 1900

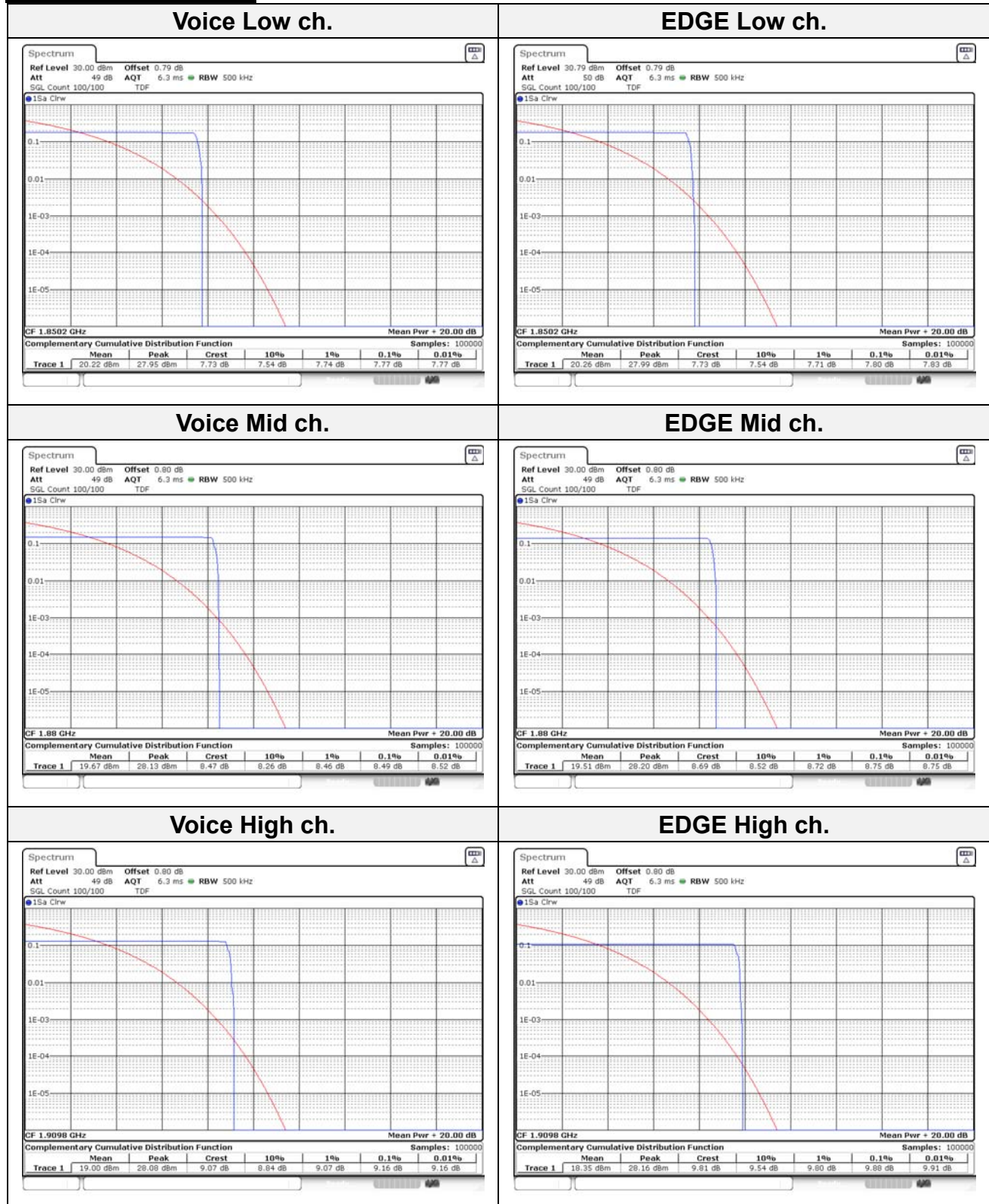

7.6. Frequency stability

Test setup

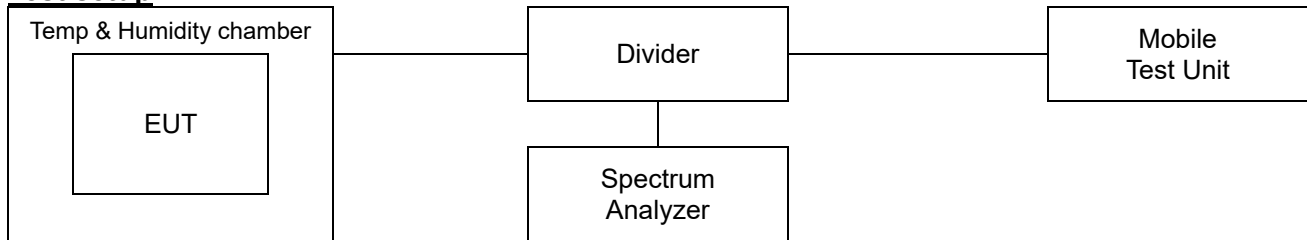

Limit

According to §2.1055(a),

The frequency stability shall be measured with variation of ambient temperature as follows:

- 1) From -30° to $+50^{\circ}$ centigrade for all equipment except that specified in paragraphs (a) (2) and (3) of this section.
- 2) From -20° to $+50^{\circ}$ centigrade for equipment to be licensed for use in the maritime services under part 80 of this chapter, except for class A, B, and S emergency position indicating radiobeacons (EPIRBS), and equipment to be licensed for use above 952 MHz at operational fixed stations in all services, stations in the local television transmission service and point-to-point microwave radio service under part 21 of this chapter, equipment licensed for use aboard aircraft in the aviation services under part 87 of this chapter, and equipment authorized for use in the family radio service under part 95 of this chapter.
- 3) From 0° to $+50^{\circ}$ centigrade for equipment to be licensed for use in the radio broadcast Services under part 73 of this chapter.

According to §2.1055(d),

The frequency stability shall be measured with variation of primary supply Voltage as follows:

- 1) Vary primary supply voltage from 85 to 115 percent of the nominal value for other than hand carried battery equipment.
- 2) For hand carried, battery powered equipment, reduce primary supply voltage to the battery operating and point which shall be specified by the manufacturer.
- 3) The supply voltage shall be measured at the input to the cable normally provided with the equipment, or at the power supply terminals if cables are not normally provided. Effects on frequency of transmitter keying (except for broadcast transmitters) and any heating element cycling at the nominal supply voltage and at each extreme also shall be shown.

According to §22.355,

The carrier frequency of each transmitter in the public mobile services must be maintained within the tolerances given in Table of this section.

For mobile devices operating in the 824 to 849 MHz band at a power level than or equal to 3 Watts, the limit specified in Table C-1 is ± 2.5 ppm.

According to §24.235,

The frequency stability shall be sufficient to ensure that the fundamental emission stays within the authorized frequency block.

The carrier frequency shall not depart from the reference frequency, in excess of ± 2.5 ppm for mobile stations and ± 1.0 ppm for base stations.

KCTL Inc.

65, Sinwon-ro, Yeongtong-gu,
Suwon-si, Gyeonggi-do, 16677, Korea
TEL: 82-31-285-0894 FAX: 82-505-299-8311
www.kctl.co.kr

Report No.:
KR21-SRF0237-A
Page (32) of (45)

The logo for KCTL, consisting of the letters 'KCTL' in a bold, blue, sans-serif font.**Test procedure**

ANSI 63.26-2015 – Section 5.6

Test settings

- 1) The carrier frequency of the transmitter is measured at room temperature.
(20°C to provide a reference)
- 2) The equipment is turned on in a “standby” condition for one minute before applying power to the transmitter. Measurement of the carrier frequency of the transmitter is made within one minute after applying power to the transmitter.
- 3) Frequency measurements are made at 10°C intervals ranging from -30°C to +50°C.
A period of at least one half-hour is provided to allow stabilization of the equipment at each Temperature level.

KCTL Inc.

65, Sinwon-ro, Yeongtong-gu,
Suwon-si, Gyeonggi-do, 16677, Korea
TEL: 82-31-285-0894 FAX: 82-505-299-8311
www.kctl.co.kr

Report No.:
KR21-SRF0237-A
Page (33) of (45)

**Test results**

Test mode : GSM 850
Frequency (Hz) : 836 600 000
Channel : 190
Deviation limit : ±0.00025% or 2.5ppm

Voltage (%)	Power (V)	Temp. (°C)	Frequency (Hz)	Frequency error (Hz)	Deviation	
					(ppm)	(%)
100%	3.88	+22(Ref)	836,600,010	9.91	0.0	0.000 001
		-30	836,599,999	-1.36	0.0	0.000 000
		-20	836,599,999	-0.92	0.0	0.000 000
		-10	836,600,002	1.55	0.0	0.000 000
		0	836,600,002	2.38	0.0	0.000 000
		+10	836,600,005	5.16	0.0	0.000 001
		+20	836,600,007	7.18	0.0	0.000 001
		+30	836,600,008	8.13	0.0	0.000 001
		+40	836,600,010	10.01	0.0	0.000 001
		+50	836,600,011	10.85	0.0	0.000 001
115%	4.46	+22	836,600,007	7.43	0.0	0.000 001
End point	3.40	+22	836,600,008	8.23	0.0	0.000 001

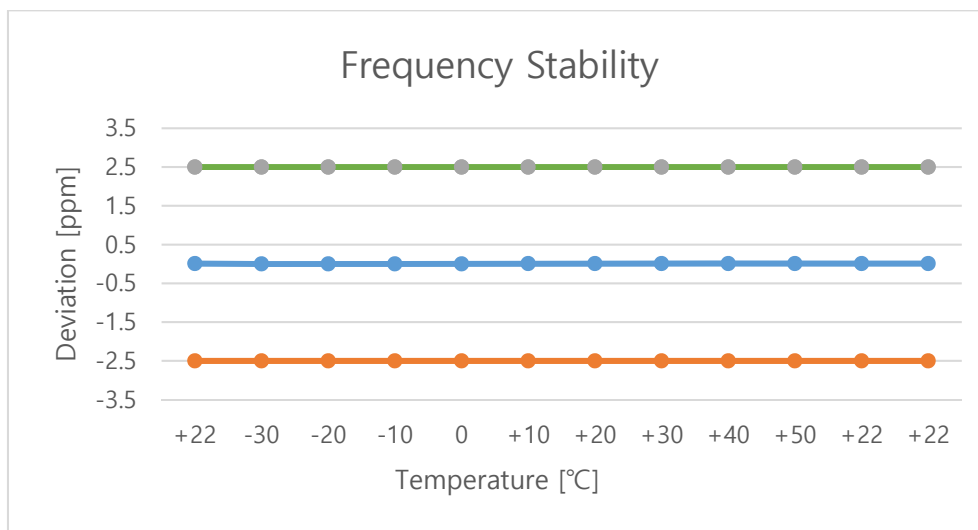

KCTL Inc.

65, Sinwon-ro, Yeongtong-gu,
Suwon-si, Gyeonggi-do, 16677, Korea
TEL: 82-31-285-0894 FAX: 82-505-299-8311
www.kctl.co.kr

Report No.:
KR21-SRF0237-A
Page (34) of (45)



Test mode : GSM 1900
 Frequency (Hz) : 1 880 000 000
 Channel : 661
 Deviation limit : The frequency stability shall be sufficient to ensure that the fundamental emission stays within the authorized frequency block.

Voltage (%)	Power (V)	Temp. (°C)	Frequency (Hz)	Frequency error (Hz)	Deviation	
					(ppm)	(%)
100%	3.88	+22(Ref)	1,879,999,993	-6.62	0.0	0.000000
		-30	1,880,000,005	5.13	0.0	0.000000
		-20	1,880,000,008	7.58	0.0	0.000000
		-10	1,880,000,003	3.39	0.0	0.000000
		0	1,880,000,003	3.18	0.0	0.000000
		+10	1,879,999,999	-1.18	0.0	0.000000
		+20	1,879,999,997	-2.58	0.0	0.000000
		+30	1,879,999,994	-5.88	0.0	0.000000
		+40	1,879,999,993	-7.35	0.0	0.000000
		+50	1,879,999,992	-8.06	0.0	0.000000
115%	4.46	+22	1,879,999,993	-6.68	0.0	0.000000
End point	3.40	+22	1,879,999,993	-7.07	0.0	0.000000

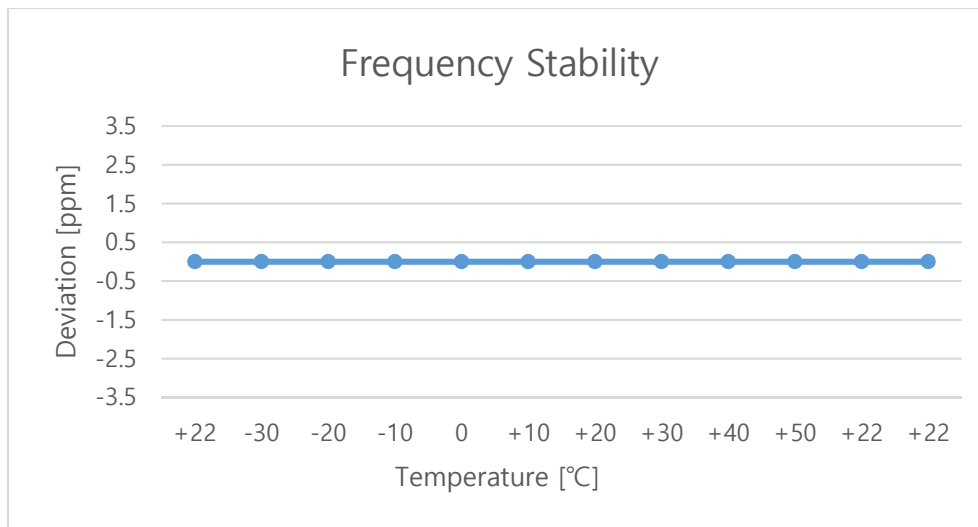

KCTL Inc.

65, Sinwon-ro, Yeongtong-gu,
Suwon-si, Gyeonggi-do, 16677, Korea
TEL: 82-31-285-0894 FAX: 82-505-299-8311
www.kctl.co.kr

Report No.:
KR21-SRF0237-A
Page (35) of (45)



Test mode : WCDMA 850
 Frequency (Hz) : 836 600 000
 Channel : 4183
 Deviation limit(FCC&IC) : ±0.00025% or 2.5 ppm

Voltage (%)	Power (V)	Temp. (°C)	Frequency (Hz)	Frequency error (Hz)	Deviation	
					(ppm)	(%)
100%	3.88	+22(Ref)	836,599,999	-0.85	0.0	0.000000
		-30	836,600,001	1.44	0.0	0.000000
		-20	836,600,001	1.16	0.0	0.000000
		-10	836,599,999	-0.75	0.0	0.000000
		0	836,599,997	-2.58	0.0	0.000000
		+10	836,599,995	-5.39	0.0	-0.000001
		+20	836,599,996	-4.11	0.0	0.000000
		+30	836,599,998	-1.58	0.0	0.000000
		+40	836,599,998	-2.08	0.0	0.000000
		+50	836,599,999	-1.33	0.0	0.000000
115%	4.46	+22(Ref)	836,599,998	-2.27	0.0	0.000000
End point	3.40	+22(Ref)	836,599,999	-0.84	0.0	0.000000

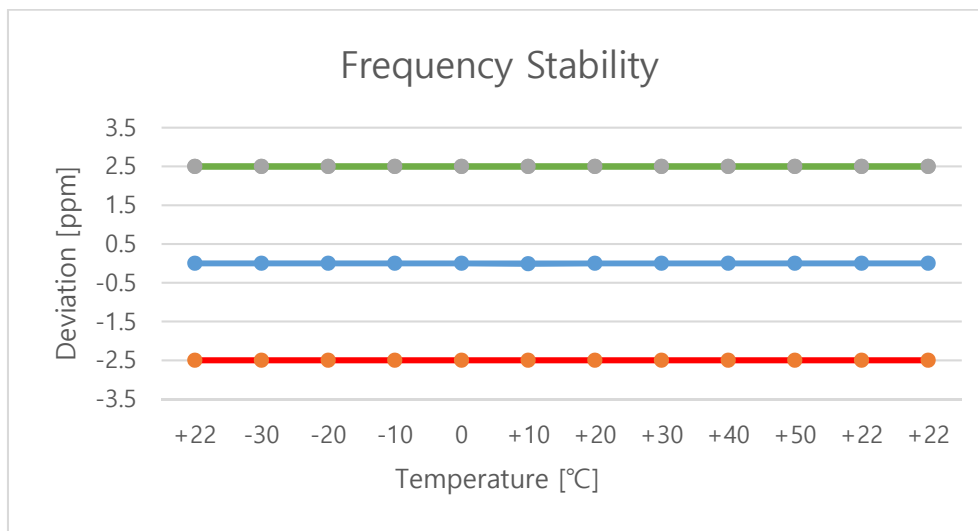

7.7. Radiated Power (ERP/EIRP)**Test setup**

The diagram below shows the test setup that is utilized to make the measurements for emission from 30 MHz to 1 GHz emissions.

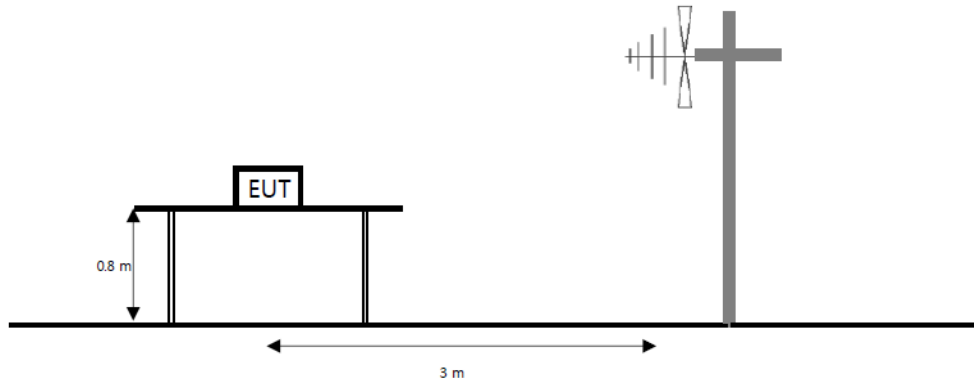

The diagram below shows the test setup that is utilized to make the measurements for emission from 1 GHz to the tenth harmonic of the highest fundamental frequency or to 40 GHz emissions, whichever is lower.

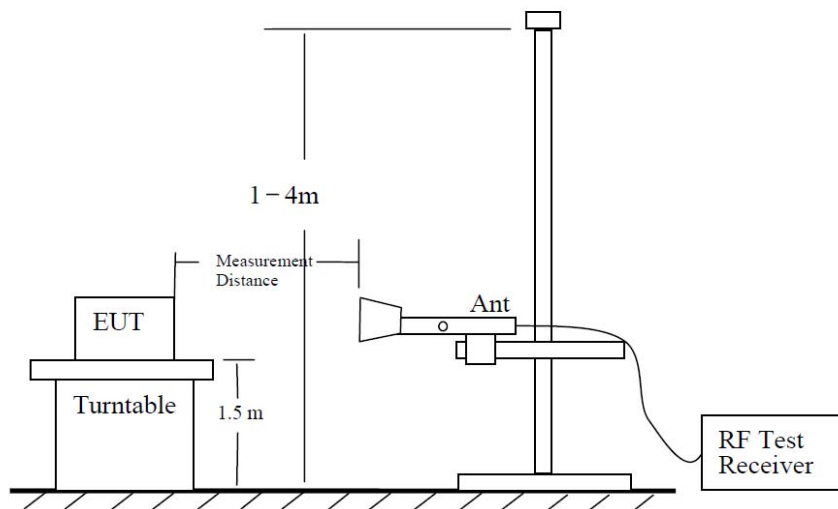

The diagram below shows the test setup for substituted method.

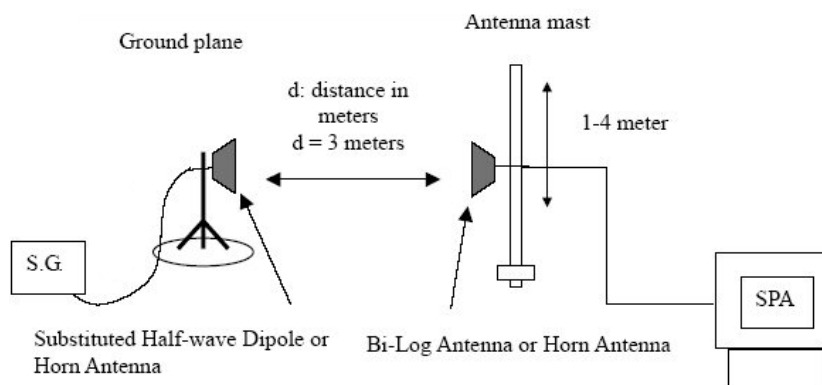

KCTL Inc.

65, Sinwon-ro, Yeongtong-gu,
Suwon-si, Gyeonggi-do, 16677, Korea
TEL: 82-31-285-0894 FAX: 82-505-299-8311
www.kctl.co.kr

Report No.:
KR21-SRF0237-A
Page (37) of (45)



Limit

According to §22.913(a)(5), the ERP of mobile transmitters and auxiliary test transmitters must not exceed 7 watts

According to §24.232(c), mobile and portable stations are limited to 2 watts EIRP and the equipment must employ a means for limiting power to the minimum necessary for successful communications.

Test procedure

971168 D01 v03r01 - Section 5.2.2
ANSI 63.26-2015 – Section 5.2.4.4.1
ANSI/TIA-603-E-2016 - Section 2.2.17

Test settings

- 1) RBW = 1 % to 5 % of the OBW.
- 2) VBW $\geq 3 \times$ RBW.
- 3) SPAN = 2 \times to 3 \times the OBW.
- 4) Number of measurement points in sweep $\geq 2 \times$ span / RBW.
- 5) Sweep time :
 - 1) Auto couple, or
 - 2) $\geq [10 \times (\text{number of points in sweep}) \times (\text{transmission period})]$ for single sweep (automation-compatible) measurement. Transmission period is the on and off time of the transmitter.
- 6) Detector = RMS
- 7) If the EUT can be configured to transmit continuously, then set the trigger to free run.
- 8) If the EUT cannot be configured to transmit continuously, then use a sweep trigger with the level set to enable triggering only on full power bursts and configure the EUT to transmit at full power for the entire duration of each sweep. Verify that the sweep time is less than or equal to the transmission burst duration. Time gating can also be used under similar constraints (i.e., configured such that measurement data is collected only during active full-power transmissions).
- 9) Trace mode = trace averaging (RMS) over 100 sweeps.
- 10) Compute the power by integrating the spectrum across the OBW of the signal using the instrument's band or channel power measurement function, with the band/channel limits set equal to the OBW band edges. If the instrument does not have a band or channel power function, then sum the spectrum levels (in linear power units) at intervals equal to the RBW extending across the entire OBW of the spectrum.
- 11) Allow trace to fully stabilize.

KCTL Inc.

65, Sinwon-ro, Yeongtong-gu,
Suwon-si, Gyeonggi-do, 16677, Korea
TEL: 82-31-285-0894 FAX: 82-505-299-8311
www.kctl.co.kr

Report No.:
KR21-SRF0237-A
Page (38) of (45)

**Notes:**

1. On a test site, the EUT shall be placed at 80 cm or 1.5 m height on a turn table, and in the position close to normal use as declared by the applicant.
2. The test antenna shall be oriented initially for vertical polarization located 3 m from EUT to correspond to the fundamental frequency of the transmitter.
3. The turntable is rotated through 360°, and the receiving antenna scans in order to determine the Level of the maximized emission.
4. The test antenna shall be raised and lowered again through the specified range of height until the maximum signal level is detected by the measuring receiver.
5. The maximum signal level detected by the measuring receiver shall be noted.
6. The EUT was replaced by half-wave dipole (1 GHz below) or horn antenna (1 GHz above) connected to a signal generator.
The power is calculated by the following formula;
$$P_d(\text{dBm}) = P_g(\text{dBm}) - \text{Cable loss (dB)} + \text{Antenna gain (dB)}$$

Note. P_d is the dipole equivalent power and P_g is the generator output power into the substitution antenna.
7. The test antenna shall be raised and lowered through the specified range of height to ensure that The maximum signal is received.
8. The input signal to the substitution antenna shall be adjusted to the level that produces a level Detected by the measuring corrected for the change of input attenuator setting of the measuring Receiver.
9. The input level to the substitution antenna shall be recorded as power level in dBm, corrected for Any change of input attenuator setting of the measuring receiver.
10. The measurement shall be repeated with the test antenna and the substitution antenna Orientated for horizontal polarization.

KCTL Inc.

65, Sinwon-ro, Yeongtong-gu,
Suwon-si, Gyeonggi-do, 16677, Korea
TEL: 82-31-285-0894 FAX: 82-505-299-8311
www.kctl.co.kr

Report No.:
KR21-SRF0237-A
Page (39) of (45)

**Test results****Test mode: GSM 850**

Mode	Channel	Frequency	Pol.	Antenna Gain	C.L	Substitute Level	ERP	
		[MHz]	[V/H]	[dBd]	[dB]	[dB m]	[dB m]	[W]
GPRS	128	824.2	V	-2.03	5.31	34.63	27.29	0.536
	190	836.6	V	-2.44	5.39	34.57	26.74	0.472
	251	848.8	V	-2.77	5.46	35.65	27.42	0.552
EDGE	128	824.2	V	-2.03	5.31	34.70	27.36	0.545
	190	836.6	V	-2.44	5.39	34.38	26.55	0.452
	251	848.8	V	-2.77	5.46	35.60	27.37	0.546

Test mode: GSM 1900

Mode	Channel	Frequency	Pol.	Antenna Gain	C.L	Substitute Level	EIRP	
		[MHz]	[V/H]	[dBi]	[dB]	[dB m]	[dB m]	[W]
Voice	512	1 850.2	V	5.15	7.89	29.62	26.88	0.488
	661	1 880.0	V	5.12	7.96	28.83	25.99	0.397
	810	1 909.8	V	5.09	7.98	28.69	25.80	0.380
EDGE	512	1 850.2	V	5.15	7.89	29.56	26.82	0.481
	661	1 880.0	V	5.12	7.96	28.81	25.97	0.395
	810	1 909.8	V	5.09	7.98	28.59	25.70	0.372

Test mode: WCDMA 850

Mode	Channel	Frequency	Pol.	Antenna Gain	C.L	Substitute Level	ERP	
		[MHz]	[V/H]	[dBd]	[dB]	[dB m]	[dB m]	[W]
RMC	4132	826.40	V	-1.81	5.33	26.67	19.53	0.090
	4183	836.60	V	-2.44	5.39	25.94	18.11	0.065
	4233	846.60	V	-2.82	5.44	26.81	18.55	0.072

Note.

1. E.R.P & E.I.R.P(dBm) = Substitute Level(dB) + Antenna gain(dBi&dBd) - C.L(Cable loss) (dB)

7.8. Radiated Spurious Emissions

Test setup

The diagram below shows the test setup that is utilized to make the measurements for emission from 30 MHz to 1 GHz emissions.

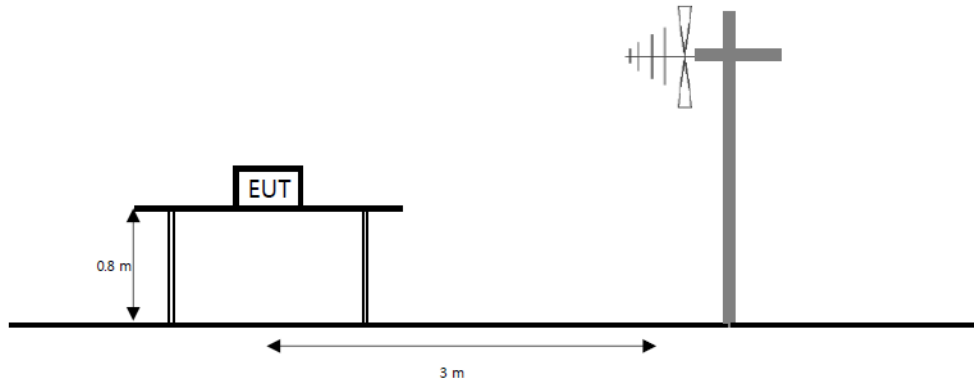

The diagram below shows the test setup that is utilized to make the measurements for emission from 1 GHz to the tenth harmonic of the highest fundamental frequency or to 40 GHz emissions, whichever is lower.

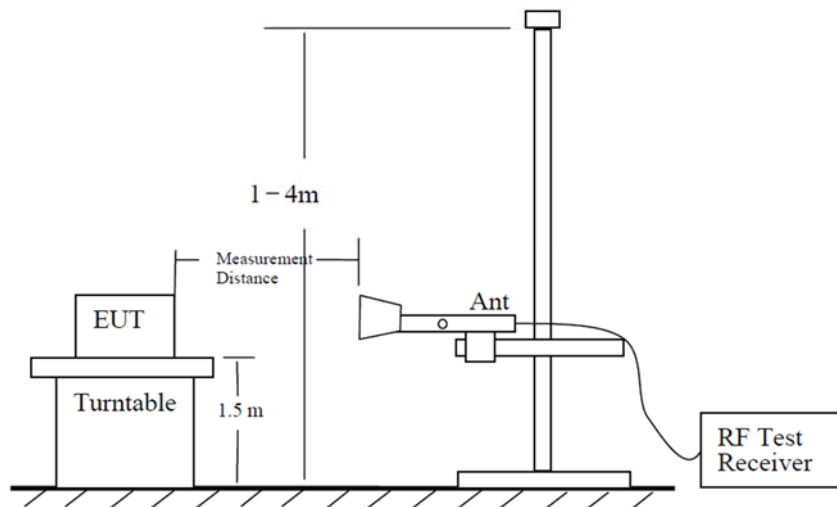

The diagram below shows the test setup for substituted method.

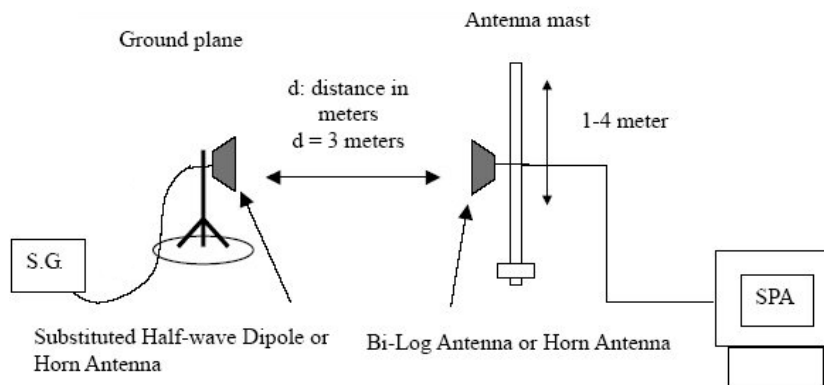

KCTL Inc.

65, Sinwon-ro, Yeongtong-gu,
Suwon-si, Gyeonggi-do, 16677, Korea
TEL: 82-31-285-0894 FAX: 82-505-299-8311
www.kctl.co.kr

Report No.:
KR21-SRF0237-A
Page (41) of (45)

KCTL

Limit

According to §22.917(a), §24.238(a), the power of any emission outside of the authorized operating frequency ranges must be attenuated below the transmitting power (P) by a factor of at least $43 + 10\log(P)$ dB.

Test procedure

971168 D01 v03r01 - Section 5.8
ANSI 63.26-2015 – Section 5.5
ANSI/TIA-603-E-2016 - Section 2.2.12

Test settings

- 1) RBW = 1 kHz for below 1 GHz and 1 MHz for above 1 GHz.
- 2) VBW $\geq 3 \times$ RBW.
- 3) Detector = RMS
- 4) Trace mode = Max hold
- 5) Sweep time = Auto couple
- 6) Number of sweep points $\geq 2 \times$ span / RBW
- 7) Allow trace to fully stabilize.

Notes:

1. On a test site, the EUT shall be placed at 80 cm or 1.5 m height on a turn table, and in the position close to normal use as declared by the applicant.
2. The test antenna shall be oriented initially for vertical polarization located 3 m from EUT to correspond to the fundamental frequency of the transmitter.
3. The turntable is rotated through 360° , and the receiving antenna scans in order to determine the Level of the maximized emission.
4. The test antenna shall be raised and lowered again through the specified range of height until the maximum signal level is detected by the measuring receiver.
5. The maximum signal level detected by the measuring receiver shall be noted.
6. The EUT was replaced by half-wave dipole (1 GHz below) or horn antenna (1 GHz above) connected to a signal generator.
7. The test antenna shall be raised and lowered through the specified range of height to ensure that the maximum signal is received.
8. The input signal to the substitution antenna shall be adjusted to the level that produces a level detected by the measuring corrected for the change of input attenuator setting of the measuring Receiver.
9. The input level to the substitution antenna shall be recorded as power level in dBm, corrected for any change of input attenuator setting of the measuring receiver.
10. The measurement shall be repeated with the test antenna and the substitution antenna oriented for horizontal polarization.

KCTL Inc.

65, Sinwon-ro, Yeongtong-gu,
Suwon-si, Gyeonggi-do, 16677, Korea
TEL: 82-31-285-0894 FAX: 82-505-299-8311
www.kctl.co.kr

Report No.:
KR21-SRF0237-A
Page (42) of (45)

**Test results (Above 1 000 MHz)**

Test mode : GSM 850

Frequency(MHz) : 824.2

Channel : 128

Mode	Frequency	Pol.	Antenna Gain	Cable loss	Substitute Level	Level	Limit	Margin
	[MHz]	[V/H]	[dBi]	[dB]	[dBm]	[dBm]	[dBm]	[dB]
GPRS	1 648.65	H	5.35	7.51	-51.64	-53.80	-13.00	40.80
	2 472.49	H	5.94	9.17	-47.67	-50.90	-13.00	37.90
	3 296.73	H	7.59	10.82	-52.57	-55.80	-13.00	42.80
	4 120.98	H	8.97	12.25	-50.22	-53.50	-13.00	40.50

Test mode : GSM 850

Frequency(MHz) : 836.6

Channel : 190

Mode	Frequency	Pol.	Antenna Gain	Cable loss	Substitute Level	Level	Limit	Margin
	[MHz]	[V/H]	[dBi]	[dB]	[dBm]	[dBm]	[dBm]	[dB]
GPRS	1 673.68	V	5.33	7.51	-59.42	-61.60	-13.00	48.60
	2 510.23	V	6.02	9.26	-43.56	-46.80	-13.00	33.80
	3 346.79	H	7.69	10.92	-51.27	-54.50	-13.00	41.50
	4 184.16	V	9.06	12.19	-49.97	-53.10	-13.00	40.10

Test mode : GSM 850

Frequency(MHz) : 848.8

Channel : 251

Mode	Frequency	Pol.	Antenna Gain	Cable loss	Substitute Level	Level	Limit	Margin
	[MHz]	[V/H]	[dBi]	[dB]	[dBm]	[dBm]	[dBm]	[dB]
GPRS	1 698.29	V	5.30	7.57	-58.13	-60.40	-13.00	47.40
	2 546.75	H	6.09	9.35	-46.04	-49.30	-13.00	36.30
	3 396.02	V	7.79	11.02	-52.57	-55.80	-13.00	42.80
	4 244.06	V	9.14	12.23	-50.21	-53.30	-13.00	40.30

Note.

1. E.R.P & E.I.R.P(dB m) = Substitute Level(dB) + Antenna gain(dB i&dB d) - C.L(Cable loss) (dB)

KCTL Inc.

65, Sinwon-ro, Yeongtong-gu,
Suwon-si, Gyeonggi-do, 16677, Korea
TEL: 82-31-285-0894 FAX: 82-505-299-8311
www.kctl.co.kr

Report No.:
KR21-SRF0237-A
Page (43) of (45)

KCTLTest mode : GSM 1900Frequency(MHz) : 1 850.2Channel : 512

Mode	Frequency	Pol.	Antenna Gain	Cable loss	Substitute Level	Level	Limit	Margin
	[MHz]	[V/H]	[dBi]	[dB]	[dBm]	[dBm]	[dBm]	[dB]
Voice	3 700.88	V	8.32	11.63	-50.09	-53.40	-13.00	40.40
	5 550.11	V	10.72	14.51	-48.91	-52.70	-13.00	39.70
	7 399.97	H	12.22	16.77	-45.95	-50.50	-13.00	37.50
	9 251.12	V	13.10	18.73	-44.37	-50.00	-13.00	37.00

Test mode : GSM 1900Frequency(MHz) : 1 880.0Channel : 661

Mode	Frequency	Pol.	Antenna Gain	Cable loss	Substitute Level	Level	Limit	Margin
	[MHz]	[V/H]	[dBi]	[dB]	[dBm]	[dBm]	[dBm]	[dB]
Voice	3 760.25	V	8.42	11.52	-49.30	-52.40	-13.00	39.40
	5 640.75	V	10.76	14.44	-48.42	-52.10	-13.00	39.10
	7 519.98	H	12.32	16.82	-45.60	-50.10	-13.00	37.10
	9 399.21	V	13.10	18.93	-43.17	-49.00	-13.00	36.00

Test mode : GSM 1900Frequency(MHz) : 1 909.8Channel : 810

Mode	Frequency	Pol.	Antenna Gain	Cable loss	Substitute Level	Level	Limit	Margin
	[MHz]	[V/H]	[dBi]	[dB]	[dBm]	[dBm]	[dBm]	[dB]
Voice	3 819.61	H	8.51	11.70	-50.31	-53.50	-13.00	40.50
	5 729.48	V	10.79	14.57	-48.72	-52.50	-13.00	39.50
	7 639.35	V	12.41	17.10	-47.71	-52.40	-13.00	39.40
	9 546.66	H	13.07	18.99	-44.78	-50.70	-13.00	37.70

Note.

1. E.R.P & E.I.R.P(dB m) = Substitute Level(dB) + Antenna gain(dB i&dB d) - C.L(Cable loss) (dB)

KCTL Inc.

65, Sinwon-ro, Yeongtong-gu,
Suwon-si, Gyeonggi-do, 16677, Korea
TEL: 82-31-285-0894 FAX: 82-505-299-8311
www.kctl.co.kr

Report No.:
KR21-SRF0237-A
Page (44) of (45)

KCTL

Test mode : WCDMA 850

Frequency(MHz) : 826.4

Channel : 4132

Mode	Frequency	Pol.	Antenna Gain	Cable loss	Substitute Level	Level	Limit	Margin
	[MHz]	[V/H]	[dBi]	[dB]	[dBm]	[dBm]	[dBm]	[dB]
RMC	1 652.34	V	5.35	7.47	-58.58	-60.70	-13.00	47.70
	2 478.64	V	5.96	9.19	-53.07	-56.30	-13.00	43.30
	3 305.76	H	7.61	10.84	-52.57	-55.80	-13.00	42.80
	4 132.06	H	8.98	12.27	-51.01	-54.30	-13.00	41.30

Test mode : WCDMA 850

Frequency(MHz) : 836.6

Channel : 4183

Mode	Frequency	Pol.	Antenna Gain	Cable loss	Substitute Level	Level	Limit	Margin
	[MHz]	[V/H]	[dBi]	[dB]	[dBm]	[dBm]	[dBm]	[dB]
RMC	1 673.27	V	5.33	7.51	-59.22	-61.40	-13.00	48.40
	2 508.59	H	6.02	9.26	-51.86	-55.10	-13.00	42.10
	3 347.20	H	7.69	10.92	-51.17	-54.40	-13.00	41.40
	4 184.16	H	9.06	12.19	-50.07	-53.20	-13.00	40.20

Test mode : WCDMA 850

Frequency(MHz) : 846.6

Channel : 4233

Mode	Frequency	Pol.	Antenna Gain	Cable loss	Substitute Level	Level	Limit	Margin
	[MHz]	[V/H]	[dBi]	[dB]	[dBm]	[dBm]	[dBm]	[dB]
RMC	1 693.78	H	5.31	7.56	-57.85	-60.10	-13.00	47.10
	2 539.36	H	6.08	9.34	-53.14	-56.40	-13.00	43.40
	3 387.40	V	7.77	11.00	-50.87	-54.10	-13.00	41.10
	4 232.17	V	9.13	12.20	-49.43	-52.50	-13.00	39.50

Note.

1. E.R.P & E.I.R.P(dB m) = Substitute Level(dB) + Antenna gain(dB i&dB d) - C.L(Cable loss) (dB)

KCTL Inc.

65, Sinwon-ro, Yeongtong-gu,
Suwon-si, Gyeonggi-do, 16677, Korea
TEL: 82-31-285-0894 FAX: 82-505-299-8311
www.kctl.co.kr

Report No.:
KR21-SRF0237-A
Page (45) of (45)



8. Measurement equipment

Equipment Name	Manufacturer	Model No.	Serial No.	Next Cal. Date
Spectrum Analyzer	R&S	FSV30	100732	22.01.20
Spectrum Analyzer	KEYSIGHT	N9040B	US55230151	22.07.28
Vector Signal Generator	R&S	SMBV100A	257566	22.07.29
Signal Generator	R&S	SMB100A	176206	22.01.20
Power Divider	AGILENT	11636B	54456	21.12.31
DC Power Supply	AGILENT	E3632A	MY40027567	22.05.10
Wideband Radio Communication Tester	R&S	CMW500	141780	22.04.01
Temp & Humid Chamber	ESPEC CORP.	SH-642	93016978	22.03.04
Biconical VHF-UHF Broadband Antenna	SCHWARZBECK	VUBA9117	275	22.04.09
Bilog Antenna	ETS.LINDGREN	3143B	00228420	21.09.30
Horn Antenna	ETS.lindgren	3115	62589	22.07.09
Horn Antenna	ETS.LINDGREN	3117	00227509	21.09.23
Horn Antenna	ETS.lindgren	3116	00086632	22.01.29
Horn Antenna	ETS.lindgren	3116	00086635	22.05.17
High pass Filter	Wainwright Instruments GmbH	WHKX12-2805-3000-18000-40SS	32	22.08.20*
High pass Filter	Wainwright Instruments GmbH	WHKX10-900-1000-15000-40SS	11	22.08.20*
Broadband Amplifier	SONOMA INSTRUMENT	310N	186280	22.08.20*
Amplifier	LTC MICROWAVE	LLA01185522Q-B	141	22.07.19
Amplifier	L-3 Narda-MITEQ	JS44-18004000-33-8P	2000996	22.01.21
Antenna Stand	innco systems GmbH	AS1500-EP-10kg	N/A	N/A
Antenna Stand	innco systems GmbH	AS1500-EP-10kg	N/A	N/A
Turn Device	innco systems GmbH	DE3700-RH	N/A	N/A

* Tests related to this equipment were progressed after the calibration was completed.

End of test report