



FCC CFR47 PART 15 SUBPART C

Bluetooth Low Energy

CERTIFICATION TEST REPORT

FOR

GSM/WCDMA/LTE Phone + BT/BLE, DTS b/g/n and NFC

MODEL NUMBER : SM-A205S

FCC ID: A3LSMA205S

REPORT NUMBER: 4788869688-E3V1

ISSUE DATE: APR 19, 2019

Prepared for
SAMSUNG ELECTRONICS CO., LTD.
129 SAMSUNG-RO, YEONGTONG-GU, SUWON-SI,
GYEONGGI-DO, 16677, KOREA

Prepared by
UL Korea, Ltd.
26th floor, 152, Teheran-ro, Gangnam-gu Seoul, 06236, Korea

Suwon Test Site: UL Korea, Ltd. Suwon Laboratory
218 Maeyeong-ro, Yeongtong-gu,
Suwon-si, Gyeonggi-do, 16675, Korea
TEL: (031) 337-9902
FAX: (031) 213-5433



Testing
Laboratory

TL-637

Revision History

<u>Rev.</u>	<u>Issue Date</u>	<u>Revisions</u>	<u>Revised By</u>
V1	04/19/19	Initial issue	Hoonpyo Lee

TABLE OF CONTENTS

1. ATTESTATION OF TEST RESULTS	5
1.1. INTRODUCTION OF TEST DATA REUSE	6
1.2. DIFFERENCE	6
1.3. SPOT CHECK VERIFICATION DATA.....	6
1.4. REFERENCE DETAIL.....	7
2. TEST METHODOLOGY	8
3. FACILITIES AND ACCREDITATION	8
4. CALIBRATION AND UNCERTAINTY	8
4.1. MEASURING INSTRUMENT CALIBRATION.....	8
4.2. SAMPLE CALCULATION.....	8
4.3. MEASUREMENT UNCERTAINTY	9
5. EQUIPMENT UNDER TEST	10
5.1. DESCRIPTION OF EUT.....	10
5.2. MAXIMUM OUTPUT POWER.....	10
5.3. DESCRIPTION OF AVAILABLE ANTENNAS	10
5.4. WORST-CASE CONFIGURATION AND MODE	11
5.5. DESCRIPTION OF TEST SETUP.....	12
6. TEST AND MEASUREMENT EQUIPMENT	14
7. REFERENCE MEASUREMENT RESULTS.....	15
7.1. ON TIME AND DUTY CYCLE RESULTS.....	15
7.2. 99% BANDWIDTH	16
8. MEASUREMENT METHODS	19
9. SUMMARY TABLE	20
10. ANTENNA PORT TEST RESULTS	21
10.1. 6 dB BANDWIDTH.....	21
10.2. OUTPUT POWER.....	24
10.3. AVERAGE POWER.....	27
10.4. PSD.....	28
10.5. OUT-OF-BAND EMISSIONS	31
11. RADIATED TEST RESULTS.....	38

11.1. LIMITS AND PROCEDURE	38
11.2. TRANSMITTER ABOVE 1 GHz	40
11.2.1. 1Mbps MODE	40
11.2.2. 2Mbps MODE	50
11.3. WORST-CASE BELOW 1 GHz.....	60
12. AC POWER LINE CONDUCTED EMISSIONS	62
13. SETUP PHOTOS.....	65

1. ATTESTATION OF TEST RESULTS

COMPANY NAME: SAMSUNG ELECTRONICS CO., LTD.
EUT DESCRIPTION: GSM/WCDMA/LTE Phone + BT/BLE, DTS b/g/n and NFC
MODEL NUMBER: SM-A205S
SERIAL NUMBER: R38KB0HB4SW (RADIATED, Original);
R38KB0HB5BP (CONDUCTED, Original)
R39M30M7RKF, R39M30M7RFM (RADIATED, Spot check)
DATE TESTED: JAN 21, 2019 - FEB 21, 2019 (Original)
APR 10, 2019 – APR 11, 2019 (Spot check)

APPLICABLE STANDARDS	
STANDARD	TEST RESULTS
CFR 47 Part 15 Subpart C	Pass

UL Korea, Ltd. tested the above equipment in accordance with the requirements set forth in the above standards. All indications of Pass/Fail in this report are opinions expressed by UL Korea, Ltd. based on interpretations and/or observations of test results. Measurement Uncertainties were not taken into account and are published for informational purposes only. The test results show that the equipment tested is capable of demonstrating compliance with the requirements as documented in this report.

Note: The results documented in this report apply only to the tested sample, under the conditions and modes of operation as described herein. This document JUN not be altered or revised in any way unless done so by UL Korea, Ltd. and all revisions are duly noted in the revisions section. Any alteration of this document not carried out by UL Korea, Ltd. will constitute fraud and shall nullify the document. This report must not be used by the client to claim product certification, approval, or endorsement by IAS, any agency of the Federal Government, or any agency of any government.

Approved & Released For
UL Korea, Ltd. By:

Tested By:



SungGil Park
Suwon Lab Engineer
UL Korea, Ltd.

Hoonpyo Lee
Suwon Lab Engineer
UL Korea, Ltd.

1.1. INTRODUCTION OF TEST DATA REUSE

This report referenced from the FCC ID: A3LSMA205GN DTS BLE(FCC CFR 47 Part 15C). And the applicant takes full responsibility that the test data as referenced in this report represent compliance for this FCC ID.

1.2. DIFFERENCE

The FCC ID: A3LSMA205S shares the same enclosure and circuit board as FCC ID: A3LSMA205GN. The BLE antennas and surrounding circuitry and layout are identical between these two units.

After confirming through preliminary radiated emissions that the performance of the FCC ID: A3LSMA205GN remains representative of FCC ID: A3LSMA205S. The test data of FCC ID: A3LSMA205GN being submitted for this application to cover BLE features.

1.3. SPOT CHECK VERIFICATION DATA

(Worst case of the radiated spurious and band edge emissions)

Band	Test Item	Mode	Frequency	Test Limit	Original model	Spot check model	Deviation	Remark
					SM-A205GN/DS Results	SM-A205S Results		
					FCC ID : A3LSMA205GN	FCC ID : A3LSMA205S		
DTS BLE (2.4GHz)	Band Edge	1Mbps	2480 MHz	54 dBuV/m	40.90 dBuV/m	43.79 dBuV/m	2.89 dB	
	RSE	1Mbps	2480 MHz	74 dBuV/m	43.71 dBuV/m	46.16 dBuV/m	2.45 dB	
	Band Edge	2Mbps	2480 MHz	54 dBuV/m	42.69 dBuV/m	45.43 dBuV/m	2.74 dB	
	RSE	2Mbps	2440 MHz	74 dBuV/m	39.41 dBuV/m	33.54 dBuV/m	-5.87 dB	

Comparison of two models, upper deviation is within 3dB range and all test results are under FCC Technical Limits.

Output power verification was performed for the spot check model, all conducted power test results were in the tune up tolerance range. Also deviation for maximum output power result is within upper 0.5dB range.

1.4. REFERENCE DETAIL

Reference application that contains the reused reference data.

Equipment Class	Reference FCC ID	Type Grant/Permissive Change	Reference Application	Folder Test/RF Exposure	Report Title / Section
PCE	A3LSMA205GN	Grant	4788869685-E1	Test	FCC Report WWAN / WCDMA B5, LTE B2/B5/B41
DTS	A3LSMA205GN	Grant	4788869685-E2	Test	FCC Report DTS/ All sections
			4788869685-E3		FCC Report BLE/ All sections
DSS	A3LSMA205GN	Grant	4788869685-E4	Test	FCC Report BT / All sections
DXX	A3LSMA205GN	Grant	4788869685-E5	Test	FCC Report NFC/ All sections

2. TEST METHODOLOGY

The tests documented in this report were performed in accordance with following methods.

1. FCC CFR 47 Part 2.
2. FCC CFR 47 Part 15.
3. KDB 558074 D01 15.247 Meas Guidance v05r02.
4. KDB 484596 D01 Referencing Test Data v01
5. ANSI C63.10-2013.

3. FACILITIES AND ACCREDITATION

The test sites and measurement facilities used to collect data are located at 218 Maeyeong-ro, Yeongtong-gu, Suwon-si, Gyeonggi-do, 16675, Korea. Line conducted emissions are measured only at the 218 address. The following table identifies which facilities were utilized for radiated emission measurements documented in this report. Specific facilities are also identified in the test results sections.

218 Maeyeong-ro	
<input checked="" type="checkbox"/>	Chamber 1
<input checked="" type="checkbox"/>	Chamber 2
<input type="checkbox"/>	Chamber 3

UL Korea, Ltd. is accredited by IAS, Laboratory Code TL-637. The full scope of accreditation can be viewed at <http://www.iasonline.org/PDF/TL/TL-637.pdf>.

4. CALIBRATION AND UNCERTAINTY

4.1. MEASURING INSTRUMENT CALIBRATION

The measuring equipment utilized to perform the tests documented in this report has been calibrated in accordance with the manufacturer's recommendations, and is traceable to recognized national standards.

4.2. SAMPLE CALCULATION

Where relevant, the following sample calculation is provided:

$$\begin{aligned} \text{Field Strength (dBuV/m)} &= \text{Measured Voltage (dBuV)} + \text{Antenna Factor (dB/m)} + \\ &\text{Cable Loss (dB)} - \text{Preamp Gain (dB)} \\ 36.5 \text{ dBuV} + 18.7 \text{ dB/m} + 0.6 \text{ dB} - 26.9 \text{ dB} &= 28.9 \text{ dBuV/m} \end{aligned}$$

4.3. MEASUREMENT UNCERTAINTY

Where relevant, the following measurement uncertainty levels have been estimated for tests performed on the apparatus:

PARAMETER	UNCERTAINTY
Conducted Disturbance, 0.15 to 30 MHz	2.32 dB
Radiated Disturbance, Below 1GHz	3.86 dB
Radiated Disturbance, Above 1 GHz	5.97 dB

Uncertainty figures are valid to a confidence level of 95%.

5. EQUIPMENT UNDER TEST

5.1. DESCRIPTION OF EUT

The EUT is a GSM/WCDMA/LTE Phone + BT/BLE, DTS b/g/n and NFC.
This test report addresses the DTS (BLE) operational mode.

5.2. MAXIMUM OUTPUT POWER

The transmitter has a maximum total conducted output power as follows:

Frequency Range [MHz]	Mode	Power Mode	Output Power [dBm]	Output Power [mW]
2402 - 2480	1Mbps	Peak	6.381	4.35
		Average	5.740	3.75
	2Mbps	Peak	6.406	4.37
		Average	5.544	3.58

5.3. DESCRIPTION OF AVAILABLE ANTENNAS

The radio utilizes an internal antenna, with a maximum gain of -0.53 dBi.

5.4. WORST-CASE CONFIGURATION AND MODE

Radiated emission below 1GHz and power line conducted emission were performed with the EUT set to transmit at the channel with highest output power as worst-case scenario.

Radiated emission above 1GHz was performed with the EUT set to transmit low/mid/high channels.

The fundamental of the EUT was investigated in three orthogonal orientations X, Y and Z it was determined that Y orientation was worst-case orientation; therefore, all final radiated testing was performed with the EUT in Y orientation.

Note : All radiated and power line conducted tests were performed connected with earphone and charger for evaluation of worst case mode.

Power verification

The Output Power of all data rate are all investigated, the 1Mbps(255 pkt) and 2Mbps(255 pkt) power is the worst case for symbol rate. All tests were performed in these two modes.

Symbol Rate [Ms/s]	Mode	Frequency [MHz]	Conducted Burst Avg (dBm)	Symbol Rate [Ms/s]	Mode	Frequency [MHz]	Conducted Burst Avg (dBm)
1	1Mbps (37 pkt)	2402	5.239	2	2Mbps (37 pkt)	2402	5.021
		2440	5.700			2440	5.460
		2480	4.982			2480	4.748
	1Mbps (255 pkt)	2402	5.282		2Mbps (255 pkt)	2402	5.099
		2440	5.740			2440	5.544
		2480	5.007			2480	4.816

5.5. DESCRIPTION OF TEST SETUP

SUPPORT EQUIPMENT

Support Equipment List				
Description	Manufacturer	Model	Serial Number	FCC ID
Charger	SAMSUNG	EP-TA200	R37M16TB401SE3	N/A
Data Cable	SAMSUNG	EP-DR140ABE	N/A	N/A
Earphone	SAMSUNG	EHS64AVFBE	N/A	N/A

I/O CABLE

I/O Cable List						
Cable No	Port	# of identical ports	Connector Type	Cable Type	Cable Length (m)	Remarks
1	DC Power	1	C Type	Shielded	1.1m	N/A
2	Audio	2	Mini-Jack	Unshielded	1.2m	N/A

TEST SETUP

The EUT is a stand-alone unit during the tests.
Test software in hidden menu exercised the EUT to enable BLE mode.

SETUP DIAGRAM FOR TESTS (CONDUCTED TEST SETUP)

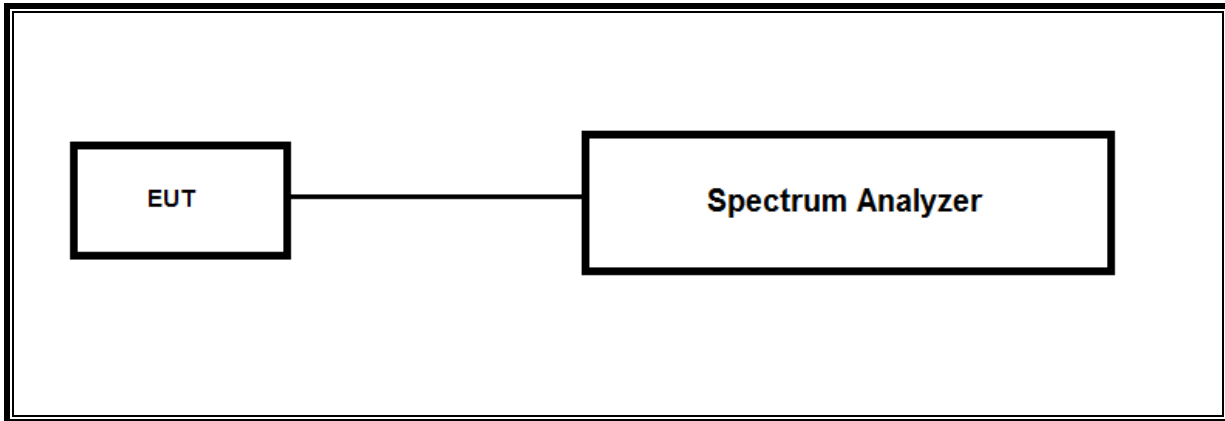

SETUP DIAGRAM FOR TESTS (RADIATED TEST SETUP)

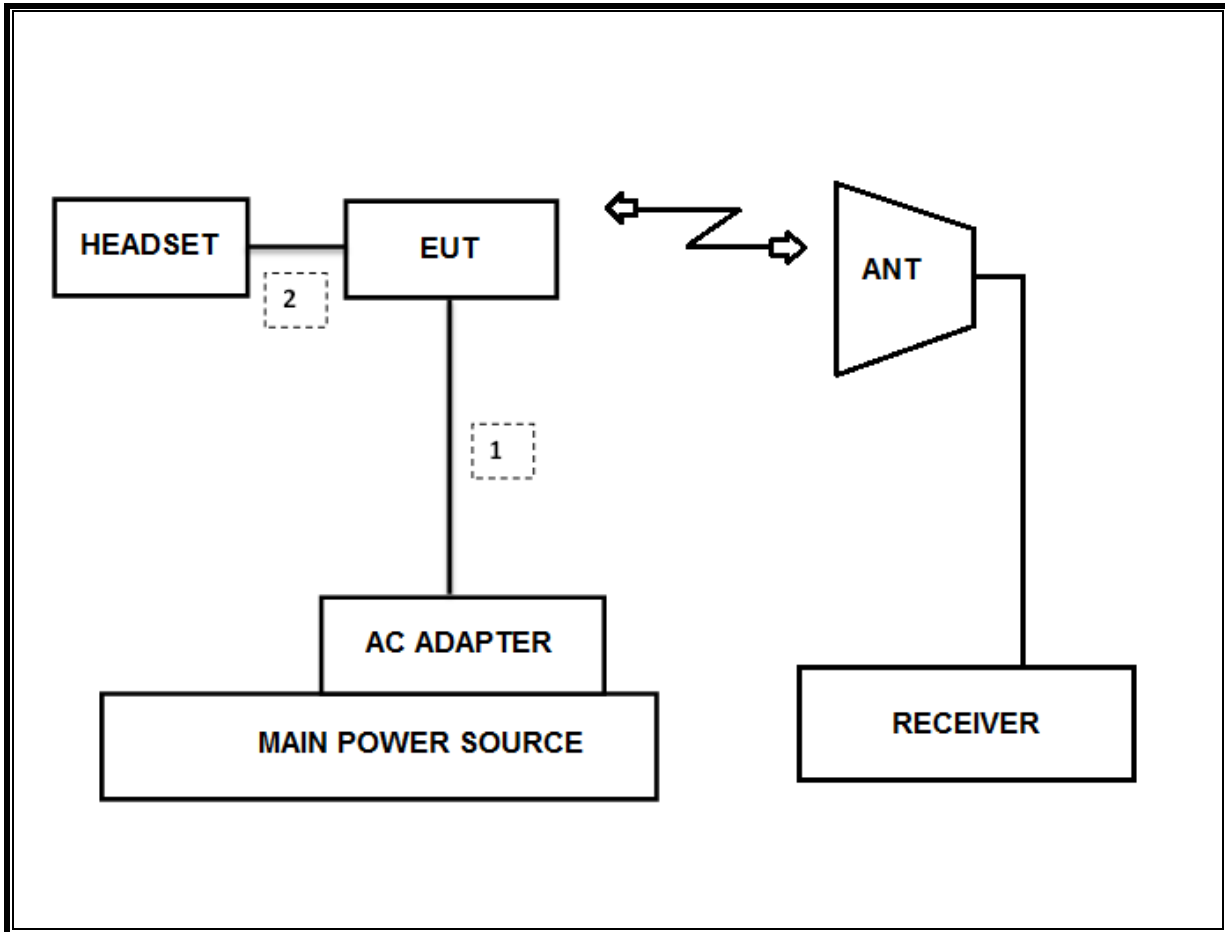

6. TEST AND MEASUREMENT EQUIPMENT

The following test and measurement equipment was utilized for the tests documented in this report:

Test Equipment List				
Description	Manufacturer	Model	S/N	Cal Due
Antenna, Bilog, 30MHz-1GHz	SCHWARZBECK	VULB9163	750	08-04-20
Antenna, Bilog, 30MHz-1GHz	SCHWARZBECK	VULB9163	749	08-04-20
Antenna, Bilog, 30MHz-1GHz	SCHWARZBECK	VULB9163	845	08-04-20
Antenna, Horn, 18 GHz	ETS	3115	00167211	08-04-20
Antenna, Horn, 18 GHz	ETS	3115	00161451	08-04-20
Antenna, Horn, 18 GHz	ETS	3117	00168724	08-04-20
Antenna, Horn, 18 GHz	ETS	3117	00168717	08-04-20
Antenna, Horn, 18 GHz	ETS	3117	00205959	08-04-20
Antenna, Horn, 40 GHz	ETS	3116C	00166155	08-14-20
Antenna, Horn, 40 GHz	ETS	3116C	00168645	12-04-19
Antenna, Horn, 40 GHz	ETS	3116C-PA	00168841	08-09-19
Preamplifier, 1000 MHz	Sonoma	310N	341282	08-07-19
Preamplifier, 1000 MHz	Sonoma	310N	351741	08-06-19
Preamplifier, 1000 MHz	Sonoma	310N	370599	08-07-19
Preamplifier, 18 GHz	Miteq	AFS42-00101800-25-S-42	1876511	08-07-19
Preamplifier, 18 GHz	Miteq	AFS42-00101800-25-S-42	1896138	08-07-19
Preamplifier, 18 GHz	Miteq	AFS42-00101800-25-S-42	2029169	08-07-19
Spectrum Analyzer, 44 GHz	Agilent / HP	N9030A	MY54170614	08-06-19
Spectrum Analyzer, 44 GHz	Agilent / HP	N9030A	MY54490312	08-06-19
Average Power Sensor	Agilent / HP	U2000	MY54270007	08-07-19
Attenuator	PASTERNAK	PE7087-10	A001	08-08-19
Attenuator	PASTERNAK	PE7087-10	A008	08-08-19
Attenuator	PASTERNAK	PE7087-10	2	08-07-19
EMI Test Receive, 40 GHz	R&S	ESU40	100439	08-06-19
EMI Test Receive, 40 GHz	R&S	ESU40	100457	08-06-19
EMI Test Receive, 44 GHz	R&S	ESW44	101590	08-06-19
EMI Test Receive, 3 GHz	R&S	ESR3	101832	08-06-19
Low Pass Filter 5GHz	Micro-Tronics	LPS17541	009	08-07-19
Low Pass Filter 5GHz	Micro-Tronics	LPS17541	015	08-07-19
Low Pass Filter 5GHz	Micro-Tronics	LPS17541	020	08-06-19
High Pass Filter 3GHz	Micro-Tronics	HPM17543	010	08-07-19
High Pass Filter 3GHz	Micro-Tronics	HPM17543	015	08-07-19
High Pass Filter 3GHz	Micro-Tronics	HPM17543	020	08-06-19
High Pass Filter 6GHz	Micro-Tronics	HPS17542	009	08-07-19
High Pass Filter 6GHz	Micro-Tronics	HPS17542	016	08-07-19
High Pass Filter 6GHz	Micro-Tronics	HPS17542	021	08-06-19
Antenna, Loop, 9kHz-30MHz	R&S	HFH2-Z2	100418	10-26-19
LISN	R&S	ENV-216	101837	08-09-19
UL Software				
Description	Manufacturer	Model	Version	
Radiated software	UL	UL EMC	Ver 9.5	
AC Line Conducted software	UL	UL EMC	Ver 9.5	

7. REFERENCE MEASUREMENT RESULTS

7.1. ON TIME AND DUTY CYCLE RESULTS

LIMITS

None: for reporting purposes only.

Mode	ON Time B [msec]	Period [msec]	Duty Cycle x [linear]	Duty Cycle [%]	Duty Cycle Correction Factor [dB]	1/T Minimum VBW [kHz]
2400MHz Bands						
BLE 1M	2.128	2.500	0.851	85.1%	0.70	0.470
BLE 2M	1.070	1.876	0.570	57.0%	2.44	0.935



7.2. 99% BANDWIDTH

LIMITS

None; for reporting purposes only.

TEST PROCEDURE

The transmitter output is connected to the spectrum analyzer. The RBW is set to 1% to 3% of the 99 % bandwidth and to 1% of the span. The VBW is set to ≥ 3 times the RBW. The spectrum analyzer internal 99% bandwidth function is utilized.

RESULTS

- 1Mbps

Channel	Frequency [MHz]	99% Bandwidth [MHz]
Low	2402	1.097
Mid	2440	1.096
High	2480	1.078
Worst		1.097

- 2Mbps

Channel	Frequency [MHz]	99% Bandwidth [MHz]
Low	2402	2.077
Mid	2440	2.075
High	2480	2.071
Worst		2.077

99% BANDWIDTH PLOTS

- 1Mbps

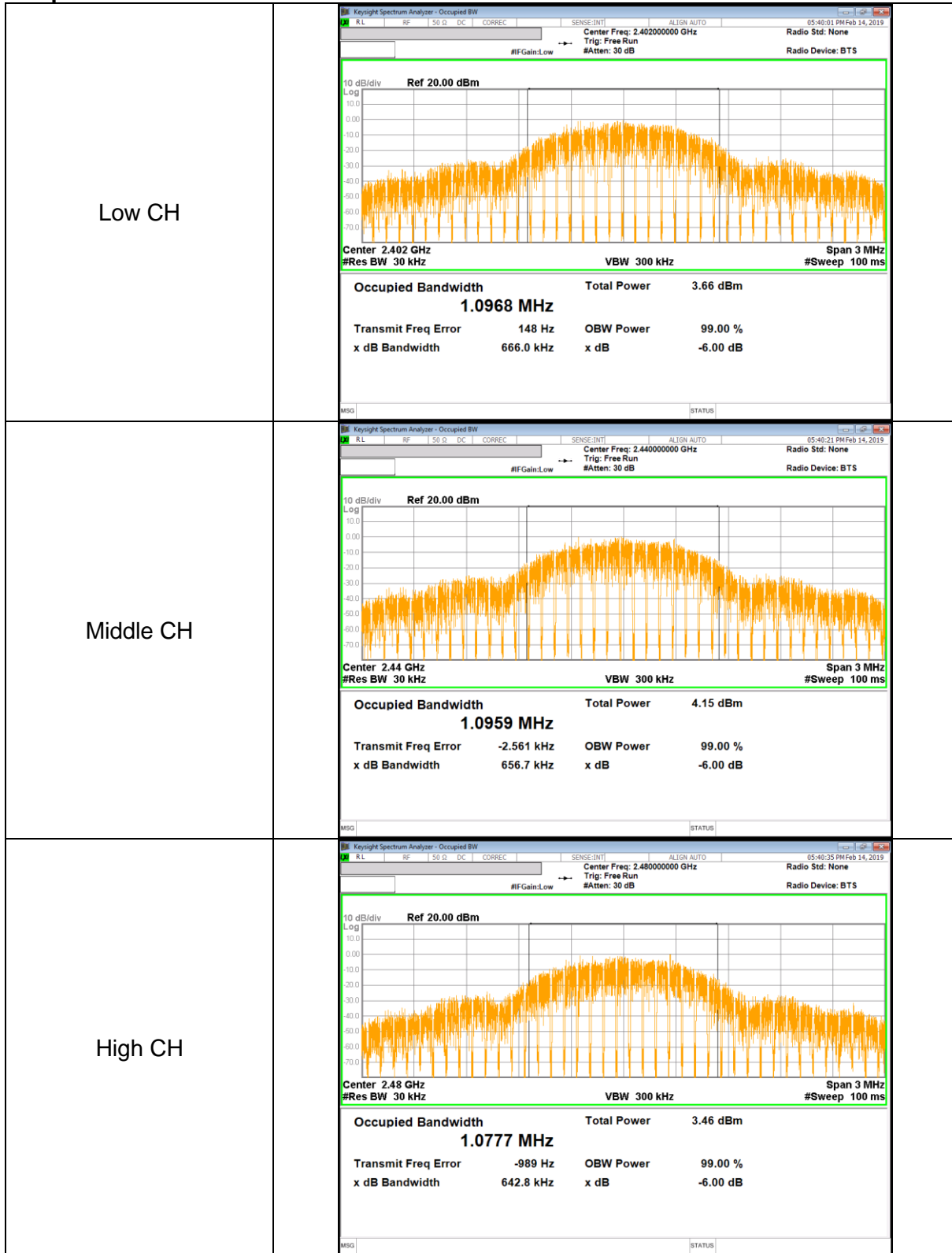

- 2Mbps

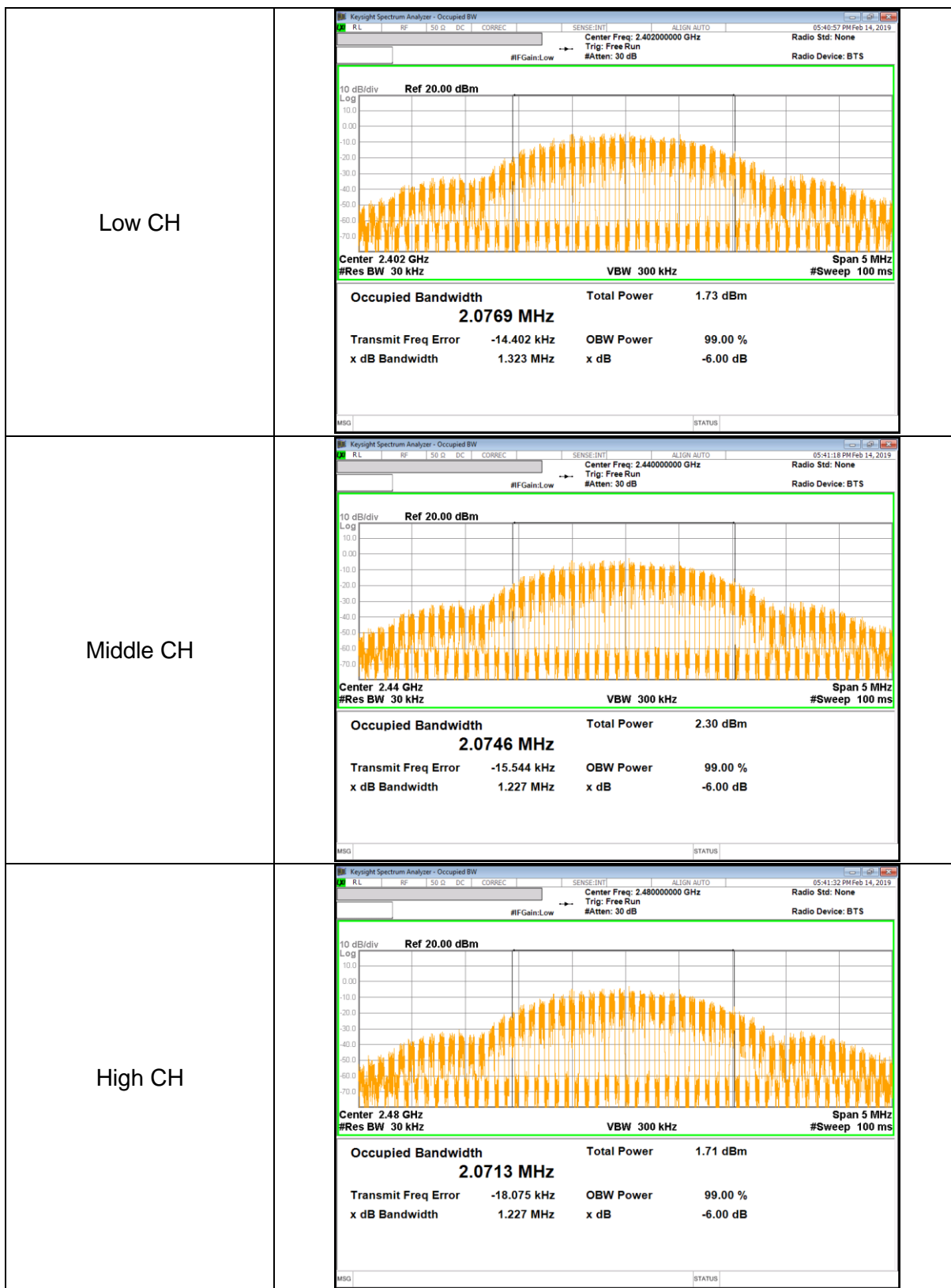

8. MEASUREMENT METHODS

6 dB BW : KDB 558074 D01 v05, Section 8.2.

OUTPUT POWER : KDB 558074 D01 v05r02, Section 8.3.2.3

POWER SPECTRAL DENSITY : KDB 558074 D01 v05r02, Section 8.4.

Out-of-band Emissions (Conducted) : KDB 558074 D01 v05r02, Section 8.5.

Out-of-band Emissions in Non-restricted Bands: KDB 558074 D01 v05r02, Section 8.5.

Out-of-band Emissions in Restricted Bands : KDB 558074 D01 v05r02, Section 8.6.

AC Power Line Conducted Emission : ANSI C63.10-2013, Section 6.2

9. SUMMARY TABLE

FCC Part Section	Test Description	Test Limit	Test Condition	Test Result
15.247 (a)(2)	Occupied Band width (6dB)	>500KHz	Conducted	Pass
2.1051, 15.247 (d)	Band Edge / Conducted Spurious Emission	-20dBc		Pass
15.247 (b)(3)	TX conducted output power	<30dBm		Pass
15.247 (e)	PSD	<8dBm		Pass
15.207 (a)	AC Power Line conducted emissions	Section 10	Power Line conducted	Pass
15.205, 15.209	Radiated Spurious Emission	< 54dBuV/m(Av)	Radiated	Pass

10. ANTENNA PORT TEST RESULTS

10.1. 6 dB BANDWIDTH

LIMITS

FCC §15.247 (a) (2)

The minimum 6 dB bandwidth shall be at least 500 kHz.

TEST PROCEDURE

Reference to section 11.8 in ANSI C63.10(2013): The transmitter output is connected to a spectrum analyzer with the RBW set to 100kHz, the VBW $\geq 3 \times$ RBW, peak detector and max hold.

RESULTS

- 1Mbps

Channel	Frequency [MHz]	6 dB Bandwidth [kHz]	Minimum Limit [kHz]
Low	2402	703.16	500.0
Mid	2440	708.37	500.0
High	2480	709.42	500.0
Worst		703.16	500.0

- 2Mbps

Channel	Frequency [MHz]	6 dB Bandwidth [MHz]	Minimum Limit [kHz]
Low	2402	1.274	500.0
Mid	2440	1.273	500.0
High	2480	1.276	500.0
Worst		1.273	500.0

6 dB BANDWIDTH PLOTS

- 1Mbps

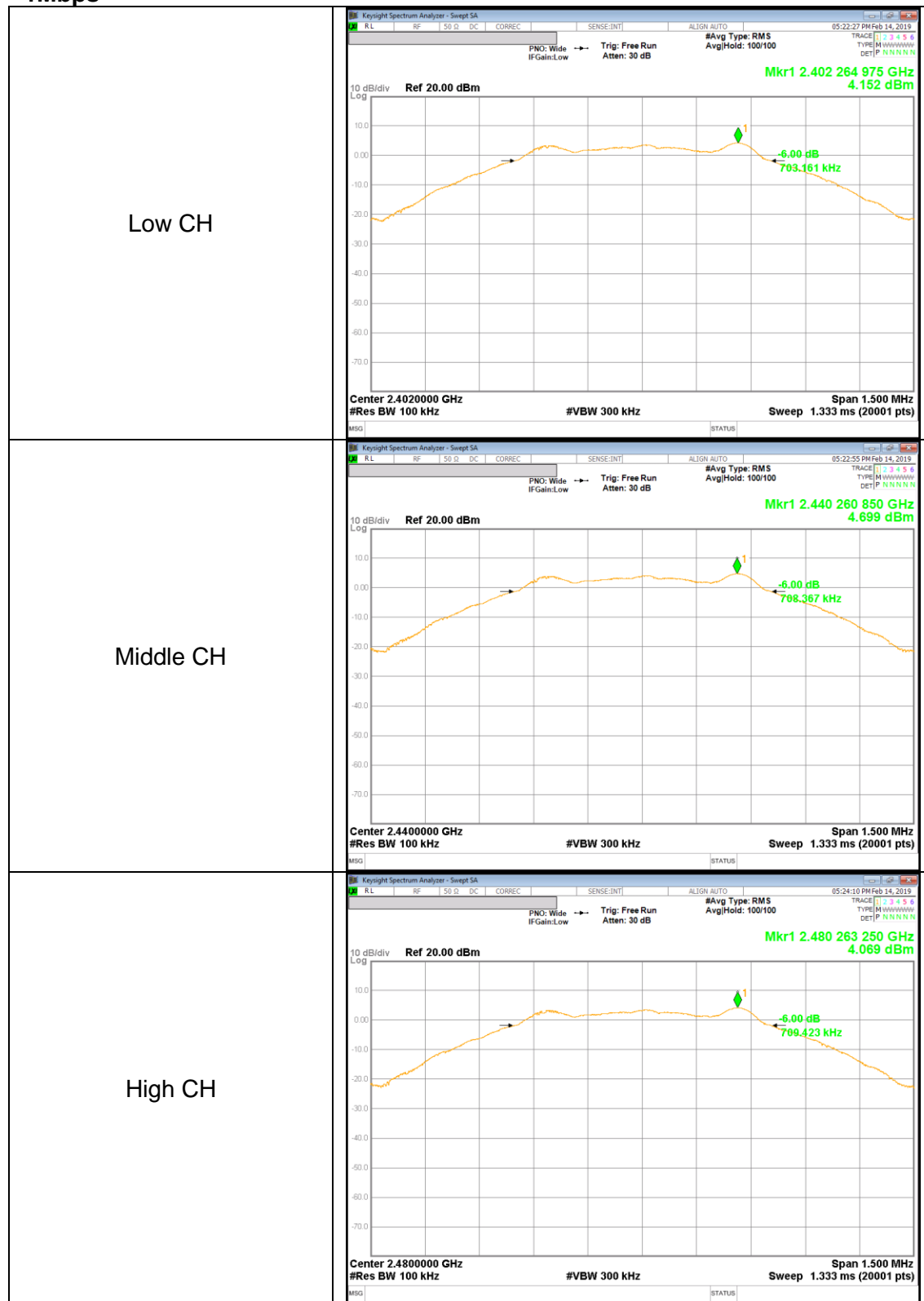

- 2Mbps

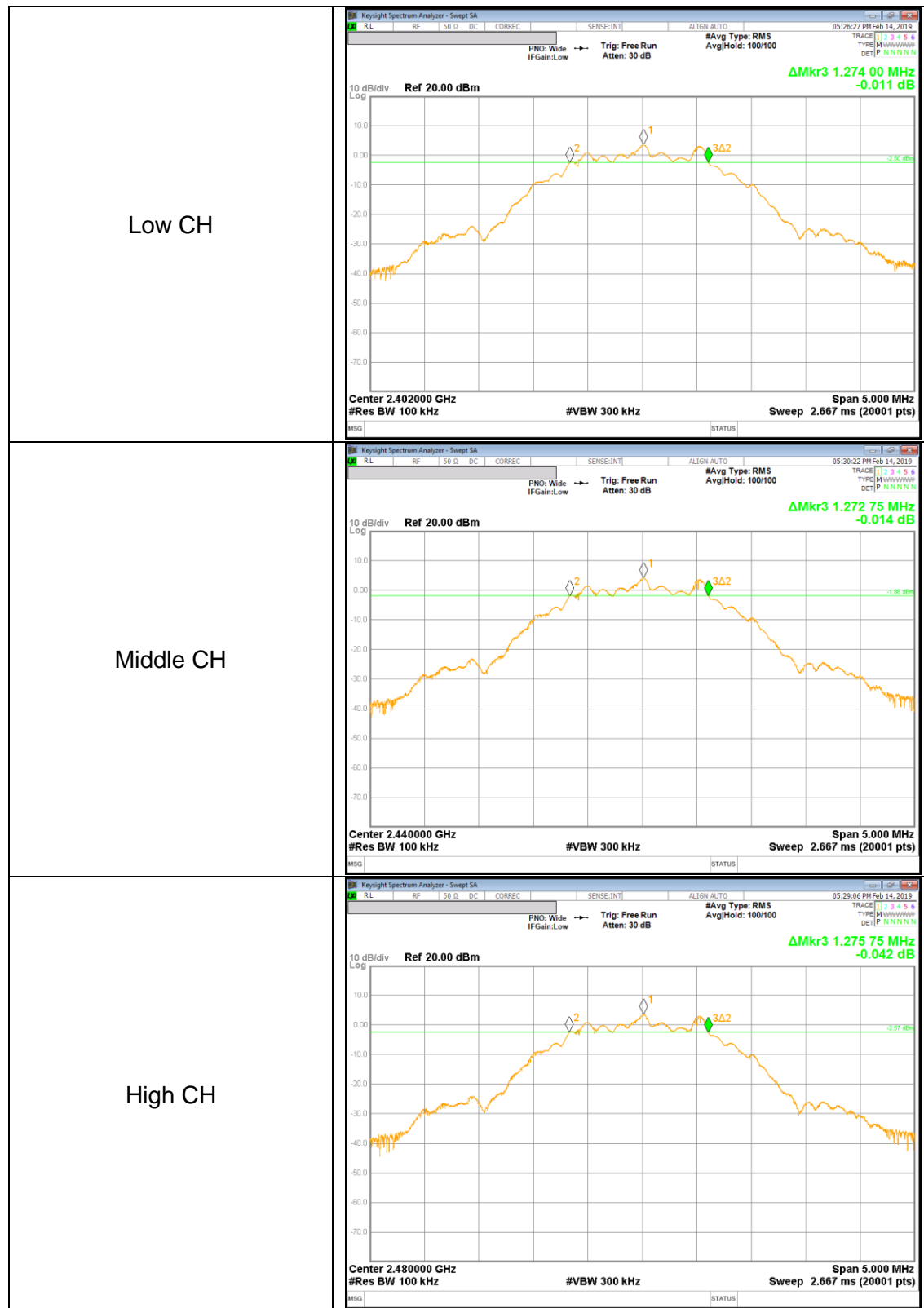

10.2. OUTPUT POWER

LIMITS

FCC §15.247 (b)

The maximum antenna gain is less than or equal to 6 dBi, therefore the limit is 30 dBm.

TEST PROCEDURE

Peak power is measured using ANSI C63.10(2013) under section 11.9.1.1 utilizing spectrum analyzer.

RESULTS

- 1Mbps

Channel	Frequency [MHz]	Peak Power Reading [dBm]	Limit [dBm]	Margin [dB]
Low	2402	5.957	30.000	-24.043
Mid	2440	6.381	30.000	-23.619
High	2480	5.559	30.000	-24.441
Worst		6.381	30.000	-23.619

- 2Mbps

Channel	Frequency [MHz]	Peak Power Reading [dBm]	Limit [dBm]	Margin [dB]
Low	2402	5.992	30.000	-24.008
Mid	2440	6.406	30.000	-23.594
High	2480	5.635	30.000	-24.365
Worst		6.406	30.000	-23.594

OUTPUT POWER PLOTS

- 1Mbps

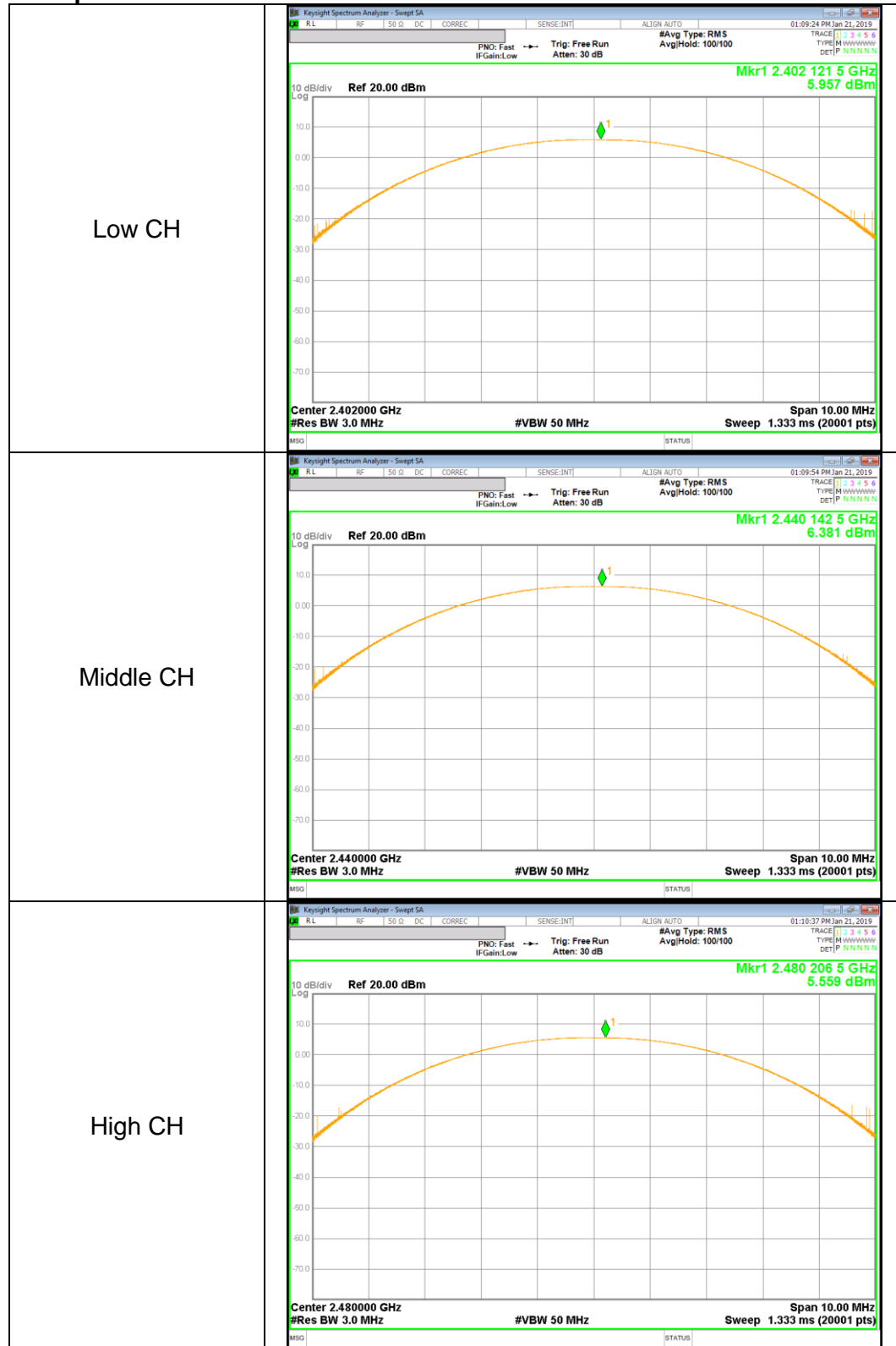

- 2Mbps

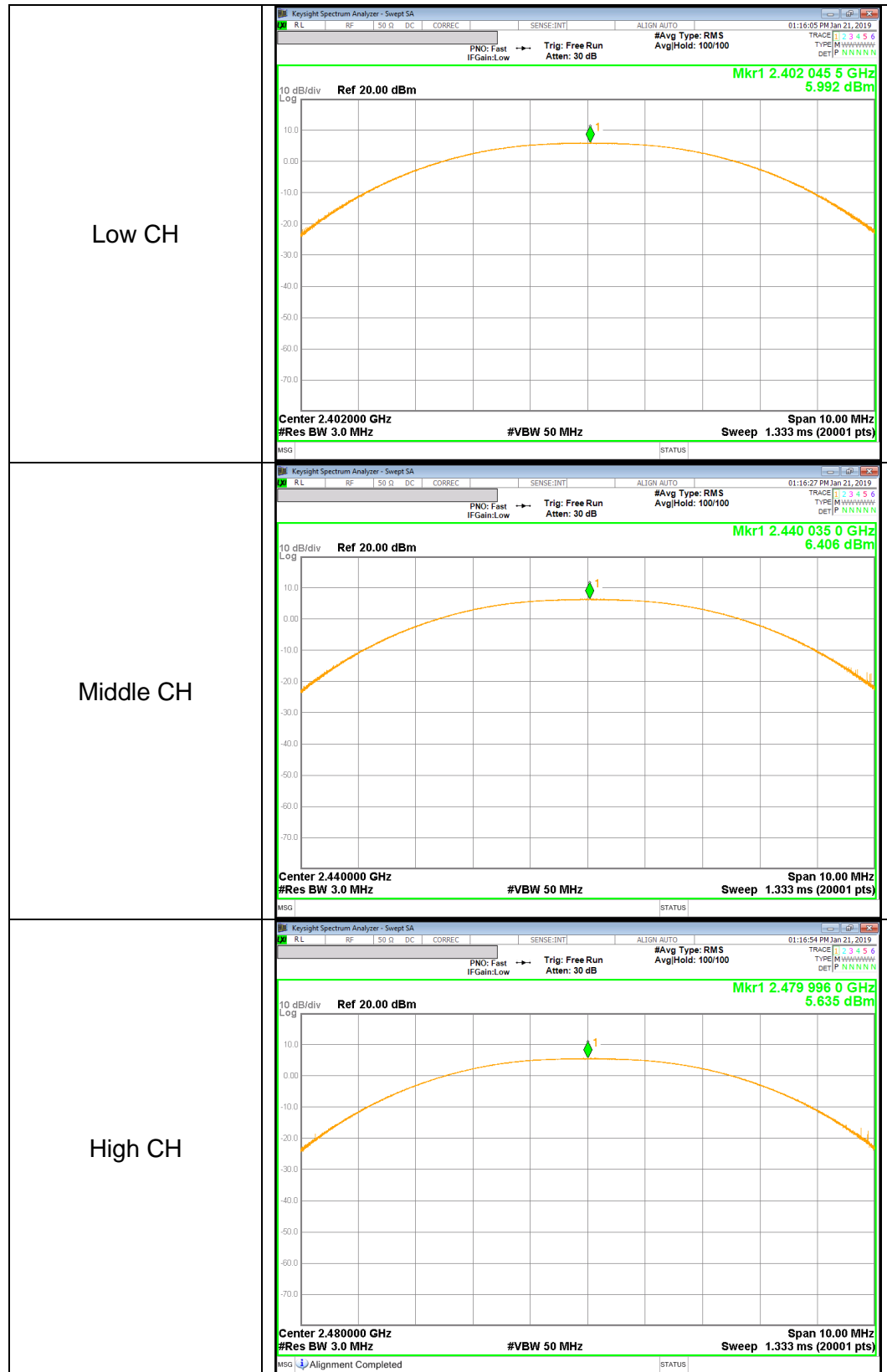

10.3. AVERAGE POWER

LIMITS

None; for reporting purposes only.

TEST PROCEDURE

The transmitter output is connected to a power meter.

RESULTS

The cable assembly insertion loss was entered as an offset in the power meter to allow for direct reading of power. The duty factor already has been added.

- 1Mbps

Channel	Frequency [MHz]	AV power [dBm]	AV power [mW]
Low	2402	5.282	3.374
Middle	2440	5.740	3.750
High	2480	5.007	3.167

- 2Mbps

Channel	Frequency [MHz]	AV power [dBm]	AV power [mW]
Low	2402	5.099	3.235
Middle	2440	5.544	3.584
High	2480	4.816	3.031

10.4. PSD

LIMITS

FCC §15.247

The power spectral density conducted from the transmitter to the antenna shall not be greater than 8 dBm in any 3 kHz band during any time interval of continuous transmission.

TEST PROCEDURE

Power Spectral Density was performed utilizing the ANSI C63.10 section 11.10.2 (Method PKPSD).

RESULTS

- 1Mbps

Channel	Frequency [MHz]	PSD [dBm/3kHz]	Limit [dBm/3kHz]	Margin [dB]
Low	2402	-12.11	8.00	-20.11
Mid	2440	-11.60	8.00	-19.60
High	2480	-12.15	8.00	-20.15

- 2Mbps

Channel	Frequency [MHz]	PSD [dBm/3kHz]	Limit [dBm/3kHz]	Margin [dB]
Low	2402	-14.74	8.00	-22.74
Mid	2440	-14.29	8.00	-22.29
High	2480	-14.94	8.00	-22.94

POWER SPECTRAL DENSITY PLOTS

- 1Mbps

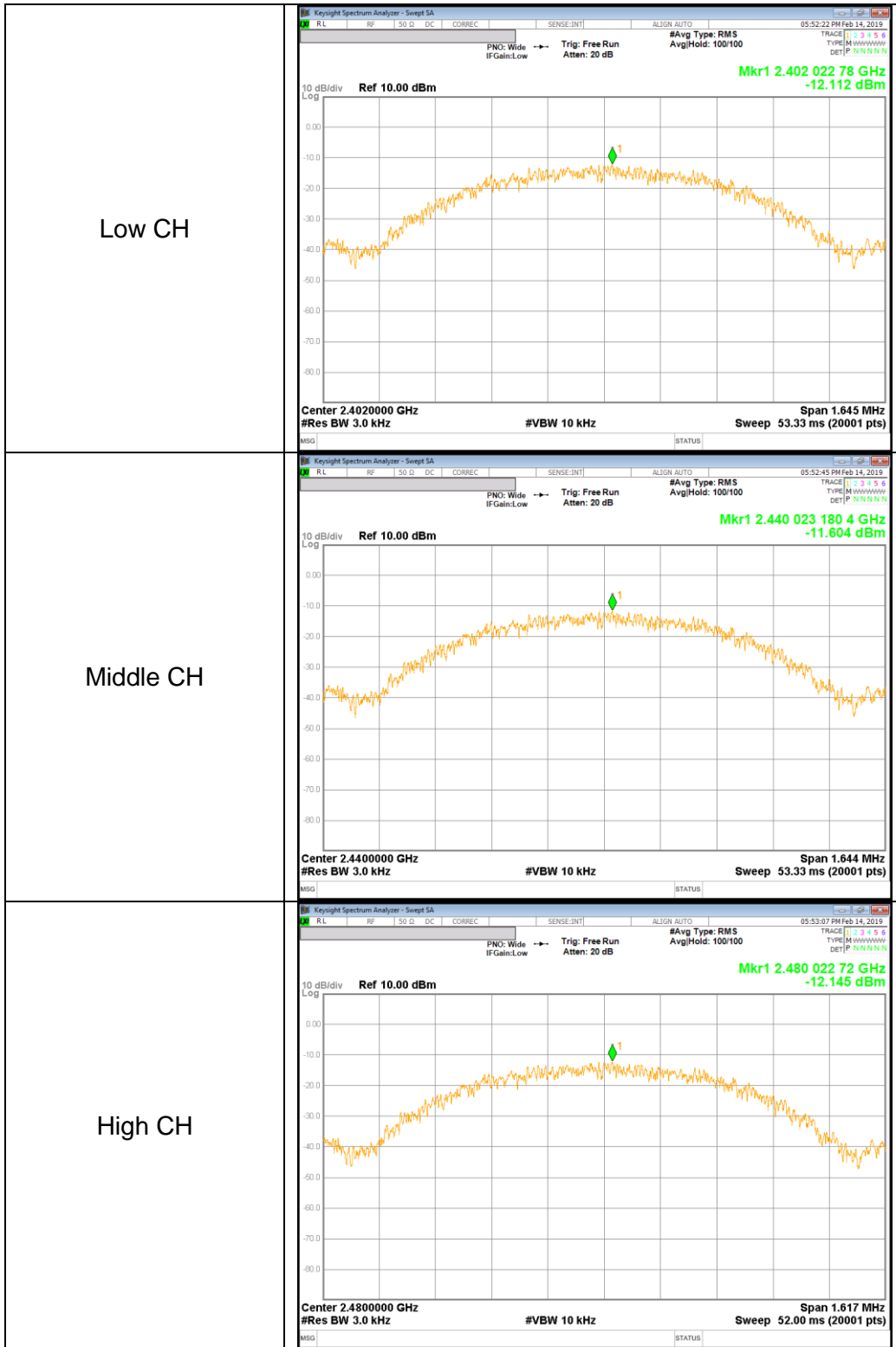

- 2Mbps

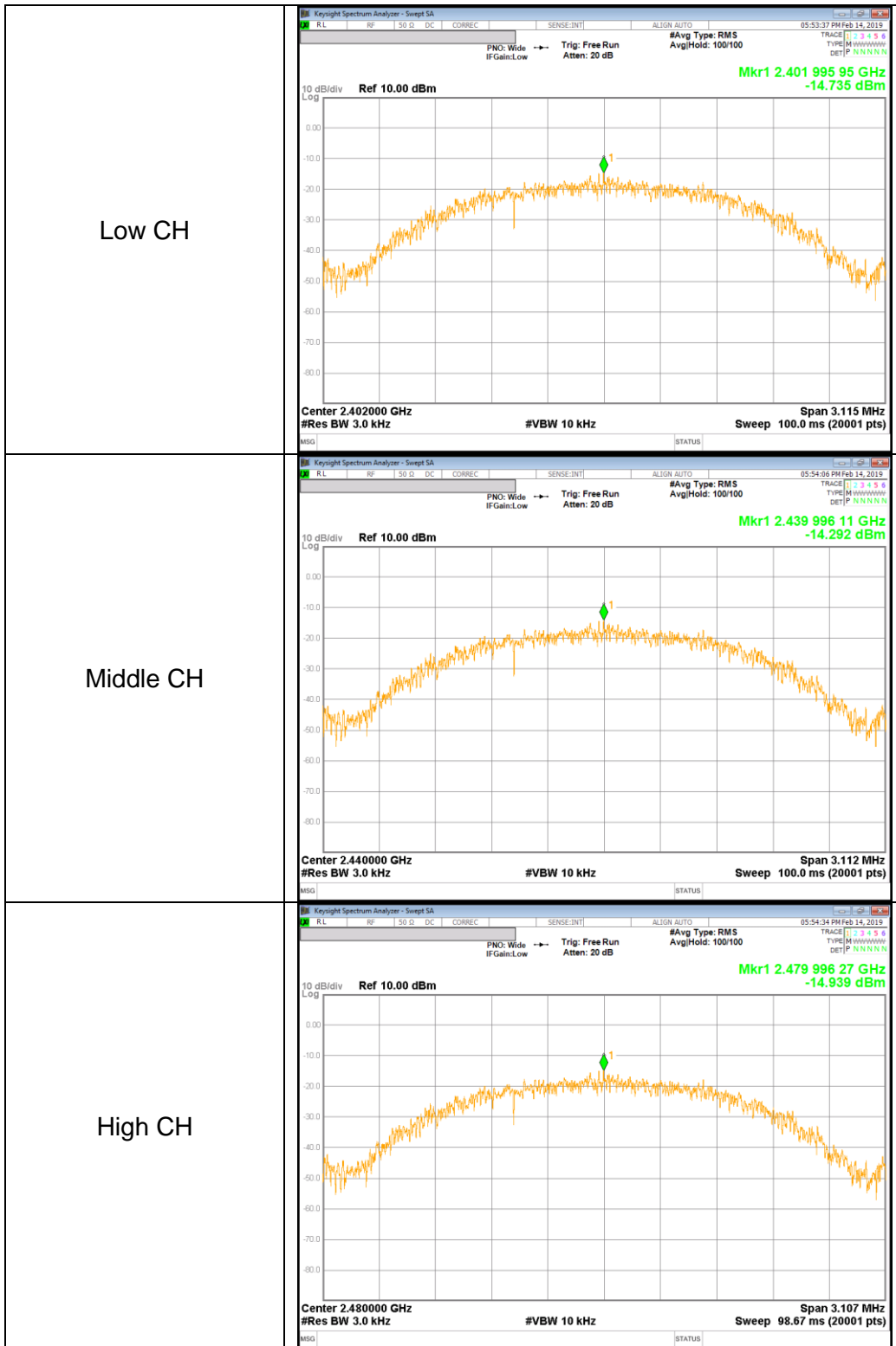

10.5. OUT-OF-BAND EMISSIONS

LIMITS

FCC §15.247 (d)

In any 100 kHz bandwidth outside the frequency band in which the spread spectrum or digitally modulated intentional radiator is operating, the radio frequency power that is produced by the intentional radiator shall be at least 20 dB below that in the 100 kHz bandwidth within the band that contains the highest level of the desired power, based on either an RF conducted or a radiated measurement, provided the transmitter demonstrates compliance with the peak conducted power limits. If the transmitter complies with the conducted power limits based on the use of RMS averaging over a time interval, as permitted under paragraph (b)(3) of this section, the attenuation required under this paragraph shall be 30 dB instead of 20 dB. Attenuation below the general limits specified in §15.209(a) is not required.

TEST PROCEDURE

The transmitter output is connected to a spectrum analyzer with RBW = 100 kHz, VBW = 300 kHz, peak detector, and max hold. Measurements utilizing these settings are made of the in-band reference level, bandedge (where measurements to the general radiated limits will not be made) and out-of-band emissions.

RESULTS

BANDEDGE & SPURIOUS EMISSIONS, LOW CHANNEL (1Mbps)

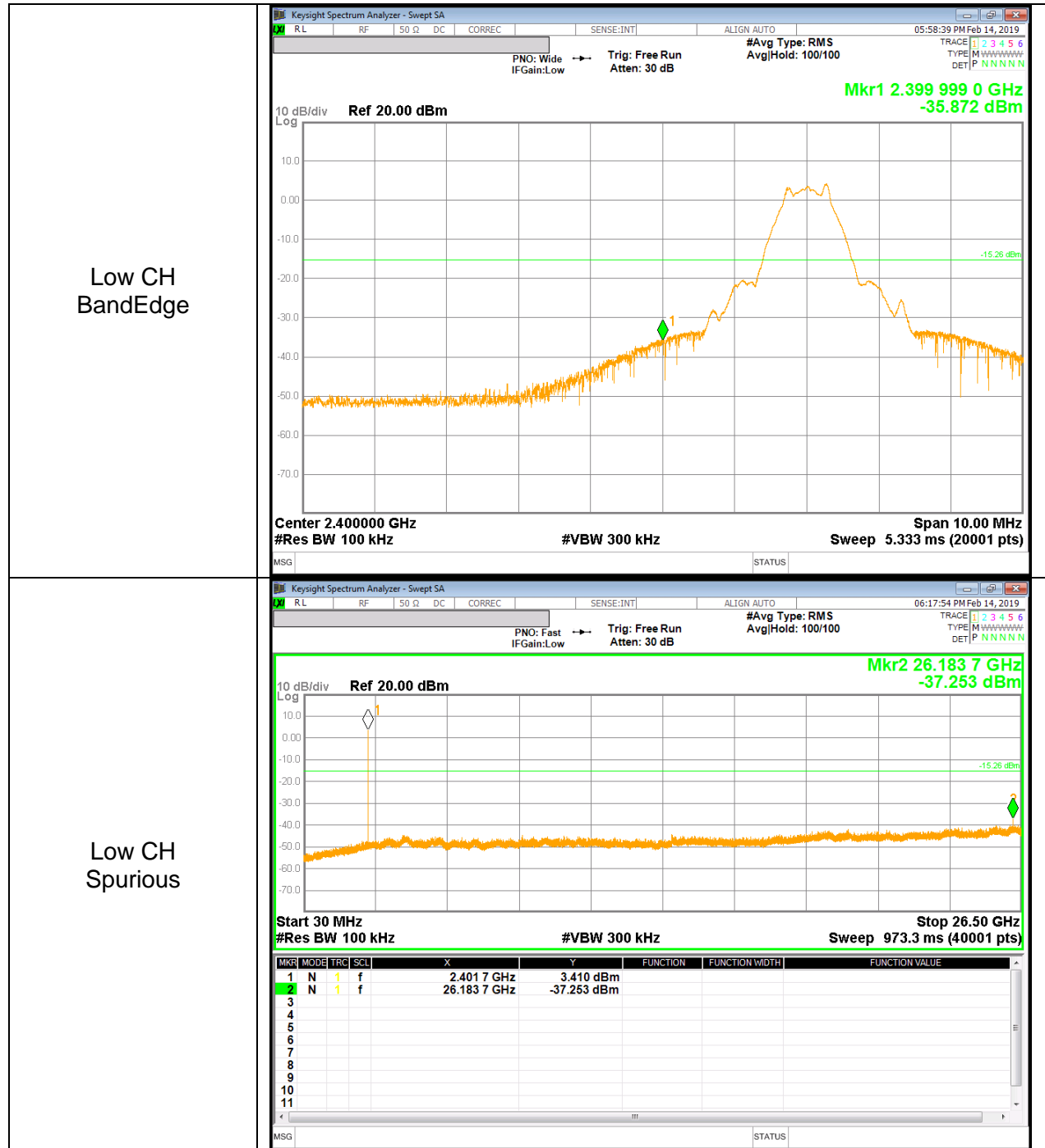

SPURIOUS EMISSIONS, MID CHANNEL (1Mbps)

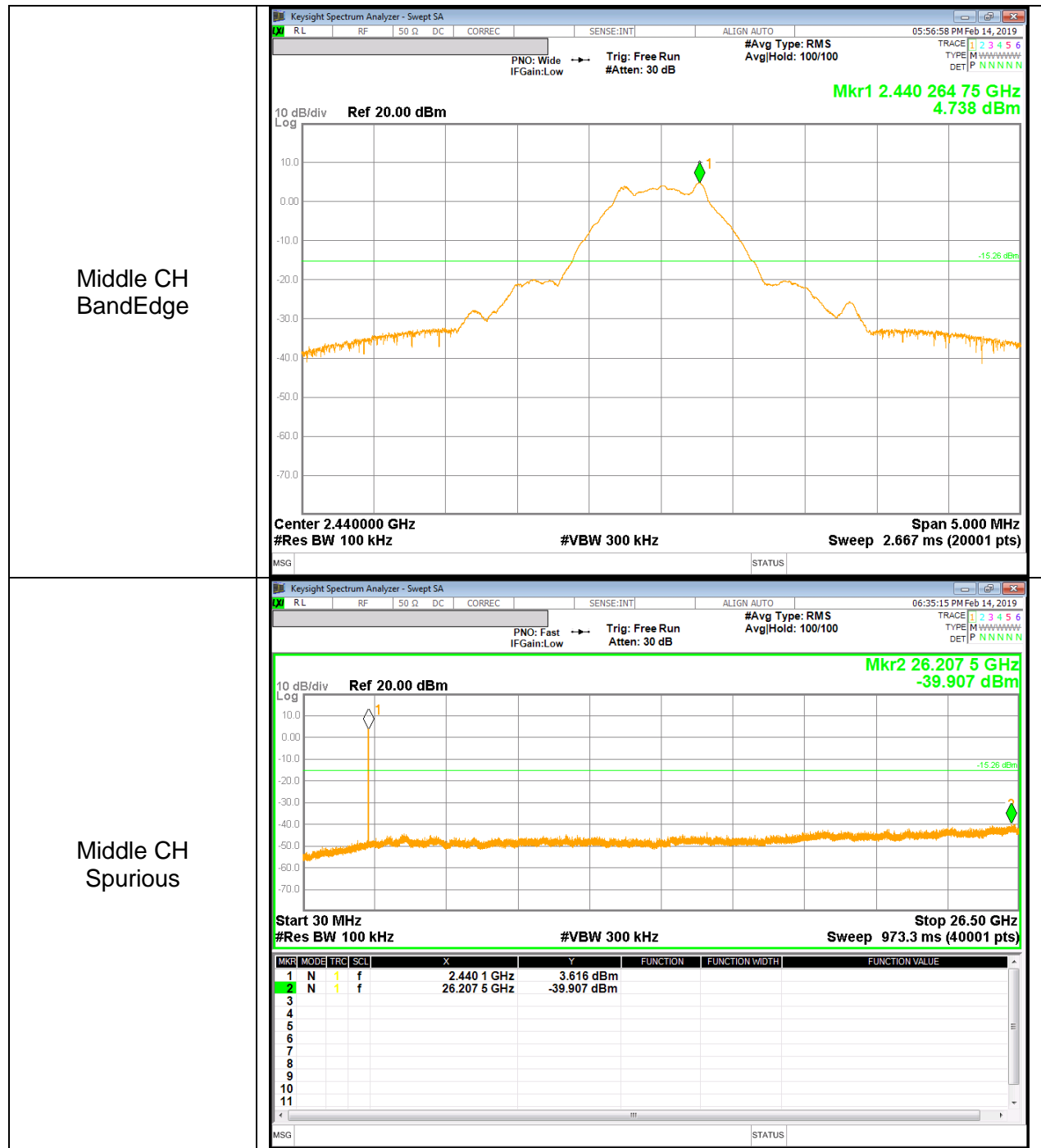

SPURIOUS EMISSIONS, HIGH CHANNEL (1Mbps)

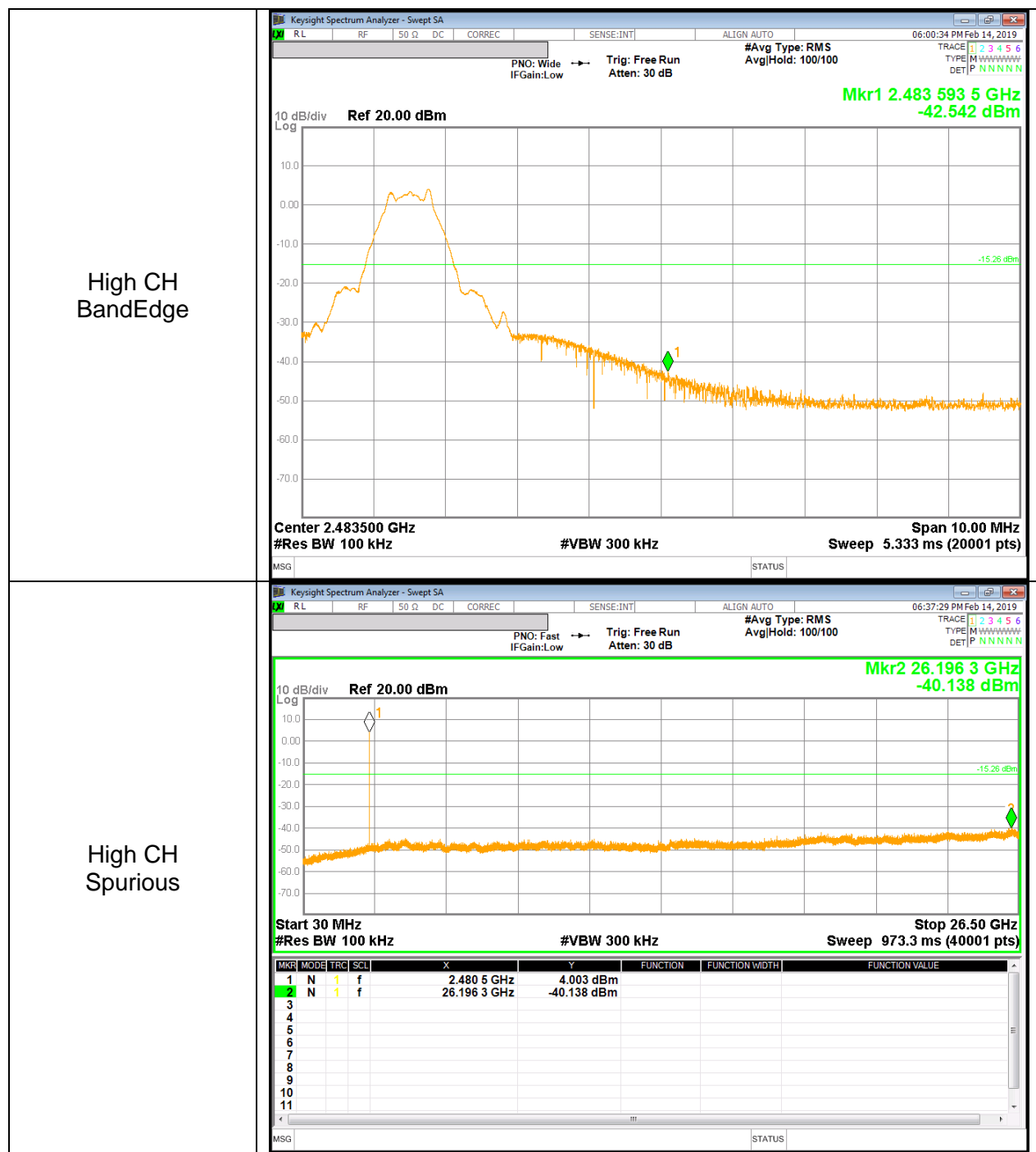

BANDEDGE & SPURIOUS EMISSIONS, LOW CHANNEL (2Mbps)

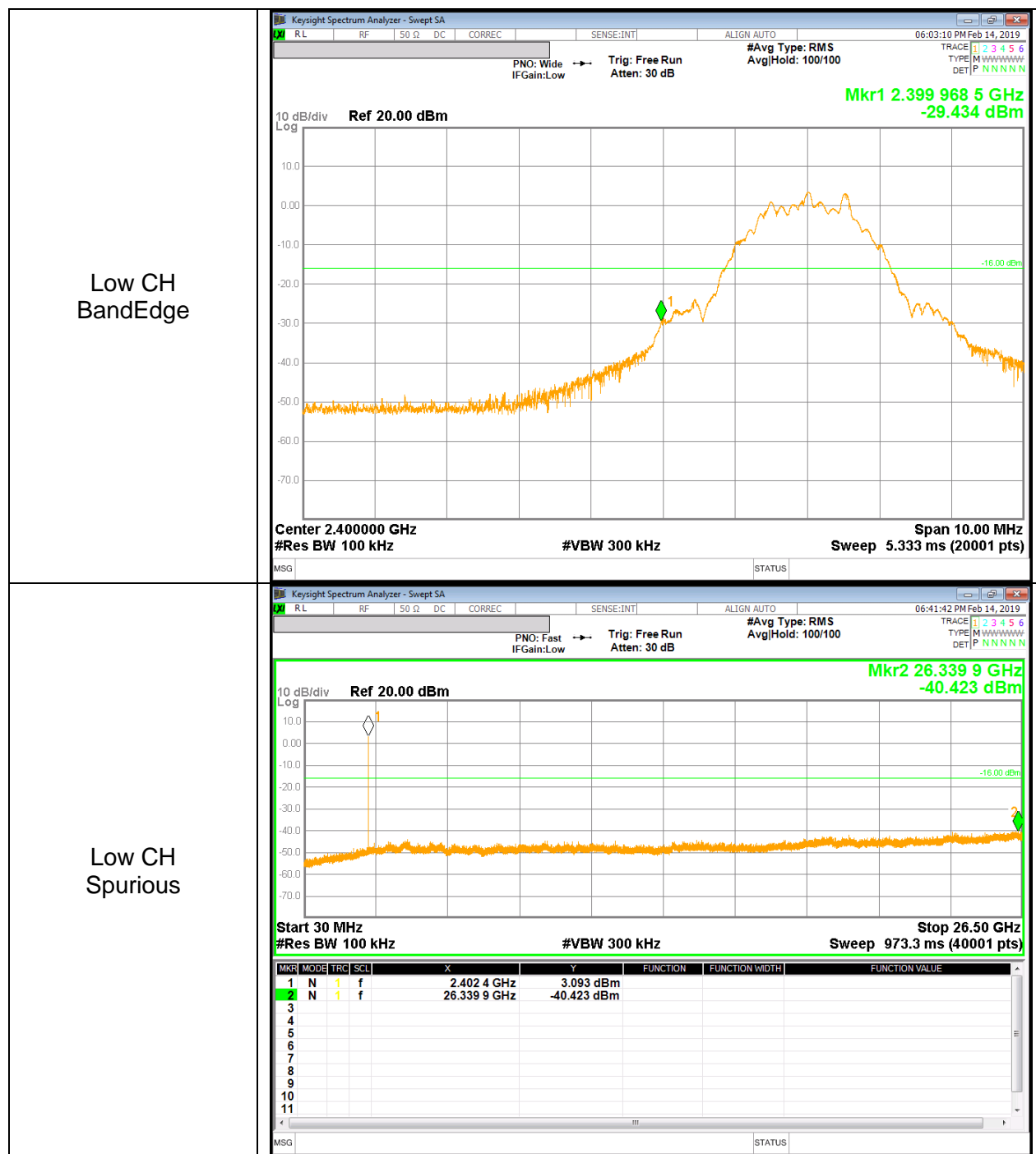

SPURIOUS EMISSIONS, MID CHANNEL (2Mbps)

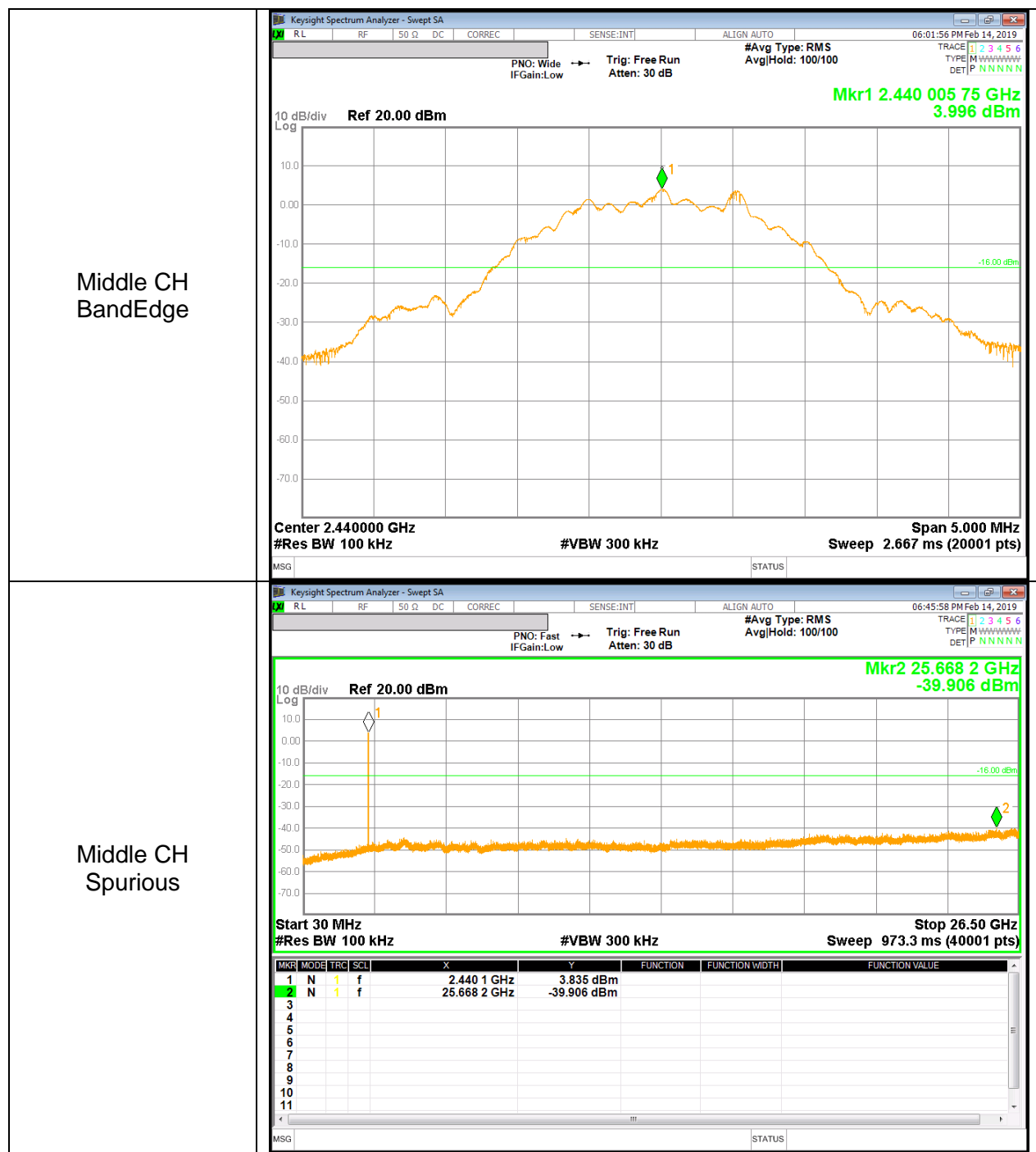

SPURIOUS EMISSIONS, HIGH CHANNEL (2Mbps)

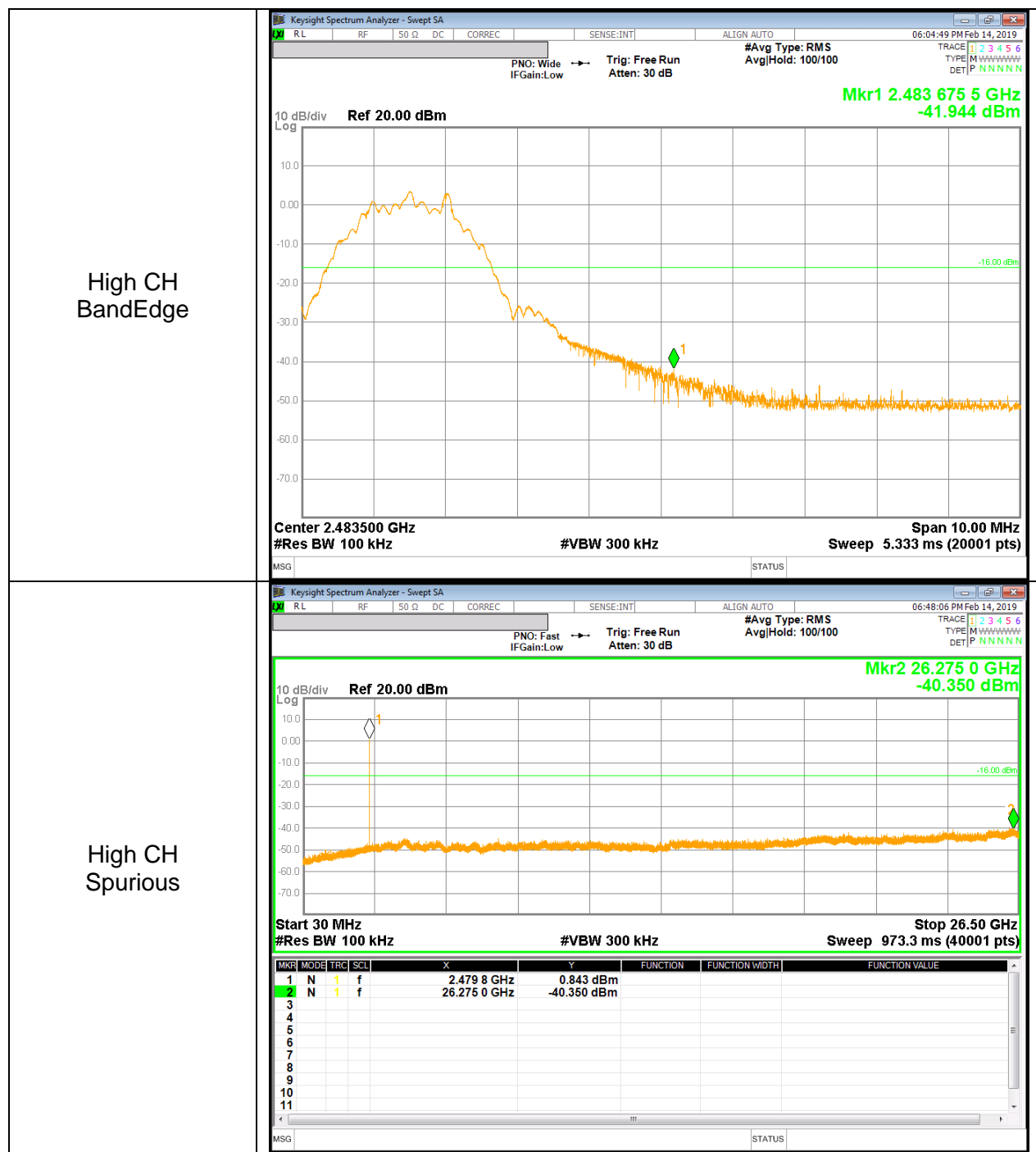

11. RADIATED TEST RESULTS

11.1. LIMITS AND PROCEDURE

LIMITS

FCC §15.205 and §15.209

Limits for radiated disturbance of an intentional radiator		
Frequency range (MHz)	Limits (µV/m)	Measurement Distance (m)
0.009 – 0.490	2400 / F (kHz)	300
0.490 – 1.705	24000 / F (kHz)	30
1.705 – 30.0	30	30
30 – 88	100**	3
88 - 216	150**	3
216 – 960	200**	3
Above 960	500	3

** Except as provided in paragraph (g), fundamental emissions from intentional radiators operating under this section shall not be located in the frequency bands 54-72 MHz, 76-88 MHz, 174-216 MHz or 470-806 MHz. However, operation within these frequency bands is permitted under other sections of this part, e.g. §§ 15.231 and 15.241.

TEST PROCEDURE

The EUT is placed on a non-conducting table 80 cm above the ground plane for below 1GHz and 150 cm for above 1GHz. The antenna to EUT distance is 3 meters. The EUT is configured in accordance with ANSI C63.10. The EUT is set to transmit in a continuous mode.

For measurements below 1 GHz the resolution bandwidth is set to 100 kHz for peak detection measurements or 120 kHz for quasi-peak detection measurements. Peak detection is used unless otherwise noted as quasi-peak.

For measurements above 1 GHz the resolution bandwidth is set to 1 MHz, then the video bandwidth is set to 3 MHz for peak measurements and add duty cycle factor for average measurements. (Restricted bandedge, Final detection of spurious harmonic emissions) Duty cycle factor = $10 \log(1/x)$. For this sample: For 1Mbps, DCF = $10 \log(1/0.851) = 0.70$ dB (Spectrum Analyzer round it up to 0.7dB) and for 2Mbps, DCF = $10 \log(1/0.571) = 2.44$ dB (Spectrum Analyzer round it up to 2.4dB)

Pre-scans to detect harmonic and spurious emissions, the resolution bandwidth is set to 1 MHz; the video bandwidth is set to 30 KHz for peak measurements.

The spectrum from 1 GHz to 26 GHz is investigated with the transmitter set to the lowest, middle, and highest channels in the 2.4 GHz band.
(From 30MHz to 1GHz, test was performed with the EUT set to transmit at the channel with highest output power)

The frequency range of interest is monitored at a fixed antenna height and EUT azimuth. The EUT is rotated through 360 degrees to maximize emissions received. The antenna is scanned from 1 to 4 meters above the ground plane to further maximize the emission. Measurements are made with the antenna polarized in both the vertical and the horizontal positions.

Note : Emission was pre-scanned from 9KHz to 30MHz; No emissions were detected which was at least 20dB below the specification limit (consider distance correction factor).
Per FCC part 15.31(o), test results were not reported.

Although these tests were performed other than open field test site, adequate comparison measurements were confirmed against 30 m open area test site.
Therefore sufficient tests were made to demonstrate that the alternative site produces results that correlate with the one of tests made in an open field based on KDB 414788.

11.2. TRANSMITTER ABOVE 1 GHz

11.2.1. 1Mbps MODE

RESTRICTED BANDEDGE (LOW CHANNEL)

HORIZONTAL PEAK AND AVERAGE PLOT

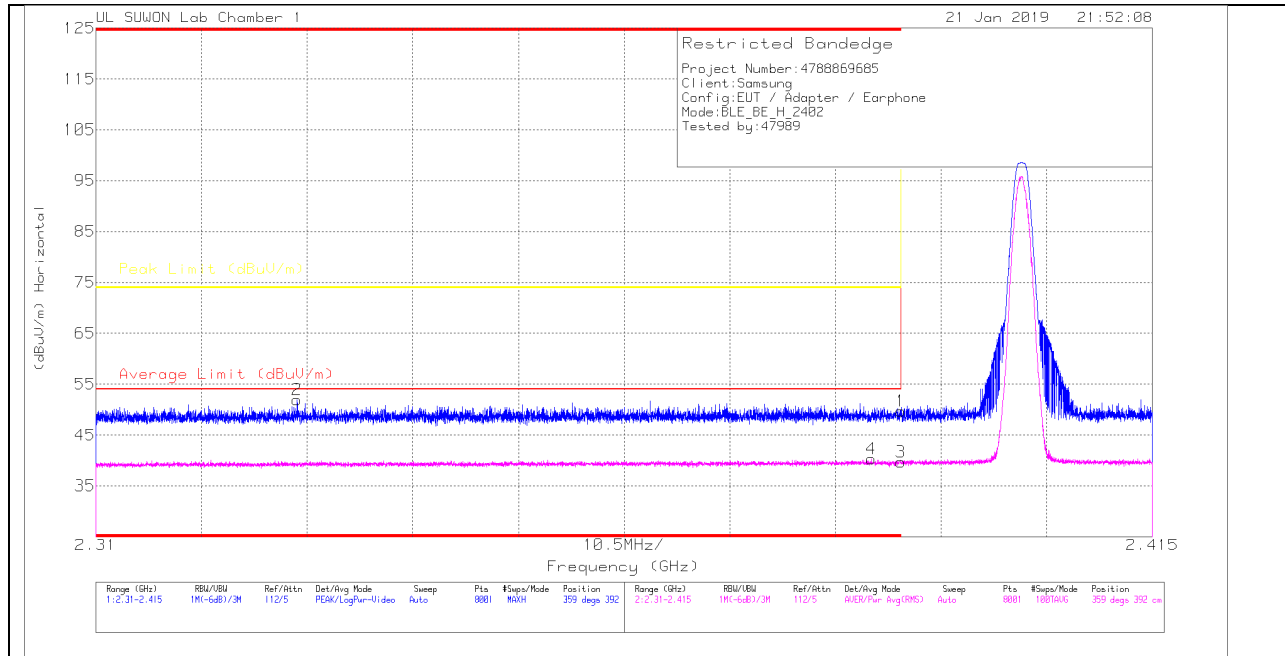

HORIZONTAL DATA

Trace Markers

Marker	Frequency (GHz)	Meter Reading (dBuV)	Det	3117_00168717	10dB(dB)	DC Corr (dB)	Corrected Reading (dBuV/m)	Average Limit (dBuV/m)	Margin (dB)	Peak Limit (dBuV/m)	PK Margin (dB)	Azimuth (Degs)	Height (cm)	Polarity
1	* 2.39	43.56	Pk	31.7	-25.5	0	49.76	-	-	74	-24.24	359	392	H
2	* 2.33	46.09	Pk	31.5	-25.7	0	51.89	-	-	74	-22.11	359	392	H
3	* 2.39	32.83	RMS	31.7	-25.5	.7	39.73	54	-14.27	-	-	359	392	H
4	* 2.387	33.37	RMS	31.7	-25.5	.7	40.27	54	-13.73	-	-	359	392	H

* - indicates frequency in CFR47 Pt 15 / IC RSS-Restricted Band

Pk - Peak detector

RMS - RMS detection

VERTICAL PEAK AND AVERAGE PLOT

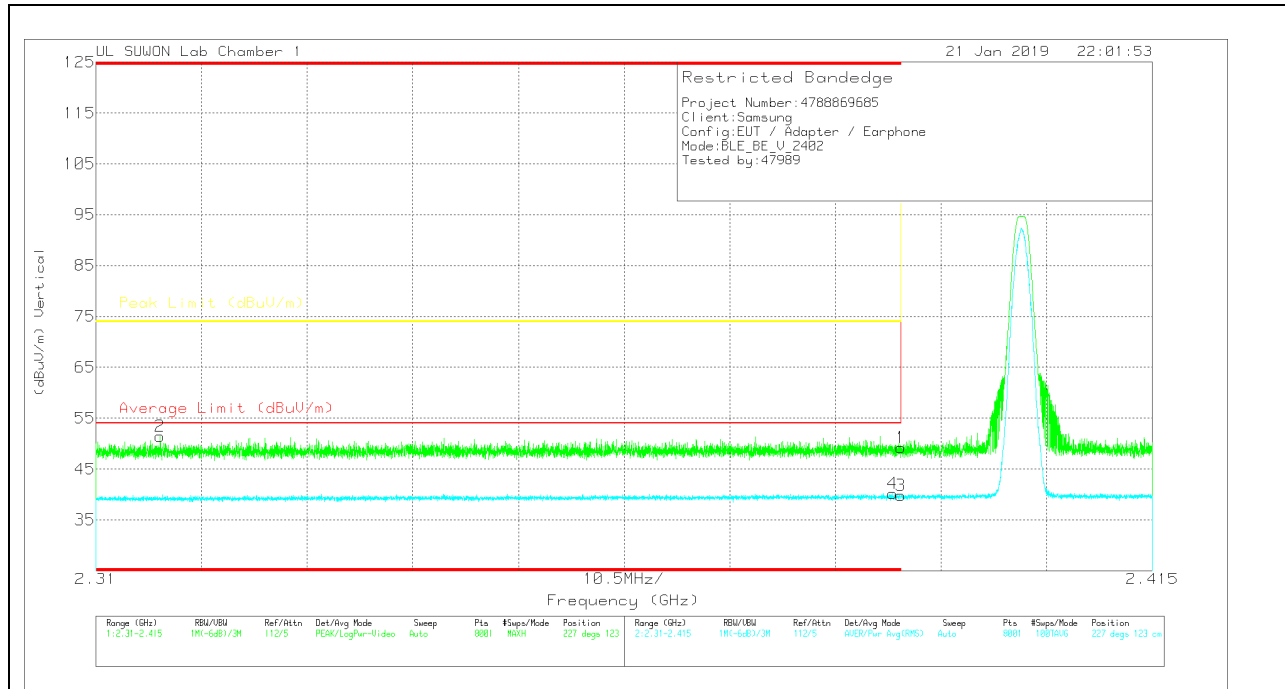

VERTICAL DATA

Trace Markers

Marker	Frequency (GHz)	Meter Reading (dBuV)	Det	3117_00168717	10dB(dB)	DC Corr (dB)	Corrected Reading (dBuV/m)	Average Limit (dBuV/m)	Margin (dB)	Peak Limit (dBuV/m)	PK Margin (dB)	Azimuth (Degs)	Height (cm)	Polarity
1	* 2.39	43.03	Pk	31.7	-25.5	0	49.23	-	-	74	-24.77	227	123	V
2	* 2.316	45.66	Pk	31.5	-25.7	0	51.46	-	-	74	-22.54	227	123	V
3	* 2.39	32.88	RMS	31.7	-25.5	.7	39.78	54	-14.22	-	-	227	123	V
4	* 2.389	33.27	RMS	31.7	-25.5	.7	40.17	54	-13.83	-	-	227	123	V

* - indicates frequency in CFR47 Pt 15 / IC RSS-Restricted Band
 Pk - Peak detector
 RMS - RMS detection

AUTHORIZED BANDEDGE (HIGH CHANNEL)

HORIZONTAL PEAK AND AVERAGE PLOT

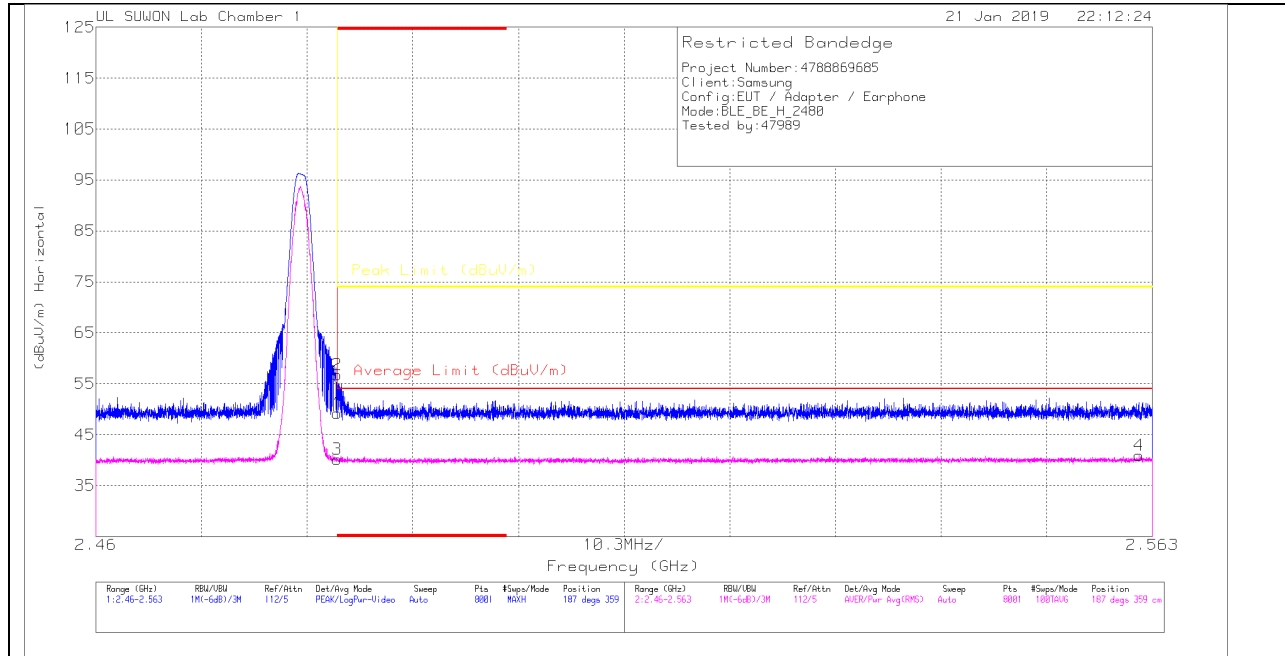

HORIZONTAL DATA

Trace Markers

Marker	Frequency (GHz)	Meter Reading (dBuV)	Det	3117_00168717	10dB(dB)	DC Corr (dB)	Corrected Reading (dBuV/m)	Average Limit (dBuV/m)	Margin (dB)	Peak Limit (dBuV/m)	PK Margin (dB)	Asimuth (Degs)	Height (cm)	Polarity
1	* 2.484	42.64	Pk	31.9	-25.3	0	49.24	-	-	74	-24.76	187	359	H
2	* 2.484	50.16	Pk	31.9	-25.3	0	56.76	-	-	74	-17.24	187	359	H
3	* 2.484	32.93	RMS	31.9	-25.3	.7	40.23	54	-13.77	-	-	187	359	H
4	2.562	33.3	RMS	32	-25.1	.7	40.9	54	-13.1	-	-	187	359	H

* - indicates frequency in CFR47 Pt 15 / IC RSS-Restricted Band

Pk - Peak detector

RMS - RMS detection

VERTICAL PEAK AND AVERAGE PLOT

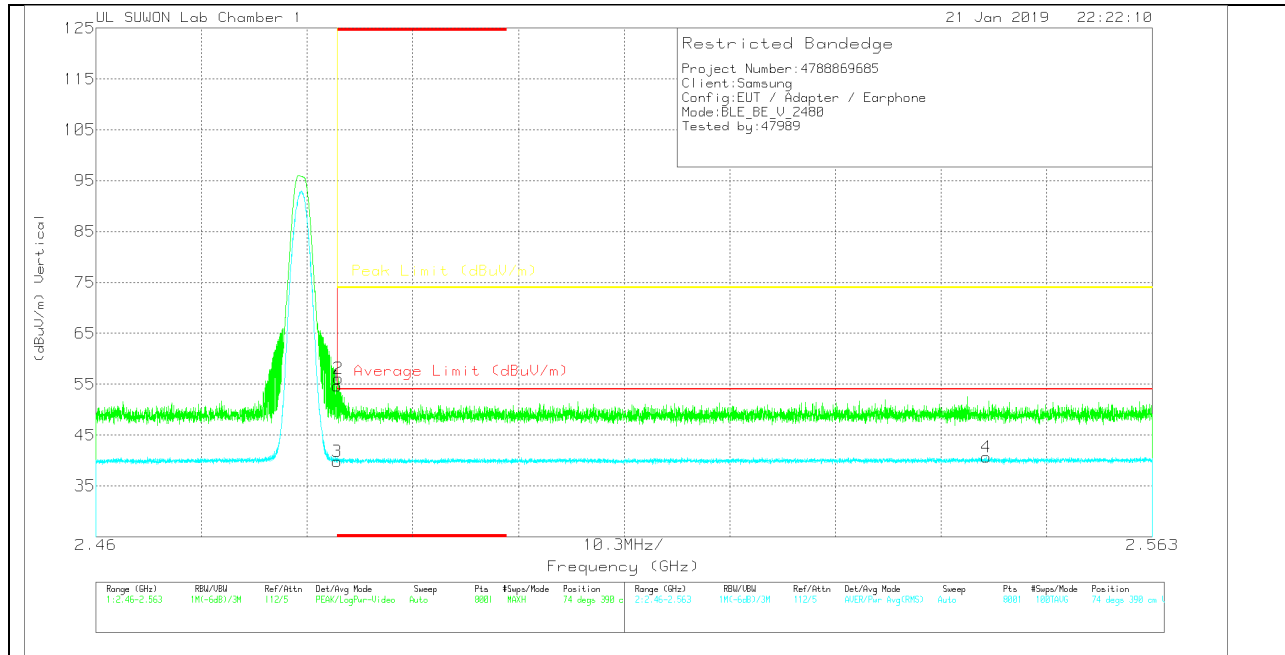

VERTICAL DATA

Trace Markers

Marker	Frequency (GHz)	Meter Reading (dBuV)	Det	3117_00168717	10dB[dB]	DC Corr (dB)	Corrected Reading (dBuV/m)	Average Limit (dBuV/m)	Margin (dB)	Peak Limit (dBuV/m)	PK Margin (dB)	Azimuth (Degs)	Height (cm)	Polarity
1	* 2.484	48.04	Pk	31.9	-25.3	0	54.64	-	-	74	-19.36	74	390	V
2	* 2.484	49.56	Pk	31.9	-25.3	0	56.16	-	-	74	-17.84	74	390	V
3	* 2.484	32.57	RMS	31.9	-25.3	.7	39.87	54	-14.13	-	-	74	390	V
4	2.547	33.09	RMS	32	-25.1	.7	40.69	54	-13.31	-	-	74	390	V

* - indicates frequency in CFR47 Pt 15 / IC RSS-Restricted Band

Pk - Peak detector

RMS - RMS detection

HARMONICS AND SPURIOUS EMISSIONS

LOW CHANNEL HORIZONTAL

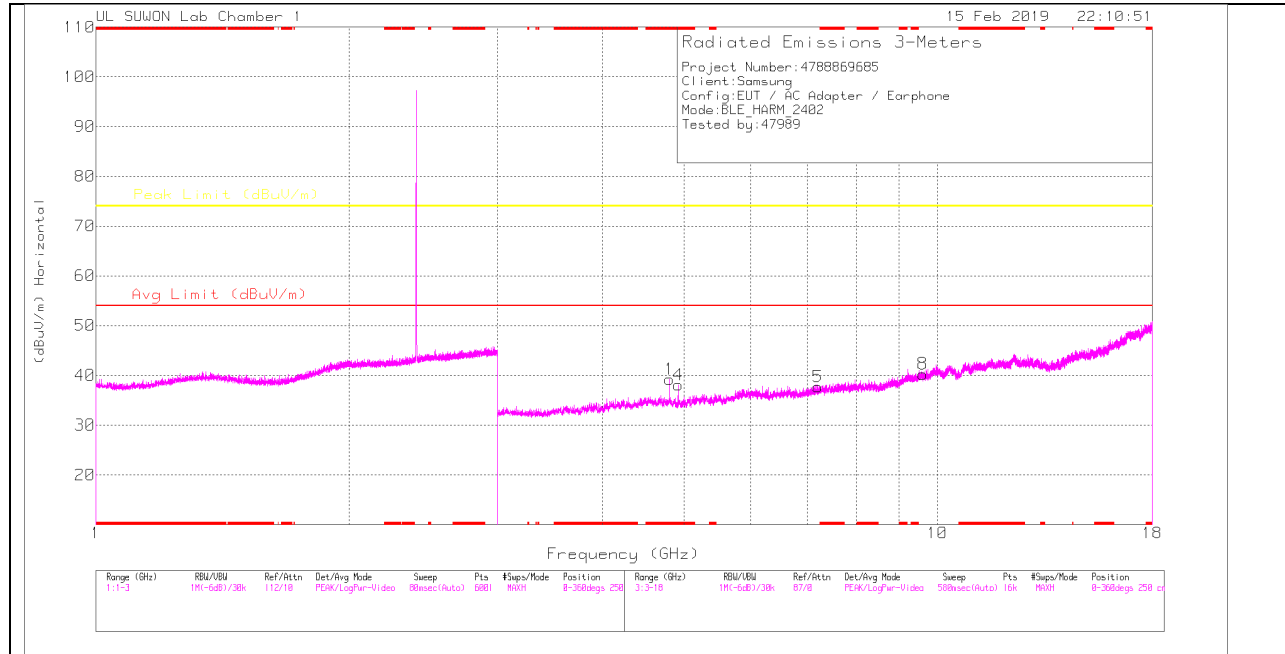

LOW CHANNEL VERTICAL

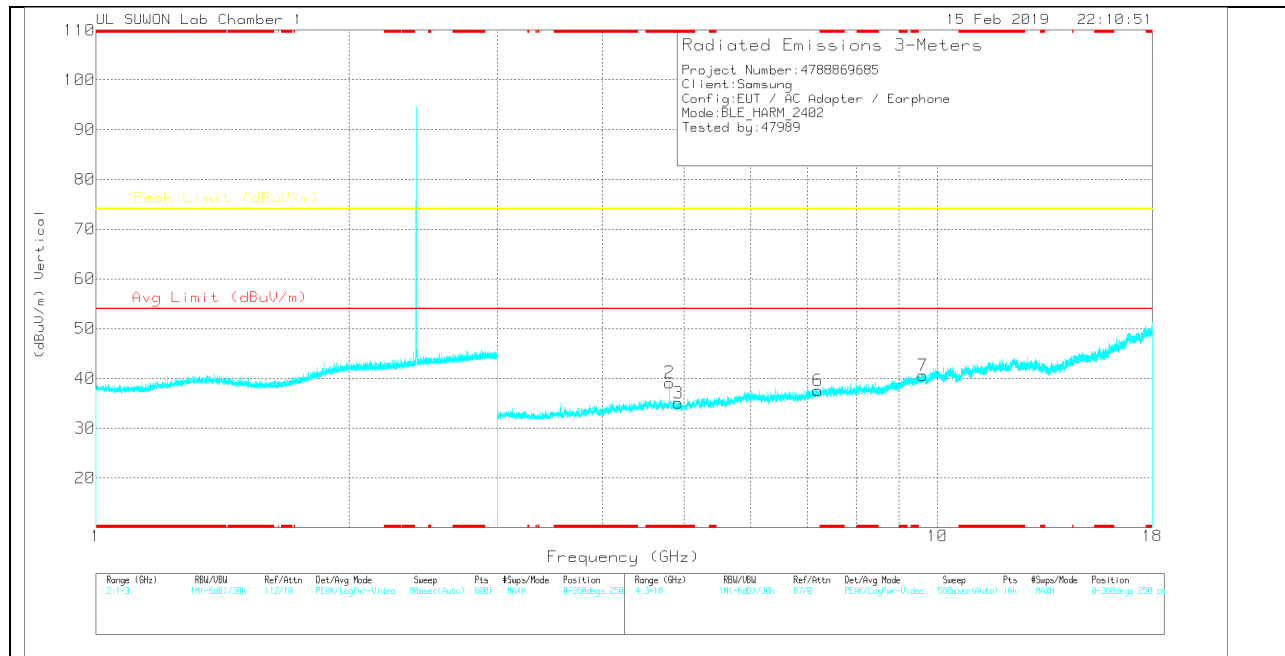

Note: Emission was scanned up to 26GHz; No emissions were detected above the noise floor which was at least 20dB below the specification limit.

LOW CHANNEL DATA

Trace Markers

Marker	Frequency (GHz)	Meter Reading (dBuV)	Det	3117_00168717	3GHz_HP[dB]	DC Corr (dB)	Corrected Reading (dBuV/m)	Avg Limit (dBuV/m)	Margin (dB)	Peak Limit (dBuV/m)	Margin (dB)	Azimuth (Degs)	Height (cm)	Polarity
1	* 4.804	36.47	PK	34.2	-31.4	0	39.27	-	-	74	-34.73	0-360	250	H
4	* 4.919	35.48	PK	34.2	-31.6	0	38.08	-	-	74	-35.92	0-360	150	H
5	7.205	29.79	PK	35.8	-27.9	0	37.69	-	-	74	-36.31	0-360	150	H
8	9.61	26.4	PK	37	-23.1	0	40.3	-	-	74	-33.7	0-360	250	H
2	* 4.804	36.36	PK	34.2	-31.4	0	39.16	-	-	74	-34.84	0-360	150	V
3	* 4.918	32.3	PK	34.2	-31.5	0	35	-	-	74	-39	0-360	250	V
6	7.205	29.67	PK	35.8	-27.9	0	37.57	-	-	74	-36.43	0-360	150	V
7	9.608	26.76	PK	37	-23.1	0	40.66	-	-	74	-33.34	0-360	150	V

* - indicates frequency in CFR47 Pt 15 / IC RSS-Restricted Band

PK – Peak detector

Radiated Emissions

Frequency (GHz)	Meter Reading (dBuV)	Det	3117_00168717	3GHz_HP[dB]	DC Corr (dB)	Corrected Reading (dBuV/m)	Avg Limit (dBuV/m)	Margin (dB)	Peak Limit (dBuV/m)	Margin (dB)	Azimuth (Degs)	Height (cm)	Polarity
* 4.922	38.6	PK2	34.2	-31.6	0	41.2	-	-	74	-32.8	151	162	V
* 4.928	29.32	MAv1	34.2	-31.5	.7	32.72	54	-21.28	-	-	151	162	V
* 4.922	41.41	PK2	34.2	-31.6	0	44.01	-	-	74	-29.99	300	127	H
* 4.925	29.18	MAv1	34.2	-31.6	.7	32.48	54	-21.52	-	-	300	127	H
* 4.804	44.25	PK2	34.2	-31.4	0	47.05	-	-	74	-26.95	161	247	H
* 4.804	35.23	MAv1	34.2	-31.4	.7	38.73	54	-15.27	-	-	161	247	H
* 4.804	43.69	PK2	34.2	-31.4	0	46.49	-	-	74	-27.51	211	147	V
* 4.804	33.66	MAv1	34.2	-31.4	.7	37.16	54	-16.84	-	-	211	147	V

* - indicates frequency in CFR47 Pt 15 / IC RSS-Restricted Band

PK2 - KDB558074 Method: Maximum Peak

MAv1 - KDB558074 Option 1 Maximum RMS Average

MID CHANNEL HORIZONTAL

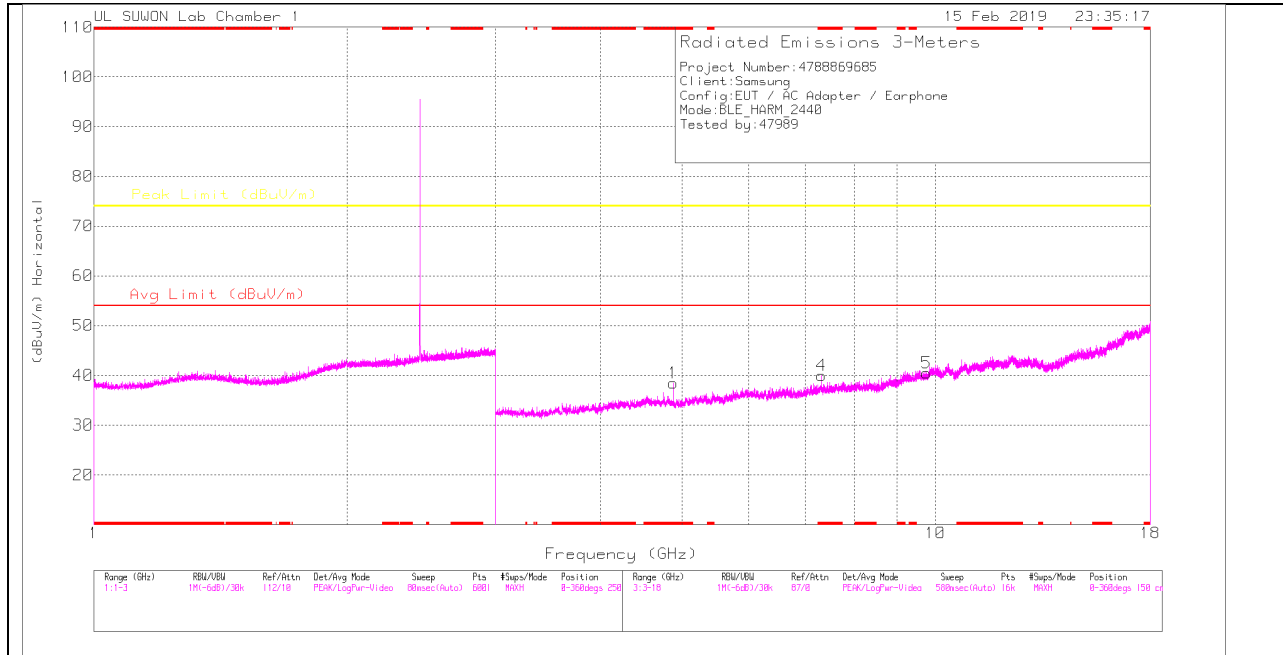

MID CHANNEL VERTICAL

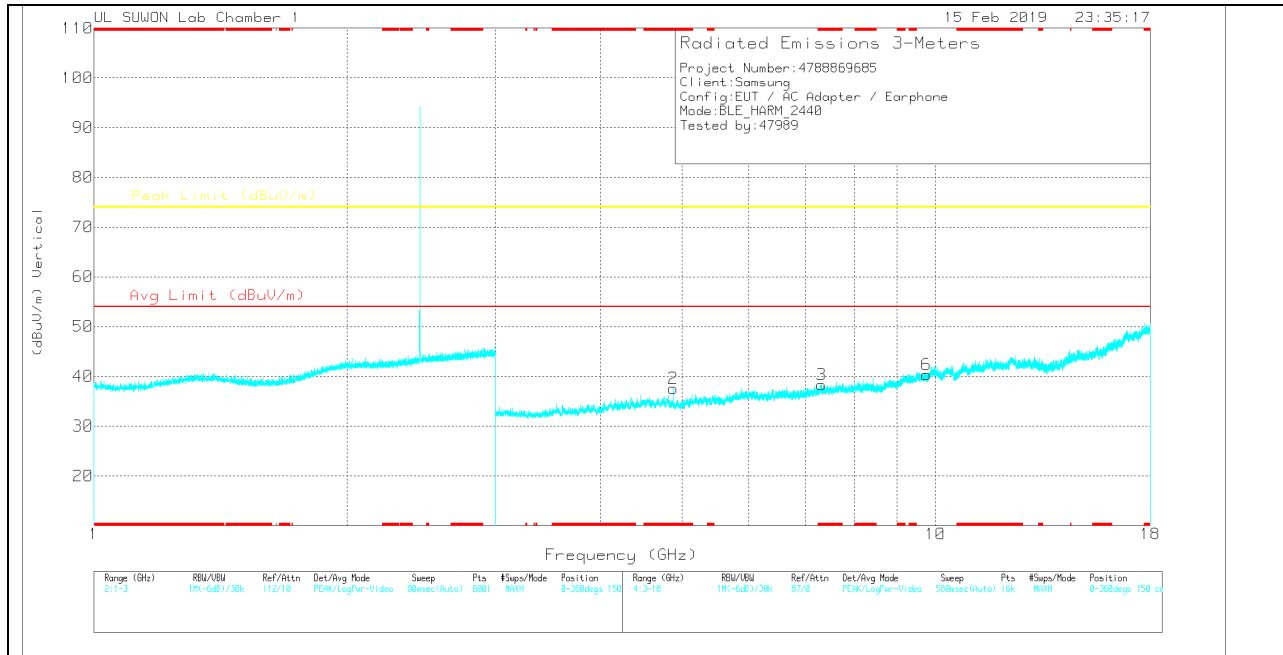

Note: Emission was scanned up to 26GHz; No emissions were detected above the noise floor which was at least 20dB below the specification limit.

MID CHANNEL DATA

Trace Markers

Marker	Frequency (GHz)	Meter Reading (dBuV)	Det	3117_00168717	3GHz_HP[dB]	DC Corr (dB)	Corrected Reading (dBuV/m)	Avg Limit (dBuV/m)	Margin (dB)	Peak Limit (dBuV/m)	Margin (dB)	Azimuth (Degs)	Height (cm)	Polarity
1	* 4.88	35.74	PK	34.2	-31.5	0	38.44	-	-	74	-35.56	0-360	150	H
4	* 7.32	31.43	PK	35.8	-27.3	0	39.93	-	-	74	-34.07	0-360	150	H
5	9.76	27.18	PK	37.2	-23.9	0	40.48	-	-	74	-33.52	0-360	250	H
2	* 4.88	34.83	PK	34.2	-31.5	0	37.53	-	-	74	-36.47	0-360	150	V
3	* 7.32	29.83	PK	35.8	-27.3	0	38.33	-	-	74	-35.67	0-360	250	V
6	9.761	27.12	PK	37.2	-23.9	0	40.42	-	-	74	-33.58	0-360	250	V

* - indicates frequency in CFR47 Pt 15 / IC RSS-Restricted Band

PK – Peak detector

Radiated Emissions

Frequency (GHz)	Meter Reading (dBuV)	Det	3117_00168717	3GHz_HP[dB]	DC Corr (dB)	Corrected Reading (dBuV/m)	Avg Limit (dBuV/m)	Margin (dB)	Peak Limit (dBuV/m)	Margin (dB)	Azimuth (Degs)	Height (cm)	Polarity
* 4.88	43.75	PK2	34.2	-31.5	0	46.45	-	-	74	-27.55	137	124	H
* 4.88	35.64	MAv1	34.2	-31.5	.7	39.04	54	-14.96	-	-	137	124	H
* 4.88	43.14	PK2	34.2	-31.5	0	45.84	-	-	74	-28.16	192	185	V
* 4.88	33.93	MAv1	34.2	-31.5	.7	37.33	54	-16.67	-	-	192	185	V
* 7.319	41.29	PK2	35.8	-27.3	0	49.79	-	-	74	-24.21	167	121	H
* 7.319	30.54	MAv1	35.8	-27.3	.7	39.74	54	-14.26	-	-	167	121	H
* 7.32	39.45	PK2	35.8	-27.3	0	47.95	-	-	74	-26.05	129	109	V
* 7.32	27.76	MAv1	35.8	-27.3	.7	36.96	54	-17.04	-	-	129	109	V

* - indicates frequency in CFR47 Pt 15 / IC RSS-Restricted Band

PK2 - KDB558074 Method: Maximum Peak

MAv1 - KDB558074 Option 1 Maximum RMS Average

HIGH CHANNEL HORIZONTAL

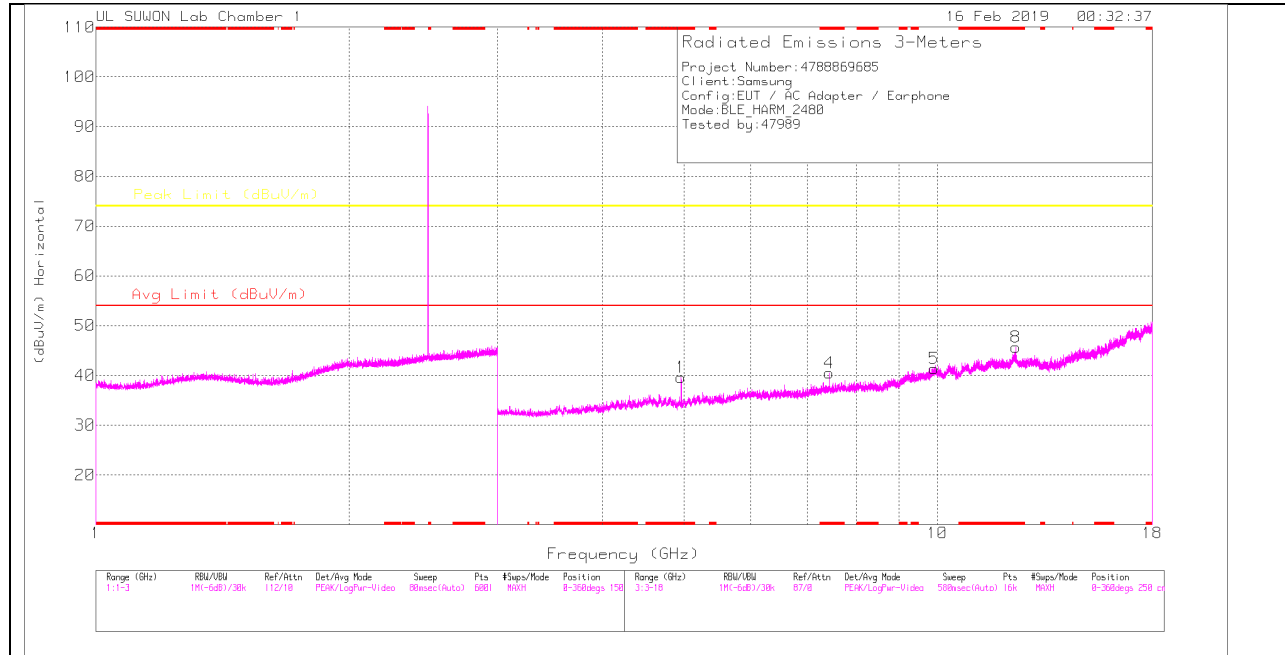

HIGH CHANNEL VERTICAL

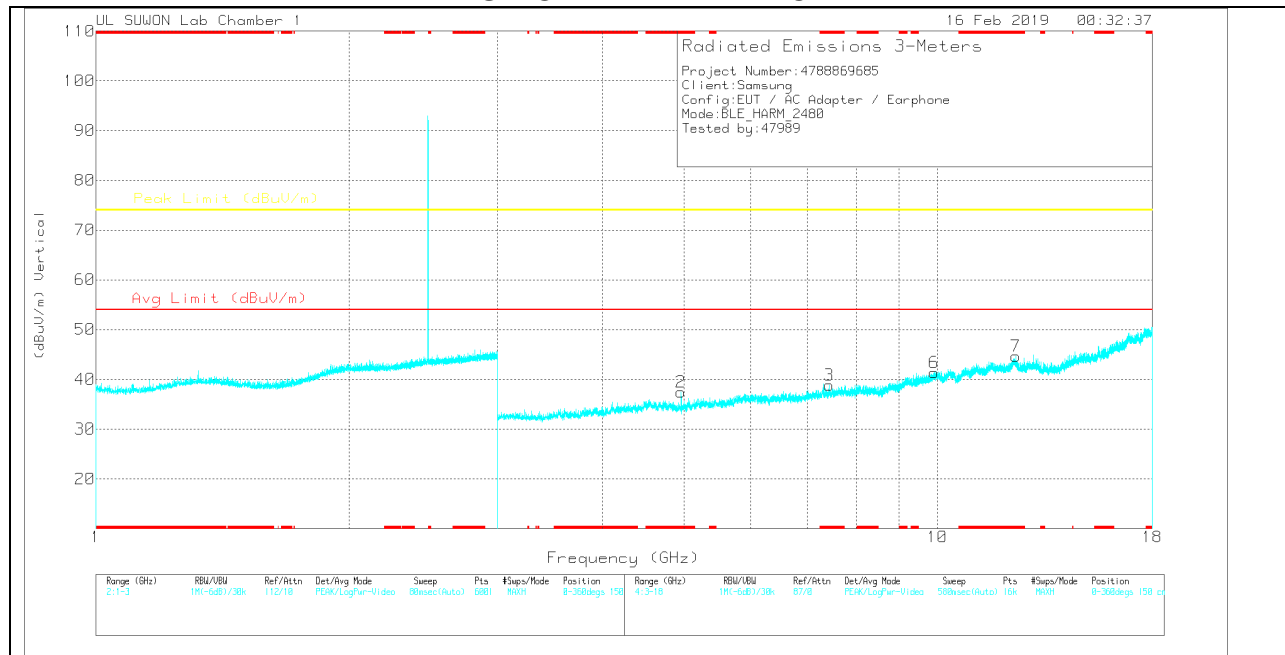

Note: Emission was scanned up to 26GHz; No emissions were detected above the noise floor which was at least 20dB below the specification limit.

HIGH CHANNEL DATA

Trace Markers

Marker	Frequency (GHz)	Meter Reading (dBuV)	Det	3117_00168717	3GHz_HP[dB]	DC Corr (dB)	Corrected Reading (dBuV/m)	Avg Limit (dBuV/m)	Margin (dB)	Peak Limit (dBuV/m)	Margin (dB)	Azimuth (Degs)	Height (cm)	Polarity
1	* 4.959	36.75	PK	34.2	-31.4	0	39.55	-	-	74	-34.45	0-360	150	H
4	* 7.439	31.74	PK	35.8	-27	0	40.54	-	-	74	-33.46	0-360	150	H
5	9.909	26.4	PK	37.4	-22.4	0	41.4	-	-	74	-32.6	0-360	150	H
8	* 12.399	27.79	PK	38.9	-21	0	45.69	-	-	74	-28.31	0-360	250	H
2	* 4.959	34.62	PK	34.2	-31.4	0	37.42	-	-	74	-36.58	0-360	150	V
3	* 7.44	30.01	PK	35.8	-27	0	38.81	-	-	74	-35.19	0-360	250	V
6	9.916	26.17	PK	37.5	-22.3	0	41.37	-	-	74	-32.63	0-360	250	V
7	* 12.399	26.72	PK	38.9	-21	0	44.62	-	-	74	-29.38	0-360	150	V

* - indicates frequency in CFR47 Pt 15 / IC RSS-Restricted Band

PK – Peak detector

Radiated Emissions

Frequency (GHz)	Meter Reading (dBuV)	Det	3117_00168717	3GHz_HP[dB]	DC Corr (dB)	Corrected Reading (dBuV/m)	Avg Limit (dBuV/m)	Margin (dB)	Peak Limit (dBuV/m)	Margin (dB)	Azimuth (Degs)	Height (cm)	Polarity
* 4.96	44.12	PK2	34.2	-31.4	0	46.92	-	-	74	-27.08	139	125	H
* 4.96	35.91	MAv1	34.2	-31.4	.7	39.41	54	-14.59	-	-	139	125	H
* 4.96	42.69	PK2	34.2	-31.4	0	45.49	-	-	74	-28.51	191	179	V
* 4.96	33.37	MAv1	34.2	-31.4	.7	36.87	54	-17.13	-	-	191	179	V
* 7.44	41.04	PK2	35.8	-27	0	49.84	-	-	74	-24.16	163	105	H
* 7.439	30.52	MAv1	35.8	-27	.7	40.02	54	-13.98	-	-	163	105	H
* 7.441	38.84	PK2	35.8	-27	0	47.64	-	-	74	-26.36	138	264	V
* 7.439	27.05	MAv1	35.8	-27	.7	36.55	54	-17.45	-	-	138	264	V
* 12.4	36.1	PK2	38.8	-21	0	53.9	-	-	74	-20.1	133	104	V
* 12.4	25.11	MAv1	38.9	-21	.7	43.71	54	-10.29	-	-	133	104	V
* 12.4	35.76	PK2	38.9	-21	0	53.66	-	-	74	-20.34	167	241	H
* 12.4	24.59	MAv1	38.9	-21	.7	43.19	54	-10.81	-	-	167	241	H

* - indicates frequency in CFR47 Pt 15 / IC RSS-Restricted Band

PK2 - KDB558074 Method: Maximum Peak

MAv1 - KDB558074 Option 1 Maximum RMS Average

11.2.2. 2Mbps MODE

RESTRICTED BANDEDGE (LOW CHANNEL)

HORIZONTAL PEAK AND AVERAGE PLOT

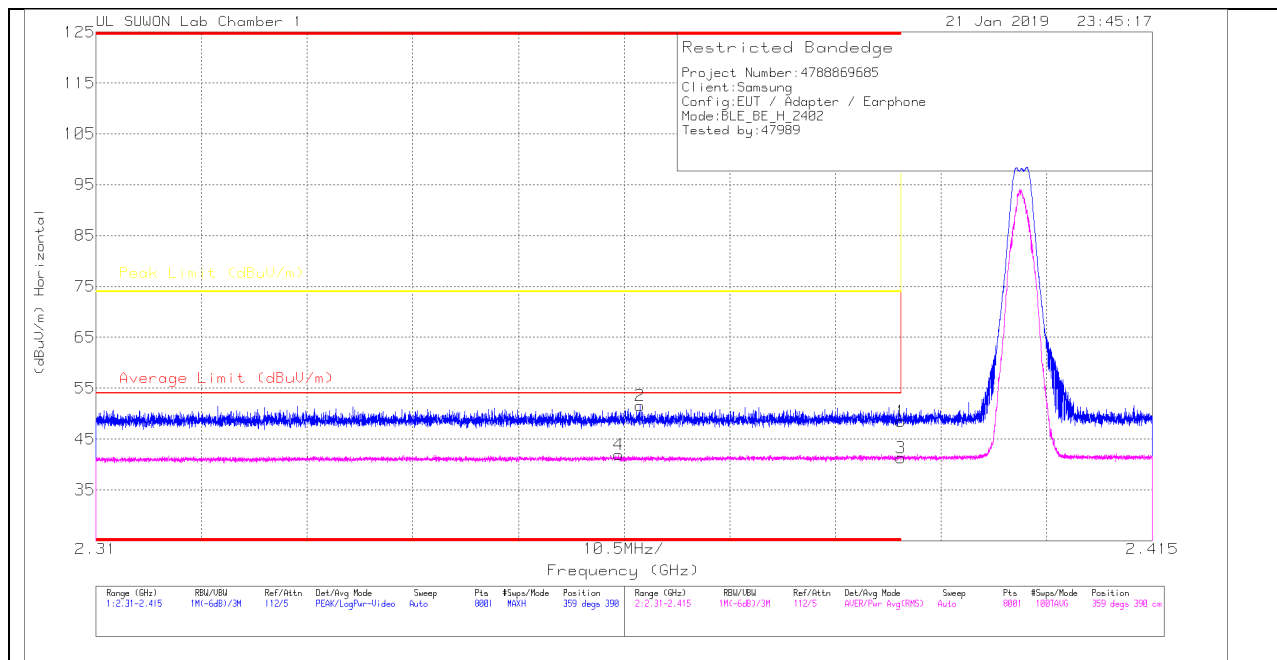

HORIZONTAL DATA

Trace Markers

Marker	Frequency (GHz)	Meter Reading (dBuV)	Det	3117_00168717	10dB(dB)	DC Corr (dB)	Corrected Reading (dBuV/m)	Average Limit (dBuV/m)	Margin (dB)	Peak Limit (dBuV/m)	PK Margin (dB)	Azimuth (Degs)	Height (cm)	Polarity
1	* 2.39	42.26	Pk	31.7	-25.5	0	48.46	-	-	74	-25.54	359	390	H
2	* 2.364	45.62	Pk	31.6	-25.7	0	51.52	-	-	74	-22.48	359	390	H
3	* 2.39	32.63	RMS	31.7	-25.5	2.44	41.27	54	-12.73	-	-	359	390	H
4	* 2.362	33.46	RMS	31.6	-25.6	2.44	41.9	54	-12.1	-	-	359	390	H

* - indicates frequency in CFR47 Pt 15 / IC RSS-Restricted Band

Pk - Peak detector

RMS - RMS detection

VERTICAL PEAK AND AVERAGE PLOT

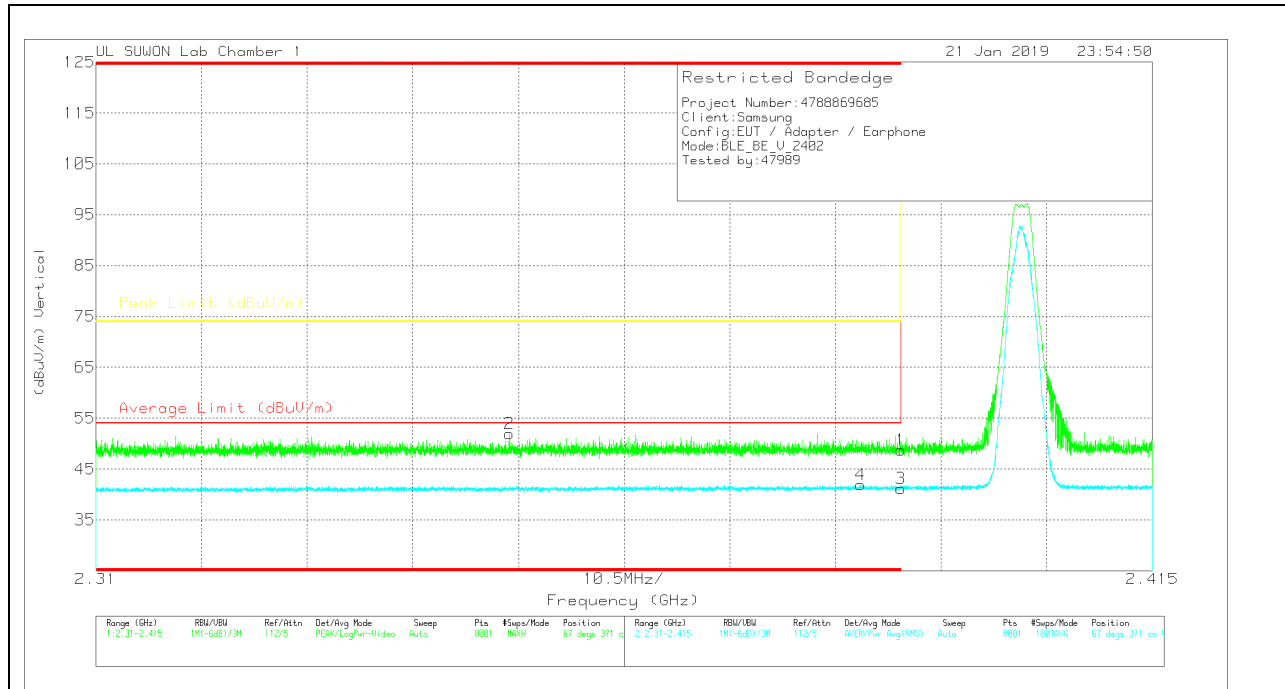

VERTICAL DATA

Trace Markers

Marker	Frequency (GHz)	Meter Reading (dBuV)	Det	3117_00168717	10dB(dB)	DC Corr (dB)	Corrected Reading (dBuV/m)	Average Limit (dBuV/m)	Margin (dB)	Peak Limit (dBuV/m)	PK Margin (dB)	Azimuth (Degs)	Height (cm)	Polarity
1	* 2.39	42.53	Pk	31.7	-25.5	0	48.73	-	-	74	-25.27	67	371	V
2	* 2.351	46.09	Pk	31.6	-25.7	0	51.99	-	-	74	-22.01	67	371	V
3	* 2.39	32.5	RMS	31.7	-25.5	2.44	41.14	54	-12.86	-	-	67	371	V
4	* 2.386	33.23	RMS	31.7	-25.5	2.44	41.87	54	-12.13	-	-	67	371	V

* - indicates frequency in CFR47 Pt 15 / IC RSS-Restricted Band
 Pk - Peak detector
 RMS - RMS detection

AUTHORIZED BANDEDGE (HIGH CHANNEL)

HORIZONTAL PEAK AND AVERAGE PLOT

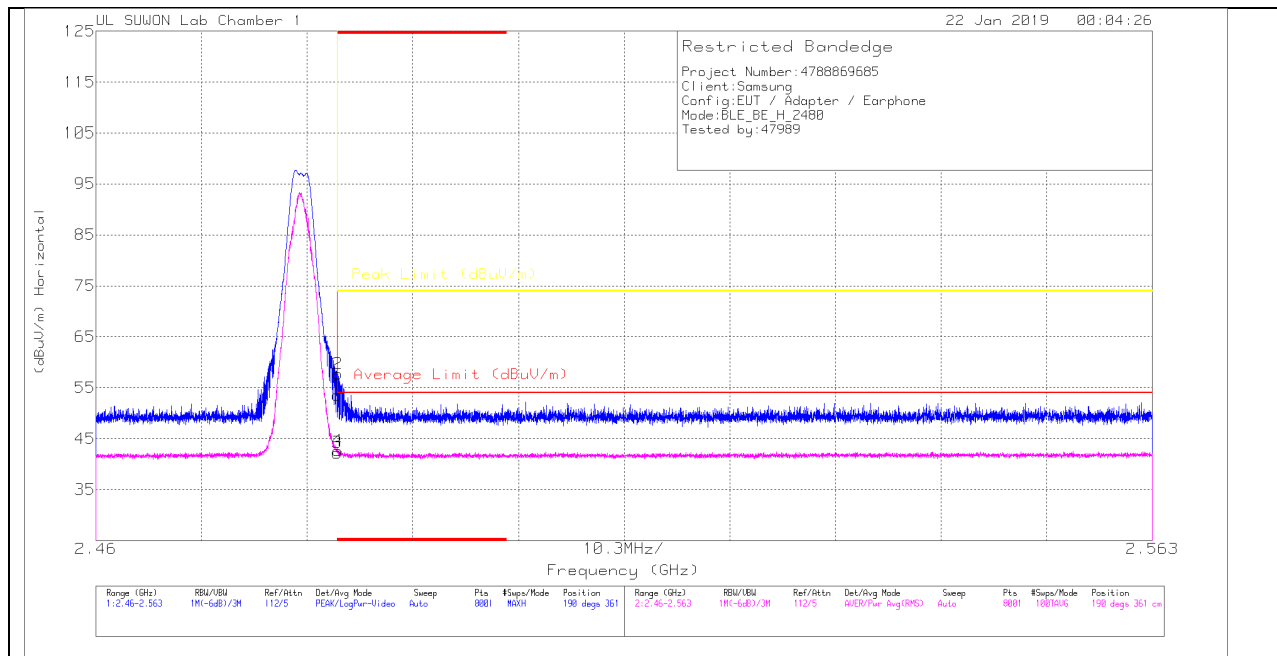

HORIZONTAL DATA

Trace Markers

Marker	Frequency (GHz)	Meter Reading (dBuV)	Det	3117_00168717	10dB(dB)	DC Corr (dB)	Corrected Reading (dBuV/m)	Average Limit (dBuV/m)	Margin (dB)	Peak Limit (dBuV/m)	PK Margin (dB)	Asimuth (Degs)	Height (cm)	Polarity
1	* 2.484	46.9	Pk	31.9	-25.3	0	53.5	-	-	74	-20.5	190	361	H
2	* 2.484	51.14	Pk	31.9	-25.3	0	57.74	-	-	74	-16.26	190	361	H
3	* 2.484	33.19	RMS	31.9	-25.3	2.44	42.23	54	-11.77	-	-	190	361	H
4	* 2.484	33.63	RMS	31.9	-25.3	2.44	42.67	54	-11.33	-	-	190	361	H

* - indicates frequency in CFR47 Pt 15 / IC RSS-Restricted Band

Pk - Peak detector

RMS - RMS detection

VERTICAL PEAK AND AVERAGE PLOT

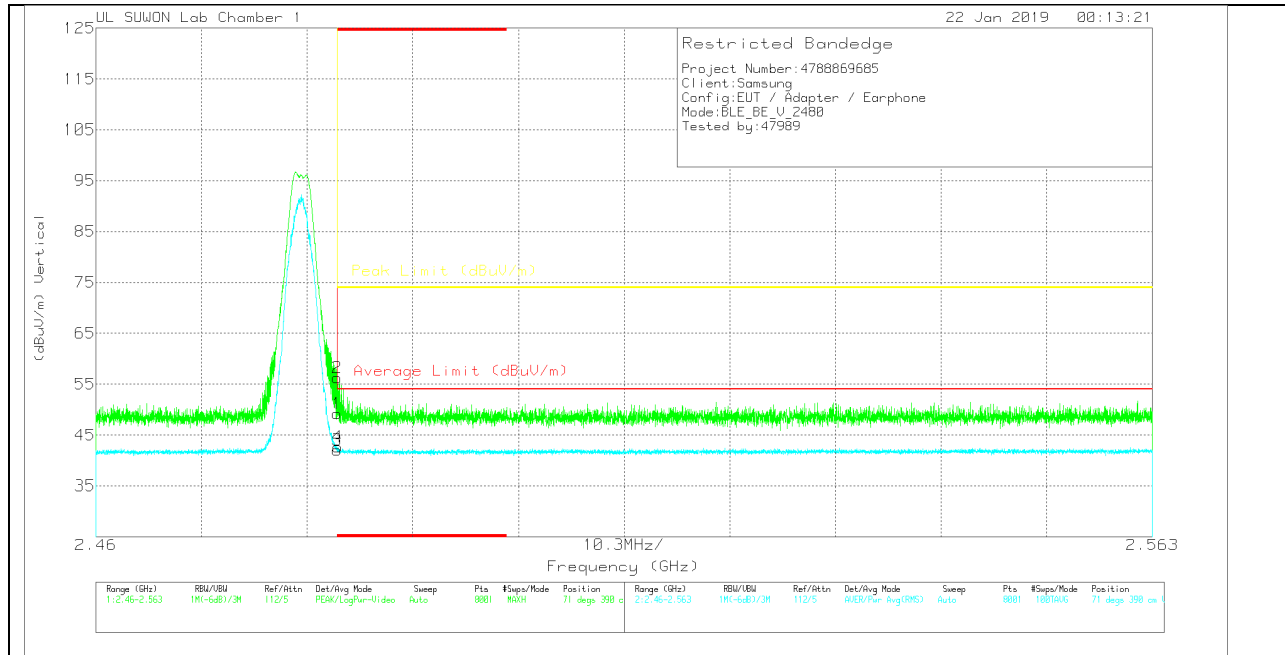

VERTICAL DATA

Trace Markers

Marker	Frequency (GHz)	Meter Reading (dBuV)	Det	3117_00168717	10dB(dB)	DC Corr (dB)	Corrected Reading (dBuV/m)	Average Limit (dBuV/m)	Margin (dB)	Peak Limit (dBuV/m)	PK Margin (dB)	Azimuth (Degs)	Height (cm)	Polarity
1	* 2.484	42.65	Pk	31.9	-25.3	0	49.25	-	-	74	-24.75	71	390	V
2	* 2.484	49.66	Pk	31.9	-25.3	0	56.26	-	-	74	-17.74	71	390	V
3	* 2.484	33.05	RMS	31.9	-25.3	2.44	42.09	54	-11.91	-	-	71	390	V
4	* 2.484	33.65	RMS	31.9	-25.3	2.44	42.69	54	-11.31	-	-	71	390	V

* - indicates frequency in CFR47 Pt 15 / IC RSS-Restricted Band

Pk - Peak detector

RMS - RMS detection

HARMONICS AND SPURIOUS EMISSIONS

LOW CHANNEL HORIZONTAL

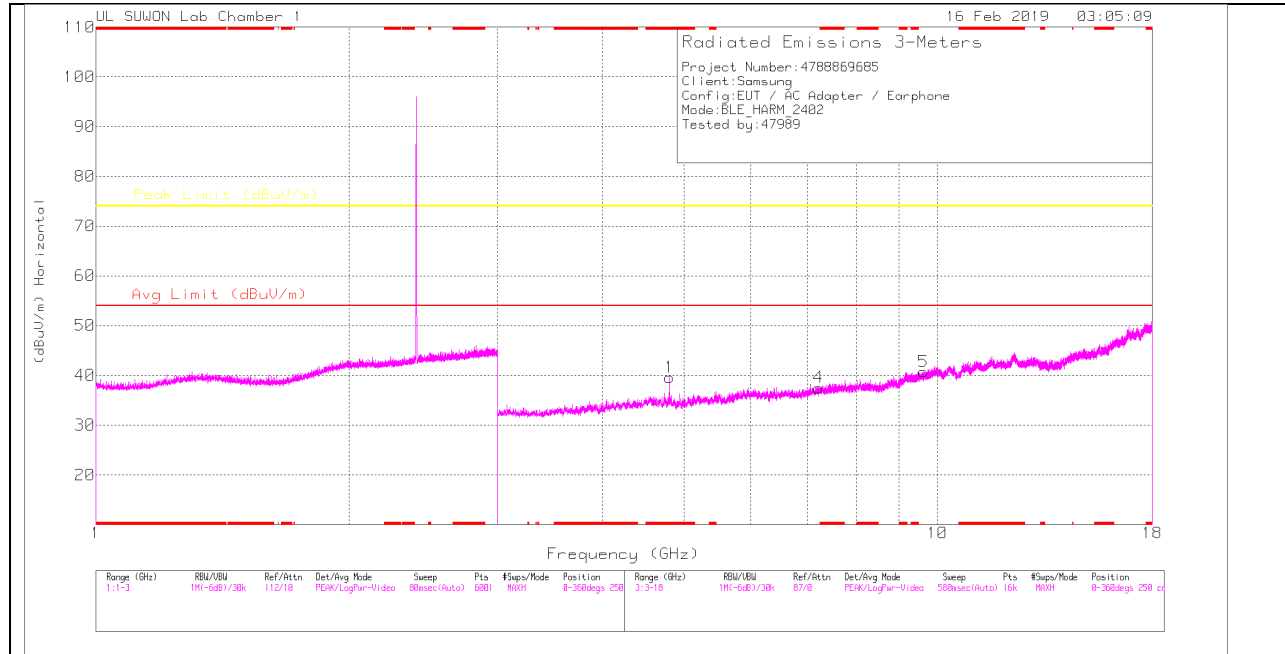

LOW CHANNEL VERTICAL

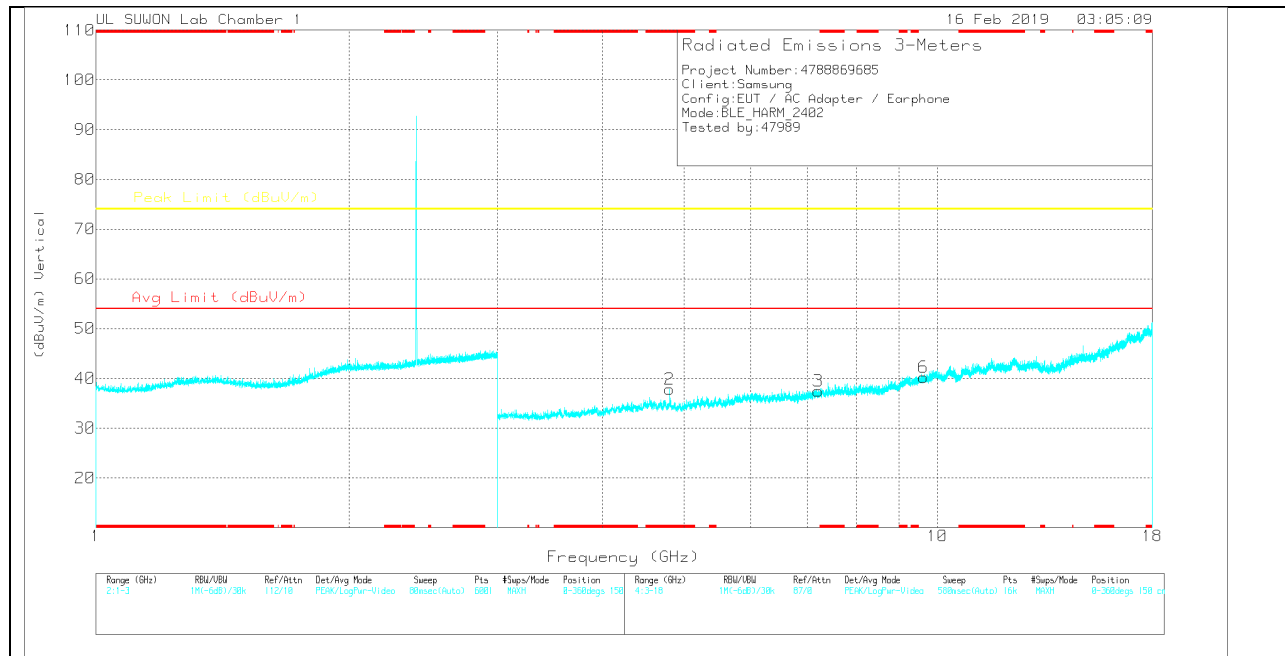

Note: Emission was scanned up to 26GHz; No emissions were detected above the noise floor which was at least 20dB below the specification limit.

LOW CHANNEL DATA

Marker	Frequency (GHz)	Meter Reading (dBuV)	Det	3117_00168717	3GHz_HP[dB]	DC Corr (dB)	Corrected Reading (dBuV/m)	Avg Limit (dBuV/m)	Margin (dB)	Peak Limit (dBuV/m)	Margin (dB)	Azimuth (Degs)	Height (cm)	Polarity
1	* 4.804	36.81	PK	34.2	-31.4	0	39.61	-	-	74	-34.39	0-360	250	H
4	7.217	29.52	PK	35.8	-27.8	0	37.52	-	-	74	-36.48	0-360	250	H
5	9.622	26.84	PK	37	-23.1	0	40.74	-	-	74	-33.26	0-360	150	H
2	* 4.804	35.02	PK	34.2	-31.4	0	37.82	-	-	74	-36.18	0-360	150	V
3	7.216	29.55	PK	35.8	-27.9	0	37.45	-	-	74	-36.55	0-360	150	V
6	9.619	26.29	PK	37	-23.1	0	40.19	-	-	74	-33.81	0-360	150	V

* - indicates frequency in CFR47 Pt 15 / IC RSS-Restricted Band
 PK – Peak detector

Radiated Emissions

Frequency (GHz)	Meter Reading (dBuV)	Det	3117_00168717	3GHz_HP[dB]	DC Corr (dB)	Corrected Reading (dBuV/m)	Avg Limit (dBuV/m)	Margin (dB)	Peak Limit (dBuV/m)	Margin (dB)	Azimuth (Degs)	Height (cm)	Polarity
* 4.804	43.61	PK2	34.2	-31.4	0	46.41	-	-	74	-27.59	141	121	H
* 4.804	35.38	MAv1	34.2	-31.4	.7	38.88	54	-15.12	-	-	141	121	H
* 4.804	43.09	PK2	34.2	-31.4	0	45.89	-	-	74	-28.11	184	154	V
* 4.804	33.65	MAv1	34.2	-31.4	.7	37.15	54	-16.85	-	-	184	154	V

* - indicates frequency in CFR47 Pt 15 / IC RSS-Restricted Band
 PK2 - KDB558074 Method: Maximum Peak
 MAv1 - KDB558074 Option 1 Maximum RMS Average

MID CHANNEL HORIZONTAL

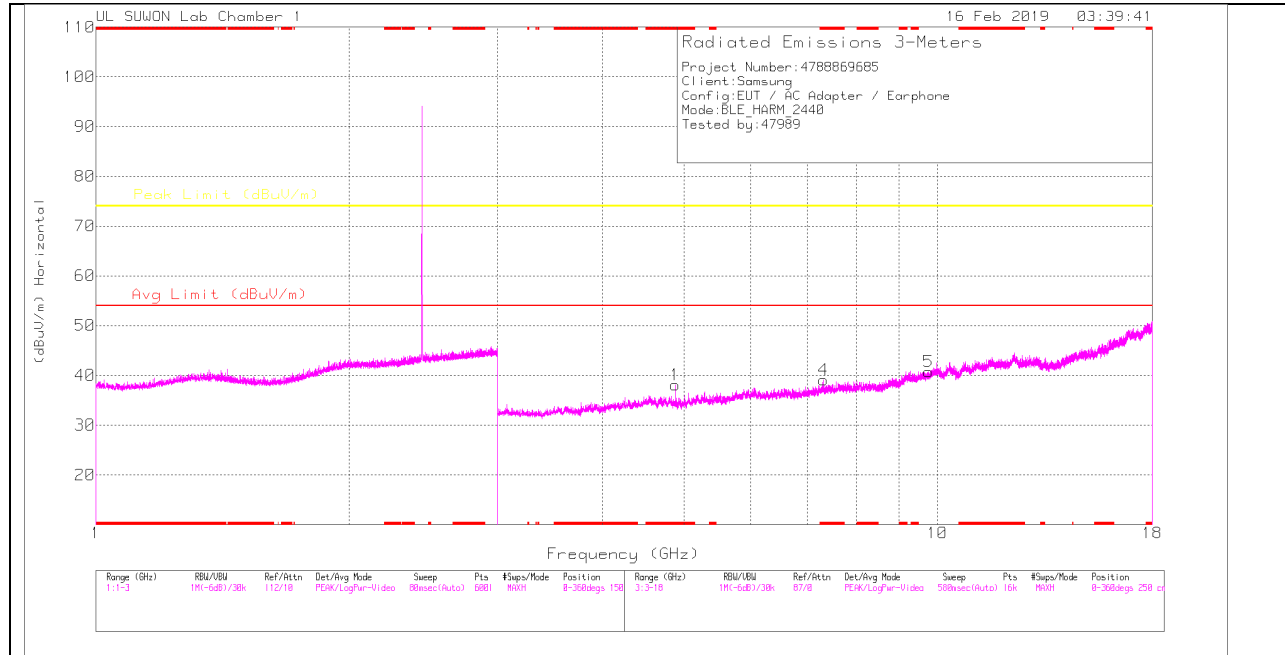

MID CHANNEL VERTICAL

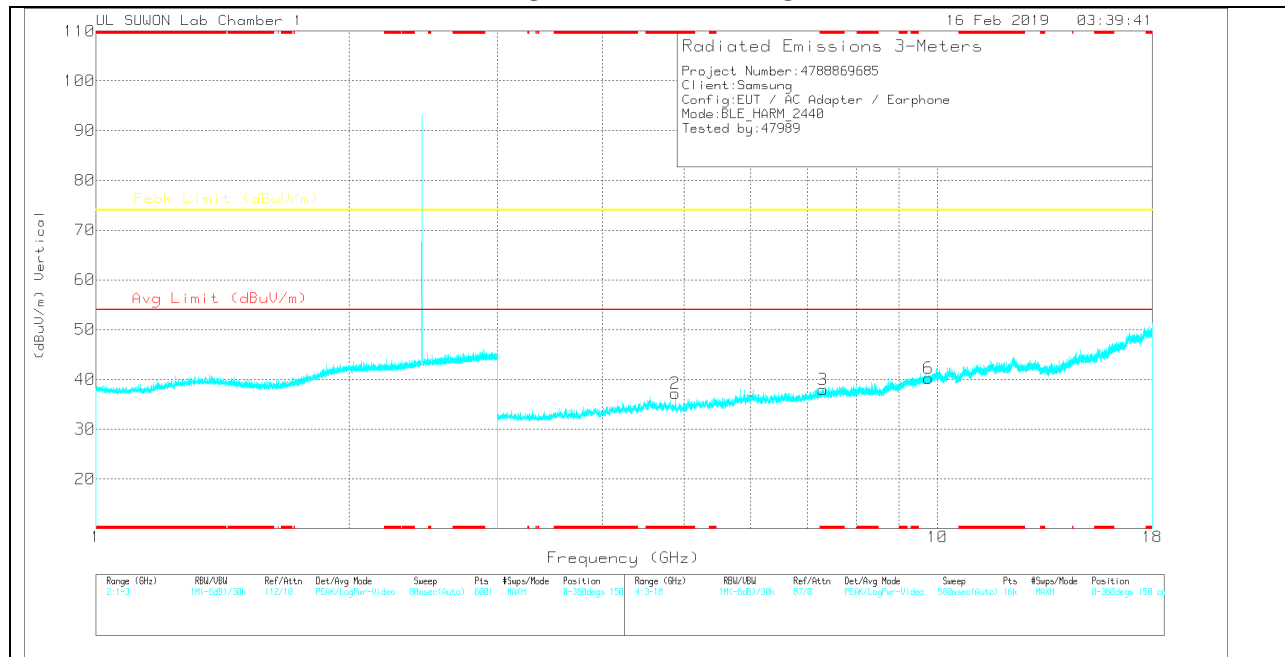

Note: Emission was scanned up to 26GHz; No emissions were detected above the noise floor which was at least 20dB below the specification limit.

MID CHANNEL DATA

Trace Markers

Marker	Frequency (GHz)	Meter Reading (dBuV)	Det	3117_00168717	3GHz_HP[dB]	DC Corr (dB)	Corrected Reading (dBuV/m)	Avg Limit (dBuV/m)	Margin (dB)	Peak Limit (dBuV/m)	Margin (dB)	Azimuth (Degs)	Height (cm)	Polarity
1	* 4.88	35.33	PK	34.2	-31.5	0	38.03	-	-	74	-35.97	0-360	150	H
4	* 7.322	30.55	PK	35.8	-27.3	0	39.05	-	-	74	-34.95	0-360	250	H
5	9.76	27.48	PK	37.2	-23.9	0	40.78	-	-	74	-33.22	0-360	250	H
2	* 4.88	34.52	PK	34.2	-31.5	0	37.22	-	-	74	-36.78	0-360	150	V
3	* 7.312	29.6	PK	35.8	-27.4	0	38	-	-	74	-36	0-360	150	V
6	9.76	26.88	PK	37.2	-23.9	0	40.18	-	-	74	-33.82	0-360	250	V

* - indicates frequency in CFR47 Pt 15 / IC RSS-Restricted Band

PK – Peak detector

Radiated Emissions

Frequency (GHz)	Meter Reading (dBuV)	Det	3117_00168717	3GHz_HP[dB]	DC Corr (dB)	Corrected Reading (dBuV/m)	Avg Limit (dBuV/m)	Margin (dB)	Peak Limit (dBuV/m)	Margin (dB)	Azimuth (Degs)	Height (cm)	Polarity
* 4.88	43.67	PK2	34.2	-31.5	0	46.37	-	-	74	-27.63	139	123	H
* 4.88	36.01	MAv1	34.2	-31.5	.7	39.41	54	-14.59	-	-	139	123	H
* 4.88	43.17	PK2	34.2	-31.5	0	45.87	-	-	74	-28.13	187	162	V
* 4.88	34.06	MAv1	34.2	-31.5	.7	37.46	54	-16.54	-	-	187	162	V

* - indicates frequency in CFR47 Pt 15 / IC RSS-Restricted Band

PK2 - KDB558074 Method: Maximum Peak

MAv1 - KDB558074 Option 1 Maximum RMS Average

HIGH CHANNEL HORIZONTAL

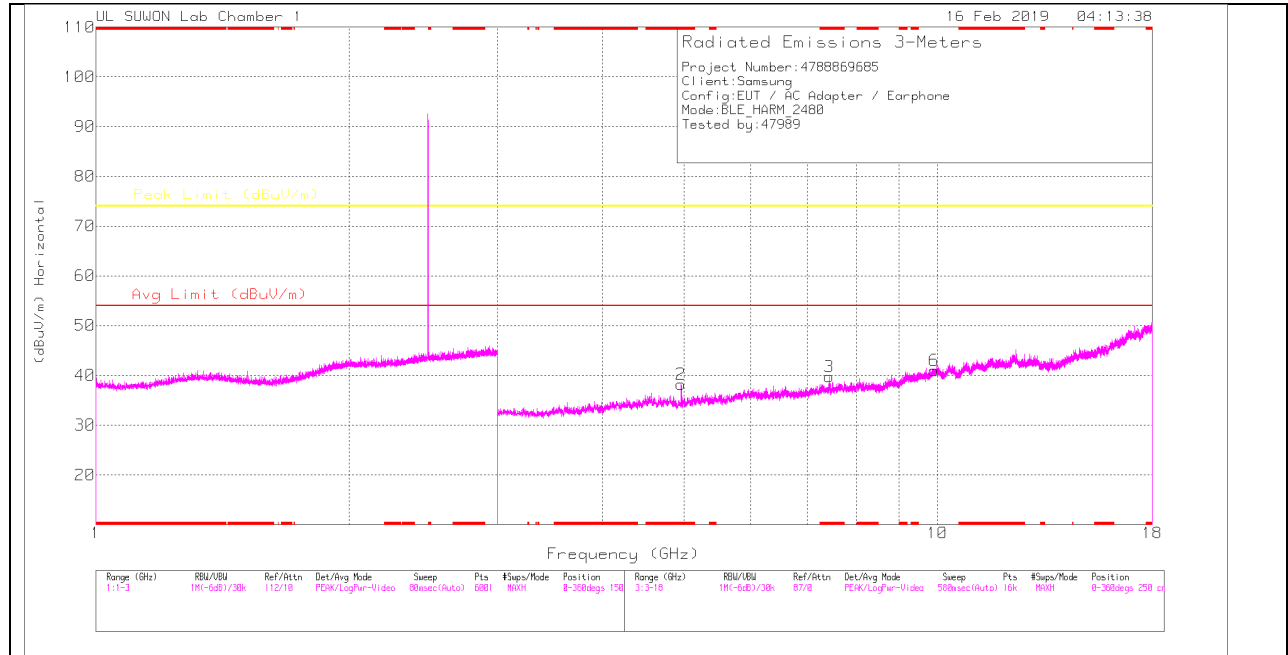

HIGH CHANNEL VERTICAL

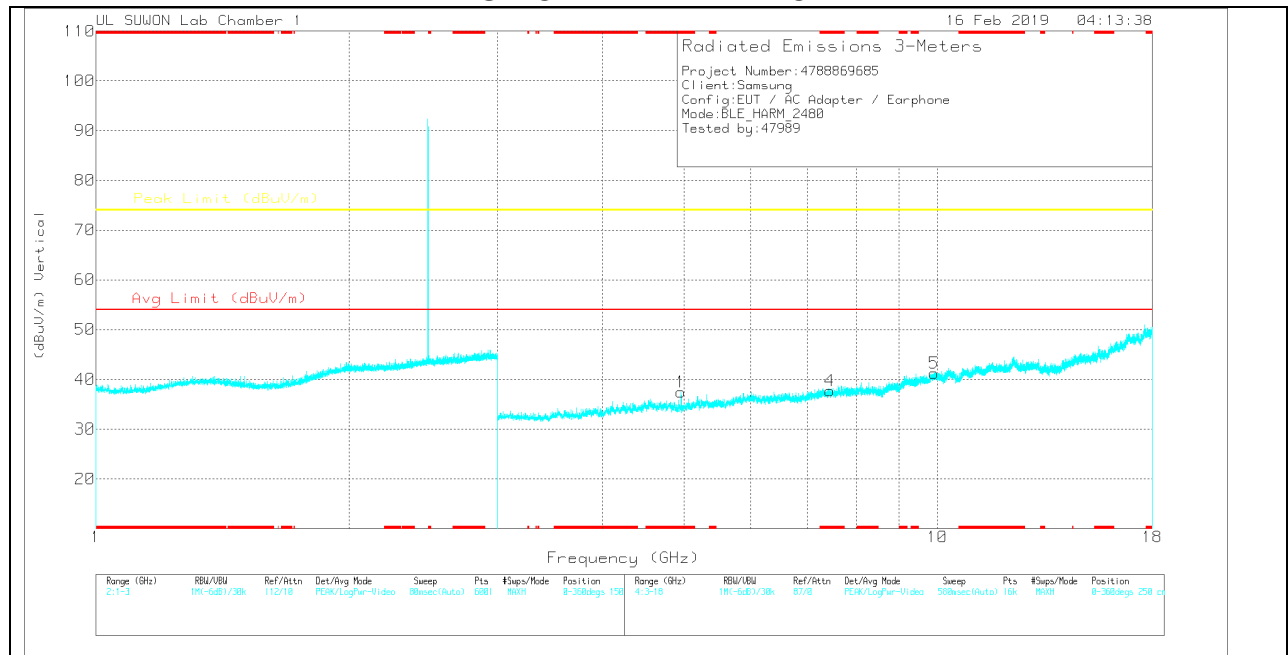

Note: Emission was scanned up to 26GHz; No emissions were detected above the noise floor which was at least 20dB below the specification limit.

HIGH CHANNEL DATA

Trace Markers

Marker	Frequency (GHz)	Meter Reading (dBuV)	Det	3117_00168717	3GHz_HP[dB]	DC Corr (dB)	Corrected Reading (dBuV/m)	Avg Limit (dBuV/m)	Margin (dB)	Peak Limit (dBuV/m)	Margin (dB)	Azimuth (Degs)	Height (cm)	Polarity
2	* 4.959	35.36	PK	34.2	-31.4	0	38.16	-	-	74	-35.84	0-360	250	H
3	* 7.44	30.97	PK	35.8	-27	0	39.77	-	-	74	-34.23	0-360	150	H
6	9.909	26.02	PK	37.4	-22.4	0	41.02	-	-	74	-32.98	0-360	150	H
1	* 4.959	34.66	PK	34.2	-31.4	0	37.46	-	-	74	-36.54	0-360	150	V
4	* 7.45	29	PK	35.8	-27.1	0	37.7	-	-	74	-36.3	0-360	250	V
5	9.911	26.06	PK	37.5	-22.3	0	41.26	-	-	74	-32.74	0-360	250	V

* - indicates frequency in CFR47 Pt 15 / IC RSS-Restricted Band
 PK – Peak detector

Radiated Emissions

Frequency (GHz)	Meter Reading (dBuV)	Det	3117_00168717	3GHz_HP[dB]	DC Corr (dB)	Corrected Reading (dBuV/m)	Avg Limit (dBuV/m)	Margin (dB)	Peak Limit (dBuV/m)	Margin (dB)	Azimuth (Degs)	Height (cm)	Polarity
* 4.96	43.52	PK2	34.2	-31.4	0	46.32	-	-	74	-27.68	138	121	H
* 4.96	35.35	MAv1	34.2	-31.4	.7	38.85	54	-15.15	-	-	138	121	H
* 4.959	42.43	PK2	34.2	-31.4	0	45.23	-	-	74	-28.77	182	181	V
* 4.96	33.6	MAv1	34.2	-31.4	.7	37.1	54	-16.9	-	-	182	181	V
* 7.442	40.67	PK2	35.8	-27	0	49.47	-	-	74	-24.53	152	100	H
* 7.439	28.43	MAv1	35.8	-27	.7	37.93	54	-16.07	-	-	152	100	H
* 7.439	39.6	PK2	35.8	-27	0	48.4	-	-	74	-25.6	119	278	V
* 7.441	26.45	MAv1	35.8	-27	.7	35.95	54	-18.05	-	-	119	278	V

* - indicates frequency in CFR47 Pt 15 / IC RSS-Restricted Band
 PK2 - KDB558074 Method: Maximum Peak
 MAv1 - KDB558074 Option 1 Maximum RMS Average

11.3. WORST-CASE BELOW 1 GHz

SPURIOUS EMISSIONS 30 TO 1000 MHz (1Mbps)

HORIZONTAL PLOT

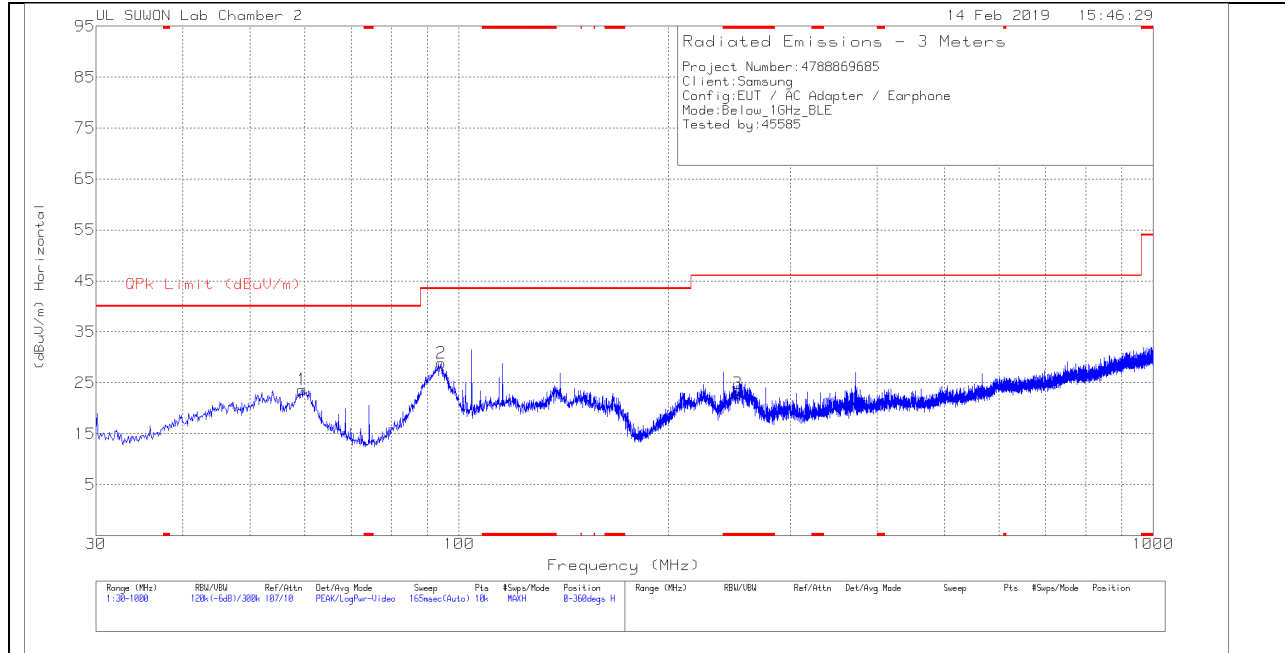

VERTICAL PLOT

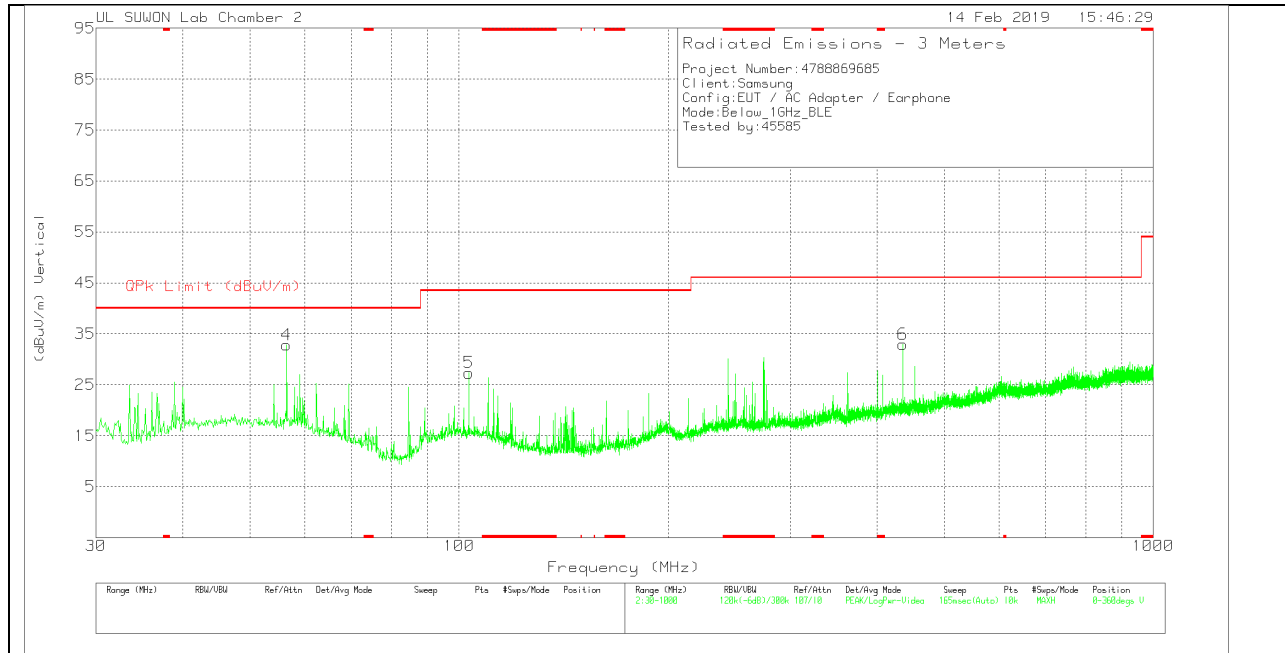

BELOW 1 GHz TABLE

Trace Markers

Marker	Frequency (MHz)	Meter Reading (dBuV)	Det	VULB9163_749	Below_1G[dB]	Corrected Reading (dBuV/m)	QPk Limit (dBuV/m)	Margin (dB)	Azimuth (Degs)	Height (cm)	Polarity
1	59.391	36.75	Pk	18.6	-31.7	23.65	40	-16.35	0-360	400	H
2	94.214	43.24	Pk	17	-31.4	28.84	43.52	-14.68	0-360	300	H
3	* 251.548	34.47	Pk	19.1	-30.6	22.97	46.02	-23.05	0-360	100	H
4	56.481	45.44	Pk	19.1	-31.7	32.84	40	-7.16	0-360	100	V
5	103.332	41.02	Pk	17.7	-31.4	27.32	43.52	-16.2	0-360	300	V
6	436.042	41.2	Pk	22.1	-30.4	32.9	46.02	-13.12	0-360	100	V

* - indicates frequency in CFR47 Pt 15 / IC RSS-Restricted Band
 Pk - Peak detector

12. AC POWER LINE CONDUCTED EMISSIONS

LIMITS

FCC §15.207 (a)

Frequency of Emission (MHz)	Conducted Limit (dBuV)	
	Quasi-peak	Average
0.15-0.5	66 to 56	56 to 46
0.5-5	56	46
5-30	60	50

*Decreases with the logarithm of the frequency.

TEST PROCEDURE

The EUT is placed on a non-conducting table 40 cm from the vertical ground plane and 80 cm above the horizontal ground plane. The EUT is configured in accordance with ANSI C63.10.

The receiver is set to a resolution bandwidth of 9 kHz. Peak detection is used unless otherwise noted as quasi-peak or average.

Line conducted data is recorded for both NEUTRAL and HOT lines.

RESULTS

WORST EMISSIONS (1Mbps)

LINE 1 PLOT

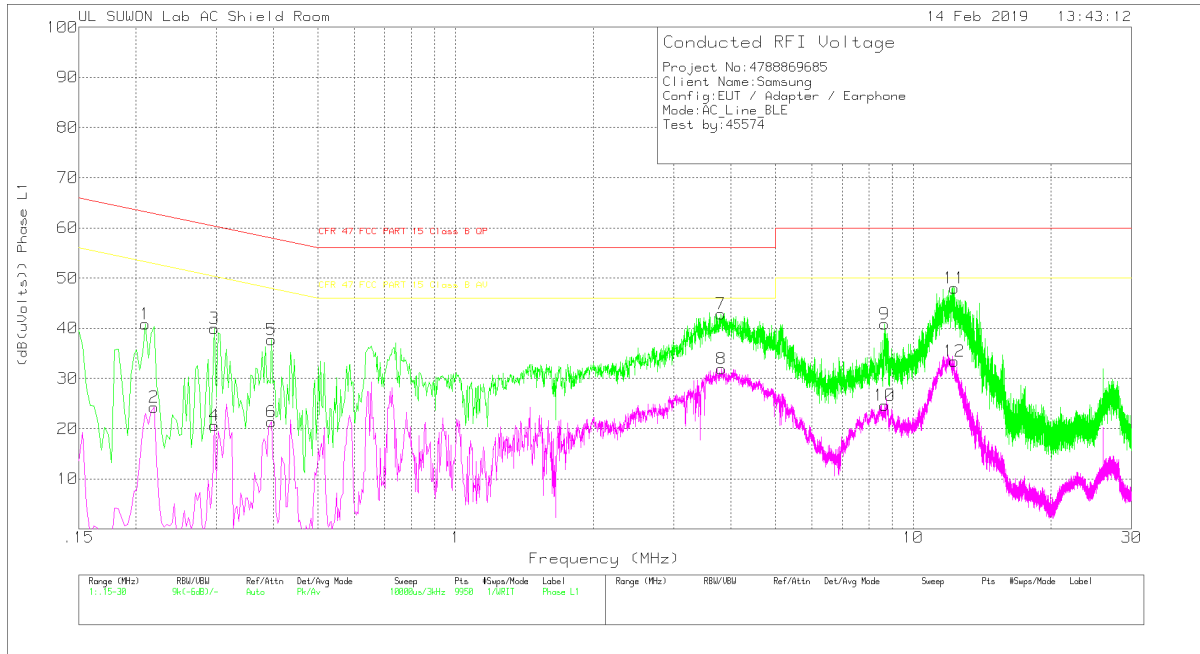

LINE 1 RESULTS

Trace Markers

Range 1: Phase L1 .15 - 30MHz

Marker	Frequency (MHz)	Meter Reading (dBuV)	Det	ENV216_10183 6_With ex-cord_L1	CABLELOSS(dB)	Corrected Reading (dB(uVolts))	CFR 47 FCC PART 15 Class B QP	Margin (dB)	CFR 47 FCC PART 15 Class B AV	Margin (dB)
1	.21	30.76	Pk	9.9	.2	40.86	63.21	-22.35	-	-
2	.219	14.3	Av	9.8	.2	24.3	-	-	52.86	-28.56
3	.297	30.01	Pk	9.8	.2	40.01	60.33	-20.32	-	-
4	.297	10.63	Av	9.8	.2	20.63	-	-	50.33	-29.7
5	.396	27.67	Pk	9.9	.2	37.77	57.94	-20.17	-	-
6	.396	11.24	Av	9.9	.2	21.34	-	-	47.94	-26.6
7	3.795	32.73	Pk	9.8	.3	42.83	56	-13.17	-	-
8	3.816	21.88	Av	9.8	.3	31.98	-	-	46	-14.02
9	8.649	30.66	Pk	9.9	.3	40.86	60	-19.14	-	-
10	8.652	14.46	Av	9.9	.3	24.66	-	-	50	-25.34
11	12.294	37.66	Pk	10.1	.3	48.06	60	-11.94	-	-
12	12.303	23.08	Av	10.1	.3	33.48	-	-	50	-16.52

Pk - Peak detector

Av - Average detection

LINE 2 PLOT

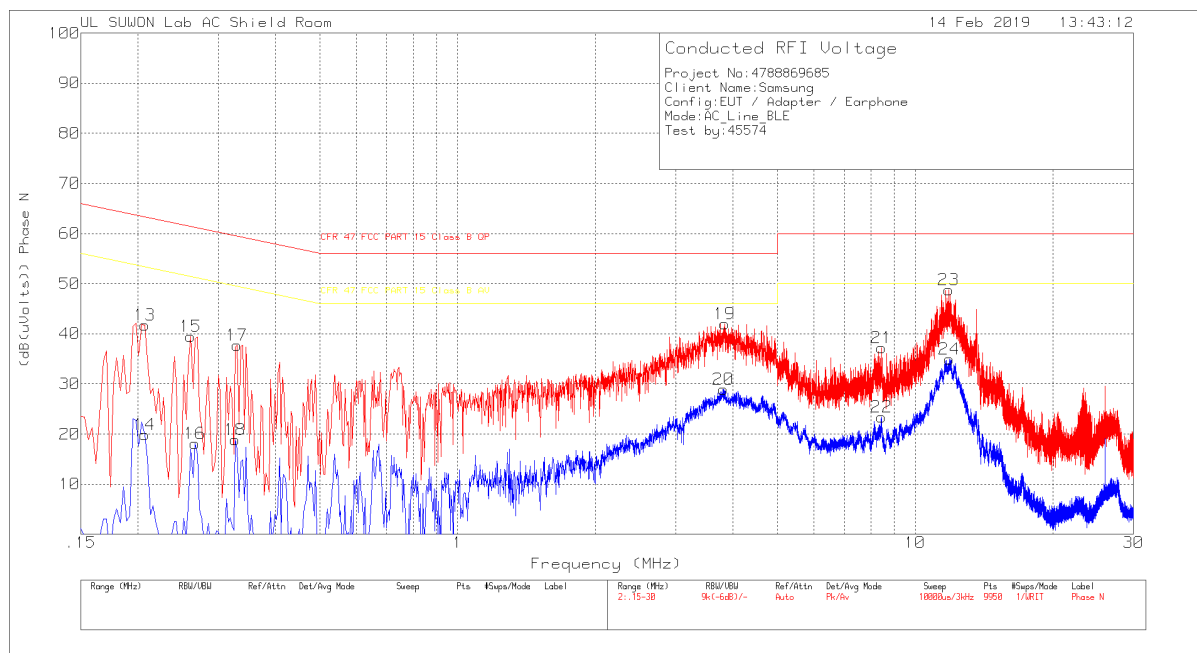

LINE 2 RESULTS

Trace Markers

Range 2: Phase N .15 - 30MHz

Marker	Frequency (MHz)	Meter Reading (dBuV)	Det	ENV216_10183 6_With ex-cord_N	CABLELOSS(dB)	Corrected Reading (dB(uVolts))	CFR 47 FCC PART 15 Class B QP	Margin (dB)	CFR 47 FCC PART 15 Class B AV	Margin (dB)
13	.207	31.69	Pk	9.8	.2	41.69	63.32	-21.63	-	-
14	.207	9.87	Av	9.8	.2	19.87	-	-	53.32	-33.45
15	.261	29.53	Pk	9.7	.2	39.43	61.4	-21.97	-	-
16	.267	8.18	Av	9.7	.2	18.08	-	-	51.21	-33.13
17	.33	27.68	Pk	9.8	.2	37.68	59.45	-21.77	-	-
18	.327	8.92	Av	9.8	.2	18.92	-	-	49.53	-30.61
19	3.834	31.88	Pk	9.8	.3	41.98	56	-14.02	-	-
20	3.813	18.78	Av	9.8	.3	28.88	-	-	46	-17.12
21	8.457	27.01	Pk	9.9	.3	37.21	60	-22.79	-	-
22	8.454	13.18	Av	9.9	.3	23.38	-	-	50	-26.62
23	11.853	38.38	Pk	10.1	.3	48.78	60	-11.22	-	-
24	11.868	24.58	Av	10.1	.3	34.98	-	-	50	-15.02

Pk - Peak detector
 Av - Average detection