



FCC CFR47 PART 15 SUBPART C

DTS Wireless LAN

CERTIFICATION TEST REPORT

FOR

GSM/WCDMA/LTE Phone + BT/BLE, DTS b/g/n and NFC

MODEL NUMBER : SM-A205GN/DS, SM-A205GN

FCC ID: A3LSMA205GN

REPORT NUMBER: 4788869685-E2V2

ISSUE DATE: FEB 26, 2019

Prepared for
SAMSUNG ELECTRONICS CO., LTD.
129 SAMSUNG-RO, YEONGTONG-GU, SUWON-SI,
GYEONGGI-DO, 16677, KOREA

Prepared by
UL Korea, Ltd.
26th floor, 152, Teheran-ro, Gangnam-gu Seoul, 06236, Korea

Suwon Test Site: UL Korea, Ltd. Suwon Laboratory
218 Maeyeong-ro, Yeongtong-gu,
Suwon-si, Gyeonggi-do, 16675, Korea
TEL: (031) 337-9902
FAX: (031) 213-5433



Testing
Laboratory

TL-637

Revision History

<u>Rev.</u>	<u>Issue Date</u>	<u>Revisions</u>	<u>Revised By</u>
V1	02/21/19	Initial issue	Hoonpyo Lee
V2	02/26/19	Updated to address about the TCB's question	Hoonpyo Lee

TABLE OF CONTENTS

1. ATTESTATION OF TEST RESULTS	5
2. TEST METHODOLOGY	6
3. FACILITIES AND ACCREDITATION	6
4. CALIBRATION AND UNCERTAINTY	6
4.1. MEASURING INSTRUMENT CALIBRATION.....	6
4.2. SAMPLE CALCULATION.....	6
4.3. MEASUREMENT UNCERTAINTY	6
5. EQUIPMENT UNDER TEST	7
5.1. DESCRIPTION OF EUT.....	7
5.2. MAXIMUM OUTPUT POWER.....	7
5.3. DESCRIPTION OF AVAILABLE ANTENNAS	7
5.4. WORST-CASE CONFIGURATION AND MODE	7
5.5. DESCRIPTION OF TEST SETUP	8
6. TEST AND MEASUREMENT EQUIPMENT	10
7. REFERENCE MEASUREMENT RESULTS.....	11
7.1. ON TIME AND DUTY CYCLE RESULTS.....	11
7.1. 99% BANDWIDTH	12
7.1.1. 802.11b MODE IN THE 2.4 GHz BAND.....	12
7.1.2. 802.11g MODE IN THE 2.4 GHz BAND.....	12
7.1.3. 802.11n HT20 MODE IN THE 2.4 GHz BAND	12
7.1.4. 99% BANDWIDTH PLOTS	13
8. MEASUREMENT METHODS	16
9. SUMMARY TABLE	17
10. ANTENNA PORT TEST RESULTS	18
10.1. 6 dB BANDWIDTH.....	18
10.1.1. 802.11b MODE IN THE 2.4 GHz BAND.....	19
10.1.1.1. 802.11g MODE IN THE 2.4 GHz BAND	19
10.1.2. 802.11n HT20 MODE IN THE 2.4 GHz BAND	19
10.1.3. 6 dB BANDWIDTH PLOTS.....	20
10.2. OUTPUT POWER.....	23
10.2.1. 802.11b MODE IN THE 2.4 GHz BAND.....	24
10.2.2. 802.11g MODE IN THE 2.4 GHz BAND.....	25
10.2.3. 802.11n HT20 MODE IN THE 2.4 GHz BAND	26

10.3.	PSD	27
10.3.1.	802.11b MODE IN THE 2.4 GHz BAND.....	28
10.3.2.	802.11g MODE IN THE 2.4 GHz BAND.....	28
10.3.3.	802.11n HT20 MODE IN THE 2.4 GHz BAND	28
10.3.4.	PSD PLOTS	29
10.4.	OUT-OF-BAND EMISSIONS	32
10.4.1.	802.11b MODE IN THE 2.4 GHz BAND.....	33
10.4.2.	802.11g MODE IN THE 2.4 GHz BAND.....	38
10.4.3.	802.11n HT20 MODE IN THE 2.4 GHz BAND	43
11.	RADIATED TEST RESULTS	49
11.1.	LIMITS AND PROCEDURE	49
11.2.	TRANSMITTER ABOVE 1 GHz	51
11.2.1.	TX ABOVE 1 GHz 802.11b MODE IN THE 2.4 GHz BAND	51
11.2.2.	TX ABOVE 1 GHz 802.11g MODE IN THE 2.4 GHz BAND	65
11.2.3.	TX ABOVE 1 GHz 802.11n HT20 MODE IN THE 2.4 GHz BAND	79
11.3.	WORST-CASE BELOW 1 GHz.....	95
12.	AC POWER LINE CONDUCTED EMISSIONS	97
13.	SETUP PHOTOS	102

1. ATTESTATION OF TEST RESULTS

COMPANY NAME: SAMSUNG ELECTRONICS CO., LTD.
EUT DESCRIPTION: GSM/WCDMA/LTE Phone + BT/BLE, DTS b/g/n and NFC
MODEL NUMBER: SM-A205GN/DS, SM-A205GN
SERIAL NUMBER: R38K909WK7M, R38M10DABYP (RADIATED);
5200499a529db5c1 (CONDUCTED)
DATE TESTED: FEB 08, 2019 – FEB 25, 2019

APPLICABLE STANDARDS	
STANDARD	TEST RESULTS
CFR 47 Part 15 Subpart C	Pass

UL Korea, Ltd. tested the above equipment in accordance with the requirements set forth in the above standards. All indications of Pass/Fail in this report are opinions expressed by UL Korea, Ltd. based on interpretations and/or observations of test results. Measurement Uncertainties were not taken into account and are published for informational purposes only. The test results show that the equipment tested is capable of demonstrating compliance with the requirements as documented in this report.

Note: The results documented in this report apply only to the tested sample, under the conditions and modes of operation as described herein. This document may not be altered or revised in any way unless done so by UL Korea, Ltd. and all revisions are duly noted in the revisions section. Any alteration of this document not carried out by UL Korea, Ltd. will constitute fraud and shall nullify the document. This report must not be used by the client to claim product certification, approval, or endorsement by IAS, any agency of the Federal Government, or any agency of any government.

Approved & Released For
UL Korea, Ltd. By:



SungGil Park
Suwon Lab Engineer
UL Korea, Ltd.

Tested By:



Hoonpyo Lee
Suwon Lab Engineer
UL Korea, Ltd.

2. TEST METHODOLOGY

The tests documented in this report were performed in accordance with following methods.

1. FCC CFR 47 Part 2.
2. FCC CFR 47 Part 15.
3. KDB 558074 D01 15.247 Meas Guidance v05r01.
4. ANSI C63.10-2013.

3. FACILITIES AND ACCREDITATION

The test sites and measurement facilities used to collect data are located at 218 Maeyeong-ro, Yeongtong-gu, Suwon-si, Gyeonggi-do, 16675, Korea. Line conducted emissions are measured only at the 218 address. The following table identifies which facilities were utilized for radiated emission measurements documented in this report. Specific facilities are also identified in the test results sections.

218 Maeyeong-ro	
<input checked="" type="checkbox"/>	Chamber 1
<input checked="" type="checkbox"/>	Chamber 2
<input type="checkbox"/>	Chamber 3

UL Korea, Ltd. is accredited by IAS, Laboratory Code TL-637. The full scope of accreditation can be viewed at <http://www.iasonline.org/PDF/TL/TL-637.pdf>.

4. CALIBRATION AND UNCERTAINTY

4.1. MEASURING INSTRUMENT CALIBRATION

The measuring equipment utilized to perform the tests documented in this report has been calibrated in accordance with the manufacturer's recommendations, and is traceable to recognized national standards.

4.2. SAMPLE CALCULATION

Where relevant, the following sample calculation is provided:

$$\begin{aligned} \text{Field Strength (dBuV/m)} &= \text{Measured Voltage (dBuV)} + \text{Antenna Factor (dB/m)} + \\ &\text{Cable Loss (dB)} - \text{Preamp Gain (dB)} \\ 36.5 \text{ dBuV} + 18.7 \text{ dB/m} + 0.6 \text{ dB} - 26.9 \text{ dB} &= 28.9 \text{ dBuV/m} \end{aligned}$$

4.3. MEASUREMENT UNCERTAINTY

Where relevant, the following measurement uncertainty levels have been estimated for tests performed on the apparatus:

PARAMETER	UNCERTAINTY
Conducted Disturbance, 0.15 to 30 MHz	2.32 dB
Radiated Disturbance, Below 1GHz	3.86 dB
Radiated Disturbance, Above 1 GHz	5.97 dB

Uncertainty figures are valid to a confidence level of 95%.

5. EQUIPMENT UNDER TEST

5.1. DESCRIPTION OF EUT

The EUT is a GSM/WCDMA/LTE Phone + BT/BLE, DTS b/g/n and NFC.
This test report addresses the DTS (WLAN) operational mode.

5.2. MAXIMUM OUTPUT POWER

The transmitter has a maximum total conducted average output power as follows:

Frequency Range [MHz]	Mode	Output Power [dBm]	Output Power [mW]
2412 - 2472	802.11b	17.16	52.00
	802.11g	16.15	41.21
	802.11n HT20	16.01	39.90

5.3. DESCRIPTION OF AVAILABLE ANTENNAS

The radio utilizes an internal antennas, with a antenna's maximum gain of -0.53 dBi.

5.4. WORST-CASE CONFIGURATION AND MODE

Radiated emission below 1GHz and power line conducted emission were performed with the EUT set to transmit at the channel with highest output power as worst-case scenario.

Radiated emission above 1GHz was performed with the EUT set to transmit low/mid/high Channels.

The fundamental of the EUT was investigated in three orthogonal orientations X, Y and Z it was determined that Y orientation was worst-case orientation; therefore, all final radiated testing was performed with the EUT in Y orientation.

Based on the baseline scan, the worst-case data rates were:

802.11b mode: 1 Mbps
802.11g mode: 6 Mbps
802.11n HT20 mode: MCS0

Note : All radiated and power line conducted tests were performed connected with earphone and charger for evaluation of worst case mode.

5.5. DESCRIPTION OF TEST SETUP

SUPPORT EQUIPMENT

Support Equipment List				
Description	Manufacturer	Model	Serial Number	FCC ID
Charger	SAMSUNG	EP-TA200	R37M15H5WM1SE3	N/A
Data Cable	SAMSUNG	EP-DR140AWE	N/A	N/A
Earphone	SAMSUNG	EHS61ASFWE	N/A	N/A

I/O CABLE

I/O Cable List						
Cable No	Port	# of identical ports	Connector Type	Cable Type	Cable Length (m)	Remarks
1	DC Power	1	C Type	Shielded	1.1m	N/A
2	Audio	2	Mini-Jack	Unshielded	1.2m	N/A

TEST SETUP

The EUT is a stand-alone unit during the tests.
 Test software in hidden menu exercised the EUT to enable DTS mode.

SETUP DIAGRAM FOR TESTS (CONDUCTED TEST SETUP)

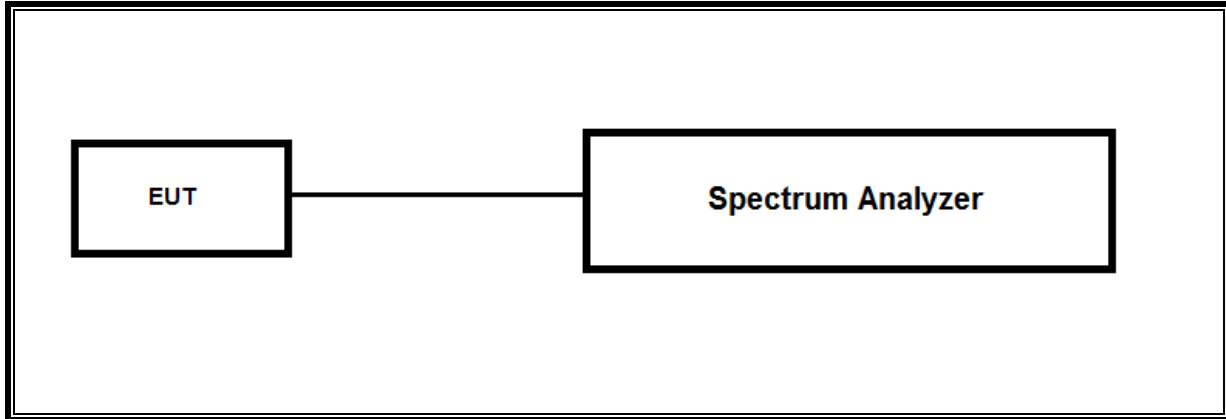

SETUP DIAGRAM FOR TESTS (RADIATED TEST SETUP)

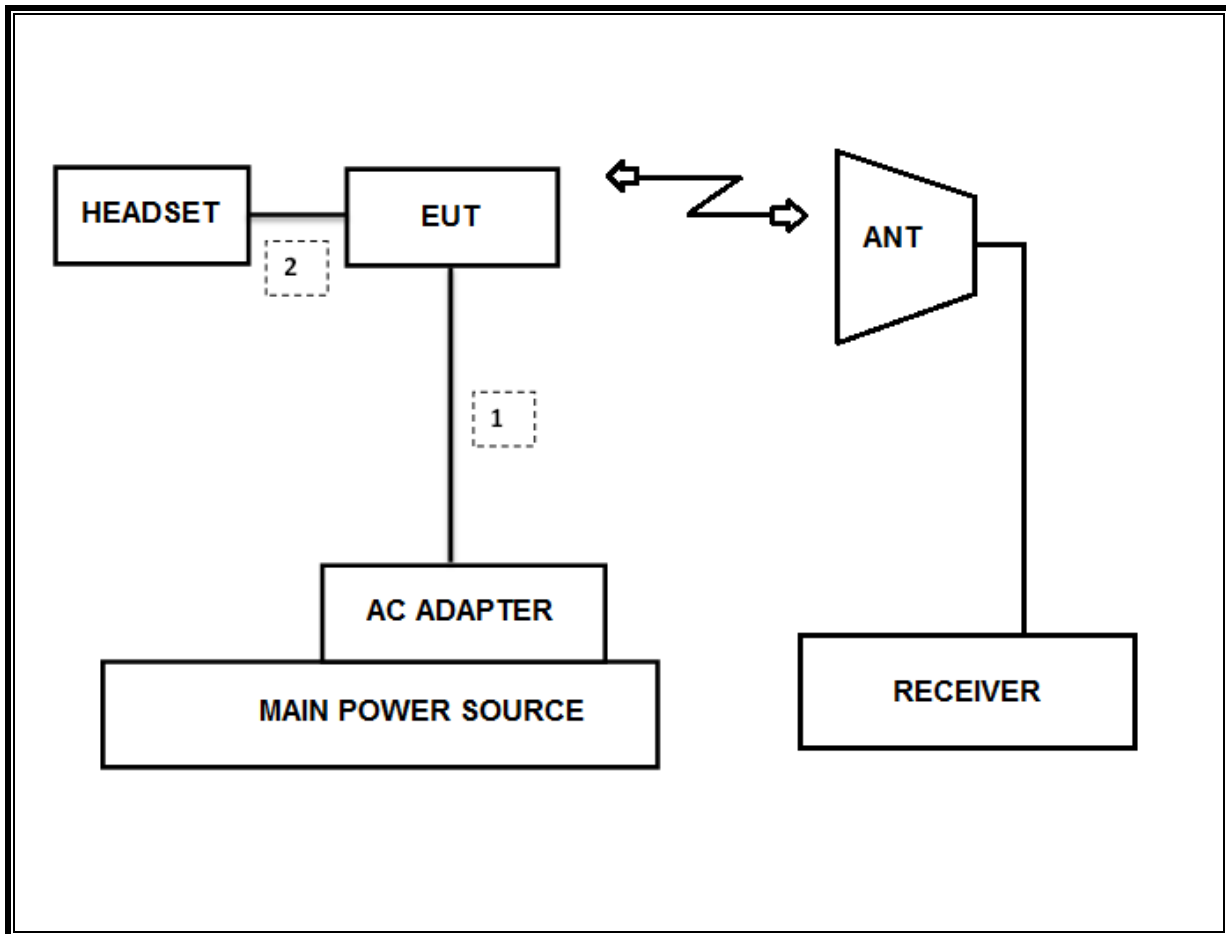

6. TEST AND MEASUREMENT EQUIPMENT

The following test and measurement equipment was utilized for the tests documented in this report:

Test Equipment List				
Description	Manufacturer	Model	S/N	Cal Due
Antenna, Bilog, 30MHz-1GHz	SCHWARZBECK	VULB9163	750	08-04-20
Antenna, Bilog, 30MHz-1GHz	SCHWARZBECK	VULB9163	749	08-04-20
Antenna, Bilog, 30MHz-1GHz	SCHWARZBECK	VULB9163	845	08-04-20
Antenna, Horn, 18 GHz	ETS	3115	00167211	08-04-20
Antenna, Horn, 18 GHz	ETS	3115	00161451	08-04-20
Antenna, Horn, 18 GHz	ETS	3117	00168724	08-04-20
Antenna, Horn, 18 GHz	ETS	3117	00168717	08-04-20
Antenna, Horn, 18 GHz	ETS	3117	00205959	08-04-20
Antenna, Horn, 40 GHz	ETS	3116C	00166155	12-04-19
Antenna, Horn, 40 GHz	ETS	3116C	00168645	12-04-19
Antenna, Horn, 40 GHz	ETS	3116C-PA	00168841	08-09-19
Preamplifier, 1000 MHz	Sonoma	310N	341282	08-07-19
Preamplifier, 1000 MHz	Sonoma	310N	351741	08-07-19
Preamplifier, 1000 MHz	Sonoma	310N	370599	08-06-19
Preamplifier, 18 GHz	Miteq	AFS42-00101800-25-S-42	1876511	08-07-19
Preamplifier, 18 GHz	Miteq	AFS42-00101800-25-S-42	1896138	08-07-19
Preamplifier, 18 GHz	Miteq	AFS42-00101800-25-S-42	2029169	08-07-19
Spectrum Analyzer, 44 GHz	Agilent / HP	N9030A	MY54170614	08-07-19
Spectrum Analyzer, 44 GHz	Agilent / HP	N9030A	MY54490312	08-06-19
Spectrum Analyzer, 43.5 GHz	R&S	FSW43	104089	08-06-19
Average Power Sensor	Agilent / HP	U2000	MY54270007	08-07-19
Attenuator	PASTERNAK	PE7087-10	A001	08-08-19
Attenuator	PASTERNAK	PE7087-10	A008	08-08-19
Attenuator	PASTERNAK	PE7004-10	2	08-07-19
Attenuator	PASTERNAK	PE7087-10	A009	08-08-19
EMI Test Receive, 40 GHz	R&S	ESU40	100439	08-06-19
EMI Test Receive, 40 GHz	R&S	ESU40	100457	08-06-19
EMI Test Receive, 44 GHz	R&S	ESW44	101590	08-06-19
EMI Test Receive, 3 GHz	R&S	ESR3	101832	08-06-19
Low Pass Filter 5GHz	Micro-Tronics	LPS17541	009	08-07-19
Low Pass Filter 5GHz	Micro-Tronics	LPS17541	015	08-07-19
Low Pass Filter 5GHz	Micro-Tronics	LPS17541	020	08-06-19
High Pass Filter 3GHz	Micro-Tronics	HPM17543	010	08-07-19
High Pass Filter 3GHz	Micro-Tronics	HPM17543	015	08-07-19
High Pass Filter 3GHz	Micro-Tronics	HPM17543	020	08-06-19
High Pass Filter 6GHz	Micro-Tronics	HPS17542	009	08-07-19
High Pass Filter 6GHz	Micro-Tronics	HPS17542	016	08-07-19
High Pass Filter 6GHz	Micro-Tronics	HPS17542	021	08-06-19
Antenna, Loop, 9kHz-30MHz	R&S	HFH2-Z2	100418	10-26-19
LISN	R&S	ENV-216	101837	08-09-19
UL Software				
Description	Manufacturer	Model	Version	
Radiated software	UL	UL EMC	Ver 9.5	
AC Line Conducted software	UL	UL EMC	Ver 9.5	

7. REFERENCE MEASUREMENT RESULTS

7.1. ON TIME AND DUTY CYCLE RESULTS

LIMITS

None; for reporting purposes only.

Mode	ON Time B [msec]	Period [msec]	Duty Cycle x [linear]	Duty Cycle [%]	Duty Cycle Correction Factor [dB]	1/T Minimum VBW [kHz]
2400MHz Bands						
802.11b	8.608	8.640	0.996	99.6%	0.00	0.116
802.11g	2.064	2.159	0.956	95.6%	0.20	0.484
802.11n HT20	1.920	1.995	0.962	96.2%	0.17	0.521

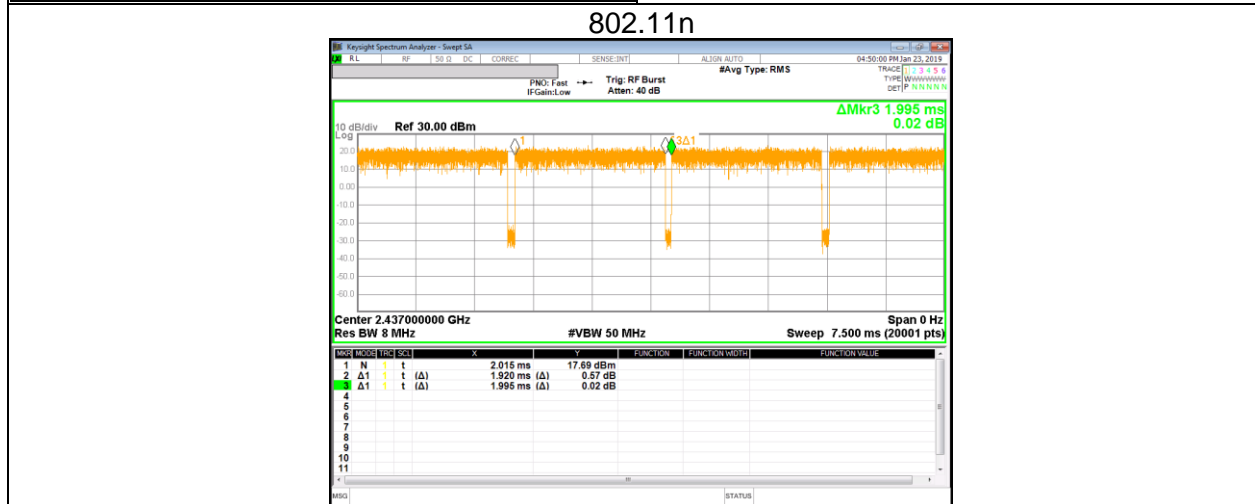

7.1. 99% BANDWIDTH

LIMITS

None; for reporting purposes only.

RESULTS

7.1.1. 802.11b MODE IN THE 2.4 GHz BAND

Channel	Frequency [MHz]	99% Bandwidth [MHz]
1	2412	12.868
6	2437	12.968
11	2462	12.914
12	2467	12.897
13	2472	13.093
Worst		13.093

7.1.2. 802.11g MODE IN THE 2.4 GHz BAND

Channel	Frequency [MHz]	99% Bandwidth [MHz]
1	2412	16.465
6	2437	16.547
11	2462	16.487
12	2467	16.445
13	2472	16.463
Worst		16.547

7.1.3. 802.11n HT20 MODE IN THE 2.4 GHz BAND

Channel	Frequency [MHz]	99% Bandwidth [MHz]
1	2412	17.541
6	2437	17.619
10	2457	17.546
11	2462	17.527
12	2467	17.574
13	2472	17.539
Worst		17.619

7.1.4. 99% BANDWIDTH PLOTS

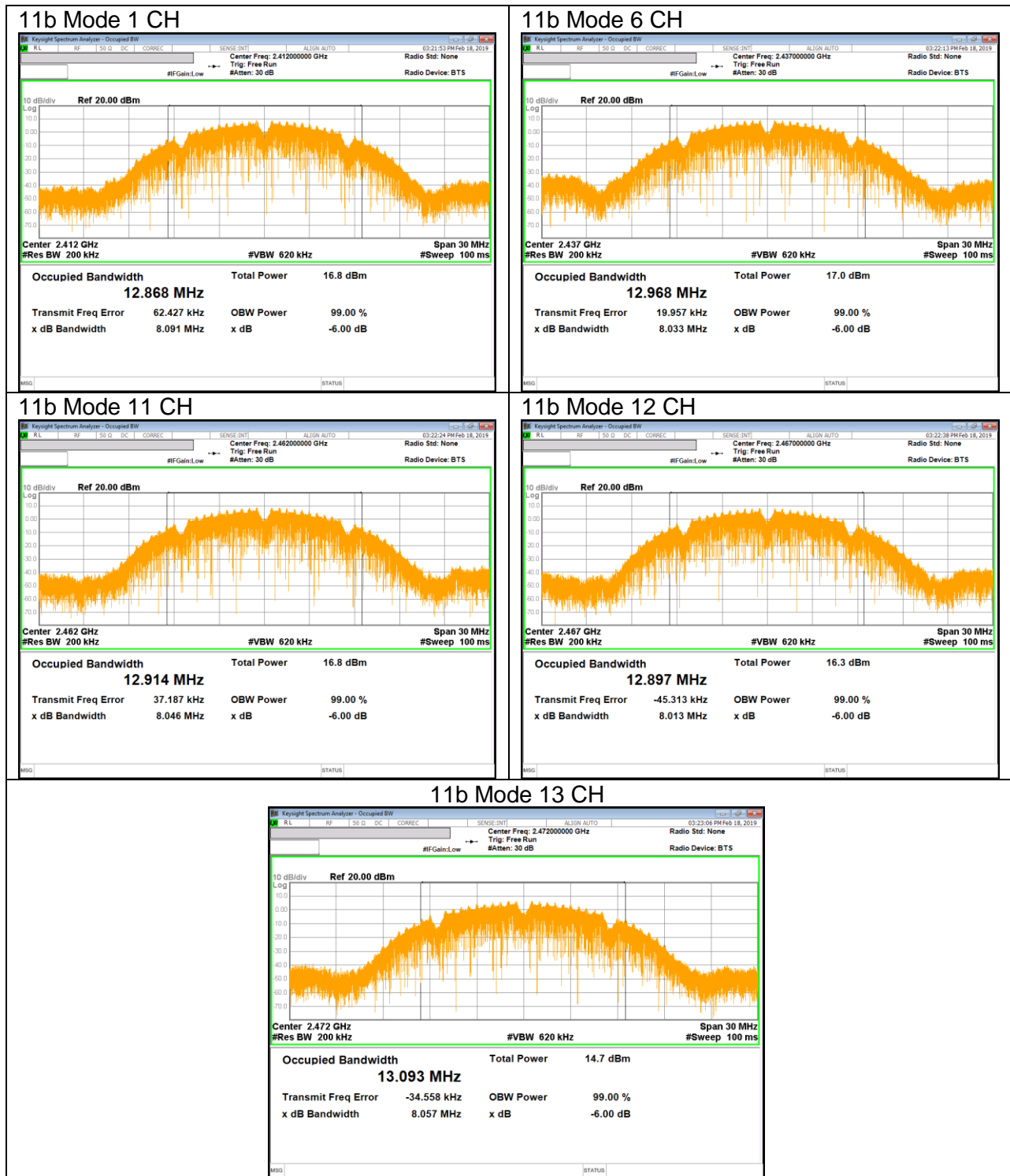

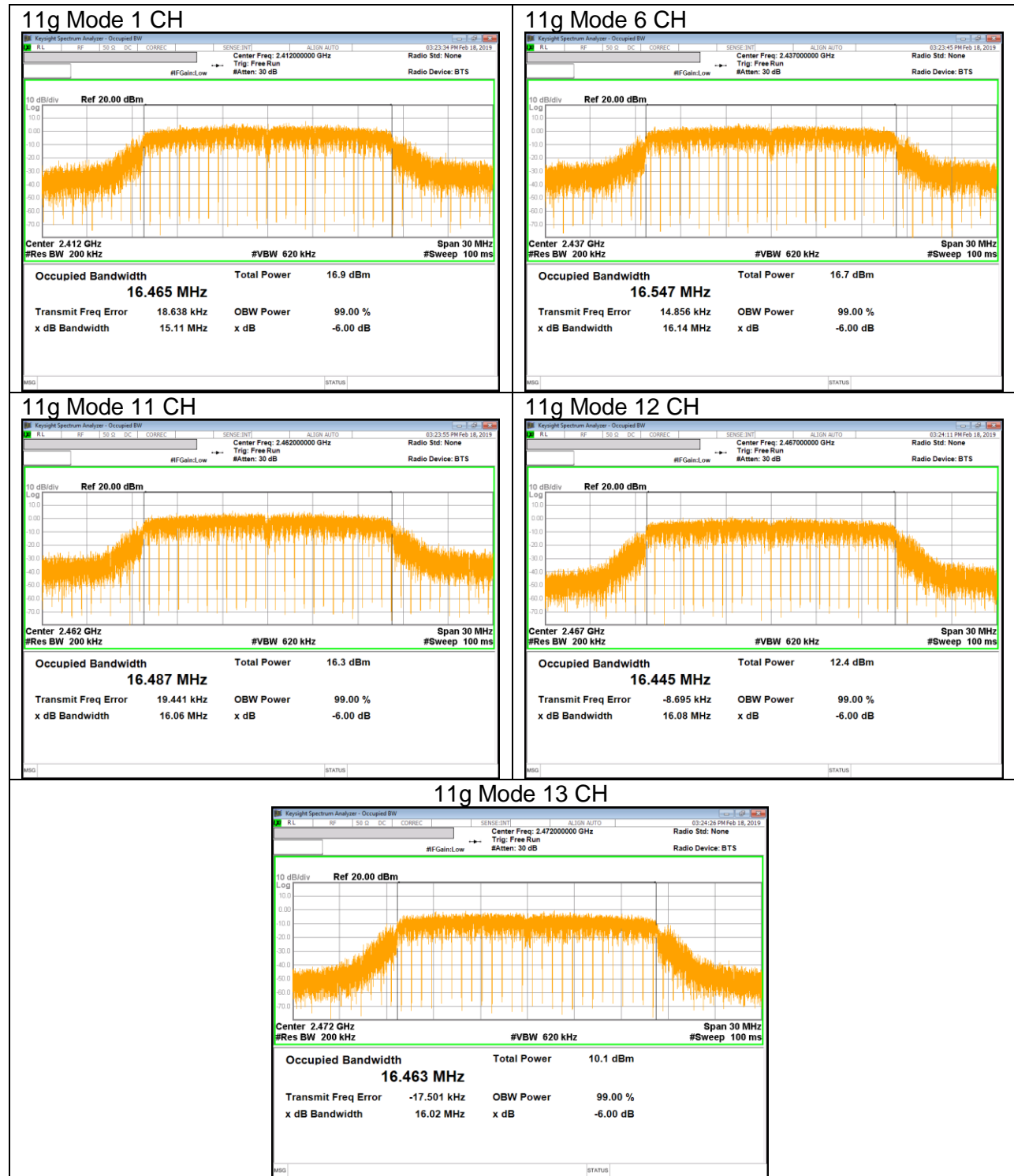

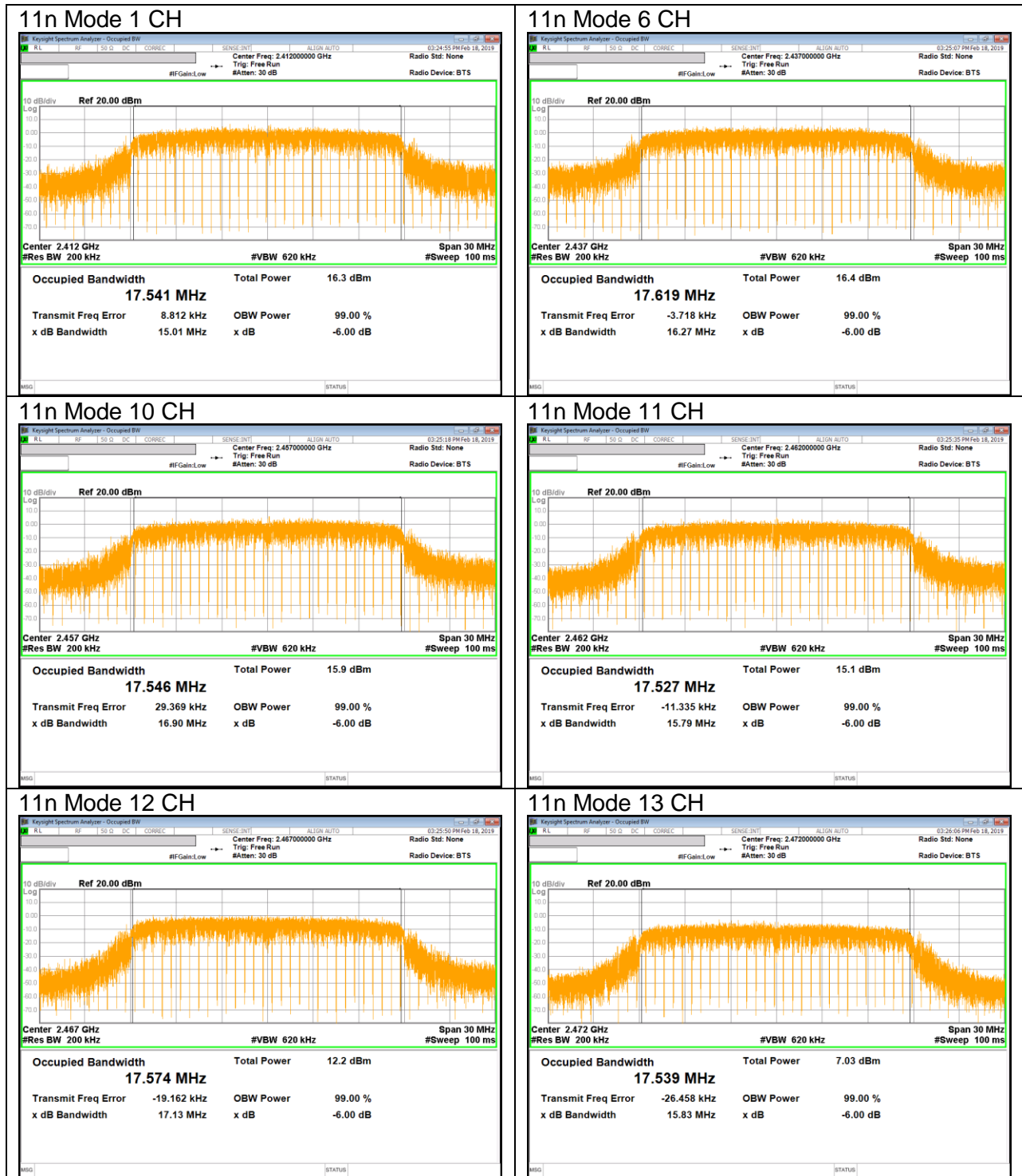

8. MEASUREMENT METHODS

6 dB BW : KDB 558074 D01 v05r01, Section 8.2.

OUTPUT POWER : KDB 558074 D01 v05r01, Section 8.3.2.3.

POWER SPECTRAL DENSITY : KDB 558074 D01 v05r01, Section 8.4.

Out-of-band Emissions (Conducted) : KDB 558074 D01 v05r01, Section 8.5, 8.7.

Out-of-band Emissions in Non-restricted Bands: KDB 558074 D01 v05r01, Section 8.5.

Out-of-band Emissions in Restricted Bands : KDB 558074 D01 v05r01, Section 8.6.

AC Power Line Conducted Emission : ANSI C63.10-2013, Section 6.2.

9. SUMMARY TABLE

FCC Part Section	Test Description	Test Limit	Test Condition	Test Result
15.247 (a)(2)	Occupied Band width (6dB)	>500KHz	Conducted	Pass
2.1051, 15.247 (d)	Band Edge / Conducted Spurious Emission	-30dBc		Pass
15.247 (b)(3)	TX conducted output power	<30dBm		Pass
15.247 (e)	PSD	<8dBm		Pass
15.207 (a)	AC Power Line conducted emissions	Section 10	Power Line conducted	Pass
15.205, 15.209	Radiated Spurious Emission	< 54dBuV/m	Radiated	Pass

10. ANTENNA PORT TEST RESULTS

10.1. 6 dB BANDWIDTH

LIMITS

FCC §15.247 (a) (2)

The minimum 6 dB bandwidth shall be at least 500 kHz.

TEST PROCEDURE

Reference to section 11.8 in ANSI C63.10(2013): The transmitter output is connected to a spectrum analyzer with the RBW set to 100KHz, the VBW $\geq 3 \times$ RBW, peak detector and max hold.

RESULTS

10.1.1.802.11b MODE IN THE 2.4 GHz BAND

Channel	Frequency [MHz]	6 dB Bandwidth [MHz]	Minimum Limit [MHz]
1	2412	8.046	0.5
6	2437	7.520	0.5
11	2462	8.068	0.5
12	2467	8.494	0.5
13	2472	8.065	0.5
Worst		7.520	0.5

10.1.1.1. 802.11g MODE IN THE 2.4 GHz BAND

Channel	Frequency [MHz]	6 dB Bandwidth [MHz]	Minimum Limit [MHz]
1	2412	15.430	0.5
6	2437	15.790	0.5
11	2462	15.330	0.5
12	2467	15.770	0.5
13	2472	15.650	0.5
Worst		15.330	0.5

10.1.2.802.11n HT20 MODE IN THE 2.4 GHz BAND

Channel	Frequency [MHz]	6 dB Bandwidth [MHz]	Minimum Limit [MHz]
1	2412	15.110	0.5
6	2437	15.780	0.5
10	2457	15.070	0.5
11	2462	15.330	0.5
12	2467	15.290	0.5
13	2472	15.460	0.5
Worst		15.070	0.5

10.1.3. 6 dB BANDWIDTH PLOTS

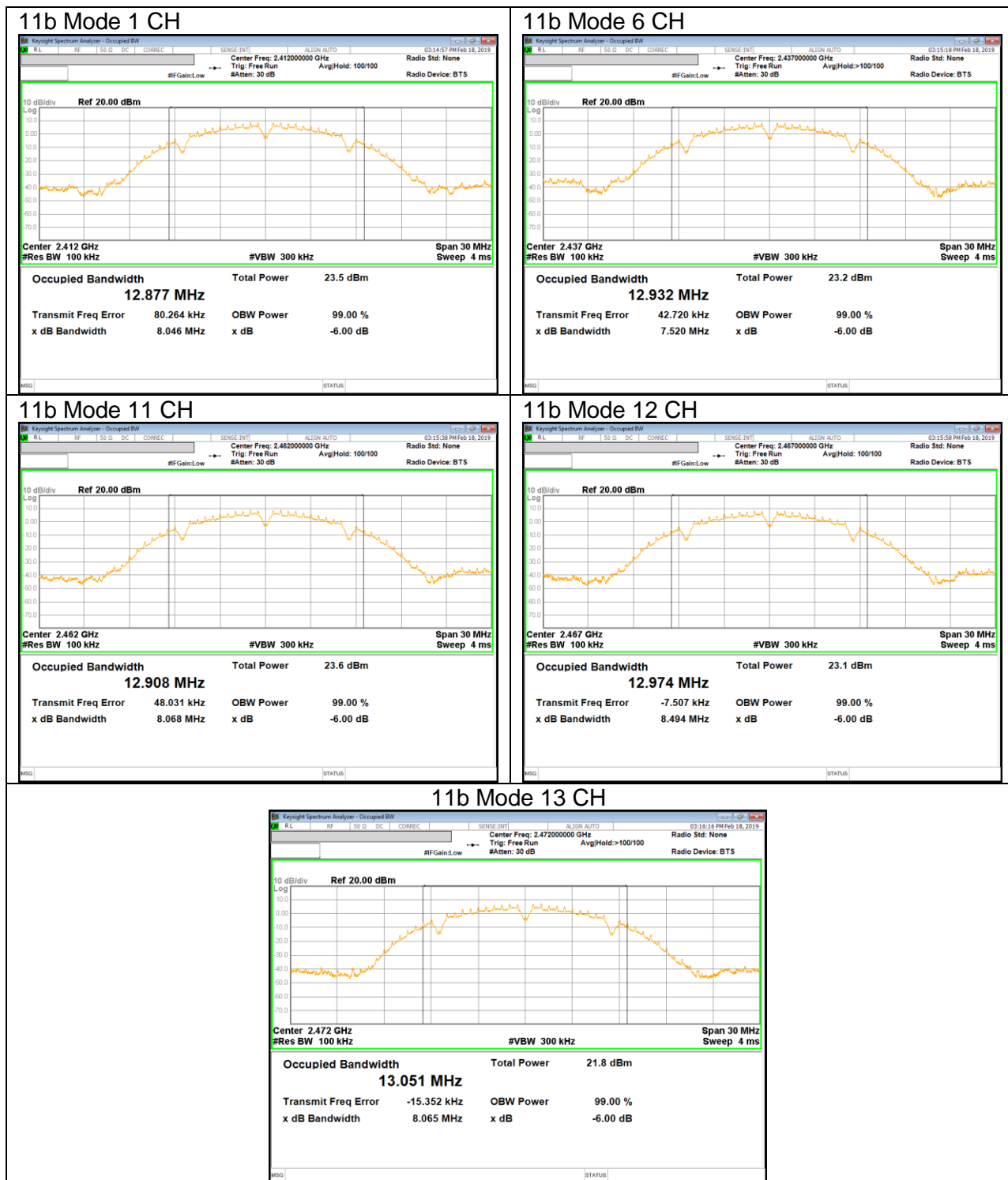



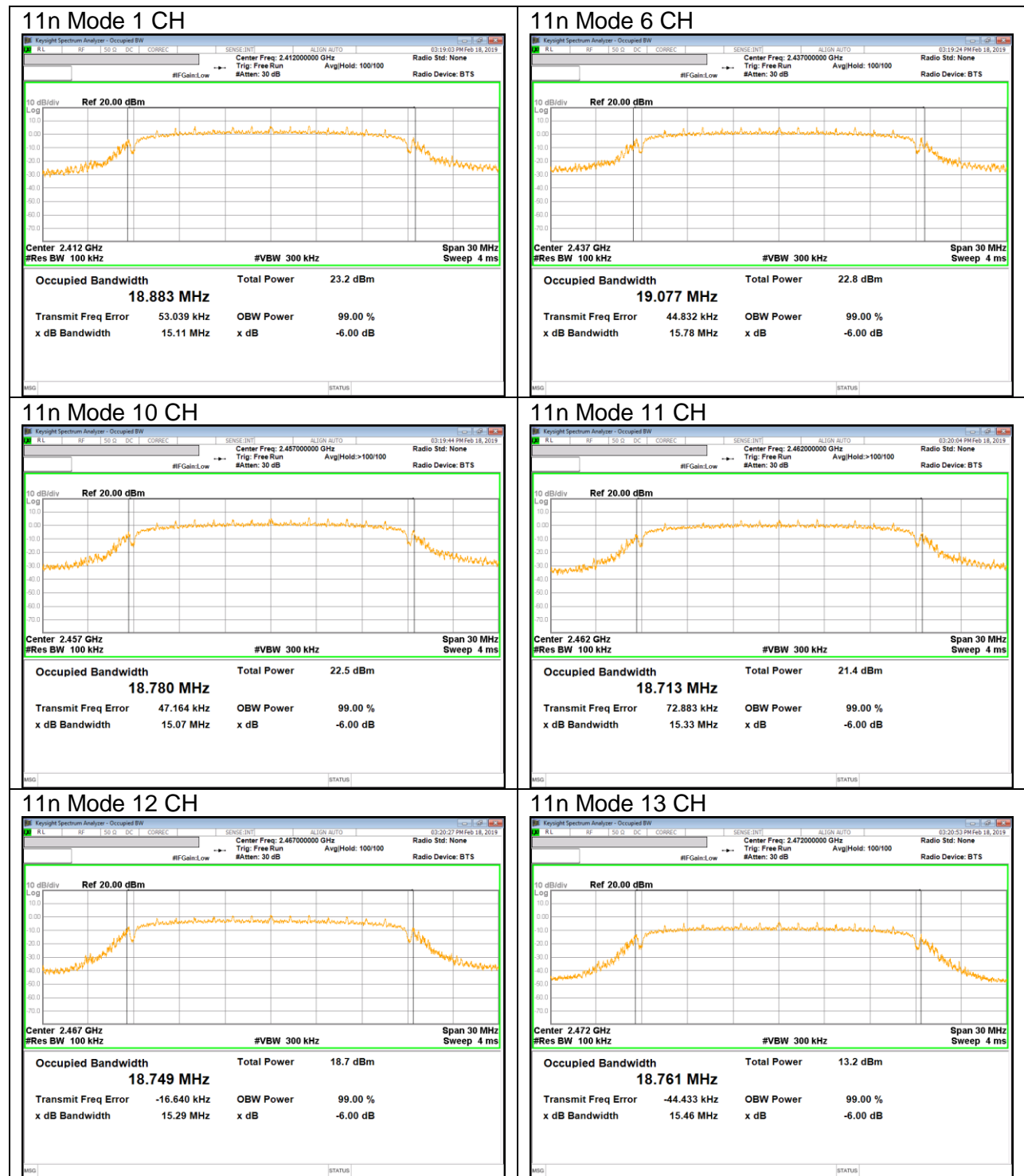

10.2. OUTPUT POWER

LIMITS

FCC §15.247

For systems using digital modulation in the 902–928 MHz, 2400–2483.5 MHz, and 5725–5850 MHz bands: 1 Watt, based on the use of antennas with directional gains that do not exceed 6 dBi. If transmitting antennas of directional gain greater than 6 dBi are used, the conducted output power from the intentional radiator shall be reduced by the amount in dB that the directional gain of the antenna exceeds 6 dBi.

DIRECTIONAL ANTENNA GAIN

There is only one transmitter output therefore the directional gain is equal to the antenna gain.

TEST PROCEDURE

The transmitter output is connected to a power meter.

The cable assembly insertion loss was entered as an offset in the power meter to allow for direct reading of power.

Output power measurement was performed utilizing the “§11.9.2.3.1 Method AVGPM” under ANSI C63.10(2013).

Duty cycle correction factor is not added to the average output power results for duty cycle factor > 98%. (802.11b mode)

Duty cycle correction factor is already added to the average output power results for duty cycle factor < 98%. (802.11g, 802.11n mode)

RESULTS

10.2.1.802.11b MODE IN THE 2.4 GHz BAND

Limits

Channel	Frequency [MHz]	Directional Gain Primary [dBi]	FCC Power Limit [dBm]	Max Power [dBm]
1	2412	-0.53	30.00	30.00
6	2437		30.00	30.00
11	2462		30.00	30.00
12	2467		30.00	30.00
13	2472		30.00	30.00

Results

Channel	Frequency [MHz]	Meas Power [dBm]	Total Power [dBm]	Power Limit [dBm]	Margin [dB]
1	2412	16.80	16.80	30.00	-13.20
6	2437	17.15	17.15	30.00	-12.85
11	2462	17.16	17.16	30.00	-12.84
12	2467	16.51	16.51	30.00	-13.49
13	2472	15.63	15.63	30.00	-14.37
Worst			17.16	30.00	-12.84

10.2.2.802.11g MODE IN THE 2.4 GHz BAND

Limits

Channel	Frequency [MHz]	Directional Gain Primary [dBi]	FCC Power Limit [dBm]	Max Power [dBm]
1	2412	-0.53	30.00	30.00
6	2437		30.00	30.00
11	2462		30.00	30.00
12	2467		30.00	30.00
13	2472		30.00	30.00

Results

Channel	Frequency [MHz]	Meas Power [dBm]	Total Power [dBm]	Power Limit [dBm]	Margin [dB]
1	2412	16.15	16.15	30.00	-13.85
6	2437	15.85	15.85	30.00	-14.15
11	2462	15.60	15.60	30.00	-14.40
12	2467	11.93	11.93	30.00	-18.07
13	2472	9.75	9.75	30.00	-20.25
Worst			16.15	30.00	-13.85

10.2.3.802.11n HT20 MODE IN THE 2.4 GHz BAND

Limits

Channel	Frequency [MHz]	Directional Gain Primary [dBi]	FCC Power Limit [dBm]	Max Power [dBm]
1	2412	-0.53	30.00	30.00
6	2437		30.00	30.00
10	2457		30.00	30.00
11	2462		30.00	30.00
12	2467		30.00	30.00
13	2472		30.00	30.00

Results

Channel	Frequency [MHz]	Meas Power [dBm]	Total Power [dBm]	Power Limit [dBm]	Margin [dB]
1	2412	16.01	16.01	30.00	-13.99
6	2437	15.65	15.65	30.00	-14.35
10	2457	15.70	15.70	30.00	-14.30
11	2462	14.76	14.76	30.00	-15.24
12	2467	11.73	11.73	30.00	-18.27
13	2472	6.64	6.64	30.00	-23.36
Worst			16.01	30.00	-13.99

10.3. PSD

LIMITS

FCC §15.247

The power spectral density conducted from the transmitter to the antenna shall not be greater than 8 dBm in any 3 kHz band during any time interval of continuous transmission.

TEST PROCEDURE

Power Spectral Density was performed utilizing the "Method § 11.10.3 Method AVGPS-1 (802.11 b mode) and § 11.10.5 Method AVGPS-2 (802.11 g/n mode) under ANSI C63.10(2013).

RESULTS

10.3.1.802.11b MODE IN THE 2.4 GHZ BAND

PSD Results

Channel	Frequency [MHz]	PSD Meas [dBm]	Duty Factor [dB]	Final PSD [dBm/3kHz]	Limit [dBm/3kHz]	Margin [dB]
1	2412	-13.604	0.00	-13.604	8.00	-21.604
6	2437	-13.474	0.00	-13.474	8.00	-21.474
11	2462	-13.710	0.00	-13.710	8.00	-21.710
12	2467	-14.187	0.00	-14.187	8.00	-22.187
13	2472	-14.955	0.00	-14.955	8.00	-22.955

10.3.2.802.11g MODE IN THE 2.4 GHZ BAND

PSD Results

Channel	Frequency [MHz]	PSD Meas [dBm]	Duty Factor [dB]	Final PSD [dBm/3kHz]	Limit [dBm/3kHz]	Margin [dB]
1	2412	-16.432	0.20	-16.232	8.00	-24.432
6	2437	-16.513	0.20	-16.313	8.00	-24.513
11	2462	-16.745	0.20	-16.545	8.00	-24.745
12	2467	-16.171	0.20	-15.971	8.00	-24.171
13	2472	-14.370	0.20	-14.170	8.00	-22.370

10.3.3.802.11n HT20 MODE IN THE 2.4 GHZ BAND

PSD Results

Channel	Frequency [MHz]	PSD Meas [dBm]	Duty Factor [dB]	Final PSD [dBm/3kHz]	Limit [dBm/3kHz]	Margin [dB]
1	2412	-17.547	0.17	-17.377	8.00	-25.547
6	2437	-17.664	0.17	-17.494	8.00	-25.664
10	2457	-17.648	0.17	-17.478	8.00	-25.648
11	2462	-17.370	0.17	-17.200	8.00	-25.370
12	2467	-18.741	0.17	-18.571	8.00	-26.741
13	2472	-14.505	0.17	-14.335	8.00	-22.505

10.3.4.PSD PLOTS

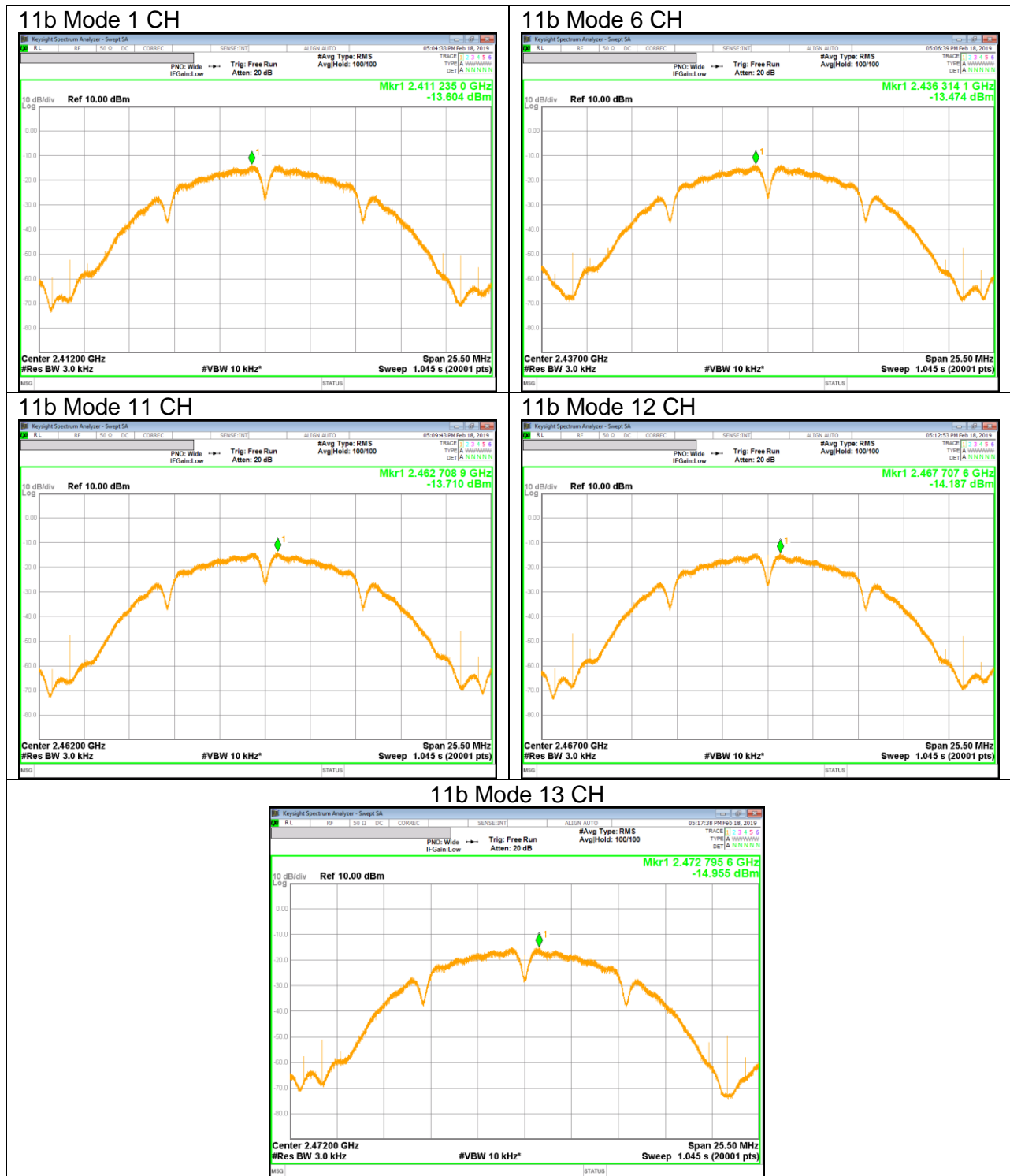

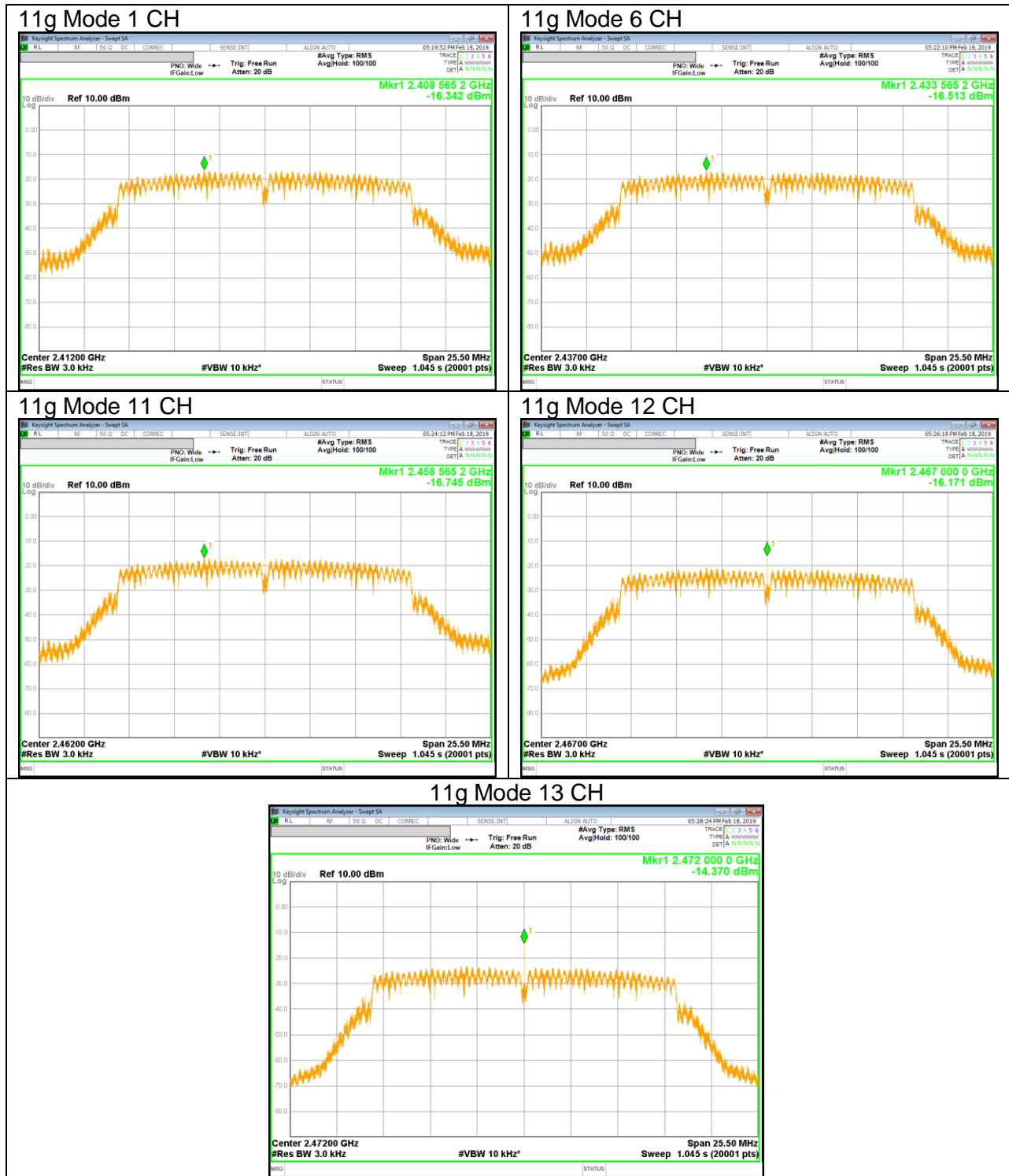

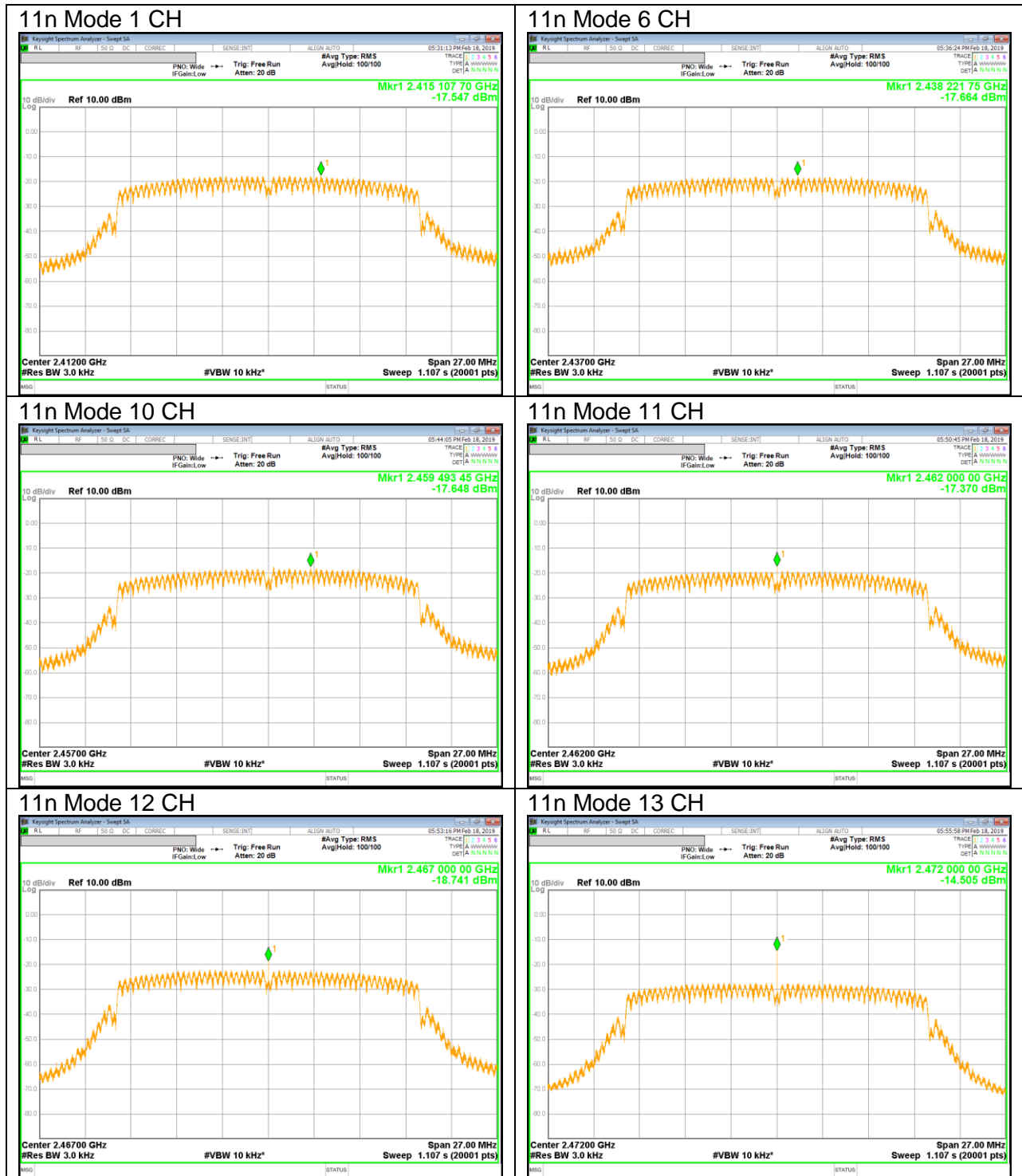

10.4. OUT-OF-BAND EMISSIONS

LIMITS

FCC §15.247 (d)

In any 100 kHz bandwidth outside the frequency band in which the spread spectrum or digitally modulated intentional radiator is operating, the radio frequency power that is produced by the intentional radiator shall be at least 20 dB below that in the 100 kHz bandwidth within the band that contains the highest level of the desired power, based on either an RF conducted or a radiated measurement, provided the transmitter demonstrates compliance with the peak conducted power limits. If the transmitter complies with the conducted power limits based on the use of RMS averaging over a time interval, as permitted under paragraph (b)(3) of this section, the attenuation required under this paragraph shall be 30 dB instead of 20 dB. Attenuation below the general limits specified in §15.209(a) is not required.

TEST PROCEDURE

The transmitter output is connected to a spectrum analyzer with RBW = 100 kHz, VBW = 300 kHz, peak detector, and max hold. Measurements utilizing these settings are made of the in-band reference level, bandedge, out-of-band emissions (where measurements to the general radiated limits will not be made)

RESULTS

10.4.1.802.11b MODE IN THE 2.4 GHz BAND

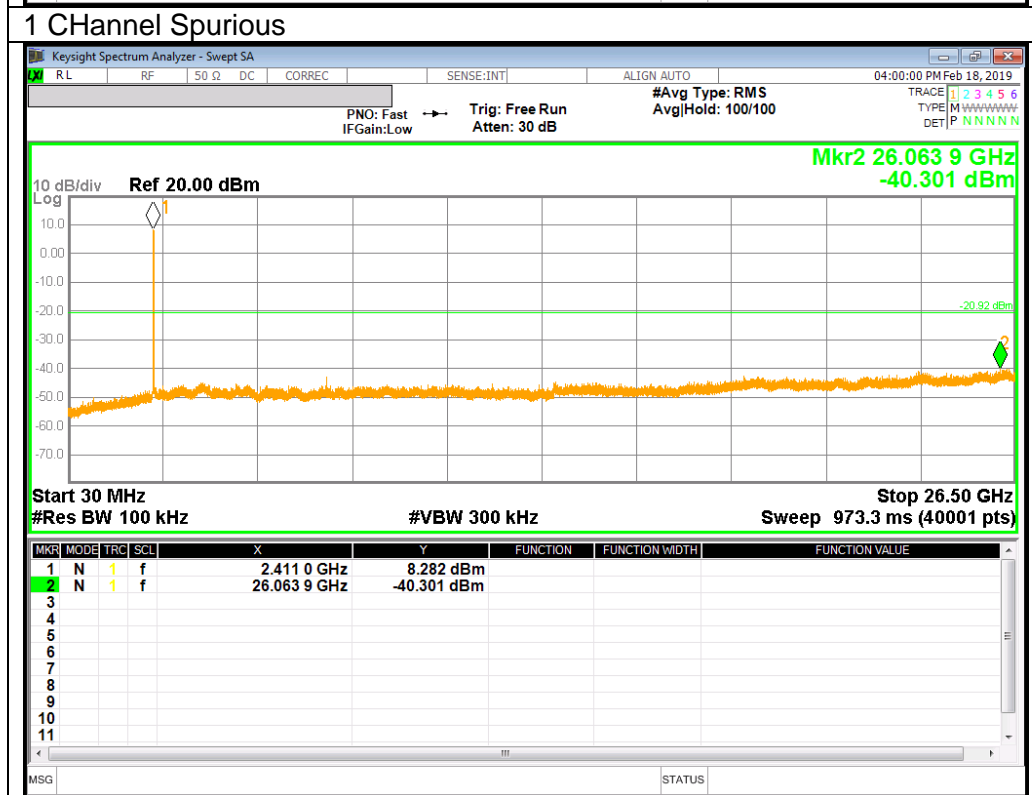
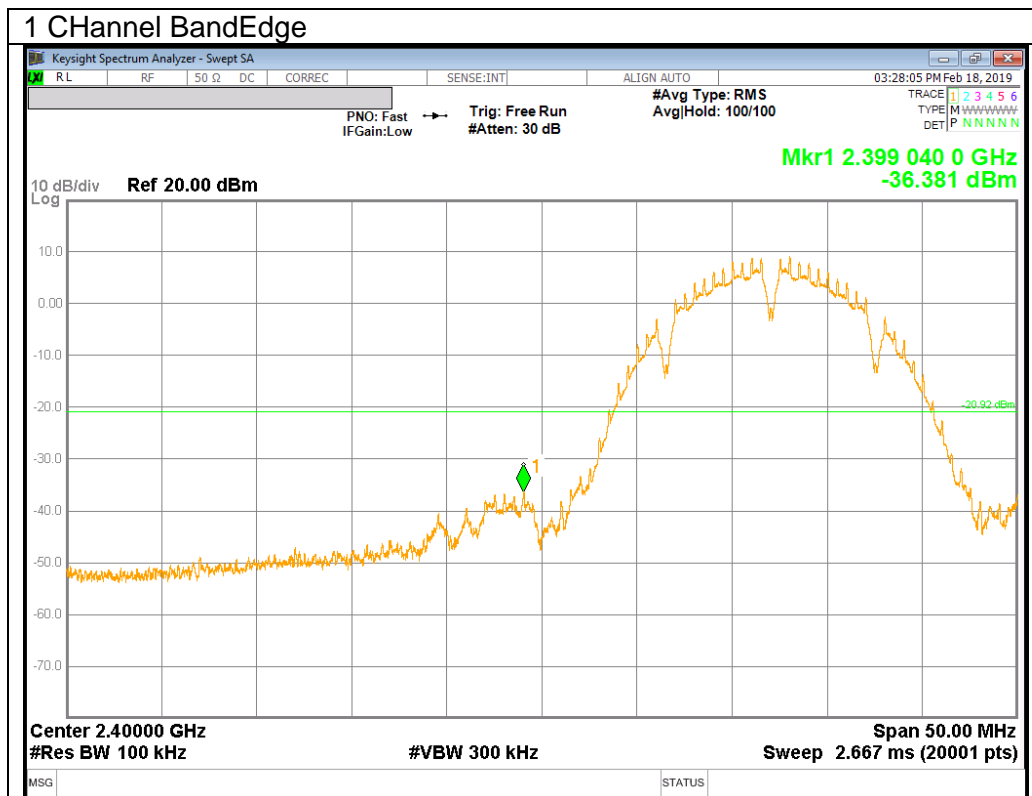

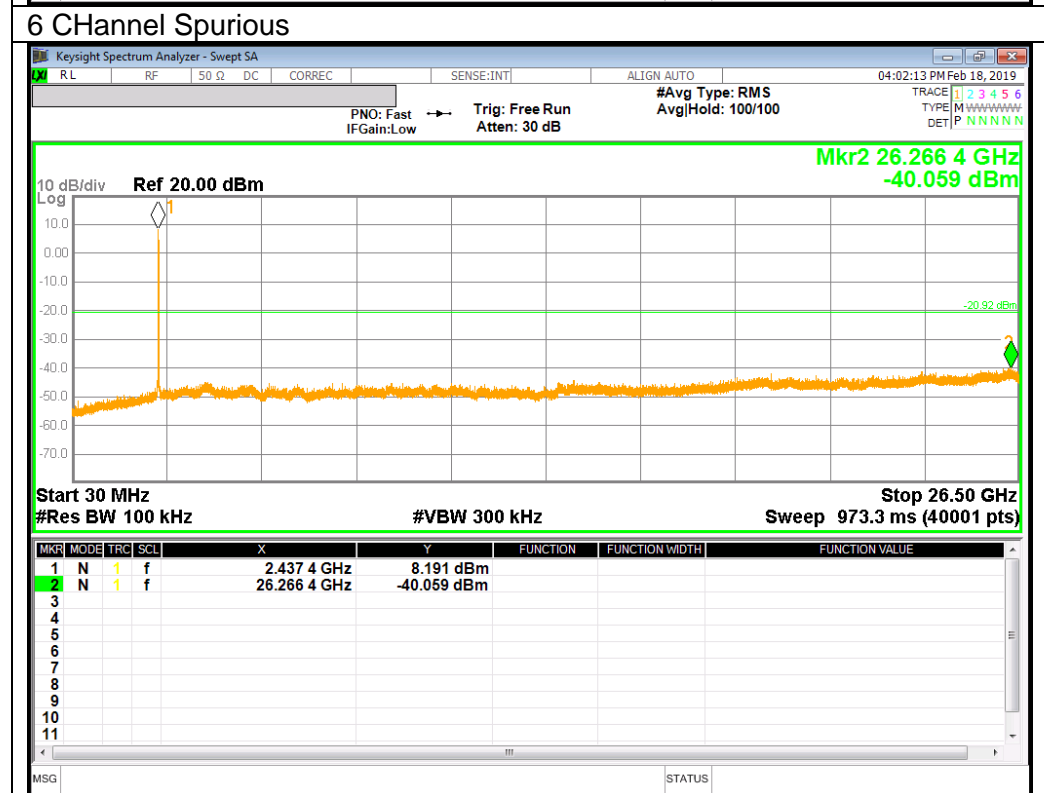
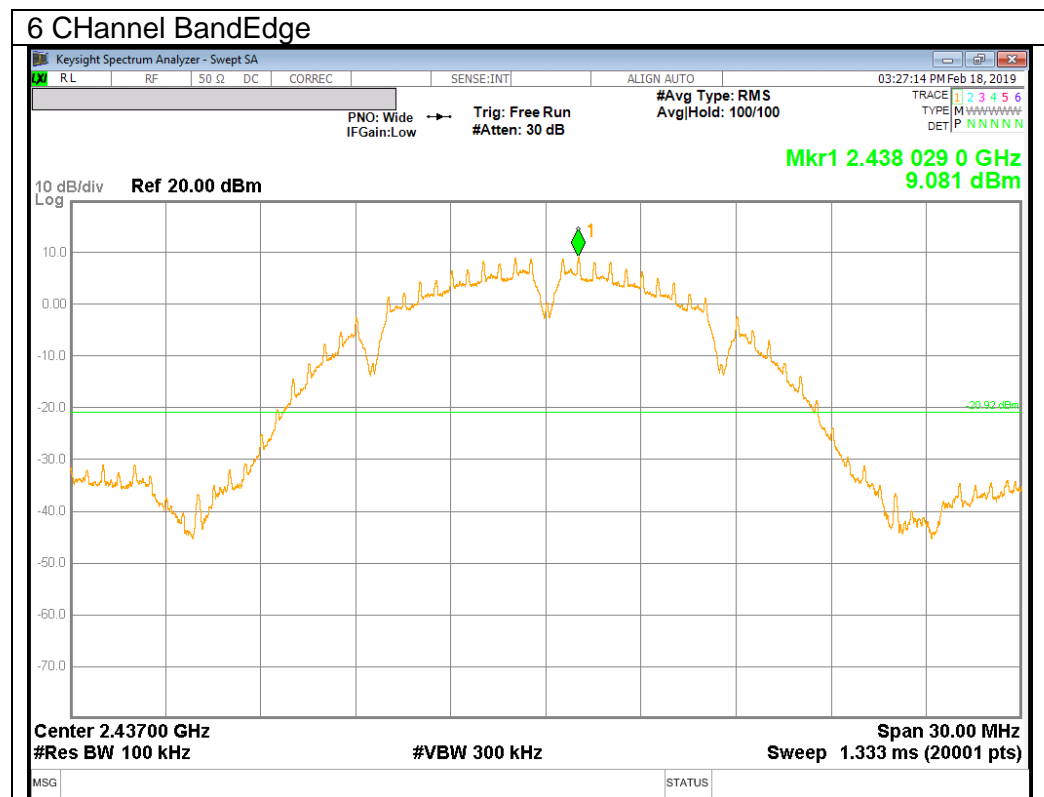

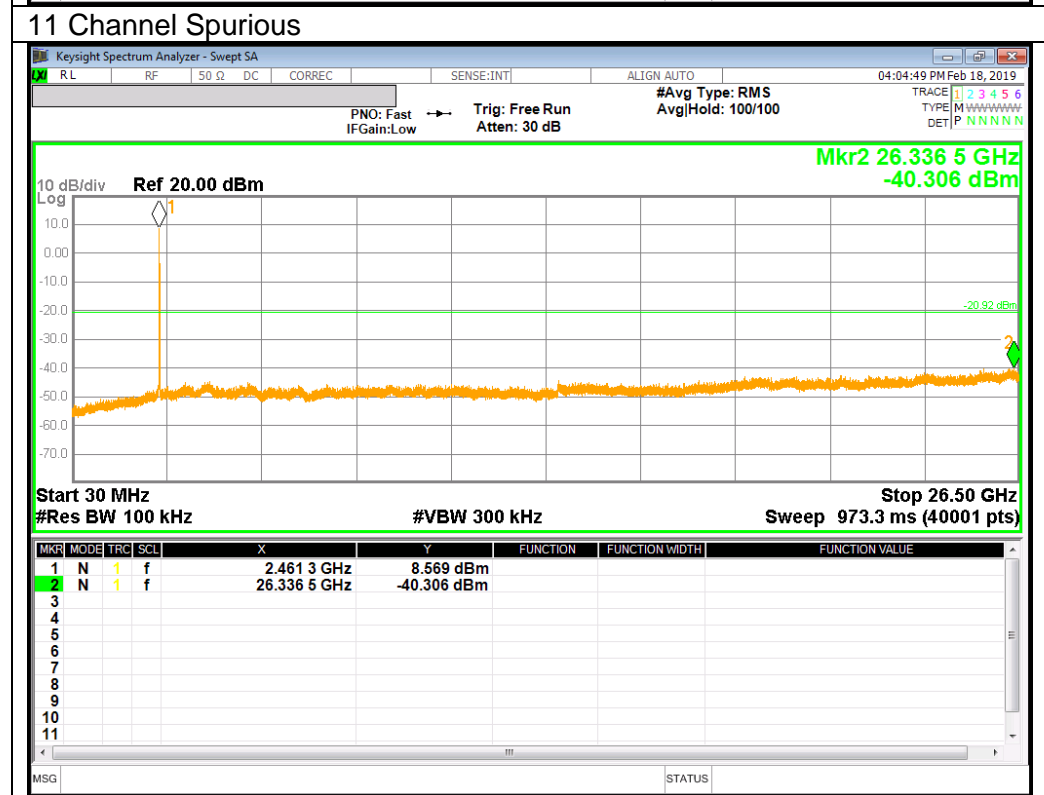
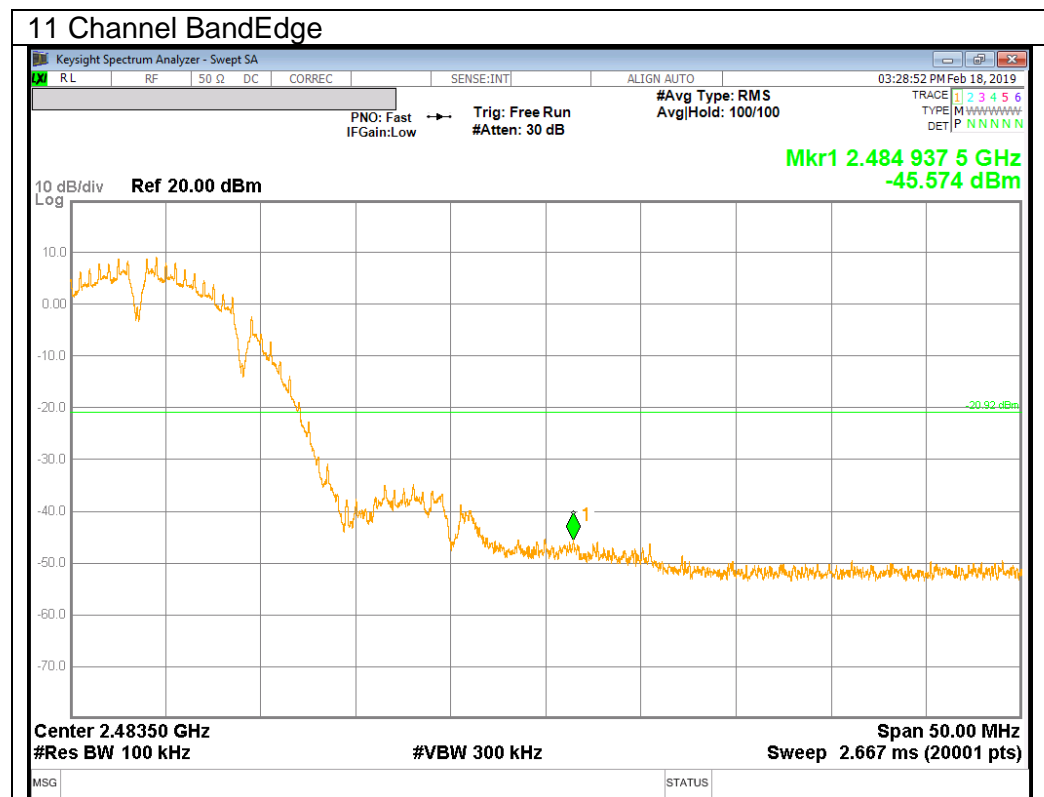

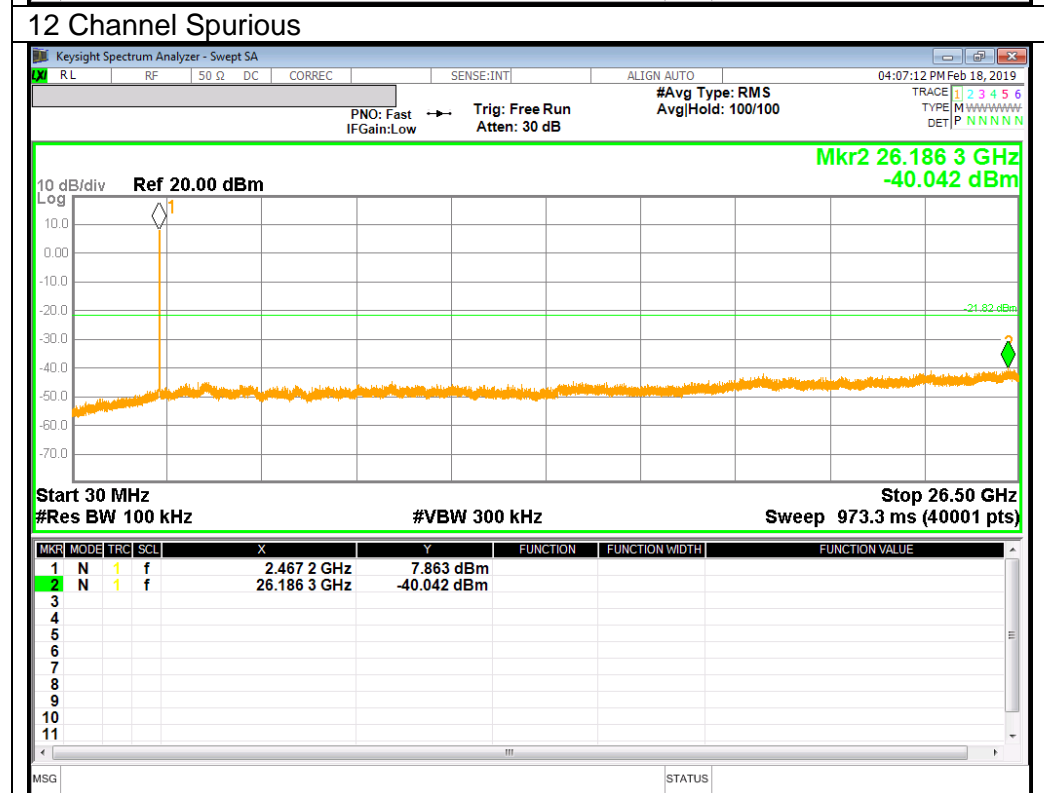
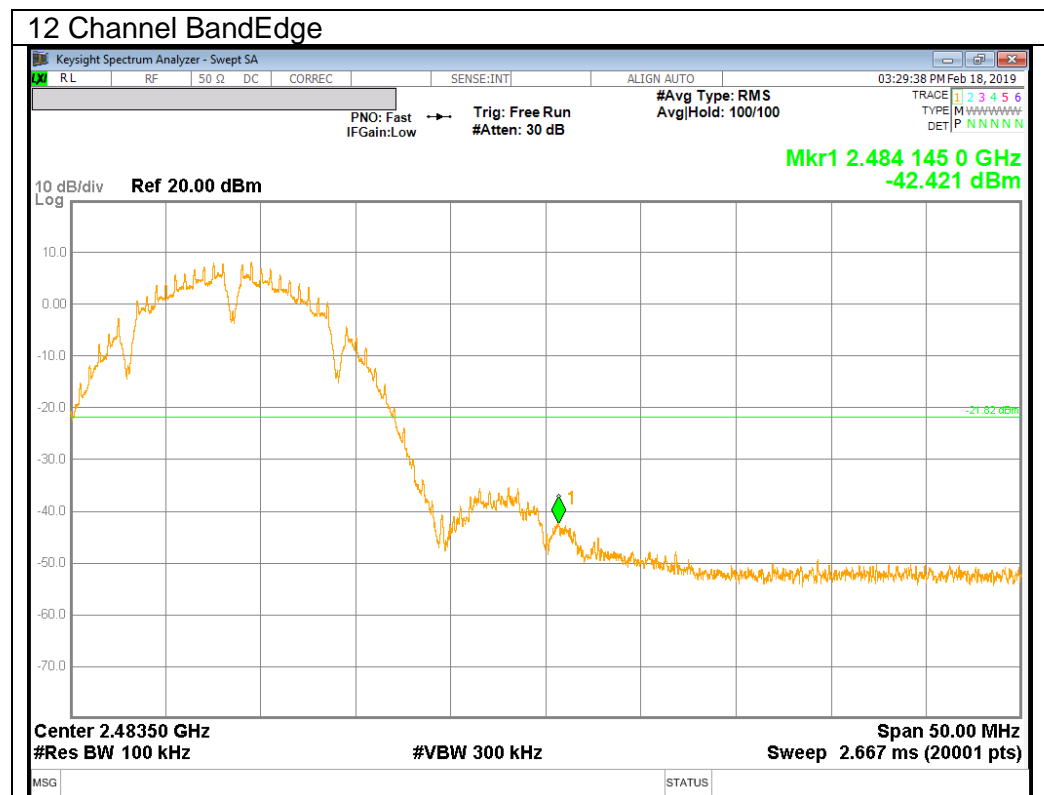

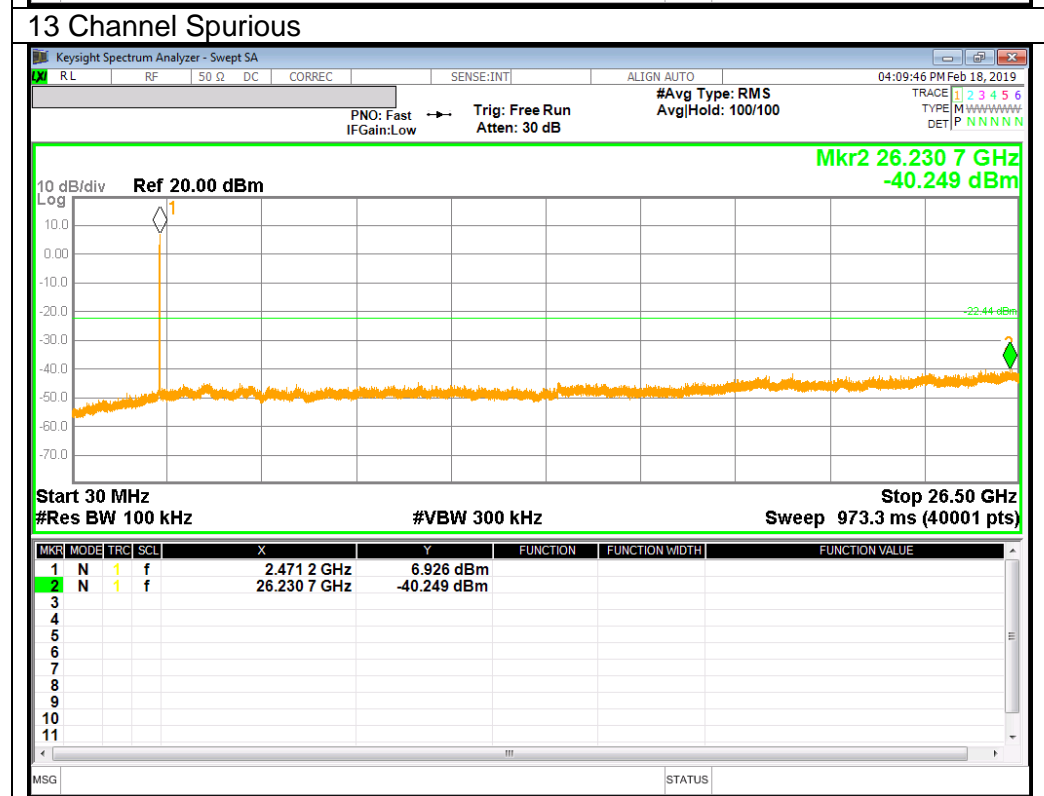
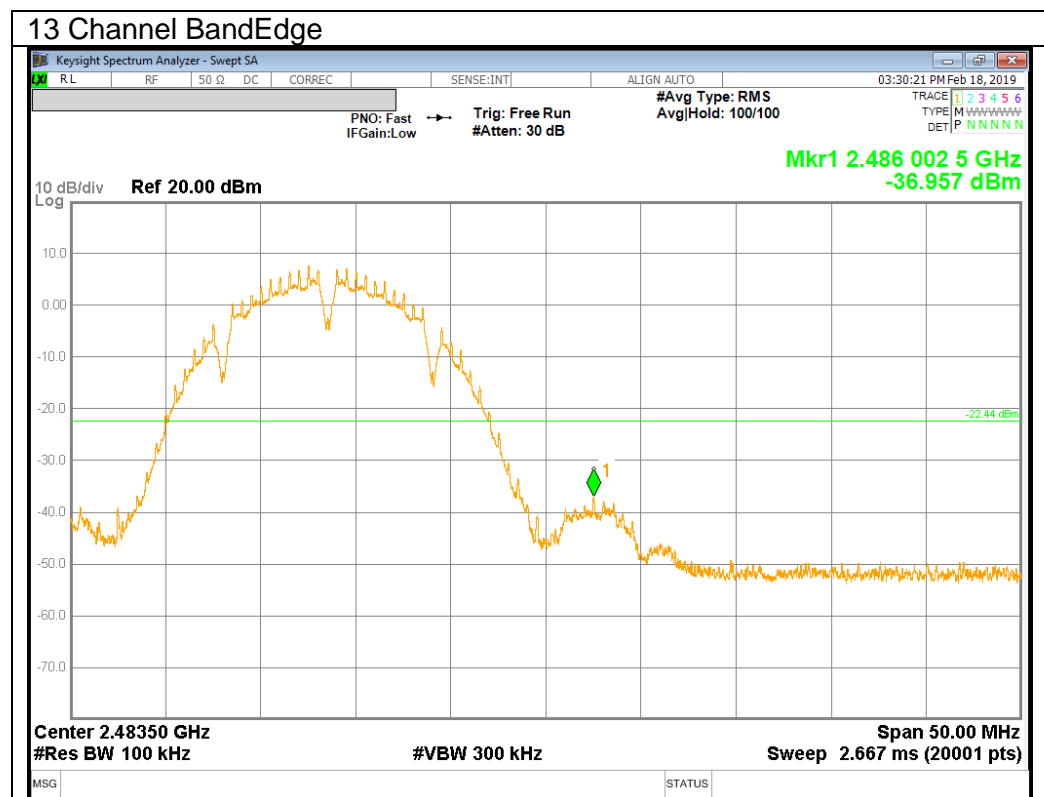

10.4.2.802.11g MODE IN THE 2.4 GHz BAND

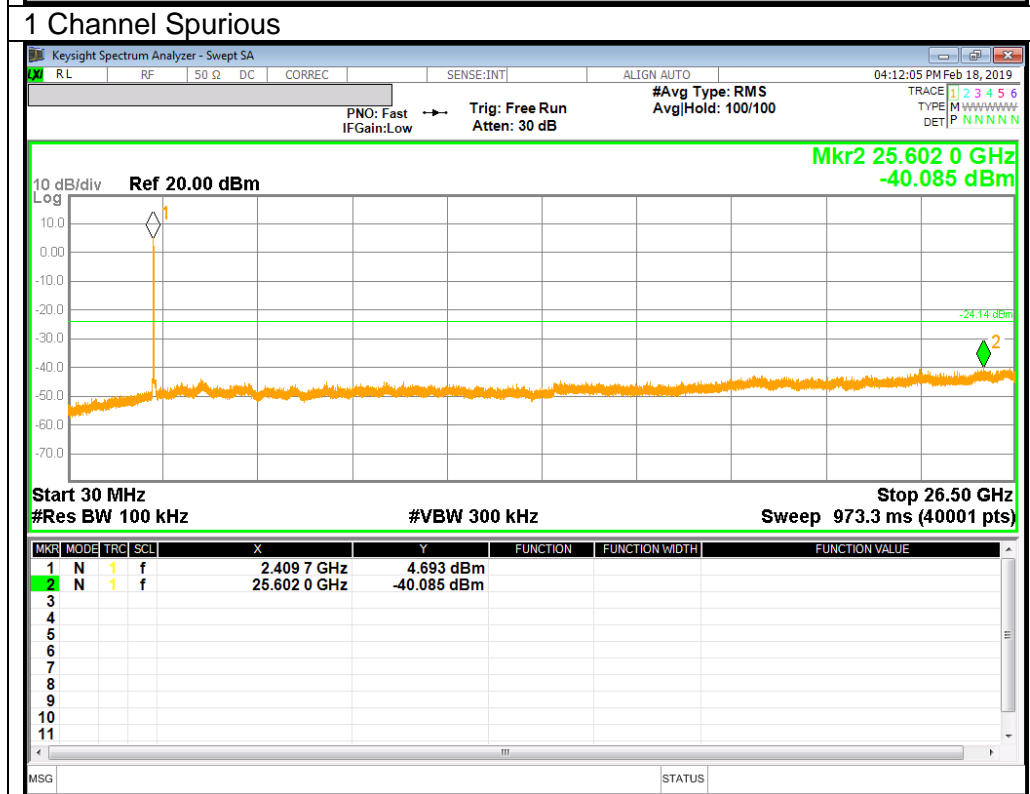
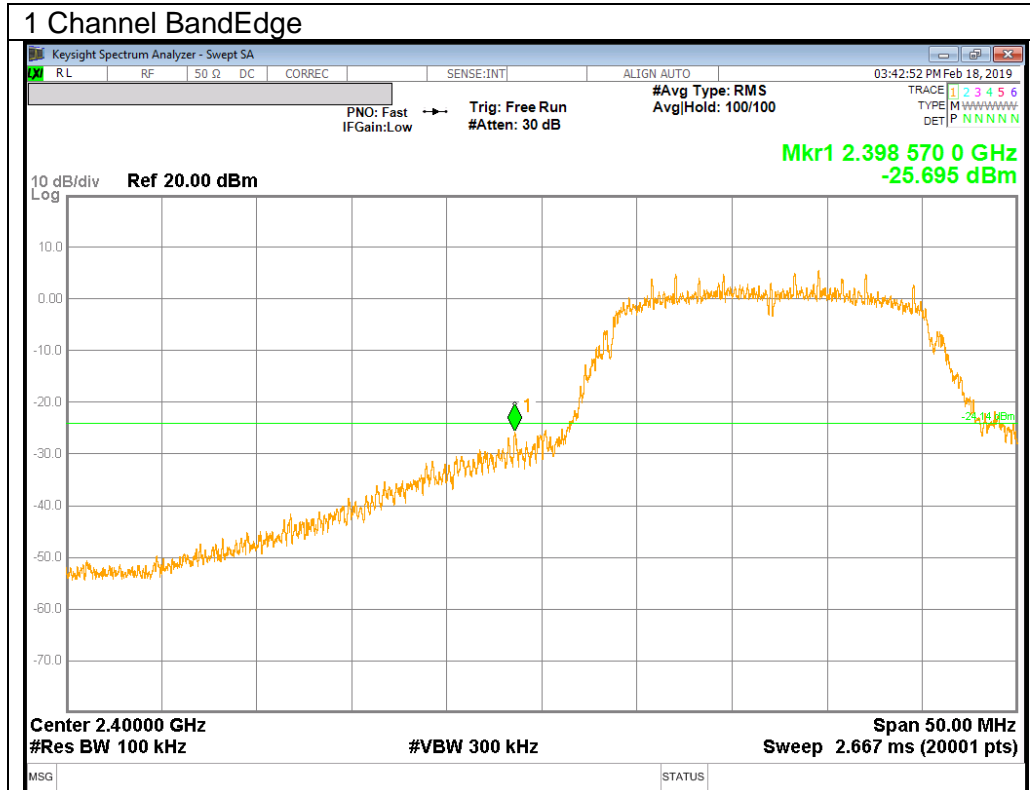

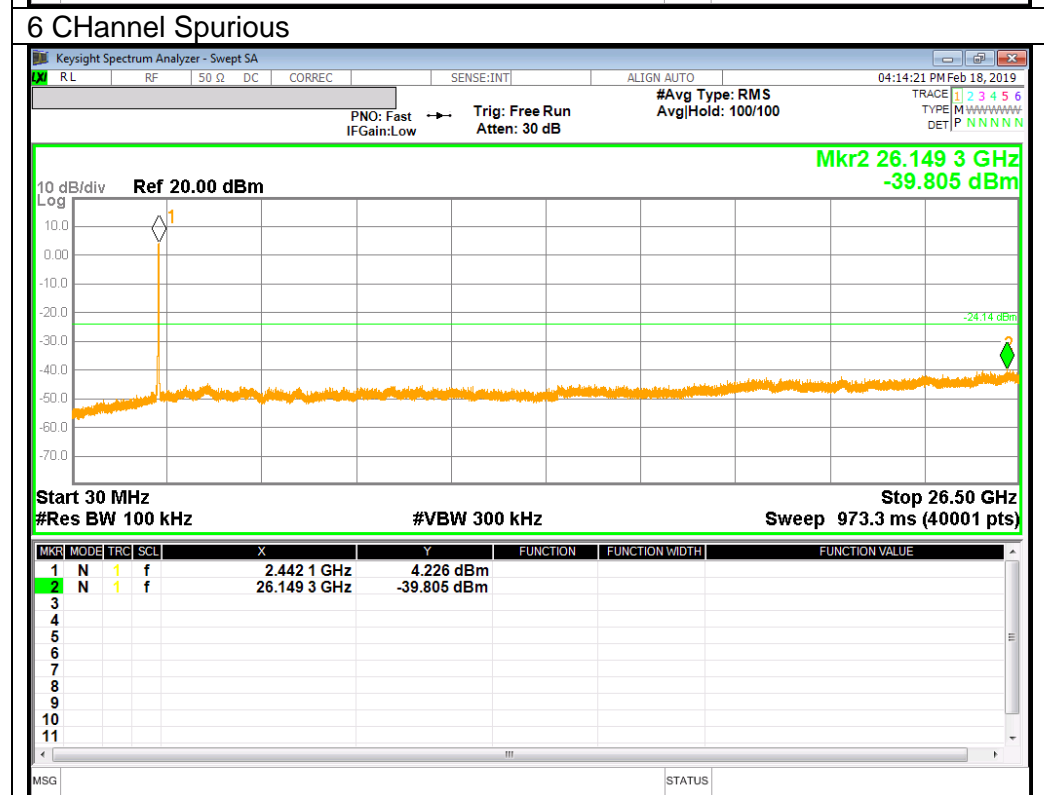
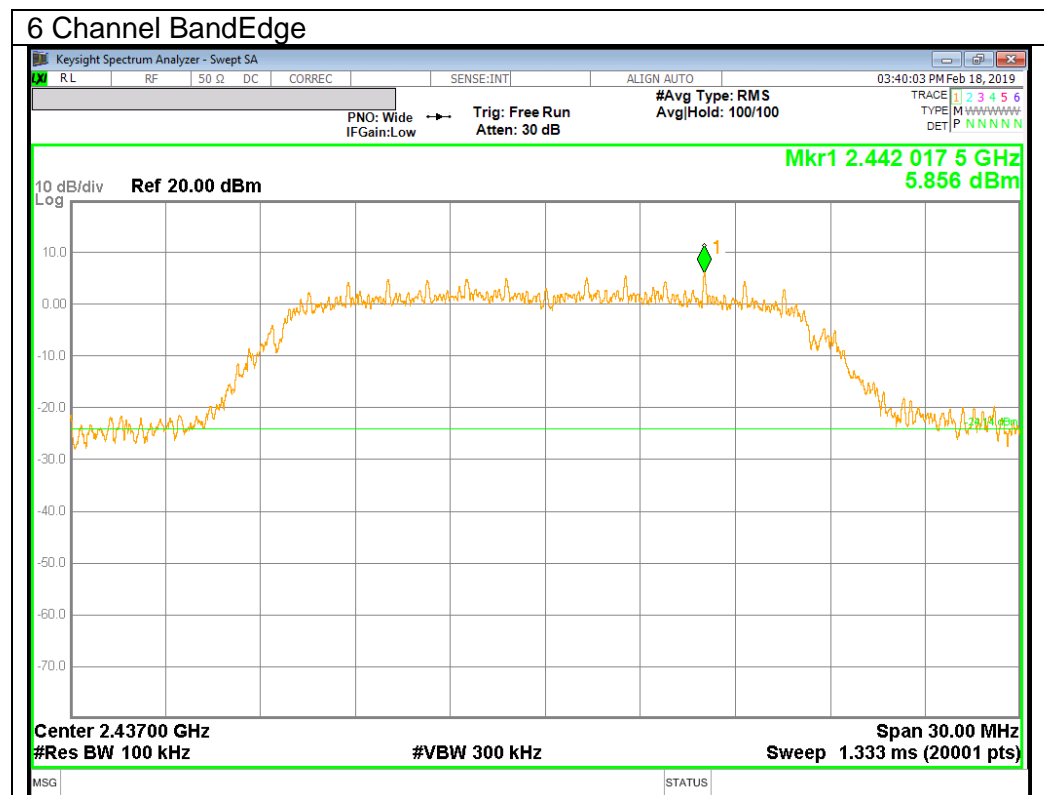

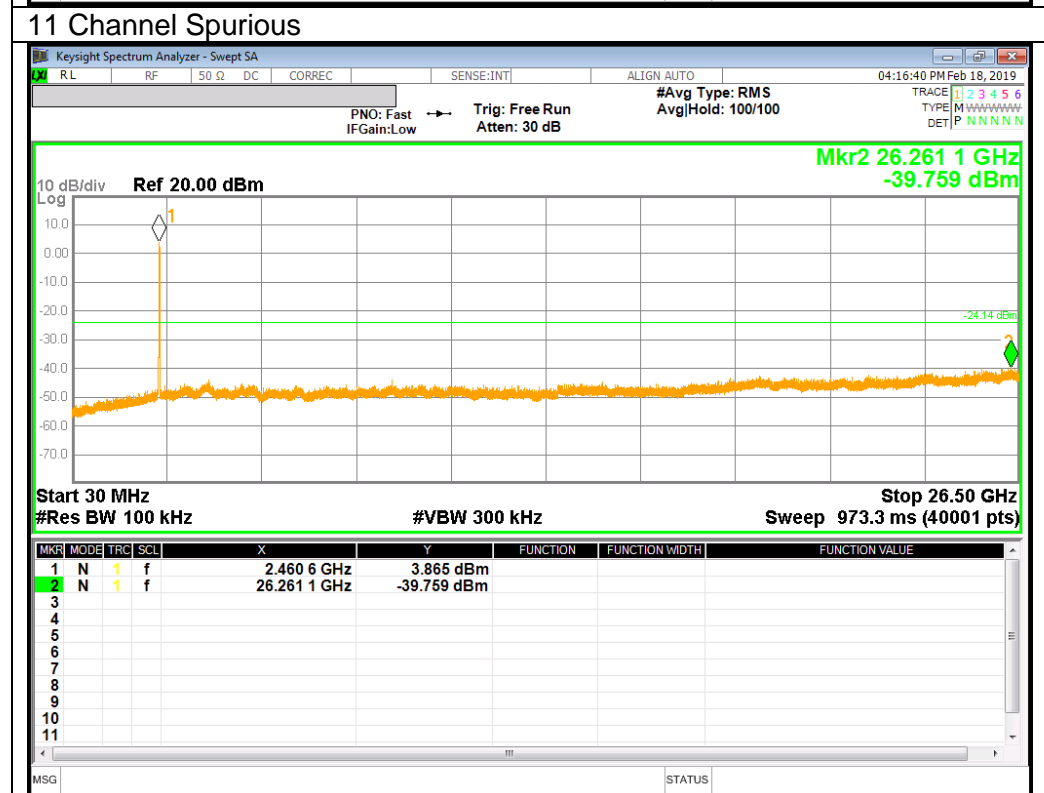
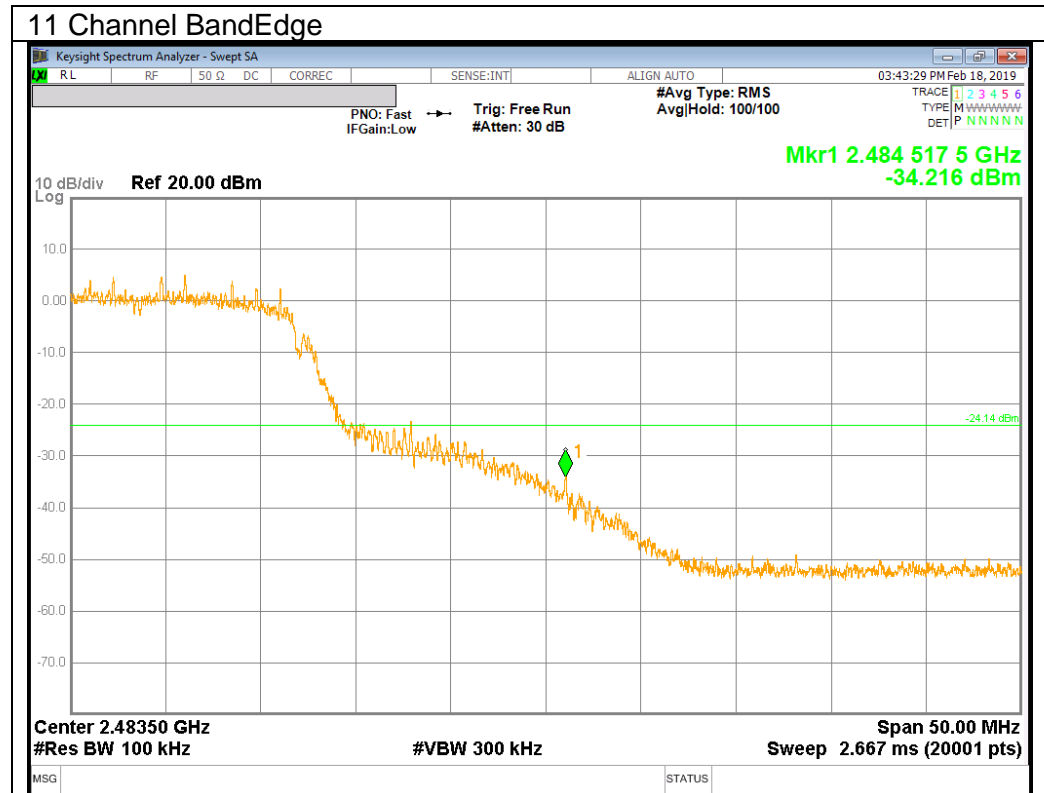

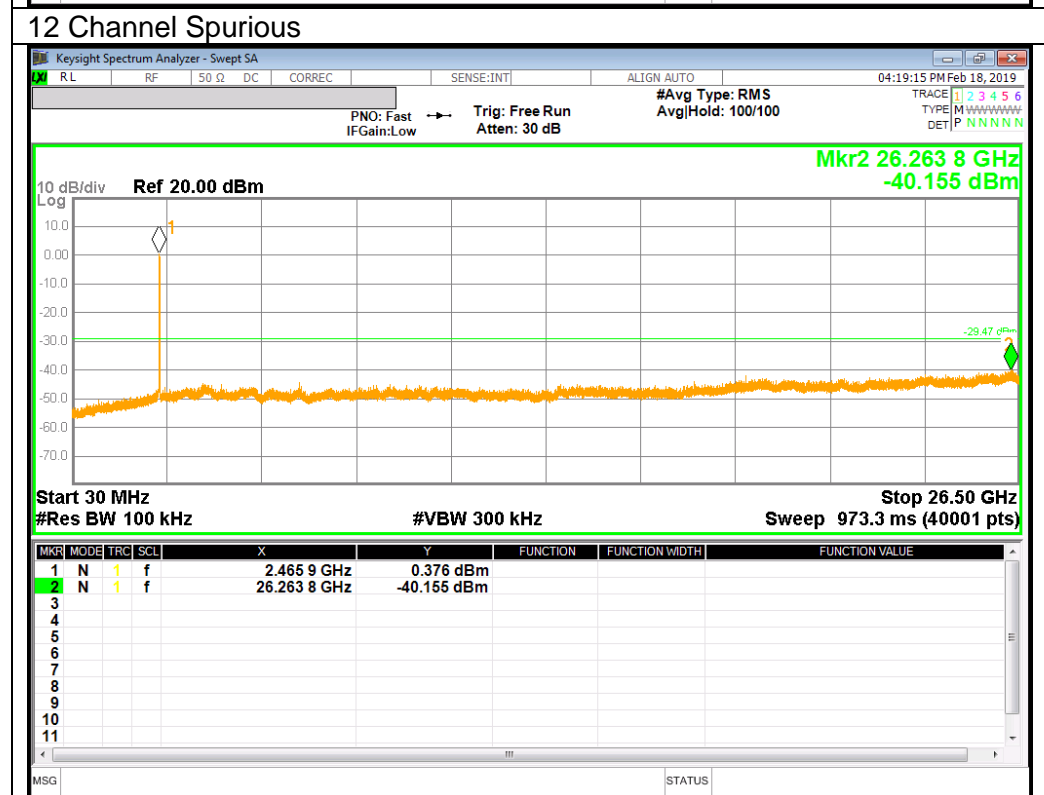
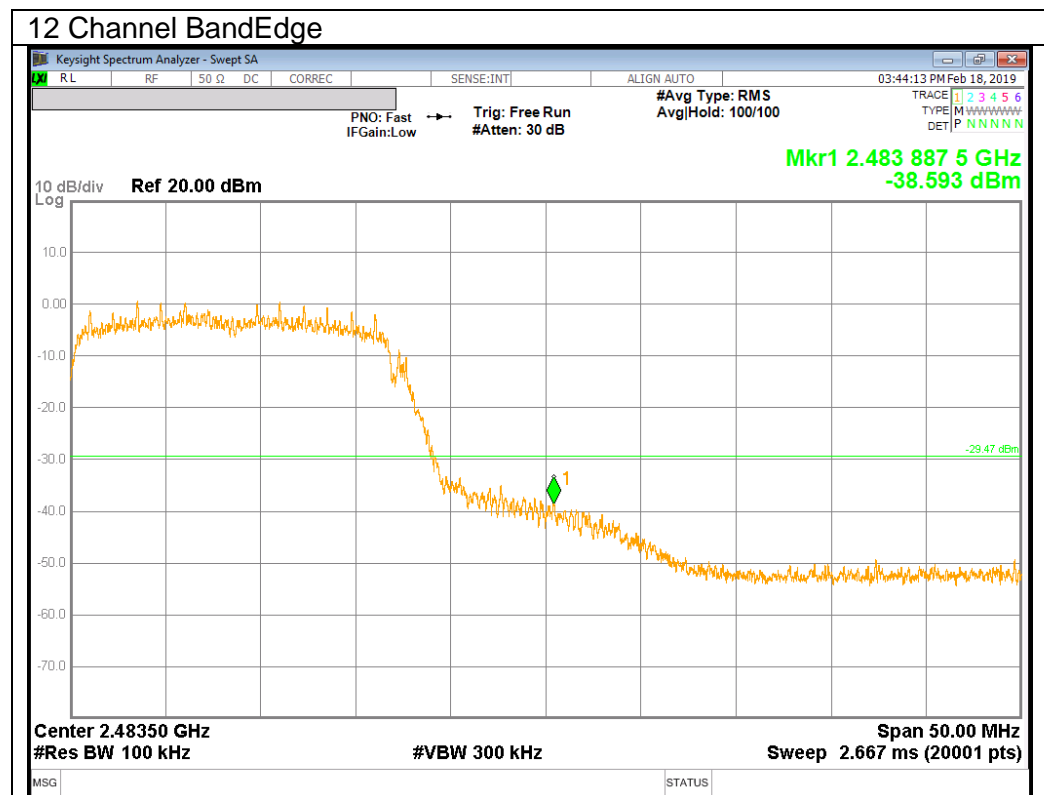

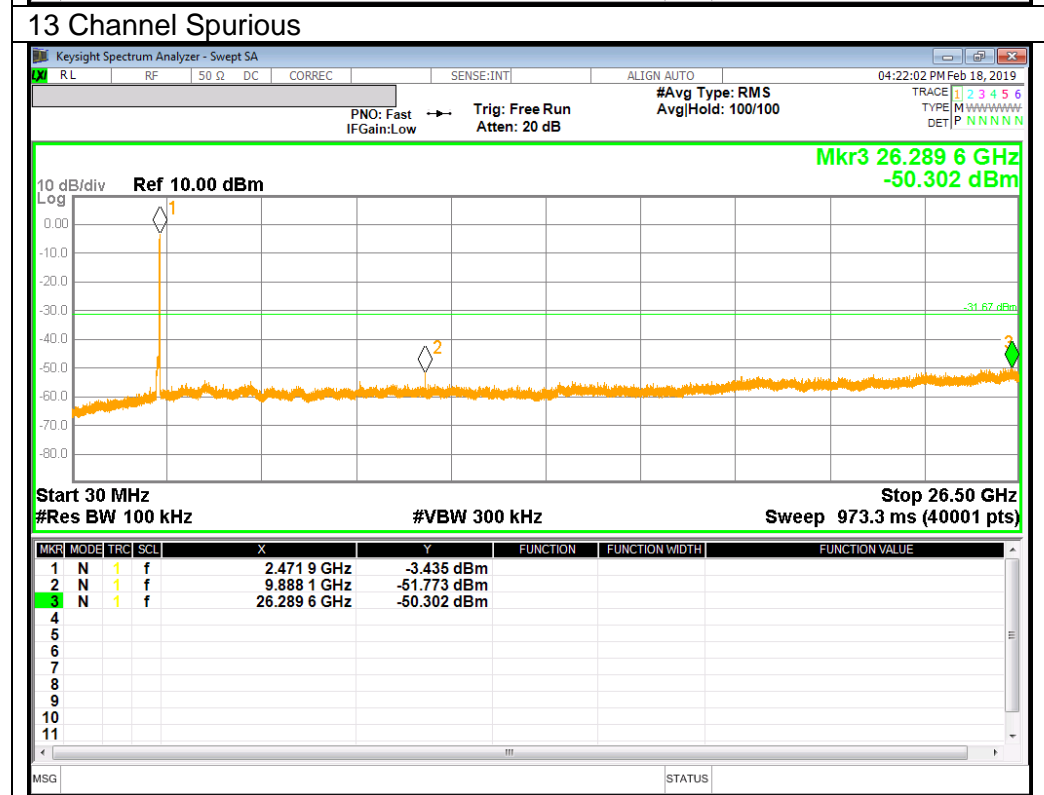
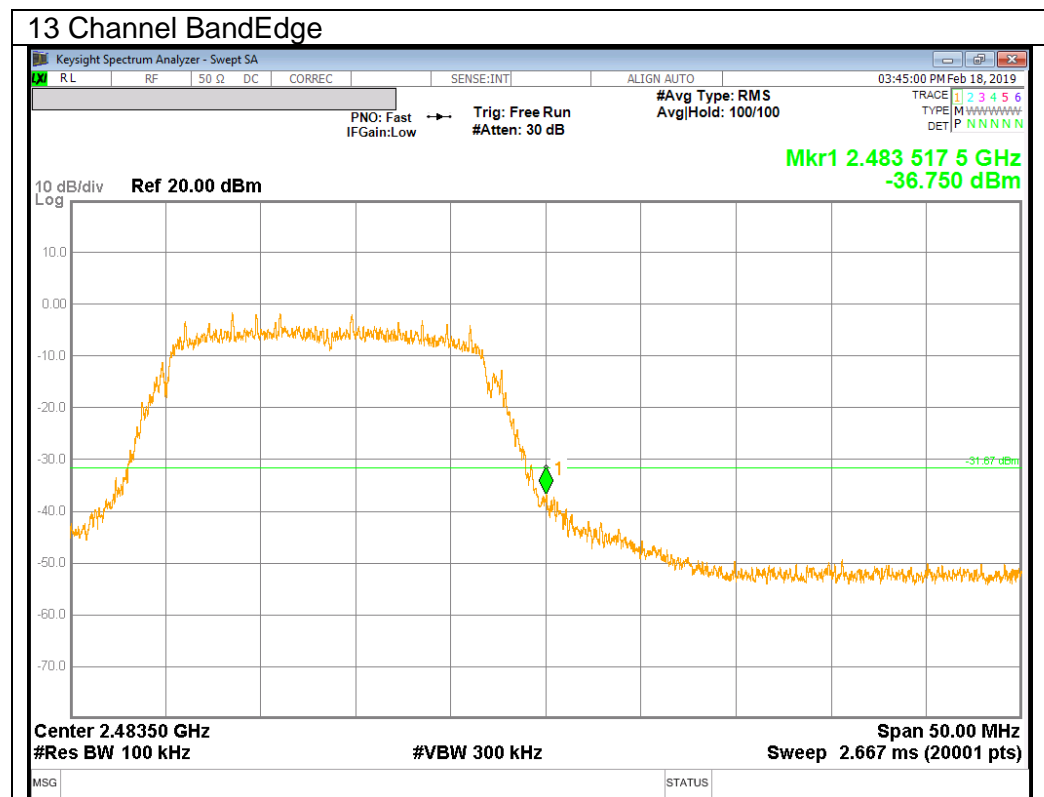

10.4.3.802.11n HT20 MODE IN THE 2.4 GHz BAND

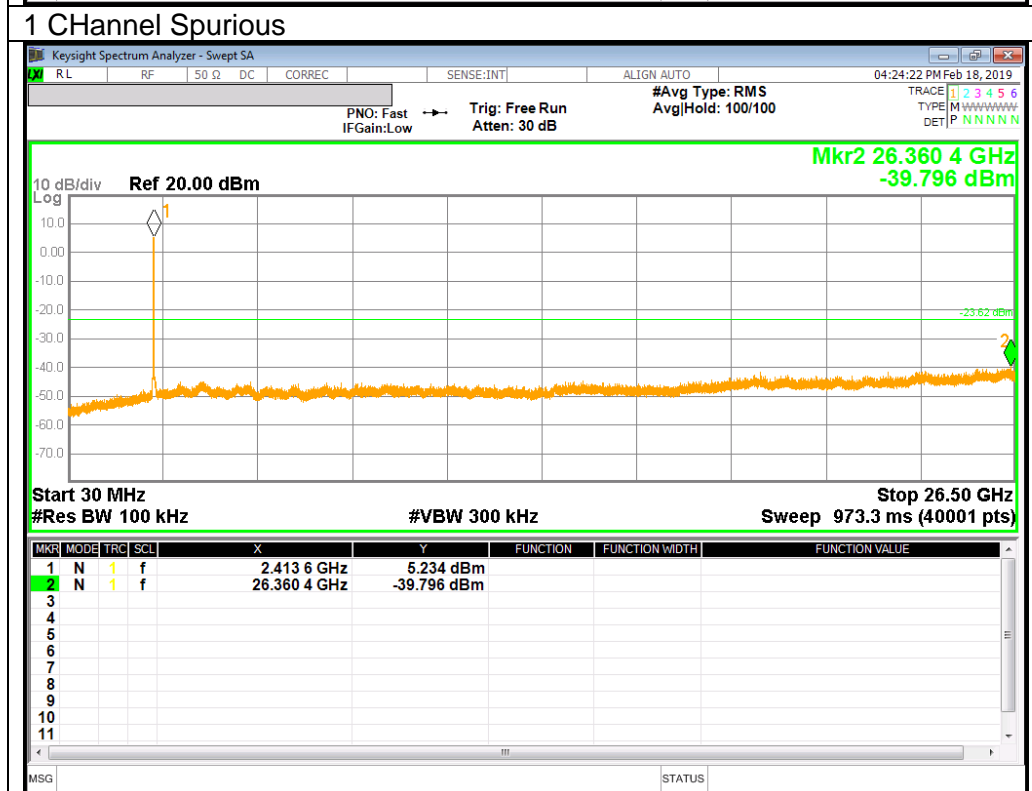
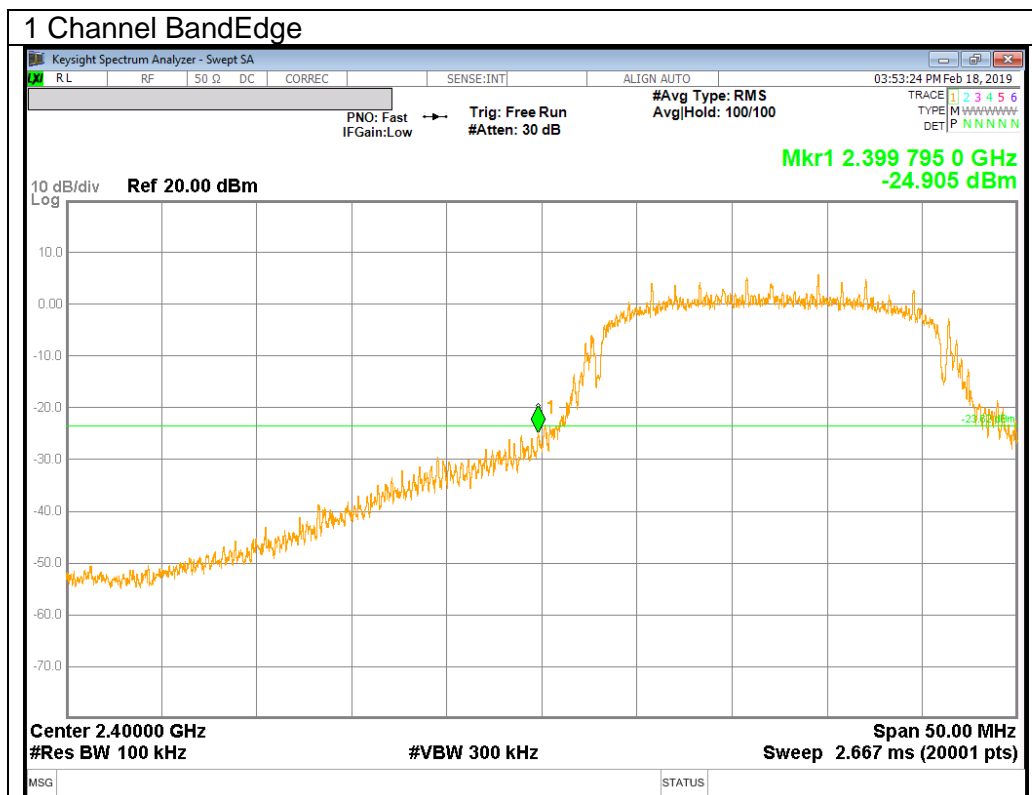

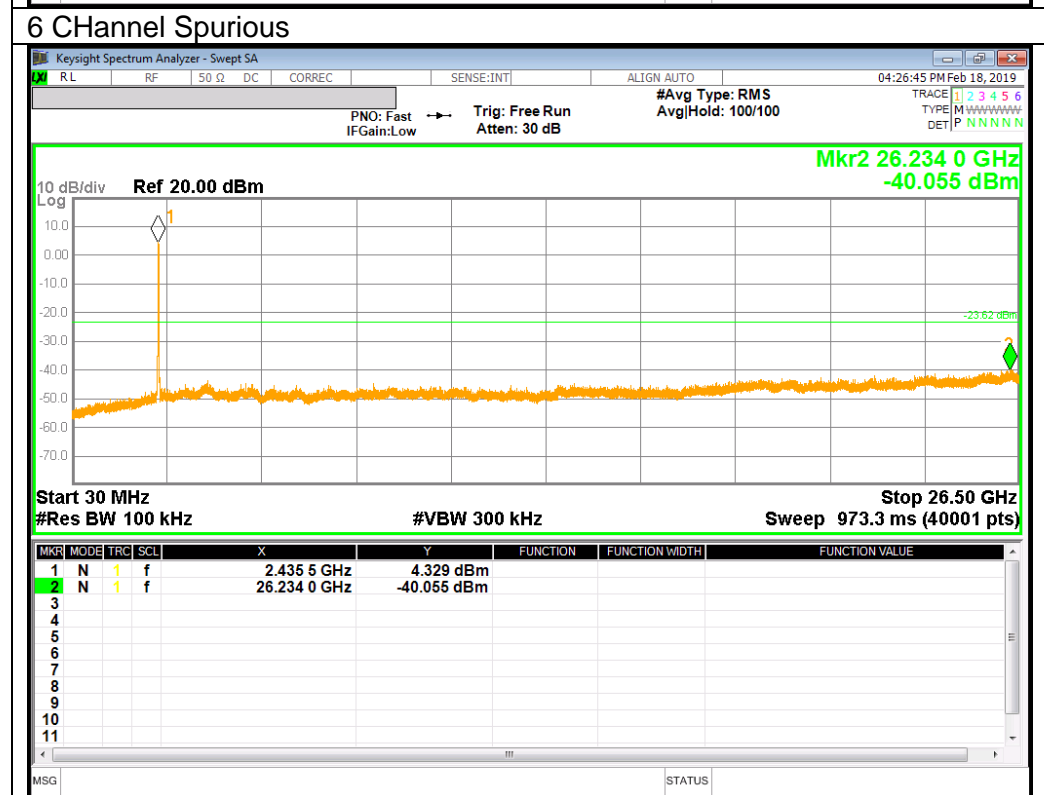
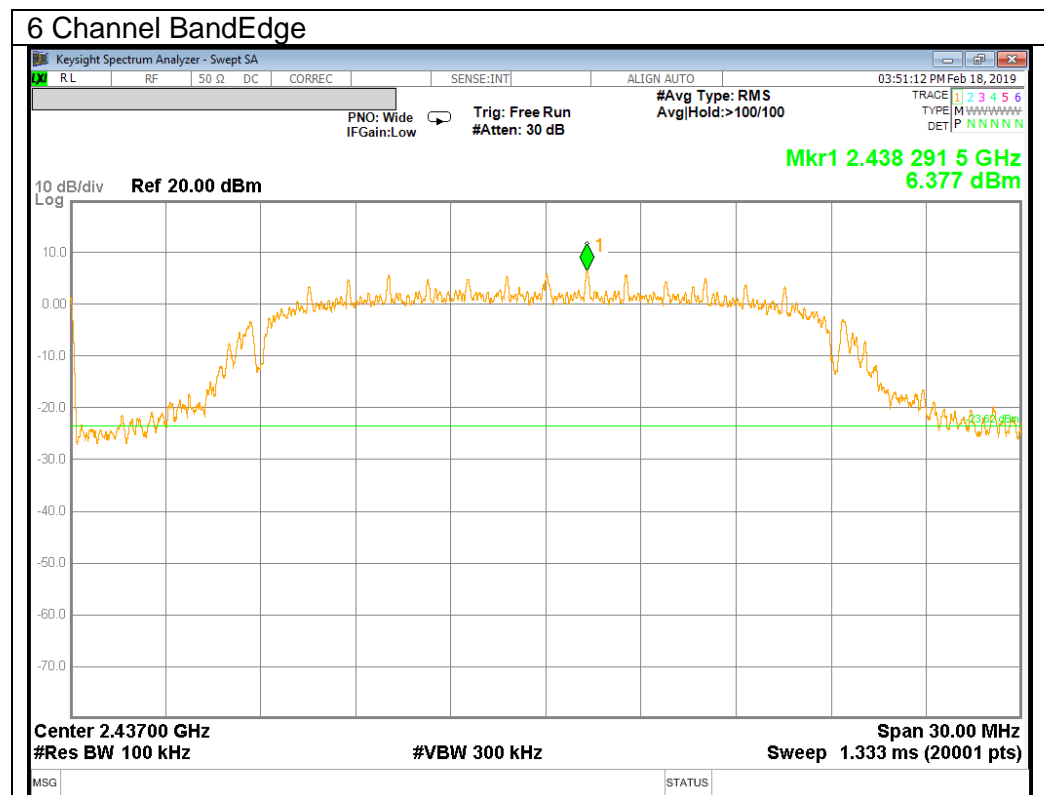

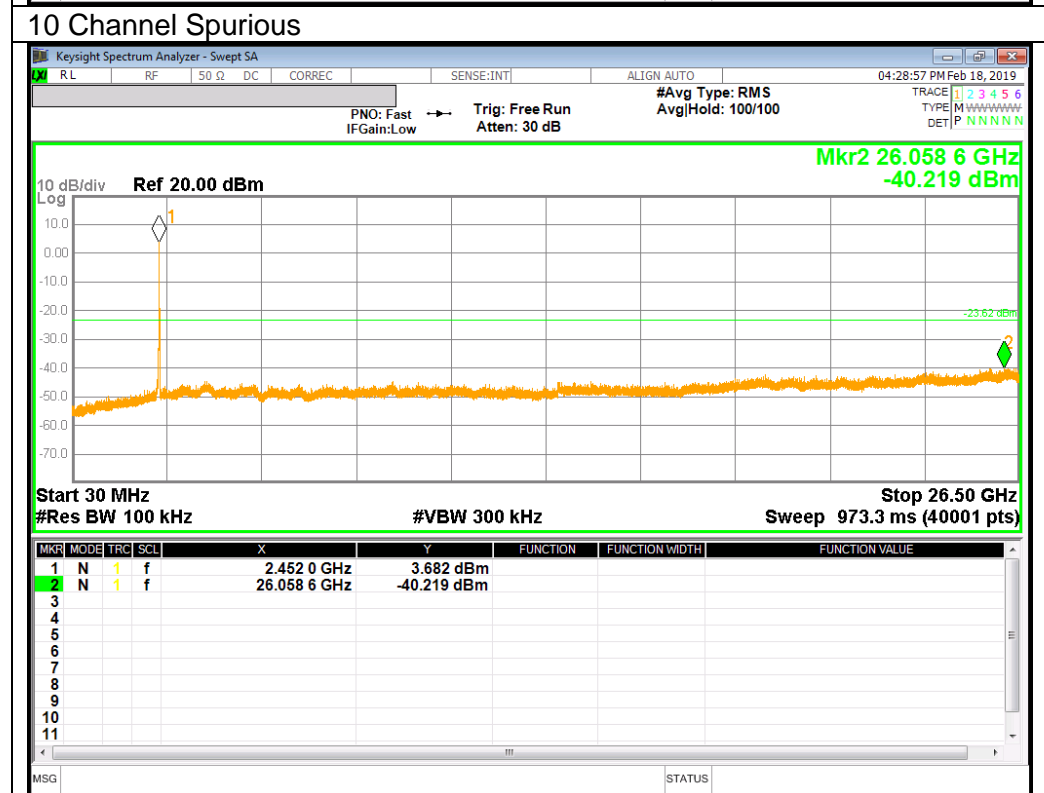
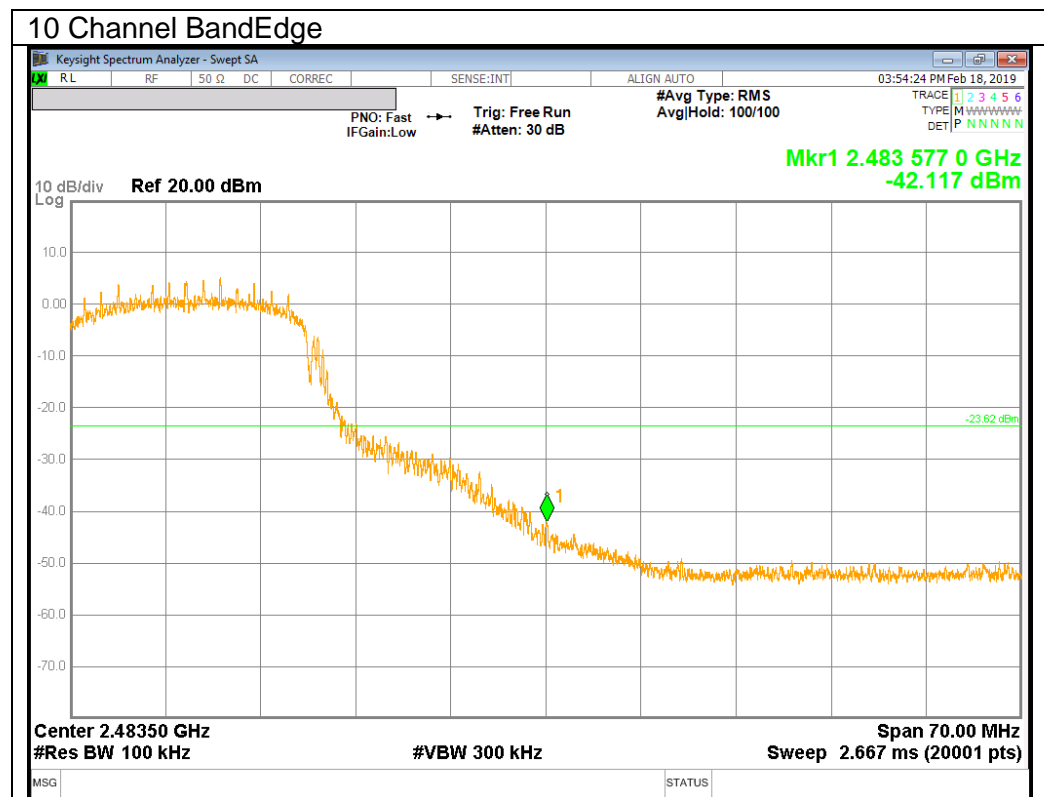

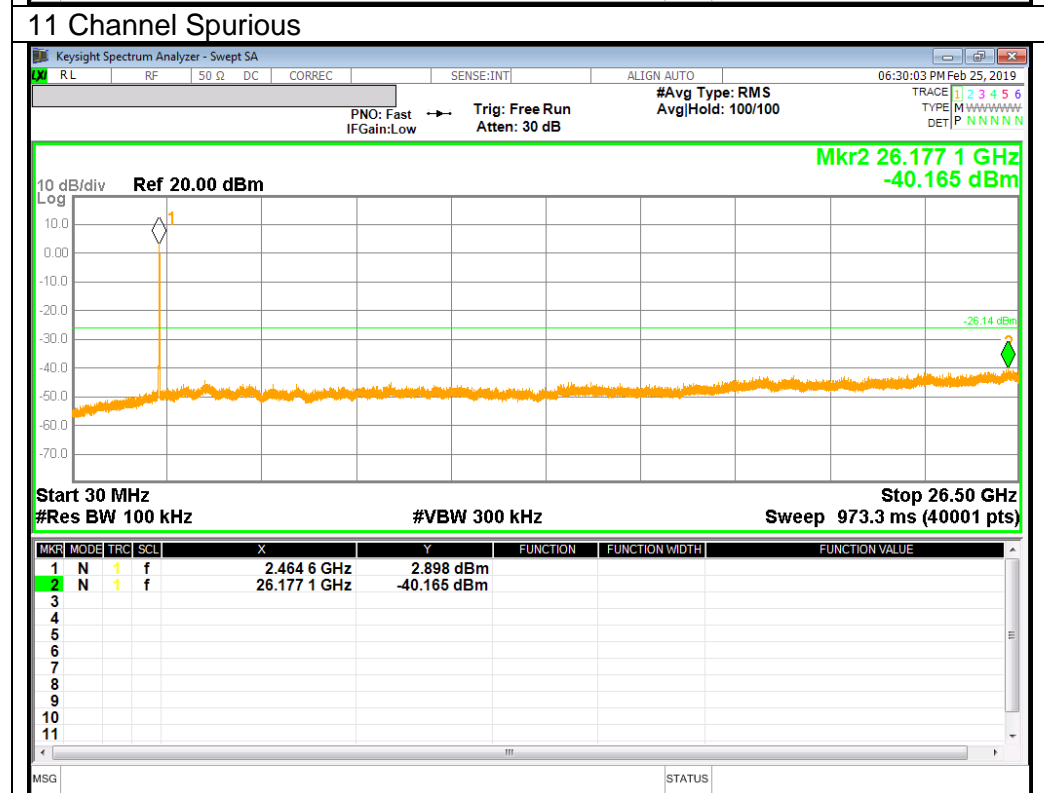
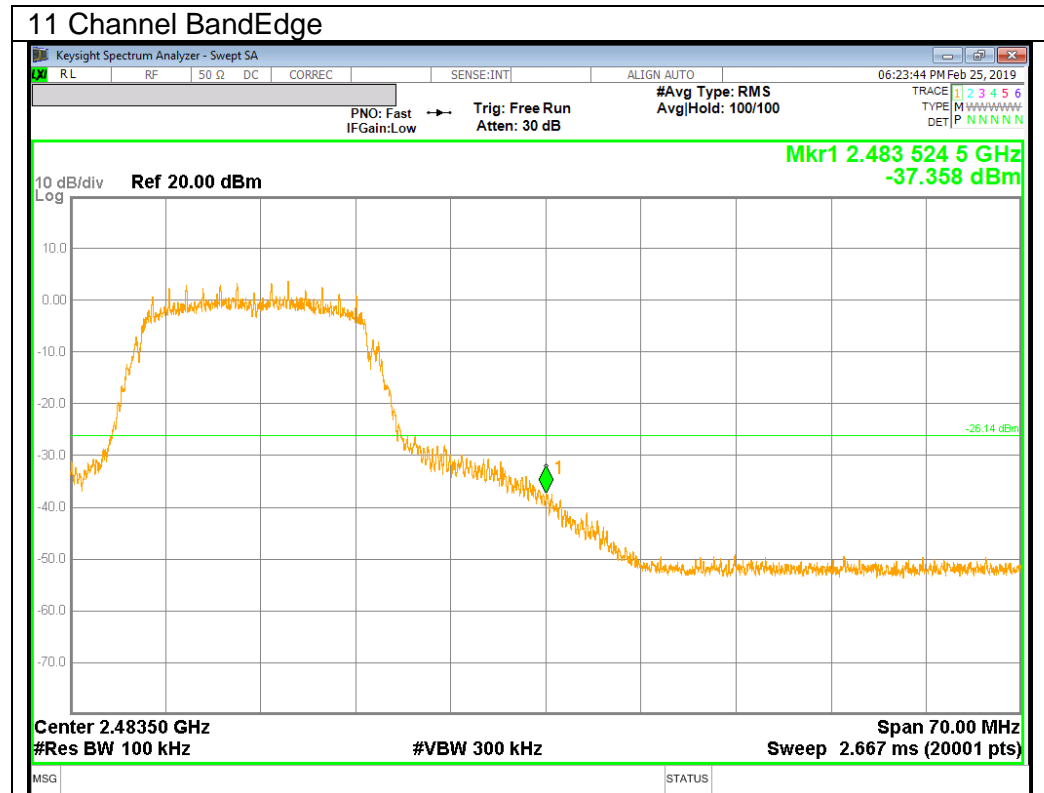

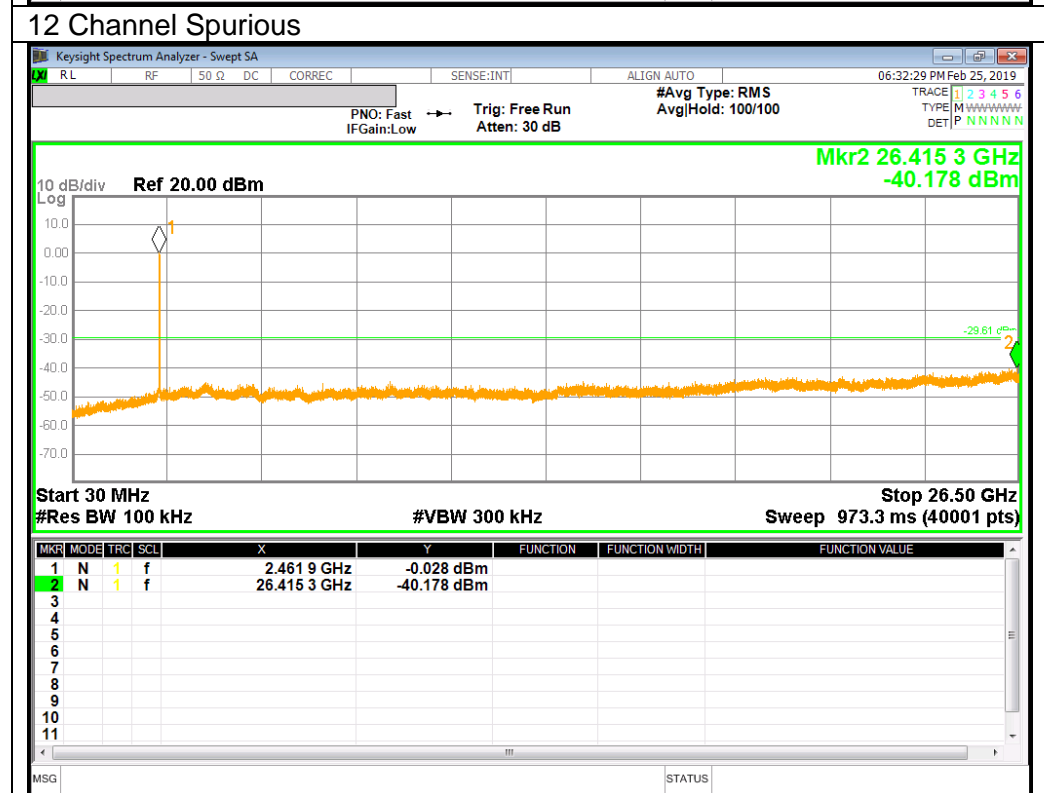
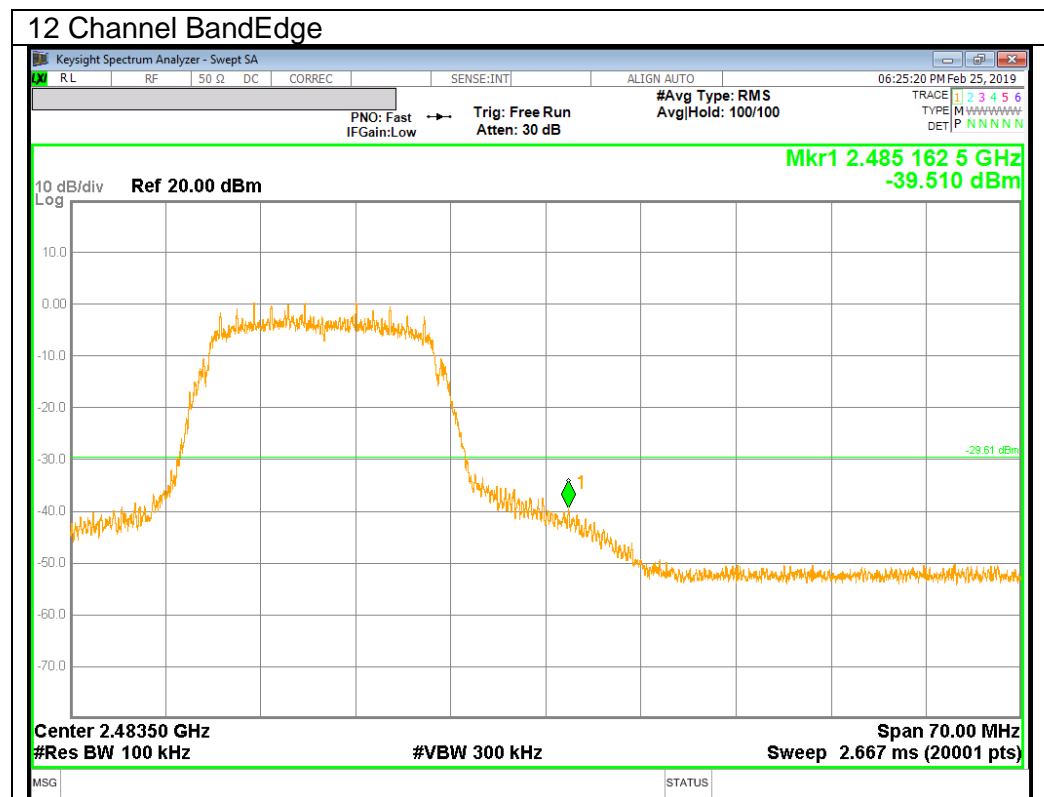

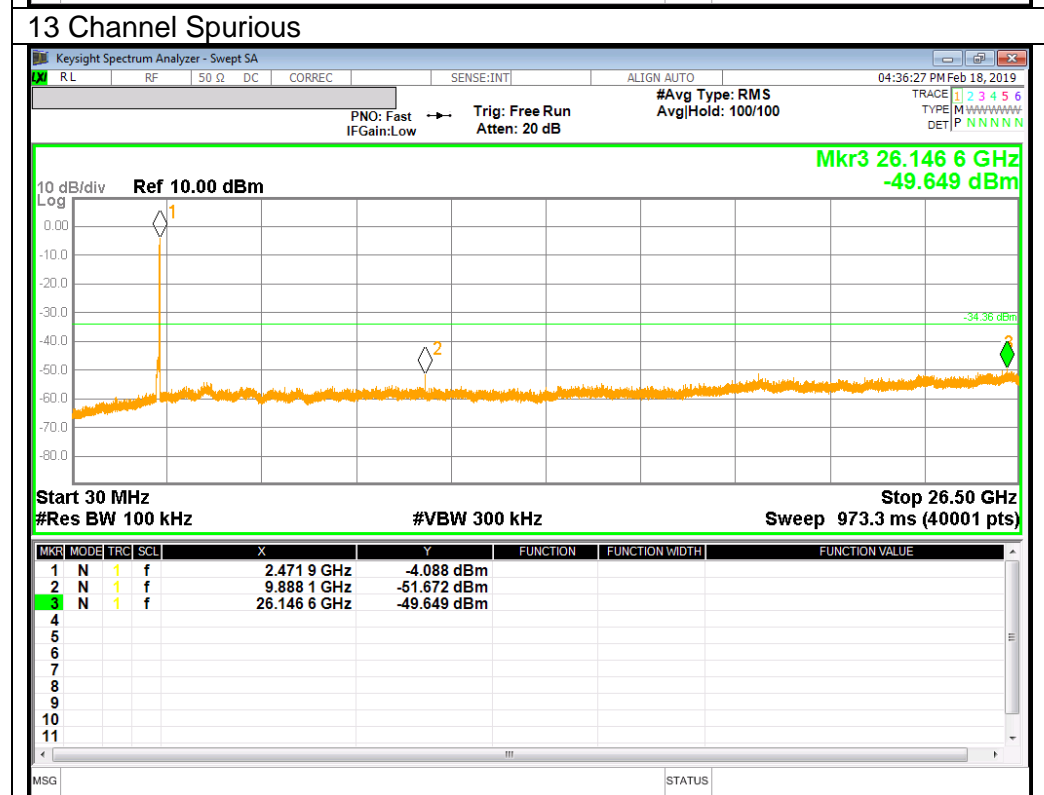
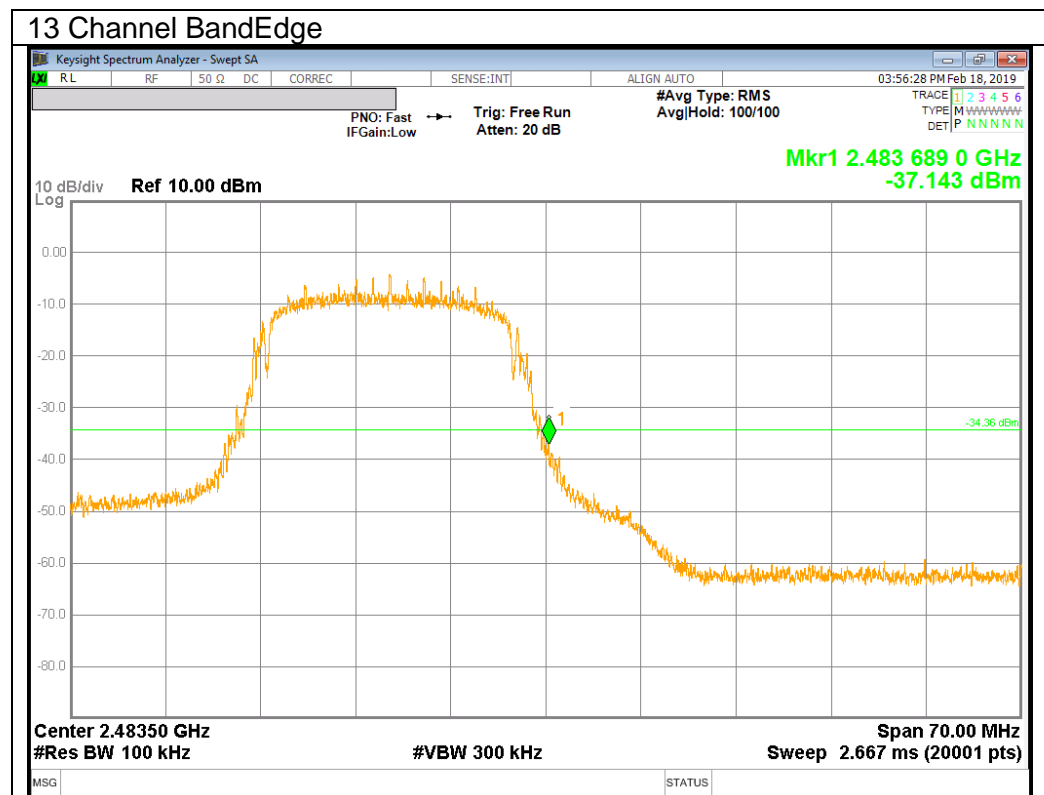

11. RADIATED TEST RESULTS

11.1. LIMITS AND PROCEDURE

LIMITS

FCC §15.205 and §15.209

Limits for radiated disturbance of an intentional radiator		
Frequency range (MHz)	Limits ($\mu\text{V}/\text{m}$)	Measurement Distance (m)
0.009 – 0.490	2400 / F (kHz)	300
0.490 – 1.705	24000 / F (kHz)	30
1.705 – 30.0	30	30
30 – 88	100**	3
88 - 216	150**	3
216 – 960	200**	3
Above 960	500	3

** Except as provided in paragraph (g), fundamental emissions from intentional radiators operating under this section shall not be located in the frequency bands 54-72 MHz, 76-88 MHz, 174-216 MHz or 470-806 MHz. However, operation within these frequency bands is permitted under other sections of this part, e.g. §§ 15.231 and 15.241.

TEST PROCEDURE

The EUT is placed on a non-conducting table 80 cm above the ground plane for below 1GHz and 150 cm for above 1GHz. The antenna to EUT distance is 3 meters. The EUT is configured in accordance with ANSI C63.10. The EUT is set to transmit in a continuous mode.

For measurements below 1 GHz the resolution bandwidth is set to 100 kHz for peak detection measurements or 120 kHz for quasi-peak detection measurements. Peak detection is used unless otherwise noted as quasi-peak.

For measurements above 1 GHz the resolution bandwidth is set to 1 MHz; the video bandwidth is set to 3 MHz for peak measurements and add duty cycle factor for average measurements. (Restricted bandedge, Final detection of spurious harmonic emissions)
Duty cycle factor= $10\log(1/x)$ For this sample B mode = 0dB (duty cycle >98%); G mode = 0.20dB ; N mode = 0.17dB.

Pre-scans to detect harmonic and spurious emissions, the resolution bandwidth is set to 1 MHz; the video bandwidth is set to 30 KHz for peak measurements.

The spectrum from 1 GHz to 26 GHz is investigated with the transmitter set to the lowest, middle, and highest channels in each applicable band.
(From 30MHz to 1GHz, test was performed with the EUT set to transmit at the channel with highest output power)

The frequency range of interest is monitored at a fixed antenna height and EUT azimuth. The EUT is rotated through 360 degrees to maximize emissions received. The antenna is scanned from 1 to 4 meters above the ground plane to further maximize the emission. Measurements are made with the antenna polarized in both the vertical and the horizontal positions.

Note : Emission was pre-scanned from 9KHz to 30MHz; No emissions were detected which was at least 20dB below the specification limit (consider distance correction factor).
Per FCC part 15.31(o), test results were not reported.

Although these tests were performed other than open field test site, adequate comparison measurements were confirmed against 30 m open are test site.
Therefore sufficient tests were made to demonstrate that the alternative site produces results that correlate with the one of tests made in an open field based on KDB 414788.

11.2. TRANSMITTER ABOVE 1 GHz

11.2.1.TX ABOVE 1 GHz 802.11b MODE IN THE 2.4 GHz BAND

RESTRICTED BANDEDGE (1 CHANNEL)

HORIZONTAL PEAK AND AVERAGE PLOT

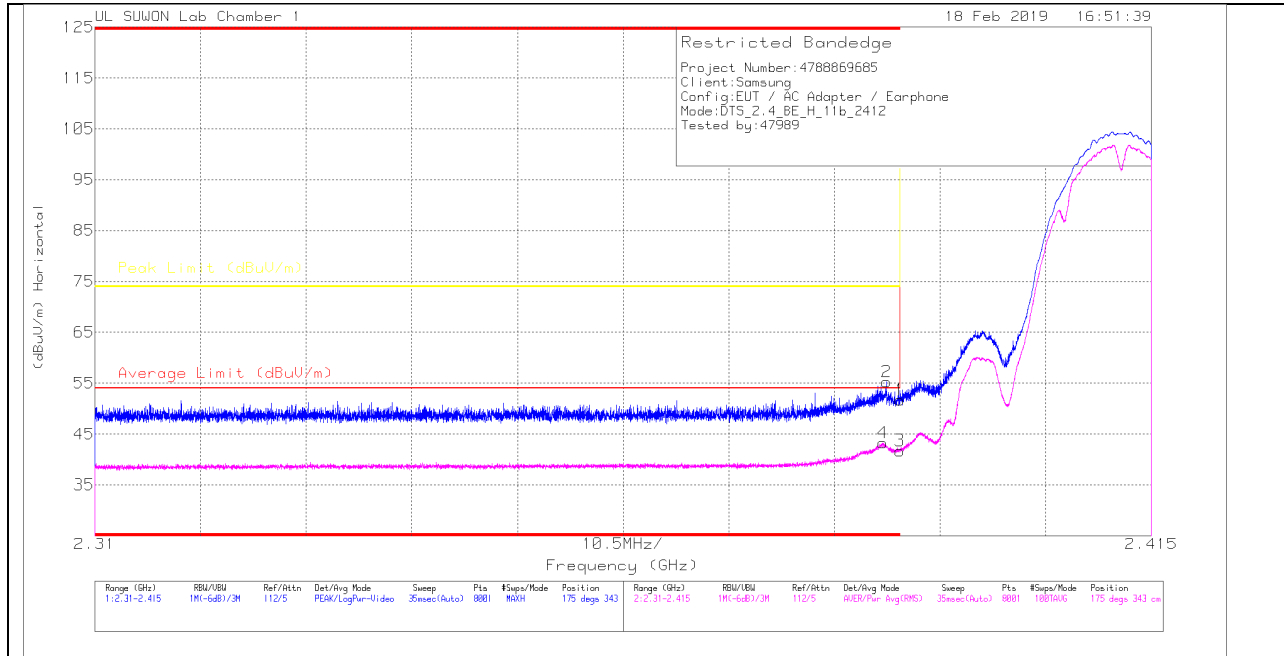

HORIZONTAL DATA

Trace Markers

Marker	Frequency (GHz)	Meter Reading (dBuV)	Det	3117_00168717	10dB(dB)	DC Corr (dB)	Corrected Reading (dBuV/m)	Average Limit (dBuV/m)	Margin (dB)	Peak Limit (dBuV/m)	PK Margin (dB)	Azimuth (Degs)	Height (cm)	Polarity
1	* 2.39	45.48	Pk	31.7	-25.5	0	51.68	-	-	74	-22.32	175	343	H
2	* 2.389	49.03	Pk	31.7	-25.5	0	55.23	-	-	74	-18.77	175	343	H
3	* 2.39	35.53	RMS	31.7	-25.5	0	41.73	54	-12.27	-	-	175	343	H
4	* 2.388	37.08	RMS	31.7	-25.5	0	43.28	54	-10.72	-	-	175	343	H

* - indicates frequency in CFR47 Pt 15 / IC RSS-Restricted Band

Pk - Peak detector

RMS - RMS detection

VERTICAL PEAK AND AVERAGE PLOT

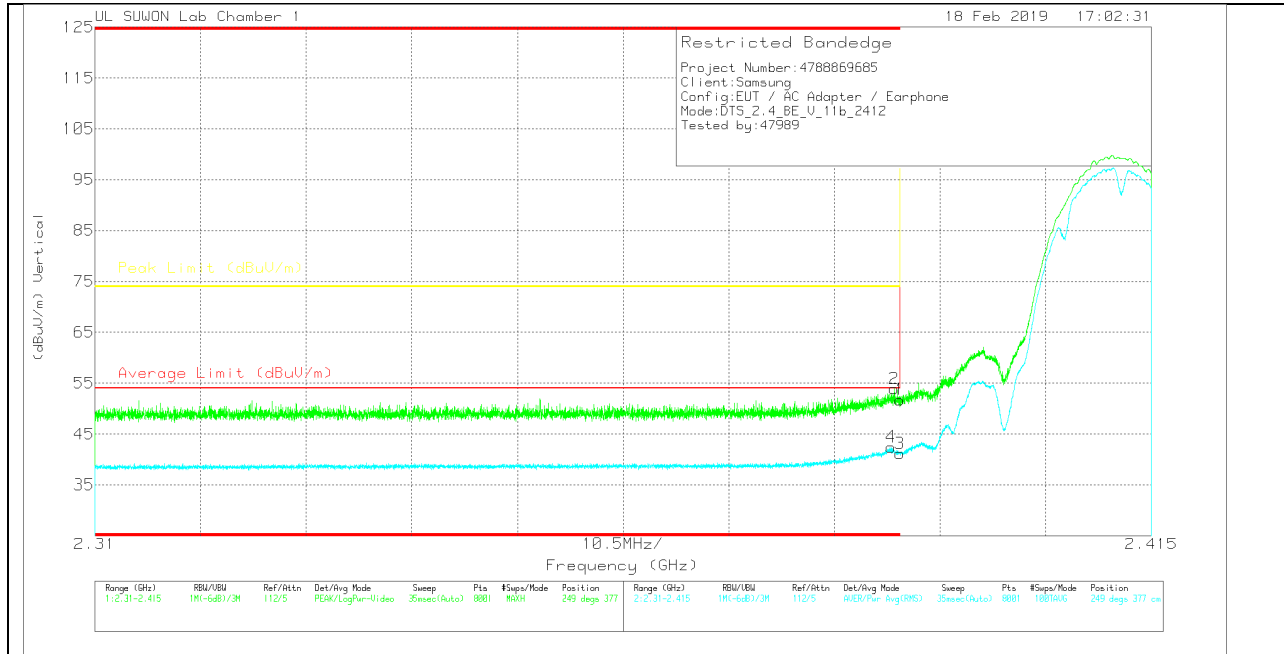

VERTICAL DATA

Trace Markers

Marker	Frequency (GHz)	Meter Reading (dBuV)	Det	3117_00168717	10dB(dB)	DC Corr (dB)	Corrected Reading (dBuV/m)	Average Limit (dBuV/m)	Margin (dB)	Peak Limit (dBuV/m)	PK Margin (dB)	Azimuth (Degs)	Height (cm)	Polarity
1	* 2.39	45.55	Pk		-25.5	0	51.75	-	-	74	-22.25	249	377	V
2	* 2.389	47.74	Pk		-25.5	0	53.94	-	-	74	-20.06	249	377	V
3	* 2.39	35.01	RMS		-25.5	0	41.21	54	-12.79	-	-	249	377	V
4	* 2.389	36.27	RMS		-25.5	0	42.47	54	-11.53	-	-	249	377	V

* - indicates frequency in CFR47 Pt 15 / IC RSS-Restricted Band

Pk - Peak detector

RMS - RMS detection

AUTHORIZED BANDEDGE (11 CHANNEL)

HORIZONTAL PEAK AND AVERAGE PLOT

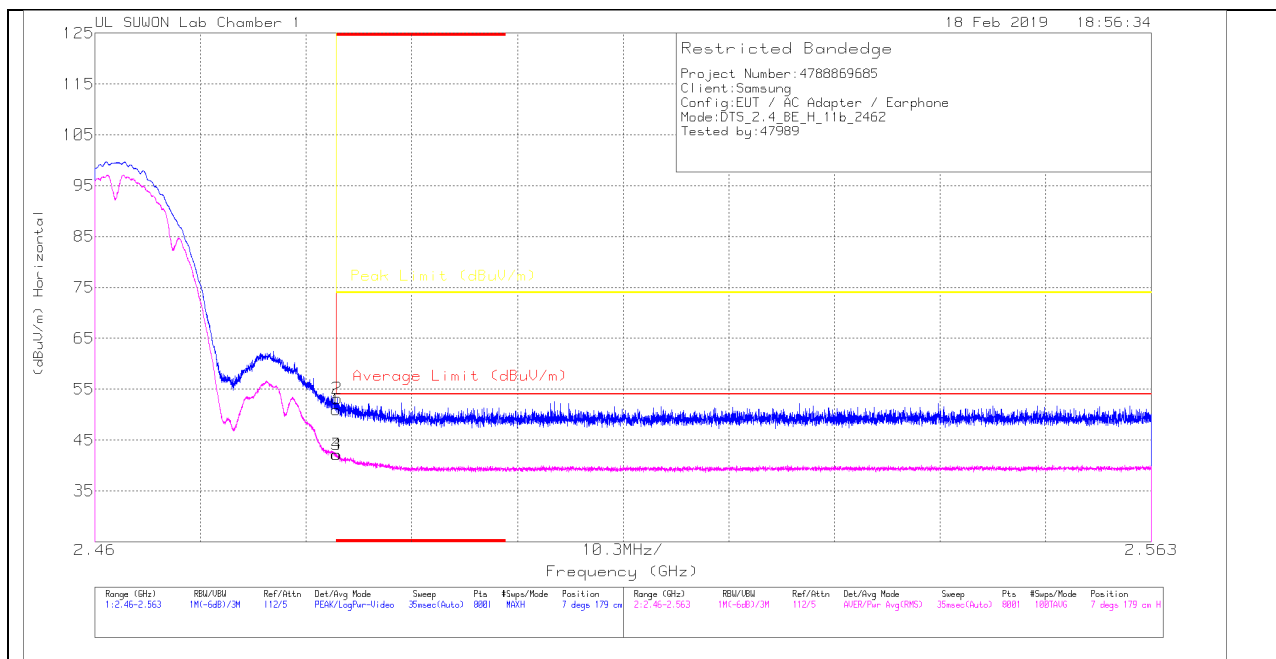

HORIZONTAL DATA

Trace Markers

Marker	Frequency (GHz)	Meter Reading (dBuV)	Det	3117_00168717	10dB(dB)	DC Corr (dB)	Corrected Reading (dBuV/m)	Average Limit (dBuV/m)	Margin (dB)	Peak Limit (dBuV/m)	PK Margin (dB)	Azimuth (Degs)	Height (cm)	Polarity
1	* 2.484	44.29	Pk	31.9	-25.3	0	50.89	-	-	74	-23.11	7	179	H
2	* 2.484	46.6	Pk	31.9	-25.3	0	53.2	-	-	74	-20.8	7	179	H
3	* 2.484	35.58	RMS	31.9	-25.3	0	42.18	54	-11.82	-	-	7	179	H
4	* 2.484	35.56	RMS	31.9	-25.3	0	42.16	54	-11.84	-	-	7	179	H

* - indicates frequency in CFR47 Pt 15 / IC RSS-Restricted Band

Pk - Peak detector

RMS - RMS detection

VERTICAL PEAK AND AVERAGE PLOT

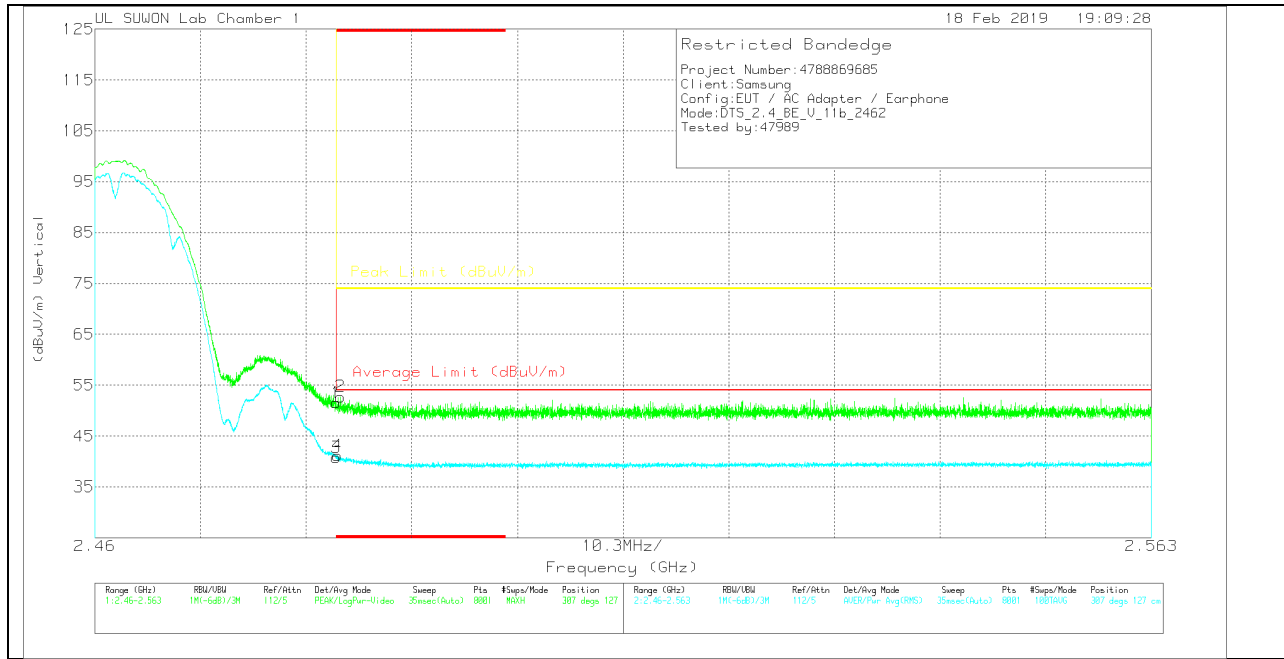

VERTICAL DATA

Trace Markers

Marker	Frequency (GHz)	Meter Reading (dBuV)	Det	3117_00168717	10dB(dB)	DC Corr (dB)	Corrected Reading (dBuV/m)	Average Limit (dBuV/m)	Margin (dB)	Peak Limit (dBuV/m)	PK Margin (dB)	Azimuth (Degs)	Height (cm)	Polarity
1	* 2.484	44.92	Pk	31.9	-25.3	0	51.52	-	-	74	-22.48	307	127	V
2	* 2.484	46.14	Pk	31.9	-25.3	0	52.74	-	-	74	-21.26	307	127	V
3	* 2.484	34.24	RMS	31.9	-25.3	0	40.84	54	-13.16	-	-	307	127	V
4	* 2.484	34.53	RMS	31.9	-25.3	0	41.13	54	-12.87	-	-	307	127	V

* - indicates frequency in CFR47 Pt 15 / IC RSS-Restricted Band

Pk - Peak detector

RMS - RMS detection

AUTHORIZED BANDEDGE (12 CHANNEL)

HORIZONTAL PEAK AND AVERAGE PLOT

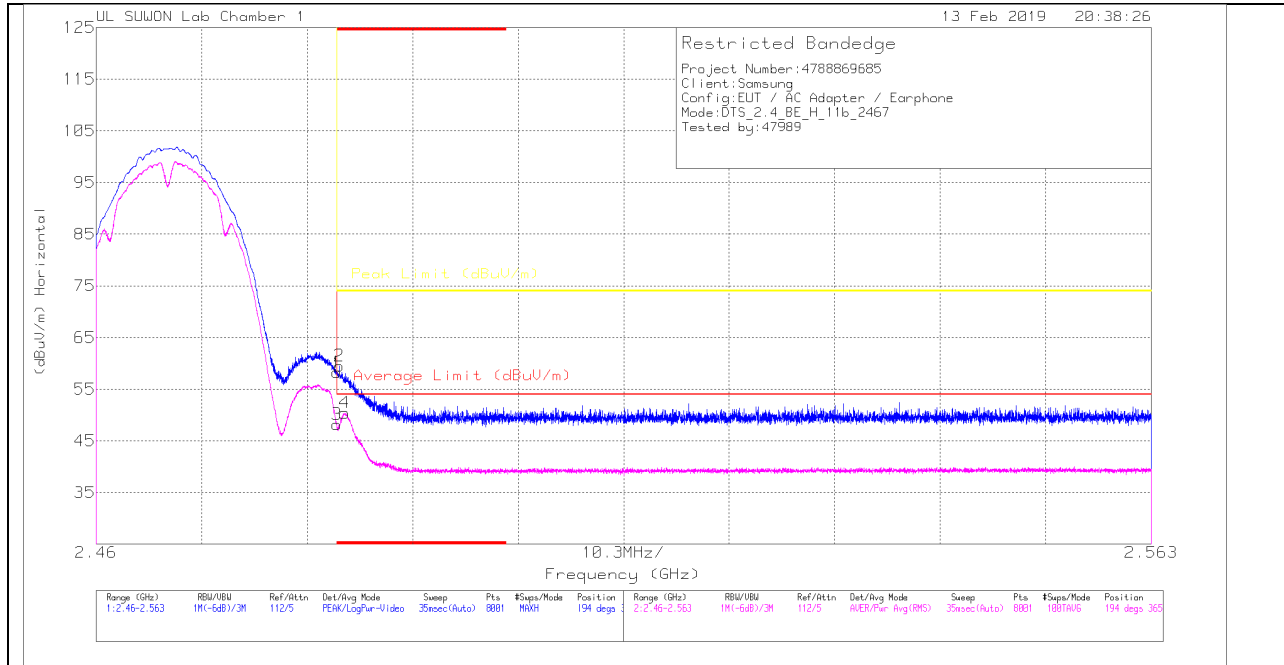

HORIZONTAL DATA

Trace Markers

Marker	Frequency (GHz)	Meter Reading (dBuV)	Det	3117_00168717	10dB(dB)	DC Corr (dB)	Corrected Reading (dBuV/m)	Average Limit (dBuV/m)	Margin (dB)	Peak Limit (dBuV/m)	PK Margin (dB)	Aimuth (Degs)	Height (cm)	Polarity
1	* 2.484	51.64	Pk	31.9	-25.3	0	58.24	-	-	74	-15.76	194	365	H
2	* 2.484	52.92	Pk	31.9	-25.3	0	59.52	-	-	74	-14.48	194	365	H
3	* 2.484	41.59	RMS	31.9	-25.3	0	48.19	54	-5.81	-	-	194	365	H
4	* 2.484	43.83	RMS	31.9	-25.3	0	50.43	54	-3.57	-	-	194	365	H

* - indicates frequency in CFR47 Pt 15 / IC RSS-Restricted Band

Pk - Peak detector

RMS - RMS detection

VERTICAL PEAK AND AVERAGE PLOT

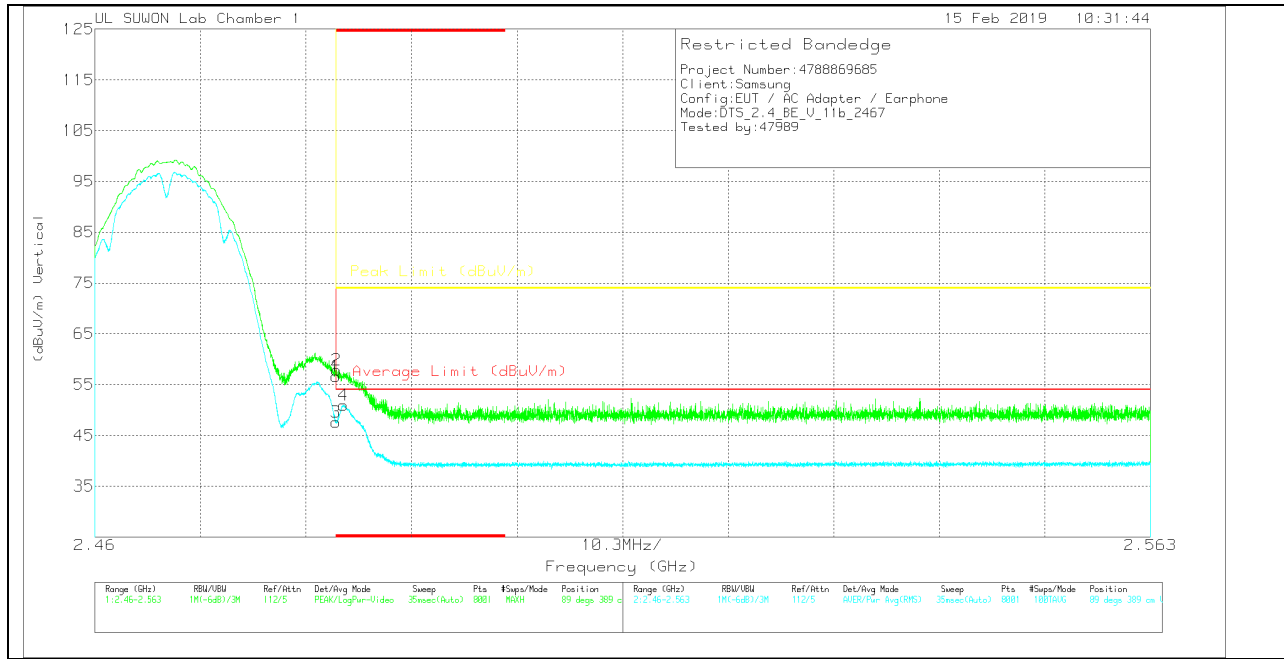

VERTICAL DATA

Trace Markers

Marker	Frequency (GHz)	Meter Reading (dBuV)	Det	3117_00168717	10dB(dB)	DC Corr (dB)	Corrected Reading (dBuV/m)	Average Limit (dBuV/m)	Margin (dB)	Peak Limit (dBuV/m)	PK Margin (dB)	Altitude (Degs)	Height (cm)	Polarity
1	* 2.484	50.07	Pk	31.9	-25.3	0	56.67	-	-	74	-17.33	89	389	V
2	* 2.484	51.25	PK	31.9	-25.3	0	57.85	-	-	74	-16.15	89	389	V
3	* 2.484	40.95	RMS	31.9	-25.3	0	47.55	54	-6.45	-	-	89	389	V
4	* 2.484	44.36	RMS	31.9	-25.3	0	50.96	54	-3.04	-	-	89	389	V

* - indicates frequency in CFR47 Pt 15 / IC RSS-Restricted Band

PK - Peak detector

RMS - RMS detection

AUTHORIZED BANDEDGE (13 CHANNEL)

HORIZONTAL PEAK AND AVERAGE PLOT

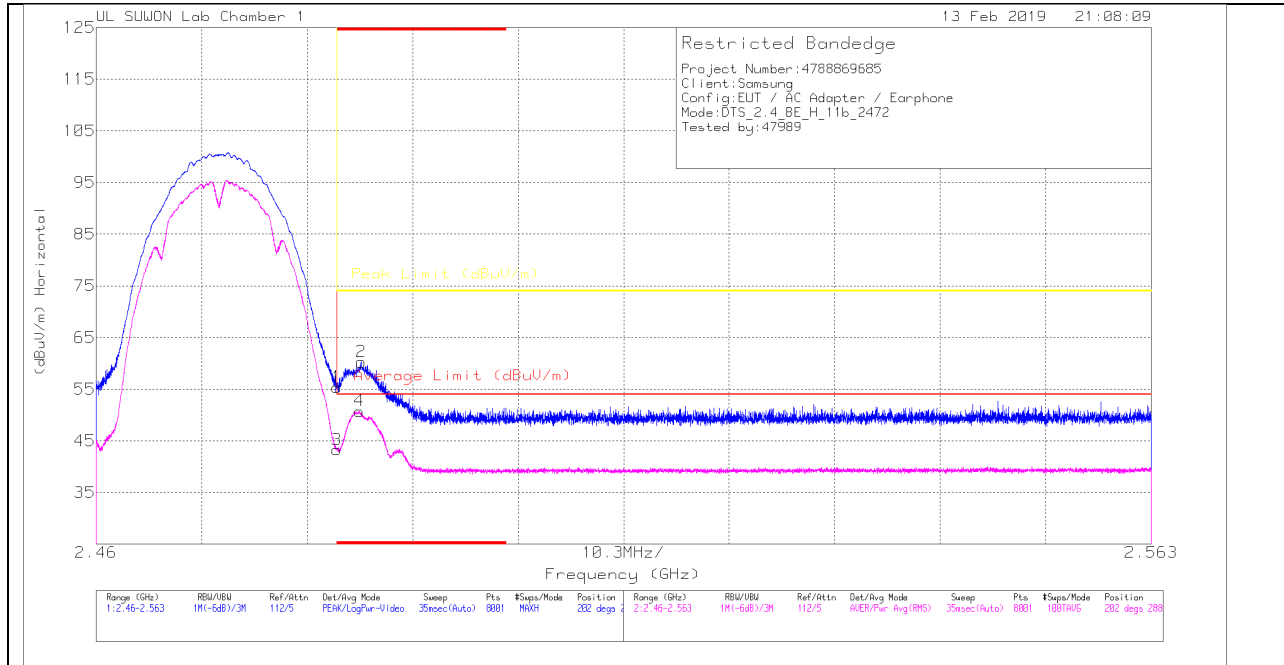

HORIZONTAL DATA

Trace Markers

Marker	Frequency (GHz)	Meter Reading (dBuV)	Det	3117_00168717	10dB(dB)	DC Corr (dB)	Corrected Reading (dBuV/m)	Average Limit (dBuV/m)	Margin (dB)	Peak Limit (dBuV/m)	PK Margin (dB)	Azimuth (Degs)	Height (cm)	Polarity
1	* 2.484	48.78	Pk	31.9	-25.3	0	55.38	-	-	74	-18.62	202	288	H
2	* 2.486	53.6	Pk	31.9	-25.2	0	60.3	-	-	74	-13.7	202	288	H
3	* 2.484	36.71	RMS	31.9	-25.3	0	43.31	54	-10.69	-	-	202	288	H
4	* 2.486	44.09	RMS	31.9	-25.2	0	50.79	54	-3.21	-	-	202	288	H

* - indicates frequency in CFR47 Pt 15 / IC RSS-Restricted Band

Pk - Peak detector

RMS - RMS detection

VERTICAL PEAK AND AVERAGE PLOT

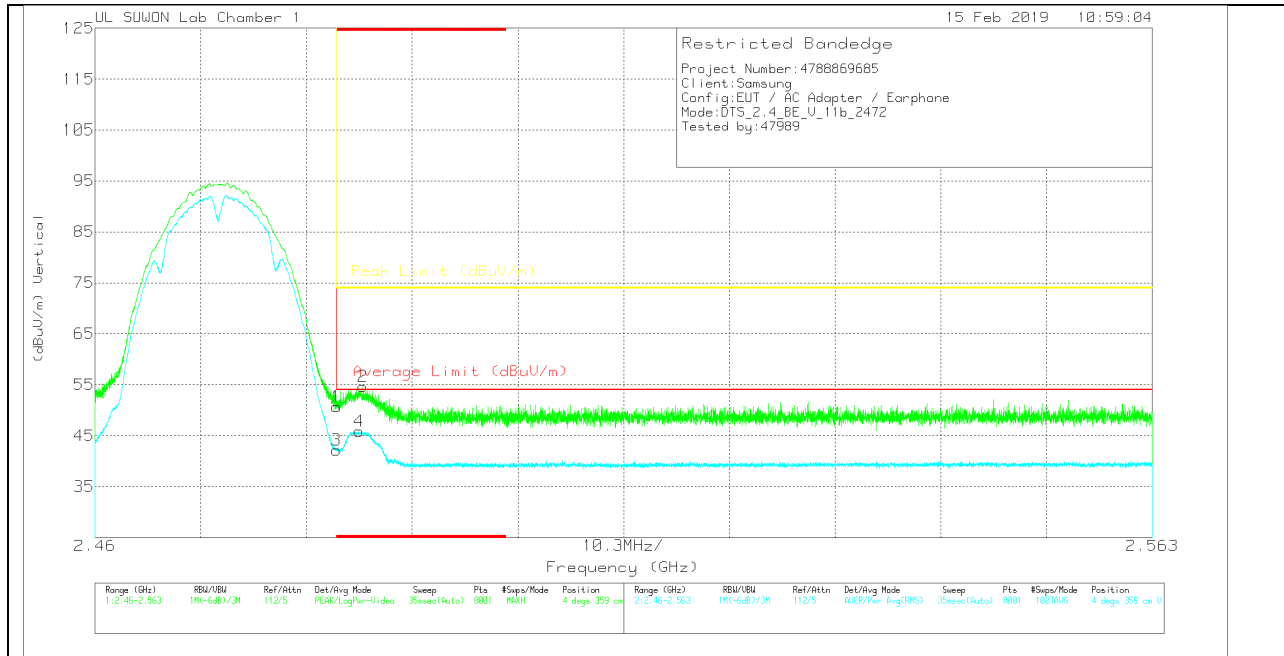

VERTICAL DATA

Trace Markers

Marker	Frequency (GHz)	Meter Reading (dBuV)	Det	3117_00168717	10dB(dB)	DC Corr (dB)	Corrected Reading (dBuV/m)	Average Limit (dBuV/m)	Margin (dB)	Peak Limit (dBuV/m)	PK Margin (dB)	Azimuth (Degs)	Height (cm)	Polarity
1	* 2.484	44.05	Pk	31.9	-25.3	0	50.65	-	-	74	-23.35	4	359	V
2	* 2.486	47.92	Pk	31.9	-25.2	0	54.62	-	-	74	-19.38	4	359	V
3	* 2.484	35.56	RMS	31.9	-25.3	0	42.16	54	-11.84	-	-	4	359	V
4	* 2.486	39.12	RMS	31.9	-25.2	0	45.82	54	-8.18	-	-	4	359	V

* - indicates frequency in CFR47 Pt 15 / IC RSS-Restricted Band

Pk - Peak detector

RMS - RMS detection

HARMONICS AND SPURIOUS EMISSIONS

1 CHANNEL HORIZONTAL

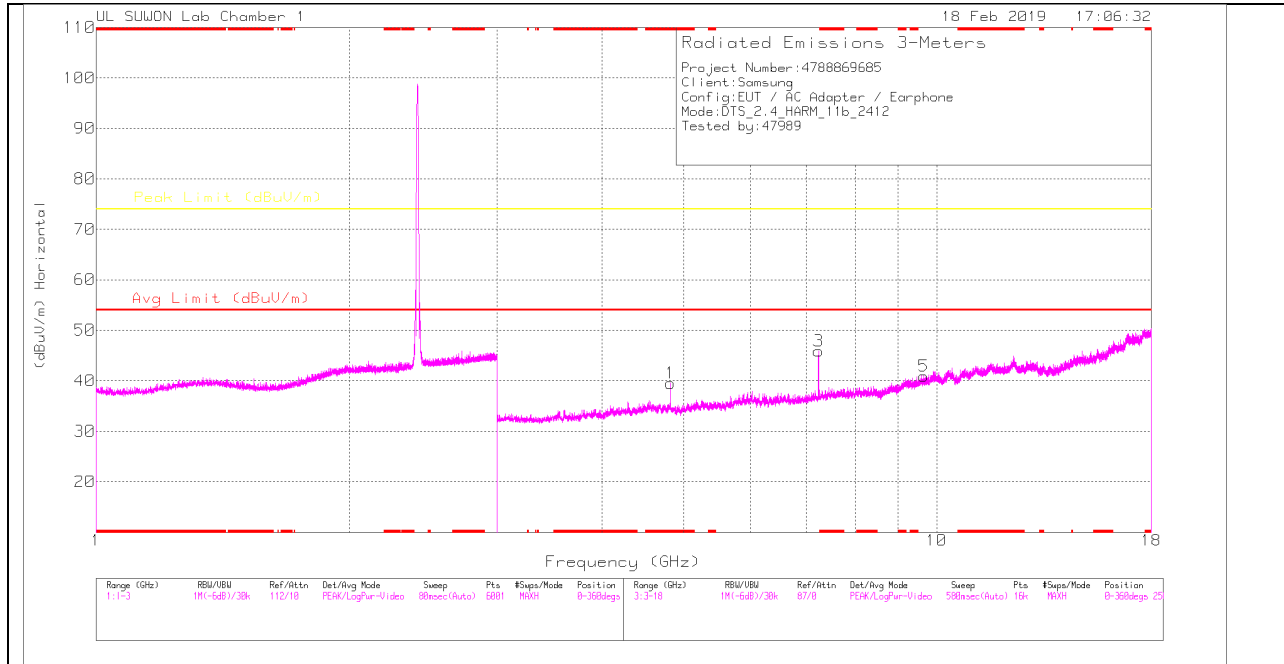

1 CHANNEL VERTICAL

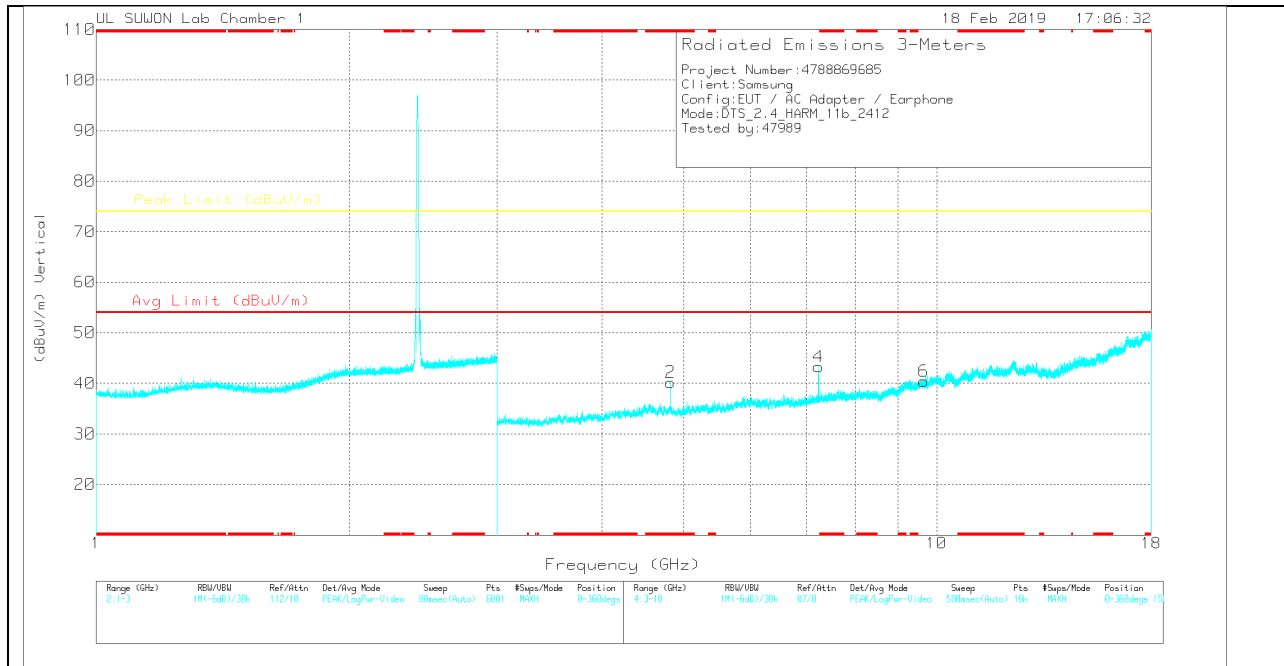

Note: Emission was scanned up to 26GHz; No emissions were detected above the noise floor which was at least 20dB below the specification limit.

1 CHANNEL DATA

Trace Markers

Marker	Frequency (GHz)	Meter Reading (dBuV)	Det	3117_00168717	3GHz_HP[dB]	DC Corr (dB)	Corrected Reading (dBuV/m)	Avg Limit (dBuV/m)	Margin (dB)	Peak Limit (dBuV/m)	Margin (dB)	Azimuth (Degs)	Height (cm)	Polarity
1	* 4.823	36.71	PK	34.2	-31.4	0	39.51	-	-	74	-34.49	0-360	250	H
3	7.235	37.86	PK	35.8	-27.8	0	45.86	-	-	74	-28.14	0-360	150	H
5	9.648	27.11	PK	37.1	-23.3	0	40.91	-	-	74	-33.09	0-360	150	H
2	* 4.823	37.4	PK	34.2	-31.4	0	40.2	-	-	74	-33.8	0-360	150	V
4	7.235	35.29	PK	35.8	-27.8	0	43.29	-	-	74	-30.71	0-360	150	V
6	9.648	26.6	PK	37.1	-23.3	0	40.4	-	-	74	-33.6	0-360	150	V

* - indicates frequency in CFR47 Pt 15 / IC RSS-Restricted Band
 PK – Peak Detector

Radiated Emissions

Frequency (GHz)	Meter Reading (dBuV)	Det	3117_00168717	3GHz_HP[dB]	DC Corr (dB)	Corrected Reading (dBuV/m)	Avg Limit (dBuV/m)	Margin (dB)	Peak Limit (dBuV/m)	Margin (dB)	Azimuth (Degs)	Height (cm)	Polarity
* 4.824	43.52	PK2	34.2	-31.4	0	46.32	-	-	74	-27.68	195	220	H
* 4.824	36.61	MAv1	34.2	-31.4	0	39.41	54	-14.59	-	-	195	220	H
* 4.824	43.88	PK2	34.2	-31.4	0	46.68	-	-	74	-27.32	189	135	V
* 4.824	36.26	MAv1	34.2	-31.4	0	39.06	54	-14.94	-	-	189	135	V
7.235	45.29	PK2	35.8	-27.8	0	53.29	-	-	74	-20.71	156	100	H
7.236	41.68	PK2	35.8	-27.8	0	49.68	-	-	74	-24.32	115	352	V

* - indicates frequency in CFR47 Pt 15 / IC RSS-Restricted Band
 PK2 - KDB558074 Method: Maximum Peak
 MAv1 - KDB558074 Option 1 Maximum RMS Average

6 CHANNEL HORIZONTAL

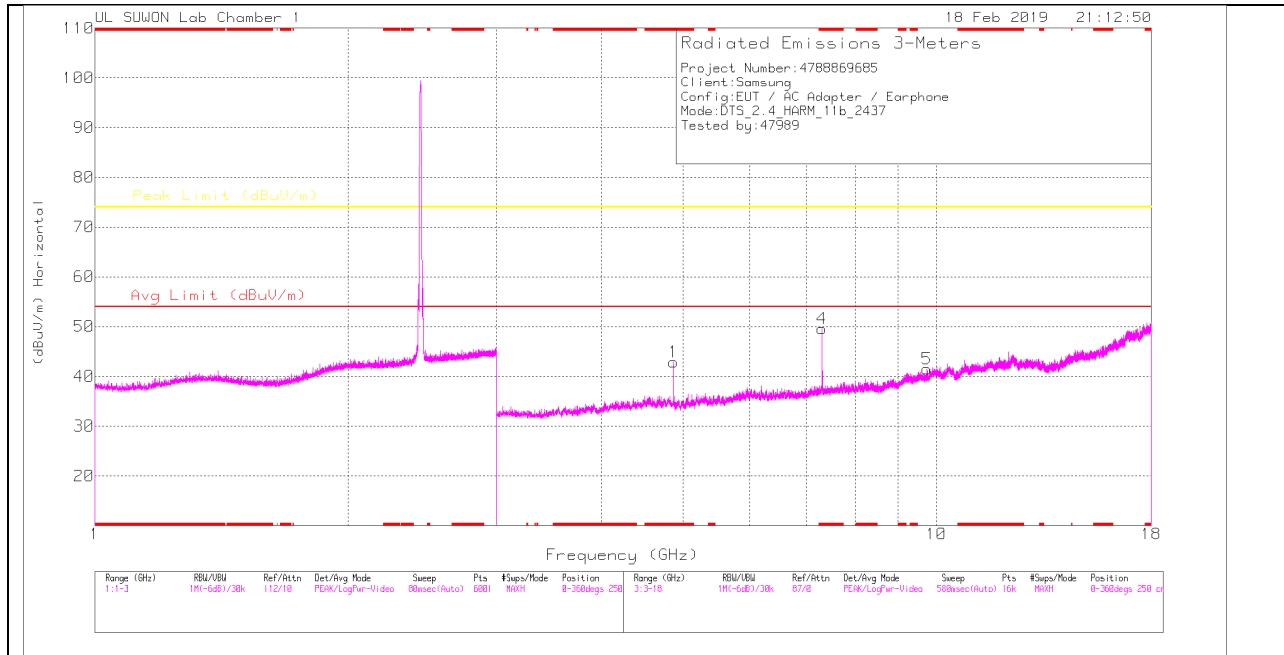

6 CHANNEL VERTICAL

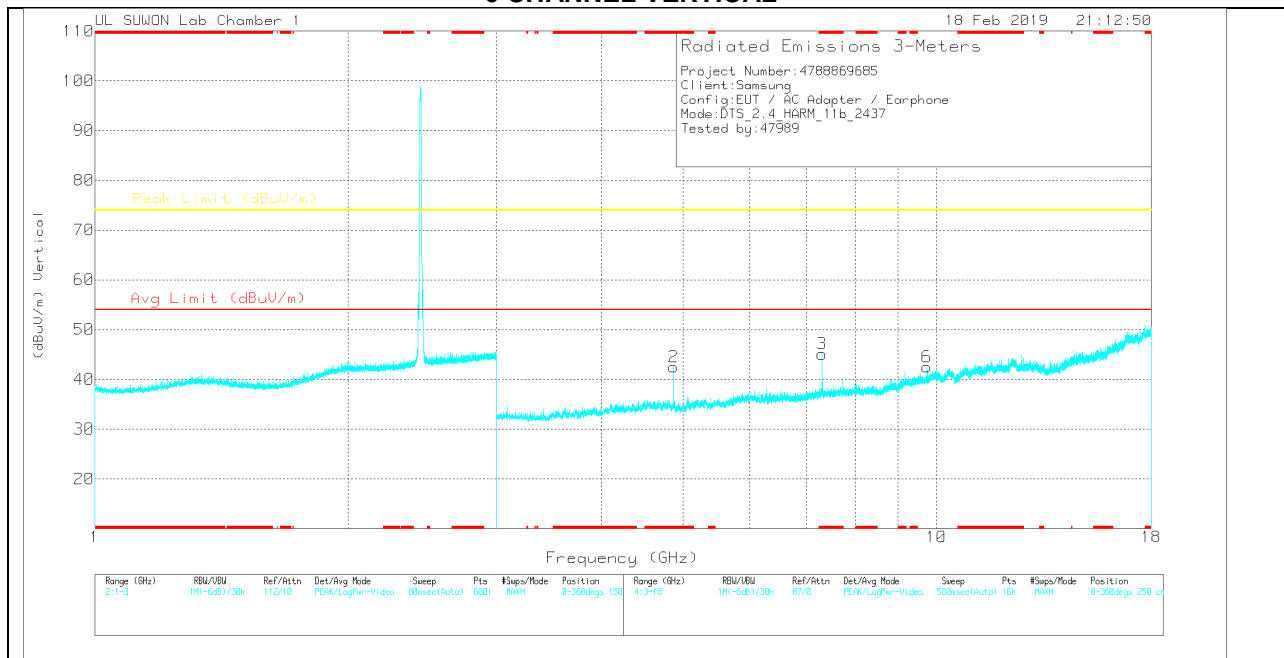

Note: Emission was scanned up to 26GHz; No emissions were detected above the noise floor which was at least 20dB below the specification limit.

6 CHANNEL DATA

Trace Markers

Marker	Frequency (GHz)	Meter Reading (dBuV)	Det	3117_00168717	3GHz_HP[dB]	DC Corr (dB)	Corrected Reading (dBuV/m)	Avg Limit (dBuV/m)	Margin (dB)	Peak Limit (dBuV/m)	Margin (dB)	Azimuth (Degs)	Height (cm)	Polarity
1	* 4.874	40.19	PK	34.2	-31.5	0	42.89	-	-	74	-31.11	0-360	250	H
4	* 7.309	41.17	PK	35.8	-27.4	0	49.57	-	-	74	-24.43	0-360	150	H
5	9.748	28.16	PK	37.2	-23.9	0	41.46	-	-	74	-32.54	0-360	150	H
2	* 4.874	39.81	PK	34.2	-31.5	0	42.51	-	-	74	-31.49	0-360	150	V
3	* 7.308	36.71	PK	35.8	-27.4	0	45.11	-	-	74	-28.89	0-360	150	V
6	9.748	29.24	PK	37.2	-23.9	0	42.54	-	-	74	-31.46	0-360	250	V

* - indicates frequency in CFR47 Pt 15 / IC RSS-Restricted Band
 PK – Peak detector

Radiated Emissions

Frequency (GHz)	Meter Reading (dBuV)	Det	3117_00168717	3GHz_HP[dB]	DC Corr (dB)	Corrected Reading (dBuV/m)	Avg Limit (dBuV/m)	Margin (dB)	Peak Limit (dBuV/m)	Margin (dB)	Azimuth (Degs)	Height (cm)	Polarity
* 4.874	45.5	PK2	34.2	-31.5	0	48.2	-	-	74	-25.8	130	270	H
* 4.874	39.91	MAv1	34.2	-31.5	0	42.61	54	-11.39	-	-	130	270	H
* 4.874	45.48	PK2	34.2	-31.5	0	48.18	-	-	74	-25.82	184	151	V
* 4.874	39.93	MAv1	34.2	-31.5	0	42.63	54	-11.37	-	-	184	151	V
* 7.31	43.65	PK2	35.8	-27.4	0	52.05	-	-	74	-21.95	126	116	V
* 7.31	36.78	MAv1	35.8	-27.5	0	45.08	54	-8.92	-	-	126	116	V
* 7.311	46.66	PK2	35.8	-27.4	0	55.06	-	-	74	-18.94	162	111	H
* 7.312	42.2	MAv1	35.8	-27.4	0	50.6	54	-3.4	-	-	162	111	H

* - indicates frequency in CFR47 Pt 15 / IC RSS-Restricted Band
 PK2 - KDB558074 Method: Maximum Peak
 MAv1 - KDB558074 Option 1 Maximum RMS Average

11 CHANNEL HORIZONTAL

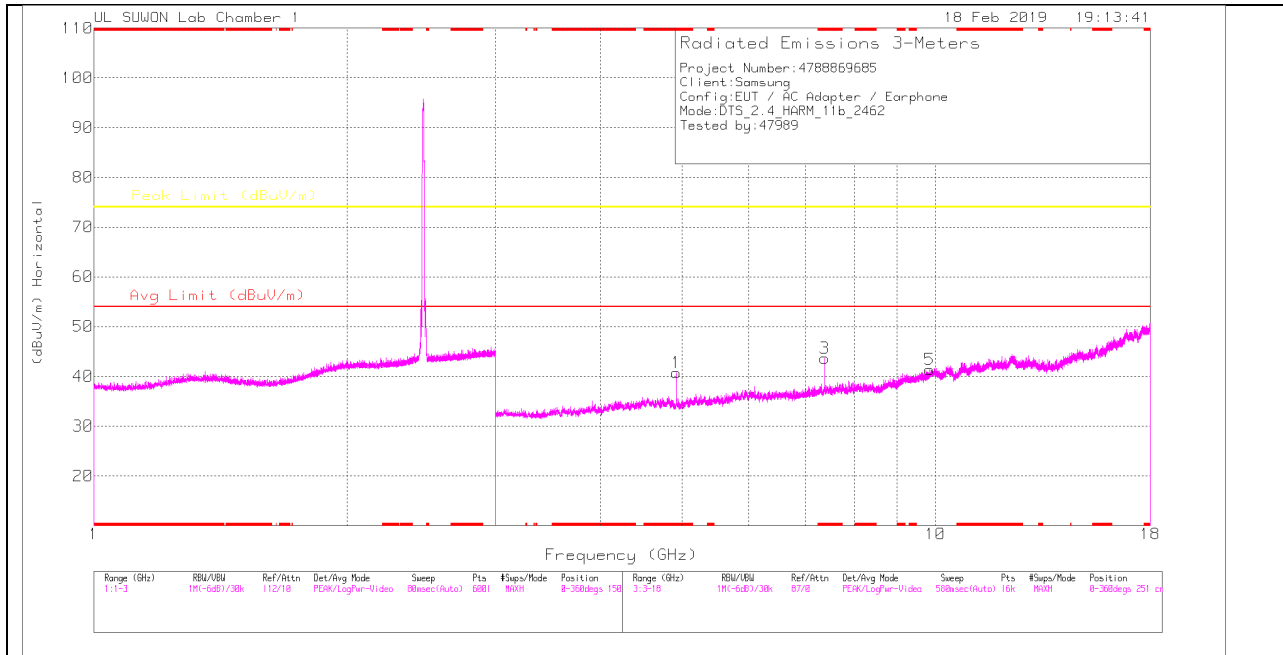

11 CHANNEL VERTICAL

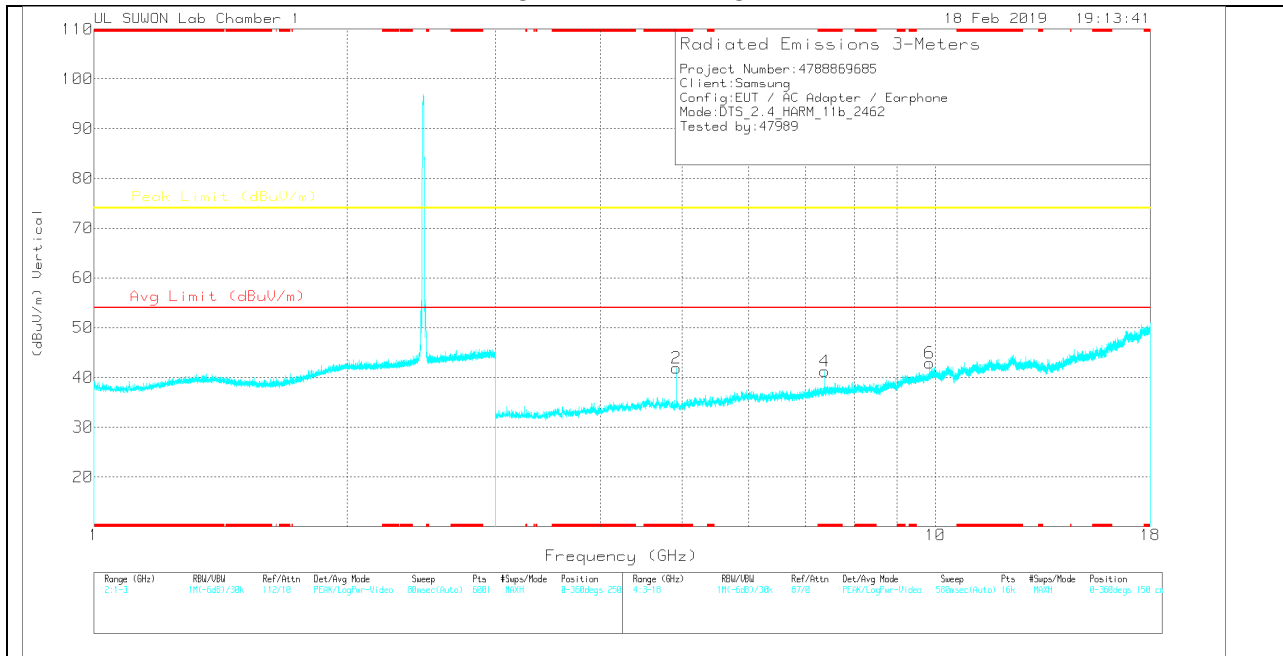

Note: Emission was scanned up to 26GHz; No emissions were detected above the noise floor which was at least 20dB below the specification limit.

11 CHANNEL DATA

Trace Markers

Trace Markers

Marker	Frequency (GHz)	Meter Reading (dBuV)	Det	3117_00168717	3GHz_HP[dB]	DC Corr (dB)	Corrected Reading (dBuV/m)	Avg Limit (dBuV/m)	Margin (dB)	Peak Limit (dBuV/m)	Margin (dB)	Azimuth (Degs)	Height (cm)	Polarity
1	* 4.924	38.1	PK	34.2	-31.6	0	40.7	-	-	74	-33.3	0-360	251	H
3	* 7.385	34.8	PK	35.8	-27	0	43.6	-	-	74	-30.4	0-360	150	H
5	9.848	27.16	PK	37.4	-23.2	0	41.36	-	-	74	-32.64	0-360	150	H
2	* 4.924	39.28	PK	34.2	-31.6	0	41.88	-	-	74	-32.12	0-360	150	V
4	* 7.385	32.41	PK	35.8	-27	0	41.21	-	-	74	-32.79	0-360	150	V
6	9.848	28.69	PK	37.4	-23.2	0	42.89	-	-	74	-31.11	0-360	251	V

* - indicates frequency in CFR47 Pt 15 / IC RSS-Restricted Band
 PK – Peak Detector

Radiated Emissions

Frequency (GHz)	Meter Reading (dBuV)	Det	3117_00168717	3GHz_HP[dB]	DC Corr (dB)	Corrected Reading (dBuV/m)	Avg Limit (dBuV/m)	Margin (dB)	Peak Limit (dBuV/m)	Margin (dB)	Azimuth (Degs)	Height (cm)	Polarity
* 4.924	44.81	PK2	34.2	-31.6	0	47.41	-	-	74	-26.59	193	242	H
* 4.924	39.18	MAv1	34.2	-31.6	0	41.78	54	-12.22	-	-	193	242	H
* 4.924	45.81	PK2	34.2	-31.6	0	48.41	-	-	74	-25.59	189	106	V
* 4.924	40.11	MAv1	34.2	-31.6	0	42.71	54	-11.29	-	-	189	106	V
* 7.386	42.64	PK2	35.8	-27	0	51.44	-	-	74	-22.56	163	108	H
* 7.385	35.88	MAv1	35.8	-27	0	44.68	54	-9.32	-	-	163	108	H
* 7.386	40.06	PK2	35.8	-27	0	48.86	-	-	74	-25.14	131	145	V
* 7.385	30.88	MAv1	35.8	-27	0	39.68	54	-14.32	-	-	131	145	V

* - indicates frequency in CFR47 Pt 15 / IC RSS-Restricted Band
 PK2 - KDB558074 Method: Maximum Peak
 MAv1 - KDB558074 Option 1 Maximum RMS Average

11.2.2.TX ABOVE 1 GHz 802.11g MODE IN THE 2.4 GHz BAND

RESTRICTED BANDEDGE (1 CHANNEL)

HORIZONTAL PEAK AND AVERAGE PLOT

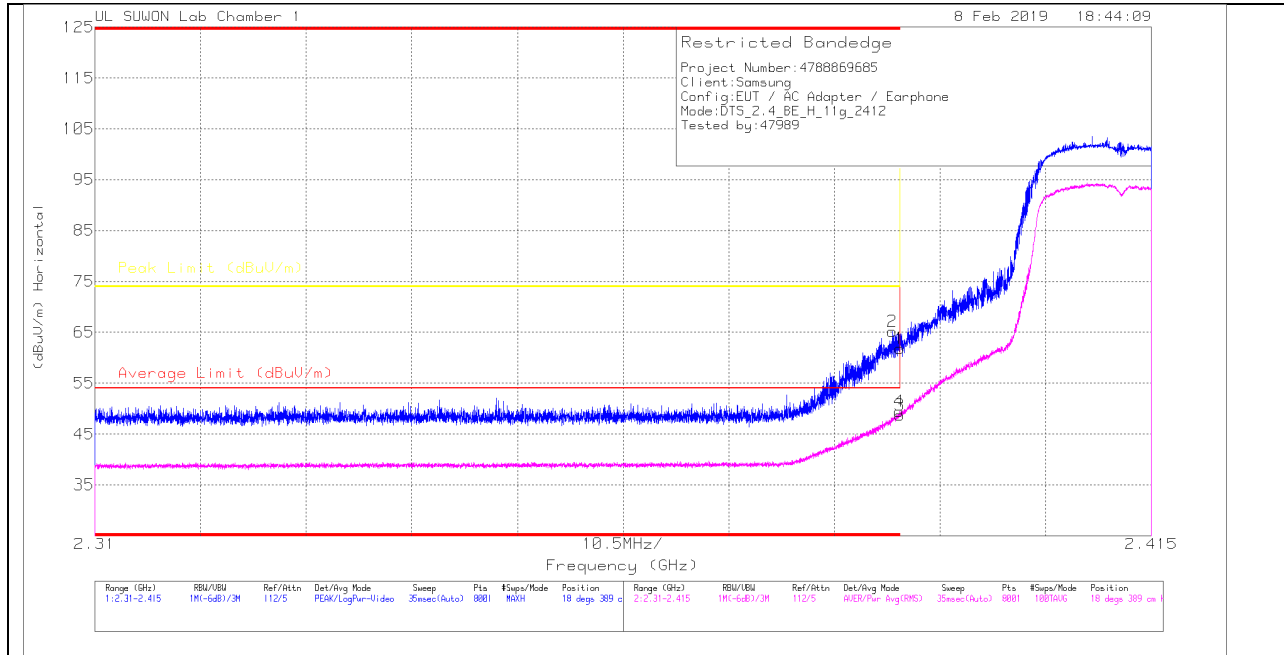

HORIZONTAL DATA

Trace Markers

Marker	Frequency (GHz)	Meter Reading (dBuV)	Det	3117_00168717	10dB(dB)	DC Corr (dB)	Corrected Reading (dBuV/m)	Average Limit (dBuV/m)	Margin (dB)	Peak Limit (dBuV/m)	PK Margin (dB)	Altitude (Degs)	Height (cm)	Polarity
1	* 2.39	55.66	Pk	31.7	-25.5	0	61.86	-	-	74	-12.14	18	389	H
2	* 2.389	58.95	Pk	31.7	-25.5	0	65.15	-	-	74	-8.85	18	389	H
3	* 2.39	42.27	RMS	31.7	-25.5	.2	48.67	54	-5.33	-	-	18	389	H
4	* 2.39	43.05	RMS	31.7	-25.5	.2	49.45	54	-4.55	-	-	18	389	H

* - indicates frequency in CFR47 Pt 15 / IC RSS-Restricted Band

Pk - Peak detector

RMS - RMS detection

VERTICAL PEAK AND AVERAGE PLOT

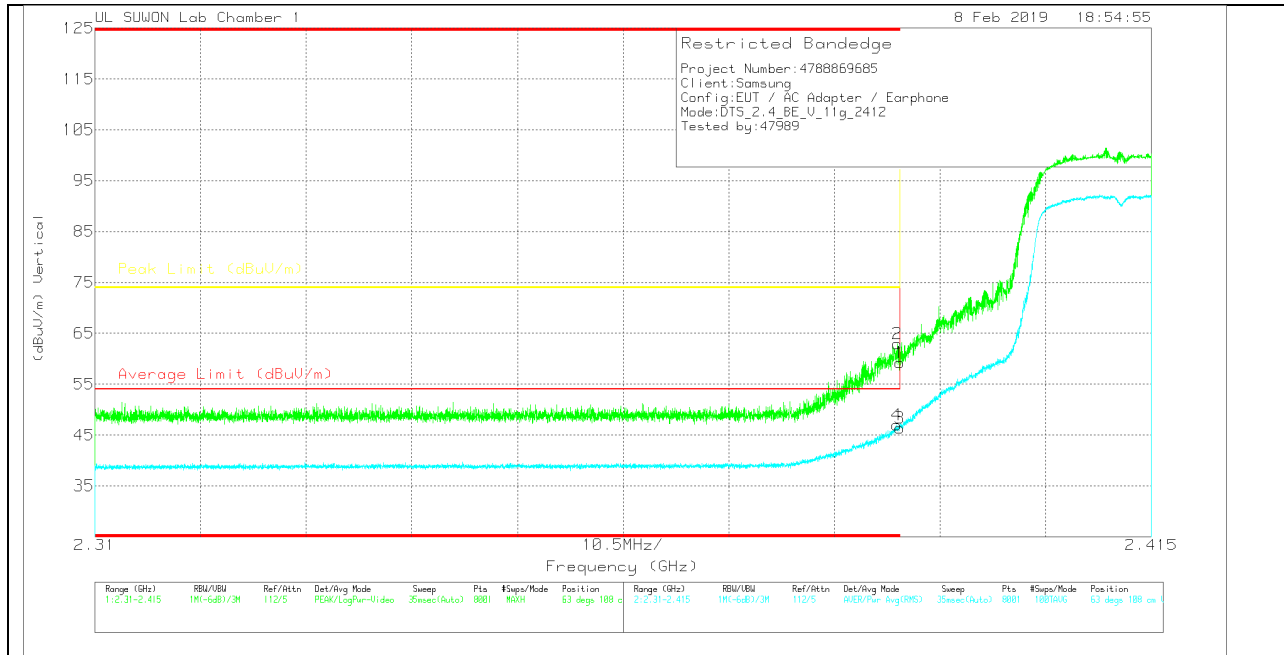

VERTICAL DATA

Trace Markers

Marker	Frequency (GHz)	Meter Reading (dBu/m)	Det	3117_00168717	10dB(dB)	DC Corr (dB)	Corrected Reading (dBu/m)	Average Limit (dBu/m)	Margin (dB)	Peak Limit (dBu/m)	PK Margin (dB)	Azimuth (Degs)	Height (cm)	Polarity
1	* 2.39	53.08	Pk	31.7	-25.5	0	59.28	-	-	74	-14.72	63	108	V
2	* 2.39	56.75	Pk	31.7	-25.5	0	62.95	-	-	74	-11.05	63	108	V
3	* 2.39	39.94	RMS	31.7	-25.5	.2	46.34	54	-7.66	-	-	63	108	V
4	* 2.39	40.55	RMS	31.7	-25.5	.2	46.95	54	-7.05	-	-	63	108	V

* - indicates frequency in CFR47 Pt 15 / IC RSS-Restricted Band

Pk - Peak detector

RMS - RMS detection

AUTHORIZED BANDEDGE (11 CHANNEL)

HORIZONTAL PEAK AND AVERAGE PLOT

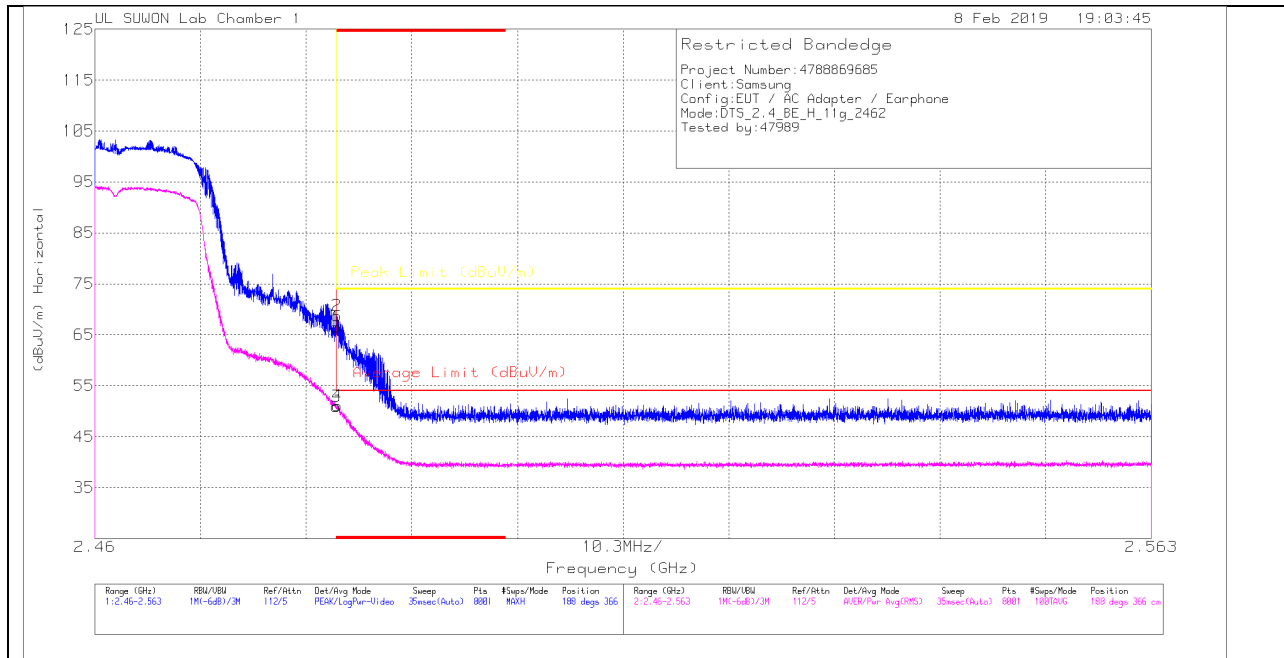

HORIZONTAL DATA

Trace Markers

Marker	Frequency (GHz)	Meter Reading (dBuV)	Det	3117_00168717	10dB(dB)	DC Corr (dB)	Corrected Reading (dBuV/m)	Average Limit (dBuV/m)	Margin (dB)	Peak Limit (dBuV/m)	PK Margin (dB)	Altitude (Degs)	Height (cm)	Polarity
1	* 2.484	59.9	Pk	31.9	-25.3	0	66.5	-	-	74	-7.5	188	366	H
2	* 2.484	62.1	Pk	31.9	-25.3	0	68.7	-	-	74	-5.3	188	366	H
3	* 2.484	44.19	RMS	31.9	-25.3	.2	50.99	54	-3.01	-	-	188	366	H
4	* 2.484	44.25	RMS	31.9	-25.3	.2	51.05	54	-2.95	-	-	188	366	H

* - indicates frequency in CFR47 Pt 15 / IC RSS-Restricted Band

Pk - Peak detector

RMS - RMS detection

VERTICAL PEAK AND AVERAGE PLOT

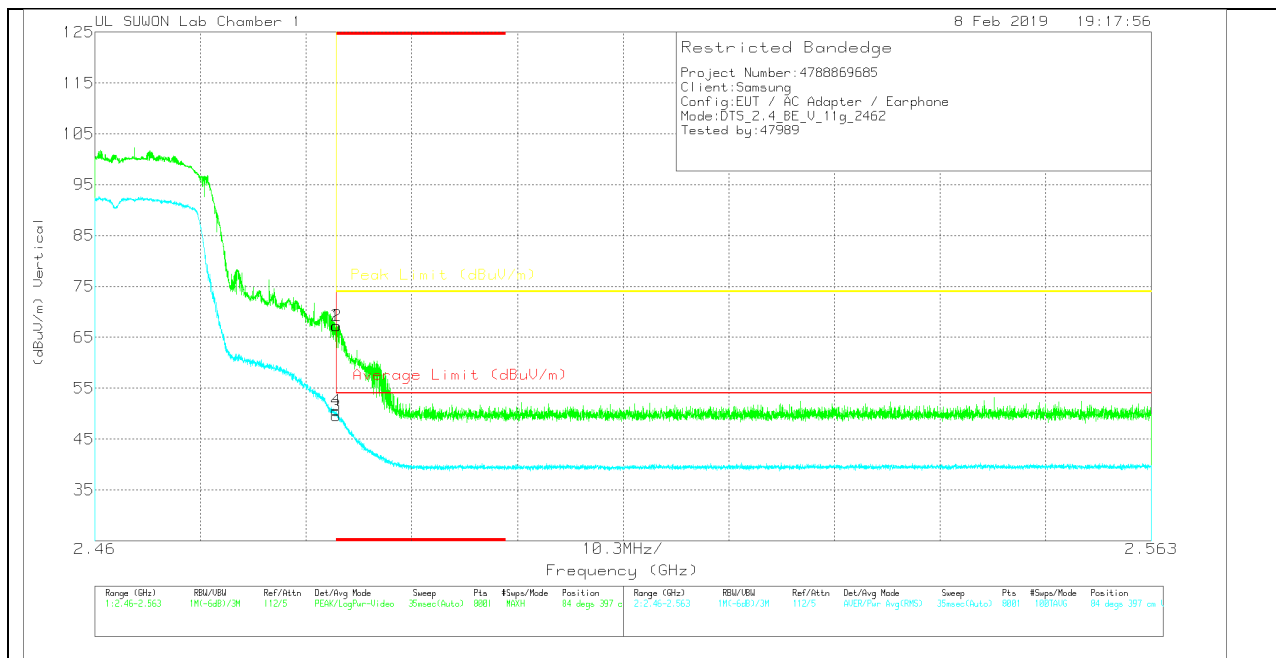

VERTICAL DATA

Trace Markers

Marker	Frequency (GHz)	Meter Reading (dBuV)	Det	3117_00168717	10dB(dB)	DC Corr (dB)	Corrected Reading (dBuV/m)	Average Limit (dBuV/m)	Margin (dB)	Peak Limit (dBuV/m)	PK Margin (dB)	Azimuth (Deg)	Height (cm)	Polarity
1	* 2.484	60.62	Pk	31.9	-25.3	0	67.22	-	-	74	-6.78	84	397	V
2	* 2.484	60.71	Pk	31.9	-25.3	0	67.31	-	-	74	-6.69	84	397	V
3	* 2.484	42.78	RMS	31.9	-25.3	.2	49.58	54	-4.42	-	-	84	397	V
4	* 2.484	43.76	RMS	31.9	-25.3	.2	50.56	54	-3.44	-	-	84	397	V

* - indicates frequency in CFR47 Pt 15 / IC RSS-Restricted Band

Pk - Peak detector

RMS - RMS detection

AUTHORIZED BANDEDGE (12 CHANNEL)

HORIZONTAL PEAK AND AVERAGE PLOT

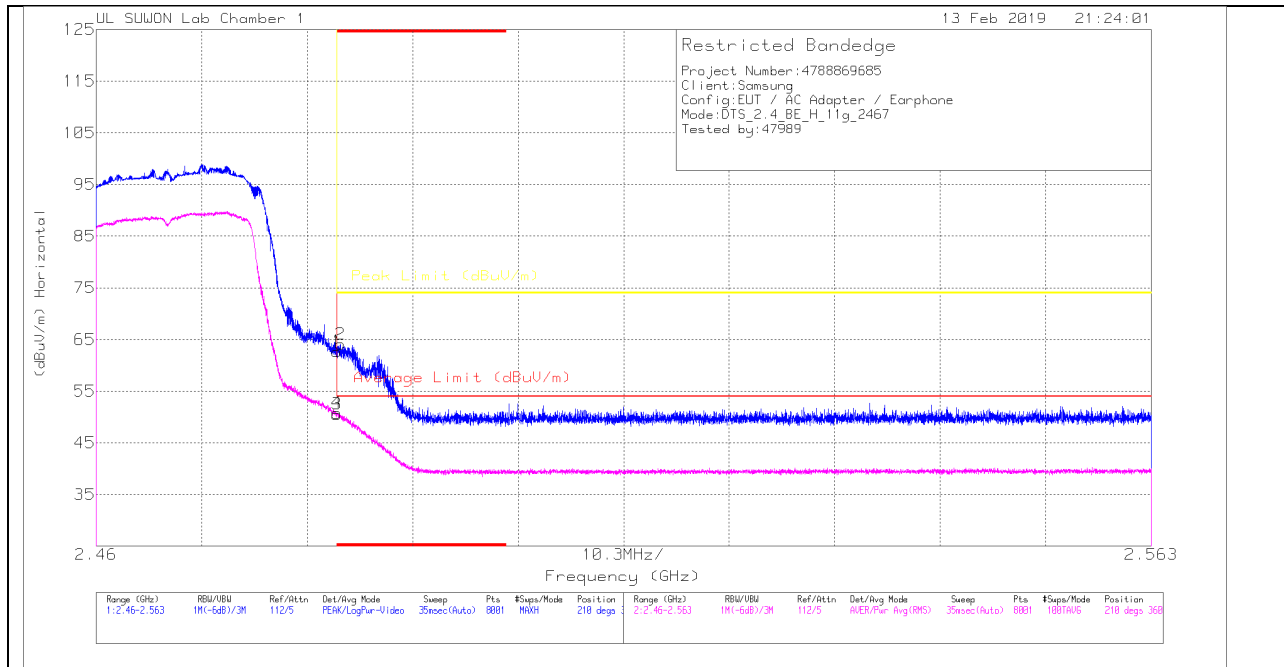

HORIZONTAL DATA

Trace Markers

Marker	Frequency (GHz)	Meter Reading (dBuV)	Det	3117_00168717	10dB(dB)	DC Corr (dB)	Corrected Reading (dBuV/m)	Average Limit (dBuV/m)	Margin (dB)	Peak Limit (dBuV/m)	PK Margin (dB)	Aimuth (Degs)	Height (cm)	Polarity
1	* 2.484	56.08	Pk	31.9	-25.3	0	62.68	-	-	74	-11.32	210	360	H
2	* 2.484	57.5	Pk	31.9	-25.3	0	64.1	-	-	74	-9.9	210	360	H
3	* 2.484	43.74	RMS	31.9	-25.3	.2	50.54	54	-3.46	-	-	210	360	H
4	* 2.484	44	RMS	31.9	-25.3	.2	50.8	54	-3.2	-	-	210	360	H

* - indicates frequency in CFR47 Pt 15 / IC RSS-Restricted Band

Pk - Peak detector

RMS - RMS detection

VERTICAL PEAK AND AVERAGE PLOT

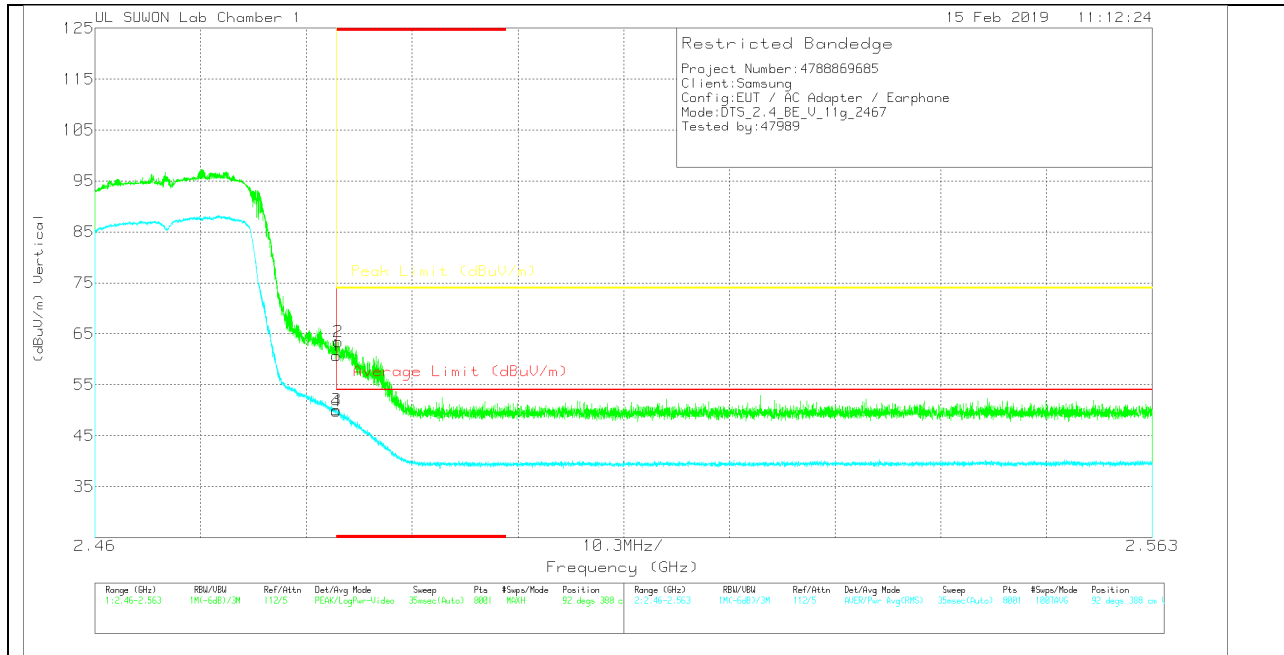

VERTICAL DATA

Trace Markers

Marker	Frequency (GHz)	Meter Reading (dBuV)	Det	3117_00168717	10dB(dB)	DC Corr (dB)	Corrected Reading (dBuV/m)	Average Limit (dBuV/m)	Margin (dB)	Peak Limit (dBuV/m)	PK Margin (dB)	Altitude (Deg)	Height (cm)	Polarity
1	* 2.484	54.1	PK	31.9	-25.3	0	60.7	-	-	74	-13.3	92	388	V
2	* 2.484	56.8	PK	31.9	-25.3	0	63.4	-	-	74	-10.6	92	388	V
3	* 2.484	43.26	RMS	31.9	-25.3	.2	50.06	54	-3.94	-	-	92	388	V
4	* 2.484	43.07	RMS	31.9	-25.3	.2	49.87	54	-4.13	-	-	92	388	V

* - indicates frequency in CFR47 Pt 15 / IC RSS-Restricted Band
 PK - Peak detector
 RMS - RMS detection

AUTHORIZED BANDEDGE (13 CHANNEL)

HORIZONTAL PEAK AND AVERAGE PLOT

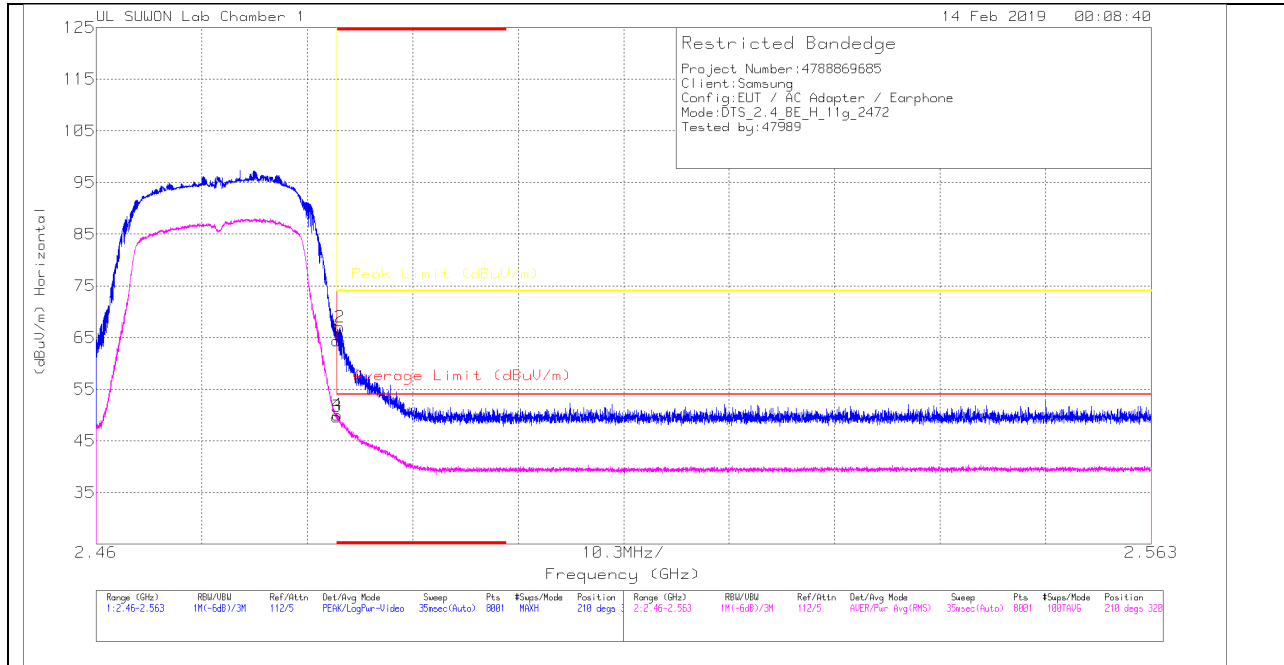

HORIZONTAL DATA

Trace Markers

Marker	Frequency (GHz)	Meter Reading (dBuV)	Det	3117_00168717	10dB(dB)	DC Corr (dB)	Corrected Reading (dBuV/m)	Average Limit (dBuV/m)	Margin (dB)	Peak Limit (dBuV/m)	PK Margin (dB)	Aimuth (Degs)	Height (cm)	Polarity
1	* 2.484	57.79	Pk	31.9	-25.3	0	64.39	-	-	74	-9.61	210	320	H
2	* 2.484	60.38	Pk	31.9	-25.3	0	66.98	-	-	74	-7.02	210	320	H
3	* 2.484	42.89	RMS	31.9	-25.3	.2	49.69	54	-4.31	-	-	210	320	H
4	* 2.484	43.25	RMS	31.9	-25.3	.2	50.05	54	-3.95	-	-	210	320	H

* - indicates frequency in CFR47 Pt 15 / IC RSS-Restricted Band

Pk - Peak detector

RMS - RMS detection

VERTICAL PEAK AND AVERAGE PLOT

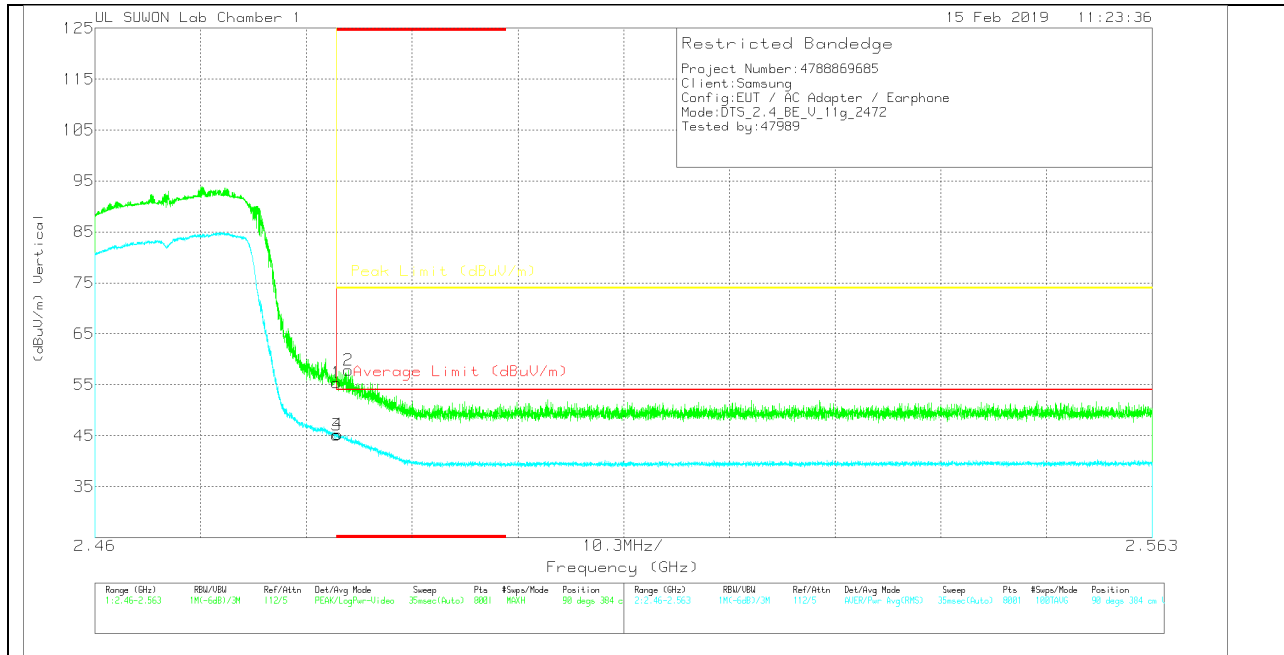

VERTICAL DATA

Trace Markers

Marker	Frequency (GHz)	Meter Reading (dBuV)	Det	3117_00168717	10dB(dB)	DC Corr (dB)	Corrected Reading (dBuV/m)	Average Limit (dBuV/m)	Margin (dB)	Peak Limit (dBuV/m)	PK Margin (dB)	Altitude (Deg)	Height (cm)	Polarity
1	* 2.484	48.84	PK	31.9	-25.3	0	55.44	-	-	74	-18.56	90	384	V
2	* 2.485	51.3	PK	31.9	-25.3	0	57.9	-	-	74	-16.1	90	384	V
3	* 2.484	38.35	RMS	31.9	-25.3	.2	45.15	54	-8.85	-	-	90	384	V
4	* 2.484	38.42	RMS	31.9	-25.3	.2	45.22	54	-8.78	-	-	90	384	V

* - indicates frequency in CFR47 Pt 15 / IC RSS-Restricted Band
 PK - Peak detector
 RMS - RMS detection

HARMONICS AND SPURIOUS EMISSIONS

1 CHANNEL HORIZONTAL

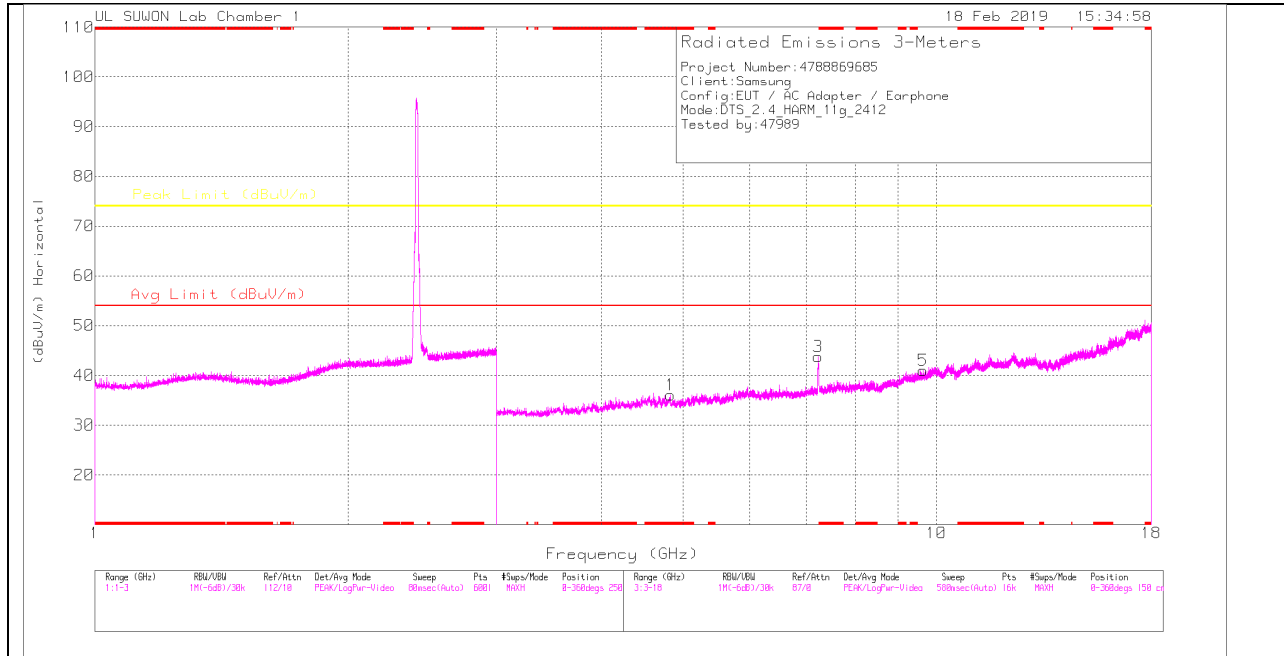

1 CHANNEL VERTICAL

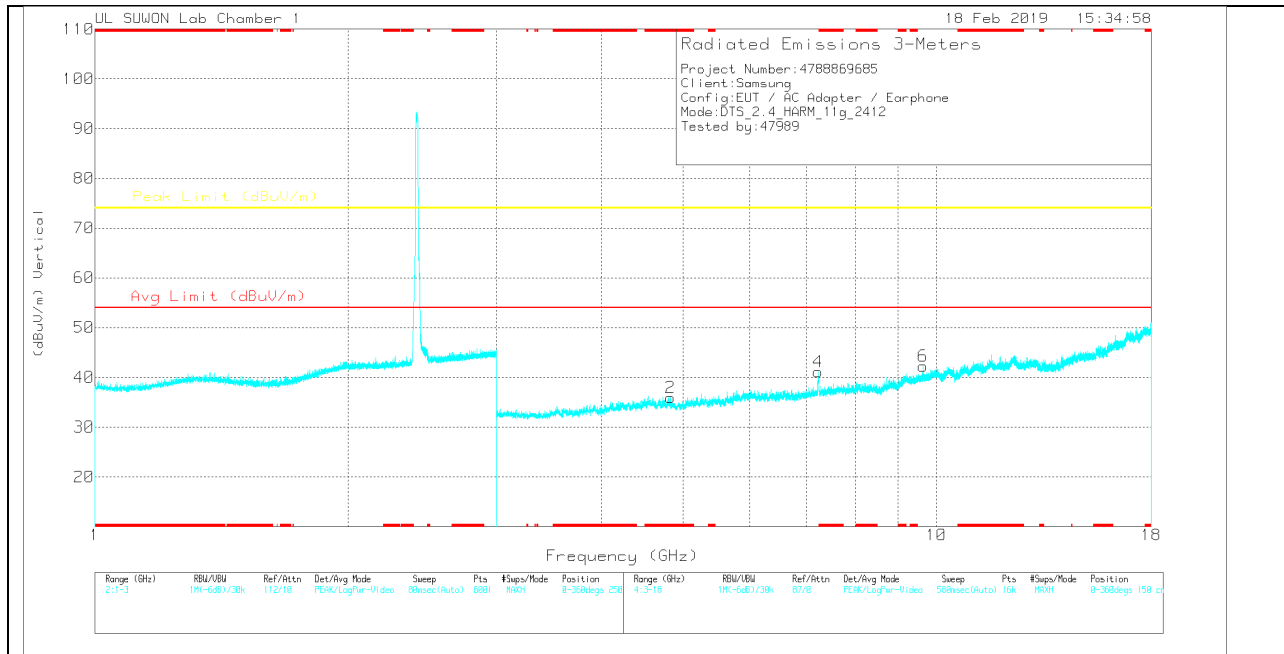

Note: Emission was scanned up to 26GHz; No emissions were detected above the noise floor which was at least 20dB below the specification limit.

1 CHANNEL DATA

Trace Markers

Marker	Frequency (GHz)	Meter Reading (dBuV)	Det	3117_00168717	3GHz_HP[dB]	DC Corr (dB)	Corrected Reading (dBuV/m)	Avg Limit (dBuV/m)	Margin (dB)	Peak Limit (dBuV/m)	Margin (dB)	Azimuth (Degs)	Height (cm)	Polarity
1	* 4.826	33.18	PK	34.2	-31.3	0	36.08	-	-	74	-37.92	0-360	150	H
3	7.233	35.9	PK	35.8	-27.9	0	43.8	-	-	74	-30.2	0-360	150	H
5	9.647	27.19	PK	37.1	-23.3	0	40.99	-	-	74	-33.01	0-360	150	H
2	* 4.827	33.05	PK	34.2	-31.3	0	35.95	-	-	74	-38.05	0-360	150	V
4	7.233	33.26	PK	35.8	-27.9	0	41.16	-	-	74	-32.84	0-360	250	V
6	9.648	28.51	PK	37.1	-23.3	0	42.31	-	-	74	-31.69	0-360	250	V

* - indicates frequency in CFR47 Pt 15 / IC RSS-Restricted Band
 PK – Peak Detector

Radiated Emissions

Frequency (GHz)	Meter Reading (dBuV)	Det	3117_00168717	3GHz_HP[dB]	DC Corr (dB)	Corrected Reading (dBuV/m)	Avg Limit (dBuV/m)	Margin (dB)	Peak Limit (dBuV/m)	Margin (dB)	Azimuth (Degs)	Height (cm)	Polarity
7.241	48.19	PK2	35.8	-27.8	0	56.19	-	-	74	-17.81	169	104	H
7.241	43.69	PK2	35.8	-27.8	0	51.69	-	-	74	-22.31	151	142	V
9.648	36.79	PK2	37.1	-23.3	0	50.59	-	-	74	-23.41	216	202	H
9.648	36.18	PK2	37.1	-23.3	0	49.98	-	-	74	-24.02	85	108	V

* - indicates frequency in CFR47 Pt 15 / IC RSS-Restricted Band
 PK2 - KDB558074 Method: Maximum Peak