

FCC TAS validation – Part 2:

Tests under dynamic transmit power scenarios

The following samples were submitted and identified on behalf of the client as:

Equipment Under Test	SAMSUNG Mobile Phone
Brand Name	Galaxy A Series
Model No.	SM-A156E/DS
Family Model No.	SM-A156M/DSN
Model Difference:	Please refer to section 1.3
Applicant	SAMSUNG Electronics Co., Ltd. 129, Samsung-ro, Yeongtong-gu, Suwon-si, Gyeonggi-do, 16677, Rep. of Korea
FCC ID	A3LSMA156E
Date of Receipt	Oct. 05, 2023
Date of Test(s)	Oct. 24, 2023 ~ Oct. 29, 2023
Date of Issue	Nov. 15, 2023

In the configuration tested, the EUT complied with the standards specified above.

Remarks:

This report details the results of the testing carried out on one sample, the results contained in this test report do not relate to other samples of the same product. The manufacturer should ensure that all products in series production are in conformity with the product sample detailed in this report.

This report may only be reproduced and distributed in full. If the product in this report is used in any configuration other than that detailed in the report, the manufacturer must ensure the new system complies with all relevant standards. Any mention of SGS Taiwan Ltd. Central RF Lab or testing done by SGS Taiwan Ltd. Central RF Lab in connection with distribution or use of the product described in this report must be approved by SGS Taiwan Ltd. Central RF Lab in writing.

Signed on behalf of SGS

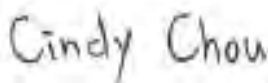
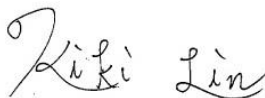
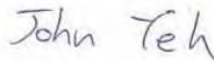
Clerk / Cindy Chou	PM / Kiki Lin	Approved By / John Yeh
		

Date: Nov. 15, 2023

Unless otherwise stated the results shown in this test report refer only to the sample(s) tested and such sample(s) are retained for 90 days only.

除非另有說明，此報告結果僅對測試之樣品負責，同時此樣品僅保留90天。本報告未經本公司書面許可，不可部份複製。

This document is issued by the Company subject to its General Conditions of Service printed overleaf, available on request or accessible at <http://www.sgs.com.tw/Terms-and-Conditions> and for electronic format documents, subject to Terms and Conditions for Electronic Documents at <http://www.sgs.com.tw/Terms-and-Conditions>. Attention is drawn to the limitation of liability, indemnification and jurisdiction issues defined therein. Any holder of this document is advised that information contained hereon reflects the Company's findings at the time of its intervention only and within the limits of Client's instructions, if any. The Company's sole responsibility is to its Client and this document does not exonerate parties to a transaction from exercising all their rights and obligations under the transaction documents. This document cannot be reproduced except in full, without prior written approval of the Company. Any unauthorized alteration, forgery or falsification of the content or appearance of this document is unlawful and offenders may be prosecuted to the fullest extent of the law.

Revision History

Report Number	Revision	Description	Issue Date	Revised By	Remark
TESA2310000628ES	00	Initial creation of document	Nov. 02, 2023	Cindy Chou	
TESA2310000628ES	01	Modify comment	Nov. 15, 2023	Cindy Chou	*

Note:

1. The mark " * " is the revised version of the report due to comments submitted by the certification.
2. Measurement results in the original test report TESA2310000627ES are fully leveraged in this test report.

Unless otherwise stated the results shown in this test report refer only to the sample(s) tested and such sample(s) are retained for 90 days only.

除非另有說明，此報告結果僅對測試之樣品負責，同時此樣品僅保留90天。本報告未經本公司書面許可，不可部份複製。

This document is issued by the Company subject to its General Conditions of Service printed overleaf, available on request or accessible at <http://www.sgs.com.tw/Terms-and-Conditions> and for electronic format documents, subject to Terms and Conditions for Electronic Documents at <http://www.sgs.com.tw/Terms-and-Conditions>. Attention is drawn to the limitation of liability, indemnification and jurisdiction issues defined therein. Any holder of this document is advised that information contained hereon reflects the Company's findings at the time of its intervention only and within the limits of Client's instructions, if any. The Company's sole responsibility is to its Client and this document does not exonerate parties to a transaction from exercising all their rights and obligations under the transaction documents. This document cannot be reproduced except in full, without prior written approval of the Company. Any unauthorized alteration, forgery or falsification of the content or appearance of this document is unlawful and offenders may be prosecuted to the fullest extent of the law.

SGS Taiwan Ltd.

No.134,Wu Kung Road, New Taipei Industrial Park, Wuku District, New Taipei City, Taiwan/新北市五股區新北產業園區五工路 134 號

台灣檢驗科技股份有限公司

t (886-2) 2299-3279

f (886-2) 2298-0488

www.sgs.com.tw

Member of SGS Group

Contents

1.General Information	5
1.1 Testing Laboratory	5
1.2 Details of Applicant	5
1.3 Details of EUT.....	6
2.Overview	7
3.MediaTek TAS feature Operation Description	8
3.1 Operating Parameters for Algorithm Validation.....	8
3.2 Overview of TA-SAR Test Proposal.....	9
4.TA-SAR Test Scenarios and Test Procedures	10
4.1 Test Sequences for All Scenarios.....	11
4.2 Test Configuration and Procedure for Scenario 1: Range of TA-SAR Parameters via Conducted Power Measurements.....	16
4.3 Test Configuration and Procedure for Scenario 2: Time-Varying TX Power via Conducted Power Measurements.....	18
4.4 Test Configuration and Procedure for Scenario 3: Call Disconnection and Re-establishment via Conducted Power Measurements.....	20
4.5 Test Configuration and Procedure for Scenario 4: Band Handover via Conducted Power Measurements.....	22
4.6 Test Configuration and Procedure for Scenario 5: Exposure Condition Index (ECI) Change via Conducted Power Measurements.....	24
4.7 Test Configuration and Procedure for Scenario 6 Antenna Switching via Conducted Power Measurements.....	25
4.8 Test Configuration and Procedure for Scenario 7: Time Window Switching via Conducted Power Measurements.....	26
4.9 Test Configuration and Procedure for Scenario 8: SAR Exposure Switching via Conducted Power Measurements.....	29
4.10 Test Configuration and Procedure for Scenario 2: Time-Varying TX Power via SAR Measurements.....	32
5.TA-SAR Validation via Conducted Power Measurements	34
5.1 Measurement Setup	34
5.2 Conducted Power Measurement Results for Scenario1: Range of TA-SAR Parameters	41
5.3 Conducted Power Measurement Results for Scenario 2: Time-Varying TX Power	44
5.4 Conducted Power Measurement Results for Scenario 3: Call Disconnection and Re-establishment.....	77
5.5 Conducted Power Measurement Results for Scenario 4: Band Handover.....	80
5.6 Conducted Power Measurement Results for Scenario 5: ECI Change.....	83
5.7 Conducted Power Measurement Results for Scenario 8: SAR Exposure Switching.....	86
6 TA-SAR Validation via SAR Measurements	89
6.4 Measurement Setup	89
6.5 SAR Measurement Results for Scenario 2: Time-Varying TX Power.....	90
7 Conclusions.....	105
Appendix A. cDASY6 System Verification.....	106
Appendix B. Instruments List.....	108
Appendix C Tissue and System Verification	109

Unless otherwise stated the results shown in this test report refer only to the sample(s) tested and such sample(s) are retained for 90 days only.

除非另有說明，此報告結果僅對測試之樣品負責，同時此樣品僅保留90天。本報告未經本公司書面許可，不可部份複製。

This document is issued by the Company subject to its General Conditions of Service printed overleaf, available on request or accessible at <http://www.sgs.com.tw/Terms-and-Conditions> and for electronic format documents, subject to Terms and Conditions for Electronic Documents at <http://www.sgs.com.tw/Terms-and-Conditions>. Attention is drawn to the limitation of liability, indemnification and jurisdiction issues defined therein. Any holder of this document is advised that information contained herein reflects the Company's findings at the time of its intervention only and within the limits of Client's instructions, if any. The Company's sole responsibility is to its Client and this document does not exonerate parties to a transaction from exercising all their rights and obligations under the transaction documents. This document cannot be reproduced except in full, without prior written approval of the Company. Any unauthorized alteration, forgery or falsification of the content or appearance of this document is unlawful and offenders may be prosecuted to the fullest extent of the law.

Appendix D Measurement uncertainty	112
8 SAR SYSTEM CHECK RESULTS	113
9.APPENDIXES	116
9.1 SAR_Appendix E Photographs.....	116
9.2 SAR_Appendix F DAE & Probe Cal. Certificate.....	116
9.3 SAR_Appendix G Phantom Description & Dipole Cal. Certificate.....	116

Unless otherwise stated the results shown in this test report refer only to the sample(s) tested and such sample(s) are retained for 90 days only.

除非另有說明，此報告結果僅對測試之樣品負責，同時此樣品僅保留90天。本報告未經本公司書面許可，不可部份複製。

This document is issued by the Company subject to its General Conditions of Service printed overleaf, available on request or accessible at <http://www.sgs.com.tw/Terms-and-Conditions> and for electronic format documents, subject to Terms and Conditions for Electronic Documents at <http://www.sgs.com.tw/Terms-and-Conditions>. Attention is drawn to the limitation of liability, indemnification and jurisdiction issues defined therein. Any holder of this document is advised that information contained hereon reflects the Company's findings at the time of its intervention only and within the limits of Client's instructions, if any. The Company's sole responsibility is to its Client and this document does not exonerate parties to a transaction from exercising all their rights and obligations under the transaction documents. This document cannot be reproduced except in full, without prior written approval of the Company. Any unauthorized alteration, forgery or falsification of the content or appearance of this document is unlawful and offenders may be prosecuted to the fullest extent of the law.

1. General Information

1.1 Testing Laboratory

Laboratory	Test Site Address	Test Site Name	FCC Designation number	IC CAB identifier
SGS Taiwan Ltd. Central RF Lab. (TAF code 3702)	1F, No. 8, Alley 15, Lane 120, Sec. 1, NeiHu Road, NeiHu District, Taipei City, 11493, Taiwan.	SAR 2	TW0029	TW3702
		SAR 6		
	No. 2, Keji 1st Rd., Guishan Township, Taoyuan County, 33383, Taiwan	SAR 1	TW0028	
		SAR 4		
	No.134, Wu Kung Road, New Taipei Industrial Park, Wuku District, New Taipei City, Taiwan	SAR 3	TW0027	
		SAR 7		

Note: Test site name is remarked on the equipment list in each section of this report as an indication where measurements occurred in specific test site and address.

1.2 Details of Applicant

Company Name	SAMSUNG Electronics Co., Ltd.
Company Address	129, Samsung-ro, Yeongtong-gu, Suwon-si, Gyeonggi-do, 16677, Rep. of Korea

Unless otherwise stated the results shown in this test report refer only to the sample(s) tested and such sample(s) are retained for 90 days only.

除非另有說明，此報告結果僅對測試之樣品負責，同時此樣品僅保留90天。本報告未經本公司書面許可，不可部份複製。

This document is issued by the Company subject to its General Conditions of Service printed overleaf, available on request or accessible at <http://www.sgs.com.tw/Terms-and-Conditions> and for electronic format documents, subject to Terms and Conditions for Electronic Documents at <http://www.sgs.com.tw/Terms-and-Conditions>. Attention is drawn to the limitation of liability, indemnification and jurisdiction issues defined therein. Any holder of this document is advised that information contained hereon reflects the Company's findings at the time of its intervention only and within the limits of Client's instructions, if any. The Company's sole responsibility is to its Client and this document does not exonerate parties to a transaction from exercising all their rights and obligations under the transaction documents. This document cannot be reproduced except in full, without prior written approval of the Company. Any unauthorized alteration, forgery or falsification of the content or appearance of this document is unlawful and offenders may be prosecuted to the fullest extent of the law.

1.3 Details of EUT

The only difference between the SM-A156M/DSN and the SM-A156E/DSN is:

Hardware

- AP/CP/TRCV/PMIC are same.
- BT/WIFI/GPS parts are exactly same.
- PCB layout is exactly same.
- Mechanic parts are exactly same.
- LTE band: delete B13, add B20
- 5G NR band: add n8/26/28/77
- Delete LTE B2 TX switch (U1005).
- Delete LTE B13 duplexer (F1001).

Unless otherwise stated the results shown in this test report refer only to the sample(s) tested and such sample(s) are retained for 90 days only.

除非另有說明，此報告結果僅對測試之樣品負責，同時此樣品僅保留90天。本報告未經本公司書面許可，不可部份複製。

This document is issued by the Company subject to its General Conditions of Service printed overleaf, available on request or accessible at <http://www.sgs.com.tw/Terms-and-Conditions> and for electronic format documents, subject to Terms and Conditions for Electronic Documents at <http://www.sgs.com.tw/Terms-and-Conditions>. Attention is drawn to the limitation of liability, indemnification and jurisdiction issues defined therein. Any holder of this document is advised that information contained hereon reflects the Company's findings at the time of its intervention only and within the limits of Client's instructions, if any. The Company's sole responsibility is to its Client and this document does not exonerate parties to a transaction from exercising all their rights and obligations under the transaction documents. This document cannot be reproduced except in full, without prior written approval of the Company. Any unauthorized alteration, forgery or falsification of the content or appearance of this document is unlawful and offenders may be prosecuted to the fullest extent of the law.

2. Overview

FCC regulation allows time averaged RF power to demonstrate compliance to RF exposure safety limits. Because RF exposure is correlated to transmission power (TX power), e.g., lower RF exposure is correlated to lower TX power, the TX power can be controlled to meet FCC RF exposure limits defined specific absorption rate (SAR) limit for transmit frequencies < 6GHz.

For SAR limit, the proposed Time-Averaged Specific Absorption Rate (TA-SAR) algorithm manages TX power to ensure that at all times the time-averaged RF exposure is compliant with the FCC SAR requirement. In the FCC regulation, the averaging window of SAR is 100 seconds for transmit frequencies less than 3GHz, 60 seconds for transmit frequencies between 3GHz and 6GHz.

This document describes the test plan, test procedures, measurement setup, and measurement results for the verification of the proposed TA-SAR algorithm being able to make RF exposure meet FCC requirement.

The equipment under test (EUT) is a mobile phone, it contains supports 2G/3G/4G/5G bands. These modems are enabled with MediaTek TAS feature to control and manage transmitting power in real time and to ensure at all times the time-averaged RF exposure is in compliance with the FCC requirement.

This purpose of the Part 2 report is to demonstrate the EUT complies with FCC RF exposure requirement under Tx varying transmission scenarios, thereby validity of MediaTek TAS feature for FCC equipment authorization

Unless otherwise stated the results shown in this test report refer only to the sample(s) tested and such sample(s) are retained for 90 days only.

除非另有說明，此報告結果僅對測試之樣品負責，同時此樣品僅保留90天。本報告未經本公司書面許可，不可部份複製。

This document is issued by the Company subject to its General Conditions of Service printed overleaf, available on request or accessible at <http://www.sgs.com.tw/Terms-and-Conditions> and for electronic format documents, subject to Terms and Conditions for Electronic Documents at <http://www.sgs.com.tw/Terms-and-Conditions>. Attention is drawn to the limitation of liability, indemnification and jurisdiction issues defined therein. Any holder of this document is advised that information contained hereon reflects the Company's findings at the time of its intervention only and within the limits of Client's instructions, if any. The Company's sole responsibility is to its Client and this document does not exonerate parties to a transaction from exercising all their rights and obligations under the transaction documents. This document cannot be reproduced except in full, without prior written approval of the Company. Any unauthorized alteration, forgery or falsification of the content or appearance of this document is unlawful and offenders may be prosecuted to the fullest extent of the law.

3. MediaTek TAS feature Operation Description

3.1 Operating Parameters for Algorithm Validation

Mediatek developed the TA-SAR algorithm to control instantaneous TX power for transmit frequencies less than 6GHz, so that the time-averaged RF exposures are less than FCC requirement. TA-SAR algorithm validation has been performed for 2G, 3G, LTE, 5G NR according to cases with different combinations of operating parameters listed in Table 3-1.

Table 3-1 TA-SAR operating parameters

Operating parameters	Description
P_{sub6_limit}	The time-averaged maximum power level limit for different band in sub6.
$P_{LowThresh_offset}$	To calculate $P_{LowThresh}$. $(P_{LowThresh} = P_{sub6_limit} - P_{LowThresh_offset})$
$P_{UE_backoff_offset}$	To calculate $P_{UE_backoff}$. $(P_{UE_backoff} = P_{sub6_limit} - P_{UE_backoff_offset})$
$P_{UE_max_cust_offset}$	To calculate $P_{UE_max_cust}$. P_{UE_max} is maximum TX power at which a UE can possibly transmit in sub6. $P_{UE_max_cust} = \min (P_{UE_max}, P_{sub6_limit} + P_{UE_max_cust_offset})$

Unless otherwise stated the results shown in this test report refer only to the sample(s) tested and such sample(s) are retained for 90 days only.

除非另有說明，此報告結果僅對測試之樣品負責，同時此樣品僅保留90天。本報告未經本公司書面許可，不可部份複製。

This document is issued by the Company subject to its General Conditions of Service printed overleaf, available on request or accessible at <http://www.sgs.com.tw/Terms-and-Conditions> and for electronic format documents, subject to Terms and Conditions for Electronic Documents at <http://www.sgs.com.tw/Terms-and-Conditions>. Attention is drawn to the limitation of liability, indemnification and jurisdiction issues defined therein. Any holder of this document is advised that information contained hereon reflects the Company's findings at the time of its intervention only and within the limits of Client's instructions, if any. The Company's sole responsibility is to its Client and this document does not exonerate parties to a transaction from exercising all their rights and obligations under the transaction documents. This document cannot be reproduced except in full, without prior written approval of the Company. Any unauthorized alteration, forgery or falsification of the content or appearance of this document is unlawful and offenders may be prosecuted to the fullest extent of the law.

3.2 Overview of TA-SAR Test Proposal

For the completeness of verifying that the proposed TA-SAR algorithm can realize FCC compliance regarding RF exposure, several test scenarios are constructed as below:

Scenario 1: test under different TA-SAR parameters to verify that the TA-SAR algorithm meets compliance requirements with different combinations of operating parameters.

Scenario 2: test under time-varying TX power to verify that the TA-SAR algorithm ensures SAR compliance through dynamic TX power.

Scenario 3: test under call drop and re-establishment conditions to ensure the TA-SAR algorithm control continuity and SAR compliance.

Scenario 4: test under RAT/band handover to ensure the TA-SAR algorithm control continuity and correctness.

Scenario 5: test under different ECIs (Exposure Condition Index) to ensure the TA-SAR algorithm control behaves as expected during ECI switching from one ECI to another. (e.g., head→body worn)

Scenario 6: test under different transmission antennae to ensure the TA-SAR algorithm control works correctly during antenna switching from one antenna to another.

Scenario 7: test under different time windows to ensure the TA-SAR algorithm control functions correctly during time window switching from one time window setting to another. (e.g., time window 100s→60s)

Scenario 8: test under SAR exposure switching between two active radios (radio#1 only, radio#1+radio#2, and radio#2 only) to ensure the TA-SAR algorithm control continuity and SAR compliance.

Unless otherwise stated the results shown in this test report refer only to the sample(s) tested and such sample(s) are retained for 90 days only.

除非另有說明，此報告結果僅對測試之樣品負責，同時此樣品僅保留90天。本報告未經本公司書面許可，不可部份複製。

This document is issued by the Company subject to its General Conditions of Service printed overleaf, available on request or accessible at <http://www.sgs.com.tw/Terms-and-Conditions> and for electronic format documents, subject to Terms and Conditions for Electronic Documents at <http://www.sgs.com.tw/Terms-and-Conditions>. Attention is drawn to the limitation of liability, indemnification and jurisdiction issues defined therein. Any holder of this document is advised that information contained hereon reflects the Company's findings at the time of its intervention only and within the limits of Client's instructions, if any. The Company's sole responsibility is to its Client and this document does not exonerate parties to a transaction from exercising all their rights and obligations under the transaction documents. This document cannot be reproduced except in full, without prior written approval of the Company. Any unauthorized alteration, forgery or falsification of the content or appearance of this document is unlawful and offenders may be prosecuted to the fullest extent of the law.

4. TA-SAR Test Scenarios and Test Procedures

In order to demonstrate that TA-SAR algorithm performs as expected under various operating scenarios, Table 4-1 lists the test scenarios and expected test sequences to validate TA-SAR algorithm in these scenarios. The test sequences 0, 1, 2 are defined in section 4.1. The details of each test procedures via conducted power and SAR measurements are described in section 4.2~4.9 and section 4.10, respectively.

Table 4-1 Test scenario list of TA-SAR validation

Test scenario		Test sequences #	Description
1	Range of TA-SAR parameters	0	Adjust parameters
2	Time-varying TX power	1 and 2	Test under time-varying TX power
3	Call disconnection and re-establishment	0	Test call drop and re-establishment
4	Band handover	0	Test band change
5	ECI (Exposure Condition Index) change	0	Test under ECI transition (e.g., head → body worn)
6	Antenna switching	0	Change antenna
7	Time window switching	0	Switch frequency bands with larger frequency separation (e.g., time window 100s → 60s)
8	SAR exposure switching	0	Switch RATs when testing (e.g., LTE → NR)

Unless otherwise stated the results shown in this test report refer only to the sample(s) tested and such sample(s) are retained for 90 days only.

除非另有說明，此報告結果僅對測試之樣品負責，同時此樣品僅保留90天。本報告未經本公司書面許可，不可部份複製。

This document is issued by the Company subject to its General Conditions of Service printed overleaf, available on request or accessible at <http://www.sgs.com.tw/Terms-and-Conditions> and for electronic format documents, subject to Terms and Conditions for Electronic Documents at <http://www.sgs.com.tw/Terms-and-Conditions>. Attention is drawn to the limitation of liability, indemnification and jurisdiction issues defined therein. Any holder of this document is advised that information contained hereon reflects the Company's findings at the time of its intervention only and within the limits of Client's instructions, if any. The Company's sole responsibility is to its Client and this document does not exonerate parties to a transaction from exercising all their rights and obligations under the transaction documents. This document cannot be reproduced except in full, without prior written approval of the Company. Any unauthorized alteration, forgery or falsification of the content or appearance of this document is unlawful and offenders may be prosecuted to the fullest extent of the law.

4.1 Test Sequences for All Scenarios

Three test sequences having possibly time-varying TX power are predefined for TA-SAR validation:

- **Test sequence 0:** EUT's TX power is requested to be maximum.
- **Test sequence 1:** EUT's TX power is requested to be at power less than $P_{LowThresh}$ for 300s, then at maximum power for 200s, and finally at $P_{LowThresh} - 2\text{dB}$ for the remaining time.
- **Test sequence 2:** EUT's TX power to vary with time. This sequence is generated relative to measured P_{UE_max} , measured P_{sub6_limit} and calculated $P_{UE_backoff}$ (= measured P_{sub6_limit} in dBm - $P_{UE_backoff_offset}$ in dB) of EUT based on measured P_{sub6_limit} .
- Test sequence is generated based on below parameters of the EUT:
 - A. Measured maximum power (P_{UE_max})
 - B. Measured Tx_power_at_SAR_design_limit (P_{sub6_limit})
 - C. Threshold of dynamic power reduction status determination: reserve hysteresis margin for instantaneous power ($P_{LowThresh}$)
 - D. SAR_time_window (FCC: 100s for $f < 3\text{GHz}$, 60s for $3\text{GHz} < f < 6\text{GHz}$)

The test sequence 0, 1, and 2 are illustrated in Figure 4-1, Figure 4-2, and Figure 4-3, respectively. The waveforms of the three test sequences are listed in Table 4-2, Table 4-3, and Table 4-4.

Unless otherwise stated the results shown in this test report refer only to the sample(s) tested and such sample(s) are retained for 90 days only.

除非另有說明，此報告結果僅對測試之樣品負責，同時此樣品僅保留90天。本報告未經本公司書面許可，不可部份複製。

This document is issued by the Company subject to its General Conditions of Service printed overleaf, available on request or accessible at <http://www.sgs.com.tw/Terms-and-Conditions> and for electronic format documents, subject to Terms and Conditions for Electronic Documents at <http://www.sgs.com.tw/Terms-and-Conditions>. Attention is drawn to the limitation of liability, indemnification and jurisdiction issues defined therein. Any holder of this document is advised that information contained hereon reflects the Company's findings at the time of its intervention only and within the limits of Client's instructions, if any. The Company's sole responsibility is to its Client and this document does not exonerate parties to a transaction from exercising all their rights and obligations under the transaction documents. This document cannot be reproduced except in full, without prior written approval of the Company. Any unauthorized alteration, forgery or falsification of the content or appearance of this document is unlawful and offenders may be prosecuted to the fullest extent of the law.

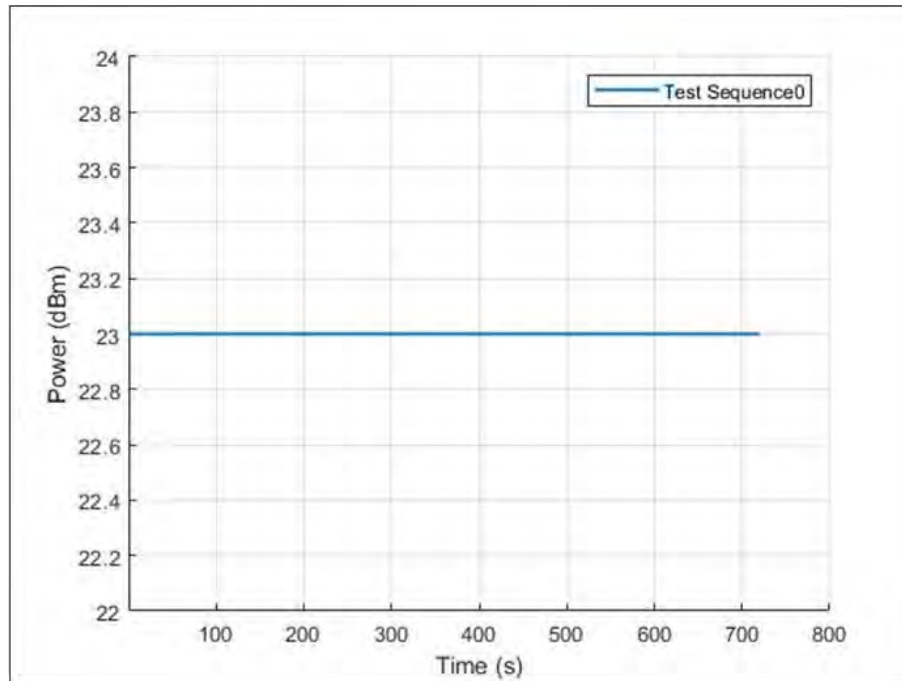
Figure 4-1 Test sequence 0
Table 4-2 Test sequence 0

Time	Duration	Power (dBm)	Note
720	720	23	P_{UE_max}

Unless otherwise stated the results shown in this test report refer only to the sample(s) tested and such sample(s) are retained for 90 days only.

除非另有說明，此報告結果僅對測試之樣品負責，同時此樣品僅保留90天。本報告未經本公司書面許可，不可部份複製。

This document is issued by the Company subject to its General Conditions of Service printed overleaf, available on request or accessible at <http://www.sgs.com.tw/Terms-and-Conditions> and for electronic format documents, subject to Terms and Conditions for Electronic Documents at <http://www.sgs.com.tw/Terms-and-Conditions>. Attention is drawn to the limitation of liability, indemnification and jurisdiction issues defined therein. Any holder of this document is advised that information contained hereon reflects the Company's findings at the time of its intervention only and within the limits of Client's instructions, if any. The Company's sole responsibility is to its Client and this document does not exonerate parties to a transaction from exercising all their rights and obligations under the transaction documents. This document cannot be reproduced except in full, without prior written approval of the Company. Any unauthorized alteration, forgery or falsification of the content or appearance of this document is unlawful and offenders may be prosecuted to the fullest extent of the law.

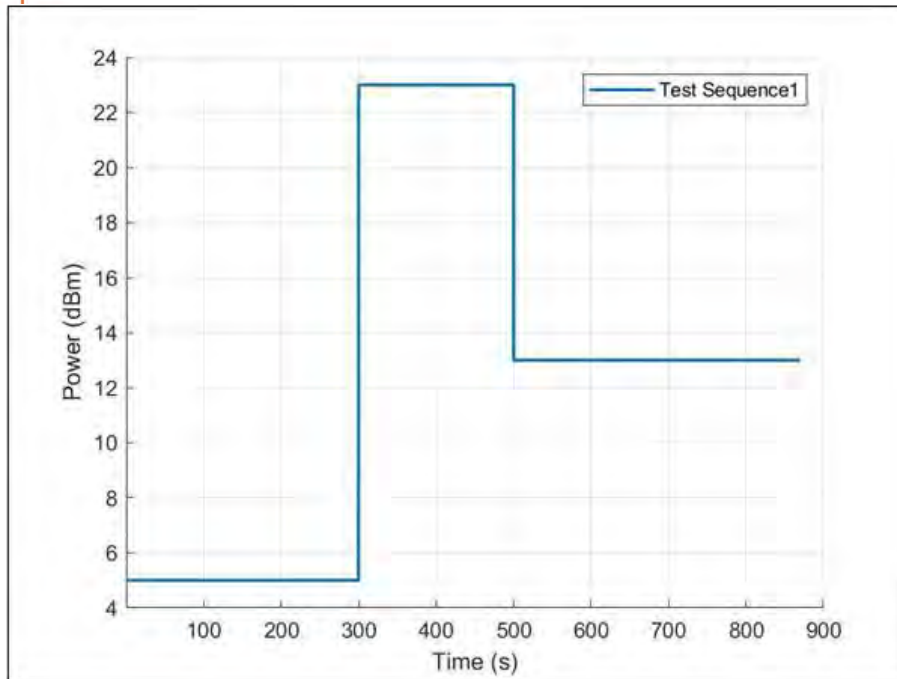

Figure 4-2 Test sequence 1

Table 4-3 Test sequence 1

Time	Duration	Power (dBm)	Note
300	300	5	$< P_{LowThresh}$
500	200	23	P_{UE_max}
870	370	13	$P_{LowThresh} - 2dB$

Unless otherwise stated the results shown in this test report refer only to the sample(s) tested and such sample(s) are retained for 90 days only.

除非另有說明，此報告結果僅對測試之樣品負責，同時此樣品僅保留90天。本報告未經本公司書面許可，不可部份複製。

This document is issued by the Company subject to its General Conditions of Service printed overleaf, available on request or accessible at <http://www.sgs.com.tw/Terms-and-Conditions> and for electronic format documents, subject to Terms and Conditions for Electronic Documents at <http://www.sgs.com.tw/Terms-and-Conditions>. Attention is drawn to the limitation of liability, indemnification and jurisdiction issues defined therein. Any holder of this document is advised that information contained hereon reflects the Company's findings at the time of its intervention only and within the limits of Client's instructions, if any. The Company's sole responsibility is to its Client and this document does not exonerate parties to a transaction from exercising all their rights and obligations under the transaction documents. This document cannot be reproduced except in full, without prior written approval of the Company. Any unauthorized alteration, forgery or falsification of the content or appearance of this document is unlawful and offenders may be prosecuted to the fullest extent of the law.

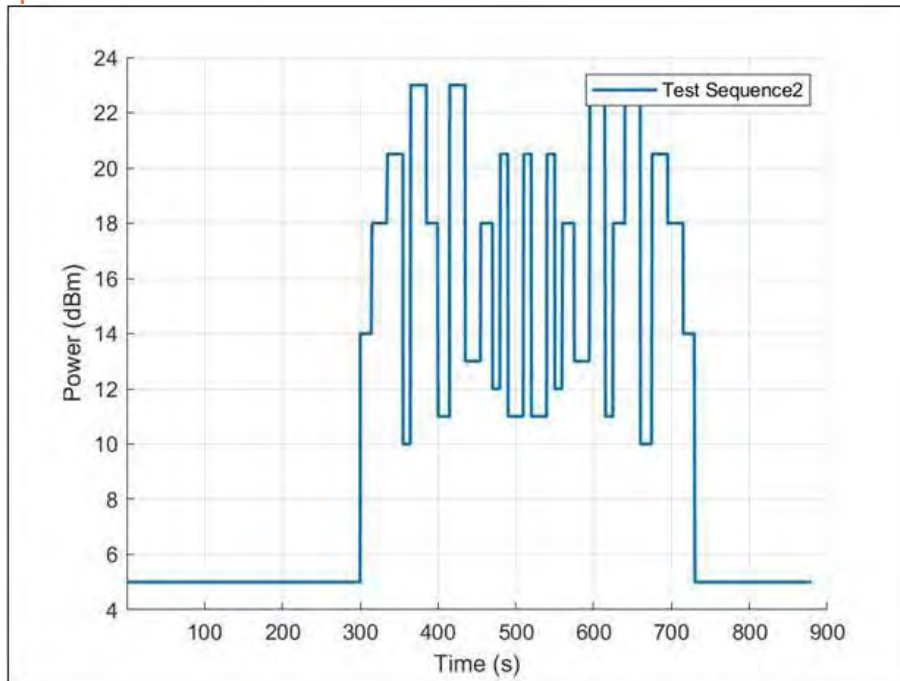

Figure 4-3 Test sequence 2

Unless otherwise stated the results shown in this test report refer only to the sample(s) tested and such sample(s) are retained for 90 days only.

除非另有說明，此報告結果僅對測試之樣品負責，同時此樣品僅保留90天。本報告未經本公司書面許可，不可部份複製。

This document is issued by the Company subject to its General Conditions of Service printed overleaf, available on request or accessible at <http://www.sgs.com.tw/Terms-and-Conditions> and for electronic format documents, subject to Terms and Conditions for Electronic Documents at <http://www.sgs.com.tw/Terms-and-Conditions>. Attention is drawn to the limitation of liability, indemnification and jurisdiction issues defined therein. Any holder of this document is advised that information contained hereon reflects the Company's findings at the time of its intervention only and within the limits of Client's instructions, if any. The Company's sole responsibility is to its Client and this document does not exonerate parties to a transaction from exercising all their rights and obligations under the transaction documents. This document cannot be reproduced except in full, without prior written approval of the Company. Any unauthorized alteration, forgery or falsification of the content or appearance of this document is unlawful and offenders may be prosecuted to the fullest extent of the law.

Table 4-4 Test sequence 2

Time	Duration	Power (dBm)	Note
300	300	5	$< P_{LowThresh}$
315	15	14	$P_{sub6_limit} - 4dB$
335	20	18	P_{sub6_limit}
355	20	20.5	$(P_{sub6_limit} + P_{UE_max})/2$
365	10	10	$P_{sub6_limit} - 8dB$
385	20	23	P_{UE_max}
400	15	18	P_{sub6_limit}
415	15	11	$P_{sub6_limit} - 7dB$
435	20	23	P_{UE_max}
455	20	13	$P_{sub6_limit} - 5dB$
470	15	18	P_{sub6_limit}
480	10	12	$P_{sub6_limit} - 6dB$
490	10	20.5	$(P_{sub6_limit} + P_{UE_max})/2$
510	20	11	$P_{sub6_limit} - 7dB$
520	10	20.5	$(P_{sub6_limit} + P_{UE_max})/2$
540	20	11	$P_{sub6_limit} - 7dB$
550	10	20.5	$(P_{sub6_limit} + P_{UE_max})/2$
560	10	12	$P_{sub6_limit} - 6dB$
575	15	18	P_{sub6_limit}
595	20	13	$P_{sub6_limit} - 5dB$
615	20	23	P_{UE_max}
625	10	11	$P_{sub6_limit} - 7dB$
640	15	18	P_{sub6_limit}
660	20	23	P_{UE_max}
675	15	10	$P_{sub6_limit} - 8dB$
695	20	20.5	$(P_{sub6_limit} + P_{UE_max})/2$
715	20	18	P_{sub6_limit}
730	15	14	$P_{sub6_limit} - 4dB$
870	140	5	$< P_{LowThresh}$

Unless otherwise stated the results shown in this test report refer only to the sample(s) tested and such sample(s) are retained for 90 days only.

除非另有說明，此報告結果僅對測試之樣品負責，同時此樣品僅保留90天。本報告未經本公司書面許可，不可部份複製。

This document is issued by the Company subject to its General Conditions of Service printed overleaf, available on request or accessible at <http://www.sgs.com.tw/Terms-and-Conditions> and for electronic format documents, subject to Terms and Conditions for Electronic Documents at <http://www.sgs.com.tw/Terms-and-Conditions>. Attention is drawn to the limitation of liability, indemnification and jurisdiction issues defined therein. Any holder of this document is advised that information contained hereon reflects the Company's findings at the time of its intervention only and within the limits of Client's instructions, if any. The Company's sole responsibility is to its Client and this document does not exonerate parties to a transaction from exercising all their rights and obligations under the transaction documents. This document cannot be reproduced except in full, without prior written approval of the Company. Any unauthorized alteration, forgery or falsification of the content or appearance of this document is unlawful and offenders may be prosecuted to the fullest extent of the law.

4.2 Test Configuration and Procedure for Scenario 1: Range of TA-SAR Parameters via Conducted Power Measurements

4.2.1 Configuration

This test is performed by changing the parameters ($P_{LowThresh_offset}$, $P_{UE_backoff_offset}$, $P_{UE_max_cust_offset}$) for the selected RAT (Radio Access Technologies) and band. Since Mediatek's TA algorithm operation is independent of RATs/bands/channels, any one RAT can be selected for this test and the selected band of the RAT has the least P_{sub6_limit} . In principle, two sets of the parameters are determined for this test (if applicable). If the parameters of the EUT are fixed (without a support of dynamic change), only the set of the default parameters needs to be tested.

4.2.2 Procedure

TX power is measured, recorded, and processed by the following steps:

- Step 1~4: measure and record TX power versus time for test scenario 1

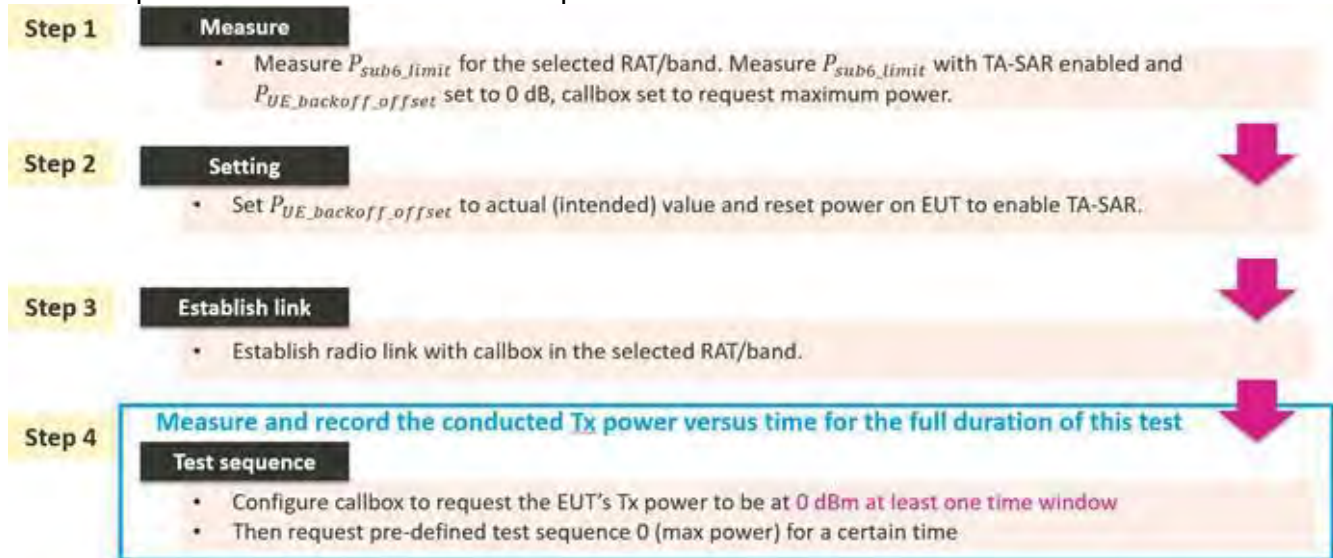

Unless otherwise stated the results shown in this test report refer only to the sample(s) tested and such sample(s) are retained for 90 days only.

除非另有說明，此報告結果僅對測試之樣品負責，同時此樣品僅保留90天。本報告未經本公司書面許可，不可部份複製。

This document is issued by the Company subject to its General Conditions of Service printed overleaf, available on request or accessible at <http://www.sgs.com.tw/Terms-and-Conditions> and for electronic format documents, subject to Terms and Conditions for Electronic Documents at <http://www.sgs.com.tw/Terms-and-Conditions>. Attention is drawn to the limitation of liability, indemnification and jurisdiction issues defined therein. Any holder of this document is advised that information contained hereon reflects the Company's findings at the time of its intervention only and within the limits of Client's instructions, if any. The Company's sole responsibility is to its Client and this document does not exonerate parties to a transaction from exercising all their rights and obligations under the transaction documents. This document cannot be reproduced except in full, without prior written approval of the Company. Any unauthorized alteration, forgery or falsification of the content or appearance of this document is unlawful and offenders may be prosecuted to the fullest extent of the law.

- Step 5: convert the measured conducted TX power into SAR
Convert the measured conducted TX power from step 4 into 1gSAR or 10gSAR value using the following equation. Perform the running time average to power and 1gSAR or 10g SAR to determine time-averaged value versus time as follows,

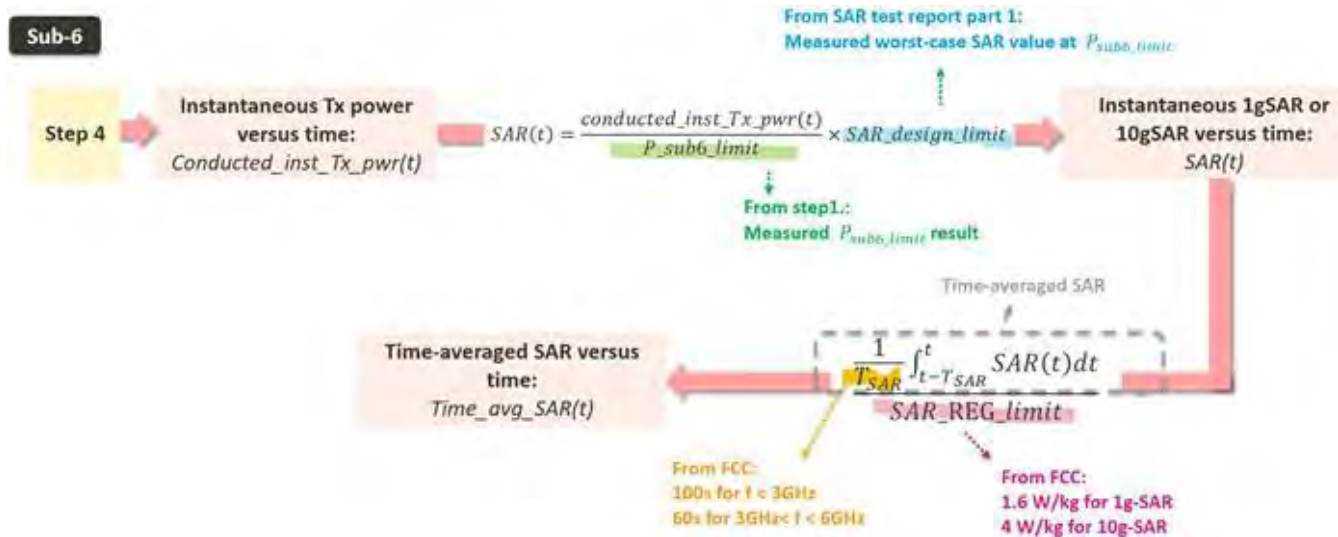

- Step 6: plot results
 - A. Make one power perspective plot containing
 1. Instantaneous TX power
 2. Requested power
 3. Calculated time-averaged power
 4. Calculated time-averaged power limits
 - B. Make one SAR perspective plot containing
 1. Calculated time-averaged 1gSAR or 10gSAR
 2. FCC limit of 1.6 W/kg (1gSAR) or 4.0 W/kg (10gSAR)

Unless otherwise stated the results shown in this test report refer only to the sample(s) tested and such sample(s) are retained for 90 days only.

除非另有說明，此報告結果僅對測試之樣品負責，同時此樣品僅保留90天。本報告未經本公司書面許可，不可部份複製。

This document is issued by the Company subject to its General Conditions of Service printed overleaf, available on request or accessible at <http://www.sgs.com.tw/Terms-and-Conditions> and for electronic format documents, subject to Terms and Conditions for Electronic Documents at <http://www.sgs.com.tw/Terms-and-Conditions>. Attention is drawn to the limitation of liability, indemnification and jurisdiction issues defined therein. Any holder of this document is advised that information contained hereon reflects the Company's findings at the time of its intervention only and within the limits of Client's instructions, if any. The Company's sole responsibility is to its Client and this document does not exonerate parties to a transaction from exercising all their rights and obligations under the transaction documents. This document cannot be reproduced except in full, without prior written approval of the Company. Any unauthorized alteration, forgery or falsification of the content or appearance of this document is unlawful and offenders may be prosecuted to the fullest extent of the law.

4.3 Test Configuration and Procedure for Scenario 2: Time-Varying TX Power via Conducted Power Measurements

4.3.1 Configuration

Since Mediatek's TA-SAR feature operation is independent of bands and channels for a given RAT, selecting one band per RAT is sufficient to validate this feature. Two bands per RAT are proposed for this test. The criteria for band selection for each RAT is based on the P_{sub6_limit} values (corresponding to SAR_design_limit) and is described as below:

- Select two bands, among the ones whose P_{sub6_limit} values are below P_{UE_max} , which correspond to least and highest P_{sub6_limit} values respectively.
 - o Only one band needs to be tested if all the bands have same P_{sub6_limit} .
 - o Only one band needs to be tested if only the band has P_{sub6_limit} below P_{UE_max} .
 - o If the same least P_{sub6_limit} applies to multiple bands, select the band with the highest measured 1gSAR at P_{sub6_limit} .
 - o If P_{sub6_limit} values of all bands are all over P_{UE_max} (i.e., TA-SAR feature is not enabled), there is no need to test this RAT.

4.3.2 Procedure

TX power is measured, recorded, and processed by the following steps:

- Step 1~4: measure and record TX power versus time for test scenario 2

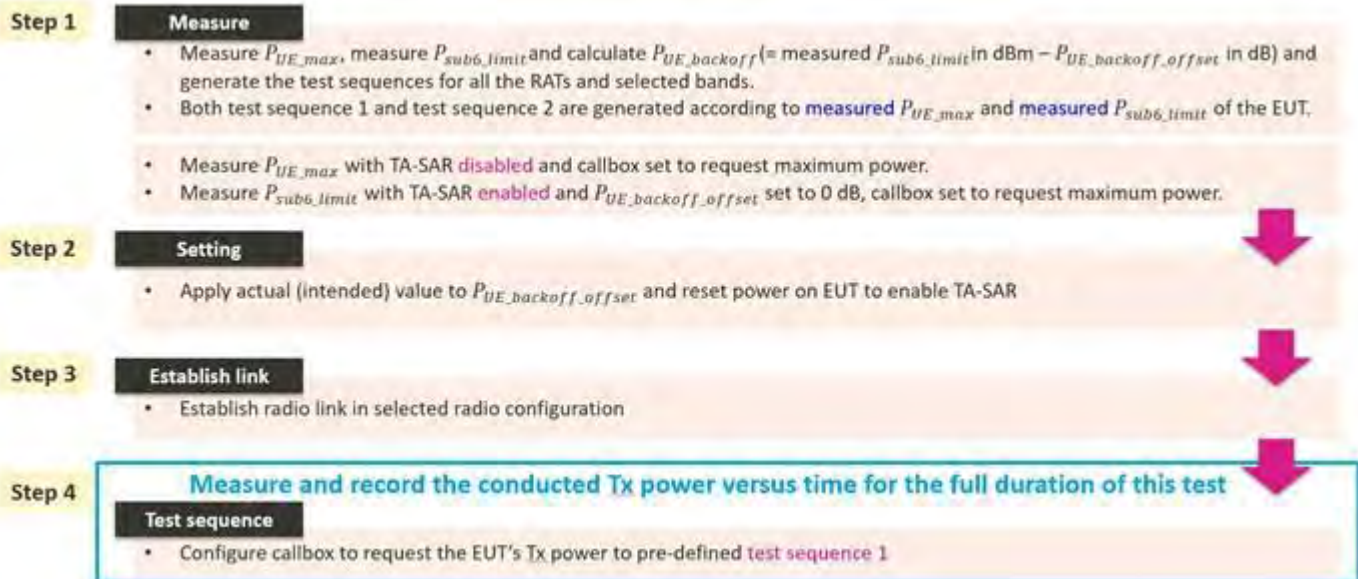

Unless otherwise stated the results shown in this test report refer only to the sample(s) tested and such sample(s) are retained for 90 days only.

除非另有說明，此報告結果僅對測試之樣品負責，同時此樣品僅保留90天。本報告未經本公司書面許可，不可部份複製。

This document is issued by the Company subject to its General Conditions of Service printed overleaf, available on request or accessible at <http://www.sgs.com.tw/Terms-and-Conditions> and for electronic format documents, subject to Terms and Conditions for Electronic Documents at <http://www.sgs.com.tw/Terms-and-Conditions>. Attention is drawn to the limitation of liability, indemnification and jurisdiction issues defined therein. Any holder of this document is advised that information contained hereon reflects the Company's findings at the time of its intervention only and within the limits of Client's instructions, if any. The Company's sole responsibility is to its Client and this document does not exonerate parties to a transaction from exercising all their rights and obligations under the transaction documents. This document cannot be reproduced except in full, without prior written approval of the Company. Any unauthorized alteration, forgery or falsification of the content or appearance of this document is unlawful and offenders may be prosecuted to the fullest extent of the law.

- Step 5: convert the measured conducted TX power into SAR
 Convert the measured conducted TX power from step 4 into 1gSAR or 10gSAR value using the following equation. Perform the running time average to power and 1gSAR or 10g SAR to determine time-averaged value versus time as below:

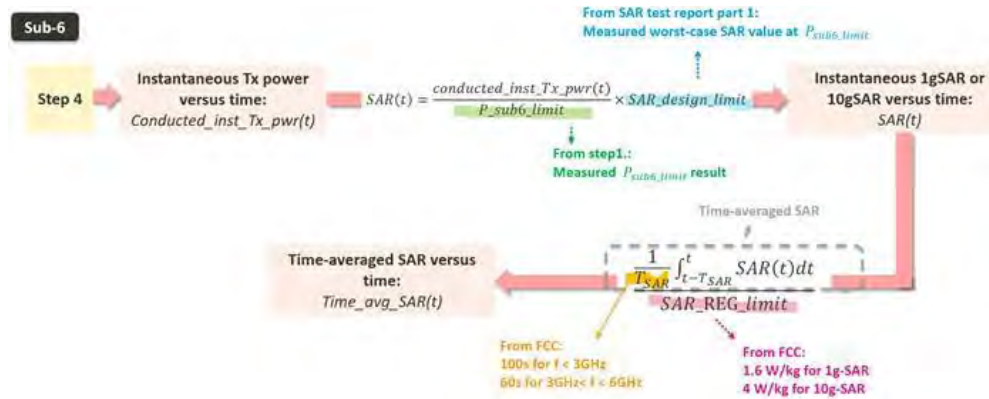
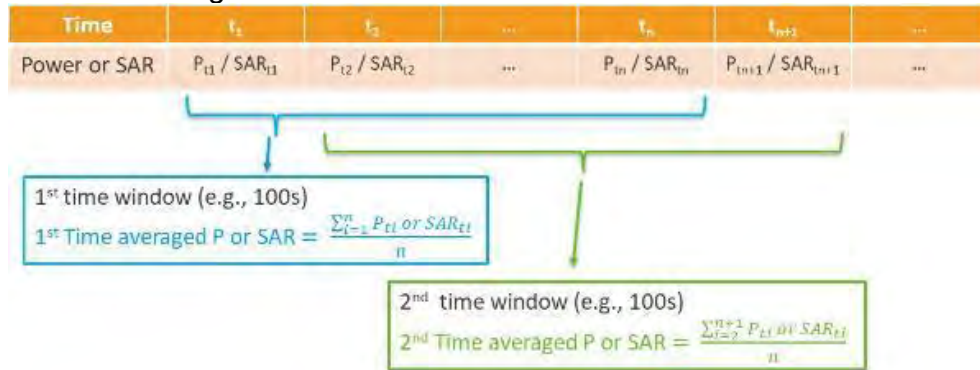

- Step 6: plot results
 - A. Make one power perspective plot containing
 1. Instantaneous TX power
 2. Requested power (test sequence1)
 3. Calculated time-averaged power
 4. Calculated time-averaged power limits
 - B. Make one SAR perspective plot containing
 1. Calculated time-averaged 1gSAR or 10gSAR
 2. FCC limit of 1.6 W/kg (1gSAR) or 4.0 W/kg (10gSAR)

- Step 7: repeat steps 2~6 for test sequence 2
 Repeat steps 2 ~ 6 for pre-defined test sequence 2 and replace test sequence 1 in step 4 with test sequence 2.
- Step 8: repeat steps 2~7 for different bands

Unless otherwise stated the results shown in this test report refer only to the sample(s) tested and such sample(s) are retained for 90 days only.

除非另有說明，此報告結果僅對測試之樣品負責，同時此樣品僅保留90天。本報告未經本公司書面許可，不可部份複製。

This document is issued by the Company subject to its General Conditions of Service printed overleaf, available on request or accessible at <http://www.sgs.com.tw/Terms-and-Conditions> and for electronic format documents, subject to Terms and Conditions for Electronic Documents at <http://www.sgs.com.tw/Terms-and-Conditions>. Attention is drawn to the limitation of liability, indemnification and jurisdiction issues defined therein. Any holder of this document is advised that information contained hereon reflects the Company's findings at the time of its intervention only and within the limits of Client's instructions, if any. The Company's sole responsibility is to its Client and this document does not exonerate parties to a transaction from exercising all their rights and obligations under the transaction documents. This document cannot be reproduced except in full, without prior written approval of the Company. Any unauthorized alteration, forgery or falsification of the content or appearance of this document is unlawful and offenders may be prosecuted to the fullest extent of the law.

4.4 Test Configuration and Procedure for Scenario 3: Call Disconnection and Re-establishment via Conducted Power Measurements

4.4.1 Configuration

For call disconnection measurement, the criteria of selecting the test configuration is:

- Select the RAT/band with least P_{sub6_limit} among all supported RATs/bands.
- Select the RAT/band having the highest measured 1gSAR at P_{sub6_limit} if multiple RATs/bands having same least P_{sub6_limit} .
- Select the radio configuration in this RAT/band that corresponds to the highest measured 1gSAR at P_{sub6_limit} .

4.4.2 Procedure

TX power is measured, recorded, and processed by the following steps:

- Step 1~4: measure and record TX power versus time for test scenario 3

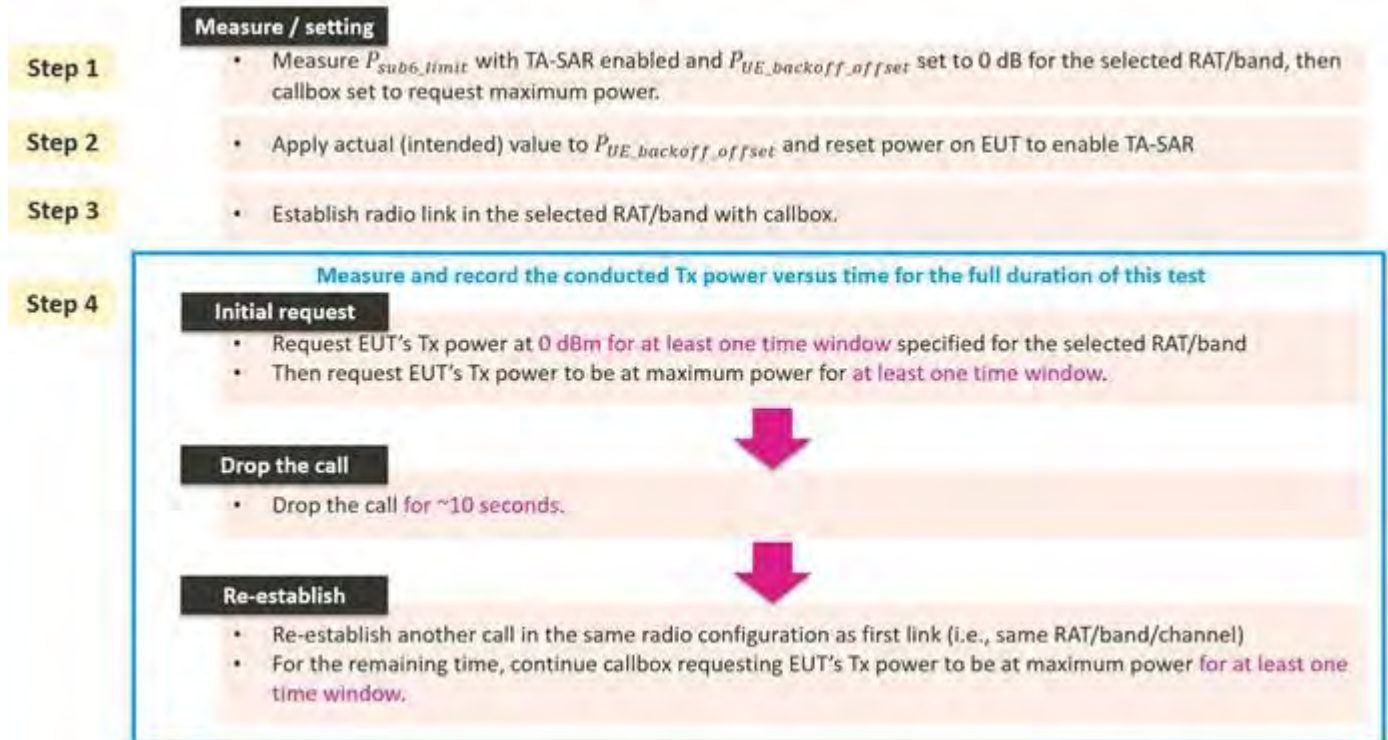

Unless otherwise stated the results shown in this test report refer only to the sample(s) tested and such sample(s) are retained for 90 days only.

除非另有說明，此報告結果僅對測試之樣品負責，同時此樣品僅保留90天。本報告未經本公司書面許可，不可部份複製。

This document is issued by the Company subject to its General Conditions of Service printed overleaf, available on request or accessible at <http://www.sgs.com.tw/Terms-and-Conditions> and for electronic format documents, subject to Terms and Conditions for Electronic Documents at <http://www.sgs.com.tw/Terms-and-Conditions>. Attention is drawn to the limitation of liability, indemnification and jurisdiction issues defined therein. Any holder of this document is advised that information contained hereon reflects the Company's findings at the time of its intervention only and within the limits of Client's instructions, if any. The Company's sole responsibility is to its Client and this document does not exonerate parties to a transaction from exercising all their rights and obligations under the transaction documents. This document cannot be reproduced except in full, without prior written approval of the Company. Any unauthorized alteration, forgery or falsification of the content or appearance of this document is unlawful and offenders may be prosecuted to the fullest extent of the law.

- Step 5: convert the measured conducted TX power into SAR
 Convert the measured conducted TX power from step 4 into 1gSAR or 10gSAR value using the following equation. Perform the running time average to power and 1gSAR or 10g SAR to determine time-averaged value versus time as follows,

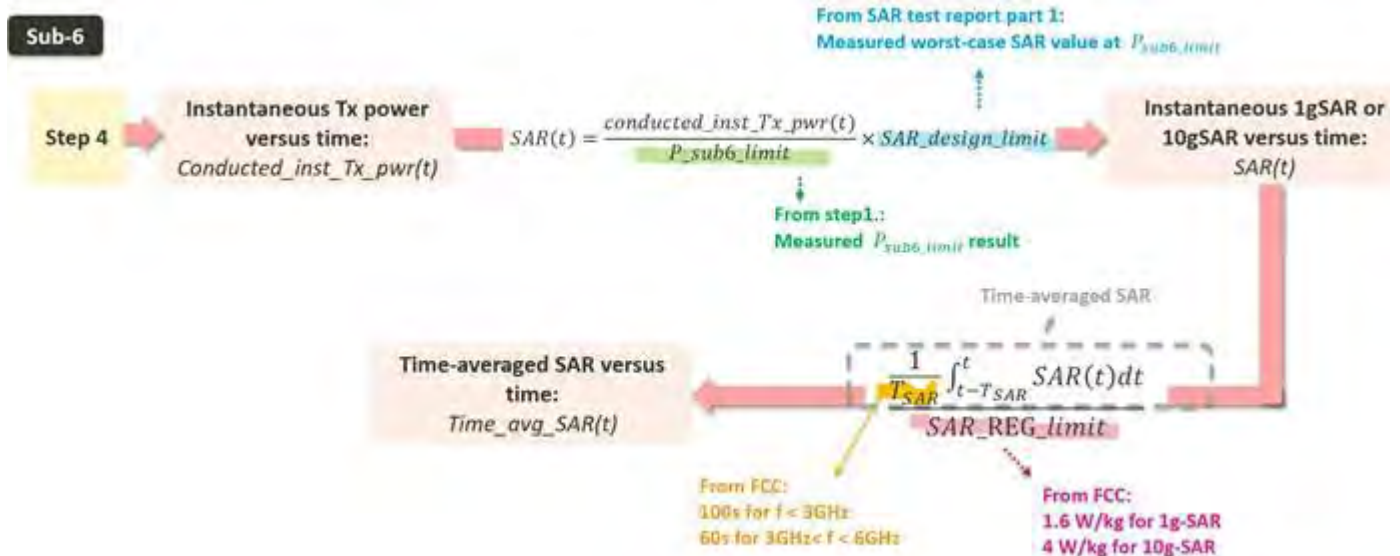

- Step 6: plot results
 - A. Make one power perspective plot containing
 1. Instantaneous TX power
 2. Requested power
 3. Calculated time-averaged power
 4. Calculated time-averaged power limits
 - B. Make one SAR perspective plot containing
 1. Calculated time-averaged 1gSAR or 10gSAR
 2. FCC limit of 1.6 W/kg (1gSAR) or 4.0 W/kg (10gSAR)

Unless otherwise stated the results shown in this test report refer only to the sample(s) tested and such sample(s) are retained for 90 days only.

除非另有說明，此報告結果僅對測試之樣品負責，同時此樣品僅保留90天。本報告未經本公司書面許可，不可部份複製。

This document is issued by the Company subject to its General Conditions of Service printed overleaf, available on request or accessible at <http://www.sgs.com.tw/Terms-and-Conditions> and for electronic format documents, subject to Terms and Conditions for Electronic Documents at <http://www.sgs.com.tw/Terms-and-Conditions>. Attention is drawn to the limitation of liability, indemnification and jurisdiction issues defined therein. Any holder of this document is advised that information contained hereon reflects the Company's findings at the time of its intervention only and within the limits of Client's instructions, if any. The Company's sole responsibility is to its Client and this document does not exonerate parties to a transaction from exercising all their rights and obligations under the transaction documents. This document cannot be reproduced except in full, without prior written approval of the Company. Any unauthorized alteration, forgery or falsification of the content or appearance of this document is unlawful and offenders may be prosecuted to the fullest extent of the law.

4.5 Test Configuration and Procedure for Scenario 4: Band Handover via Conducted Power Measurements

4.5.1 Configuration

For a given TX antenna, select a RAT/band with the lowest P_{sub6_limit} and the other RAT/band with the highest P_{sub6_limit} . Both of them have P_{sub6_limit} values less than P_{UE_max} if possible.

- Select the RAT/band having the highest measured 1gSAR at P_{sub6_limit} if multiple RATs/bands have the same lowest P_{sub6_limit} .
- Select the RAT/band having the lowest measured 1gSAR at P_{sub6_limit} if multiple RATs/bands have the same highest P_{sub6_limit} .

4.5.2 Procedure

TX power is measured, recorded, and processed by the following steps:

- Step 1~4: measure and record TX power versus time for test scenario 4

Step 1

Measure / setting

- Measure P_{sub6_limit} for both the selected RATs and bands. Measure P_{sub6_limit} with TA-SAR enabled and $P_{UE_backoff_offset}$ set to 0 dB, callbox set to request maximum power.

Step 2

- Apply actual (intended) value to $P_{UE_backoff_offset}$ and reset power on EUT to enable TA-SAR.

Step 3

- Establish radio link in first selected RAT/band with callbox .

Step 4

Measure and record the conducted Tx power versus time for the full duration of this test

Initial request

- Request EUT's Tx power at 0 dBm for at least one time window specified for the selected RAT/band
- Then request EUT's Tx power to be at maximum power for at least one time window.

RAT/Band switch

- Switch the radio link to second RAT/band selected.
- For the remaining time, continue callbox requesting EUT's Tx power to be at maximum power for at least one time window.



Unless otherwise stated the results shown in this test report refer only to the sample(s) tested and such sample(s) are retained for 90 days only.

除非另有說明，此報告結果僅對測試之樣品負責，同時此樣品僅保留90天。本報告未經本公司書面許可，不可部份複製。

This document is issued by the Company subject to its General Conditions of Service printed overleaf, available on request or accessible at <http://www.sgs.com.tw/Terms-and-Conditions> and for electronic format documents, subject to Terms and Conditions for Electronic Documents at <http://www.sgs.com.tw/Terms-and-Conditions>. Attention is drawn to the limitation of liability, indemnification and jurisdiction issues defined therein. Any holder of this document is advised that information contained hereon reflects the Company's findings at the time of its intervention only and within the limits of Client's instructions, if any. The Company's sole responsibility is to its Client and this document does not exonerate parties to a transaction from exercising all their rights and obligations under the transaction documents. This document cannot be reproduced except in full, without prior written approval of the Company. Any unauthorized alteration, forgery or falsification of the content or appearance of this document is unlawful and offenders may be prosecuted to the fullest extent of the law.

- Step 5: convert the measured conducted TX power into SAR
Convert the measured conducted TX power from step 4 into 1gSAR or 10gSAR value using the following equation. Perform the running time average to power and 1gSAR or 10g SAR to determine time-averaged value versus time as follows,

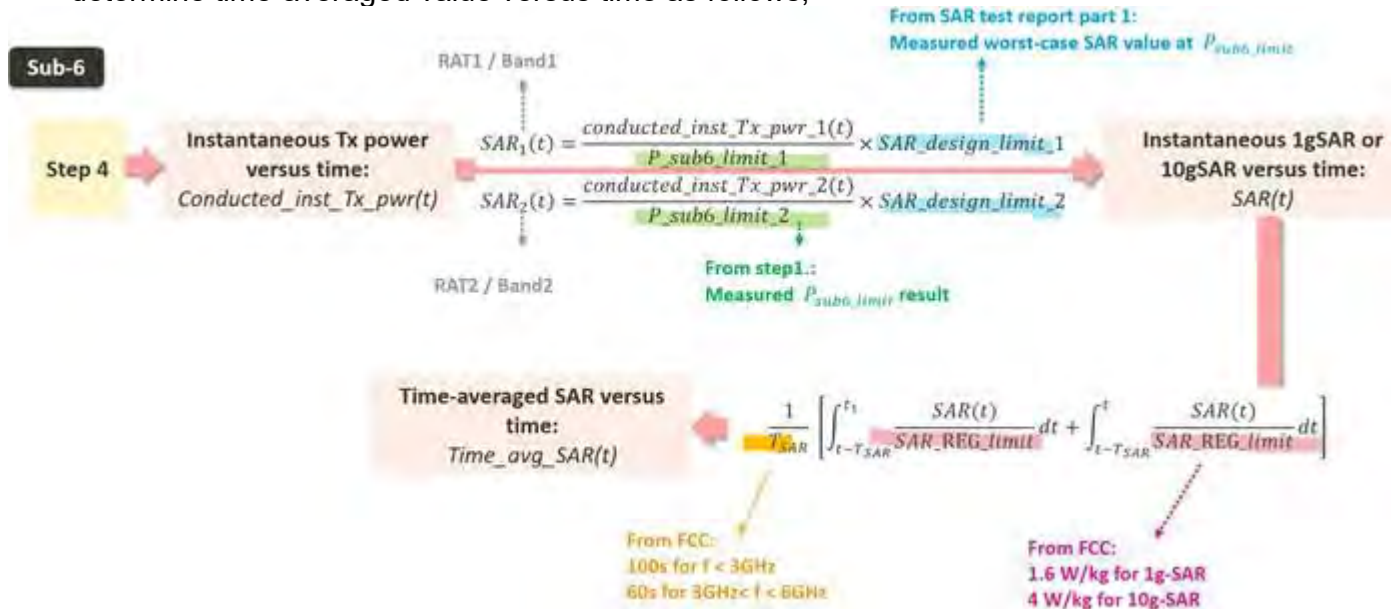

- Step 6: plot results
 - A. Make one power perspective plot containing
 1. Instantaneous TX power
 2. Requested power
 3. Calculated time-averaged power
 4. Calculated time-averaged power limits
 - B. Make one SAR perspective plot containing
 1. Calculated time-averaged 1gSAR or 10gSAR
 2. FCC limit of 1.6 W/kg (1gSAR) or 4.0 W/kg (10gSAR)
 3. Normalized time-averaged 1gSAR/1.6 or 10gSAR/4.0

Unless otherwise stated the results shown in this test report refer only to the sample(s) tested and such sample(s) are retained for 90 days only.

除非另有說明，此報告結果僅對測試之樣品負責，同時此樣品僅保留90天。本報告未經本公司書面許可，不可部份複製。

This document is issued by the Company subject to its General Conditions of Service printed overleaf, available on request or accessible at <http://www.sgs.com.tw/Terms-and-Conditions> and for electronic format documents, subject to Terms and Conditions for Electronic Documents at <http://www.sgs.com.tw/Terms-and-Conditions>. Attention is drawn to the limitation of liability, indemnification and jurisdiction issues defined therein. Any holder of this document is advised that information contained hereon reflects the Company's findings at the time of its intervention only and within the limits of Client's instructions, if any. The Company's sole responsibility is to its Client and this document does not exonerate parties to a transaction from exercising all their rights and obligations under the transaction documents. This document cannot be reproduced except in full, without prior written approval of the Company. Any unauthorized alteration, forgery or falsification of the content or appearance of this document is unlawful and offenders may be prosecuted to the fullest extent of the law.

4.6 Test Configuration and Procedure for Scenario 5: Exposure Condition Index (ECI) Change via Conducted Power Measurements

4.6.1 Configuration

Select any one RAT/band, which has at least two ECIs whose P_{sub6_limit} values are different and are below P_{UE_max} .

4.6.2 Procedure

The test procedure is identical to section 4.5.2 except the following 2 changes:

1. Replace band switch operation with ECI switch.
2. In Step 4, the second ECI switching is arranged after the first one lasts for at least one time window, i.e., switch the second ECI back to the first ECI, and then continue with callbox requesting EUT's Tx power to be at maximum power for at least one time window.

It is noted that the following operations are done as well for this scenario:

- The correct power control is controlled by TA_SAR during ECI switches from one ECI to another.
- The validation criteria are, at all times, the time-averaged 1gSAR or 10gSAR versus time shall not exceed FCC limit of 1.6 W/kg for 1gSAR or 4.0 W/kg for 10gSAR.

Unless otherwise stated the results shown in this test report refer only to the sample(s) tested and such sample(s) are retained for 90 days only.

除非另有說明，此報告結果僅對測試之樣品負責，同時此樣品僅保留90天。本報告未經本公司書面許可，不可部份複製。

This document is issued by the Company subject to its General Conditions of Service printed overleaf, available on request or accessible at <http://www.sgs.com.tw/Terms-and-Conditions> and for electronic format documents, subject to Terms and Conditions for Electronic Documents at <http://www.sgs.com.tw/Terms-and-Conditions>. Attention is drawn to the limitation of liability, indemnification and jurisdiction issues defined therein. Any holder of this document is advised that information contained hereon reflects the Company's findings at the time of its intervention only and within the limits of Client's instructions, if any. The Company's sole responsibility is to its Client and this document does not exonerate parties to a transaction from exercising all their rights and obligations under the transaction documents. This document cannot be reproduced except in full, without prior written approval of the Company. Any unauthorized alteration, forgery or falsification of the content or appearance of this document is unlawful and offenders may be prosecuted to the fullest extent of the law.

4.7 Test Configuration and Procedure for Scenario 6 Antenna Switching via Conducted Power Measurements

4.7.1 Configuration

Among RATs/bands supporting TX antenna switches, select the RAT/band with the highest P_{sub6_limit} difference between a pair of supported TX antennas.

- Select the RAT/band having the highest measured 1gSAR at P_{sub6_limit} if multiple RATs/bands having the same P_{sub6_limit} difference between the supported TX antennas.
- Antenna selection order
 - o Select the configuration with two antennas having P_{sub6_limit} values less than P_{UE_max} .
 - o If the previous configuration does not exist, select the configuration with one antenna having P_{sub6_limit} value less than P_{UE_max} .
 - o If the above two cannot be found, select one configuration with the two antennas having the least difference between their P_{sub6_limit} and P_{UE_max} (i.e., P_{sub6_limit} can be greater than P_{UE_max}).

4.7.2 Procedure

The test procedure is identical to section 4.5.2 except the following 2 changes:

1. Replace band switch operation with antenna switch.
2. In Step 4, the second antenna switching is arranged after the first one lasts for at least one time window, i.e., switch the second antenna back to the first antenna, and then continue with callbox requesting EUT's Tx power to be at maximum power for at least one time window.

It is noted that the following operations are done as well for this scenario:

- The correct power control is controlled by TA_SAR during antenna switches from one antenna to another.
- The validation criteria are, at all times, the time-averaged 1gSAR or 10gSAR versus time shall not exceed FCC limit of 1.6 W/kg for 1gSAR or 4.0 W/kg for 10gSAR.

Unless otherwise stated the results shown in this test report refer only to the sample(s) tested and such sample(s) are retained for 90 days only.

除非另有說明，此報告結果僅對測試之樣品負責，同時此樣品僅保留90天。本報告未經本公司書面許可，不可部份複製。

This document is issued by the Company subject to its General Conditions of Service printed overleaf, available on request or accessible at <http://www.sgs.com.tw/Terms-and-Conditions> and for electronic format documents, subject to Terms and Conditions for Electronic Documents at <http://www.sgs.com.tw/Terms-and-Conditions>. Attention is drawn to the limitation of liability, indemnification and jurisdiction issues defined therein. Any holder of this document is advised that information contained hereon reflects the Company's findings at the time of its intervention only and within the limits of Client's instructions, if any. The Company's sole responsibility is to its Client and this document does not exonerate parties to a transaction from exercising all their rights and obligations under the transaction documents. This document cannot be reproduced except in full, without prior written approval of the Company. Any unauthorized alteration, forgery or falsification of the content or appearance of this document is unlawful and offenders may be prosecuted to the fullest extent of the law.

4.8 Test Configuration and Procedure for Scenario 7: Time Window Switching via Conducted Power Measurements

4.8.1 Configuration

Select one RAT/band with 60-second time averaging window, and the other RAT/band with 100-second time averaging window. Both of them have P_{sub6_limit} values less than P_{UE_max} if possible.

- At least one of the selected RAT/band has its P_{sub6_limit} less than P_{UE_max} .

4.8.2 Procedure

TX power is measured, recorded, and processed by the following steps:

- Step 1~4: measure and record TX power versus time for test scenario 7

Step 1

Measure / setting

- Measure P_{sub6_limit} for both the selected RATs and bands. Measure P_{sub6_limit} with TA-SAR enabled and $P_{UE_backoff_offset}$ set to 0 dB, callbox set to request maximum power.

Step 2

- Apply actual (intended) value to $P_{UE_backoff_offset}$ and enable TA-SAR.

① Transition from 100s time window to 60s time window, and vice versa (step3 to step 6)

Step 3

- Establish radio link in the RAT/band having 100s time window selected with callbox.

Step 4

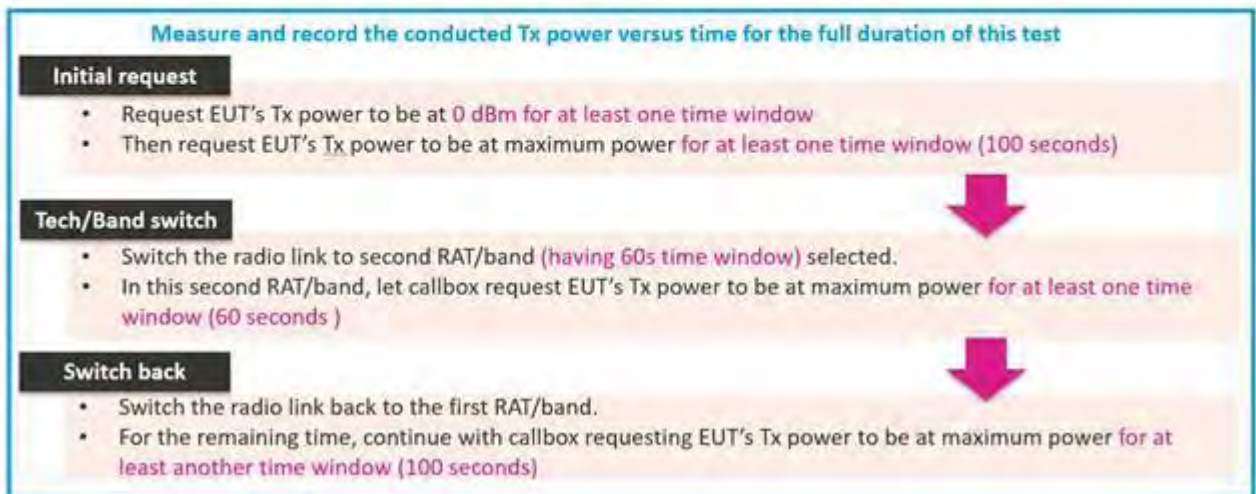

Unless otherwise stated the results shown in this test report refer only to the sample(s) tested and such sample(s) are retained for 90 days only.

除非另有說明，此報告結果僅對測試之樣品負責，同時此樣品僅保留90天。本報告未經本公司書面許可，不可部份複製。

This document is issued by the Company subject to its General Conditions of Service printed overleaf, available on request or accessible at <http://www.sgs.com.tw/Terms-and-Conditions> and for electronic format documents, subject to Terms and Conditions for Electronic Documents at <http://www.sgs.com.tw/Terms-and-Conditions>. Attention is drawn to the limitation of liability, indemnification and jurisdiction issues defined therein. Any holder of this document is advised that information contained hereon reflects the Company's findings at the time of its intervention only and within the limits of Client's instructions, if any. The Company's sole responsibility is to its Client and this document does not exonerate parties to a transaction from exercising all their rights and obligations under the transaction documents. This document cannot be reproduced except in full, without prior written approval of the Company. Any unauthorized alteration, forgery or falsification of the content or appearance of this document is unlawful and offenders may be prosecuted to the fullest extent of the law.

- Step 5: convert the measured conducted TX power into SAR
Convert the measured conducted TX power from step 4 into 1gSAR or 10gSAR value using the following equation. Perform the running time average to power and 1gSAR or 10g SAR to determine time-averaged value versus time as follows,

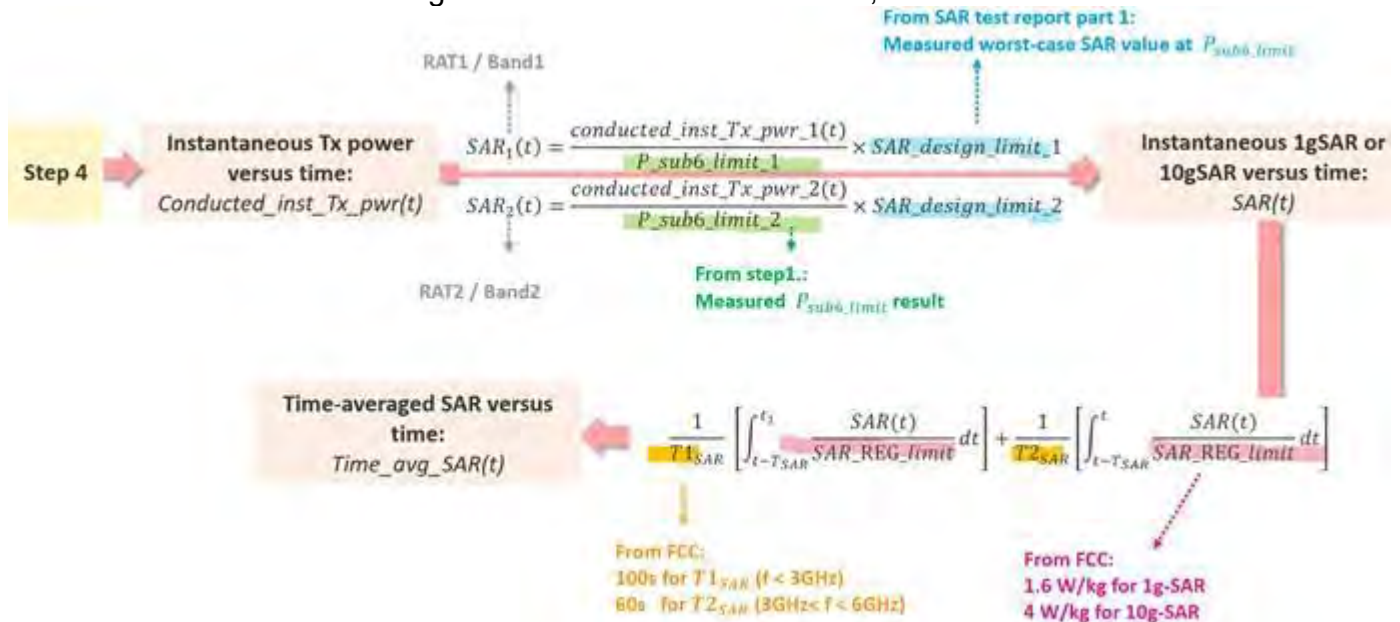

- Step 6: plot results
 - A. Make one power perspective plot containing
 1. Instantaneous TX power
 2. Requested power
 3. Calculated time-averaged power
 4. Calculated time-averaged power limits
 - B. Make one SAR perspective plot containing
 1. Calculated time-averaged 1gSAR or 10gSAR
 2. FCC limit of 1.6 W/kg (1gSAR) or 4.0 W/kg (10gSAR)
 3. Normalized time-averaged 1gSAR/1.6 or 10gSAR/4.0

Unless otherwise stated the results shown in this test report refer only to the sample(s) tested and such sample(s) are retained for 90 days only.

除非另有說明，此報告結果僅對測試之樣品負責，同時此樣品僅保留90天。本報告未經本公司書面許可，不可部份複製。

This document is issued by the Company subject to its General Conditions of Service printed overleaf, available on request or accessible at <http://www.sgs.com.tw/Terms-and-Conditions> and for electronic format documents, subject to Terms and Conditions for Electronic Documents at <http://www.sgs.com.tw/Terms-and-Conditions>. Attention is drawn to the limitation of liability, indemnification and jurisdiction issues defined therein. Any holder of this document is advised that information contained hereon reflects the Company's findings at the time of its intervention only and within the limits of Client's instructions, if any. The Company's sole responsibility is to its Client and this document does not exonerate parties to a transaction from exercising all their rights and obligations under the transaction documents. This document cannot be reproduced except in full, without prior written approval of the Company. Any unauthorized alteration, forgery or falsification of the content or appearance of this document is unlawful and offenders may be prosecuted to the fullest extent of the law.

- Step 7~8: measure and record TX power versus time in another time window change

🕒 Transition from 60s time window to 100s time window, and vice versa (step7 to step 9)

Step 7

- Establish radio link with callbox in the RAT/band having 60s time window selected.

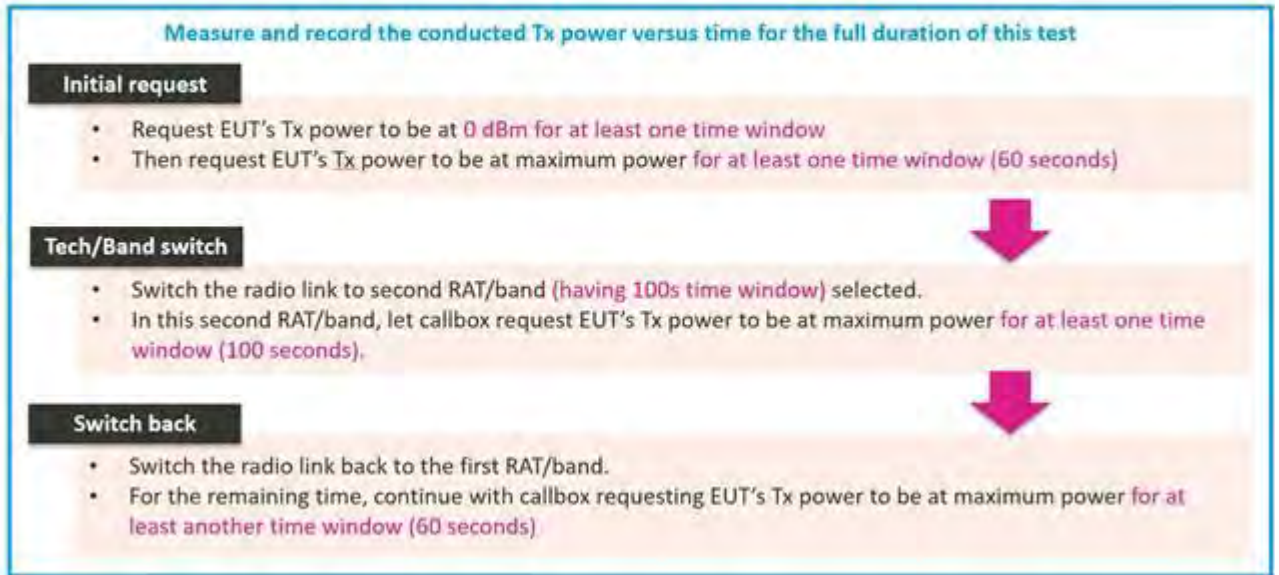

- Step 9: convert the measurement and plot results

Convert the measured conducted TX power from step 8 into 1gSAR or 10gSAR value using the equation in step 5.

Repeat step 6 to generate the plots.

Unless otherwise stated the results shown in this test report refer only to the sample(s) tested and such sample(s) are retained for 90 days only.

除非另有說明，此報告結果僅對測試之樣品負責，同時此樣品僅保留90天。本報告未經本公司書面許可，不可部份複製。

This document is issued by the Company subject to its General Conditions of Service printed overleaf, available on request or accessible at <http://www.sgs.com.tw/Terms-and-Conditions> and for electronic format documents, subject to Terms and Conditions for Electronic Documents at <http://www.sgs.com.tw/Terms-and-Conditions>. Attention is drawn to the limitation of liability, indemnification and jurisdiction issues defined therein. Any holder of this document is advised that information contained hereon reflects the Company's findings at the time of its intervention only and within the limits of Client's instructions, if any. The Company's sole responsibility is to its Client and this document does not exonerate parties to a transaction from exercising all their rights and obligations under the transaction documents. This document cannot be reproduced except in full, without prior written approval of the Company. Any unauthorized alteration, forgery or falsification of the content or appearance of this document is unlawful and offenders may be prosecuted to the fullest extent of the law.

4.9 Test Configuration and Procedure for Scenario 8: SAR Exposure Switching via Conducted Power Measurements

4.9.1 Configuration

If supported, SAR exposure switch with two active radios having the same and different time averaging windows should be covered in this test. Mediatek's TA algorithm operation is independent of the source of SAR exposure (e.g., LTE vs. NR FR1) and ensures total time-averaged RF exposure compliance for SAR exposure among the scenarios of radio 1 only, radio 1 + radio 2, and radio 2 only.

- Select any two < 6GHz RATs/bands that the EUT supports for simultaneous transmission (e.g., LTE+NR FR1).
- The selection order among all supported simultaneous transmission configurations is
 - o Select one configuration with P_{sub6_limit} values of radio1 and radio2 less than their corresponding P_{UE_max} , and their P_{sub6_limit} values are different if possible.
 - o If the previous configuration does not exist, at least one radio has its P_{sub6_limit} less than P_{UE_max} .
 - o If above two cannot be found, select one configuration that has P_{sub6_limit} of radio1 and radio2 with the least difference between P_{sub6_limit} and P_{UE_max} (i.e., P_{sub6_limit} can be greater than P_{UE_max}).
- One test with two active radios in any two different time windows is sufficient to cover this scenario.
- One SAR switching is sufficient because the TA algorithm operation is the same.

4.9.2 Procedure

- Step 1~3: measure and record TX power versus time for test scenario 8
 - A. Measure conducted TX power corresponding to radio1 P_{sub6_limit}
 - Establish device in call with the callbox for radio1 band.
 - Measure conducted TX power corresponding to radio1 P_{sub6_limit} with TA_SAR enabled and $P_{UE_backoff_offset}$ set to 0 dB, callbox set to request maximum power.
 - B. measure conducted TX power corresponding to radio2 P_{sub6_limit}
 - Repeat above step to measure conducted TX power corresponding to radio2 P_{sub6_limit} .
 - If radio2 is dependent on radio1 (for example, non-standalone mode of NR FR1 requiring radio1 LTE as anchor), then establish radio1 + radio2 call with callbox, and request all down bits for radio1 LTE.
 - In this scenario, with callbox requesting maximum power from radio2 NR FR1, measured conducted TX power corresponds to radio2 P_{sub6_limit} (as radio1 LTE is at

Unless otherwise stated the results shown in this test report refer only to the sample(s) tested and such sample(s) are retained for 90 days only.

除非另有說明，此報告結果僅對測試之樣品負責，同時此樣品僅保留90天。本報告未經本公司書面許可，不可部份複製。

This document is issued by the Company subject to its General Conditions of Service printed overleaf, available on request or accessible at <http://www.sgs.com.tw/Terms-and-Conditions> and for electronic format documents, subject to Terms and Conditions for Electronic Documents at <http://www.sgs.com.tw/Terms-and-Conditions>. Attention is drawn to the limitation of liability, indemnification and jurisdiction issues defined therein. Any holder of this document is advised that information contained hereon reflects the Company's findings at the time of its intervention only and within the limits of Client's instructions, if any. The Company's sole responsibility is to its Client and this document does not exonerate parties to a transaction from exercising all their rights and obligations under the transaction documents. This document cannot be reproduced except in full, without prior written approval of the Company. Any unauthorized alteration, forgery or falsification of the content or appearance of this document is unlawful and offenders may be prosecuted to the fullest extent of the law.

all-down bits)

Step 1

Measure / setting

- Measure conducted Tx power corresponding to P_{sub6_limit} for radio1 and radio2 in selected band
- Test condition to measure conducted P_{sub6_limit} is in **step 1.A and 1.B**
- Apply actual (intended) value to $P_{UE_backoff_offset}$ with EUT setup for radio1 + radio2 call.
- (In this description, it is assumed that radio2 has lower priority than radio1)

Step 2

Establish link

- Establish device in radio1+radio2 call, and request low power (all-down bits) on radio1

Step 3

Measure and record the conducted Tx power for both radio1 and radio2 for the full duration of this test

Radio 2 predominant

- let callbox request EUT's Tx power to be at 0 dBm in radio2 for at least one time window
- Then let callbox request EUT's Tx power to be at maximum power in radio2 for at least one time window

Radio 1+2

- set callbox to request EUT's Tx power to be at maximum power on radio1, i.e., all-up bits
- Continue radio1+radio2 call with both radios at maximum power for at least one time window

Radio 1 predominant

- drop (or request all-down bits on) radio2
- Continue radio1 at maximum power for at least one time window.

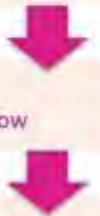

Unless otherwise stated the results shown in this test report refer only to the sample(s) tested and such sample(s) are retained for 90 days only.

除非另有說明，此報告結果僅對測試之樣品負責，同時此樣品僅保留90天。本報告未經本公司書面許可，不可部份複製。

This document is issued by the Company subject to its General Conditions of Service printed overleaf, available on request or accessible at <http://www.sgs.com.tw/Terms-and-Conditions> and for electronic format documents, subject to Terms and Conditions for Electronic Documents at <http://www.sgs.com.tw/Terms-and-Conditions>. Attention is drawn to the limitation of liability, indemnification and jurisdiction issues defined therein. Any holder of this document is advised that information contained hereon reflects the Company's findings at the time of its intervention only and within the limits of Client's instructions, if any. The Company's sole responsibility is to its Client and this document does not exonerate parties to a transaction from exercising all their rights and obligations under the transaction documents. This document cannot be reproduced except in full, without prior written approval of the Company. Any unauthorized alteration, forgery or falsification of the content or appearance of this document is unlawful and offenders may be prosecuted to the fullest extent of the law.

- Step 4: convert the measured conducted TX power into SAR
Convert the measured conducted TX power from step 3 into 1gSAR or 10gSAR value using the following equation. Perform the running time average to power and 1gSAR or 10g SAR to determine time-averaged value versus time as follows,

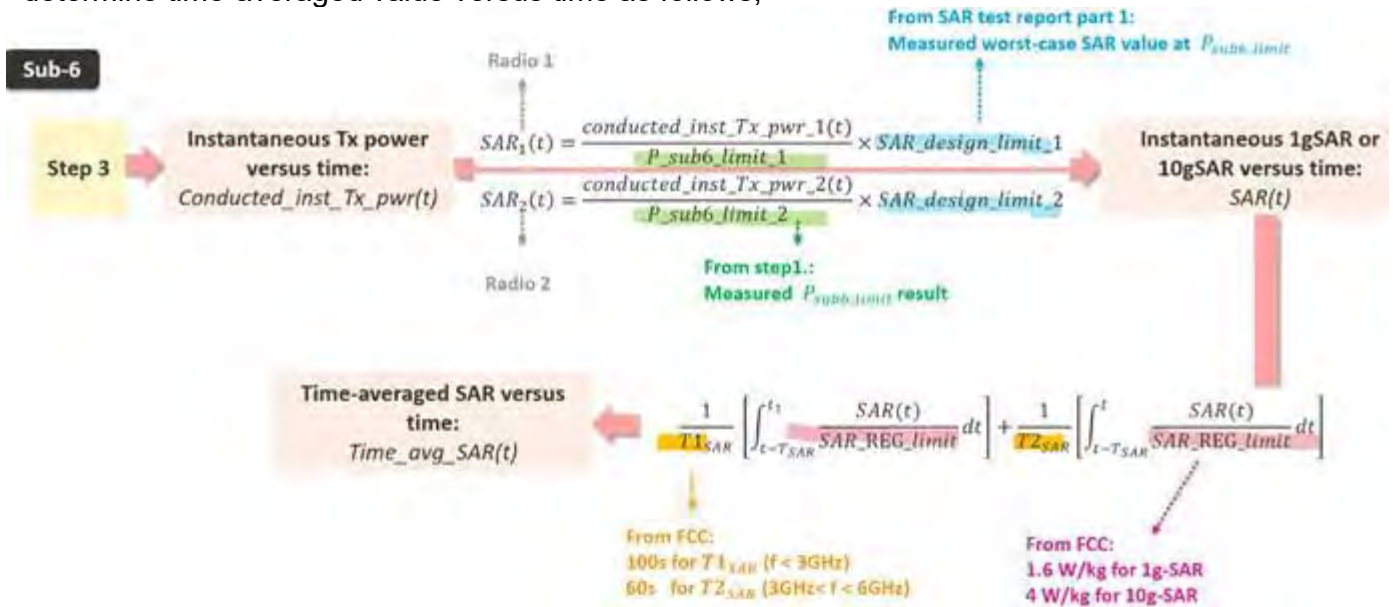

- Step 5: plot results
 - A. Make one power perspective plot containing
 1. Instantaneous TX power
 2. Requested power
 3. Calculated time-averaged power
 4. Calculated time-averaged power limits
 - B. Make one SAR perspective plot containing
 1. Calculated time-averaged 1gSAR or 10gSAR
 2. FCC limit of 1.6 W/kg (1gSAR) or 4.0 W/kg (10gSAR)
 3. Normalized time-averaged 1gSAR/1.6 or 10gSAR/4.0

Unless otherwise stated the results shown in this test report refer only to the sample(s) tested and such sample(s) are retained for 90 days only.

除非另有說明，此報告結果僅對測試之樣品負責，同時此樣品僅保留90天。本報告未經本公司書面許可，不可部份複製。

This document is issued by the Company subject to its General Conditions of Service printed overleaf, available on request or accessible at <http://www.sgs.com.tw/Terms-and-Conditions> and for electronic format documents, subject to Terms and Conditions for Electronic Documents at <http://www.sgs.com.tw/Terms-and-Conditions>. Attention is drawn to the limitation of liability, indemnification and jurisdiction issues defined therein. Any holder of this document is advised that information contained hereon reflects the Company's findings at the time of its intervention only and within the limits of Client's instructions, if any. The Company's sole responsibility is to its Client and this document does not exonerate parties to a transaction from exercising all their rights and obligations under the transaction documents. This document cannot be reproduced except in full, without prior written approval of the Company. Any unauthorized alteration, forgery or falsification of the content or appearance of this document is unlawful and offenders may be prosecuted to the fullest extent of the law.

4.10 Test Configuration and Procedure for Scenario 2: Time-Varying TX Power via SAR Measurements

SAR is measured and recorded by the following steps:

- Step 1~4: measure and record SAR versus time

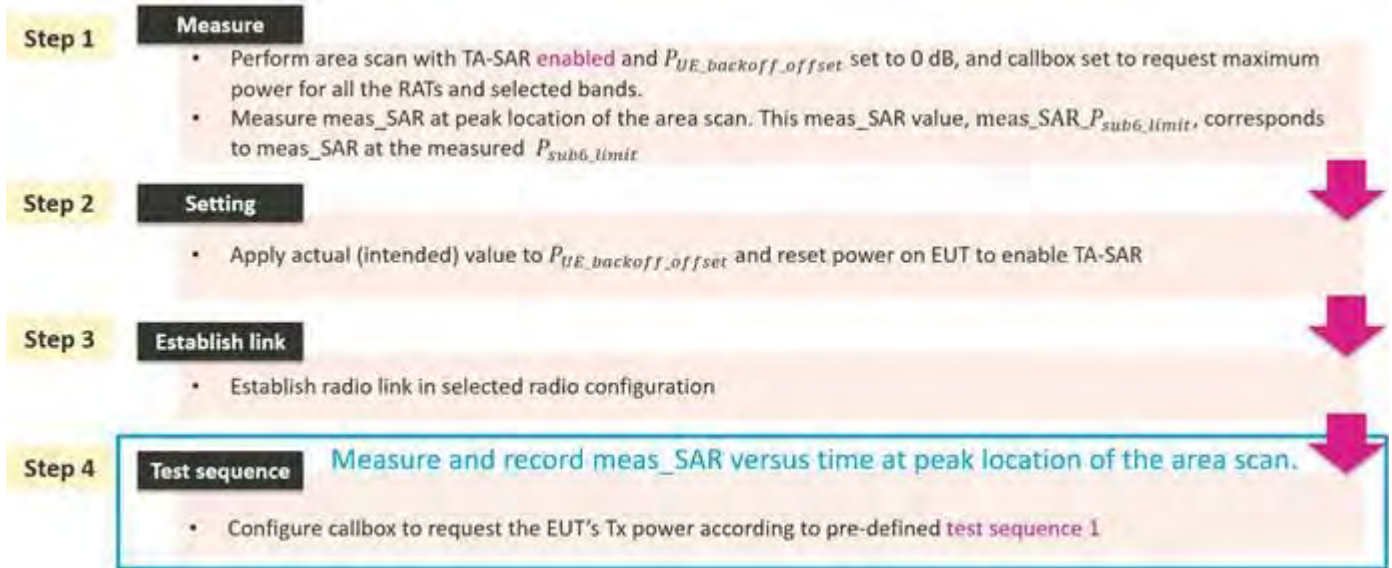

- Step 5: convert the measured SAR into time-averaged SAR

Convert the instantaneous measured SAR from step 4 into 1gSAR or 10gSAR value. Perform the running time average to 1gSAR or 10g SAR to determine time-averaged value versus time as follows,

Unless otherwise stated the results shown in this test report refer only to the sample(s) tested and such sample(s) are retained for 90 days only.

除非另有說明，此報告結果僅對測試之樣品負責，同時此樣品僅保留90天。本報告未經本公司書面許可，不可部份複製。

This document is issued by the Company subject to its General Conditions of Service printed overleaf, available on request or accessible at <http://www.sgs.com.tw/Terms-and-Conditions> and for electronic format documents, subject to Terms and Conditions for Electronic Documents at <http://www.sgs.com.tw/Terms-and-Conditions>. Attention is drawn to the limitation of liability, indemnification and jurisdiction issues defined therein. Any holder of this document is advised that information contained hereon reflects the Company's findings at the time of its intervention only and within the limits of Client's instructions, if any. The Company's sole responsibility is to its Client and this document does not exonerate parties to a transaction from exercising all their rights and obligations under the transaction documents. This document cannot be reproduced except in full, without prior written approval of the Company. Any unauthorized alteration, forgery or falsification of the content or appearance of this document is unlawful and offenders may be prosecuted to the fullest extent of the law.

Sub-6

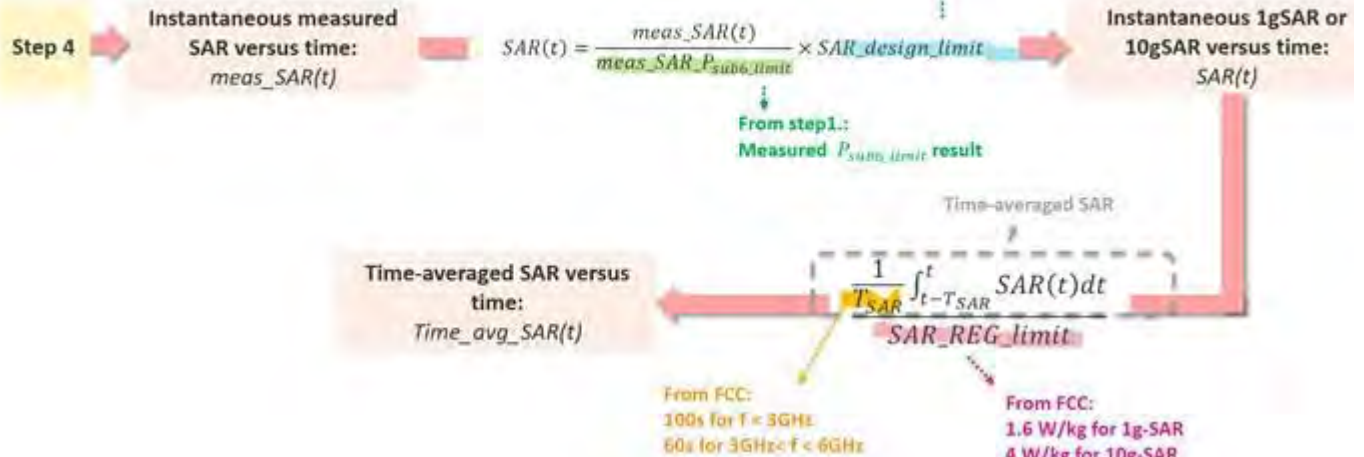

where, $meas_SAR_P_{sub6_limit}$ is the value determined in step 1, and $meas_SAR(t)$ is the instantaneous measured SAR measured in step 4.

- Step 6: plot result
 - A. Calculated time-averaged 1gSAR or 10gSAR
 - B. FCC limit of 1.6 W/kg (1gSAR) or 4.0 W/kg (10gSAR)

- Step 7: repeat steps 2 ~ 6 for pre-defined test sequence 2

Repeat steps 2 ~ 6 for pre-defined test sequence 2 and replace test sequence 1 in step 4 with test sequence 2.

- Step 8: repeat steps 2 ~ 7 for all the selected bands

The time-averaged SAR versus time shall not exceed FCC limit at all times.

Unless otherwise stated the results shown in this test report refer only to the sample(s) tested and such sample(s) are retained for 90 days only.
 除非另有說明，此報告結果僅對測試之樣品負責，同時此樣品僅保留90天。本報告未經本公司書面許可，不可部份複製。

This document is issued by the Company subject to its General Conditions of Service printed overleaf, available on request or accessible at <http://www.sgs.com.tw/Terms-and-Conditions> and for electronic format documents, subject to Terms and Conditions for Electronic Documents at <http://www.sgs.com.tw/Terms-and-Conditions>. Attention is drawn to the limitation of liability, indemnification and jurisdiction issues defined therein. Any holder of this document is advised that information contained hereon reflects the Company's findings at the time of its intervention only and within the limits of Client's instructions, if any. The Company's sole responsibility is to its Client and this document does not exonerate parties to a transaction from exercising all their rights and obligations under the transaction documents. This document cannot be reproduced except in full, without prior written approval of the Company. Any unauthorized alteration, forgery or falsification of the content or appearance of this document is unlawful and offenders may be prosecuted to the fullest extent of the law.

5. TA-SAR Validation via Conducted Power Measurements

5.1 Measurement Setup

5.1.1 Test Bench Introduction

All of the test cases defined in this chapter are conducted by using the phone, whose antenna placement for each RAT is illustrated in Figure 5-1.



Ant. (MFA)	Global	Global / NA
Sub1	LB/mb/hb	LB/mb(n70)/hb
Sub2	WiFi/GPS+mb, n77/n78	WiFi/GPS+mb, n77
Sub3	N77/N78	N77
Sub4	hb/n77/n78	hb/n77
Sub5	hb/n77/n78	hb/n77
Main3	MB	MB
Main1	LB/mb/hb	LB
Main2	MB/HB	MB(N70)/HB

Figure 5- 1 Antenna placement of the phone

Unless otherwise stated the results shown in this test report refer only to the sample(s) tested and such sample(s) are retained for 90 days only.

除非另有說明，此報告結果僅對測試之樣品負責，同時此樣品僅保留90天。本報告未經本公司書面許可，不可部份複製。

This document is issued by the Company subject to its General Conditions of Service printed overleaf, available on request or accessible at <http://www.sgs.com.tw/Terms-and-Conditions> and for electronic format documents, subject to Terms and Conditions for Electronic Documents at <http://www.sgs.com.tw/Terms-and-Conditions>. Attention is drawn to the limitation of liability, indemnification and jurisdiction issues defined therein. Any holder of this document is advised that information contained hereon reflects the Company's findings at the time of its intervention only and within the limits of Client's instructions, if any. The Company's sole responsibility is to its Client and this document does not exonerate parties to a transaction from exercising all their rights and obligations under the transaction documents. This document cannot be reproduced except in full, without prior written approval of the Company. Any unauthorized alteration, forgery or falsification of the content or appearance of this document is unlawful and offenders may be prosecuted to the fullest extent of the law.

The call boxes KeySight UXM (supporting sub6 NR and LTE) and Rohde & Schwarz CMW500 (supporting LTE, WCDMA, C2K and 2G) are used to validate the proposed TA-SAR mechanism. Figure 5-2 shows the block diagram of the measurement bench, which supports the following test scenarios.

- Test scenario 1: range of TA-SAR parameters
- Test scenario 2: time-varying TX power
- Test scenario 3: call disconnection and re-establishment
- Test scenario 5: ECI change

For these measurements, RF port of the call box is connected to the EUT’s antenna port, and the call box establishes a connection link through the test script console tool and the power meter measures the conducted output power of the EUT.

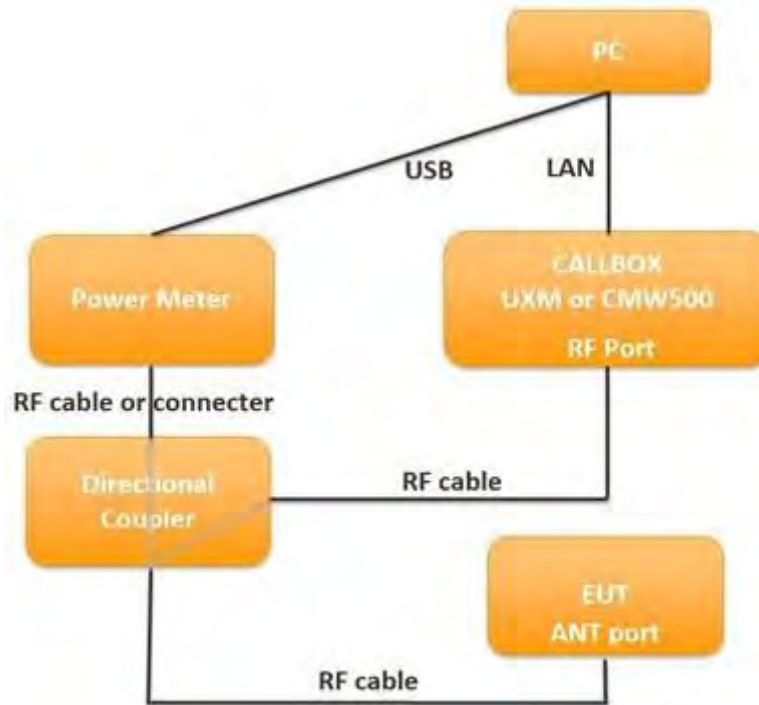

Figure 5- 2 TA-SAR conductive power test setup block diagram for scenarios 1/2/3/5

Unless otherwise stated the results shown in this test report refer only to the sample(s) tested and such sample(s) are retained for 90 days only.

除非另有說明，此報告結果僅對測試之樣品負責，同時此樣品僅保留90天。本報告未經本公司書面許可，不可部份複製。

This document is issued by the Company subject to its General Conditions of Service printed overleaf, available on request or accessible at <http://www.sgs.com.tw/Terms-and-Conditions> and for electronic format documents, subject to Terms and Conditions for Electronic Documents at <http://www.sgs.com.tw/Terms-and-Conditions>. Attention is drawn to the limitation of liability, indemnification and jurisdiction issues defined therein. Any holder of this document is advised that information contained hereon reflects the Company's findings at the time of its intervention only and within the limits of Client's instructions, if any. The Company's sole responsibility is to its Client and this document does not exonerate parties to a transaction from exercising all their rights and obligations under the transaction documents. This document cannot be reproduced except in full, without prior written approval of the Company. Any unauthorized alteration, forgery or falsification of the content or appearance of this document is unlawful and offenders may be prosecuted to the fullest extent of the law.

Figure 5-3 shows the block diagram of the measurement bench, which support test scenario 4 (band handover) and scenario 7 (time window switching). For these measurements, the RF port of the call box is connected with a 1-to-2 power divider, which allows the call box to transmit/receive signals from the two different system configurations set in these two test scenarios. Figure 5-4 shows the setup, which is highly similar to Figure 5-3, to support test scenario 6 (antenna switching); as seen in the figure, two EUT's antenna ports are individually connected with a RF cable.

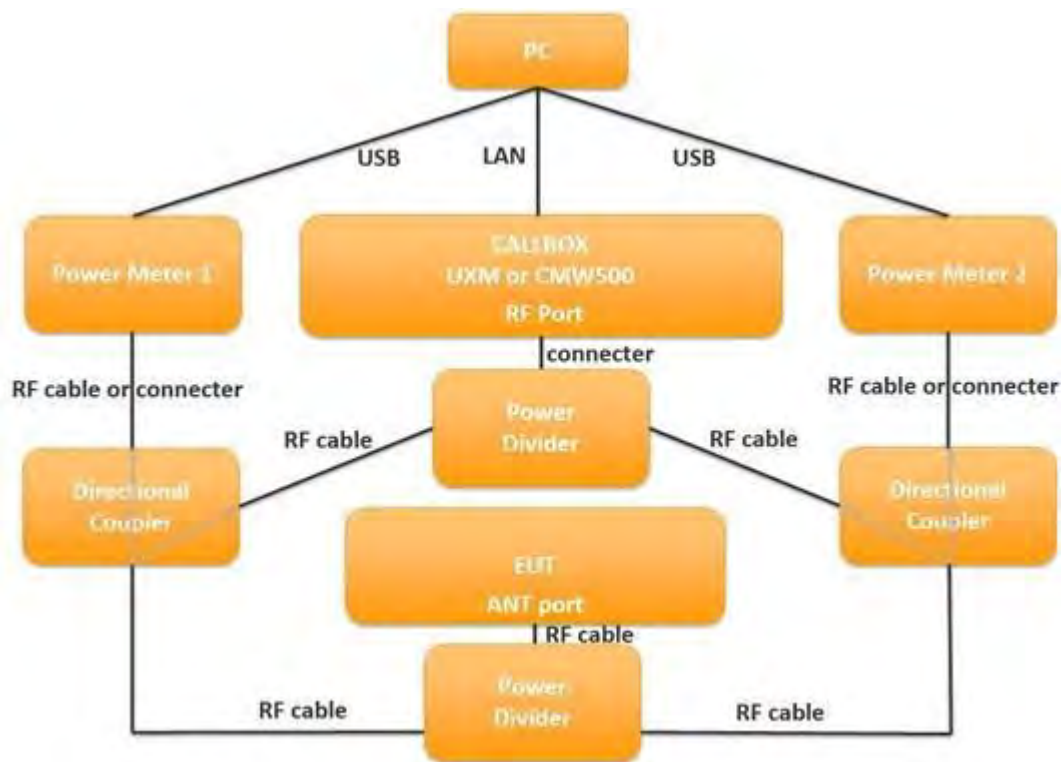

Figure 5- 3 TA-SAR conductive power test setup block diagram for scenarios 4 and 7

Unless otherwise stated the results shown in this test report refer only to the sample(s) tested and such sample(s) are retained for 90 days only.

除非另有說明，此報告結果僅對測試之樣品負責，同時此樣品僅保留90天。本報告未經本公司書面許可，不可部份複製。

This document is issued by the Company subject to its General Conditions of Service printed overleaf, available on request or accessible at <http://www.sgs.com.tw/Terms-and-Conditions> and for electronic format documents, subject to Terms and Conditions for Electronic Documents at <http://www.sgs.com.tw/Terms-and-Conditions>. Attention is drawn to the limitation of liability, indemnification and jurisdiction issues defined therein. Any holder of this document is advised that information contained hereon reflects the Company's findings at the time of its intervention only and within the limits of Client's instructions, if any. The Company's sole responsibility is to its Client and this document does not exonerate parties to a transaction from exercising all their rights and obligations under the transaction documents. This document cannot be reproduced except in full, without prior written approval of the Company. Any unauthorized alteration, forgery or falsification of the content or appearance of this document is unlawful and offenders may be prosecuted to the fullest extent of the law.

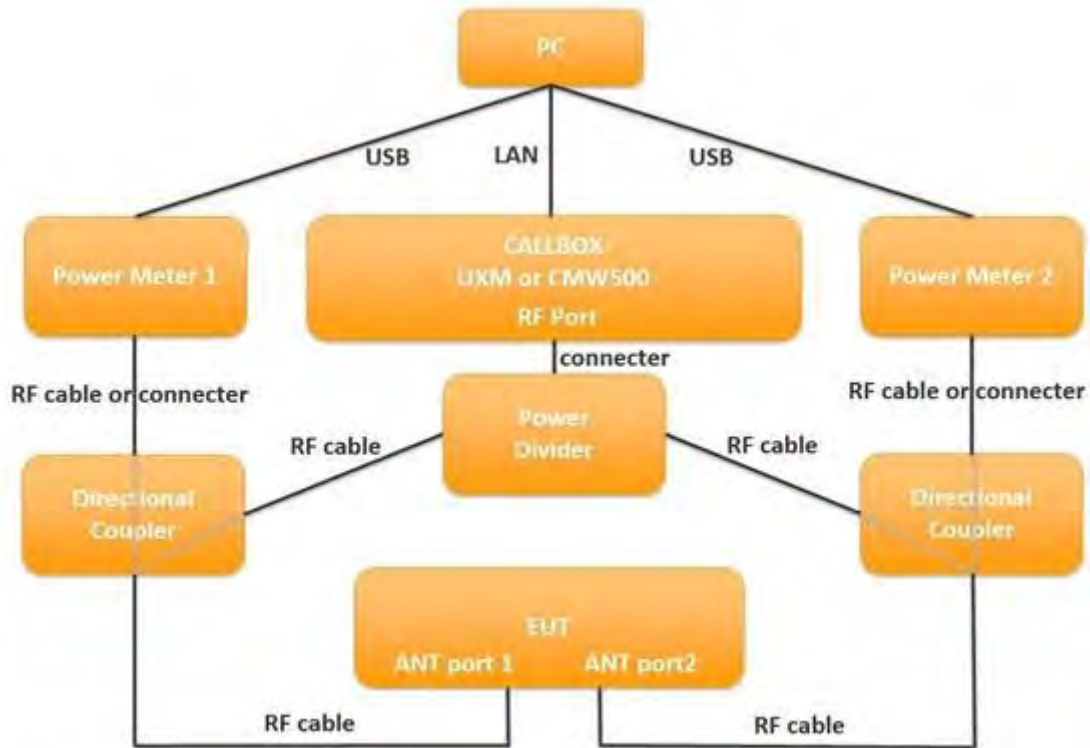

Figure 5- 4 TA-SAR conductive power test setup block diagram for scenario 6

Unless otherwise stated the results shown in this test report refer only to the sample(s) tested and such sample(s) are retained for 90 days only.

除非另有說明，此報告結果僅對測試之樣品負責，同時此樣品僅保留90天。本報告未經本公司書面許可，不可部份複製。

This document is issued by the Company subject to its General Conditions of Service printed overleaf, available on request or accessible at <http://www.sgs.com.tw/Terms-and-Conditions> and for electronic format documents, subject to Terms and Conditions for Electronic Documents at <http://www.sgs.com.tw/Terms-and-Conditions>. Attention is drawn to the limitation of liability, indemnification and jurisdiction issues defined therein. Any holder of this document is advised that information contained hereon reflects the Company's findings at the time of its intervention only and within the limits of Client's instructions, if any. The Company's sole responsibility is to its Client and this document does not exonerate parties to a transaction from exercising all their rights and obligations under the transaction documents. This document cannot be reproduced except in full, without prior written approval of the Company. Any unauthorized alteration, forgery or falsification of the content or appearance of this document is unlawful and offenders may be prosecuted to the fullest extent of the law.

Figure 5-5 shows the setup for test scenario 4 (RAT handover) and scenario 8 (SAR exposure switching). Since two RATs need to be controlled in these two scenarios, RF port of RAT #1 and RF port of RAT #2 of the call box are individually connected to an antenna port of the EUT through a directional coupler. It is noted that each of the two RATs individually transmit signals through one antenna port. The antenna port assignment of each RAT for these two scenarios is described in Figure 5-1.

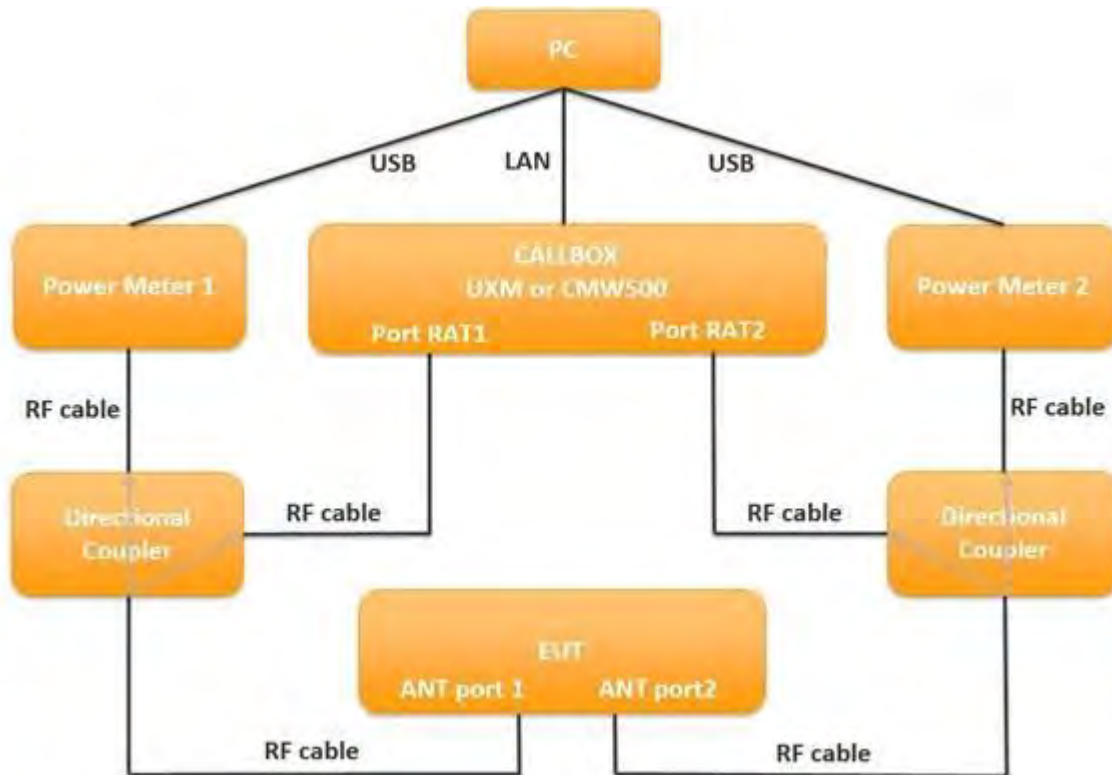

Figure 5- 5 TA-SAR conductive power test setup block diagram for scenarios 4/8

Unless otherwise stated the results shown in this test report refer only to the sample(s) tested and such sample(s) are retained for 90 days only.

除非另有說明，此報告結果僅對測試之樣品負責，同時此樣品僅保留90天。本報告未經本公司書面許可，不可部份複製。

This document is issued by the Company subject to its General Conditions of Service printed overleaf, available on request or accessible at <http://www.sgs.com.tw/Terms-and-Conditions> and for electronic format documents, subject to Terms and Conditions for Electronic Documents at <http://www.sgs.com.tw/Terms-and-Conditions>. Attention is drawn to the limitation of liability, indemnification and jurisdiction issues defined therein. Any holder of this document is advised that information contained hereon reflects the Company's findings at the time of its intervention only and within the limits of Client's instructions, if any. The Company's sole responsibility is to its Client and this document does not exonerate parties to a transaction from exercising all their rights and obligations under the transaction documents. This document cannot be reproduced except in full, without prior written approval of the Company. Any unauthorized alteration, forgery or falsification of the content or appearance of this document is unlawful and offenders may be prosecuted to the fullest extent of the law.

5.1.2 sub6 NR/LTE/3G/2G Power Limit Table and Test Configurations

For the supported bands/channels/antennas of each technology, the measured power limit (P_{sub6_limit}), corresponding to SAR_design_limit , is listed in the table 5-1. The SAR_design_limit is determined by taking 1-dB device uncertainty into consideration. Please note that for TDD bands with TX duty cycles less than or equal to 100%, the measured power limit corresponds to the burst averaged power level which does not account for TX duty cycle.

Table 5-1 Summary table of power limit (P_{sub6_limit}) for all supported RAT

RAT	Band	ANT	Duty cycle (%)	$P_{limit,nom}$ (dBm) Setting								$P_{max,nom}$ (dBm) Setting	
				ECI 1 RCV		ECI 2 HOTSPOT		ECI 3 EarJack		ECI 4 Free			
				burst-power	frame-averaged power	burst-power	frame-averaged power	burst-power	frame-averaged power	burst-power	frame-averaged power	burst-power	frame-averaged power
2G GSM	850	A(M1)	12.5	37.63	28.60	32.00	22.97	32.00	22.97	32.00	22.97	33.00	23.97
2G GPRS	850 1Tx	A(M1)	12.5	33.00	23.97	32.00	22.97	32.00	22.97	32.00	22.97	33.00	23.97
2G GPRS	850 2Tx	A(M1)	25	31.00	24.98	30.00	23.98	30.00	23.98	30.00	23.98	31.00	24.98
2G GPRS	850 3Tx	A(M1)	37.5	29.00	24.74	28.00	23.74	28.00	23.74	28.00	23.74	29.00	24.74
2G GPRS	850 4Tx	A(M1)	50	28.00	24.99	27.00	23.99	27.00	23.99	27.00	23.99	28.00	24.99
2G GSM	1900	B(M2)	12.5	37.53	28.50	30.00	20.97	30.00	20.97	32.33	23.30	30.00	20.97
2G GPRS	1900 1Tx	B(M2)	12.5	30.00	20.97	30.00	20.97	30.00	20.97	30.00	20.97	30.00	20.97
2G GPRS	1900 2Tx	B(M2)	25	28.00	21.98	28.00	21.98	28.00	21.98	28.00	21.98	28.00	21.98
2G GPRS	1900 3Tx	B(M2)	37.5	26.00	21.74	26.00	21.74	26.00	21.74	26.00	21.74	26.00	21.74
2G GPRS	1900 4Tx	B(M2)	50	25.00	21.99	26.31	23.30	26.31	23.30	25.00	21.99	25.00	21.99
3G WCDMA	II	B(M2)	100	29.50	29.50	20.00	20.00	20.00	20.00	20.00	20.00	22.00	22.00
3G WCDMA	IV	B(M2)	100	30.00	30.00	20.00	20.00	20.00	20.00	20.00	20.00	23.00	23.00
3G WCDMA	V	A(M1)	100	28.10	28.10	23.00	23.00	23.00	23.00	23.00	23.00	24.00	24.00
4G LTE	B2	B(M2)	100	28.90	28.90	17.50	17.50	17.50	17.50	17.50	17.50	23.00	23.00
	B2	C(M3)	100	31.00	31.00	21.00	21.00	21.00	21.00	21.00	21.00	23.00	23.00
	B4	B(M2)	100	30.50	30.50	18.50	18.50	18.50	18.50	18.50	18.50	24.00	24.00
	B4	C(M3)	100	32.00	32.00	20.00	20.00	20.00	20.00	20.00	20.00	23.00	23.00
	B5	A(M1)	100	28.90	28.90	24.70	24.70	24.70	24.70	24.70	24.70	24.00	24.00
	B12	A(M1)	100	29.80	29.80	26.80	26.80	26.80	26.80	26.80	26.80	24.00	24.00
	B13	A(M1)	100	30.00	30.00	26.30	26.30	26.30	26.30	26.30	26.30	24.00	24.00
	B26	A(M1)	100	28.90	28.90	24.70	24.70	24.70	24.70	24.70	24.70	24.00	24.00
	B38	B(M2)	63.3	28.89	26.90	21.99	20.00	21.99	20.00	21.99	20.00	23.00	21.01
	B41 PC3	B(M2)	63.3	28.89	26.90	21.99	20.00	21.99	20.00	21.99	20.00	23.00	21.01
B66	B(M2)	100	30.50	30.50	18.50	18.50	18.50	18.50	18.50	18.50	24.00	24.00	
5G NR	n5	A(M1)	100	28.90	28.90	23.00	23.00	23.00	23.00	23.00	23.00	24.00	24.00
	n66	B(M2)	100	28.60	28.60	17.50	17.50	17.50	17.50	17.50	17.50	24.00	24.00
	n66	C(M3)	100	22.00	22.00	21.00	21.00	21.00	21.00	21.00	21.00	24.00	24.00

Table 5-2 summarizes the test configurations of all RATs, and the corresponding worst-case measured SAR for each RAT under the power limit.

Unless otherwise stated the results shown in this test report refer only to the sample(s) tested and such sample(s) are retained for 90 days only.

除非另有說明，此報告結果僅對測試之樣品負責，同時此樣品僅保留90天。本報告未經本公司書面許可，不可部份複製。

This document is issued by the Company subject to its General Conditions of Service printed overleaf, available on request or accessible at <http://www.sgs.com.tw/Terms-and-Conditions> and for electronic format documents, subject to Terms and Conditions for Electronic Documents at <http://www.sgs.com.tw/Terms-and-Conditions>. Attention is drawn to the limitation of liability, indemnification and jurisdiction issues defined therein. Any holder of this document is advised that information contained hereon reflects the Company's findings at the time of its intervention only and within the limits of Client's instructions, if any. The Company's sole responsibility is to its Client and this document does not exonerate parties to a transaction from exercising all their rights and obligations under the transaction documents. This document cannot be reproduced except in full, without prior written approval of the Company. Any unauthorized alteration, forgery or falsification of the content or appearance of this document is unlawful and offenders may be prosecuted to the fullest extent of the law.

Table 5-2 Test configurations of radio technologies and worst-case measured SAR

Test Case	Test Scenario	Test Tech	Test band	Test Sequence	BW (MHz)	Modulation	duty cycle	RB size	RB offset	Test Position	Gap (mm)	ANT index	ANT date (TX/RX)	ECC	UL Channel	UL Freq (MHz)	DL Channel	DL Freq (MHz)	Part 1, SAR@10g 1-g SAR (W/kg)	SAR req.	PLM1, frame-averaged	Pmax, frame-averaged	min power duration	duration 1	stop call	duration 2	duration 3		
0	1. Range of TA-SAR parameters	LTE	Band 2	0	20	QPSK	100.00%	1	0	N/A	10	RLM1	1	0/0	2	18700	1860	1940	0.082	1.6	18.13	22.87	300	570					
1		2G	GPRS ESD 4Tx	1	N/A	GMSK	50.00%	N/A	N/A	back side	10	ALM1	0	0/0	2	18700	1860	1940	0.082	1.6	22.42	23.54	150	720					
2		WCDMA	Band II	1	N/A	RMK	100.00%	N/A	N/A	bottom edge	10	RLM2	1	0/0	2	9938	1907.6	9938	1907.6	0.347	1.6	20.23	22.95	150	720				
3		WCDMA	Band IV	1	N/A	RMK	100.00%	N/A	N/A	bottom edge	10	RLM2	1	0/0	2	1312	1712.4	1312	1712.4	0.399	1.6	20.25	22.88	150	720				
4		LTE	Band 2	1	20	QPSK	100.00%	1	0	bottom edge	10	RLM2	1	0/0	2	18700	1860	1940	0.082	1.6	18.13	22.87	150	720					
5		LTE	Band 66	1	20	QPSK	100.00%	50	50	bottom edge	10	RLM2	1	0/0	2	132072	1720	66336	2120	0.163	1.6	18.36	23.88	150	720				
6		FR1	n66	1	40	QPSK(DT-S-OFDM)	100.00%	128	54	back side	10	RLM2	1	0/0	2	167800	1746	429000	2146	0.164	1.6	18.21	23.93	150	720				
7		FR1	n5	1	20	QPSK(DT-S-OFDM)	100.00%	1	104	back side	10	ALM1	0	0/0	2	167300	836.5	176300	881.5	0.463	1.6	23.07	23.86	150	720				
8		2G	GPRS ESD 4Tx	2	N/A	GMSK	50.00%	N/A	N/A	back side	10	RLM2	0	0/0	2	261	848.8	251	893.8	0.414	1.6	22.42	23.64	150	720				
9		WCDMA	Band II	2	N/A	RMK	100.00%	N/A	N/A	bottom edge	10	RLM2	1	0/0	2	9938	1907.6	9938	1907.6	0.347	1.6	20.23	22.95	150	720				
10		WCDMA	Band IV	2	N/A	RMK	100.00%	N/A	N/A	bottom edge	10	RLM2	1	0/0	2	1312	1712.4	1312	1712.4	0.399	1.6	20.25	22.88	150	720				
11		LTE	Band 2	2	20	QPSK	100.00%	1	0	bottom edge	10	RLM2	1	0/0	2	18700	1860	1940	0.082	1.6	18.13	22.87	150	720					
12		LTE	Band 66	2	20	QPSK	100.00%	50	50	bottom edge	10	RLM2	1	0/0	2	132072	1720	66336	2120	0.163	1.6	18.36	23.88	150	720				
13		FR1	n66	2	40	QPSK(DT-S-OFDM)	100.00%	128	54	back side	10	RLM2	1	0/0	2	167800	1746	429000	2146	0.164	1.6	18.21	23.93	150	720				
14		FR1	n5	2	20	QPSK(DT-S-OFDM)	100.00%	1	104	back side	10	ALM1	0	0/0	2	167300	836.5	176300	881.5	0.463	1.6	23.07	23.86	150	720				
15	3. Call disconnection and re-establishment	LTE	Band 2	0	20	QPSK	100.00%	1	0	N/A	10	RLM2	1	0/0	2	18700	1860	1940	0.082	1.6	18.13	22.87	300	200	10	200			
16	4. band handover	LTE	Band 2	0	20	QPSK	100.00%	1	0	N/A	10	RLM2	1	0/0	2	18700	1860	1940	0.082	1.6	18.13	23.86	300	200	200	200			
17	5. Change in operating state	LTE	Band 2	0	20	QPSK	100.00%	1	0	N/A	10	RLM2	1	0/0	2	18700	1860	1940	0.082	1.6	18.13	23.87	300	200	200	200			
18	8. SAR exposure switching (ENDC)	LTE	Band 2	0	20	QPSK	100.00%	1	0	N/A	10	RLM2	1	0/0	2	18700	1860	1940	0.082	1.6	18.13	23.87	300	200	200	200			
		FR1	n5	0	20	QPSK(DT-S-OFDM)	100.00%	1	104	N/A	10	ALM1	0	0/0	2	167300	836.5	176300	881.5	0.463	1.6	23.07	23.87	300	200	200	200		

Unless otherwise stated the results shown in this test report refer only to the sample(s) tested and such sample(s) are retained for 90 days only.

除非另有說明，此報告結果僅對測試之樣品負責，同時此樣品僅保留90天。本報告未經本公司書面許可，不可部份複製。

This document is issued by the Company subject to its General Conditions of Service printed overleaf, available on request or accessible at <http://www.sgs.com.tw/Terms-and-Conditions> and for electronic format documents, subject to Terms and Conditions for Electronic Documents at <http://www.sgs.com.tw/Terms-and-Conditions>. Attention is drawn to the limitation of liability, indemnification and jurisdiction issues defined therein. Any holder of this document is advised that information contained hereon reflects the Company's findings at the time of its intervention only and within the limits of Client's instructions, if any. The Company's sole responsibility is to its Client and this document does not exonerate parties to a transaction from exercising all their rights and obligations under the transaction documents. This document cannot be reproduced except in full, without prior written approval of the Company. Any unauthorized alteration, forgery or falsification of the content or appearance of this document is unlawful and offenders may be prosecuted to the fullest extent of the law.

5.2 Conducted Power Measurement Results for Scenario1: Range of TA-SAR Parameters

In this scenario, two TA-SAR parameters are swept to validate Mediatek's TA-SAR algorithm. The parameter sets are summarized in Table 5-3, and the test procedure follows section 4.2.2. The measurement setup is shown in Figure 5-2. The high-level summary of the final validation results are also listed in the last column of the table, which concludes that Mediatek's TA-SAR algorithm can maintain the time-averaged SAR is always below the FCC requirement for all test cases. The following section will demonstrate case-by-case to show how Mediatek's TA-SAR algorithm behaves for different parameters.

Table 5-3 TA-SAR parameters setting for scenario 1

Test case	RAT	Test band	Test seq.	ECI	Max power (dBm)	P_{sub6_limit} (dBm)	$P_{LowThresh}$ (dBm)	$P_{UE_backoff}$ (dBm)	$P_{UE_max_cust}$ (dBm)	Pass /Fail SAR limit
0	LTE	B2	0	2	23	23.00	17.50	17.00	14.50	Pass

These test cases are for 4G LTE and are conducted under LTE band B2 with ECI = 2. The corresponding detailed test procedure is described in 4.2.2. For the figure set of each case, the first figure demonstrates the EUT's instantaneous conducted TX power, the time-averaged conducted TX power behavior over time, and the power limit ($P_{reg_sub6_limit} = P_{sub6_limit} + 1\text{dB device uncertainty}$). The second figure illustrates the corresponding time-averaged SAR over time converted from the TX time-averaged power by using the equation listed in section 4.2.2. For all test cases, the time-averaged SAR does not exceed the FCC limit.

Unless otherwise stated the results shown in this test report refer only to the sample(s) tested and such sample(s) are retained for 90 days only.

除非另有說明，此報告結果僅對測試之樣品負責，同時此樣品僅保留90天。本報告未經本公司書面許可，不可部份複製。

This document is issued by the Company subject to its General Conditions of Service printed overleaf, available on request or accessible at <http://www.sgs.com.tw/Terms-and-Conditions> and for electronic format documents, subject to Terms and Conditions for Electronic Documents at <http://www.sgs.com.tw/Terms-and-Conditions>. Attention is drawn to the limitation of liability, indemnification and jurisdiction issues defined therein. Any holder of this document is advised that information contained hereon reflects the Company's findings at the time of its intervention only and within the limits of Client's instructions, if any. The Company's sole responsibility is to its Client and this document does not exonerate parties to a transaction from exercising all their rights and obligations under the transaction documents. This document cannot be reproduced except in full, without prior written approval of the Company. Any unauthorized alteration, forgery or falsification of the content or appearance of this document is unlawful and offenders may be prosecuted to the fullest extent of the law.

• Case 0 in table 5-3

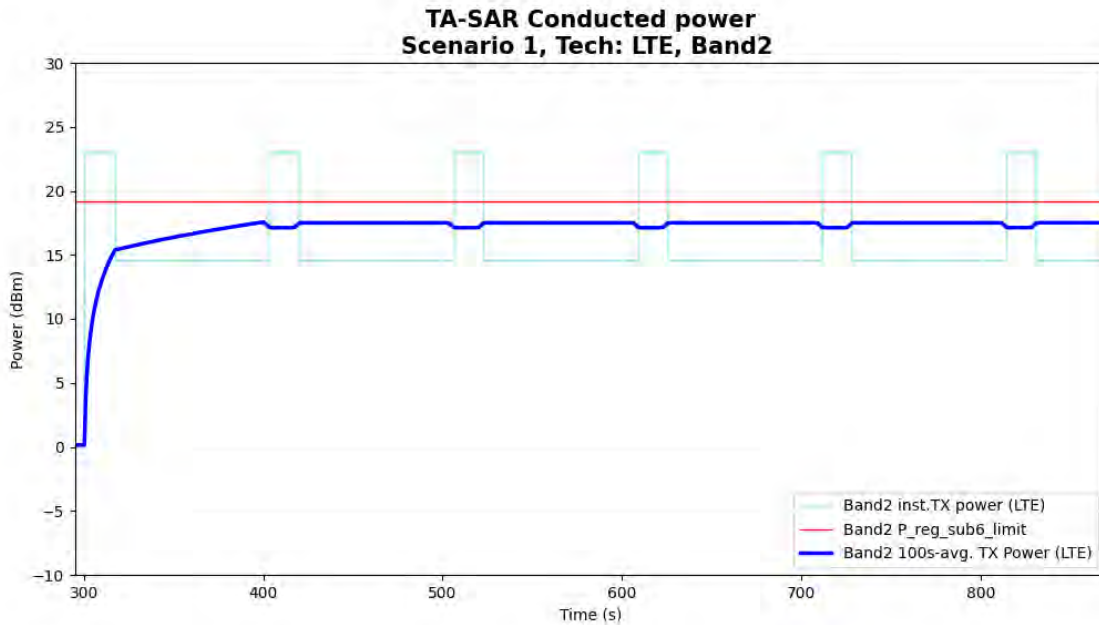

Figure 5- 6 Time-averaged conducted TX power over time for case 0

Unless otherwise stated the results shown in this test report refer only to the sample(s) tested and such sample(s) are retained for 90 days only.

除非另有說明，此報告結果僅對測試之樣品負責，同時此樣品僅保留90天。本報告未經本公司書面許可，不可部份複製。

This document is issued by the Company subject to its General Conditions of Service printed overleaf, available on request or accessible at <http://www.sgs.com.tw/Terms-and-Conditions> and for electronic format documents, subject to Terms and Conditions for Electronic Documents at <http://www.sgs.com.tw/Terms-and-Conditions>. Attention is drawn to the limitation of liability, indemnification and jurisdiction issues defined therein. Any holder of this document is advised that information contained hereon reflects the Company's findings at the time of its intervention only and within the limits of Client's instructions, if any. The Company's sole responsibility is to its Client and this document does not exonerate parties to a transaction from exercising all their rights and obligations under the transaction documents. This document cannot be reproduced except in full, without prior written approval of the Company. Any unauthorized alteration, forgery or falsification of the content or appearance of this document is unlawful and offenders may be prosecuted to the fullest extent of the law.

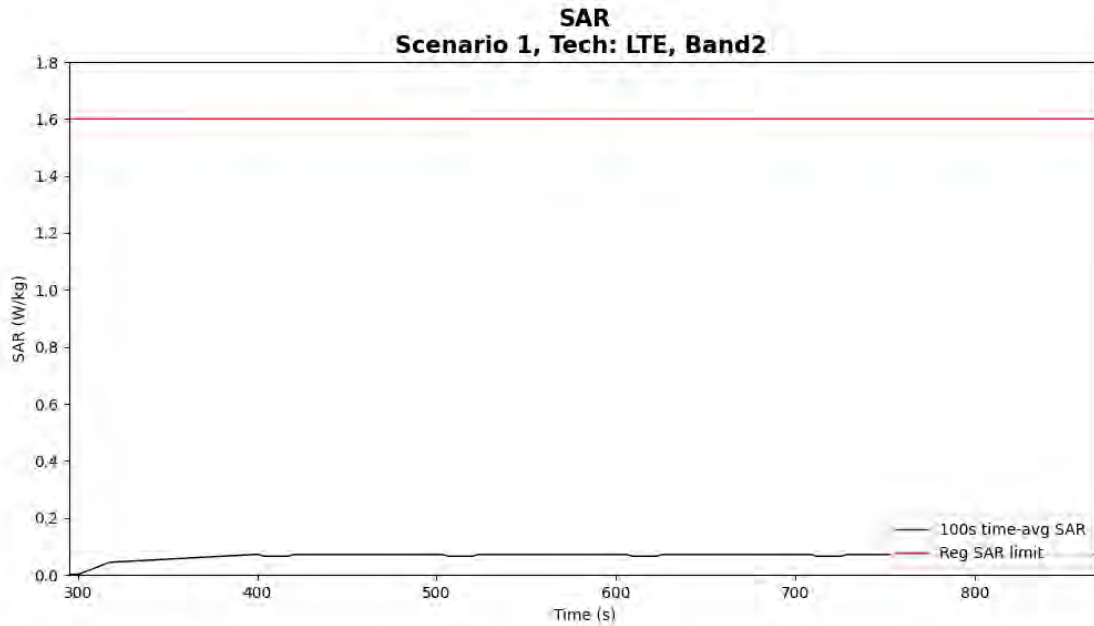

Figure 5- 7 Time-averaged SAR for case 0

FCC 1gSAR limit	1.6 W/kg
Max 100s-time averaged 1gSAR	0.071955 W/kg
Validation result: pass	

Unless otherwise stated the results shown in this test report refer only to the sample(s) tested and such sample(s) are retained for 90 days only.

除非另有說明，此報告結果僅對測試之樣品負責，同時此樣品僅保留90天。本報告未經本公司書面許可，不可部份複製。

This document is issued by the Company subject to its General Conditions of Service printed overleaf, available on request or accessible at <http://www.sgs.com.tw/Terms-and-Conditions> and for electronic format documents, subject to Terms and Conditions for Electronic Documents at <http://www.sgs.com.tw/Terms-and-Conditions>. Attention is drawn to the limitation of liability, indemnification and jurisdiction issues defined therein. Any holder of this document is advised that information contained hereon reflects the Company's findings at the time of its intervention only and within the limits of Client's instructions, if any. The Company's sole responsibility is to its Client and this document does not exonerate parties to a transaction from exercising all their rights and obligations under the transaction documents. This document cannot be reproduced except in full, without prior written approval of the Company. Any unauthorized alteration, forgery or falsification of the content or appearance of this document is unlawful and offenders may be prosecuted to the fullest extent of the law.

5.3 Conducted Power Measurement Results for Scenario 2: Time-Varying TX Power

In this scenario, Mediatek's TA-SAR algorithm is tested under more dynamic power test sequences. The test sequence #1 is shown in section 4.1 and test sequence #2 is tabulated in table 4.4. All of the test cases for this scenario are relegated in Table 5-4, and the test procedure follows section 4.3.2. The measurement setup is shown in Figure 5-2. The high-level summary of the final validation results are also listed in the last column of the table, which concludes that Mediatek's TA-SAR algorithm can maintain the time-averaged SAR is always below the FCC requirement for all test cases. The following sections will demonstrate case-by-case to show how Mediatek's TA-SAR algorithm behaves for each RAT.

Table 5-4 TA-SAR parameters setting for scenario 2

Test case	RAT	Test band	Test seq.	ECI	Max power (dBm)	P_{sub6_limit} (dBm)	$P_{LowThresh}$ (dBm)	$P_{UE_backoff}$ (dBm)	$P_{UE_max_cust}$ (dBm)	Pass /Fail SAR limit
1	2G	GPRS 850 4Tx	1	2	28.00	27.00	26.50	24.00	28.00	Pass
2	WCDMA	Band 2	1	2	22.00	20.00	19.50	17.00	22.00	Pass
3	WCDMA	Band 4	1	2	23.00	20.00	19.50	17.00	23.00	Pass
4	LTE	Band 2	1	2	23.00	17.50	17.00	14.50	23.00	Pass
5	LTE	Band 66	1	2	24.00	18.50	18.00	15.50	24.00	Pass
6	FR1	n66	1	2	24.00	17.50	17.00	14.50	24.00	Pass
7	FR1	n5	1	2	24.00	23.00	22.50	20.00	24.00	Pass
8	2G	GPRS 850 4Tx	2	2	28.00	27.00	26.50	24.00	28.00	Pass
9	WCDMA	Band 2	2	2	22.00	20.00	19.50	17.00	22.00	Pass
10	WCDMA	Band 4	2	2	23.00	20.00	19.50	17.00	23.00	Pass
11	LTE	Band 2	2	2	23.00	17.50	17.00	14.50	23.00	Pass
12	LTE	Band 66	2	2	24.00	18.50	18.00	15.50	24.00	Pass
13	FR1	n66	2	2	24.00	17.50	17.00	14.50	24.00	Pass
14	FR1	n5	2	2	24.00	23.00	22.50	20.00	24.00	Pass

Unless otherwise stated the results shown in this test report refer only to the sample(s) tested and such sample(s) are retained for 90 days only.

除非另有說明，此報告結果僅對測試之樣品負責，同時此樣品僅保留90天。本報告未經本公司書面許可，不可部份複製。

This document is issued by the Company subject to its General Conditions of Service printed overleaf, available on request or accessible at <http://www.sgs.com.tw/Terms-and-Conditions> and for electronic format documents, subject to Terms and Conditions for Electronic Documents at <http://www.sgs.com.tw/Terms-and-Conditions>. Attention is drawn to the limitation of liability, indemnification and jurisdiction issues defined therein. Any holder of this document is advised that information contained hereon reflects the Company's findings at the time of its intervention only and within the limits of Client's instructions, if any. The Company's sole responsibility is to its Client and this document does not exonerate parties to a transaction from exercising all their rights and obligations under the transaction documents. This document cannot be reproduced except in full, without prior written approval of the Company. Any unauthorized alteration, forgery or falsification of the content or appearance of this document is unlawful and offenders may be prosecuted to the fullest extent of the law.

5.3.1 Measurement results for NR

These test cases are for sub6 NR and is conducted under NR bands n66 and n5 with ECI = 2. The corresponding detailed test procedure is described in 4.3.2. For the figure set of each case, the first figure demonstrates the EUT's instantaneous conducted TX power, the time-averaged conducted TX power behavior over time, and the power limit ($P_{reg_sub6_limit} = P_{sub6_limit} + 1\text{dB device uncertainty}$). The second figure illustrates the corresponding time-averaged SAR over time converted from the TX time-averaged power by using the equation listed in section 4.3.2. For all test cases, the time-averaged SAR does not exceed the FCC limit.

Unless otherwise stated the results shown in this test report refer only to the sample(s) tested and such sample(s) are retained for 90 days only.

除非另有說明，此報告結果僅對測試之樣品負責，同時此樣品僅保留90天。本報告未經本公司書面許可，不可部份複製。

This document is issued by the Company subject to its General Conditions of Service printed overleaf, available on request or accessible at <http://www.sgs.com.tw/Terms-and-Conditions> and for electronic format documents, subject to Terms and Conditions for Electronic Documents at <http://www.sgs.com.tw/Terms-and-Conditions>. Attention is drawn to the limitation of liability, indemnification and jurisdiction issues defined therein. Any holder of this document is advised that information contained hereon reflects the Company's findings at the time of its intervention only and within the limits of Client's instructions, if any. The Company's sole responsibility is to its Client and this document does not exonerate parties to a transaction from exercising all their rights and obligations under the transaction documents. This document cannot be reproduced except in full, without prior written approval of the Company. Any unauthorized alteration, forgery or falsification of the content or appearance of this document is unlawful and offenders may be prosecuted to the fullest extent of the law.

- Case 6 in table 5-4: NR n66 result for test sequence 1

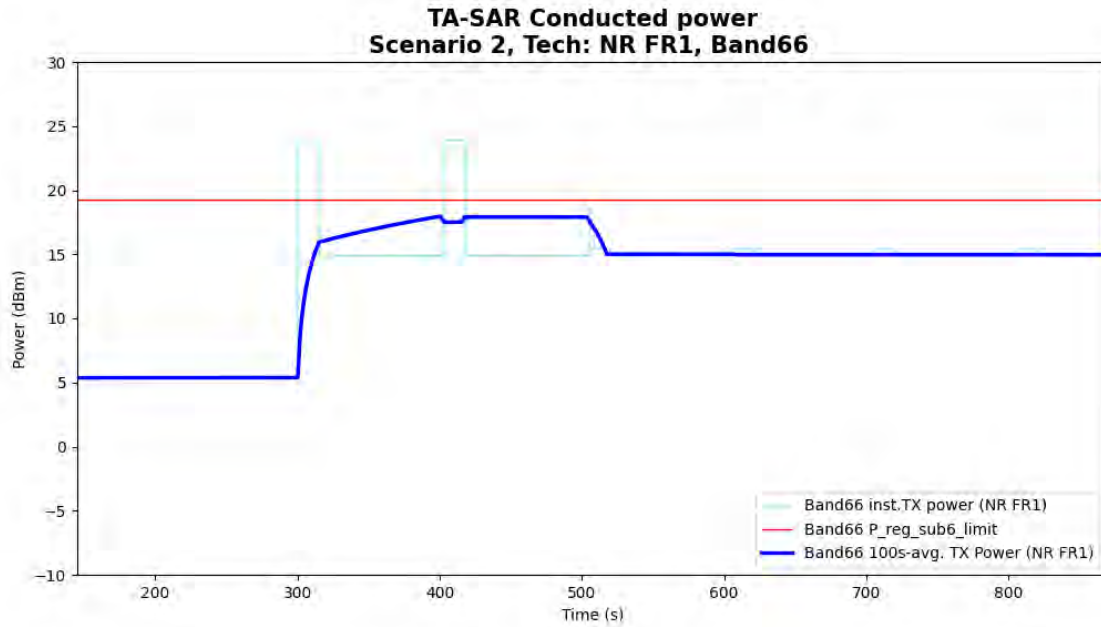

Figure 5- 10 Time-averaged conducted TX power over time for case 6 (sub6 NR n66)

Unless otherwise stated the results shown in this test report refer only to the sample(s) tested and such sample(s) are retained for 90 days only.

除非另有說明，此報告結果僅對測試之樣品負責，同時此樣品僅保留90天。本報告未經本公司書面許可，不可部份複製。

This document is issued by the Company subject to its General Conditions of Service printed overleaf, available on request or accessible at <http://www.sgs.com.tw/Terms-and-Conditions> and for electronic format documents, subject to Terms and Conditions for Electronic Documents at <http://www.sgs.com.tw/Terms-and-Conditions>. Attention is drawn to the limitation of liability, indemnification and jurisdiction issues defined therein. Any holder of this document is advised that information contained hereon reflects the Company's findings at the time of its intervention only and within the limits of Client's instructions, if any. The Company's sole responsibility is to its Client and this document does not exonerate parties to a transaction from exercising all their rights and obligations under the transaction documents. This document cannot be reproduced except in full, without prior written approval of the Company. Any unauthorized alteration, forgery or falsification of the content or appearance of this document is unlawful and offenders may be prosecuted to the fullest extent of the law.

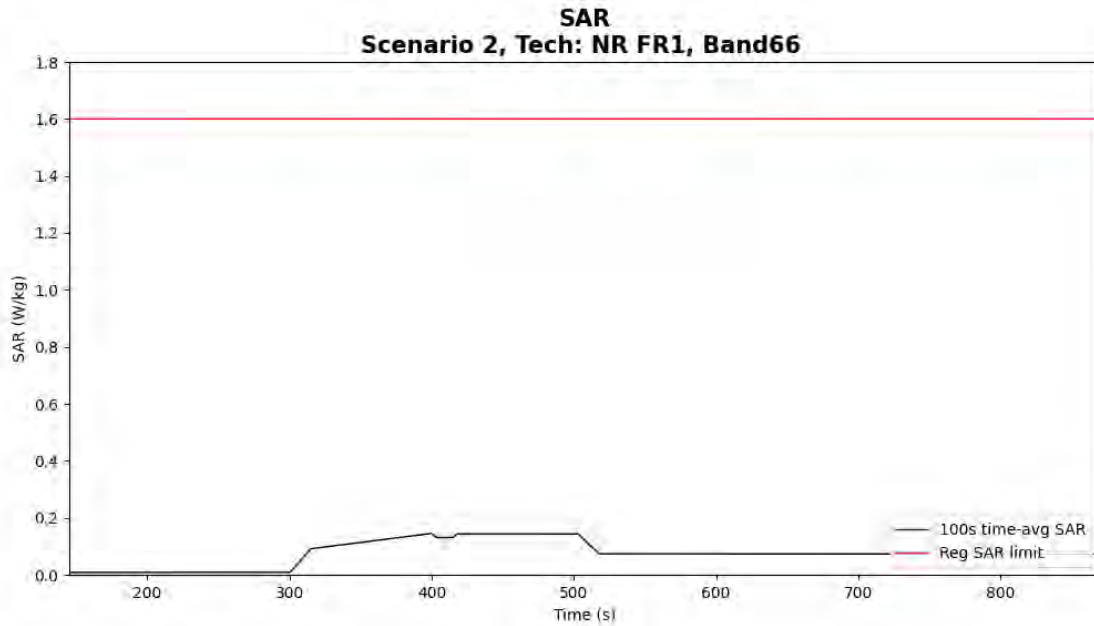

Figure 5- 11 Time-averaged SAR for case 6 (sub6 NR n66)

FCC 1gSAR limit	1.6 W/kg
Max 100s-time averaged 1gSAR	0.145 W/kg
Validation result: pass	

Unless otherwise stated the results shown in this test report refer only to the sample(s) tested and such sample(s) are retained for 90 days only.

除非另有說明，此報告結果僅對測試之樣品負責，同時此樣品僅保留90天。本報告未經本公司書面許可，不可部份複製。

This document is issued by the Company subject to its General Conditions of Service printed overleaf, available on request or accessible at <http://www.sgs.com.tw/Terms-and-Conditions> and for electronic format documents, subject to Terms and Conditions for Electronic Documents at <http://www.sgs.com.tw/Terms-and-Conditions>. Attention is drawn to the limitation of liability, indemnification and jurisdiction issues defined therein. Any holder of this document is advised that information contained hereon reflects the Company's findings at the time of its intervention only and within the limits of Client's instructions, if any. The Company's sole responsibility is to its Client and this document does not exonerate parties to a transaction from exercising all their rights and obligations under the transaction documents. This document cannot be reproduced except in full, without prior written approval of the Company. Any unauthorized alteration, forgery or falsification of the content or appearance of this document is unlawful and offenders may be prosecuted to the fullest extent of the law.

- Case 7 in table 5-4: NR n5 result for test sequence 1

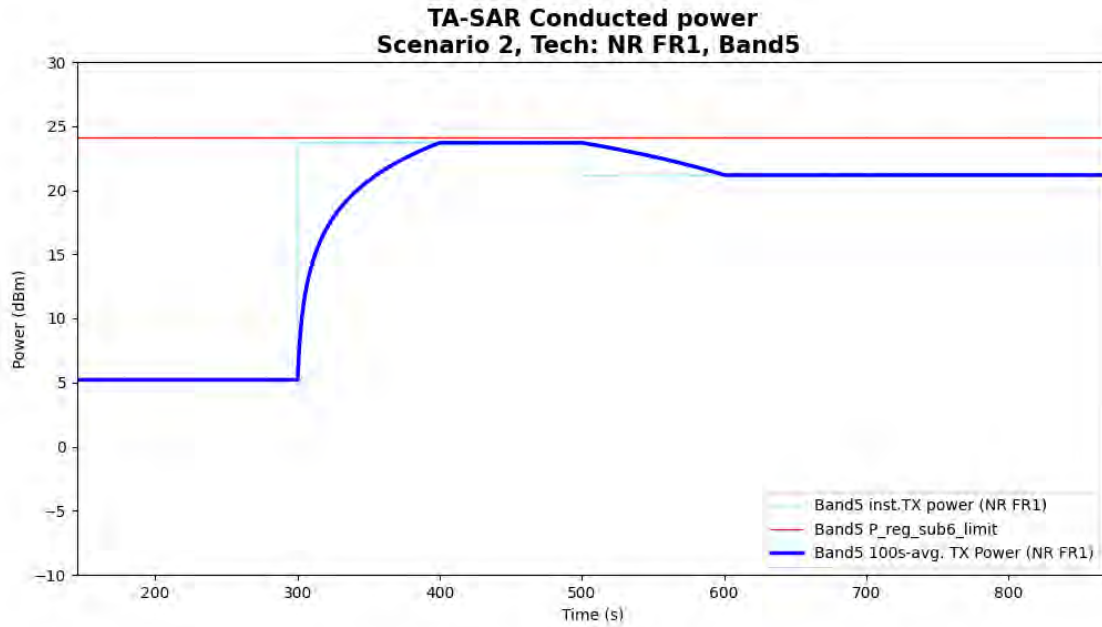

Figure 5- 12 Time-averaged conducted TX power over time for case 7 (sub6 NR n5)

Unless otherwise stated the results shown in this test report refer only to the sample(s) tested and such sample(s) are retained for 90 days only.

除非另有說明，此報告結果僅對測試之樣品負責，同時此樣品僅保留90天。本報告未經本公司書面許可，不可部份複製。

This document is issued by the Company subject to its General Conditions of Service printed overleaf, available on request or accessible at <http://www.sgs.com.tw/Terms-and-Conditions> and for electronic format documents, subject to Terms and Conditions for Electronic Documents at <http://www.sgs.com.tw/Terms-and-Conditions>. Attention is drawn to the limitation of liability, indemnification and jurisdiction issues defined therein. Any holder of this document is advised that information contained hereon reflects the Company's findings at the time of its intervention only and within the limits of Client's instructions, if any. The Company's sole responsibility is to its Client and this document does not exonerate parties to a transaction from exercising all their rights and obligations under the transaction documents. This document cannot be reproduced except in full, without prior written approval of the Company. Any unauthorized alteration, forgery or falsification of the content or appearance of this document is unlawful and offenders may be prosecuted to the fullest extent of the law.

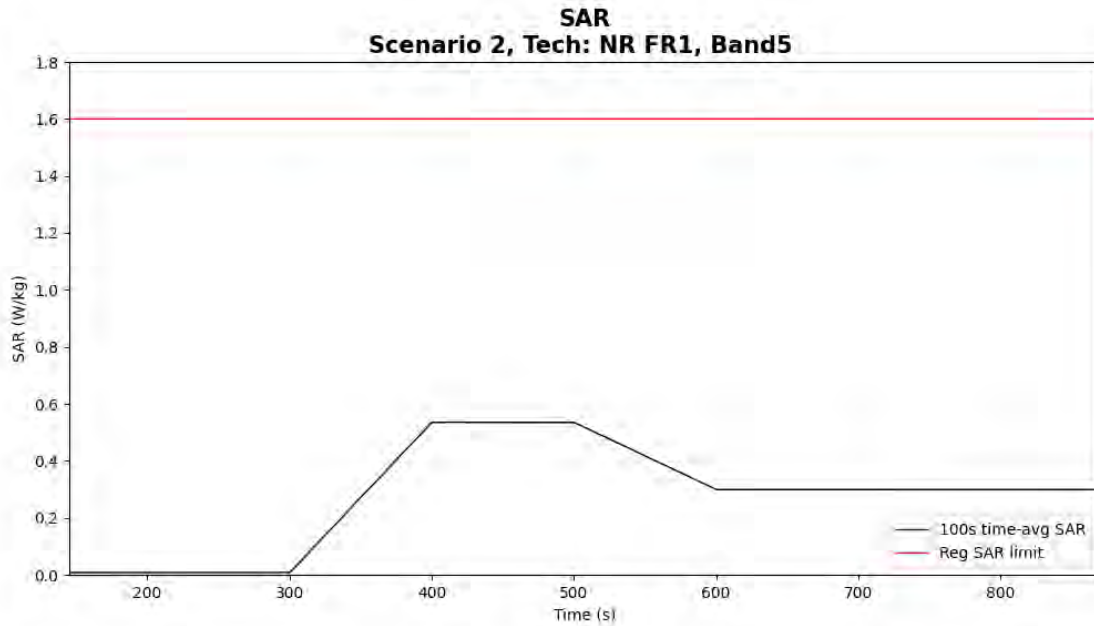

Figure 5- 13 Time-averaged SAR for case 7 (sub6 NR n5)

FCC 1gSAR limit	1.6 W/kg
Max 100s-time averaged 1gSAR	0.535 W/kg
Validation result:	pass

Unless otherwise stated the results shown in this test report refer only to the sample(s) tested and such sample(s) are retained for 90 days only.

除非另有說明，此報告結果僅對測試之樣品負責，同時此樣品僅保留90天。本報告未經本公司書面許可，不可部份複製。

This document is issued by the Company subject to its General Conditions of Service printed overleaf, available on request or accessible at <http://www.sgs.com.tw/Terms-and-Conditions> and for electronic format documents, subject to Terms and Conditions for Electronic Documents at <http://www.sgs.com.tw/Terms-and-Conditions>. Attention is drawn to the limitation of liability, indemnification and jurisdiction issues defined therein. Any holder of this document is advised that information contained hereon reflects the Company's findings at the time of its intervention only and within the limits of Client's instructions, if any. The Company's sole responsibility is to its Client and this document does not exonerate parties to a transaction from exercising all their rights and obligations under the transaction documents. This document cannot be reproduced except in full, without prior written approval of the Company. Any unauthorized alteration, forgery or falsification of the content or appearance of this document is unlawful and offenders may be prosecuted to the fullest extent of the law.

•Case 13 in table 5-4: NR n66 result for test sequence 2

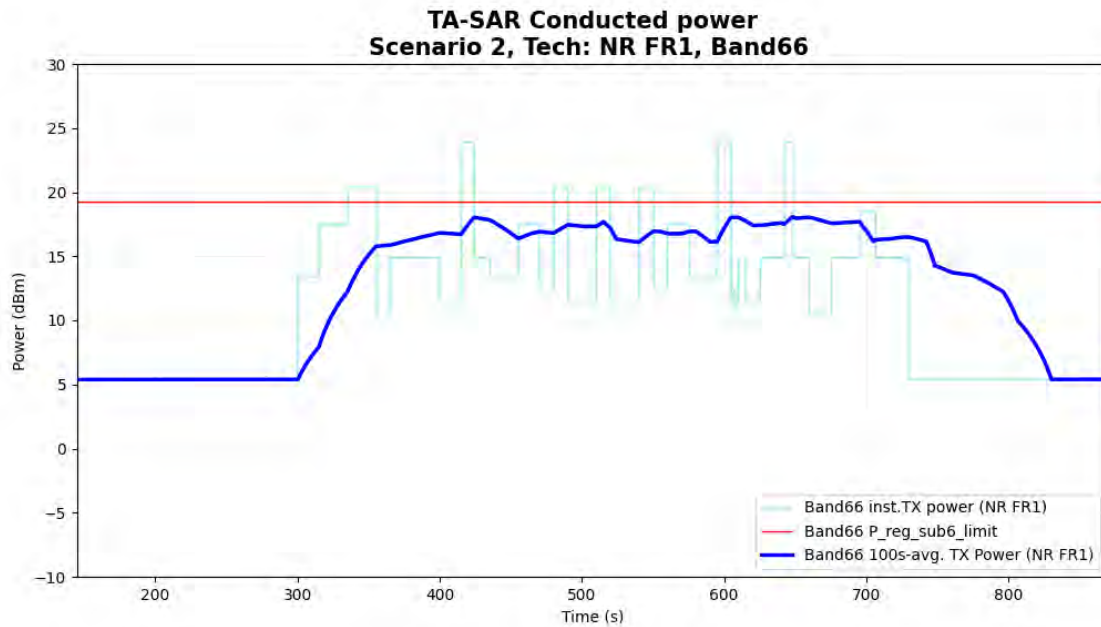

Figure 5- 14 Time-averaged conducted TX power over time for case 13 (sub6 NR n66)

Unless otherwise stated the results shown in this test report refer only to the sample(s) tested and such sample(s) are retained for 90 days only.

除非另有說明，此報告結果僅對測試之樣品負責，同時此樣品僅保留90天。本報告未經本公司書面許可，不可部份複製。

This document is issued by the Company subject to its General Conditions of Service printed overleaf, available on request or accessible at <http://www.sgs.com.tw/Terms-and-Conditions> and for electronic format documents, subject to Terms and Conditions for Electronic Documents at <http://www.sgs.com.tw/Terms-and-Conditions>. Attention is drawn to the limitation of liability, indemnification and jurisdiction issues defined therein. Any holder of this document is advised that information contained hereon reflects the Company's findings at the time of its intervention only and within the limits of Client's instructions, if any. The Company's sole responsibility is to its Client and this document does not exonerate parties to a transaction from exercising all their rights and obligations under the transaction documents. This document cannot be reproduced except in full, without prior written approval of the Company. Any unauthorized alteration, forgery or falsification of the content or appearance of this document is unlawful and offenders may be prosecuted to the fullest extent of the law.

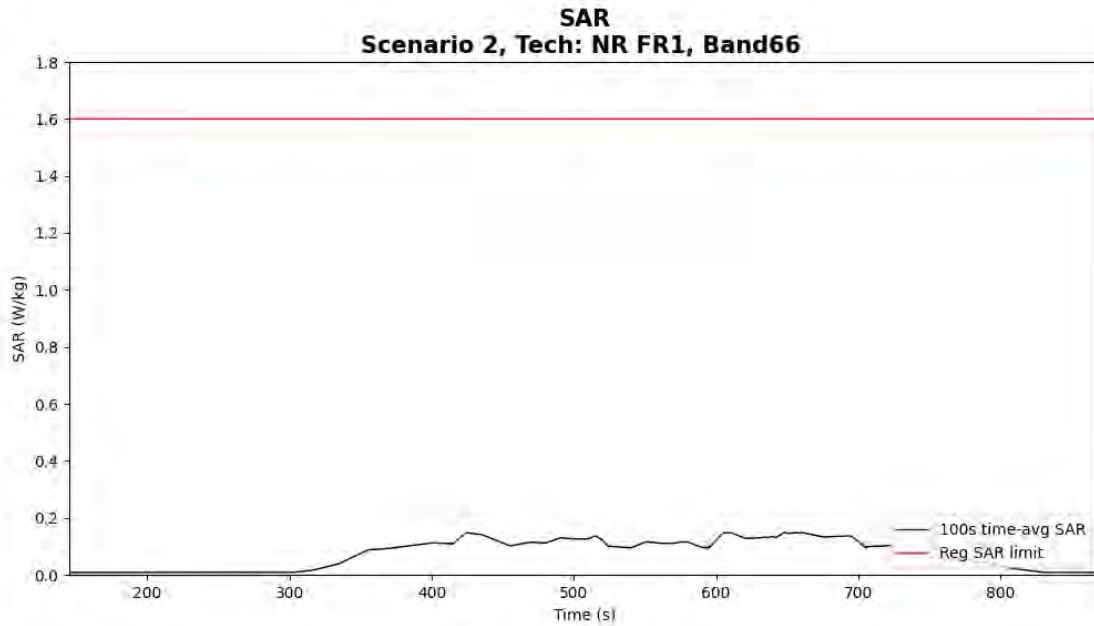

Figure 5- 15 Time-averaged SAR for case 13 (sub6 NR n66)

FCC 1gSAR limit	1.6 W/kg
Max 100s-time averaged 1gSAR	0.149 W/kg
Validation result: pass	

Unless otherwise stated the results shown in this test report refer only to the sample(s) tested and such sample(s) are retained for 90 days only.

除非另有說明，此報告結果僅對測試之樣品負責，同時此樣品僅保留90天。本報告未經本公司書面許可，不可部份複製。

This document is issued by the Company subject to its General Conditions of Service printed overleaf, available on request or accessible at <http://www.sgs.com.tw/Terms-and-Conditions> and for electronic format documents, subject to Terms and Conditions for Electronic Documents at <http://www.sgs.com.tw/Terms-and-Conditions>. Attention is drawn to the limitation of liability, indemnification and jurisdiction issues defined therein. Any holder of this document is advised that information contained hereon reflects the Company's findings at the time of its intervention only and within the limits of Client's instructions, if any. The Company's sole responsibility is to its Client and this document does not exonerate parties to a transaction from exercising all their rights and obligations under the transaction documents. This document cannot be reproduced except in full, without prior written approval of the Company. Any unauthorized alteration, forgery or falsification of the content or appearance of this document is unlawful and offenders may be prosecuted to the fullest extent of the law.

- Case 14 in table 5-4: NR n5 result for test sequence 2

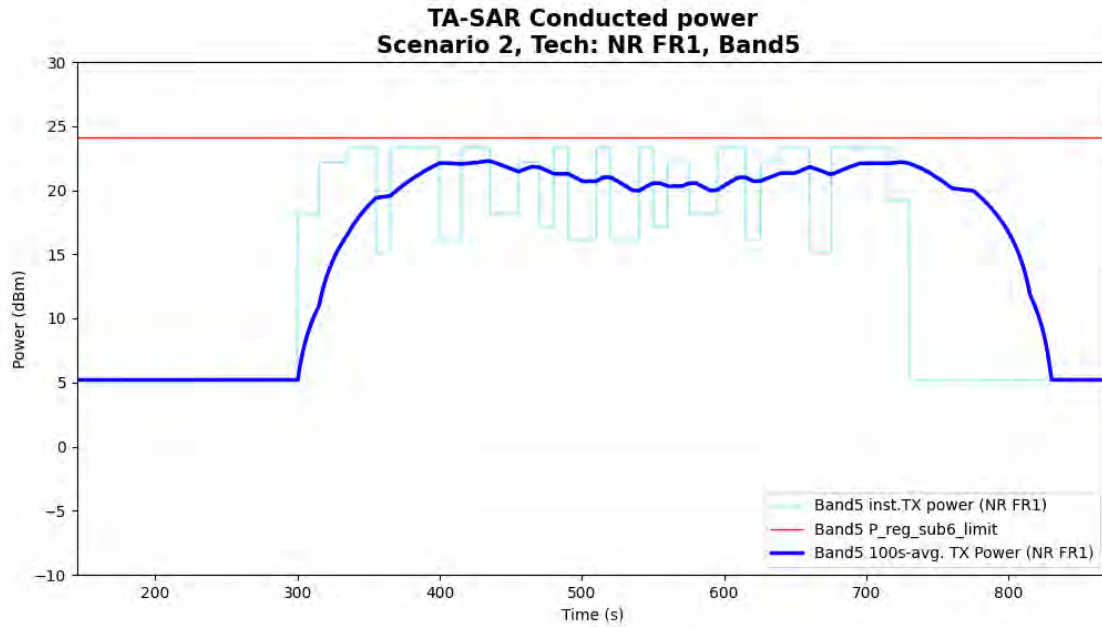

Figure 5- 16 Time-averaged conducted TX power over time for case 14 (sub6 NR n5)

Unless otherwise stated the results shown in this test report refer only to the sample(s) tested and such sample(s) are retained for 90 days only.

除非另有說明，此報告結果僅對測試之樣品負責，同時此樣品僅保留90天。本報告未經本公司書面許可，不可部份複製。

This document is issued by the Company subject to its General Conditions of Service printed overleaf, available on request or accessible at <http://www.sgs.com.tw/Terms-and-Conditions> and for electronic format documents, subject to Terms and Conditions for Electronic Documents at <http://www.sgs.com.tw/Terms-and-Conditions>. Attention is drawn to the limitation of liability, indemnification and jurisdiction issues defined therein. Any holder of this document is advised that information contained hereon reflects the Company's findings at the time of its intervention only and within the limits of Client's instructions, if any. The Company's sole responsibility is to its Client and this document does not exonerate parties to a transaction from exercising all their rights and obligations under the transaction documents. This document cannot be reproduced except in full, without prior written approval of the Company. Any unauthorized alteration, forgery or falsification of the content or appearance of this document is unlawful and offenders may be prosecuted to the fullest extent of the law.

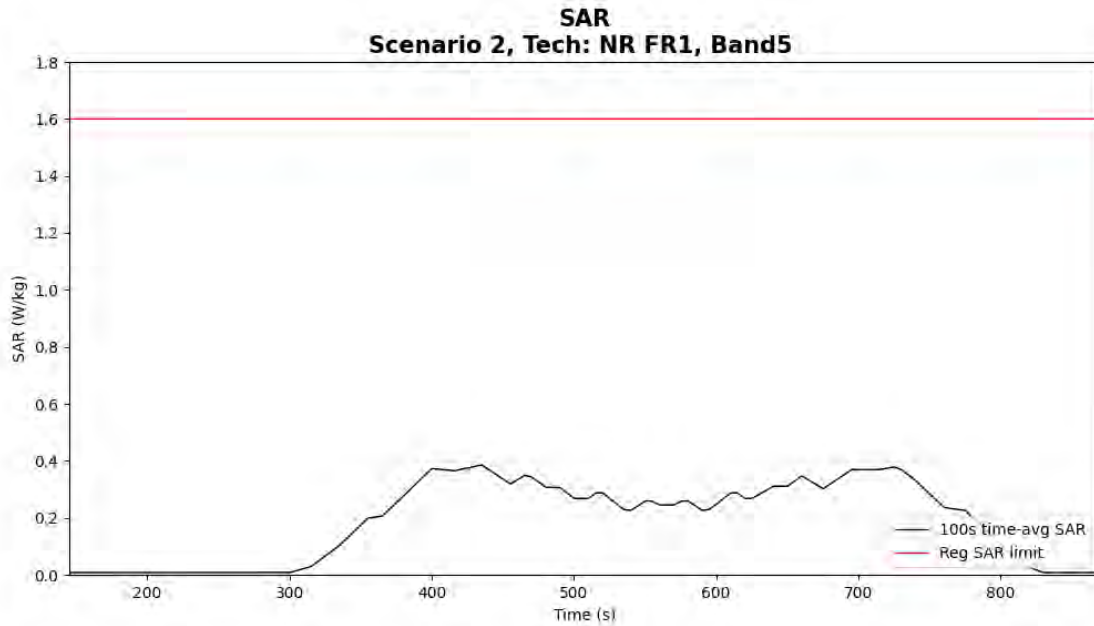

Figure 5- 17 Time-averaged SAR for case 14 (sub6 NR n5)

FCC 1gSAR limit	1.6 W/kg
Max 100s-time averaged 1gSAR	0.386 W/kg
Validation result: pass	

Unless otherwise stated the results shown in this test report refer only to the sample(s) tested and such sample(s) are retained for 90 days only.

除非另有說明，此報告結果僅對測試之樣品負責，同時此樣品僅保留90天。本報告未經本公司書面許可，不可部份複製。

This document is issued by the Company subject to its General Conditions of Service printed overleaf, available on request or accessible at <http://www.sgs.com.tw/Terms-and-Conditions> and for electronic format documents, subject to Terms and Conditions for Electronic Documents at <http://www.sgs.com.tw/Terms-and-Conditions>. Attention is drawn to the limitation of liability, indemnification and jurisdiction issues defined therein. Any holder of this document is advised that information contained hereon reflects the Company's findings at the time of its intervention only and within the limits of Client's instructions, if any. The Company's sole responsibility is to its Client and this document does not exonerate parties to a transaction from exercising all their rights and obligations under the transaction documents. This document cannot be reproduced except in full, without prior written approval of the Company. Any unauthorized alteration, forgery or falsification of the content or appearance of this document is unlawful and offenders may be prosecuted to the fullest extent of the law.

5.3.2 Measurement results for LTE

These test cases are for 4G LTE and are conducted under LTE bands B2 and B66 with ECI = 2. The corresponding detailed test procedure is described in 4.3.2. For the figure set of each case, the first figure demonstrates the EUT's instantaneous conducted TX power, the time-averaged conducted TX power behavior over time, and the power limit ($P_{reg_sub6_limit} = P_{sub6_limit} + 1\text{dB}$ device uncertainty). The second figure illustrates the corresponding time-averaged SAR over time converted from the TX time-averaged power by using the equation listed in section 4.3.2. For all test cases, the time-averaged SAR does not exceed the FCC limit.

Unless otherwise stated the results shown in this test report refer only to the sample(s) tested and such sample(s) are retained for 90 days only.

除非另有說明，此報告結果僅對測試之樣品負責，同時此樣品僅保留90天。本報告未經本公司書面許可，不可部份複製。

This document is issued by the Company subject to its General Conditions of Service printed overleaf, available on request or accessible at <http://www.sgs.com.tw/Terms-and-Conditions> and for electronic format documents, subject to Terms and Conditions for Electronic Documents at <http://www.sgs.com.tw/Terms-and-Conditions>. Attention is drawn to the limitation of liability, indemnification and jurisdiction issues defined therein. Any holder of this document is advised that information contained hereon reflects the Company's findings at the time of its intervention only and within the limits of Client's instructions, if any. The Company's sole responsibility is to its Client and this document does not exonerate parties to a transaction from exercising all their rights and obligations under the transaction documents. This document cannot be reproduced except in full, without prior written approval of the Company. Any unauthorized alteration, forgery or falsification of the content or appearance of this document is unlawful and offenders may be prosecuted to the fullest extent of the law.

- Case 4 in table 5-4: LTE B2 result for test sequence 1

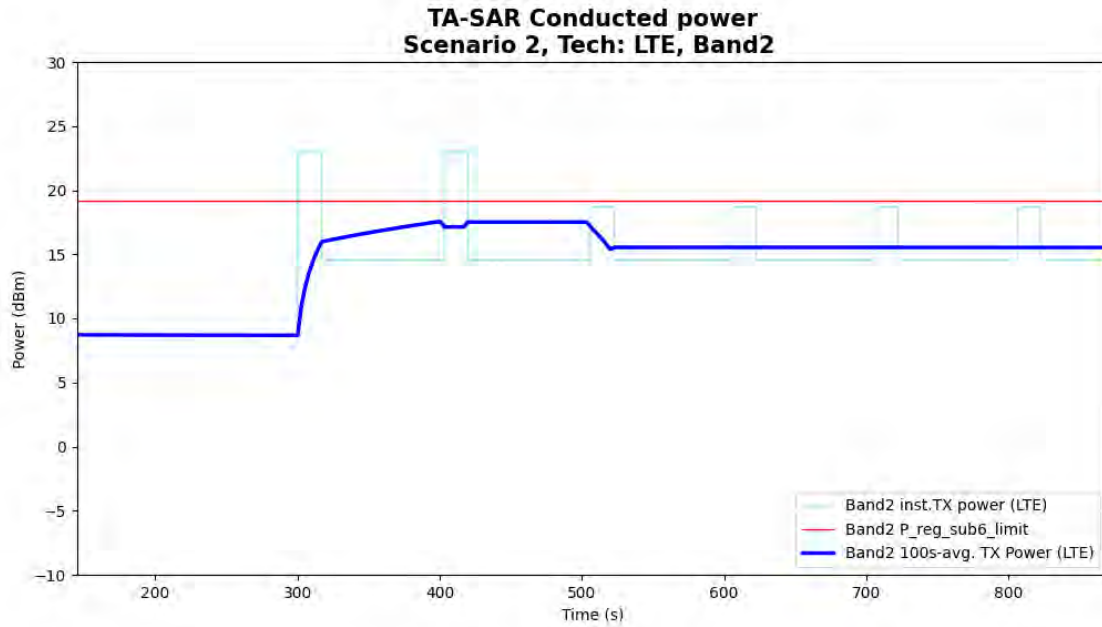

Figure 5- 18 Time-averaged conducted TX power over time for case 4 (LTE B2)

Unless otherwise stated the results shown in this test report refer only to the sample(s) tested and such sample(s) are retained for 90 days only.

除非另有說明，此報告結果僅對測試之樣品負責，同時此樣品僅保留90天。本報告未經本公司書面許可，不可部份複製。

This document is issued by the Company subject to its General Conditions of Service printed overleaf, available on request or accessible at <http://www.sgs.com.tw/Terms-and-Conditions> and for electronic format documents, subject to Terms and Conditions for Electronic Documents at <http://www.sgs.com.tw/Terms-and-Conditions>. Attention is drawn to the limitation of liability, indemnification and jurisdiction issues defined therein. Any holder of this document is advised that information contained hereon reflects the Company's findings at the time of its intervention only and within the limits of Client's instructions, if any. The Company's sole responsibility is to its Client and this document does not exonerate parties to a transaction from exercising all their rights and obligations under the transaction documents. This document cannot be reproduced except in full, without prior written approval of the Company. Any unauthorized alteration, forgery or falsification of the content or appearance of this document is unlawful and offenders may be prosecuted to the fullest extent of the law.

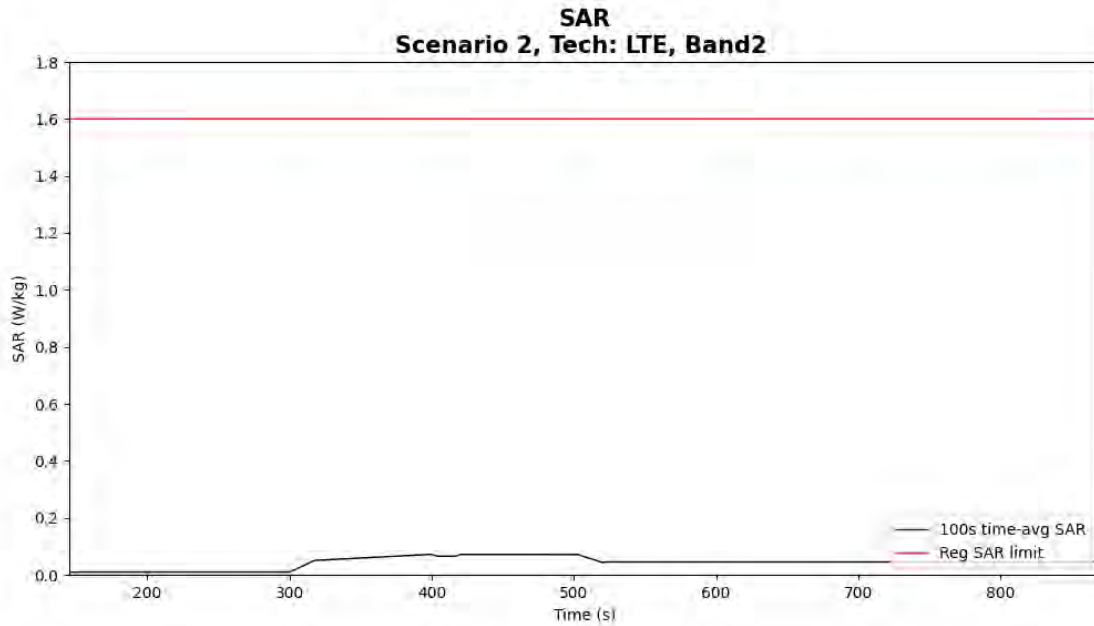

Figure 5- 19 Time-averaged SAR for case 4 (LTE B2)

FCC 1gSAR limit	1.6 W/kg
Max 100s-time averaged 1gSAR	0.0719 W/kg
Validation result: pass	

Unless otherwise stated the results shown in this test report refer only to the sample(s) tested and such sample(s) are retained for 90 days only.

除非另有說明，此報告結果僅對測試之樣品負責，同時此樣品僅保留90天。本報告未經本公司書面許可，不可部份複製。

This document is issued by the Company subject to its General Conditions of Service printed overleaf, available on request or accessible at <http://www.sgs.com.tw/Terms-and-Conditions> and for electronic format documents, subject to Terms and Conditions for Electronic Documents at <http://www.sgs.com.tw/Terms-and-Conditions>. Attention is drawn to the limitation of liability, indemnification and jurisdiction issues defined therein. Any holder of this document is advised that information contained hereon reflects the Company's findings at the time of its intervention only and within the limits of Client's instructions, if any. The Company's sole responsibility is to its Client and this document does not exonerate parties to a transaction from exercising all their rights and obligations under the transaction documents. This document cannot be reproduced except in full, without prior written approval of the Company. Any unauthorized alteration, forgery or falsification of the content or appearance of this document is unlawful and offenders may be prosecuted to the fullest extent of the law.

- Case 5 in table 5-4: LTE B66 result for test sequence 1

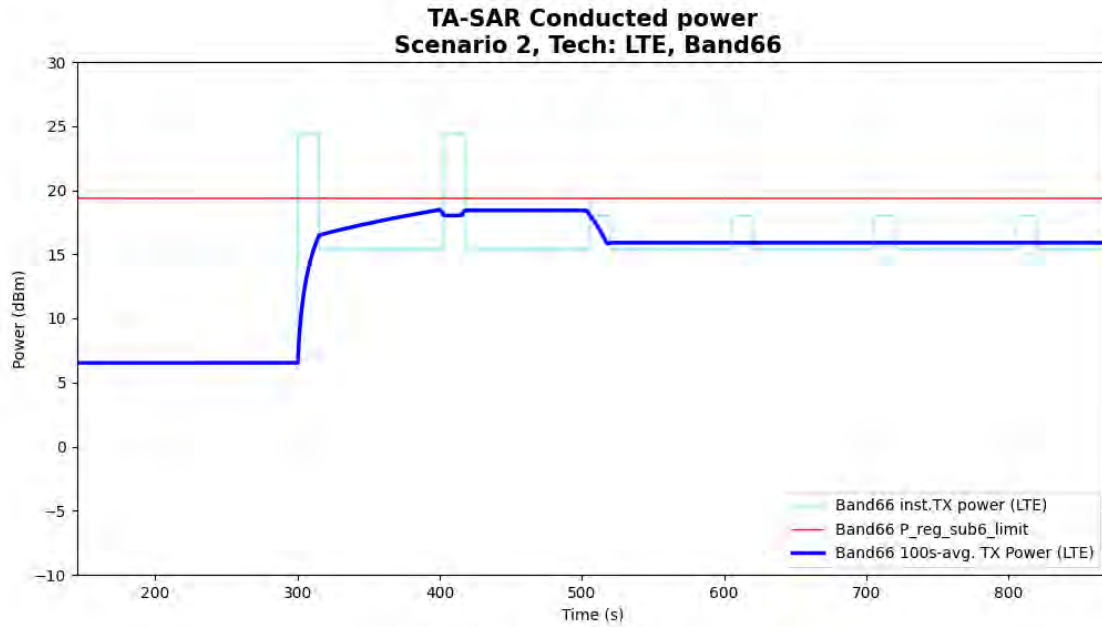

Figure 5- 20 Time-averaged conducted TX power over time for case 5 (LTE B66)

Unless otherwise stated the results shown in this test report refer only to the sample(s) tested and such sample(s) are retained for 90 days only.

除非另有說明，此報告結果僅對測試之樣品負責，同時此樣品僅保留90天。本報告未經本公司書面許可，不可部份複製。

This document is issued by the Company subject to its General Conditions of Service printed overleaf, available on request or accessible at <http://www.sgs.com.tw/Terms-and-Conditions> and for electronic format documents, subject to Terms and Conditions for Electronic Documents at <http://www.sgs.com.tw/Terms-and-Conditions>. Attention is drawn to the limitation of liability, indemnification and jurisdiction issues defined therein. Any holder of this document is advised that information contained hereon reflects the Company's findings at the time of its intervention only and within the limits of Client's instructions, if any. The Company's sole responsibility is to its Client and this document does not exonerate parties to a transaction from exercising all their rights and obligations under the transaction documents. This document cannot be reproduced except in full, without prior written approval of the Company. Any unauthorized alteration, forgery or falsification of the content or appearance of this document is unlawful and offenders may be prosecuted to the fullest extent of the law.

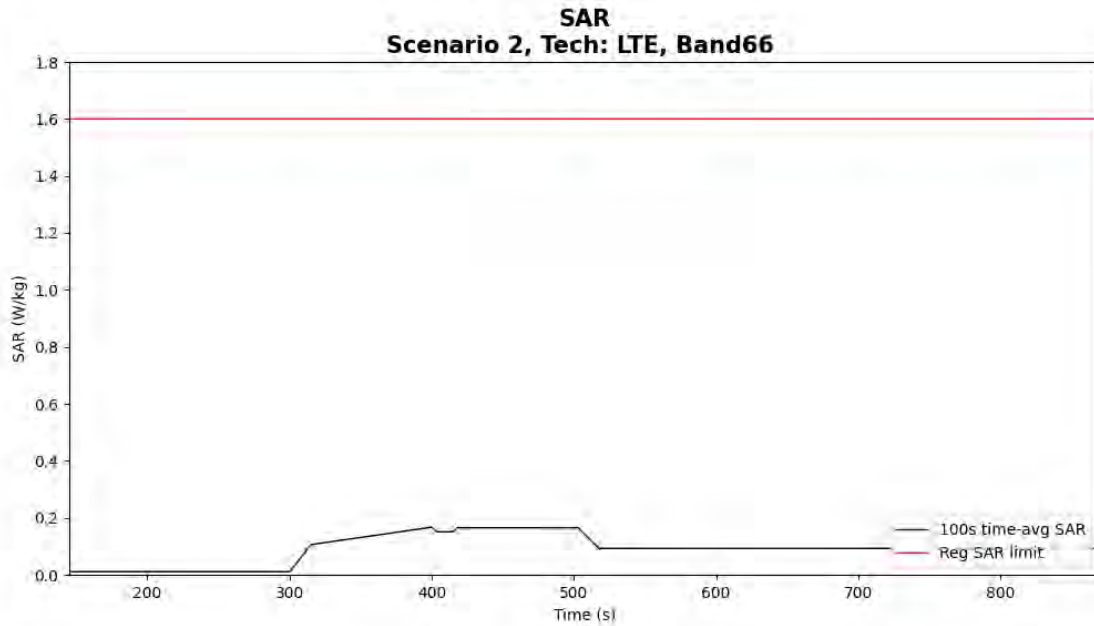

Figure 5- 21 Time-averaged SAR for case 5 (LTE B66)

FCC 1gSAR limit	1.6 W/kg
Max 100s-time averaged 1gSAR	0.167 W/kg
Validation result:	pass

Unless otherwise stated the results shown in this test report refer only to the sample(s) tested and such sample(s) are retained for 90 days only.

除非另有說明，此報告結果僅對測試之樣品負責，同時此樣品僅保留90天。本報告未經本公司書面許可，不可部份複製。

This document is issued by the Company subject to its General Conditions of Service printed overleaf, available on request or accessible at <http://www.sgs.com.tw/Terms-and-Conditions> and for electronic format documents, subject to Terms and Conditions for Electronic Documents at <http://www.sgs.com.tw/Terms-and-Conditions>. Attention is drawn to the limitation of liability, indemnification and jurisdiction issues defined therein. Any holder of this document is advised that information contained hereon reflects the Company's findings at the time of its intervention only and within the limits of Client's instructions, if any. The Company's sole responsibility is to its Client and this document does not exonerate parties to a transaction from exercising all their rights and obligations under the transaction documents. This document cannot be reproduced except in full, without prior written approval of the Company. Any unauthorized alteration, forgery or falsification of the content or appearance of this document is unlawful and offenders may be prosecuted to the fullest extent of the law.

•Case 11 in table 5-4: LTE B2 result for test sequence 2

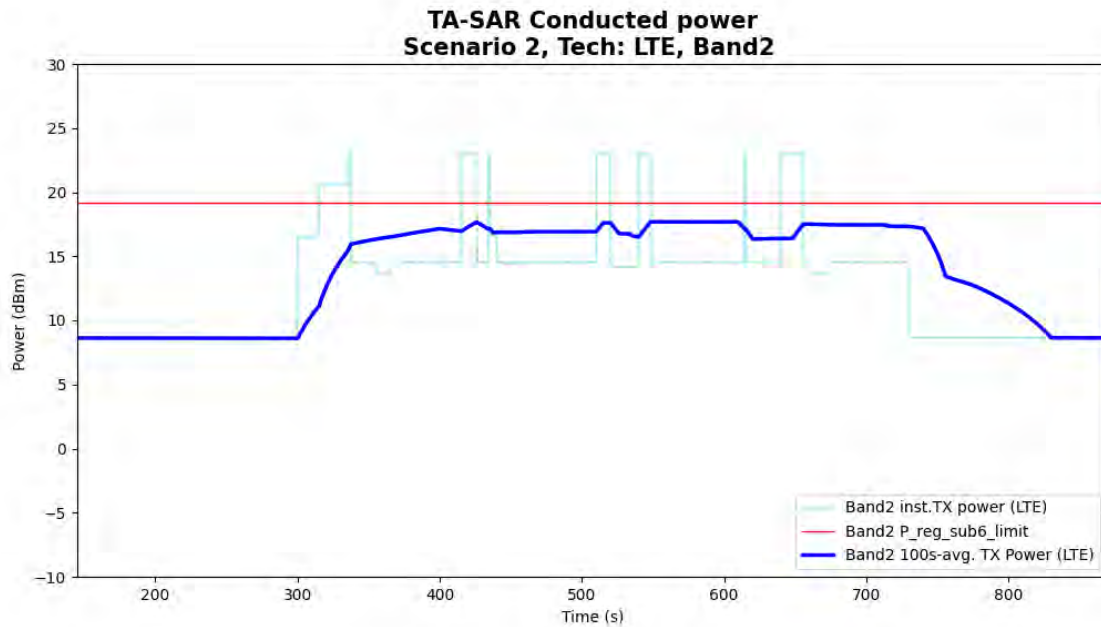

Figure 5- 22 Time-averaged conducted TX power over time for case 11 (LTE B2)

Unless otherwise stated the results shown in this test report refer only to the sample(s) tested and such sample(s) are retained for 90 days only.

除非另有說明，此報告結果僅對測試之樣品負責，同時此樣品僅保留90天。本報告未經本公司書面許可，不可部份複製。

This document is issued by the Company subject to its General Conditions of Service printed overleaf, available on request or accessible at <http://www.sgs.com.tw/Terms-and-Conditions> and for electronic format documents, subject to Terms and Conditions for Electronic Documents at <http://www.sgs.com.tw/Terms-and-Conditions>. Attention is drawn to the limitation of liability, indemnification and jurisdiction issues defined therein. Any holder of this document is advised that information contained hereon reflects the Company's findings at the time of its intervention only and within the limits of Client's instructions, if any. The Company's sole responsibility is to its Client and this document does not exonerate parties to a transaction from exercising all their rights and obligations under the transaction documents. This document cannot be reproduced except in full, without prior written approval of the Company. Any unauthorized alteration, forgery or falsification of the content or appearance of this document is unlawful and offenders may be prosecuted to the fullest extent of the law.

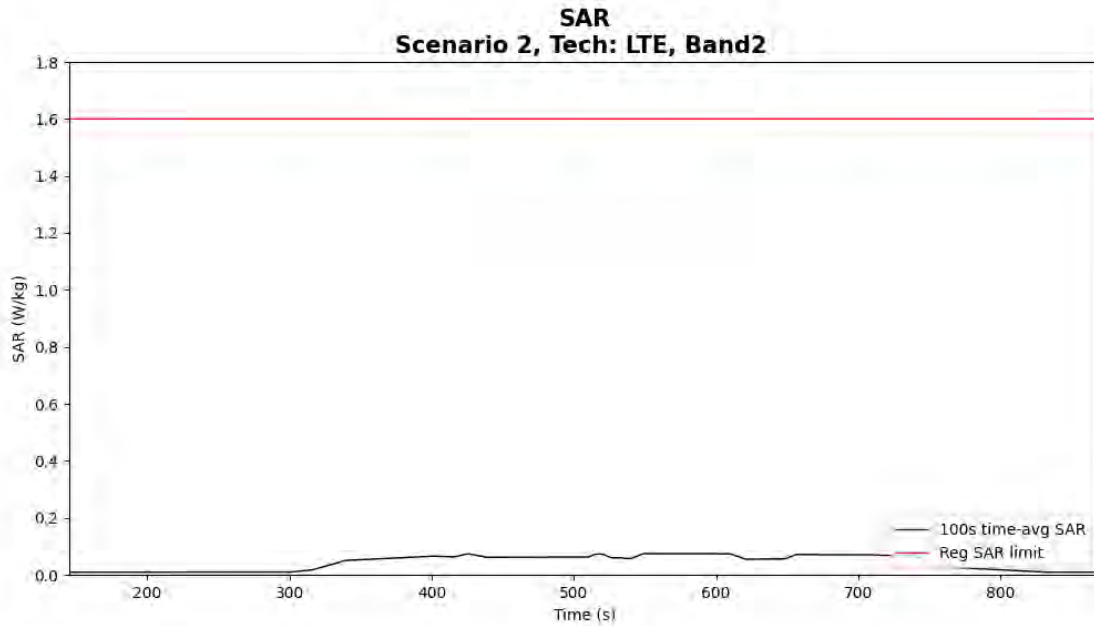

Figure 5- 23 Time-averaged SAR for case 11 (LTE B2)

FCC 1gSAR limit	1.6 W/kg
Max 100s-time averaged 1gSAR	0.074 W/kg
Validation result: pass	

Unless otherwise stated the results shown in this test report refer only to the sample(s) tested and such sample(s) are retained for 90 days only.

除非另有說明，此報告結果僅對測試之樣品負責，同時此樣品僅保留90天。本報告未經本公司書面許可，不可部份複製。

This document is issued by the Company subject to its General Conditions of Service printed overleaf, available on request or accessible at <http://www.sgs.com.tw/Terms-and-Conditions> and for electronic format documents, subject to Terms and Conditions for Electronic Documents at <http://www.sgs.com.tw/Terms-and-Conditions>. Attention is drawn to the limitation of liability, indemnification and jurisdiction issues defined therein. Any holder of this document is advised that information contained hereon reflects the Company's findings at the time of its intervention only and within the limits of Client's instructions, if any. The Company's sole responsibility is to its Client and this document does not exonerate parties to a transaction from exercising all their rights and obligations under the transaction documents. This document cannot be reproduced except in full, without prior written approval of the Company. Any unauthorized alteration, forgery or falsification of the content or appearance of this document is unlawful and offenders may be prosecuted to the fullest extent of the law.

- Case 12 in table 5-4: LTE B66 result for test sequence 2

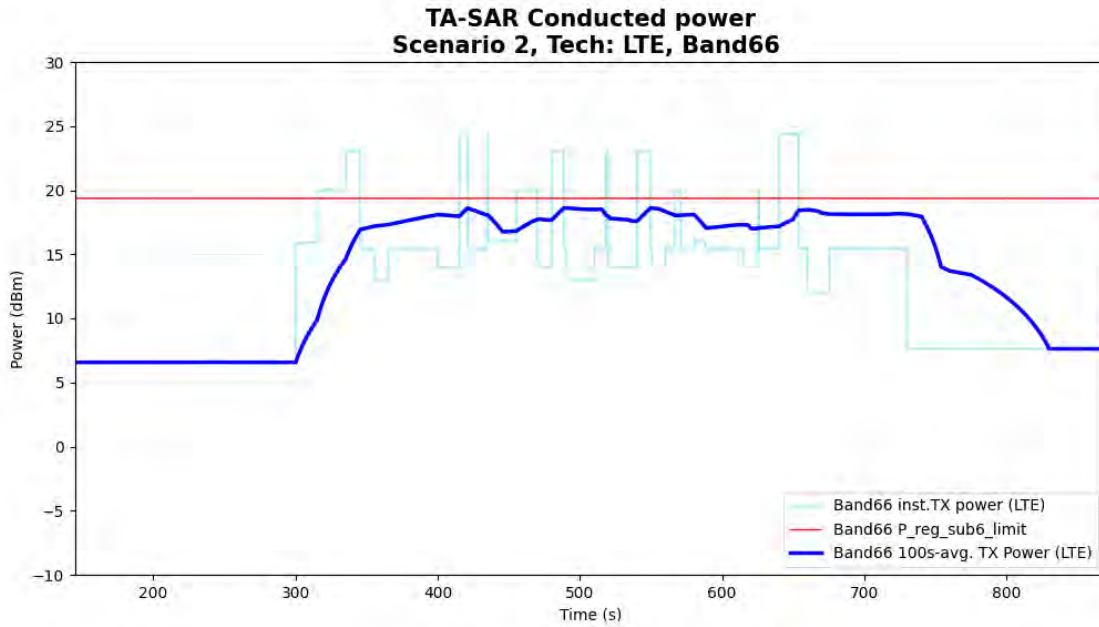

Figure 5- 24 Time-averaged conducted TX power over time for case 12 (LTE B66)

Unless otherwise stated the results shown in this test report refer only to the sample(s) tested and such sample(s) are retained for 90 days only.

除非另有說明，此報告結果僅對測試之樣品負責，同時此樣品僅保留90天。本報告未經本公司書面許可，不可部份複製。

This document is issued by the Company subject to its General Conditions of Service printed overleaf, available on request or accessible at <http://www.sgs.com.tw/Terms-and-Conditions> and for electronic format documents, subject to Terms and Conditions for Electronic Documents at <http://www.sgs.com.tw/Terms-and-Conditions>. Attention is drawn to the limitation of liability, indemnification and jurisdiction issues defined therein. Any holder of this document is advised that information contained hereon reflects the Company's findings at the time of its intervention only and within the limits of Client's instructions, if any. The Company's sole responsibility is to its Client and this document does not exonerate parties to a transaction from exercising all their rights and obligations under the transaction documents. This document cannot be reproduced except in full, without prior written approval of the Company. Any unauthorized alteration, forgery or falsification of the content or appearance of this document is unlawful and offenders may be prosecuted to the fullest extent of the law.

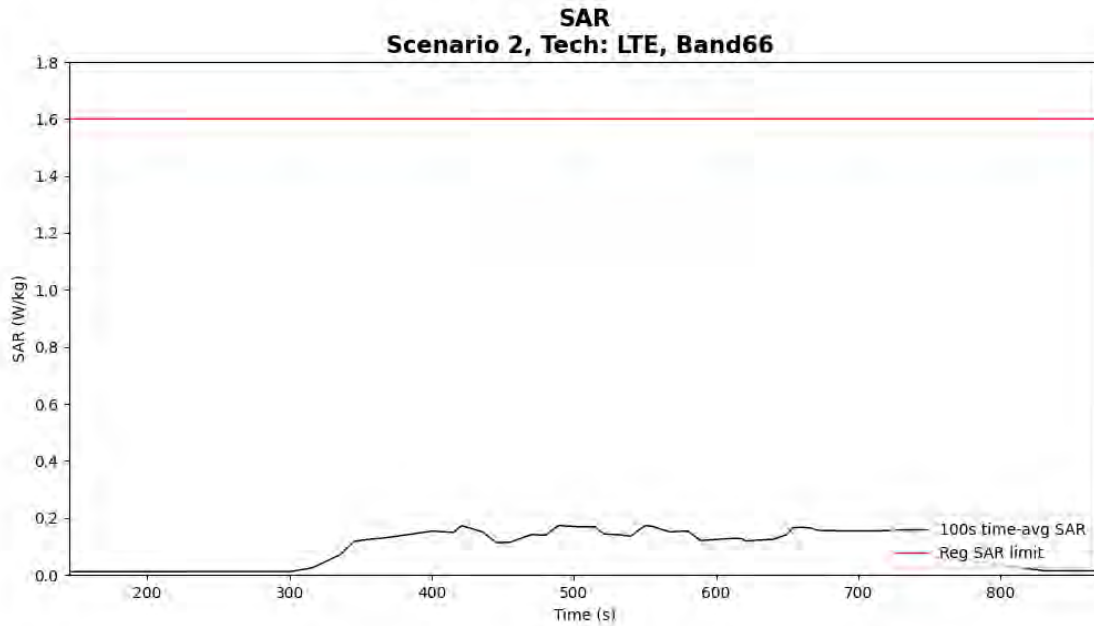

Figure 5- 25 Time-averaged SAR for case 12 (LTE B66)

FCC 1gSAR limit	1.6 W/kg
Max 100s-time averaged 1gSAR	0.173W/kg
Validation result: pass	

Unless otherwise stated the results shown in this test report refer only to the sample(s) tested and such sample(s) are retained for 90 days only.

除非另有說明，此報告結果僅對測試之樣品負責，同時此樣品僅保留90天。本報告未經本公司書面許可，不可部份複製。

This document is issued by the Company subject to its General Conditions of Service printed overleaf, available on request or accessible at <http://www.sgs.com.tw/Terms-and-Conditions> and for electronic format documents, subject to Terms and Conditions for Electronic Documents at <http://www.sgs.com.tw/Terms-and-Conditions>. Attention is drawn to the limitation of liability, indemnification and jurisdiction issues defined therein. Any holder of this document is advised that information contained hereon reflects the Company's findings at the time of its intervention only and within the limits of Client's instructions, if any. The Company's sole responsibility is to its Client and this document does not exonerate parties to a transaction from exercising all their rights and obligations under the transaction documents. This document cannot be reproduced except in full, without prior written approval of the Company. Any unauthorized alteration, forgery or falsification of the content or appearance of this document is unlawful and offenders may be prosecuted to the fullest extent of the law.

5.3.3 Measurement results for WCDMA

These test cases are for 3G WCDMA and are conducted under WCDMA bands B4 and B2 with ECI = 2. The corresponding detailed test procedure is described in 4.3.2. For the figure set of each case, the first figure demonstrates the EUT's instantaneous conducted TX power, the time-averaged conducted TX power behavior over time, and the power limit ($P_{reg_sub6_limit} = P_{sub6_limit} + 1\text{dB device uncertainty}$). The second figure illustrates the corresponding time-averaged SAR over time converted from the TX time-averaged power by using the equation listed in section 4.3.2. For all test cases, the time-averaged SAR does not exceed the FCC limit.

Unless otherwise stated the results shown in this test report refer only to the sample(s) tested and such sample(s) are retained for 90 days only.

除非另有說明，此報告結果僅對測試之樣品負責，同時此樣品僅保留90天。本報告未經本公司書面許可，不可部份複製。

This document is issued by the Company subject to its General Conditions of Service printed overleaf, available on request or accessible at <http://www.sgs.com.tw/Terms-and-Conditions> and for electronic format documents, subject to Terms and Conditions for Electronic Documents at <http://www.sgs.com.tw/Terms-and-Conditions>. Attention is drawn to the limitation of liability, indemnification and jurisdiction issues defined therein. Any holder of this document is advised that information contained hereon reflects the Company's findings at the time of its intervention only and within the limits of Client's instructions, if any. The Company's sole responsibility is to its Client and this document does not exonerate parties to a transaction from exercising all their rights and obligations under the transaction documents. This document cannot be reproduced except in full, without prior written approval of the Company. Any unauthorized alteration, forgery or falsification of the content or appearance of this document is unlawful and offenders may be prosecuted to the fullest extent of the law.

- Case 2 in table 5-4: WCDMA B2 result for test sequence 1

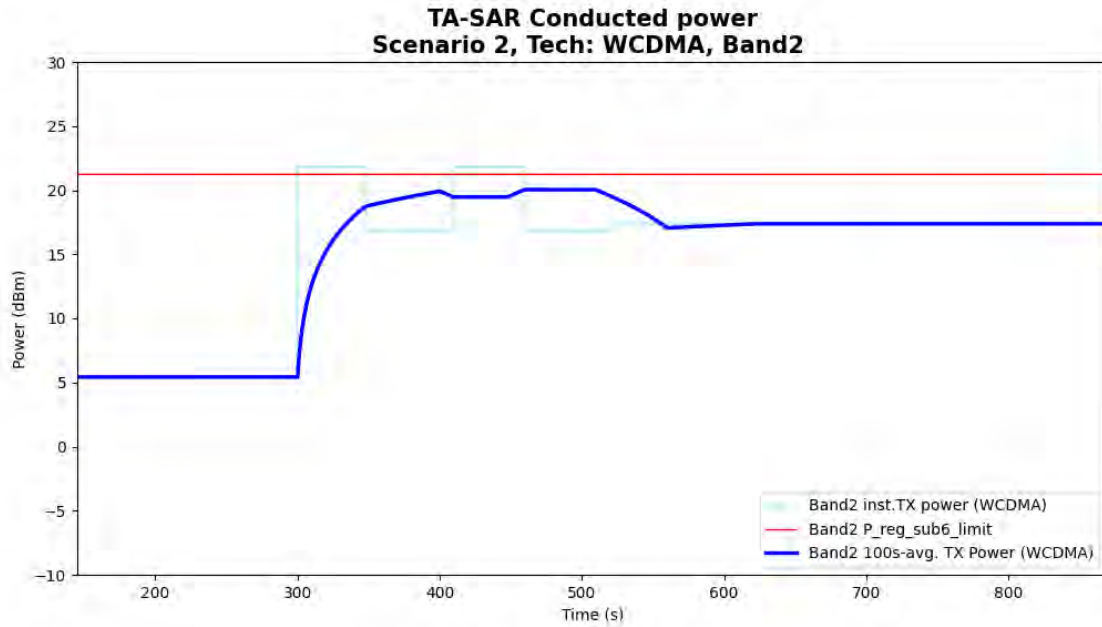

Figure 5- 26 Time-averaged conducted TX power over time for case 2 (WCDMA B2)

Unless otherwise stated the results shown in this test report refer only to the sample(s) tested and such sample(s) are retained for 90 days only.

除非另有說明，此報告結果僅對測試之樣品負責，同時此樣品僅保留90天。本報告未經本公司書面許可，不可部份複製。

This document is issued by the Company subject to its General Conditions of Service printed overleaf, available on request or accessible at <http://www.sgs.com.tw/Terms-and-Conditions> and for electronic format documents, subject to Terms and Conditions for Electronic Documents at <http://www.sgs.com.tw/Terms-and-Conditions>. Attention is drawn to the limitation of liability, indemnification and jurisdiction issues defined therein. Any holder of this document is advised that information contained hereon reflects the Company's findings at the time of its intervention only and within the limits of Client's instructions, if any. The Company's sole responsibility is to its Client and this document does not exonerate parties to a transaction from exercising all their rights and obligations under the transaction documents. This document cannot be reproduced except in full, without prior written approval of the Company. Any unauthorized alteration, forgery or falsification of the content or appearance of this document is unlawful and offenders may be prosecuted to the fullest extent of the law.

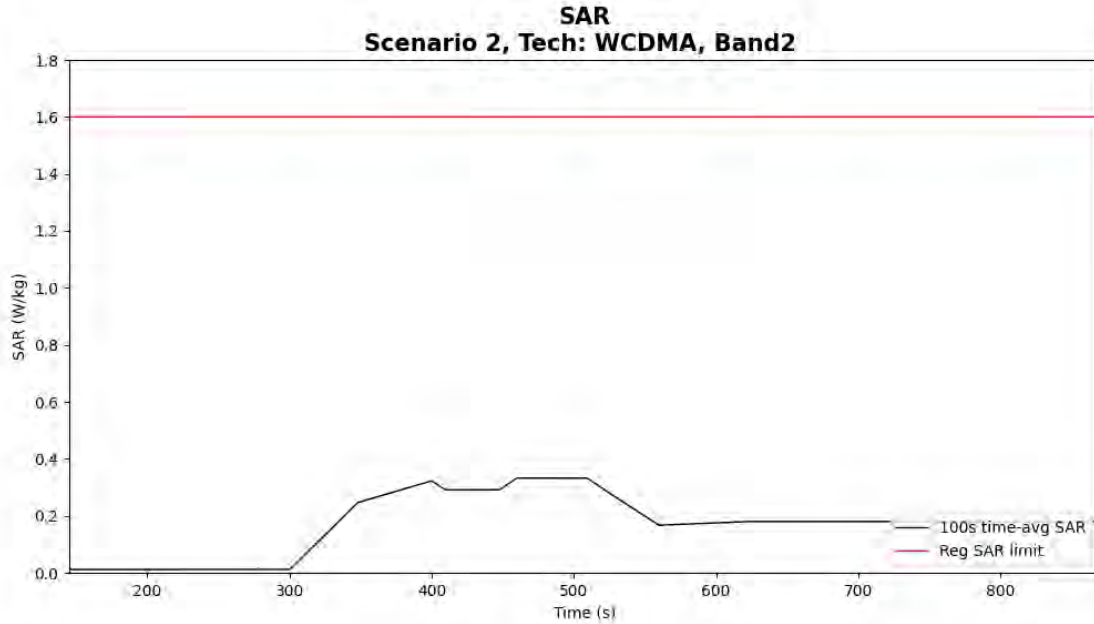

Figure 5- 27 Time-averaged SAR for case 2 (WCDMA B2)

FCC 1gSAR limit	1.6 W/kg
Max 100s-time averaged 1gSAR	0.332 W/kg
Validation result: pass	

Unless otherwise stated the results shown in this test report refer only to the sample(s) tested and such sample(s) are retained for 90 days only.

除非另有說明，此報告結果僅對測試之樣品負責，同時此樣品僅保留90天。本報告未經本公司書面許可，不可部份複製。

This document is issued by the Company subject to its General Conditions of Service printed overleaf, available on request or accessible at <http://www.sgs.com.tw/Terms-and-Conditions> and for electronic format documents, subject to Terms and Conditions for Electronic Documents at <http://www.sgs.com.tw/Terms-and-Conditions>. Attention is drawn to the limitation of liability, indemnification and jurisdiction issues defined therein. Any holder of this document is advised that information contained hereon reflects the Company's findings at the time of its intervention only and within the limits of Client's instructions, if any. The Company's sole responsibility is to its Client and this document does not exonerate parties to a transaction from exercising all their rights and obligations under the transaction documents. This document cannot be reproduced except in full, without prior written approval of the Company. Any unauthorized alteration, forgery or falsification of the content or appearance of this document is unlawful and offenders may be prosecuted to the fullest extent of the law.

- Case 3 in table 5-4: WCDMA B4 result for test sequence 1

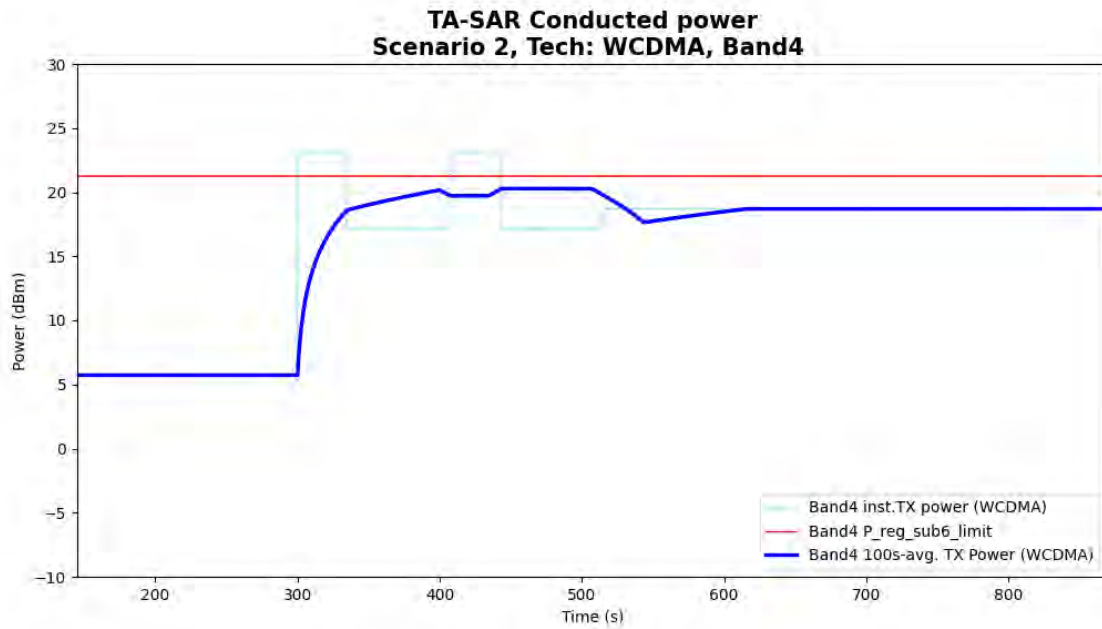

Figure 5- 28 Time-averaged conducted TX power over time for case 3 (WCDMA B4)

Unless otherwise stated the results shown in this test report refer only to the sample(s) tested and such sample(s) are retained for 90 days only.

除非另有說明，此報告結果僅對測試之樣品負責，同時此樣品僅保留90天。本報告未經本公司書面許可，不可部份複製。

This document is issued by the Company subject to its General Conditions of Service printed overleaf, available on request or accessible at <http://www.sgs.com.tw/Terms-and-Conditions> and for electronic format documents, subject to Terms and Conditions for Electronic Documents at <http://www.sgs.com.tw/Terms-and-Conditions>. Attention is drawn to the limitation of liability, indemnification and jurisdiction issues defined therein. Any holder of this document is advised that information contained hereon reflects the Company's findings at the time of its intervention only and within the limits of Client's instructions, if any. The Company's sole responsibility is to its Client and this document does not exonerate parties to a transaction from exercising all their rights and obligations under the transaction documents. This document cannot be reproduced except in full, without prior written approval of the Company. Any unauthorized alteration, forgery or falsification of the content or appearance of this document is unlawful and offenders may be prosecuted to the fullest extent of the law.

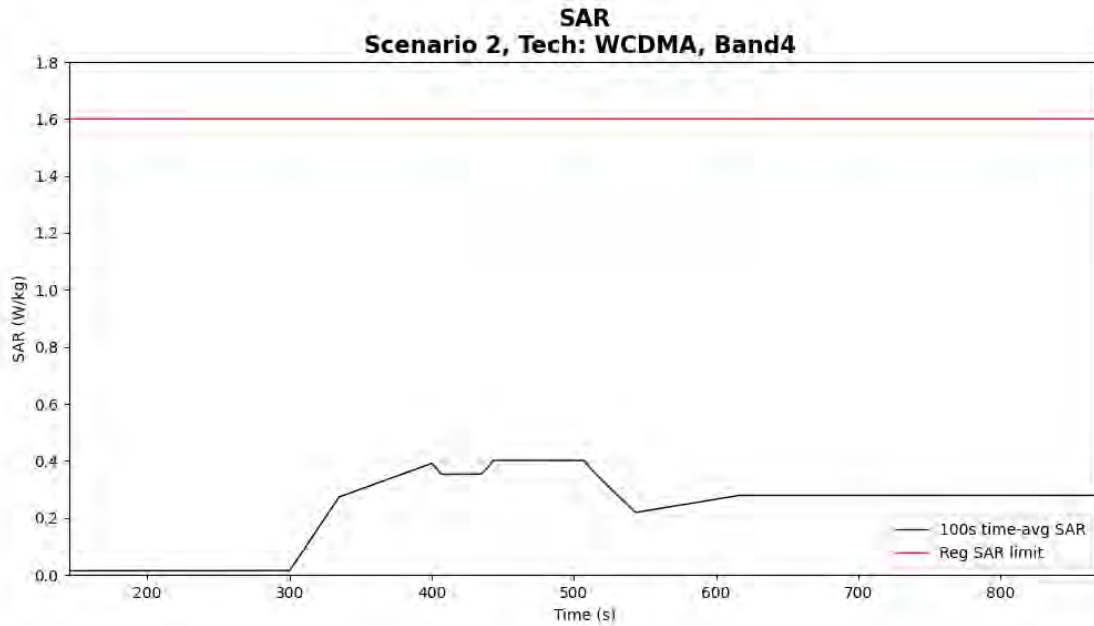

Figure 5- 29 Time-averaged SAR for case 3 (WCDMA B4)

FCC 1gSAR limit	1.6 W/kg
Max 100s-time averaged 1gSAR	0.402 W/kg
Validation result: pass	

Unless otherwise stated the results shown in this test report refer only to the sample(s) tested and such sample(s) are retained for 90 days only.

除非另有說明，此報告結果僅對測試之樣品負責，同時此樣品僅保留90天。本報告未經本公司書面許可，不可部份複製。

This document is issued by the Company subject to its General Conditions of Service printed overleaf, available on request or accessible at <http://www.sgs.com.tw/Terms-and-Conditions> and for electronic format documents, subject to Terms and Conditions for Electronic Documents at <http://www.sgs.com.tw/Terms-and-Conditions>. Attention is drawn to the limitation of liability, indemnification and jurisdiction issues defined therein. Any holder of this document is advised that information contained hereon reflects the Company's findings at the time of its intervention only and within the limits of Client's instructions, if any. The Company's sole responsibility is to its Client and this document does not exonerate parties to a transaction from exercising all their rights and obligations under the transaction documents. This document cannot be reproduced except in full, without prior written approval of the Company. Any unauthorized alteration, forgery or falsification of the content or appearance of this document is unlawful and offenders may be prosecuted to the fullest extent of the law.

•Case 9 in table 5-4: WCDMA B2 result for test sequence 2

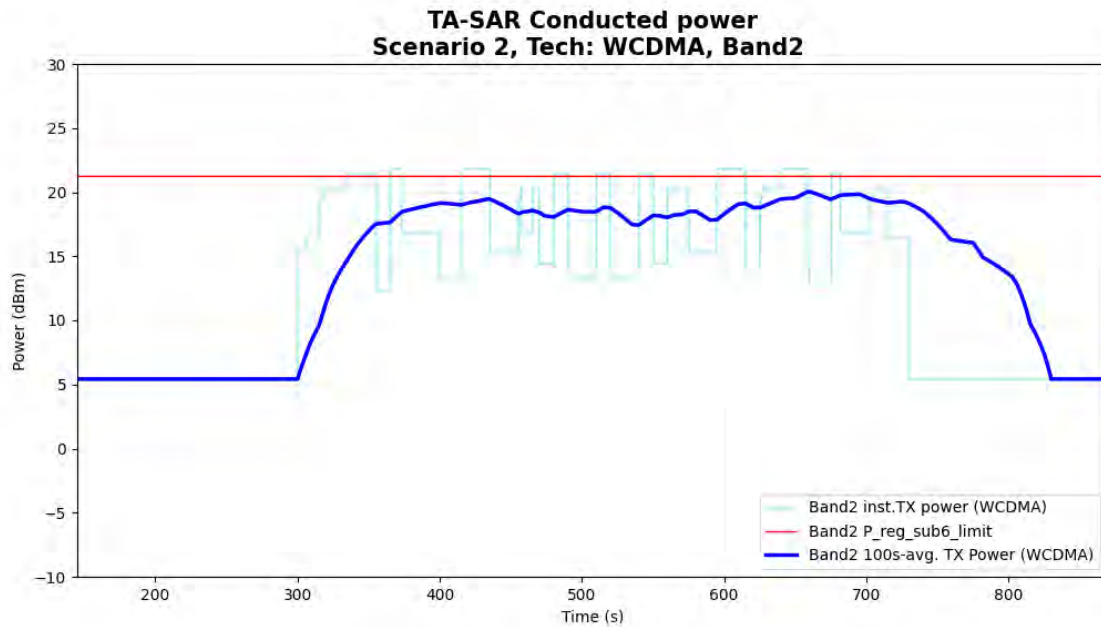

Figure 5- 30 Time-averaged conducted TX power over time for case 9 (WCDMA B2)

Unless otherwise stated the results shown in this test report refer only to the sample(s) tested and such sample(s) are retained for 90 days only.

除非另有說明，此報告結果僅對測試之樣品負責，同時此樣品僅保留90天。本報告未經本公司書面許可，不可部份複製。

This document is issued by the Company subject to its General Conditions of Service printed overleaf, available on request or accessible at <http://www.sgs.com.tw/Terms-and-Conditions> and for electronic format documents, subject to Terms and Conditions for Electronic Documents at <http://www.sgs.com.tw/Terms-and-Conditions>. Attention is drawn to the limitation of liability, indemnification and jurisdiction issues defined therein. Any holder of this document is advised that information contained hereon reflects the Company's findings at the time of its intervention only and within the limits of Client's instructions, if any. The Company's sole responsibility is to its Client and this document does not exonerate parties to a transaction from exercising all their rights and obligations under the transaction documents. This document cannot be reproduced except in full, without prior written approval of the Company. Any unauthorized alteration, forgery or falsification of the content or appearance of this document is unlawful and offenders may be prosecuted to the fullest extent of the law.

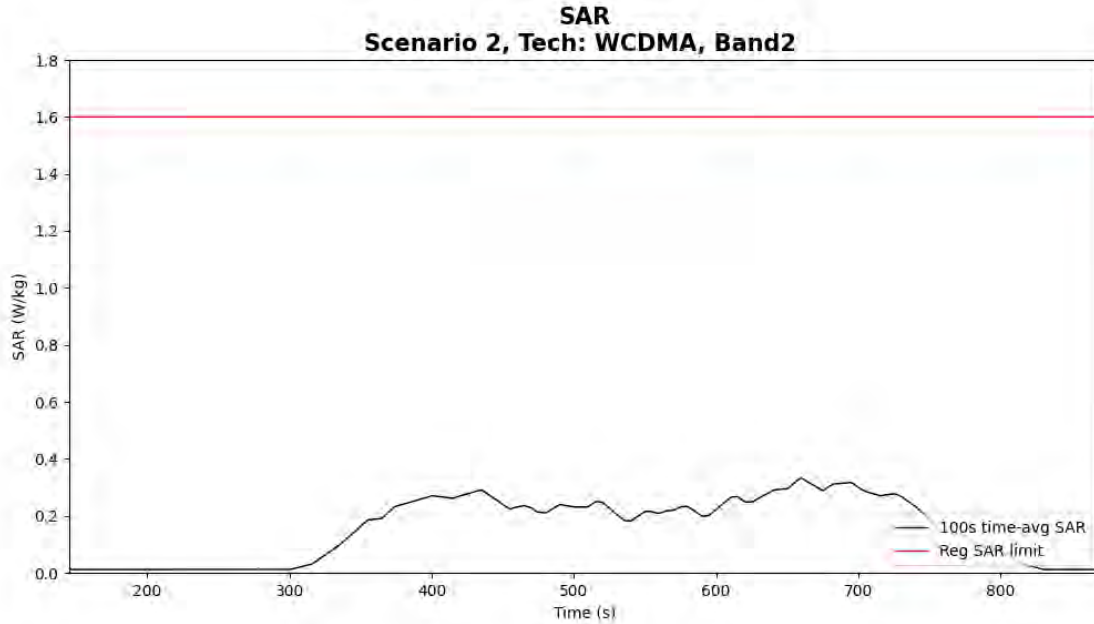

Figure 5- 31 Time-averaged SAR for case 9 (WCDMA B2)

FCC 1gSAR limit	1.6 W/kg
Max 100s-time averaged 1gSAR	0.332 W/kg
Validation result: pass	

Unless otherwise stated the results shown in this test report refer only to the sample(s) tested and such sample(s) are retained for 90 days only.

除非另有說明，此報告結果僅對測試之樣品負責，同時此樣品僅保留90天。本報告未經本公司書面許可，不可部份複製。

This document is issued by the Company subject to its General Conditions of Service printed overleaf, available on request or accessible at <http://www.sgs.com.tw/Terms-and-Conditions> and for electronic format documents, subject to Terms and Conditions for Electronic Documents at <http://www.sgs.com.tw/Terms-and-Conditions>. Attention is drawn to the limitation of liability, indemnification and jurisdiction issues defined therein. Any holder of this document is advised that information contained hereon reflects the Company's findings at the time of its intervention only and within the limits of Client's instructions, if any. The Company's sole responsibility is to its Client and this document does not exonerate parties to a transaction from exercising all their rights and obligations under the transaction documents. This document cannot be reproduced except in full, without prior written approval of the Company. Any unauthorized alteration, forgery or falsification of the content or appearance of this document is unlawful and offenders may be prosecuted to the fullest extent of the law.

- Case 10 in table 5-4: WCDMA B4 result for test sequence 2

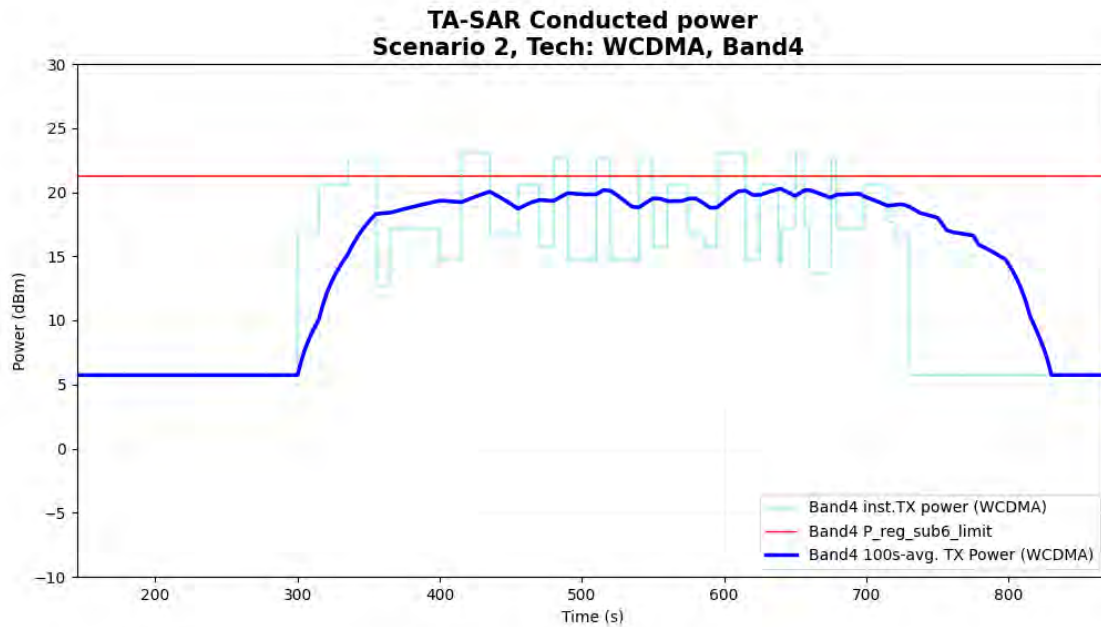

Figure 5- 32 Time-averaged conducted TX power over time for case 10 (WCDMA B4)

Unless otherwise stated the results shown in this test report refer only to the sample(s) tested and such sample(s) are retained for 90 days only.
除非另有說明，此報告結果僅對測試之樣品負責，同時此樣品僅保留90天。本報告未經本公司書面許可，不可部份複製。

This document is issued by the Company subject to its General Conditions of Service printed overleaf, available on request or accessible at <http://www.sgs.com.tw/Terms-and-Conditions> and for electronic format documents, subject to Terms and Conditions for Electronic Documents at <http://www.sgs.com.tw/Terms-and-Conditions>. Attention is drawn to the limitation of liability, indemnification and jurisdiction issues defined therein. Any holder of this document is advised that information contained hereon reflects the Company's findings at the time of its intervention only and within the limits of Client's instructions, if any. The Company's sole responsibility is to its Client and this document does not exonerate parties to a transaction from exercising all their rights and obligations under the transaction documents. This document cannot be reproduced except in full, without prior written approval of the Company. Any unauthorized alteration, forgery or falsification of the content or appearance of this document is unlawful and offenders may be prosecuted to the fullest extent of the law.

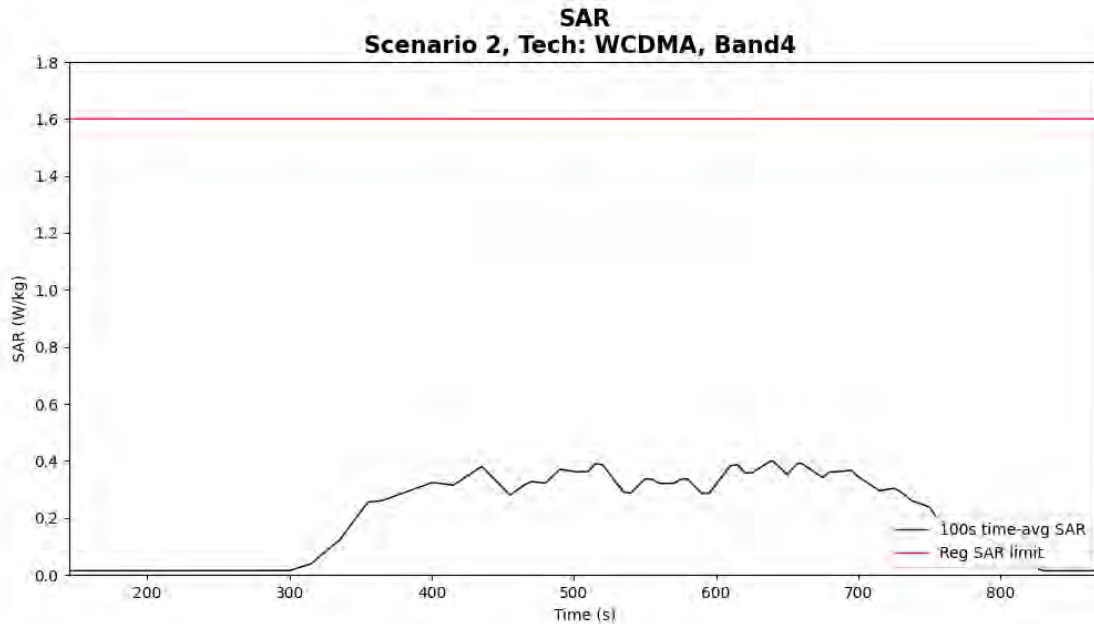

Figure 5- 33 Time-averaged SAR for case 10 (WCDMA B4)

FCC 1gSAR limit	1.6 W/kg
Max 100s-time averaged 1gSAR	1.09 W/kg
Validation result: pass	

Unless otherwise stated the results shown in this test report refer only to the sample(s) tested and such sample(s) are retained for 90 days only.

除非另有說明，此報告結果僅對測試之樣品負責，同時此樣品僅保留90天。本報告未經本公司書面許可，不可部份複製。

This document is issued by the Company subject to its General Conditions of Service printed overleaf, available on request or accessible at <http://www.sgs.com.tw/Terms-and-Conditions> and for electronic format documents, subject to Terms and Conditions for Electronic Documents at <http://www.sgs.com.tw/Terms-and-Conditions>. Attention is drawn to the limitation of liability, indemnification and jurisdiction issues defined therein. Any holder of this document is advised that information contained hereon reflects the Company's findings at the time of its intervention only and within the limits of Client's instructions, if any. The Company's sole responsibility is to its Client and this document does not exonerate parties to a transaction from exercising all their rights and obligations under the transaction documents. This document cannot be reproduced except in full, without prior written approval of the Company. Any unauthorized alteration, forgery or falsification of the content or appearance of this document is unlawful and offenders may be prosecuted to the fullest extent of the law.

5.3.5 Measurement results for 2G

These test cases are for 2G and are conducted under 2G band GPRS 850 4Tx with ECI = 2. The corresponding detailed test procedure is described in 4.3.2. For the figure set of each case, the first figure demonstrates the EUT's instantaneous conducted TX power, the time-averaged conducted TX power behavior over time, and the power limit ($P_{reg_sub6_limit} = P_{sub6_limit} + 1\text{dB}$ device uncertainty). The second figure illustrates the corresponding time-averaged SAR over time converted from the TX time-averaged power by using the equation listed in section 4.3.2.

Unless otherwise stated the results shown in this test report refer only to the sample(s) tested and such sample(s) are retained for 90 days only.

除非另有說明，此報告結果僅對測試之樣品負責，同時此樣品僅保留90天。本報告未經本公司書面許可，不可部份複製。

This document is issued by the Company subject to its General Conditions of Service printed overleaf, available on request or accessible at <http://www.sgs.com.tw/Terms-and-Conditions> and for electronic format documents, subject to Terms and Conditions for Electronic Documents at <http://www.sgs.com.tw/Terms-and-Conditions>. Attention is drawn to the limitation of liability, indemnification and jurisdiction issues defined therein. Any holder of this document is advised that information contained hereon reflects the Company's findings at the time of its intervention only and within the limits of Client's instructions, if any. The Company's sole responsibility is to its Client and this document does not exonerate parties to a transaction from exercising all their rights and obligations under the transaction documents. This document cannot be reproduced except in full, without prior written approval of the Company. Any unauthorized alteration, forgery or falsification of the content or appearance of this document is unlawful and offenders may be prosecuted to the fullest extent of the law.

- Case 1 in table 5-4: 2G GPRS 850 4TX result for test sequence 1

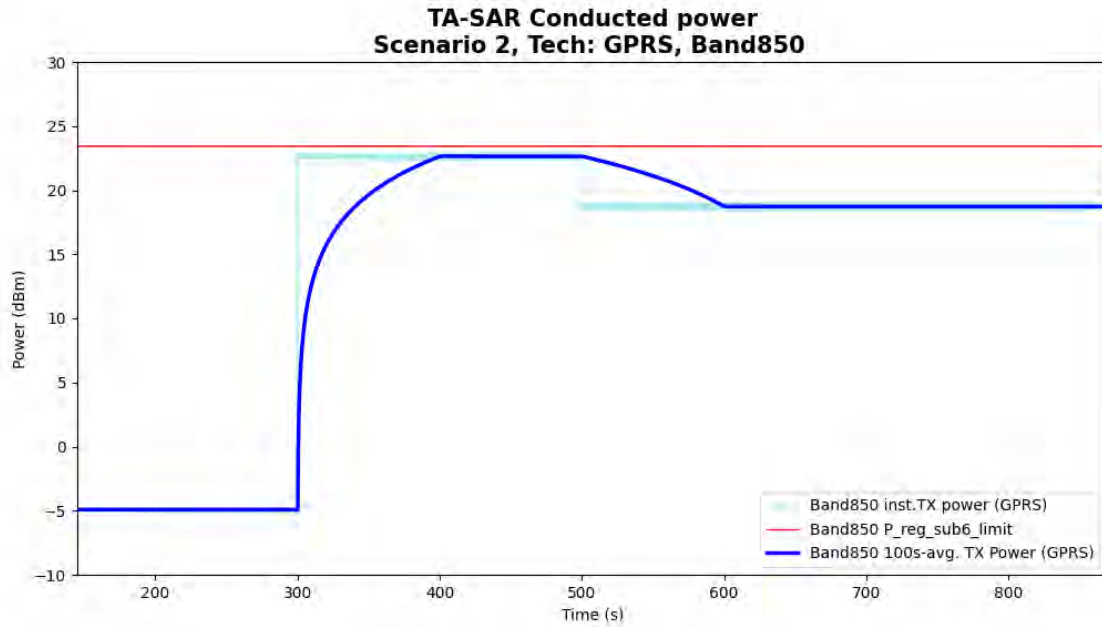

Figure 5- 38 Time-averaged conducted TX power over time for case 1 (2G GPRS 850 4TX)

Unless otherwise stated the results shown in this test report refer only to the sample(s) tested and such sample(s) are retained for 90 days only.

除非另有說明，此報告結果僅對測試之樣品負責，同時此樣品僅保留90天。本報告未經本公司書面許可，不可部份複製。

This document is issued by the Company subject to its General Conditions of Service printed overleaf, available on request or accessible at <http://www.sgs.com.tw/Terms-and-Conditions> and for electronic format documents, subject to Terms and Conditions for Electronic Documents at <http://www.sgs.com.tw/Terms-and-Conditions>. Attention is drawn to the limitation of liability, indemnification and jurisdiction issues defined therein. Any holder of this document is advised that information contained hereon reflects the Company's findings at the time of its intervention only and within the limits of Client's instructions, if any. The Company's sole responsibility is to its Client and this document does not exonerate parties to a transaction from exercising all their rights and obligations under the transaction documents. This document cannot be reproduced except in full, without prior written approval of the Company. Any unauthorized alteration, forgery or falsification of the content or appearance of this document is unlawful and offenders may be prosecuted to the fullest extent of the law.

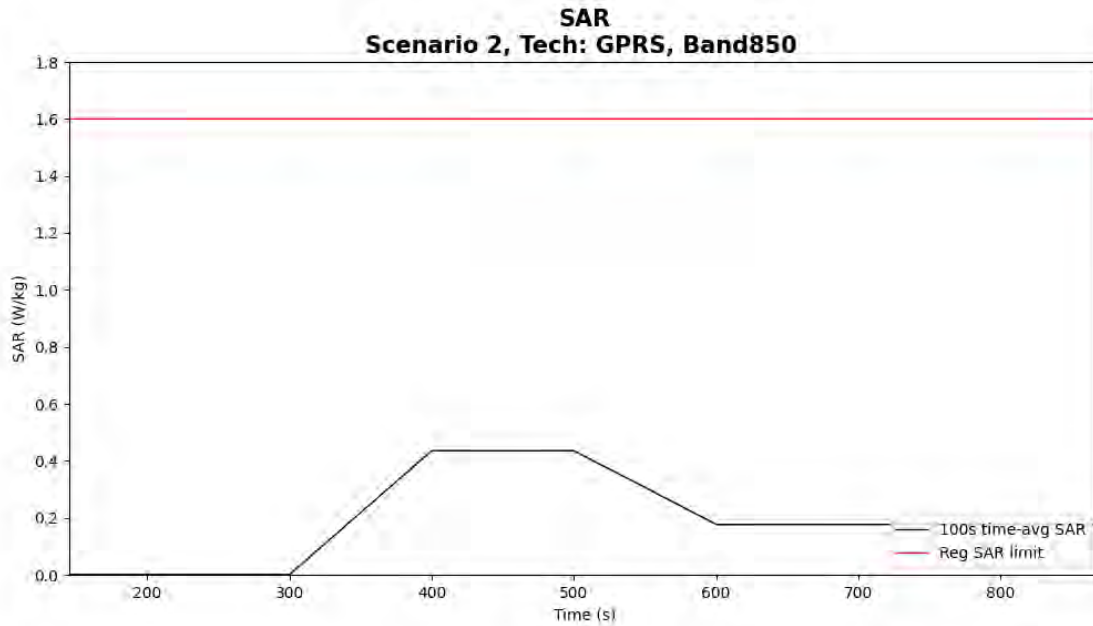

Figure 5- 39 Time-averaged SAR for case 1 (2G GPRS 850 4TX)

FCC 1gSAR limit	1.6 W/kg
Max 100s-time averaged 1gSAR	0.436 W/kg
Validation result: pass	

Unless otherwise stated the results shown in this test report refer only to the sample(s) tested and such sample(s) are retained for 90 days only.

除非另有說明，此報告結果僅對測試之樣品負責，同時此樣品僅保留90天。本報告未經本公司書面許可，不可部份複製。

This document is issued by the Company subject to its General Conditions of Service printed overleaf, available on request or accessible at <http://www.sgs.com.tw/Terms-and-Conditions> and for electronic format documents, subject to Terms and Conditions for Electronic Documents at <http://www.sgs.com.tw/Terms-and-Conditions>. Attention is drawn to the limitation of liability, indemnification and jurisdiction issues defined therein. Any holder of this document is advised that information contained hereon reflects the Company's findings at the time of its intervention only and within the limits of Client's instructions, if any. The Company's sole responsibility is to its Client and this document does not exonerate parties to a transaction from exercising all their rights and obligations under the transaction documents. This document cannot be reproduced except in full, without prior written approval of the Company. Any unauthorized alteration, forgery or falsification of the content or appearance of this document is unlawful and offenders may be prosecuted to the fullest extent of the law.

•Case 8 in table 5-4: 2G GPRS 850 4Tx result for test sequence 2

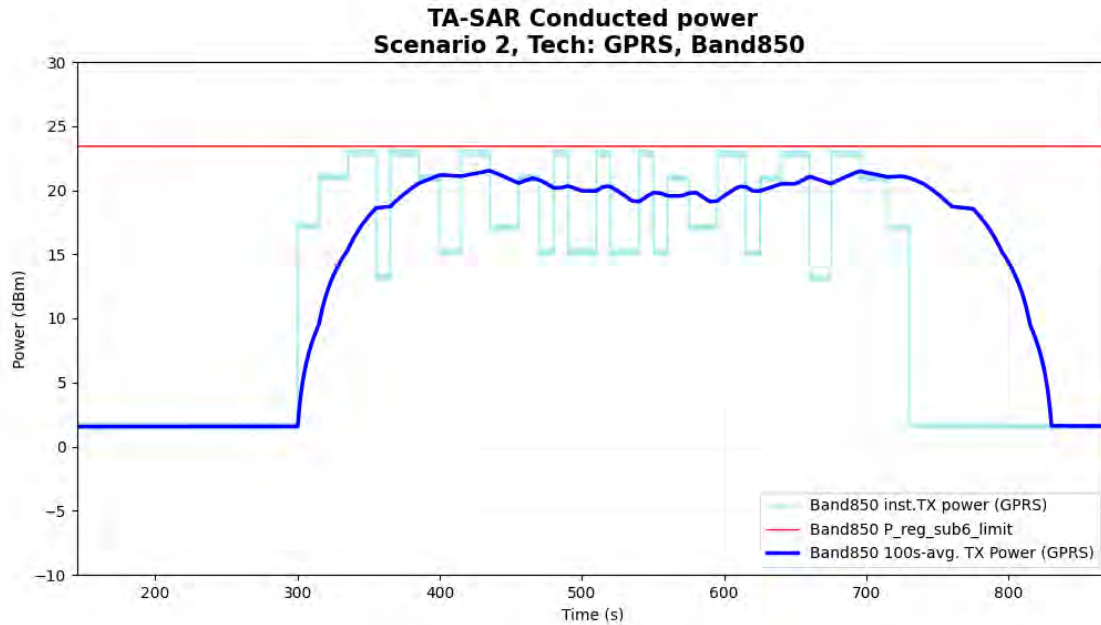

Figure 5- 40 Time-averaged conducted TX power over time for case 8 (2G GPRS 850 4Tx)

Unless otherwise stated the results shown in this test report refer only to the sample(s) tested and such sample(s) are retained for 90 days only.

除非另有說明，此報告結果僅對測試之樣品負責，同時此樣品僅保留90天。本報告未經本公司書面許可，不可部份複製。

This document is issued by the Company subject to its General Conditions of Service printed overleaf, available on request or accessible at <http://www.sgs.com.tw/Terms-and-Conditions> and for electronic format documents, subject to Terms and Conditions for Electronic Documents at <http://www.sgs.com.tw/Terms-and-Conditions>. Attention is drawn to the limitation of liability, indemnification and jurisdiction issues defined therein. Any holder of this document is advised that information contained hereon reflects the Company's findings at the time of its intervention only and within the limits of Client's instructions, if any. The Company's sole responsibility is to its Client and this document does not exonerate parties to a transaction from exercising all their rights and obligations under the transaction documents. This document cannot be reproduced except in full, without prior written approval of the Company. Any unauthorized alteration, forgery or falsification of the content or appearance of this document is unlawful and offenders may be prosecuted to the fullest extent of the law.

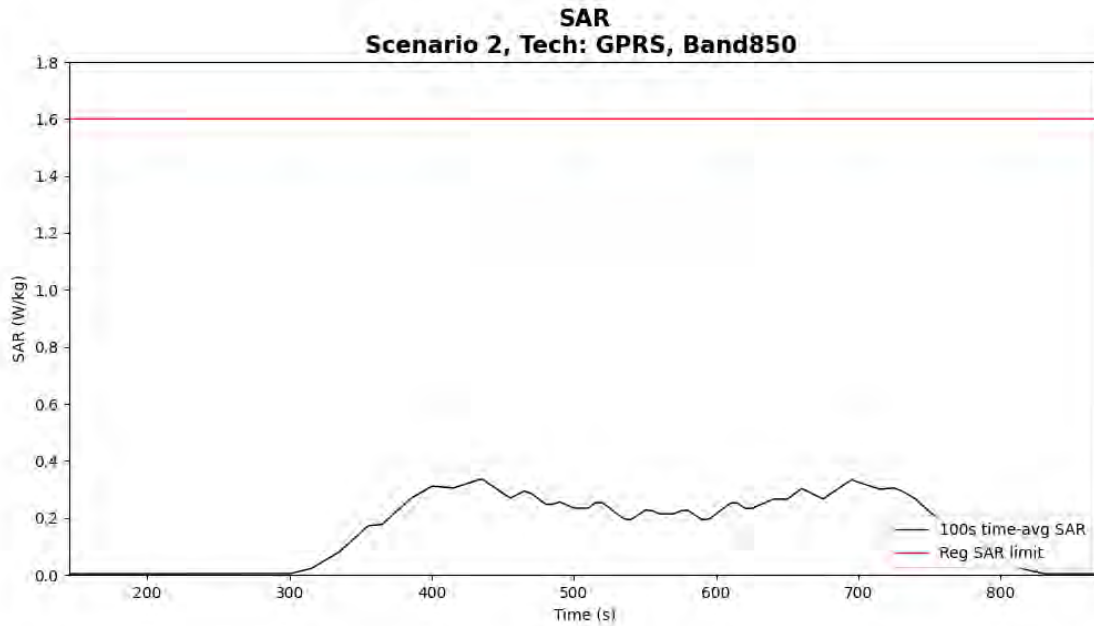

Figure 5- 41 Time-averaged SAR for case 8 (2G GPRS 850 4Tx)

FCC 1gSAR limit	1.6 W/kg
Max 100s-time averaged 1gSAR	0.337 W/kg
Validation result: pass	

Unless otherwise stated the results shown in this test report refer only to the sample(s) tested and such sample(s) are retained for 90 days only.

除非另有說明，此報告結果僅對測試之樣品負責，同時此樣品僅保留90天。本報告未經本公司書面許可，不可部份複製。

This document is issued by the Company subject to its General Conditions of Service printed overleaf, available on request or accessible at <http://www.sgs.com.tw/Terms-and-Conditions> and for electronic format documents, subject to Terms and Conditions for Electronic Documents at <http://www.sgs.com.tw/Terms-and-Conditions>. Attention is drawn to the limitation of liability, indemnification and jurisdiction issues defined therein. Any holder of this document is advised that information contained hereon reflects the Company's findings at the time of its intervention only and within the limits of Client's instructions, if any. The Company's sole responsibility is to its Client and this document does not exonerate parties to a transaction from exercising all their rights and obligations under the transaction documents. This document cannot be reproduced except in full, without prior written approval of the Company. Any unauthorized alteration, forgery or falsification of the content or appearance of this document is unlawful and offenders may be prosecuted to the fullest extent of the law.

5.4 Conducted Power Measurement Results for Scenario 3: Call Disconnection and Re-establishment

In this scenario, the test power sequence #0 (i.e., maximum TX power is requested by a call box for each RAT) is used, and the call drop is manually configured for a pre-defined period and then the call is re-established to continue data transmission. The test case for this scenario is relegated in Table 5-5, and the test procedure follows section 4.4.2. The measurement setup is shown in Figure 5-2. The high-level summary of the final validation results is also listed in the last column of the table, which concludes that Mediatek's TA-SAR algorithm can maintain the time-averaged SAR is always below the FCC requirement. The following section will demonstrate how Mediatek's TA-SAR algorithm behaves.

Table 5-5 TA-SAR parameters setting for scenario 3

Test case	RAT	Test band	Test seq.	ECI	Max power (dBm)	P_{sub6_limit} (dBm)	$P_{LowThresh}$ (dBm)	$P_{UE_backoff}$ (dBm)	$P_{UE_max_cust}$ (dBm)	Pass /Fail SAR limit
15	LTE	Band 2	0	2	23.00	17.50	17.00	14.50	23.00	Pass

This test is for LTE B2 with ECI = 2. The corresponding detailed test procedure is described in 4.4.2. Figure 5-42 demonstrates the EUT's instantaneous conducted TX power, the time-averaged conducted TX power behavior over time, and the power limit ($P_{reg_sub6_limit} = P_{sub6_limit} + 1\text{dB}$ device uncertainty). Figure 5-43 illustrates the corresponding time-averaged SAR over time converted from the TX time-averaged power by using the equation listed in section 4.4.2. As seen in this figure, the time-averaged SAR does not exceed the FCC limit.

Unless otherwise stated the results shown in this test report refer only to the sample(s) tested and such sample(s) are retained for 90 days only.

除非另有說明，此報告結果僅對測試之樣品負責，同時此樣品僅保留90天。本報告未經本公司書面許可，不可部份複製。

This document is issued by the Company subject to its General Conditions of Service printed overleaf, available on request or accessible at <http://www.sgs.com.tw/Terms-and-Conditions> and for electronic format documents, subject to Terms and Conditions for Electronic Documents at <http://www.sgs.com.tw/Terms-and-Conditions>. Attention is drawn to the limitation of liability, indemnification and jurisdiction issues defined therein. Any holder of this document is advised that information contained hereon reflects the Company's findings at the time of its intervention only and within the limits of Client's instructions, if any. The Company's sole responsibility is to its Client and this document does not exonerate parties to a transaction from exercising all their rights and obligations under the transaction documents. This document cannot be reproduced except in full, without prior written approval of the Company. Any unauthorized alteration, forgery or falsification of the content or appearance of this document is unlawful and offenders may be prosecuted to the fullest extent of the law.

- Case 15 in table 5-5: call drop happens at the time instance of 500 seconds.

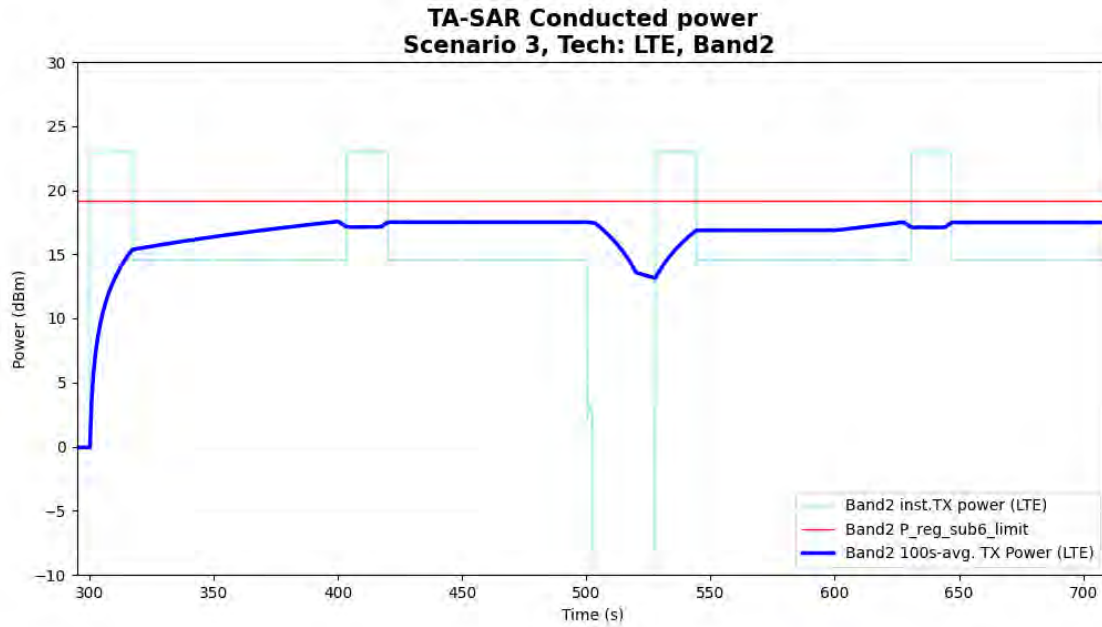

Figure 5- 42 Time-averaged conducted TX power over time for case 15 (LTE B2)

Unless otherwise stated the results shown in this test report refer only to the sample(s) tested and such sample(s) are retained for 90 days only.

除非另有說明，此報告結果僅對測試之樣品負責，同時此樣品僅保留90天。本報告未經本公司書面許可，不可部份複製。

This document is issued by the Company subject to its General Conditions of Service printed overleaf, available on request or accessible at <http://www.sgs.com.tw/Terms-and-Conditions> and for electronic format documents, subject to Terms and Conditions for Electronic Documents at <http://www.sgs.com.tw/Terms-and-Conditions>. Attention is drawn to the limitation of liability, indemnification and jurisdiction issues defined therein. Any holder of this document is advised that information contained hereon reflects the Company's findings at the time of its intervention only and within the limits of Client's instructions, if any. The Company's sole responsibility is to its Client and this document does not exonerate parties to a transaction from exercising all their rights and obligations under the transaction documents. This document cannot be reproduced except in full, without prior written approval of the Company. Any unauthorized alteration, forgery or falsification of the content or appearance of this document is unlawful and offenders may be prosecuted to the fullest extent of the law.

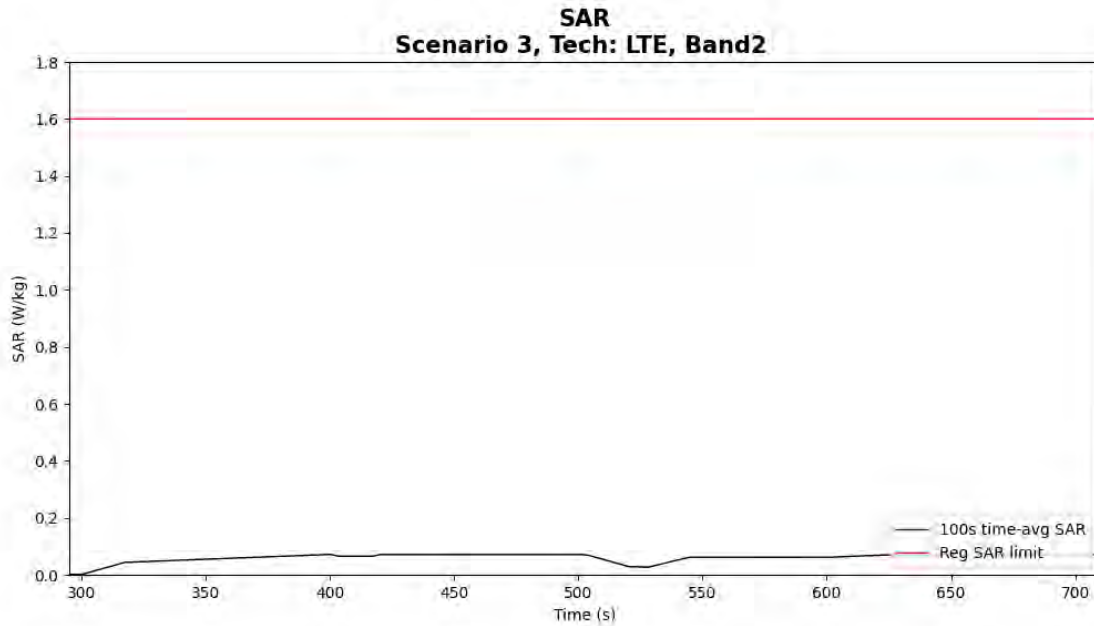

Figure 5- 43 Time-averaged SAR for case 15 (LTE B2)

FCC 1gSAR limit	1.6 W/kg
Max 100s-time averaged 1gSAR	0.719 W/kg
Validation result: pass	

Unless otherwise stated the results shown in this test report refer only to the sample(s) tested and such sample(s) are retained for 90 days only.

除非另有說明，此報告結果僅對測試之樣品負責，同時此樣品僅保留90天。本報告未經本公司書面許可，不可部份複製。

This document is issued by the Company subject to its General Conditions of Service printed overleaf, available on request or accessible at <http://www.sgs.com.tw/Terms-and-Conditions> and for electronic format documents, subject to Terms and Conditions for Electronic Documents at <http://www.sgs.com.tw/Terms-and-Conditions>. Attention is drawn to the limitation of liability, indemnification and jurisdiction issues defined therein. Any holder of this document is advised that information contained hereon reflects the Company's findings at the time of its intervention only and within the limits of Client's instructions, if any. The Company's sole responsibility is to its Client and this document does not exonerate parties to a transaction from exercising all their rights and obligations under the transaction documents. This document cannot be reproduced except in full, without prior written approval of the Company. Any unauthorized alteration, forgery or falsification of the content or appearance of this document is unlawful and offenders may be prosecuted to the fullest extent of the law.

5.5 Conducted Power Measurement Results for Scenario 4: Band Handover

In this scenario, the test power sequence #0 (i.e., maximum TX power is requested by a call box for each RAT) is used, and band (and RAT) handover is manually configured at a specific time instance. The test case widely cover handover scenarios between two RATs. The test case for this scenario is relegated in Table 5-6, and the test procedure follows section 4.5.2. The measurement setup is shown in Figure 5-3 (band handover) and Figure 5-5 (RAT handover). The high-level summary of the final validation results is also listed in the last column of the table, which concludes that Mediatek's TA-SAR algorithm can maintain the time-averaged SAR is always below the FCC requirement. The following section will demonstrate how Mediatek's TA-SAR algorithm behaves.

Table 5-6 TA-SAR parameters setting for scenario 4

Test case	RAT	Test band	Test seq.	ECI	Max power (dBm)	P_{sub6_limit} (dBm)	$P_{LowThresh}$ (dBm)	$P_{UE_backoff}$ (dBm)	$P_{UE_max_cust}$ (dBm)	Pass /Fail SAR limit
16	LTE	Band 2	0	2	23.00	17.50	17.00	14.50	23.00	Pass
	FR1	n5	0	2	24.00	23.00	22.50	20.00	24.00	

This test aims to validate the TA-SAR algorithm with a handover from LTE band B2 to 5G n5 and ECI = 2. The corresponding detailed test procedure is described in 4.5.2. The first figure demonstrates the EUT's instantaneous conducted TX power and the time-averaged conducted TX power behavior over time, and the power limit ($P_{reg_sub6_limit} = P_{sub6_limit} + 1\text{dB}$ device uncertainty). The handover is configured at the time instance of 500 seconds. It is observed in the figure that the time-averaged TX power of the individual RAT is below its own P_{sub6_limit} . The second figure illustrates the corresponding time-averaged normalized SAR over time converted from the TX time-averaged power by using the equation listed in section 4.5.2. The figure shows that the time-averaged normalized SAR does not exceed the normalized FCC limit of 1.

Unless otherwise stated the results shown in this test report refer only to the sample(s) tested and such sample(s) are retained for 90 days only.

除非另有說明，此報告結果僅對測試之樣品負責，同時此樣品僅保留90天。本報告未經本公司書面許可，不可部份複製。

This document is issued by the Company subject to its General Conditions of Service printed overleaf, available on request or accessible at <http://www.sgs.com.tw/Terms-and-Conditions> and for electronic format documents, subject to Terms and Conditions for Electronic Documents at <http://www.sgs.com.tw/Terms-and-Conditions>. Attention is drawn to the limitation of liability, indemnification and jurisdiction issues defined therein. Any holder of this document is advised that information contained hereon reflects the Company's findings at the time of its intervention only and within the limits of Client's instructions, if any. The Company's sole responsibility is to its Client and this document does not exonerate parties to a transaction from exercising all their rights and obligations under the transaction documents. This document cannot be reproduced except in full, without prior written approval of the Company. Any unauthorized alteration, forgery or falsification of the content or appearance of this document is unlawful and offenders may be prosecuted to the fullest extent of the law.

•Case 16 in table 5-6: band handover happens at the time instance of 500 seconds.

**TA-SAR Conducted power
Scenario 4, Tech: LTE, Band2
/ Tech: NR FR1, Band5**

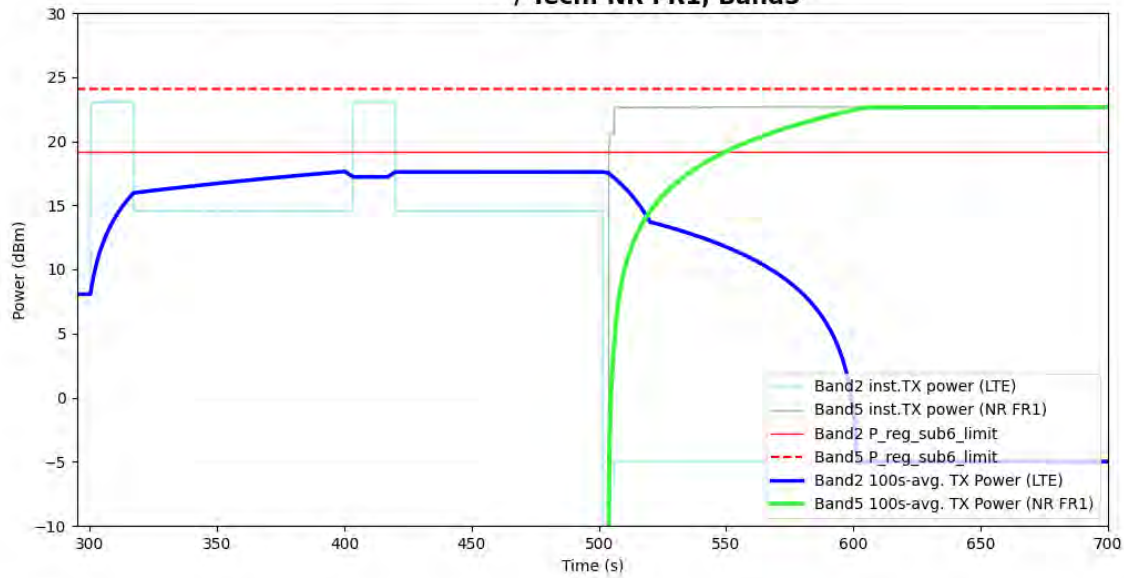

Figure 5- 44 Time-averaged conducted TX power over time for case 16 (LTE B2, sub6 NR B5)

Unless otherwise stated the results shown in this test report refer only to the sample(s) tested and such sample(s) are retained for 90 days only.

除非另有說明，此報告結果僅對測試之樣品負責，同時此樣品僅保留90天。本報告未經本公司書面許可，不可部份複製。

This document is issued by the Company subject to its General Conditions of Service printed overleaf, available on request or accessible at <http://www.sgs.com.tw/Terms-and-Conditions> and for electronic format documents, subject to Terms and Conditions for Electronic Documents at <http://www.sgs.com.tw/Terms-and-Conditions>. Attention is drawn to the limitation of liability, indemnification and jurisdiction issues defined therein. Any holder of this document is advised that information contained hereon reflects the Company's findings at the time of its intervention only and within the limits of Client's instructions, if any. The Company's sole responsibility is to its Client and this document does not exonerate parties to a transaction from exercising all their rights and obligations under the transaction documents. This document cannot be reproduced except in full, without prior written approval of the Company. Any unauthorized alteration, forgery or falsification of the content or appearance of this document is unlawful and offenders may be prosecuted to the fullest extent of the law.

**Total normalized Time-averaged RF exposure
Scenario 4, Tech: LTE, Band2
/ Tech: NR FR1, Band5**

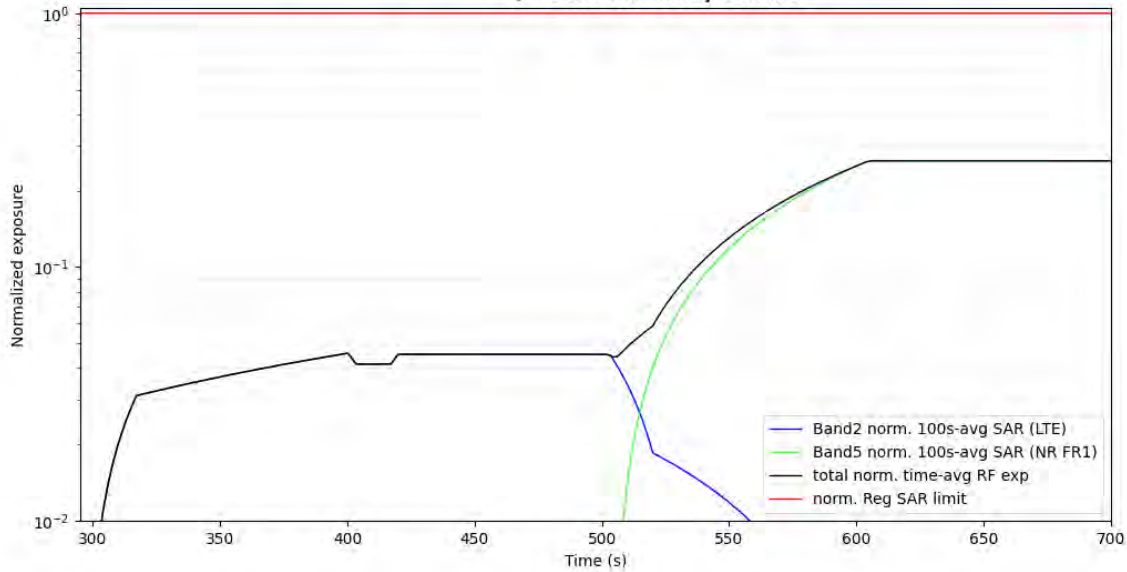

Figure 5- 45 Normalized time-averaged SAR for case 16 (LTE B2, sub6 NR B5)

FCC limit of total RF exposure (normalized)	1.0
Max total normalized time-averaged RF exposure	0.262
Validation result: pass	

Unless otherwise stated the results shown in this test report refer only to the sample(s) tested and such sample(s) are retained for 90 days only.

除非另有說明，此報告結果僅對測試之樣品負責，同時此樣品僅保留90天。本報告未經本公司書面許可，不可部份複製。

This document is issued by the Company subject to its General Conditions of Service printed overleaf, available on request or accessible at <http://www.sgs.com.tw/Terms-and-Conditions> and for electronic format documents, subject to Terms and Conditions for Electronic Documents at <http://www.sgs.com.tw/Terms-and-Conditions>. Attention is drawn to the limitation of liability, indemnification and jurisdiction issues defined therein. Any holder of this document is advised that information contained hereon reflects the Company's findings at the time of its intervention only and within the limits of Client's instructions, if any. The Company's sole responsibility is to its Client and this document does not exonerate parties to a transaction from exercising all their rights and obligations under the transaction documents. This document cannot be reproduced except in full, without prior written approval of the Company. Any unauthorized alteration, forgery or falsification of the content or appearance of this document is unlawful and offenders may be prosecuted to the fullest extent of the law.

5.6 Conducted Power Measurement Results for Scenario 5: ECI Change

In this scenario, the test power sequence #0 (i.e., maximum TX power is requested by a call box for each RAT) is used, and ECI change at the EUT side is manually configured at a specific time instance. The test case cover ECI switching scenario between two ECIs. The test case for this scenario is relegated in Table 5-7, and the test procedure follows section 4.6.2. The measurement setup is shown in Figure 5-2. The high-level summary of the final validation results is also listed in the last column of the table, which concludes that Mediatek's TA-SAR algorithm can maintain the time-averaged SAR is always below the FCC requirement. The following section will demonstrate how Mediatek's TA-SAR algorithm behaves.

Table 5-7 TA-SAR parameters setting for scenario 5

Test case	RAT	Test band	Test seq.	ECI	Max power (dBm)	P_{sub6_limit} (dBm)	$P_{LowThresh}$ (dBm)	$P_{UE_backoff}$ (dBm)	$P_{UE_max_cust}$ (dBm)	Pass /Fail SAR limit
17	LTE	B2	0	2	23	17.1	16.1	15.1	20.1	Pass
				1		18.1	17.1	16.1	21.1	

This test aims to validate the TA-SAR algorithm with ECI change from 4G LTE band B2 with ECI = 2 to ECI = 1. The corresponding detailed test procedure is described in 4.6.2. The first figure demonstrates the EUT's instantaneous conducted TX power and the time-averaged conducted TX power behavior over time, and the power limit ($P_{reg_sub6_limit} = P_{sub6_limit} + 1\text{dB}$ device uncertainty). During the test period, there are two ECI change events configured individually at the time instances 500 seconds and 700 seconds. The 1st change is from ECI = 2 to ECI = 1 and the 2nd change is from ECI = 1 back to ECI = 2. It is observed in the figure that the time-averaged TX power of the individual RAT is below its own P_{sub6_limit} . The second figure illustrates the corresponding time-averaged normalized SAR over time converted from the TX time-averaged power by using the equation listed in section 4.6.2. The figure shows that the time-averaged normalized SAR does not exceed the normalized FCC limit of 1.

Unless otherwise stated the results shown in this test report refer only to the sample(s) tested and such sample(s) are retained for 90 days only.

除非另有說明，此報告結果僅對測試之樣品負責，同時此樣品僅保留90天。本報告未經本公司書面許可，不可部份複製。

This document is issued by the Company subject to its General Conditions of Service printed overleaf, available on request or accessible at <http://www.sgs.com.tw/Terms-and-Conditions> and for electronic format documents, subject to Terms and Conditions for Electronic Documents at <http://www.sgs.com.tw/Terms-and-Conditions>. Attention is drawn to the limitation of liability, indemnification and jurisdiction issues defined therein. Any holder of this document is advised that information contained hereon reflects the Company's findings at the time of its intervention only and within the limits of Client's instructions, if any. The Company's sole responsibility is to its Client and this document does not exonerate parties to a transaction from exercising all their rights and obligations under the transaction documents. This document cannot be reproduced except in full, without prior written approval of the Company. Any unauthorized alteration, forgery or falsification of the content or appearance of this document is unlawful and offenders may be prosecuted to the fullest extent of the law.

- Case 17 in table 5-7: two ECI changes happen at the time instances of 500 and 700 seconds, respectively.

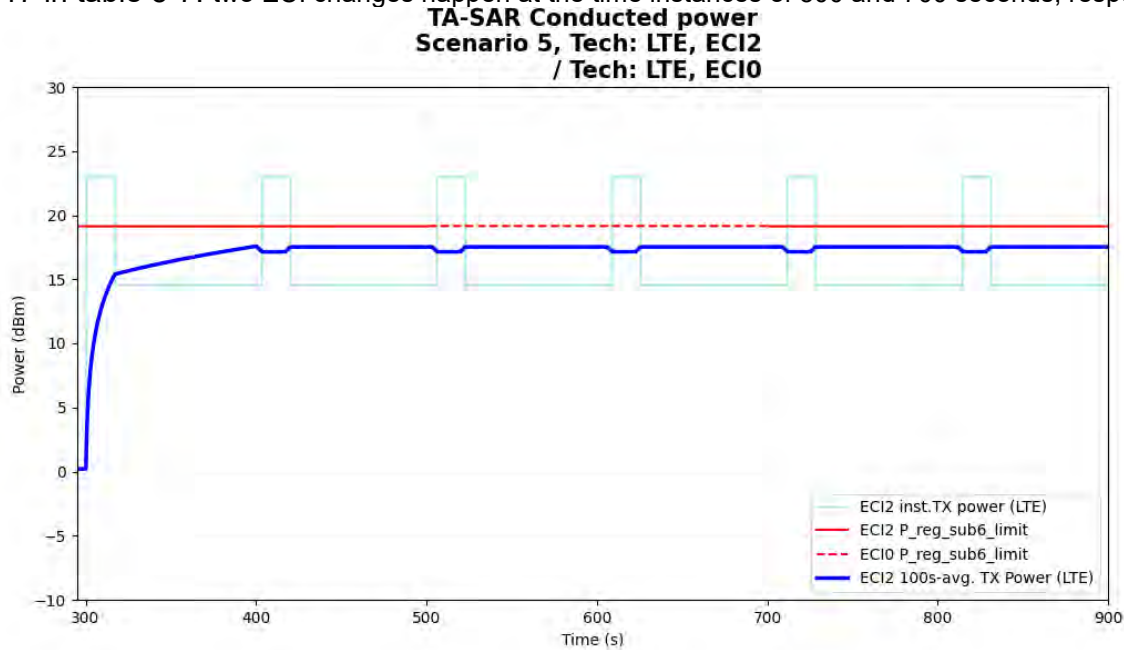

Figure 5- 46 Time-averaged conducted TX power over time for case 17 (LTE B2)

NOTE : The inst. TX power should be compared with P_reg_sub6_limit of the corresponding configuration, then transformed and averaged in SAR perspective to check compliance. Therefore, even though the time-averaged TX power seems to exceed P_reg_sub6_limit after configuration changed (from 700s to 730s), the time-averaged SAR pass regulation as a matter of fact.

Unless otherwise stated the results shown in this test report refer only to the sample(s) tested and such sample(s) are retained for 90 days only.

除非另有說明，此報告結果僅對測試之樣品負責，同時此樣品僅保留90天。本報告未經本公司書面許可，不可部份複製。

This document is issued by the Company subject to its General Conditions of Service printed overleaf, available on request or accessible at <http://www.sgs.com.tw/Terms-and-Conditions> and for electronic format documents, subject to Terms and Conditions for Electronic Documents at <http://www.sgs.com.tw/Terms-and-Conditions>. Attention is drawn to the limitation of liability, indemnification and jurisdiction issues defined therein. Any holder of this document is advised that information contained hereon reflects the Company's findings at the time of its intervention only and within the limits of Client's instructions, if any. The Company's sole responsibility is to its Client and this document does not exonerate parties to a transaction from exercising all their rights and obligations under the transaction documents. This document cannot be reproduced except in full, without prior written approval of the Company. Any unauthorized alteration, forgery or falsification of the content or appearance of this document is unlawful and offenders may be prosecuted to the fullest extent of the law.

**Total normalized Time-averaged RF exposure
Scenario 5, Tech: LTE, ECI2
/ Tech: LTE, ECI0**

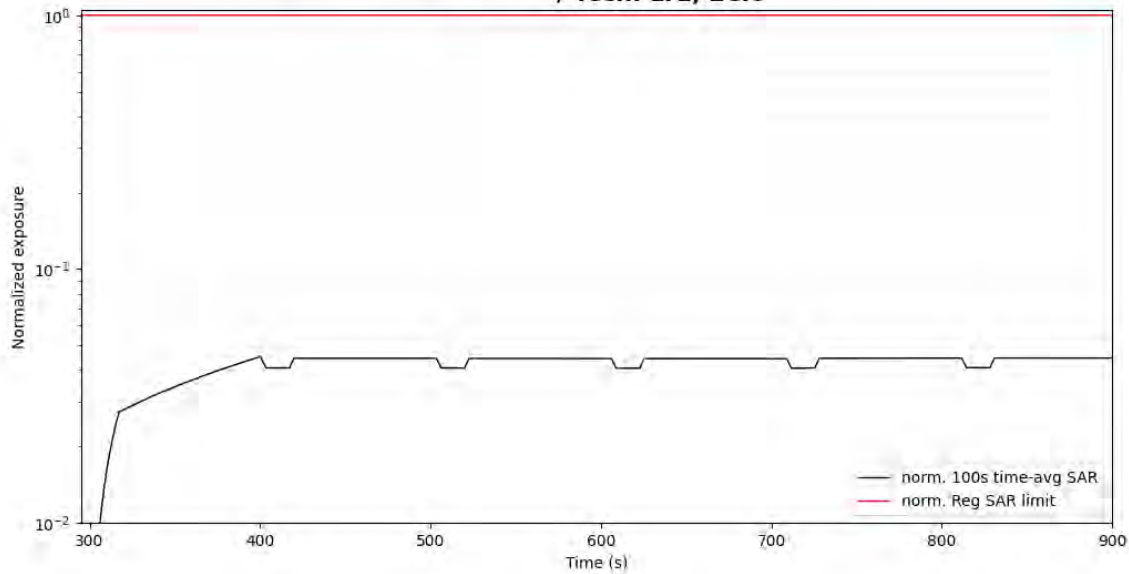

Figure 5- 47 Normalized time-averaged SAR for case 17 (LTE B2)

FCC limit of total RF exposure (normalized)	1.0
Max total normalized time-averaged RF exposure	0.451
Validation result: pass	

Unless otherwise stated the results shown in this test report refer only to the sample(s) tested and such sample(s) are retained for 90 days only.

除非另有說明，此報告結果僅對測試之樣品負責，同時此樣品僅保留90天。本報告未經本公司書面許可，不可部份複製。

This document is issued by the Company subject to its General Conditions of Service printed overleaf, available on request or accessible at <http://www.sgs.com.tw/Terms-and-Conditions> and for electronic format documents, subject to Terms and Conditions for Electronic Documents at <http://www.sgs.com.tw/Terms-and-Conditions>. Attention is drawn to the limitation of liability, indemnification and jurisdiction issues defined therein. Any holder of this document is advised that information contained hereon reflects the Company's findings at the time of its intervention only and within the limits of Client's instructions, if any. The Company's sole responsibility is to its Client and this document does not exonerate parties to a transaction from exercising all their rights and obligations under the transaction documents. This document cannot be reproduced except in full, without prior written approval of the Company. Any unauthorized alteration, forgery or falsification of the content or appearance of this document is unlawful and offenders may be prosecuted to the fullest extent of the law.

5.7 Conducted Power Measurement Results for Scenario 8: SAR Exposure Switching

In this scenario, the test power sequence #0 (i.e., maximum TX power is requested by a call box for each RAT) is used, and LTE and sub6 NR are turned on at the same time for a pre-defined period during the test. This scenario aims to validate whether the TA-SAR algorithm is able to maintain TER below the FCC limit when the two radios change TX power dynamically. The experiment parameters are summarized in Table 5-10, and the test procedure follows section 4.9.2. The measurement setup is shown in Figure 5-5.

Table 5-10 TA-SAR parameters setting for scenario 8

Test case	RAT	Test band	Test seq.	ECI	Max power (dBm)	P_{sub6_limit} (dBm)	$P_{LowThresh}$ (dBm)	$P_{UE_backoff}$ (dBm)	$P_{UE_max_cust}$ (dBm)	Pass /Fail SAR limit
18	LTE	B2	0	2	23.00	17.50	17.00	14.50	23.00	Pass
	NR	n5	0	2	24.00	23.00	22.50	20.00	24.00	

During the test period,

- Time = 300s~500s: NR sub5-only scenario.
- Time = 500s~700s: LTE+ NR sub6 scenario.
- Time = 700s~900s: LTE-only scenario.

The first figure demonstrates the EUT's instantaneous conducted TX power and the time-averaged conducted TX power behavior over time, and the power limit ($P_{reg_sub6_limit} = P_{sub6_limit} + 1\text{dB}$ device uncertainty). It is observed in the figure that the time-averaged TX power in all time periods is maintained below the power limitation. The second figure illustrates the corresponding time-averaged normalized SAR over time converted from the TX time-averaged power by using the equation listed in section 4.9.2. The figure shows that the time-averaged normalized SAR does not exceed the normalized FCC limit of 1.

Unless otherwise stated the results shown in this test report refer only to the sample(s) tested and such sample(s) are retained for 90 days only.

除非另有說明，此報告結果僅對測試之樣品負責，同時此樣品僅保留90天。本報告未經本公司書面許可，不可部份複製。

This document is issued by the Company subject to its General Conditions of Service printed overleaf, available on request or accessible at <http://www.sgs.com.tw/Terms-and-Conditions> and for electronic format documents, subject to Terms and Conditions for Electronic Documents at <http://www.sgs.com.tw/Terms-and-Conditions>. Attention is drawn to the limitation of liability, indemnification and jurisdiction issues defined therein. Any holder of this document is advised that information contained hereon reflects the Company's findings at the time of its intervention only and within the limits of Client's instructions, if any. The Company's sole responsibility is to its Client and this document does not exonerate parties to a transaction from exercising all their rights and obligations under the transaction documents. This document cannot be reproduced except in full, without prior written approval of the Company. Any unauthorized alteration, forgery or falsification of the content or appearance of this document is unlawful and offenders may be prosecuted to the fullest extent of the law.

•Case 18 in table 5-10 .

**TA-SAR Conducted power
Scenario 8, Tech: LTE, Band2
/ Tech: NR FR1, Band5**

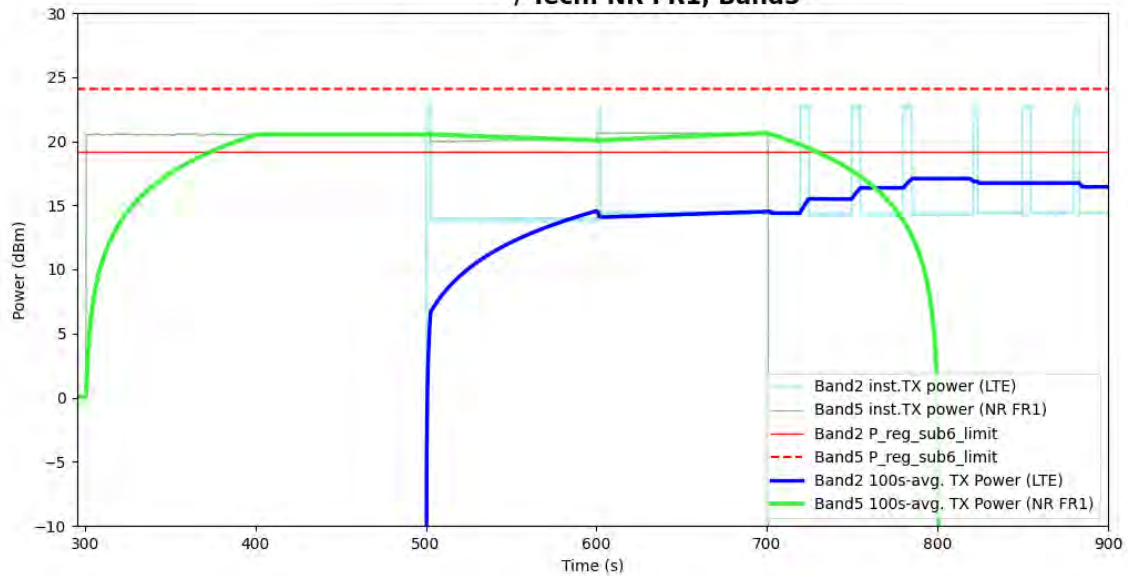

Figure 5- 54 Time-averaged conducted TX power over time for case 18 (LTE B2, sub6 NR n5)

Unless otherwise stated the results shown in this test report refer only to the sample(s) tested and such sample(s) are retained for 90 days only.

除非另有說明，此報告結果僅對測試之樣品負責，同時此樣品僅保留90天。本報告未經本公司書面許可，不可部份複製。

This document is issued by the Company subject to its General Conditions of Service printed overleaf, available on request or accessible at <http://www.sgs.com.tw/Terms-and-Conditions> and for electronic format documents, subject to Terms and Conditions for Electronic Documents at <http://www.sgs.com.tw/Terms-and-Conditions>. Attention is drawn to the limitation of liability, indemnification and jurisdiction issues defined therein. Any holder of this document is advised that information contained hereon reflects the Company's findings at the time of its intervention only and within the limits of Client's instructions, if any. The Company's sole responsibility is to its Client and this document does not exonerate parties to a transaction from exercising all their rights and obligations under the transaction documents. This document cannot be reproduced except in full, without prior written approval of the Company. Any unauthorized alteration, forgery or falsification of the content or appearance of this document is unlawful and offenders may be prosecuted to the fullest extent of the law.

**Total normalized Time-averaged RF exposure
Scenario 8, Tech: LTE, Band2
/ Tech: NR FR1, Band5**

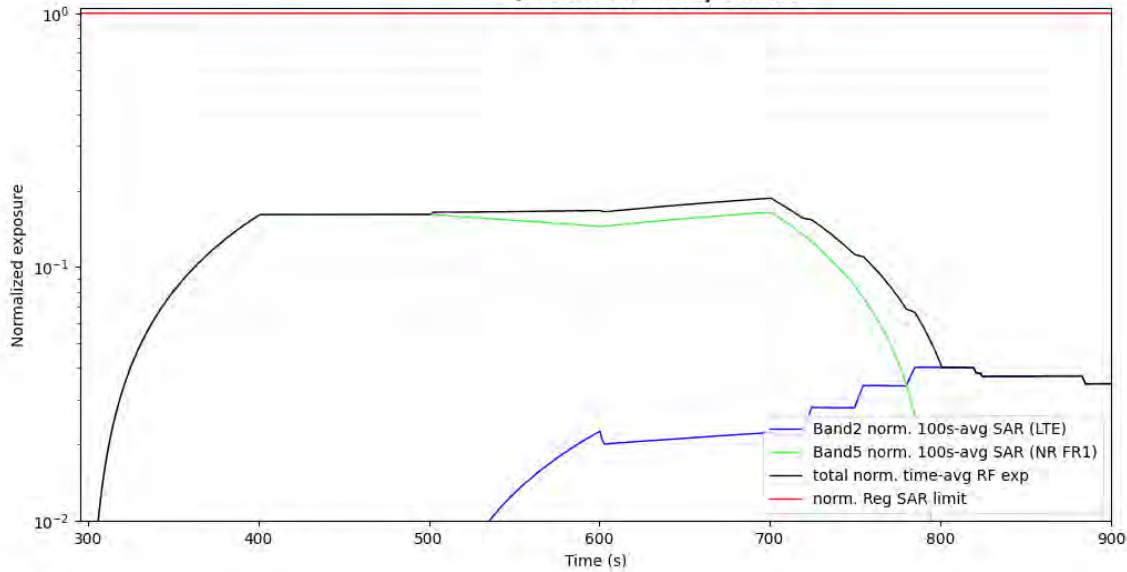

Figure 5- 55 Normalized time-averaged SAR for case 18 (LTE B2, sub6 NR n5)

FCC limit of total RF exposure (normalized)	1.0
Max total normalized time-averaged RF exposure	0.187
Validation result: pass	

Unless otherwise stated the results shown in this test report refer only to the sample(s) tested and such sample(s) are retained for 90 days only.

除非另有說明，此報告結果僅對測試之樣品負責，同時此樣品僅保留90天。本報告未經本公司書面許可，不可部份複製。

This document is issued by the Company subject to its General Conditions of Service printed overleaf, available on request or accessible at <http://www.sgs.com.tw/Terms-and-Conditions> and for electronic format documents, subject to Terms and Conditions for Electronic Documents at <http://www.sgs.com.tw/Terms-and-Conditions>. Attention is drawn to the limitation of liability, indemnification and jurisdiction issues defined therein. Any holder of this document is advised that information contained hereon reflects the Company's findings at the time of its intervention only and within the limits of Client's instructions, if any. The Company's sole responsibility is to its Client and this document does not exonerate parties to a transaction from exercising all their rights and obligations under the transaction documents. This document cannot be reproduced except in full, without prior written approval of the Company. Any unauthorized alteration, forgery or falsification of the content or appearance of this document is unlawful and offenders may be prosecuted to the fullest extent of the law.

6 TA-SAR Validation via SAR Measurements

6.4 Measurement Setup

The measurement setup is similar to normal fixed power SAR measurement. The difference in SAR measurement setup for time averaging feature validation is that the call box operates under the close loop power control mode and is connected to the PC, so that the PC can control the call box based on the test sequence to configure EUT's TX target power. The same test procedure used in conducted power setup for time-varying TX power measurement is also used in this section for time-averaging SAR measurements. Since the SAR chamber is an uncontrolled environment, the path loss between call box antenna and the EUT are well calibrated. The test setup is illustrated in Figure 6-1.

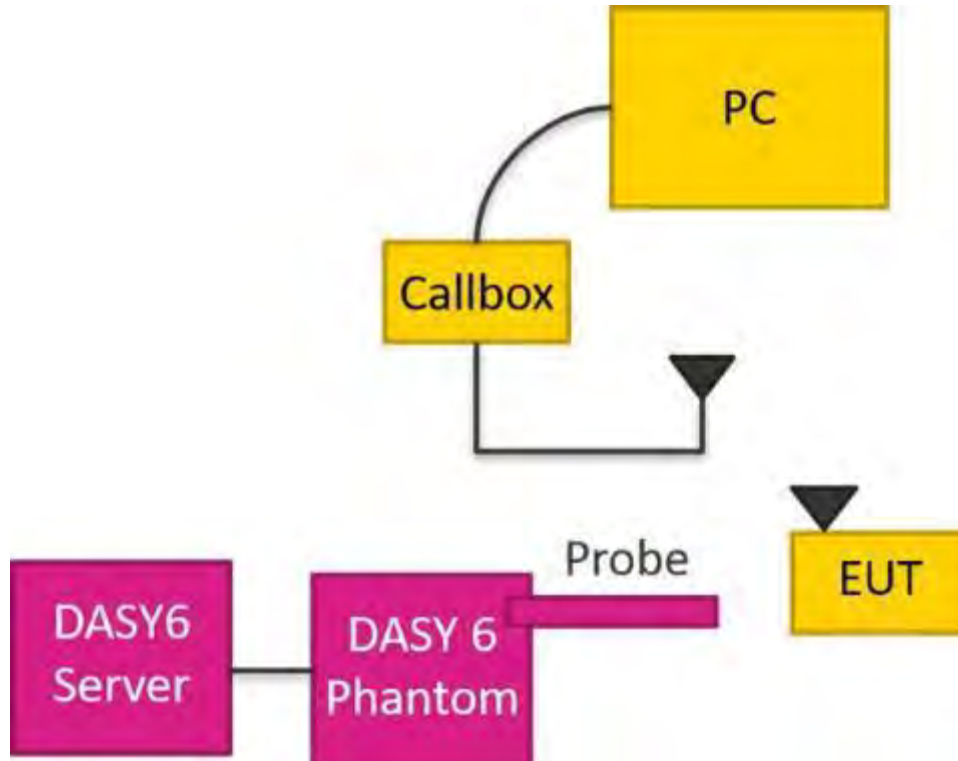

Figure 6-1 TA-SAR wireless test environment

Unless otherwise stated the results shown in this test report refer only to the sample(s) tested and such sample(s) are retained for 90 days only.

除非另有說明，此報告結果僅對測試之樣品負責，同時此樣品僅保留90天。本報告未經本公司書面許可，不可部份複製。

This document is issued by the Company subject to its General Conditions of Service printed overleaf, available on request or accessible at <http://www.sgs.com.tw/Terms-and-Conditions> and for electronic format documents, subject to Terms and Conditions for Electronic Documents at <http://www.sgs.com.tw/Terms-and-Conditions>. Attention is drawn to the limitation of liability, indemnification and jurisdiction issues defined therein. Any holder of this document is advised that information contained hereon reflects the Company's findings at the time of its intervention only and within the limits of Client's instructions, if any. The Company's sole responsibility is to its Client and this document does not exonerate parties to a transaction from exercising all their rights and obligations under the transaction documents. This document cannot be reproduced except in full, without prior written approval of the Company. Any unauthorized alteration, forgery or falsification of the content or appearance of this document is unlawful and offenders may be prosecuted to the fullest extent of the law.

6.5 SAR Measurement Results for Scenario 2: Time-Varying TX Power

In this scenario, Mediatek's TA-SAR algorithm is tested under more dynamic power test sequences. The test sequence #1 is shown in section 4.1 and test sequence #2 is tabulated in table 4.4. All of the test cases for this scenario are relegated in Table 6-1, and the test procedure follows section 4.10.2. The measurement setup is shown in Figure 6-1, 6-2(a) and 6-2(b). All of the measurements are conduct by using DASY6. The high-level summary of the final validation results is given in the last column of the table, which concludes that Mediatek's TA-SAR algorithm can maintain the time-averaged SAR is always below the FCC requirement for all test cases. The following sections will demonstrate case-by-case to show how Mediatek's TA-SAR algorithm behaves for each RAT.

Table 6-1 Operating parameters for different TA-SAR parameters setting

Test case	RAT	Test band	Test seq.	ECI	Max power (dBm)	P_{sub6_limit} (dBm)	$P_{LowThres}$ (dBm)	$P_{UE_backoff}$ (dBm)	$P_{UE_max_cust}$ (dBm)	Pass /Fail SAR limit
1	2G	GPRS 850 4Tx	1	2	28.00	27.00	26.50	24.00	28.00	Pass
2	WCDMA	Band 2	1	2	22.00	20.00	19.50	17.00	22.00	Pass
3	WCDMA	Band 4	1	2	23.00	20.00	19.50	17.00	23.00	Pass
4	LTE	Band 2	1	2	23.00	17.50	17.00	14.50	23.00	Pass
5	LTE	Band 66	1	2	24.00	18.50	18.00	15.50	24.00	Pass
6	FR1	n66	1	2	24.00	17.50	17.00	14.50	24.00	Pass
7	FR1	n5	1	2	24.00	23.00	22.50	20.00	24.00	Pass
8	2G	GPRS 850 4Tx	2	2	28.00	27.00	26.50	24.00	28.00	Pass
9	WCDMA	Band 2	2	2	22.00	20.00	19.50	17.00	22.00	Pass
10	WCDMA	Band 4	2	2	23.00	20.00	19.50	17.00	23.00	Pass
11	LTE	Band 2	2	2	23.00	17.50	17.00	14.50	23.00	Pass
12	LTE	Band 66	2	2	24.00	18.50	18.00	15.50	24.00	Pass
13	FR1	n66	2	2	24.00	17.50	17.00	14.50	24.00	Pass
14	FR1	n5	2	2	24.00	23.00	22.50	20.00	24.00	Pass

Unless otherwise stated the results shown in this test report refer only to the sample(s) tested and such sample(s) are retained for 90 days only.

除非另有說明，此報告結果僅對測試之樣品負責，同時此樣品僅保留90天。本報告未經本公司書面許可，不可部份複製。

This document is issued by the Company subject to its General Conditions of Service printed overleaf, available on request or accessible at <http://www.sgs.com.tw/Terms-and-Conditions> and for electronic format documents, subject to Terms and Conditions for Electronic Documents at <http://www.sgs.com.tw/Terms-and-Conditions>. Attention is drawn to the limitation of liability, indemnification and jurisdiction issues defined therein. Any holder of this document is advised that information contained hereon reflects the Company's findings at the time of its intervention only and within the limits of Client's instructions, if any. The Company's sole responsibility is to its Client and this document does not exonerate parties to a transaction from exercising all their rights and obligations under the transaction documents. This document cannot be reproduced except in full, without prior written approval of the Company. Any unauthorized alteration, forgery or falsification of the content or appearance of this document is unlawful and offenders may be prosecuted to the fullest extent of the law.

6.2.1 SAR Measurement results for NR

- Case 6 in table 6-1: NR n66 result for test sequence 1

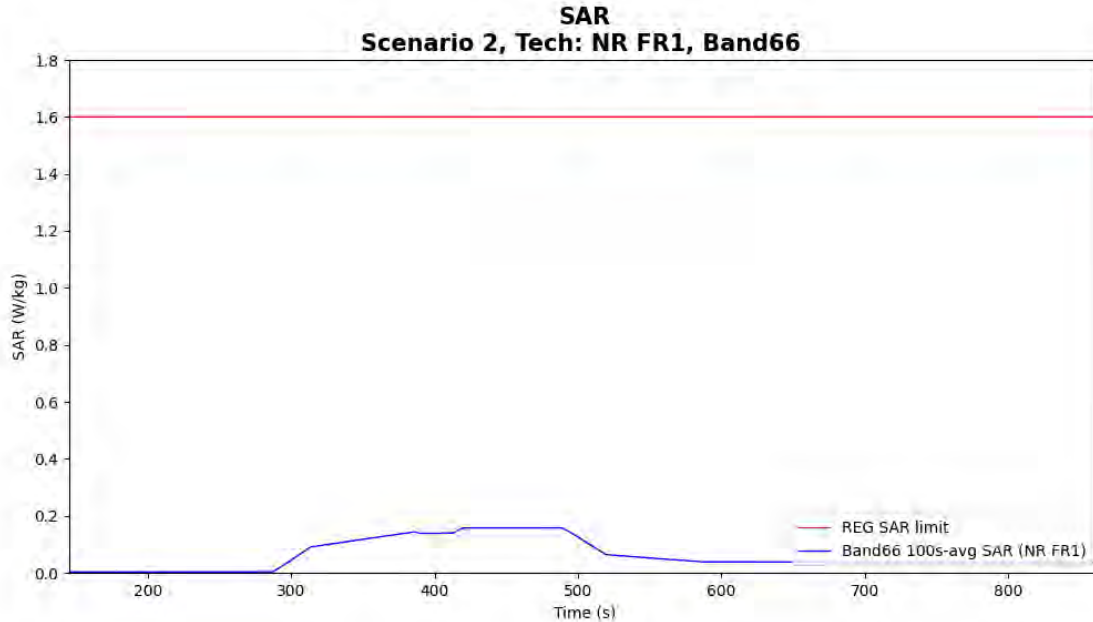

Figure 6-3 Time-averaged SAR for case 6 in table 6-1 (sub6 NR n66)

FCC 1gSAR limit	1.6 W/kg
Max 100s-time averaged 1gSAR	0.158 W/kg
Validation result: pass	

Unless otherwise stated the results shown in this test report refer only to the sample(s) tested and such sample(s) are retained for 90 days only.

除非另有說明，此報告結果僅對測試之樣品負責，同時此樣品僅保留90天。本報告未經本公司書面許可，不可部份複製。

This document is issued by the Company subject to its General Conditions of Service printed overleaf, available on request or accessible at <http://www.sgs.com.tw/Terms-and-Conditions> and for electronic format documents, subject to Terms and Conditions for Electronic Documents at <http://www.sgs.com.tw/Terms-and-Conditions>. Attention is drawn to the limitation of liability, indemnification and jurisdiction issues defined therein. Any holder of this document is advised that information contained hereon reflects the Company's findings at the time of its intervention only and within the limits of Client's instructions, if any. The Company's sole responsibility is to its Client and this document does not exonerate parties to a transaction from exercising all their rights and obligations under the transaction documents. This document cannot be reproduced except in full, without prior written approval of the Company. Any unauthorized alteration, forgery or falsification of the content or appearance of this document is unlawful and offenders may be prosecuted to the fullest extent of the law.

•Case 7 in table 6-1: NR n5 result for test sequence 1

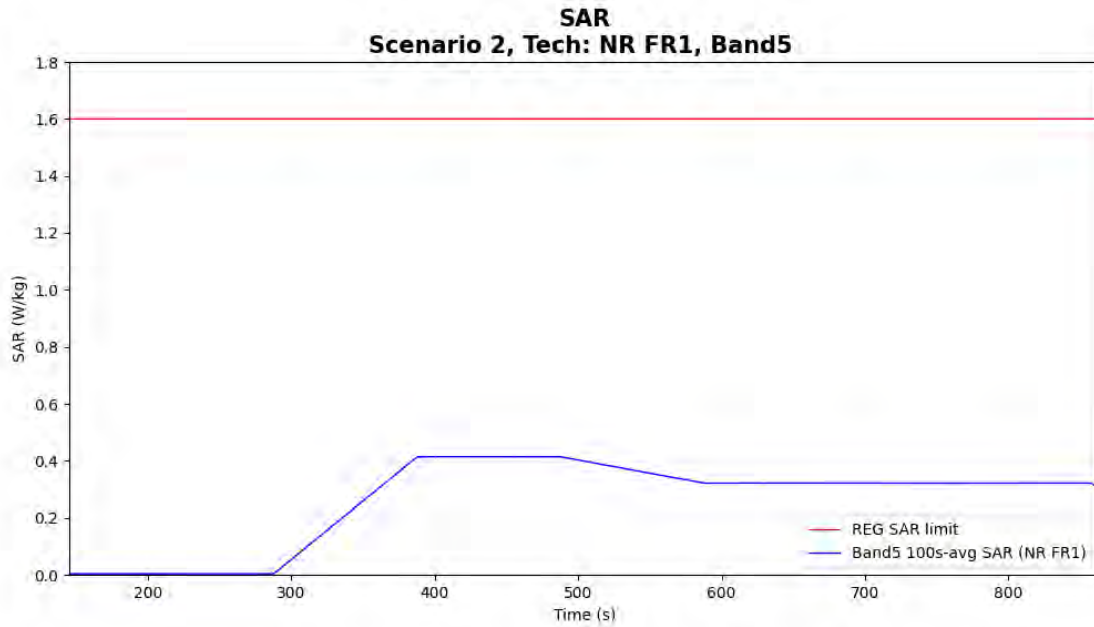

Figure 6-4 Time-averaged SAR for case 7 in table 6-1 (sub6 NR n5)

FCC 1gSAR limit	1.6 W/kg
Max 100s-time averaged 1gSAR	0.415 W/kg
Validation result:	pass

Unless otherwise stated the results shown in this test report refer only to the sample(s) tested and such sample(s) are retained for 90 days only.

除非另有說明，此報告結果僅對測試之樣品負責，同時此樣品僅保留90天。本報告未經本公司書面許可，不可部份複製。

This document is issued by the Company subject to its General Conditions of Service printed overleaf, available on request or accessible at <http://www.sgs.com.tw/Terms-and-Conditions> and for electronic format documents, subject to Terms and Conditions for Electronic Documents at <http://www.sgs.com.tw/Terms-and-Conditions>. Attention is drawn to the limitation of liability, indemnification and jurisdiction issues defined therein. Any holder of this document is advised that information contained hereon reflects the Company's findings at the time of its intervention only and within the limits of Client's instructions, if any. The Company's sole responsibility is to its Client and this document does not exonerate parties to a transaction from exercising all their rights and obligations under the transaction documents. This document cannot be reproduced except in full, without prior written approval of the Company. Any unauthorized alteration, forgery or falsification of the content or appearance of this document is unlawful and offenders may be prosecuted to the fullest extent of the law.

•Case 13 in table 6-1: NR n66 result for test sequence 2

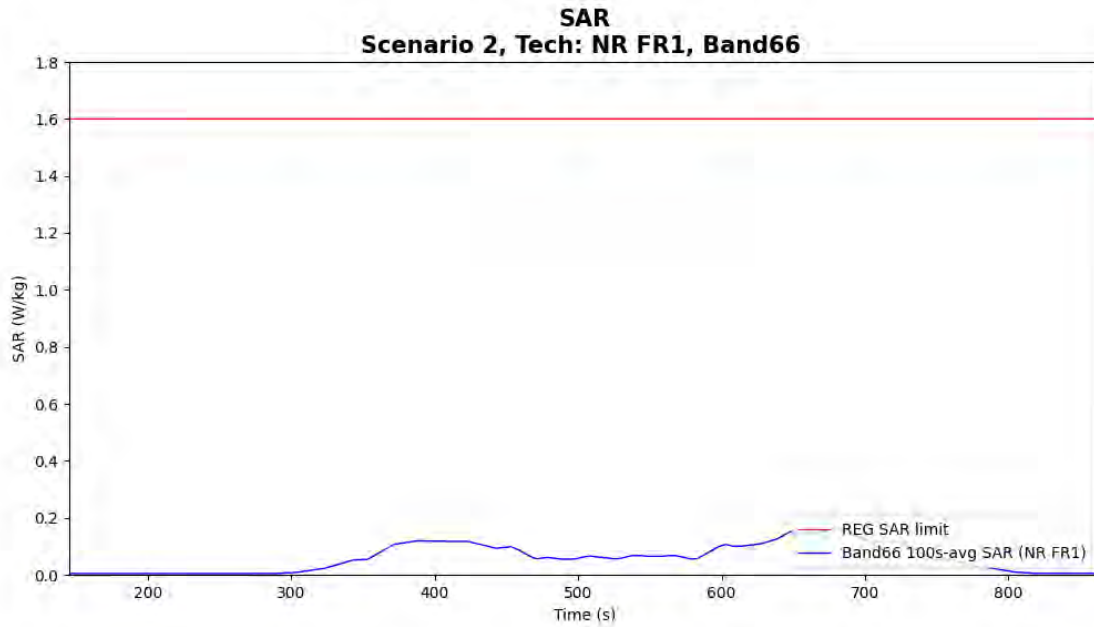

Figure 6-5 Time-averaged SAR for case 13 in table 6-1 (sub6 NR n66)

FCC 1gSAR limit	1.6 W/kg
Max 100s-time averaged 1gSAR	0.160 W/kg
Validation result: pass	

Unless otherwise stated the results shown in this test report refer only to the sample(s) tested and such sample(s) are retained for 90 days only.

除非另有說明，此報告結果僅對測試之樣品負責，同時此樣品僅保留90天。本報告未經本公司書面許可，不可部份複製。

This document is issued by the Company subject to its General Conditions of Service printed overleaf, available on request or accessible at <http://www.sgs.com.tw/Terms-and-Conditions> and for electronic format documents, subject to Terms and Conditions for Electronic Documents at <http://www.sgs.com.tw/Terms-and-Conditions>. Attention is drawn to the limitation of liability, indemnification and jurisdiction issues defined therein. Any holder of this document is advised that information contained hereon reflects the Company's findings at the time of its intervention only and within the limits of Client's instructions, if any. The Company's sole responsibility is to its Client and this document does not exonerate parties to a transaction from exercising all their rights and obligations under the transaction documents. This document cannot be reproduced except in full, without prior written approval of the Company. Any unauthorized alteration, forgery or falsification of the content or appearance of this document is unlawful and offenders may be prosecuted to the fullest extent of the law.

•Case 14 in table 6-1: NR n5 result for test sequence 2

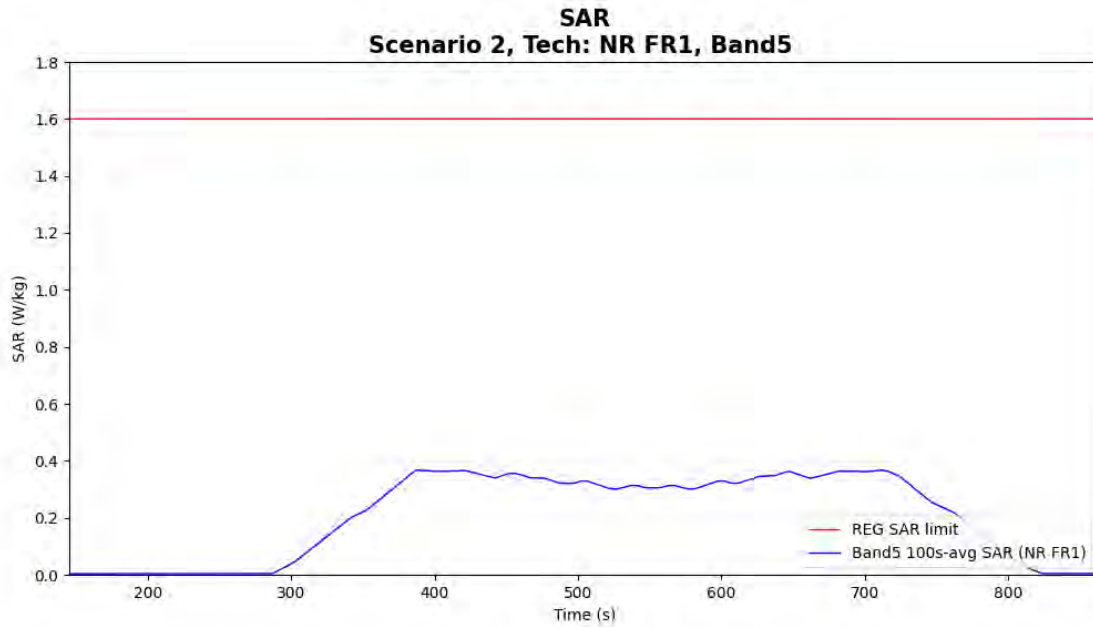

Figure 6-6 Time-averaged SAR for case 14 in table 6-1 (sub6 NR n5)

FCC 1gSAR limit	1.6 W/kg
Max 100s-time averaged 1gSAR	0.367 W/kg
Validation result: pass	

Unless otherwise stated the results shown in this test report refer only to the sample(s) tested and such sample(s) are retained for 90 days only.

除非另有說明，此報告結果僅對測試之樣品負責，同時此樣品僅保留90天。本報告未經本公司書面許可，不可部份複製。

This document is issued by the Company subject to its General Conditions of Service printed overleaf, available on request or accessible at <http://www.sgs.com.tw/Terms-and-Conditions> and for electronic format documents, subject to Terms and Conditions for Electronic Documents at <http://www.sgs.com.tw/Terms-and-Conditions>. Attention is drawn to the limitation of liability, indemnification and jurisdiction issues defined therein. Any holder of this document is advised that information contained hereon reflects the Company's findings at the time of its intervention only and within the limits of Client's instructions, if any. The Company's sole responsibility is to its Client and this document does not exonerate parties to a transaction from exercising all their rights and obligations under the transaction documents. This document cannot be reproduced except in full, without prior written approval of the Company. Any unauthorized alteration, forgery or falsification of the content or appearance of this document is unlawful and offenders may be prosecuted to the fullest extent of the law.

6.2.2 SAR Measurement results for LTE

•Case 4 in table 6-1: LTE B2 result for test sequence 1

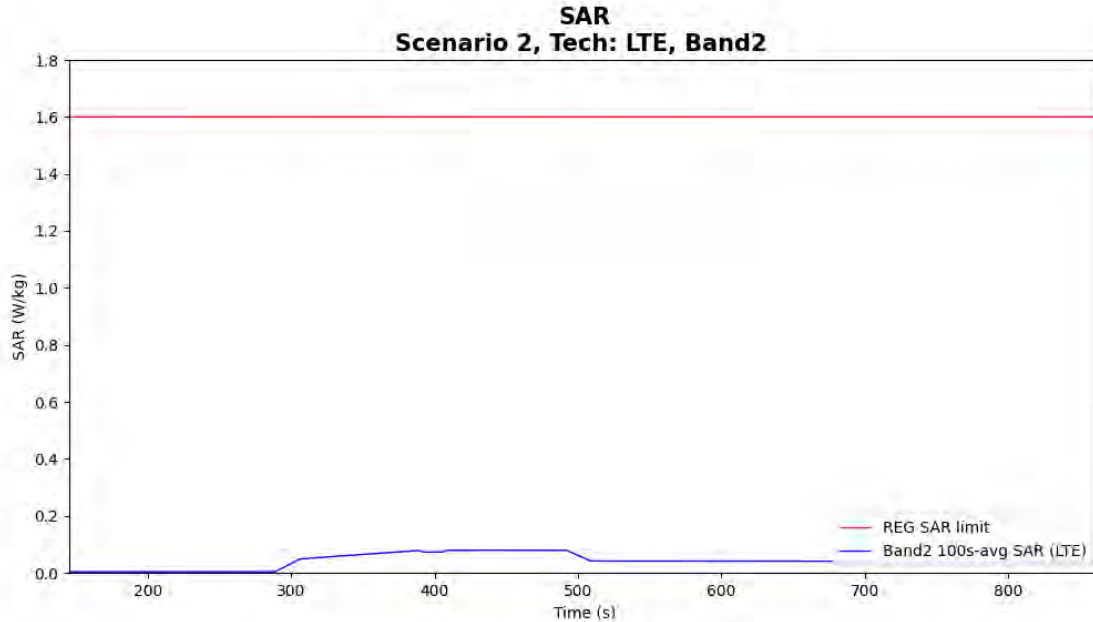

Figure 6-7 Time-averaged SAR for case 4 in table 6-1 (LTE B2)

FCC 1gSAR limit	1.6 W/kg
Max 100s-time averaged 1gSAR	0.079 W/kg
Validation result: pass	

Unless otherwise stated the results shown in this test report refer only to the sample(s) tested and such sample(s) are retained for 90 days only.

除非另有說明，此報告結果僅對測試之樣品負責，同時此樣品僅保留90天。本報告未經本公司書面許可，不可部份複製。

This document is issued by the Company subject to its General Conditions of Service printed overleaf, available on request or accessible at <http://www.sgs.com.tw/Terms-and-Conditions> and for electronic format documents, subject to Terms and Conditions for Electronic Documents at <http://www.sgs.com.tw/Terms-and-Conditions>. Attention is drawn to the limitation of liability, indemnification and jurisdiction issues defined therein. Any holder of this document is advised that information contained hereon reflects the Company's findings at the time of its intervention only and within the limits of Client's instructions, if any. The Company's sole responsibility is to its Client and this document does not exonerate parties to a transaction from exercising all their rights and obligations under the transaction documents. This document cannot be reproduced except in full, without prior written approval of the Company. Any unauthorized alteration, forgery or falsification of the content or appearance of this document is unlawful and offenders may be prosecuted to the fullest extent of the law.

•Case 5 in table 6-1: LTE B66 result for test sequence 2

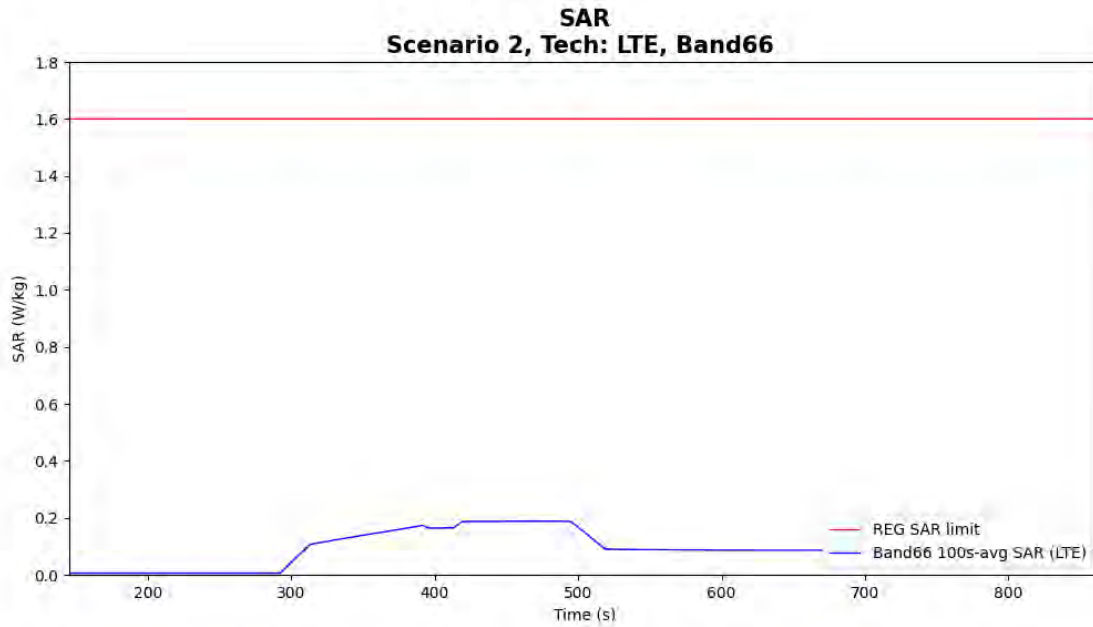

Figure 6-8 Time-averaged SAR for case 5 in table 6-1 (LTE B66)

FCC 1gSAR limit	1.6 W/kg
Max 100s-time averaged 1gSAR	0.188 W/kg
Validation result: pass	

Unless otherwise stated the results shown in this test report refer only to the sample(s) tested and such sample(s) are retained for 90 days only.

除非另有說明，此報告結果僅對測試之樣品負責，同時此樣品僅保留90天。本報告未經本公司書面許可，不可部份複製。

This document is issued by the Company subject to its General Conditions of Service printed overleaf, available on request or accessible at <http://www.sgs.com.tw/Terms-and-Conditions> and for electronic format documents, subject to Terms and Conditions for Electronic Documents at <http://www.sgs.com.tw/Terms-and-Conditions>. Attention is drawn to the limitation of liability, indemnification and jurisdiction issues defined therein. Any holder of this document is advised that information contained hereon reflects the Company's findings at the time of its intervention only and within the limits of Client's instructions, if any. The Company's sole responsibility is to its Client and this document does not exonerate parties to a transaction from exercising all their rights and obligations under the transaction documents. This document cannot be reproduced except in full, without prior written approval of the Company. Any unauthorized alteration, forgery or falsification of the content or appearance of this document is unlawful and offenders may be prosecuted to the fullest extent of the law.

•Case 11 in table 6-1: LTE B2 result for test sequence 2

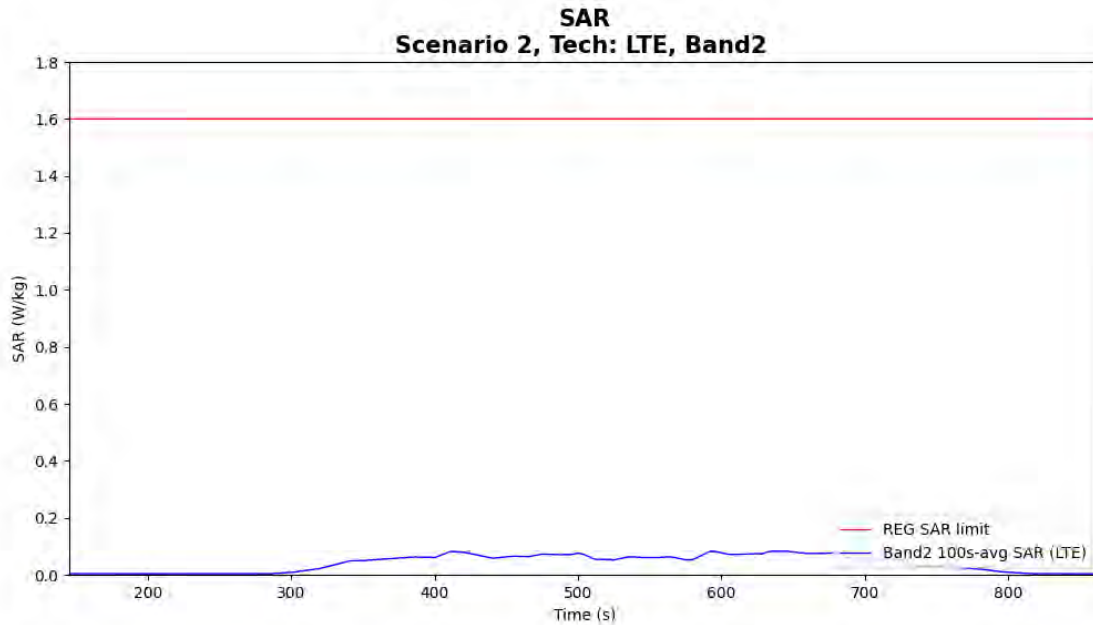

Figure 6-9 Time-averaged SAR for case 11 in table 6-1 (LTE B2)

FCC 1gSAR limit	1.6 W/kg
Max 100s-time averaged 1gSAR	0.083 W/kg
Validation result: pass	

Unless otherwise stated the results shown in this test report refer only to the sample(s) tested and such sample(s) are retained for 90 days only.

除非另有說明，此報告結果僅對測試之樣品負責，同時此樣品僅保留90天。本報告未經本公司書面許可，不可部份複製。

This document is issued by the Company subject to its General Conditions of Service printed overleaf, available on request or accessible at <http://www.sgs.com.tw/Terms-and-Conditions> and for electronic format documents, subject to Terms and Conditions for Electronic Documents at <http://www.sgs.com.tw/Terms-and-Conditions>. Attention is drawn to the limitation of liability, indemnification and jurisdiction issues defined therein. Any holder of this document is advised that information contained hereon reflects the Company's findings at the time of its intervention only and within the limits of Client's instructions, if any. The Company's sole responsibility is to its Client and this document does not exonerate parties to a transaction from exercising all their rights and obligations under the transaction documents. This document cannot be reproduced except in full, without prior written approval of the Company. Any unauthorized alteration, forgery or falsification of the content or appearance of this document is unlawful and offenders may be prosecuted to the fullest extent of the law.

•Case 12 in table 6-1: LTE B66 result for test sequence 2

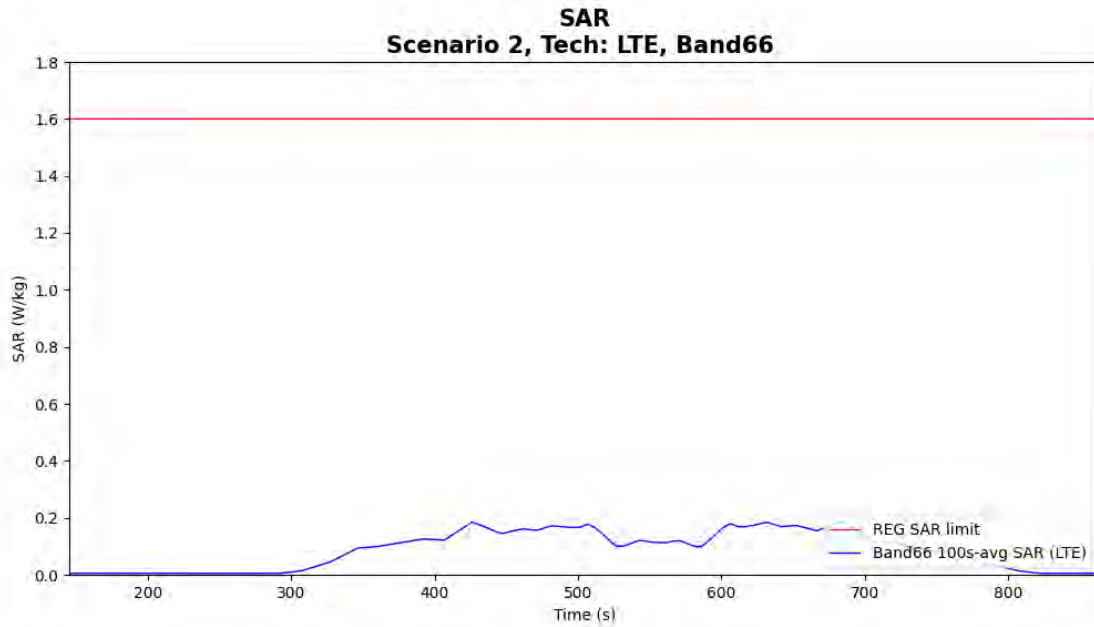

Figure 6-10 Time-averaged SAR for case 12 in table 6-1 (LTE B66)

FCC 1gSAR limit	1.6 W/kg
Max 100s-time averaged 1gSAR	0.185 W/kg
Validation result: pass	

Unless otherwise stated the results shown in this test report refer only to the sample(s) tested and such sample(s) are retained for 90 days only.

除非另有說明，此報告結果僅對測試之樣品負責，同時此樣品僅保留90天。本報告未經本公司書面許可，不可部份複製。

This document is issued by the Company subject to its General Conditions of Service printed overleaf, available on request or accessible at <http://www.sgs.com.tw/Terms-and-Conditions> and for electronic format documents, subject to Terms and Conditions for Electronic Documents at <http://www.sgs.com.tw/Terms-and-Conditions>. Attention is drawn to the limitation of liability, indemnification and jurisdiction issues defined therein. Any holder of this document is advised that information contained hereon reflects the Company's findings at the time of its intervention only and within the limits of Client's instructions, if any. The Company's sole responsibility is to its Client and this document does not exonerate parties to a transaction from exercising all their rights and obligations under the transaction documents. This document cannot be reproduced except in full, without prior written approval of the Company. Any unauthorized alteration, forgery or falsification of the content or appearance of this document is unlawful and offenders may be prosecuted to the fullest extent of the law.

6.2.3 SAR Measurement results for 3G WCDMA

- Case 2 in table 6-1: WCDMA B2 result for test sequence 1

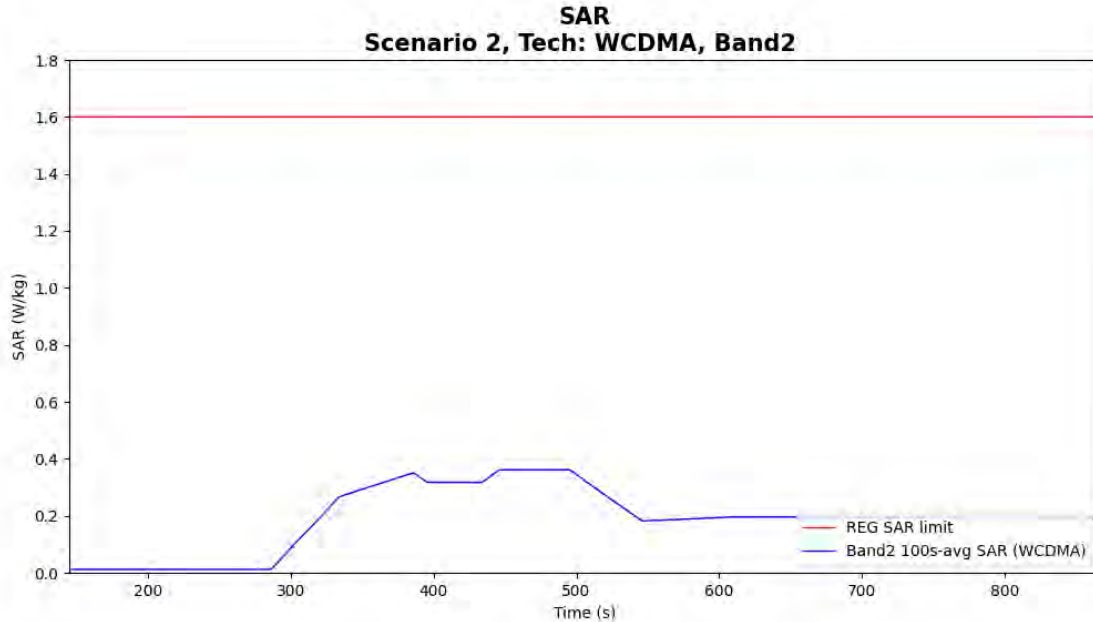

Figure 6-11 Time-averaged SAR for case 2 in table 6-1 (WCDMA B2)

FCC 1gSAR limit	1.6 W/kg
Max 100s-time averaged 1gSAR	0.362 W/kg
Validation result: pass	

Unless otherwise stated the results shown in this test report refer only to the sample(s) tested and such sample(s) are retained for 90 days only.

除非另有說明，此報告結果僅對測試之樣品負責，同時此樣品僅保留90天。本報告未經本公司書面許可，不可部份複製。

This document is issued by the Company subject to its General Conditions of Service printed overleaf, available on request or accessible at <http://www.sgs.com.tw/Terms-and-Conditions> and for electronic format documents, subject to Terms and Conditions for Electronic Documents at <http://www.sgs.com.tw/Terms-and-Conditions>. Attention is drawn to the limitation of liability, indemnification and jurisdiction issues defined therein. Any holder of this document is advised that information contained hereon reflects the Company's findings at the time of its intervention only and within the limits of Client's instructions, if any. The Company's sole responsibility is to its Client and this document does not exonerate parties to a transaction from exercising all their rights and obligations under the transaction documents. This document cannot be reproduced except in full, without prior written approval of the Company. Any unauthorized alteration, forgery or falsification of the content or appearance of this document is unlawful and offenders may be prosecuted to the fullest extent of the law.

•Case 3 in table 6-1: WCDMA B4 result for test sequence 1

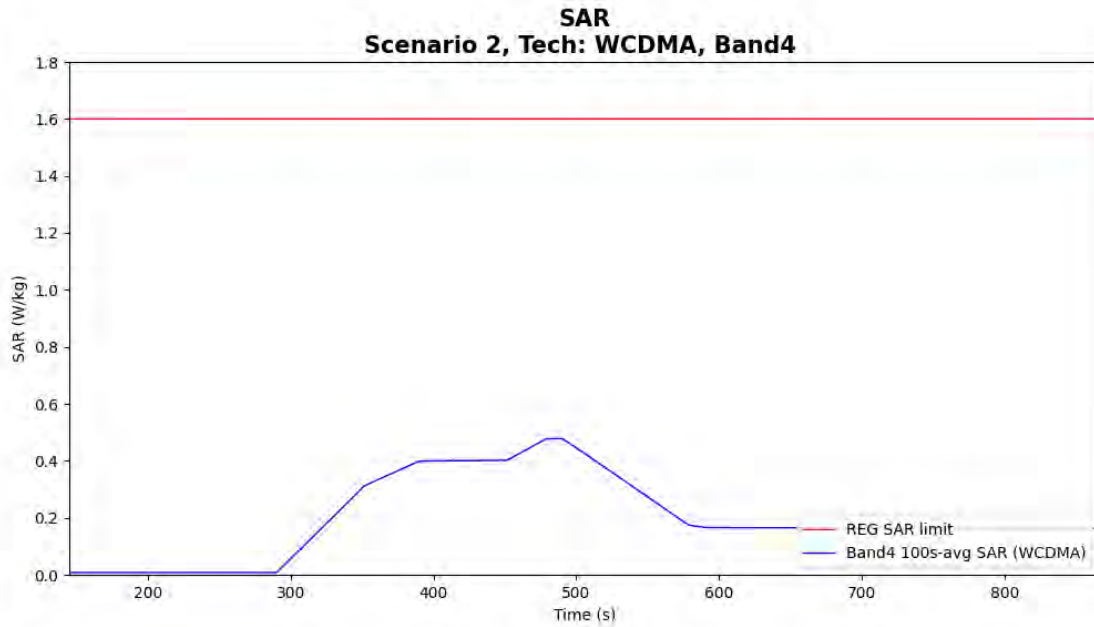

Figure 6-12 Time-averaged SAR for case 3 in table 6-1 (WCDMA B4)

FCC 1gSAR limit	1.6 W/kg
Max 100s-time averaged 1gSAR	0.478 W/kg
Validation result: pass	

Unless otherwise stated the results shown in this test report refer only to the sample(s) tested and such sample(s) are retained for 90 days only.

除非另有說明，此報告結果僅對測試之樣品負責，同時此樣品僅保留90天。本報告未經本公司書面許可，不可部份複製。

This document is issued by the Company subject to its General Conditions of Service printed overleaf, available on request or accessible at <http://www.sgs.com.tw/Terms-and-Conditions> and for electronic format documents, subject to Terms and Conditions for Electronic Documents at <http://www.sgs.com.tw/Terms-and-Conditions>. Attention is drawn to the limitation of liability, indemnification and jurisdiction issues defined therein. Any holder of this document is advised that information contained hereon reflects the Company's findings at the time of its intervention only and within the limits of Client's instructions, if any. The Company's sole responsibility is to its Client and this document does not exonerate parties to a transaction from exercising all their rights and obligations under the transaction documents. This document cannot be reproduced except in full, without prior written approval of the Company. Any unauthorized alteration, forgery or falsification of the content or appearance of this document is unlawful and offenders may be prosecuted to the fullest extent of the law.

•Case 9 in table 6-1: WCDMA B2 result for test sequence 1

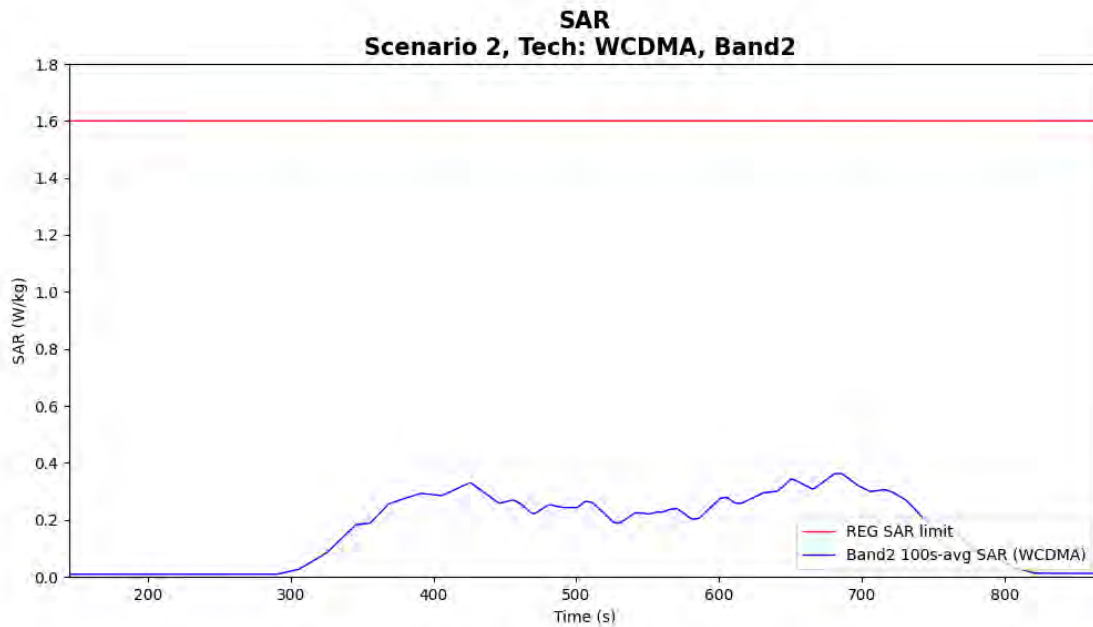

Figure 6-13 Time-averaged SAR for case 9 in table 6-1 (WCDMA B2)

FCC 1gSAR limit	1.6 W/kg
Max 100s-time averaged 1gSAR	0.362 W/kg
Validation result: pass	

Unless otherwise stated the results shown in this test report refer only to the sample(s) tested and such sample(s) are retained for 90 days only.

除非另有說明，此報告結果僅對測試之樣品負責，同時此樣品僅保留90天。本報告未經本公司書面許可，不可部份複製。

This document is issued by the Company subject to its General Conditions of Service printed overleaf, available on request or accessible at <http://www.sgs.com.tw/Terms-and-Conditions> and for electronic format documents, subject to Terms and Conditions for Electronic Documents at <http://www.sgs.com.tw/Terms-and-Conditions>. Attention is drawn to the limitation of liability, indemnification and jurisdiction issues defined therein. Any holder of this document is advised that information contained hereon reflects the Company's findings at the time of its intervention only and within the limits of Client's instructions, if any. The Company's sole responsibility is to its Client and this document does not exonerate parties to a transaction from exercising all their rights and obligations under the transaction documents. This document cannot be reproduced except in full, without prior written approval of the Company. Any unauthorized alteration, forgery or falsification of the content or appearance of this document is unlawful and offenders may be prosecuted to the fullest extent of the law.

•Case 10 in table 6-1: WCDMA B4 result for test sequence 2

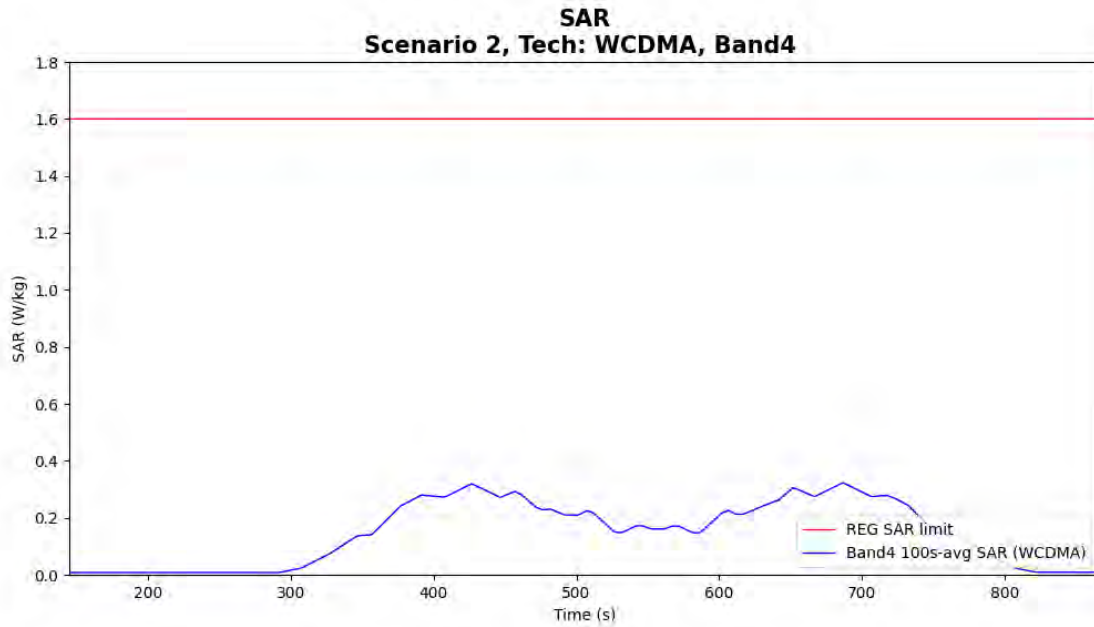

Figure 6-14 Time-averaged SAR for case 10 in table 6-1 (WCDMA B4)

FCC 1gSAR limit	1.6 W/kg
Max 100s-time averaged 1gSAR	0.323 W/kg
Validation result: pass	

Unless otherwise stated the results shown in this test report refer only to the sample(s) tested and such sample(s) are retained for 90 days only.

除非另有說明，此報告結果僅對測試之樣品負責，同時此樣品僅保留90天。本報告未經本公司書面許可，不可部份複製。

This document is issued by the Company subject to its General Conditions of Service printed overleaf, available on request or accessible at <http://www.sgs.com.tw/Terms-and-Conditions> and for electronic format documents, subject to Terms and Conditions for Electronic Documents at <http://www.sgs.com.tw/Terms-and-Conditions>. Attention is drawn to the limitation of liability, indemnification and jurisdiction issues defined therein. Any holder of this document is advised that information contained hereon reflects the Company's findings at the time of its intervention only and within the limits of Client's instructions, if any. The Company's sole responsibility is to its Client and this document does not exonerate parties to a transaction from exercising all their rights and obligations under the transaction documents. This document cannot be reproduced except in full, without prior written approval of the Company. Any unauthorized alteration, forgery or falsification of the content or appearance of this document is unlawful and offenders may be prosecuted to the fullest extent of the law.

6.2.5 SAR Measurement results for 2G

- Case 1 in table 6-1: 2G GPRS 850 4Tx result for test sequence 1

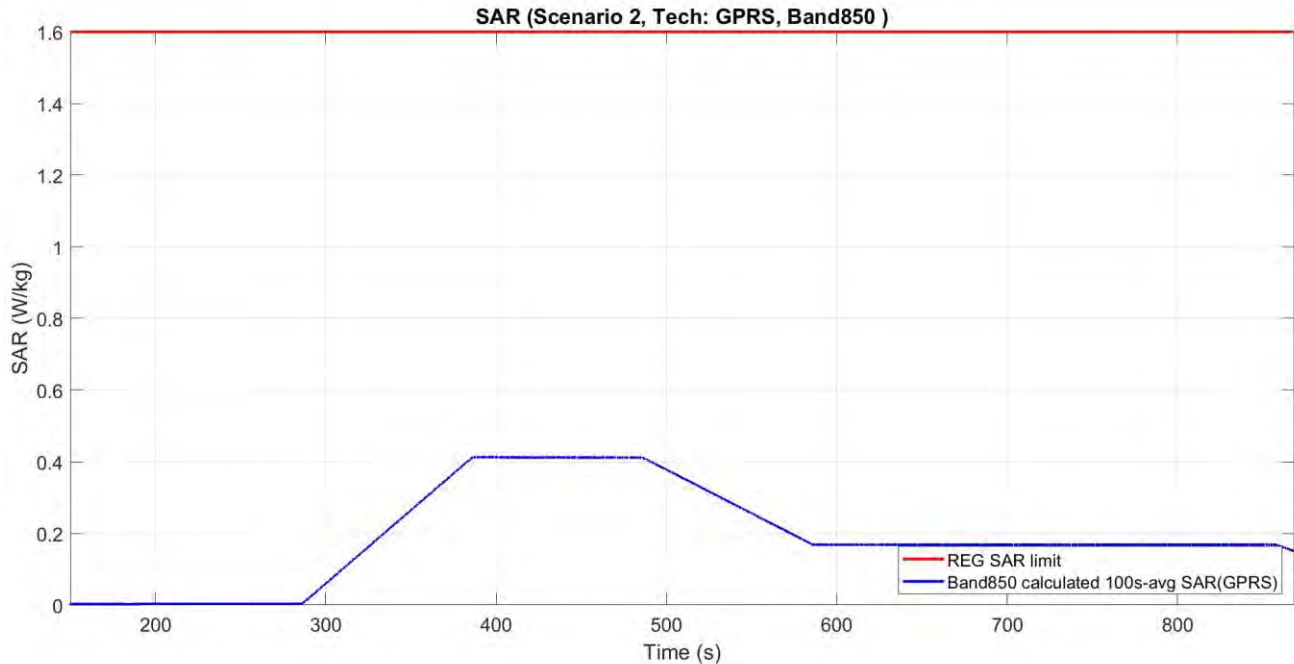

Figure 6-17 Time-averaged SAR for case 1 in table 6-1 (2G GPRS 850 4Tx)

FCC 1gSAR limit	1.6 W/kg
Max 100s-time averaged 1gSAR	0.413 W/kg
Validation result: pass	

Unless otherwise stated the results shown in this test report refer only to the sample(s) tested and such sample(s) are retained for 90 days only.

除非另有說明，此報告結果僅對測試之樣品負責，同時此樣品僅保留90天。本報告未經本公司書面許可，不可部份複製。

This document is issued by the Company subject to its General Conditions of Service printed overleaf, available on request or accessible at <http://www.sgs.com.tw/Terms-and-Conditions> and for electronic format documents, subject to Terms and Conditions for Electronic Documents at <http://www.sgs.com.tw/Terms-and-Conditions>. Attention is drawn to the limitation of liability, indemnification and jurisdiction issues defined therein. Any holder of this document is advised that information contained hereon reflects the Company's findings at the time of its intervention only and within the limits of Client's instructions, if any. The Company's sole responsibility is to its Client and this document does not exonerate parties to a transaction from exercising all their rights and obligations under the transaction documents. This document cannot be reproduced except in full, without prior written approval of the Company. Any unauthorized alteration, forgery or falsification of the content or appearance of this document is unlawful and offenders may be prosecuted to the fullest extent of the law.

•Case 8 in table 6-1: 2G GPRS 850 4Tx result for test sequence 2

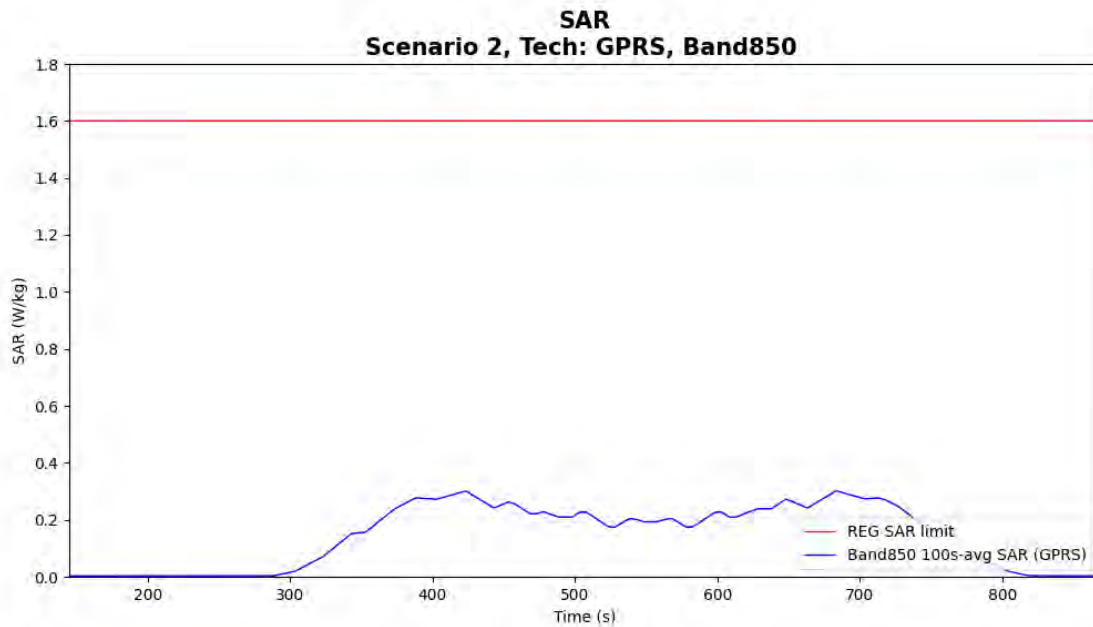

Figure 6-18 Time-averaged SAR for case 8 in table 6-1 (2G GPRS 850 4Tx)

FCC 1gSAR limit	1.6 W/kg
Max 100s-time averaged 1gSAR	0.301 W/kg
Validation result: pass	

Unless otherwise stated the results shown in this test report refer only to the sample(s) tested and such sample(s) are retained for 90 days only.

除非另有說明，此報告結果僅對測試之樣品負責，同時此樣品僅保留90天。本報告未經本公司書面許可，不可部份複製。

This document is issued by the Company subject to its General Conditions of Service printed overleaf, available on request or accessible at <http://www.sgs.com.tw/Terms-and-Conditions> and for electronic format documents, subject to Terms and Conditions for Electronic Documents at <http://www.sgs.com.tw/Terms-and-Conditions>. Attention is drawn to the limitation of liability, indemnification and jurisdiction issues defined therein. Any holder of this document is advised that information contained hereon reflects the Company's findings at the time of its intervention only and within the limits of Client's instructions, if any. The Company's sole responsibility is to its Client and this document does not exonerate parties to a transaction from exercising all their rights and obligations under the transaction documents. This document cannot be reproduced except in full, without prior written approval of the Company. Any unauthorized alteration, forgery or falsification of the content or appearance of this document is unlawful and offenders may be prosecuted to the fullest extent of the law.

7 Conclusions

This document proposes TA-SAR test scenarios and procedures, and further proves Mediatek's TA-SAR algorithms can meet the FCC SAR regulations with the proposed test scenarios and procedures. As shown in Chapters 6 and 8, Mediatek's TA-SAR algorithms are able to maintain SAR over time below the FCC regulatory limits (based on the agreed TX-power-to-SAR translation). Furthermore, the near-field measurements are also done in an FCC certified lab to further validate the proposed test methodologies, and the results shown demonstrate that Mediatek's TA-SAR algorithms really can maintain SAR over time below the FCC regulatory limits under the proposed test procedures. Based on the provided measurement evidence, it is concluded that Mediatek's TA-SAR algorithms can be tested by using the proposed test methodology for FCC compliance.

Unless otherwise stated the results shown in this test report refer only to the sample(s) tested and such sample(s) are retained for 90 days only.

除非另有說明，此報告結果僅對測試之樣品負責，同時此樣品僅保留90天。本報告未經本公司書面許可，不可部份複製。

This document is issued by the Company subject to its General Conditions of Service printed overleaf, available on request or accessible at <http://www.sgs.com.tw/Terms-and-Conditions> and for electronic format documents, subject to Terms and Conditions for Electronic Documents at <http://www.sgs.com.tw/Terms-and-Conditions>. Attention is drawn to the limitation of liability, indemnification and jurisdiction issues defined therein. Any holder of this document is advised that information contained hereon reflects the Company's findings at the time of its intervention only and within the limits of Client's instructions, if any. The Company's sole responsibility is to its Client and this document does not exonerate parties to a transaction from exercising all their rights and obligations under the transaction documents. This document cannot be reproduced except in full, without prior written approval of the Company. Any unauthorized alteration, forgery or falsification of the content or appearance of this document is unlawful and offenders may be prosecuted to the fullest extent of the law.

Appendix A. cDASY6 System Verification

EX3DV4 E-Field Probe

Construction	Symmetrical design with triangular core Built-in shielding against static charges PEEK enclosure material (resistant to organic solvents, e.g., DGBE)	
Calibration	Basic Broad Band Calibration in air Conversion Factors (CF) for HSL 835/1750/1900 MHz Additional CF for other liquids and frequencies upon request	
Frequency	10 MHz to > 6 GHz	
Directivity	± 0.3 dB in HSL (rotation around probe axis) ± 0.5 dB in tissue material (rotation normal to probe axis)	
Dynamic Range	10 μ W/g to > 100 mW/g Linearity: ± 0.2 dB (noise: typically < 1 μ W/g)	
Dimensions	Tip diameter: 2.5 mm	
Application	High precision dosimetric measurements in any exposure scenario (e.g., very strong gradient fields). Only probe which enables compliance testing for frequencies up to 6 GHz with precision of better 30%.	

Unless otherwise stated the results shown in this test report refer only to the sample(s) tested and such sample(s) are retained for 90 days only.

除非另有說明，此報告結果僅對測試之樣品負責，同時此樣品僅保留90天。本報告未經本公司書面許可，不可部份複製。

This document is issued by the Company subject to its General Conditions of Service printed overleaf, available on request or accessible at <http://www.sgs.com.tw/Terms-and-Conditions> and for electronic format documents, subject to Terms and Conditions for Electronic Documents at <http://www.sgs.com.tw/Terms-and-Conditions>. Attention is drawn to the limitation of liability, indemnification and jurisdiction issues defined therein. Any holder of this document is advised that information contained hereon reflects the Company's findings at the time of its intervention only and within the limits of Client's instructions, if any. The Company's sole responsibility is to its Client and this document does not exonerate parties to a transaction from exercising all their rights and obligations under the transaction documents. This document cannot be reproduced except in full, without prior written approval of the Company. Any unauthorized alteration, forgery or falsification of the content or appearance of this document is unlawful and offenders may be prosecuted to the fullest extent of the law.

Phantom

Model	Twin SAM	
Construction	<p>The shell corresponds to the specifications of the Specific Anthropomorphic Mannequin (SAM) phantom defined in IEEE 1528 and IEC 62209.</p> <p>It enables the dosimetric evaluation of left and right hand phone usage as well as body mounted usage at the flat phantom region. A cover prevents evaporation of the liquid. Reference markings on the phantom allow the complete setup of all predefined phantom positions and measurement grids by manually teaching three points with the robot.</p>	
Shell Thickness	2 ± 0.2 mm	
Filling Volume	Approx. 25 liters	
Dimensions	Height: 850 mm; Length: 1000 mm; Width: 500 mm	

DEVICE HOLDER

Construction	<p>In combination with the Twin SAM Phantom V4.0/V4.0C or Twin SAM, the Mounting Device (made from POM) enables the rotation of the mounted transmitter in spherical coordinates, whereby the rotation point is the ear opening. The devices can be easily and accurately positioned according to IEC, IEEE, CENELEC, FCC or other specifications. The device holder can be locked at different phantom locations (left head, right head, flat phantom).</p>	 <p style="text-align: center;">Device Holder</p>
--------------	--	--

Unless otherwise stated the results shown in this test report refer only to the sample(s) tested and such sample(s) are retained for 90 days only.

除非另有說明，此報告結果僅對測試之樣品負責，同時此樣品僅保留90天。本報告未經本公司書面許可，不可部份複製。

This document is issued by the Company subject to its General Conditions of Service printed overleaf, available on request or accessible at <http://www.sgs.com.tw/Terms-and-Conditions> and for electronic format documents, subject to Terms and Conditions for Electronic Documents at <http://www.sgs.com.tw/Terms-and-Conditions>. Attention is drawn to the limitation of liability, indemnification and jurisdiction issues defined therein. Any holder of this document is advised that information contained hereon reflects the Company's findings at the time of its intervention only and within the limits of Client's instructions, if any. The Company's sole responsibility is to its Client and this document does not exonerate parties to a transaction from exercising all their rights and obligations under the transaction documents. This document cannot be reproduced except in full, without prior written approval of the Company. Any unauthorized alteration, forgery or falsification of the content or appearance of this document is unlawful and offenders may be prosecuted to the fullest extent of the law.

Appendix B. Instruments List

Equipment List					
Manufacturer	Device	Type	Serial number	Date of last calibration	Date of next calibration
SPEAG	Data acquisition Electronics	DAE4	856	Apr/26/2023	Apr/25/2024
SPEAG	Dosimetric E-Field Probe	EX3DV4	7712	Apr/14/2023	Apr/13/2024
SPEAG	System Validation Dipole	D835V2	4d063	Sep/20/2023	Sep/19/2024
SPEAG	System Validation Dipole	D1750V2	1158	Aug/25/2023	Aug/24/2024
SPEAG	System Validation Dipole	D1900V2	5d173	Apr/26/2023	Apr/25/2024
SPEAG	Dielectric Assessment Kit	DAKS-3.5	1053	Feb/27/2023	Feb/26/2024
R&S	MXG Analog Signal Generator	SMB100A03	182012	May/23/2023	May/22/2024
Agilent	Dual-directional coupler	772D	MY52180142	Oct/23/2023	Oct/22/2024
Agilent	Dual-directional coupler	778D	MY52180302	Oct/23/2023	Oct/22/2024
EMCI	Amplifier	ZHL-42	980189	Calibration not required	Calibration not required
EMCI	Amplifier	ZVE-8G	980190	Calibration not required	Calibration not required
R&S	Power Sensor	NRP18S	109065	Oct/23/2023	Oct/22/2024
R&S	Power Meter	NRX	102034	Jan/11/2023	Jan/10/2024
R&S	Power Sensor	NRP18S	109066	Oct/23/2023	Oct/22/2024
SPEAG	Software	DASY 6 V16.0.2.136	N/A	Calibration not required	Calibration not required
SPEAG	Phantom	SAM	N/A	Calibration not required	Calibration not required
R&S	Radio Communication Test	CMW 500	165070	Oct/21/2023	Oct/20/2024
Keysight	UXM 5G Wireless Test Platform	E7515B	MY60101215	Feb/07/2023	Feb/06/2024
TECPEL	Digital thermometer	DTM-303A	TP130075	Jan/11/2023	Jan/10/2024

Unless otherwise stated the results shown in this test report refer only to the sample(s) tested and such sample(s) are retained for 90 days only.

除非另有說明，此報告結果僅對測試之樣品負責，同時此樣品僅保留90天。本報告未經本公司書面許可，不可部份複製。

This document is issued by the Company subject to its General Conditions of Service printed overleaf, available on request or accessible at <http://www.sgs.com.tw/Terms-and-Conditions> and for electronic format documents, subject to Terms and Conditions for Electronic Documents at <http://www.sgs.com.tw/Terms-and-Conditions>. Attention is drawn to the limitation of liability, indemnification and jurisdiction issues defined therein. Any holder of this document is advised that information contained hereon reflects the Company's findings at the time of its intervention only and within the limits of Client's instructions, if any. The Company's sole responsibility is to its Client and this document does not exonerate parties to a transaction from exercising all their rights and obligations under the transaction documents. This document cannot be reproduced except in full, without prior written approval of the Company. Any unauthorized alteration, forgery or falsification of the content or appearance of this document is unlawful and offenders may be prosecuted to the fullest extent of the law.

Appendix C Tissue and System Verification

• Tissue Verification

The following tissue formulations are provided for reference only as some of the parameters have not been thoroughly verified. The composition of ingredients may be modified accordingly to achieve the desired target tissue parameters required for routine SAR evaluation.

The composition of the brain tissue simulating liquid is:

Simulating Liquids for 600 MHz -10 GHz, Manufactured by SPEAG:

Broad-band head tissue simulating liquids	SPEAG Product	Frequency range (MHz)	Main Ingredients
	HBBL600-10000V6	600 - 10000	Water, Oil

• Tissue Simulant Fluid for the Frequency Band

The dielectric properties for this Head-simulant fluid were measured by using the SPEAG Dielectric Assessment Kit (DAKS-3.5)

All dielectric parameters of tissue simulates were measured within 24 hours of SAR measurements. The measured conductivity and permittivity are all within $\pm 5\%$ of the target values.

The depth of the tissue simulant in the flat section of the phantom was $\geq 15 \text{ cm} \pm 5 \text{ mm}$ during all tests. (Fig. 2)

Measured Frequency (MHz)	Target Dielectric Constant, ϵ_r	Target Conductivity, σ (S/m)	Measured Dielectric Constant, ϵ_r	Measured Conductivity, σ (S/m)	% dev ϵ_r	% dev σ	Limit	Measurement Date	Liquid Temp. ($^{\circ}\text{C}$)	Ambient Temp ($^{\circ}\text{C}$)
835	41.500	0.900	40.501	0.891	-2.41%	-1.00%	$\pm 5\%$	Oct. 24, 2023	22.1	22.4
836.5	41.500	0.902	40.496	0.895	-2.42%	-0.73%	$\pm 5\%$	Oct. 24, 2023	22.1	22.4
848.8	41.500	0.915	40.483	0.907	-2.45%	-0.86%	$\pm 5\%$	Oct. 24, 2023	22.1	22.4
1712.4	40.125	1.350	40.359	1.319	0.58%	-2.29%	$\pm 5\%$	Oct. 25, 2023	22.2	22.6
1720	40.114	1.354	40.347	1.326	0.58%	-2.09%	$\pm 5\%$	Oct. 25, 2023	22.2	22.6
1745	40.079	1.369	40.345	1.328	0.66%	-2.96%	$\pm 5\%$	Oct. 25, 2023	22.2	22.6
1750	40.071	1.371	40.329	1.338	0.64%	-2.44%	$\pm 5\%$	Oct. 25, 2023	22.2	22.6
1860	40.000	1.400	39.345	1.439	-1.64%	2.79%	$\pm 5\%$	Oct. 26, 2023	21.7	22.1
1900	40.000	1.400	39.318	1.462	-1.71%	4.43%	$\pm 5\%$	Oct. 26, 2023	21.7	22.1
1907.6	40.000	1.400	39.313	1.465	-1.72%	4.64%	$\pm 5\%$	Oct. 26, 2023	21.7	22.1

Unless otherwise stated the results shown in this test report refer only to the sample(s) tested and such sample(s) are retained for 90 days only.

除非另有說明，此報告結果僅對測試之樣品負責，同時此樣品僅保留90天。本報告未經本公司書面許可，不可部份複製。

This document is issued by the Company subject to its General Conditions of Service printed overleaf, available on request or accessible at <http://www.sgs.com.tw/Terms-and-Conditions> and for electronic format documents, subject to Terms and Conditions for Electronic Documents at <http://www.sgs.com.tw/Terms-and-Conditions>. Attention is drawn to the limitation of liability, indemnification and jurisdiction issues defined therein. Any holder of this document is advised that information contained hereon reflects the Company's findings at the time of its intervention only and within the limits of Client's instructions, if any. The Company's sole responsibility is to its Client and this document does not exonerate parties to a transaction from exercising all their rights and obligations under the transaction documents. This document cannot be reproduced except in full, without prior written approval of the Company. Any unauthorized alteration, forgery or falsification of the content or appearance of this document is unlawful and offenders may be prosecuted to the fullest extent of the law.

• System Verification

The microwave circuit arrangement for system verification is sketched in Fig. b. The daily system accuracy verification occurs within the flat section of the SAM phantom. A SAR measurement was performed to see if the measured SAR was within $\pm 10\%$ from the target SAR values. These tests were done at 1900/2600MHz. The tests were conducted on the same days as the measurement of the DUT. The obtained results from the system accuracy verification are displayed in the table 1 (SAR values are normalized to 1W forward power delivered to the dipole). During the tests, the liquid depth above the ear reference points was above 15 cm in all the cases. It is seen that the system is operating within its specification, as the results are within acceptable tolerance of the reference values.

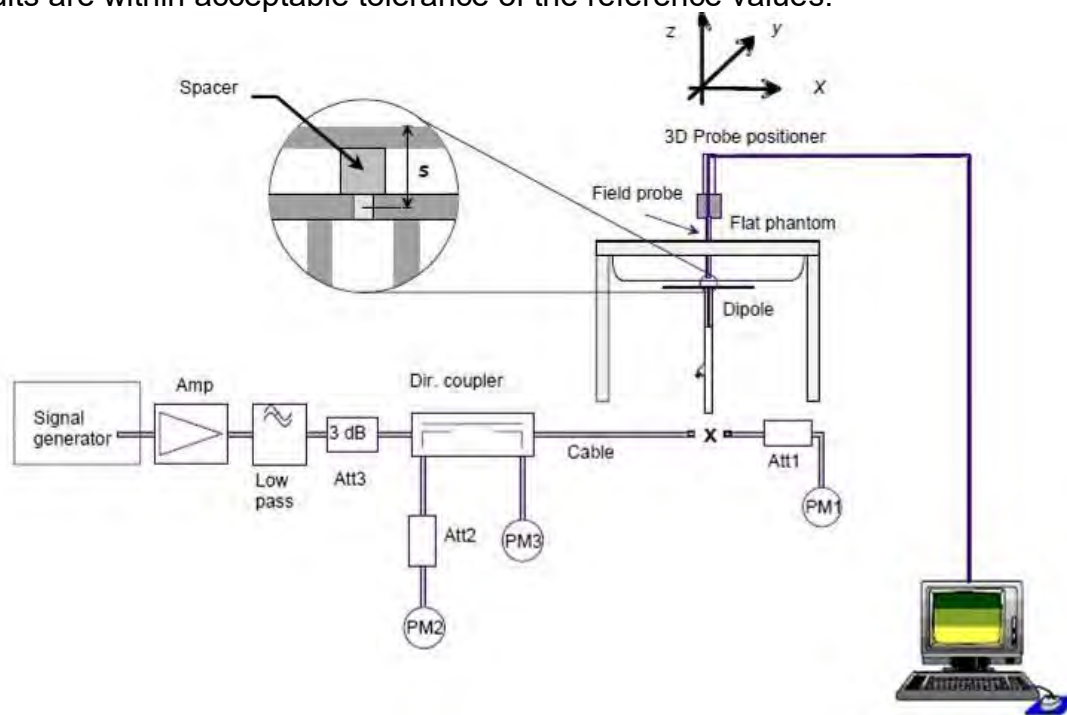

Fig. b The block diagram of system verification

Unless otherwise stated the results shown in this test report refer only to the sample(s) tested and such sample(s) are retained for 90 days only.

除非另有說明，此報告結果僅對測試之樣品負責，同時此樣品僅保留90天。本報告未經本公司書面許可，不可部份複製。

This document is issued by the Company subject to its General Conditions of Service printed overleaf, available on request or accessible at <http://www.sgs.com.tw/Terms-and-Conditions> and for electronic format documents, subject to Terms and Conditions for Electronic Documents at <http://www.sgs.com.tw/Terms-and-Conditions>. Attention is drawn to the limitation of liability, indemnification and jurisdiction issues defined therein. Any holder of this document is advised that information contained hereon reflects the Company's findings at the time of its intervention only and within the limits of Client's instructions, if any. The Company's sole responsibility is to its Client and this document does not exonerate parties to a transaction from exercising all their rights and obligations under the transaction documents. This document cannot be reproduced except in full, without prior written approval of the Company. Any unauthorized alteration, forgery or falsification of the content or appearance of this document is unlawful and offenders may be prosecuted to the fullest extent of the law.

Validation Kit	S/N	Frequency (MHz)	1W Target 1g-SAR (W/kg)	pin=250mW Measured 1g-SAR (W/kg)	Normalized to 1W 1g-SAR (W/kg)	Deviation (%)	Limit	Measurement Date
D835V2	4d063	835	9.53	2.39	9.56	0.31	± 10%	Oct.24,2023
D1750V2	1158	1750	36.8	8.71	34.84	-5.33	± 10%	Oct.25,2023
D1900V2	5d173	1900	40.3	10.2	40.8	1.24	± 10%	Oct.26,2023

Unless otherwise stated the results shown in this test report refer only to the sample(s) tested and such sample(s) are retained for 90 days only.

除非另有說明，此報告結果僅對測試之樣品負責，同時此樣品僅保留90天。本報告未經本公司書面許可，不可部份複製。

This document is issued by the Company subject to its General Conditions of Service printed overleaf, available on request or accessible at <http://www.sgs.com.tw/Terms-and-Conditions> and for electronic format documents, subject to Terms and Conditions for Electronic Documents at <http://www.sgs.com.tw/Terms-and-Conditions>. Attention is drawn to the limitation of liability, indemnification and jurisdiction issues defined therein. Any holder of this document is advised that information contained hereon reflects the Company's findings at the time of its intervention only and within the limits of Client's instructions, if any. The Company's sole responsibility is to its Client and this document does not exonerate parties to a transaction from exercising all their rights and obligations under the transaction documents. This document cannot be reproduced except in full, without prior written approval of the Company. Any unauthorized alteration, forgery or falsification of the content or appearance of this document is unlawful and offenders may be prosecuted to the fullest extent of the law.

Appendix D Measurement uncertainty

Measurement Uncertainty evaluation template for DUT SAR test (3-6G)

A	c	D	e		f	g	h=c * f / e	i=c * g / e	k
Source of Uncertainty	Tolerance/ Uncertainty	Probability Distributio	Div	Div Value	ci (1g)	ci (10g)	Standard uncertainty	Standard uncertainty	vi, or Veff
Measurement system									
Probe calibration	6.55%	N	1	1	1	1	6.55%	6.55%	∞
<i>Isotropy, Axial</i>	3.50%	R	√3	1.732	1	1	2.02%	2.02%	∞
<i>Isotropy, Hemispherical</i>	9.60%	R	√3	1.732	1	1	5.54%	5.54%	∞
Modulation Response	2.40%	R	√3	1.732	1	1	1.40%	1.40%	∞
Boundary Effect	1.00%	R	√3	1.732	1	1	0.58%	0.58%	∞
Linearity	4.70%	R	√3	1.732	1	1	2.71%	2.71%	∞
Detection Limits	1.00%	R	√3	1.732	1	1	0.58%	0.58%	∞
Readout Electronics	0.30%	N	1	1	1	1	0.30%	0.30%	∞
Response time	0.80%	R	√3	1.732	1	1	0.46%	0.46%	∞
Integration Time	2.60%	R	√3	1.732	1	1	1.50%	1.50%	∞
Measurement drift (class A evaluation)	1.75%	R	√3	1.732	1	1	1.01%	1.01%	∞
RF ambient condition - noise	3.00%	R	√3	1.732	1	1	1.73%	1.73%	∞
RF ambient conditions - reflections	3.00%	R	√3	1.732	1	1	1.73%	1.73%	∞
Probe positioner Mechanical restrictions	0.40%	R	√3	1.732	1	1	0.23%	0.23%	∞
Probe Positioning with respect to phantom shell	2.90%	R	√3	1.732	1	1	1.67%	1.67%	∞
Post-processing	1.00%	R	√3	1.732	1	1	0.58%	0.58%	∞
Max SAR Eval	1.00%	R	√3	1.732	1	1	0.58%	0.58%	∞
Test Sample related									
Test sample positioning	2.90%	N	1	1	1	1	2.90%	2.90%	M-1
Device Holder Uncertainty	3.60%	N	1	1	1	1	3.60%	3.60%	M-1
Drift of output power	5.00%	R	√3	1.732	1	1	2.89%	2.89%	∞
Phantom and Setup									
Phantom Uncertainty	4.00%	R	√3	1.732	1	1	2.31%	2.31%	∞
Liquid permittivity (mea.)	3.27%	N	1	1	0.64	0.43	2.09%	1.41%	M
Liquid Conductivity (mea.)	1.44%	N	1	1	0.6	0.49	0.86%	0.71%	M
Combined standard uncertainty		RSS					11.93%	11.81%	
Expant uncertainty (95% confidence interval), K=2							23.87%	23.62%	

Unless otherwise stated the results shown in this test report refer only to the sample(s) tested and such sample(s) are retained for 90 days only.

除非另有說明，此報告結果僅對測試之樣品負責，同時此樣品僅保留90天。本報告未經本公司書面許可，不可部份複製。

This document is issued by the Company subject to its General Conditions of Service printed overleaf, available on request or accessible at <http://www.sgs.com.tw/Terms-and-Conditions> and for electronic format documents, subject to Terms and Conditions for Electronic Documents at <http://www.sgs.com.tw/Terms-and-Conditions>. Attention is drawn to the limitation of liability, indemnification and jurisdiction issues defined therein. Any holder of this document is advised that information contained hereon reflects the Company's findings at the time of its intervention only and within the limits of Client's instructions, if any. The Company's sole responsibility is to its Client and this document does not exonerate parties to a transaction from exercising all their rights and obligations under the transaction documents. This document cannot be reproduced except in full, without prior written approval of the Company. Any unauthorized alteration, forgery or falsification of the content or appearance of this document is unlawful and offenders may be prosecuted to the fullest extent of the law.

8 SAR SYSTEM CHECK RESULTS

Date: 2023/10/24

Report No. : TESA2310000627ES

Dipole 835 MHz_SN:4d063

Communication System: CW; Frequency: 835 MHz; Duty cycle= 1:1

Medium parameters used: $f = 835 \text{ MHz}$; $\sigma = 0.891 \text{ S/m}$; $\epsilon_r = 40.501$; $\rho = 1000 \text{ kg/m}^3$

Phantom section: Flat Section

Ambient temperature: 22.4°C; Liquid temperature: 22.1°C

DASY5 Configuration:

- Probe: EX3DV4 – SN7712; ConvF(10.16, 10.16, 10.16); Calibrated: 2023/4/14
- Sensor-Surface: 2mm (Mechanical Surface Detection)
- Electronics: DAE4 Sn856; Calibrated: 2023/4/26
- Phantom: SAM
- DASY52 52.10.4(1527); SEMCAD X 14.6.14(7483)

Area Scan (51x131x1): Interpolated grid: dx=15 mm, dy=15 mm

Maximum value of SAR (interpolated) = 2.95 W/kg

Zoom Scan (7x7x7)/Cube 0: Measurement grid: dx=5mm, dy=5mm, dz=5mm

Reference Value = 60.26 V/m; Power Drift = -0.03 dB

Peak SAR (extrapolated) = 3.87 W/kg

SAR(1 g) = 2.39 W/kg; SAR(10 g) = 1.48 W/kg

Smallest distance from peaks to all points 3 dB below = 14 mm

Ratio of SAR at M2 to SAR at M1 = 62.1%

Maximum value of SAR (measured) = 3.17 W/kg

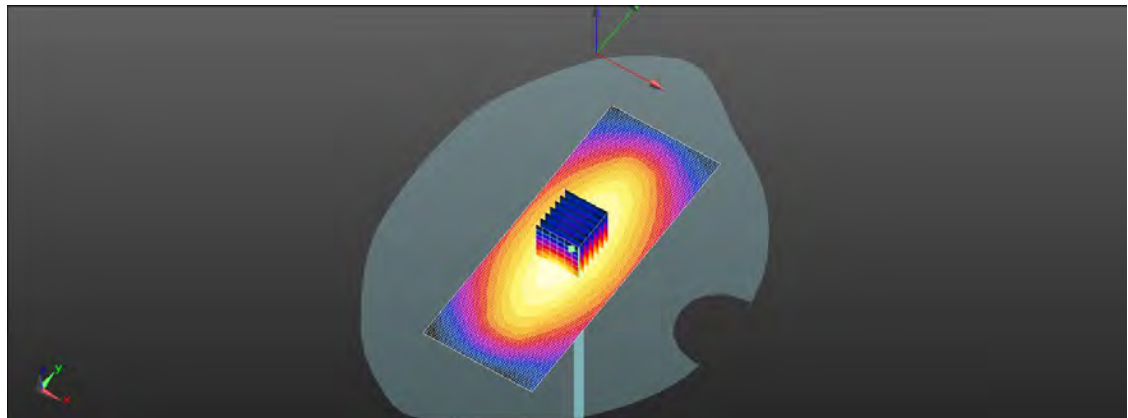
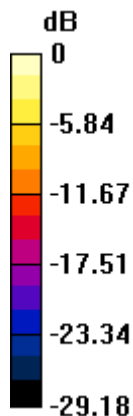

0 dB = 2.95 W/kg = 4.70 dBW/kg

Unless otherwise stated the results shown in this test report refer only to the sample(s) tested and such sample(s) are retained for 90 days only.

除非另有說明，此報告結果僅對測試之樣品負責，同時此樣品僅保留90天。本報告未經本公司書面許可，不可部份複製。

This document is issued by the Company subject to its General Conditions of Service printed overleaf, available on request or accessible at <http://www.sgs.com.tw/Terms-and-Conditions> and for electronic format documents, subject to Terms and Conditions for Electronic Documents at <http://www.sgs.com.tw/Terms-and-Conditions>. Attention is drawn to the limitation of liability, indemnification and jurisdiction issues defined therein. Any holder of this document is advised that information contained hereon reflects the Company's findings at the time of its intervention only and within the limits of Client's instructions, if any. The Company's sole responsibility is to its Client and this document does not exonerate parties to a transaction from exercising all their rights and obligations under the transaction documents. This document cannot be reproduced except in full, without prior written approval of the Company. Any unauthorized alteration, forgery or falsification of the content or appearance of this document is unlawful and offenders may be prosecuted to the fullest extent of the law.

Report No. : TESA2310000627ES

Dipole 1750 MHz_SN:1158

Communication System: CW; Frequency: 1750 MHz; Duty cycle= 1:1

Medium parameters used: $f = 1750 \text{ MHz}$; $\sigma = 1.338 \text{ S/m}$; $\epsilon_r = 40.329$; $\rho = 1000 \text{ kg/m}^3$

Phantom section: Flat Section

Ambient temperature: 22.6°C; Liquid temperature: 22.2°C

DASY5 Configuration:

- Probe: EX3DV4 – SN7712; ConvF(8.77, 8.77, 8.77); Calibrated: 2023/4/14
- Sensor-Surface: 2mm (Mechanical Surface Detection)
- Electronics: DAE4 Sn856; Calibrated: 2023/4/26
- Phantom: SAM
- DASY52 52.10.4(1527); SEMCAD X 14.6.14(7483)

Area Scan (51x101x1): Interpolated grid: dx=15 mm, dy=15 mm

Maximum value of SAR (interpolated) = 12.5 W/kg

Zoom Scan (7x7x7)/Cube 0: Measurement grid: dx=5mm, dy=5mm, dz=5mm

Reference Value = 95.22 V/m; Power Drift = -0.01 dB

Peak SAR (extrapolated) = 15.6 W/kg

SAR(1 g) = 8.71 W/kg; SAR(10 g) = 4.64 W/kg

Smallest distance from peaks to all points 3 dB below = 11 mm

Ratio of SAR at M2 to SAR at M1 = 56.2%

Maximum value of SAR (measured) = 12.3 W/kg

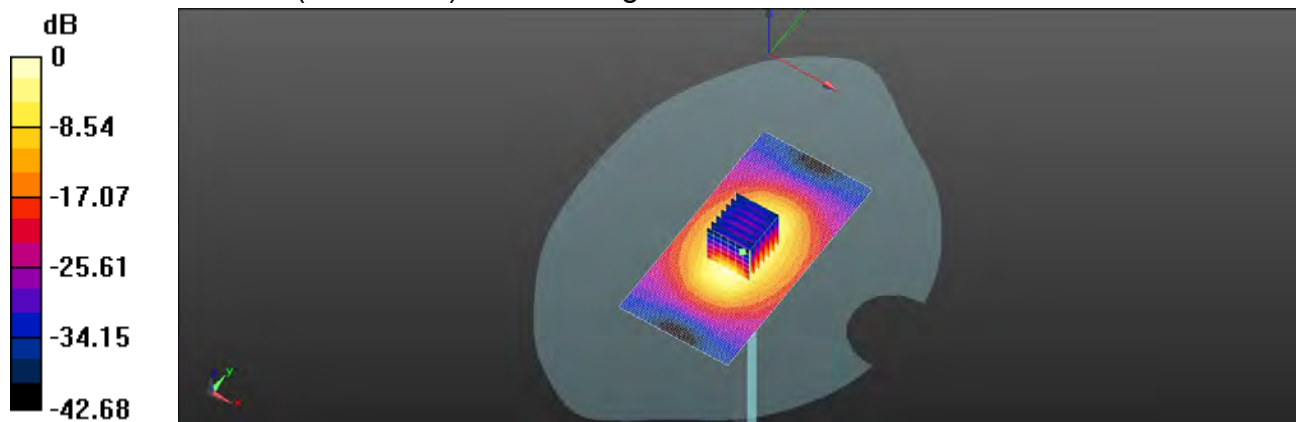

0 dB = 12.5 W/kg = 10.96 dBW/kg

Unless otherwise stated the results shown in this test report refer only to the sample(s) tested and such sample(s) are retained for 90 days only.

除非另有說明，此報告結果僅對測試之樣品負責，同時此樣品僅保留90天。本報告未經本公司書面許可，不可部份複製。

This document is issued by the Company subject to its General Conditions of Service printed overleaf, available on request or accessible at <http://www.sgs.com.tw/Terms-and-Conditions> and for electronic format documents, subject to Terms and Conditions for Electronic Documents at <http://www.sgs.com.tw/Terms-and-Conditions>. Attention is drawn to the limitation of liability, indemnification and jurisdiction issues defined therein. Any holder of this document is advised that information contained hereon reflects the Company's findings at the time of its intervention only and within the limits of Client's instructions, if any. The Company's sole responsibility is to its Client and this document does not exonerate parties to a transaction from exercising all their rights and obligations under the transaction documents. This document cannot be reproduced except in full, without prior written approval of the Company. Any unauthorized alteration, forgery or falsification of the content or appearance of this document is unlawful and offenders may be prosecuted to the fullest extent of the law.

Report No. : TESA2310000627ES

Dipole 1900 MHz_SN:5d173

Communication System: CW; Frequency: 1900 MHz; Duty cycle= 1:1

Medium parameters used: $f = 1900 \text{ MHz}$; $\sigma = 1.462 \text{ S/m}$; $\epsilon_r = 39.318$; $\rho = 1000 \text{ kg/m}^3$

Phantom section: Flat Section

Ambient temperature: 22.1°C; Liquid temperature: 21.7°C

DASY5 Configuration:

- Probe: EX3DV4 – SN7712; ConvF(8.47, 8.47, 8.47); Calibrated: 2023/4/14
- Sensor-Surface: 2mm (Mechanical Surface Detection)
- Electronics: DAE4 Sn856; Calibrated: 2023/4/26
- Phantom: SAM
- DASY52 52.10.4(1527); SEMCAD X 14.6.14(7483)

Area Scan (51x61x1): Interpolated grid: dx=15 mm, dy=15 mm

Maximum value of SAR (interpolated) = 15.3 W/kg

Zoom Scan (7x7x7)/Cube 0: Measurement grid: dx=5mm, dy=5mm, dz=5mm

Reference Value = 105.6 V/m; Power Drift = -0.02 dB

Peak SAR (extrapolated) = 18.6 W/kg

SAR(1 g) = 10.2 W/kg; SAR(10 g) = 5.42 W/kg

Smallest distance from peaks to all points 3 dB below = 10.2 mm

Ratio of SAR at M2 to SAR at M1 = 55.6%

Maximum value of SAR (measured) = 14.5 W/kg

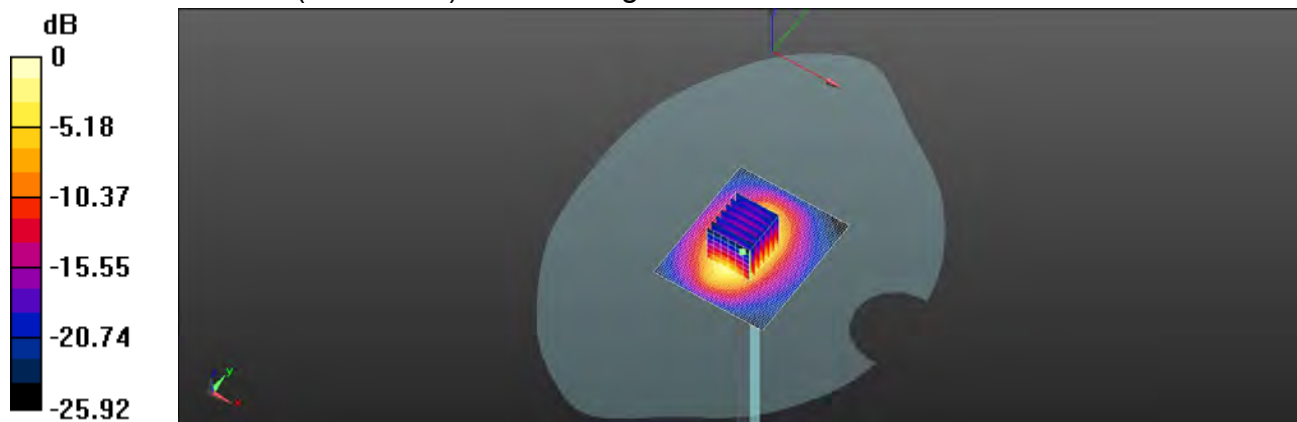

0 dB = 15.3 W/kg = 11.83 dBW/kg

Unless otherwise stated the results shown in this test report refer only to the sample(s) tested and such sample(s) are retained for 90 days only.

除非另有說明，此報告結果僅對測試之樣品負責，同時此樣品僅保留90天。本報告未經本公司書面許可，不可部份複製。

This document is issued by the Company subject to its General Conditions of Service printed overleaf, available on request or accessible at <http://www.sgs.com.tw/Terms-and-Conditions> and for electronic format documents, subject to Terms and Conditions for Electronic Documents at <http://www.sgs.com.tw/Terms-and-Conditions>. Attention is drawn to the limitation of liability, indemnification and jurisdiction issues defined therein. Any holder of this document is advised that information contained hereon reflects the Company's findings at the time of its intervention only and within the limits of Client's instructions, if any. The Company's sole responsibility is to its Client and this document does not exonerate parties to a transaction from exercising all their rights and obligations under the transaction documents. This document cannot be reproduced except in full, without prior written approval of the Company. Any unauthorized alteration, forgery or falsification of the content or appearance of this document is unlawful and offenders may be prosecuted to the fullest extent of the law.

9.APPENDIXES

Refer to separated files for the following appendixes.

9.1 SAR_Appendix E Photographs

9.2 SAR_Appendix F DAE & Probe Cal. Certificate

9.3 SAR_Appendix G Phantom Description & Dipole Cal. Certificate

- End of report -

Unless otherwise stated the results shown in this test report refer only to the sample(s) tested and such sample(s) are retained for 90 days only.

除非另有說明，此報告結果僅對測試之樣品負責，同時此樣品僅保留90天。本報告未經本公司書面許可，不可部份複製。

This document is issued by the Company subject to its General Conditions of Service printed overleaf, available on request or accessible at <http://www.sgs.com.tw/Terms-and-Conditions> and for electronic format documents, subject to Terms and Conditions for Electronic Documents at <http://www.sgs.com.tw/Terms-and-Conditions>. Attention is drawn to the limitation of liability, indemnification and jurisdiction issues defined therein. Any holder of this document is advised that information contained hereon reflects the Company's findings at the time of its intervention only and within the limits of Client's instructions, if any. The Company's sole responsibility is to its Client and this document does not exonerate parties to a transaction from exercising all their rights and obligations under the transaction documents. This document cannot be reproduced except in full, without prior written approval of the Company. Any unauthorized alteration, forgery or falsification of the content or appearance of this document is unlawful and offenders may be prosecuted to the fullest extent of the law.