

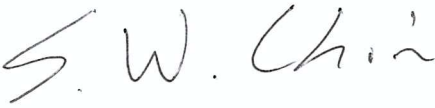

# EMC TEST REPORT

<b>Project No.</b>	LBE20210911	<b>Issue No.</b>	0
<b>Applicant</b>	<b>Name of organization</b>	Samsung Electronics Co., Ltd.	
	<b>Address</b>	(Maetan-dong) 129, Samsung-ro, Yeongtong-gu, Suwon-si, Gyeonggi-do, 16677, Korea	
	<b>Date of receipt</b>	December 24, 2021	
<b>EUT</b>	<b>Type of device</b>	<input checked="" type="checkbox"/> All other receivers subject to Part 15 <input checked="" type="checkbox"/> Class B personal computers and peripherals <input checked="" type="checkbox"/> Other Class B digital devices and peripherals <input type="checkbox"/> FM Broadcast Receiver	
	<b>Equipment authorization</b>	<input checked="" type="checkbox"/> Certification <input type="checkbox"/> Supplier's Declaration of Conformity	
	<b>FCC ID</b>	A3LSMA135FDSN	
	<b>Kind of product</b>	Mobile Phone	
	<b>Model No.</b>	SM-A135F/DSN	
	<b>Variant Model No.</b>	Refer to clause 4.6	
	<b>Manufacturer</b>	Samsung Electronics Vietnam Thai Nguyen Co., Ltd. Yen Binh Industrial Zone Pho Ten Dist., Thai Nguyen Province, Vietnam	
<b>Applied Standards</b>	47 CFR Part 15, Subpart B, Class B / ANSI C63.4-2014		
<b>Test Period</b>	December 30, 2021 ~ January 19, 2022		
<b>Issue date</b>	January 21, 2022		
<b>Test result : Complied</b>			
The equipment under test has found to be compliant with the applied standards. (Refer to the attached test result for more detail.)			
<b>Tested by</b> : Sung-Wook Choi 		<b>Reviewed by</b> : Chang-Eun Park 	
The test results in this report only apply to the tested sample. This report must not be reproduced, except in full, without written permission from Global CS center. * Not KOLAS report			
<b>Samsung Electronics Co., Ltd., Global CS Center</b> (Maetan dong) 129, Samsung-ro, Yeongtong-Gu, Suwon-Si, Gyeonggi-Do 16677, Korea			

---

# Table of Contents

<b>1. Report Information</b> .....	3
1.1 Revision history .....	3
<b>2. Summary of test results</b> .....	3
2.1 Emission.....	3
<b>3. General Information</b> .....	3
3.1 Test facility .....	3
<b>4. Test Setup configuration</b> .....	4
4.1 Test Peripherals .....	4
4.2 EUT operating mode .....	5
4.3 Details of Sampling.....	5
4.4 Used cable description .....	6
4.5 Test arrangement .....	7
4.6 EUT Description.....	10
4.7 EUT Frequencies .....	10
4.8 Test configuration and condition .....	11
4.9 Measurement uncertainty .....	11
<b>5. Results of individual test</b> .....	12
5.1 Conducted Emission .....	12
5.2 Radiated Emission .....	17

# 1. Report Information

## 1.1 Revision history

No.	Date of Issue	Revised detailed information
Issue 0	January 21, 2022	There are no revisions and this version is basic test report.

※ Remark

Only compliance with Part 15B (Section 15.107 Conducted limits) requirements for the receiver part of the licensed transmitter (equipment code CXX) is covered by this report.

# 2. Summary of test results

## 2.1 Emission

The EUT has been tested according to the following specifications:

Applied	Test type	Applied standard	Result
■	Conducted Emission (Mains port)	47 CFR Part 15 Subpart B / ANSI C63.4-2014 (Class B)	Complied
■	Radiated Emission		Complied

# 3. General Information

## 3.1 Test facility

The Global CS Center is located on Samsung Electronics Co., Ltd. at (Maetan-dong) 129, Samsung-ro, Yeongtong-gu, Suwon-si, Gyeonggi-do, 16677, Korea.

All testing are performed in Semi-anechoic chambers conforming to the site attenuation characteristics defined by ANSI C63.4, CISPR 32, CISPR 16-1-4 and Shielded rooms.

And all antennas are properly calibrated using ANSI C63.5:2017.

The Global CS Center is an ISO/IEC 17025 accredited testing laboratory by the National Radio Research Agency with designation No. KR0004. for EMC testing.

## 4. Test Setup configuration

### 4.1 Test Peripherals

The cables used for these peripherals are either permanently attached by the peripheral manufacturer or coupled with an assigned cable as defined below.

The following is a listing of the EUT and peripherals utilized during the performance of EMC test:

Description	Model No.	Serial No.	Manufacturer / Trademark	FCC ID
Mobile Phone	SM-A135F/DSN	-	SAMSUNG	A3LSMA135FDSN
Battery	EB-BA217ABY	-	SDI	-
Headset	EHS61	-	ESTEC	-
Data Cable	EP-DN980	-	RF TECH	-
Laptop Computer	Latitude5580	1WYRYM2	Dell	DoC
Laptop Computer	Latitude5580	D3HRYM2	Dell	DoC
Laptop AC Adapter	LA65NM130	5DEA	Dell	DoC
Laptop AC Adapter	LA65NM130	5B3C	Dell	DoC
Mouse	AA-SM7PCPB	CN57BA5903634AD V8JJCD4371	SAMSUNG	DoC
Mouse	SMH-210UB	TAKGA05788Z	SAMSUNG	DoC
Router	DIR-806A	RF0F1D8018454	D-Link	DoC
Router	DIR-806A	RF0F1D8011504	D-Link	DoC
Travel Adapter	EP-TA800	R37RCE100F9RT3	RF TECH	-
Micro SD Card	64GB	-	SAMSUNG	-

## 4.2 EUT operating mode

To achieve compliance applied standard specification including CXX, JAB and JBP requirement, the following mode(s) were made during compliance testing:

### 4.2.1 Conducted Emission

No.	Operating mode
1	Camera (Rear) + Charging (w/TA) + Cellular receiver (GSM 850 Center Frequency)
2	Camera (Front) + Charging (w/TA)
3	Video + Audio playback from internal memory + Charging (w/TA)
4	USB data communication with PC (from external memory)

### 4.2.2 Radiated Emission

No.	Operating mode
1	Camera (Rear) + Charging (w/TA)
2	Camera (Front)
3	Video + Audio playback from internal memory
4	USB data communication with PC (from external memory)

## 4.3 Details of Sampling

Customer selected, single unit.

#### 4.4 Used cable description

The EUT is configured, installed, arranged and operated in a manner consistent with typical applications. Interface cables/loads/devices are connected to at least one of each type of interface port of the EUT, and where practical, each cable shall be terminated in a device typical of actual usage. The type(s) of interconnecting cables to be used and the interface port (of the EUT) to which these were connected:

Connected cable	Length [m]	Shielded [Y/N]	Note
Data Cable	1.0	Y	From EUT to Laptop Computer or Travel Adapter
Headset	1.6	N	For EUT
Power	1.8	N	From Laptop Computer to AC Adapter
Power	1.5	N	For Laptop AC Adapter
LAN	1.5	N	From Laptop Computer to Router
USB	0.8	Y	From Laptop Computer to Router for DC Power
USB	1.8	Y	From Laptop Computer to Mouse

## 4.5 Test arrangement

### 4.5.1 Conducted Emission

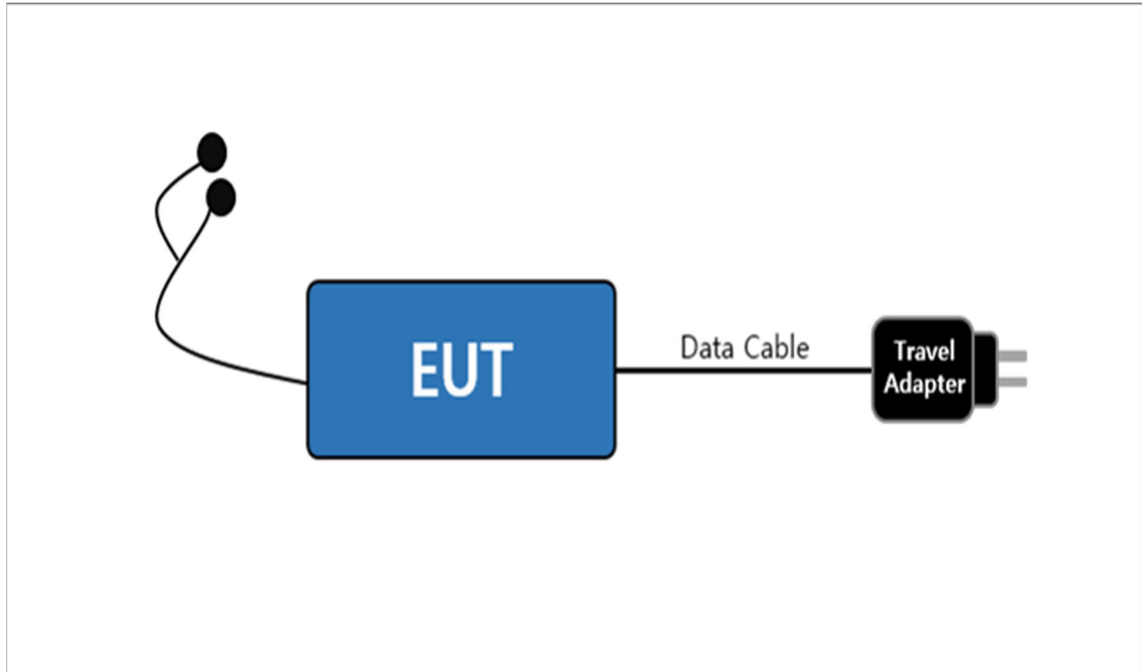

[ Mode 1 – 3 ]

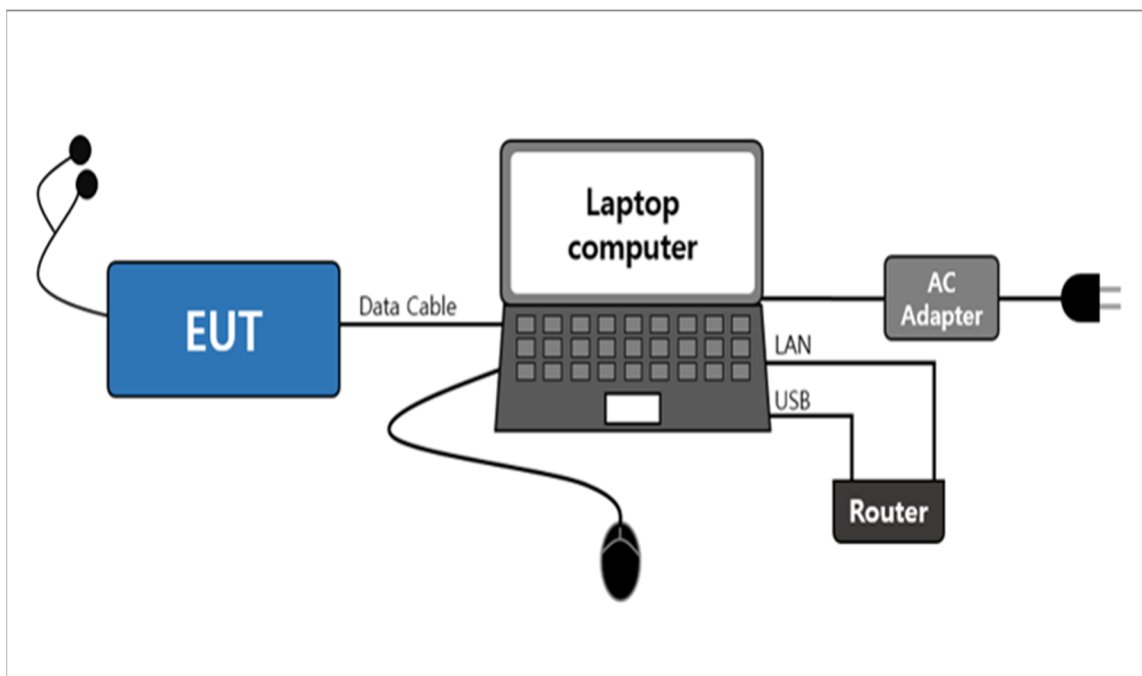

[ Mode 4 ]

## 4.5.2 Radiated Emission

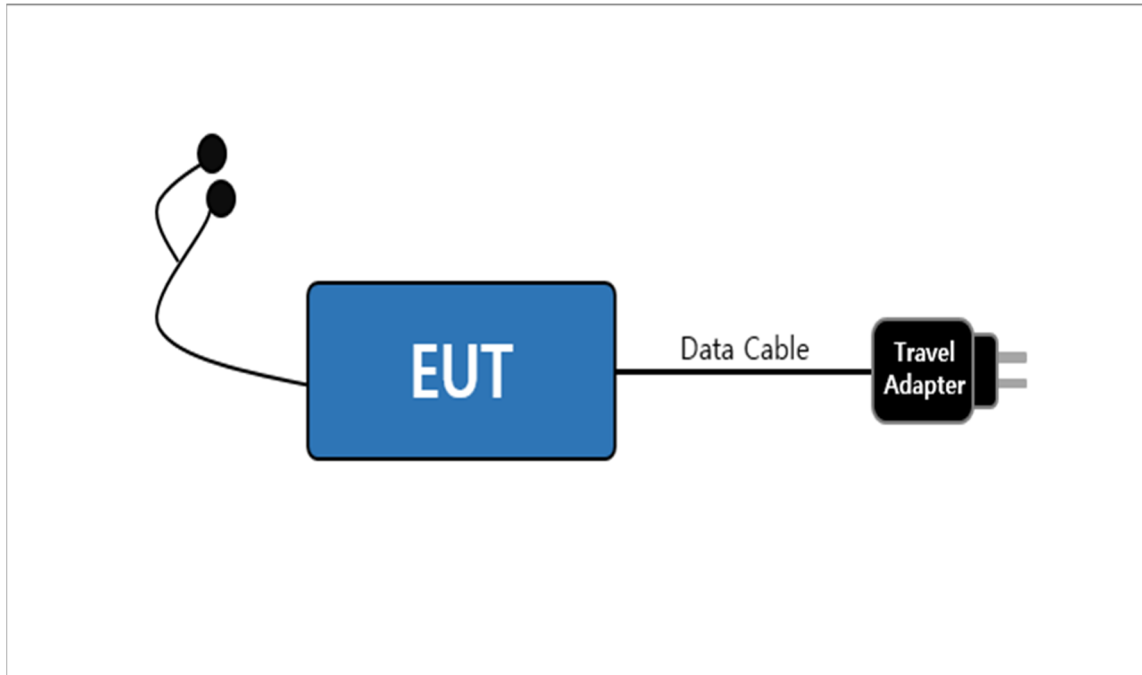

[ Mode 1 ]

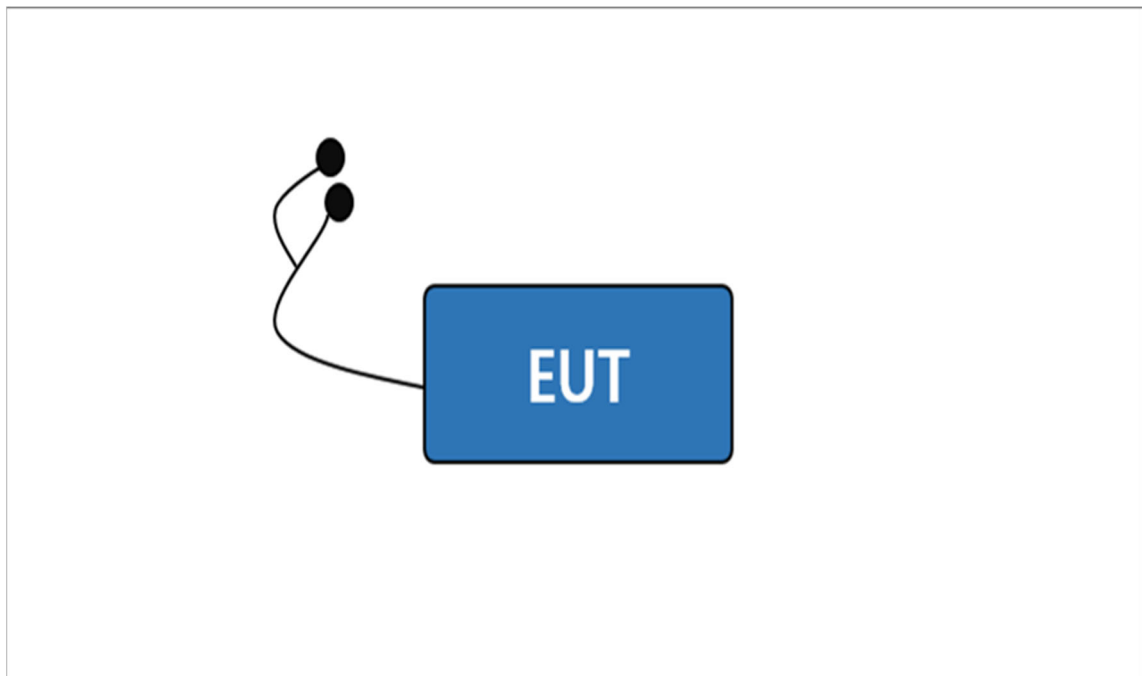

[ Mode 2 – 3 ]



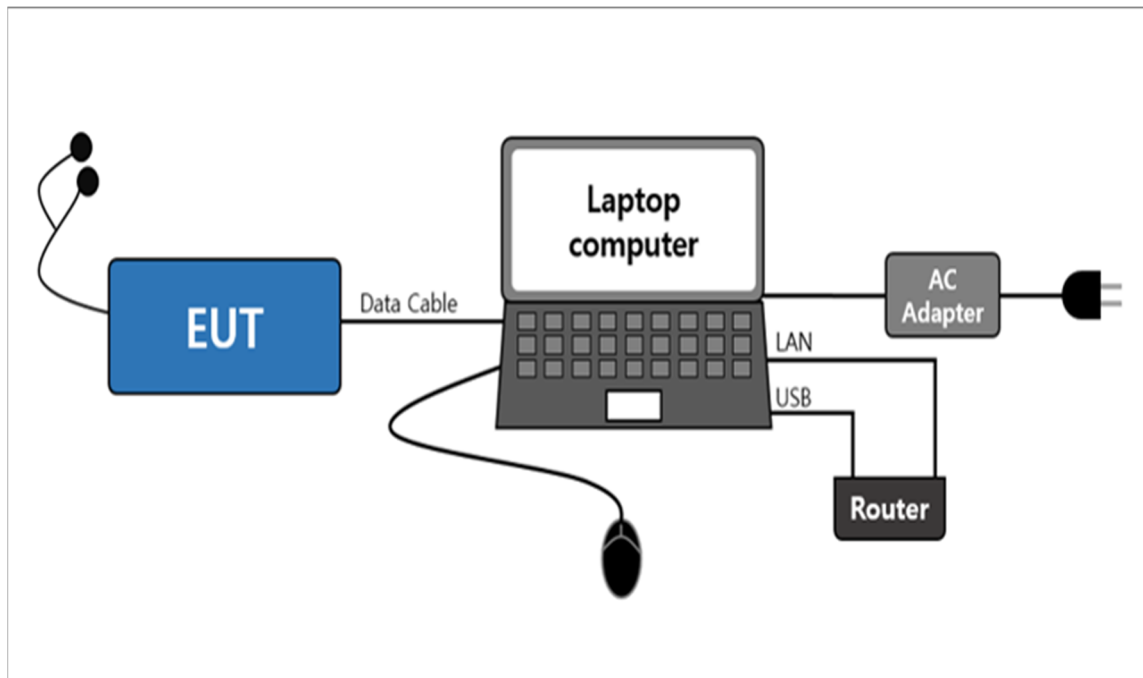

[ Mode 4 ]

## 4.6 EUT Description

The EUT is a bar type mobile phone which can operate on GSM 850/900/1800/1900, WCDMA FDD 1/5/8, LTE FDD 1/3/5/7/8/20/28, LTE TDD 38/40/41, and incorporates a Bluetooth, Wi-Fi (802.11 b/g/n/a/ac), Camera, Audio, Video, GNSS, SD Card and NFC.

### 4.6.1 The variant models

- None

## 4.7 EUT Frequencies

The highest frequencies (Generated and used)	Frequency [ MHz ]
Wi-Fi	5 825

## 4.8 Test configuration and condition

The system was configured for testing in a typical fashion that a customer would normally use. Cables were attached to each of the available I/O Ports. Where applicable, peripherals were attached to the I/O cables.

All the external I/O ports are exercised, as well as internal and the external SD card(if available), by writing and reading arbitrary data or charging with TA.

The EUT was investigated in three orientations and the worst case orientation is reported.

RX mode(850MHz) testing for AC conducted emission test was performed with the GSM850 RX Test mode at center frequency. All licensed communication (850MHz) RX mode, GSM/WCDMA/LTE, test results are not significantly different.

The video and audio were repetitively played with the earphone connected.

The camera of the EUT was operated continuously.

Power source for the EUT operating was supplied by CVCF made by the Pacific Corp.

- Test Voltage : AC 120 V, 60 Hz

## 4.9 Measurement uncertainty

Where relevant, the following measurement uncertainty levels have been estimated for tests performed on the apparatus : (According to CISPR 16-4-2 and UKAS M3003)

Test type		Measurement uncertainty (C.L. approximately 95 %, $k = 2$ )
Conducted Emission	AC Mains	2.83 dB
Radiated Emission (Below 1 GHz)	Horizontal	4.06 dB
	Vertical	4.74 dB
Radiated Emission (Above 1 GHz)	Horizontal	4.99 dB
	Vertical	4.99 dB

\* Remark

- 1) The values for uncertainty of conducted and radiated emissions are less than the Corresponding values of  $U_{cispr}$  given in CISPR 16-4-2. Therefore no adjustment of measurement results is necessary when comparing them with the relevant limits.

## 5. Results of individual test

### 5.1 Conducted Emission

The EUT is connected to a LISN via travel adapter. If the EUT is connected to the Laptop Computer USB port, the Laptop AC adapter is connected to a LISN.

Both conducted lines are measured in Quasi-Peak and CISPR-Average mode, including the worst-case data points for each tested configuration. The EUT measured in accordance with the methods described in standards.

Limits for Conducted emission at the mains ports of Class B

Frequency range Limits [ MHz ]	Resolution Bandwidth [ kHz ]	Limits [ dB( $\mu$ V) ]	
		Quasi-peak	Average
0.15 to 0.50	9	66 to 56	56 to 46
0.50 to 5	9	56	46
5 to 30	9	60	50

NOTE 1 The lower limit shall apply at the transition frequency.

NOTE 2 The limit decreases linearly with the logarithm of the frequency in the range 0.15 MHz to 0.50 MHz.

#### 5.1.1 Test instrumentation

EMC No.	Test Instrument	Model name	Manufacturer	Serial No.	Next Calibration	
					Date	Interval (Month)
E5I-109	Universal Radio Communicator	CMU200	R&S	110431	2022-12-08	12
E5I-127	Two-Line V-Network	ENV216	R&S	102061	2023-01-17	12
E5I-016	EMI Test Receiver	ESU8	R&S	100482	2022-06-03	12
-	Test software	EMC32	R&S	Ver 10.60.20	-	-

#### 5.1.2 Temperature and humidity condition

Test date	2022-01-19	Test engineer	Sung-Wook Choi
Climate condition	Ambient temperature	(25.4 $\pm$ 0.5) °C	Limit (15.0 to 35.0) °C
	Relative humidity	(38.1 $\pm$ 0.5) % R.H.	Limit (25.0 to 75.0) % R.H.
	Atmospheric pressure	(102.0 $\pm$ 0.5) kPa	Limit (86.0 to 106.0) kPa
Test place	Shield Room (SR8)		

### 5.1.3 Test Results

#### □ Operating Mode 1: AC Mains

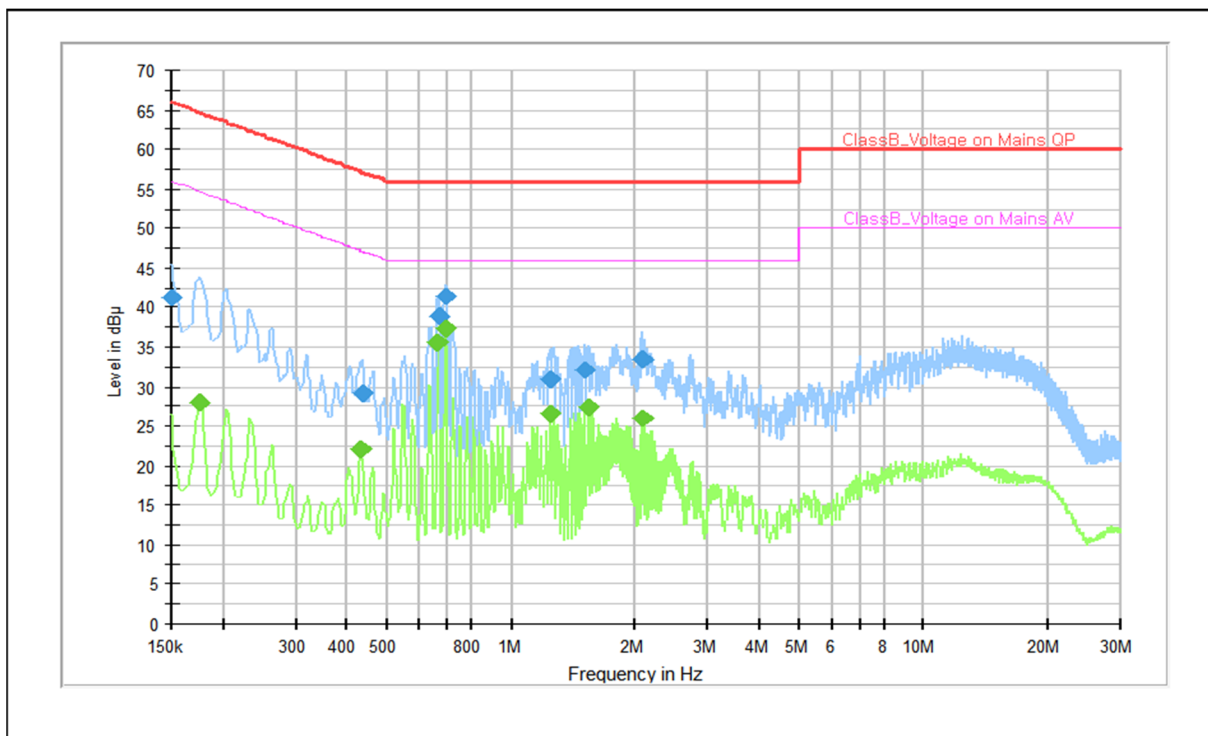

Note 1) Two graphs measured for both Live(L1) and Neutral(N) of the LISN are combined into one graph.

QP / CAV final measurement results table:

Frequency (MHz)	QP (dBµV)	CAV (dBµV)	Limit (dBµV)	Margin (dB)	Line	Corr. (dB)
0.150	41.3	---	66.0	24.7	L1	9.9
0.175	---	27.9	54.7	26.8	N	9.9
0.431	---	22.1	47.2	25.2	N	10.1
0.436	29.1	---	57.1	28.1	N	10.1
0.665	---	35.6	46.0	10.4	L1	10.1
0.670	39.0	---	56.0	17.0	L1	10.1
0.692	41.5	---	56.0	14.5	L1	10.1
0.695	---	37.3	46.0	8.7	L1	10.1
1.237	30.9	---	56.0	25.1	L1	10.0
1.244	---	26.7	46.0	19.3	N	9.9
1.502	32.1	---	56.0	23.9	L1	9.9
1.536	---	27.4	46.0	18.6	N	9.9
2.085	---	25.9	46.0	20.1	N	9.9
2.085	33.5	---	56.0	22.5	L1	9.9

Note 2) Level (QP and/or CAV) = Meter Reading (QP and/or CAV) + Corr. (LISN Insertion Loss + Cable Loss)  
 Margin (QP and/or CAV) = Limit – Level (QP and/or CAV)  
 QP = Quasi-Peak, CAV = CISPR-Average, Corr. = Correction Factor

□ Operating Mode 2: AC Mains

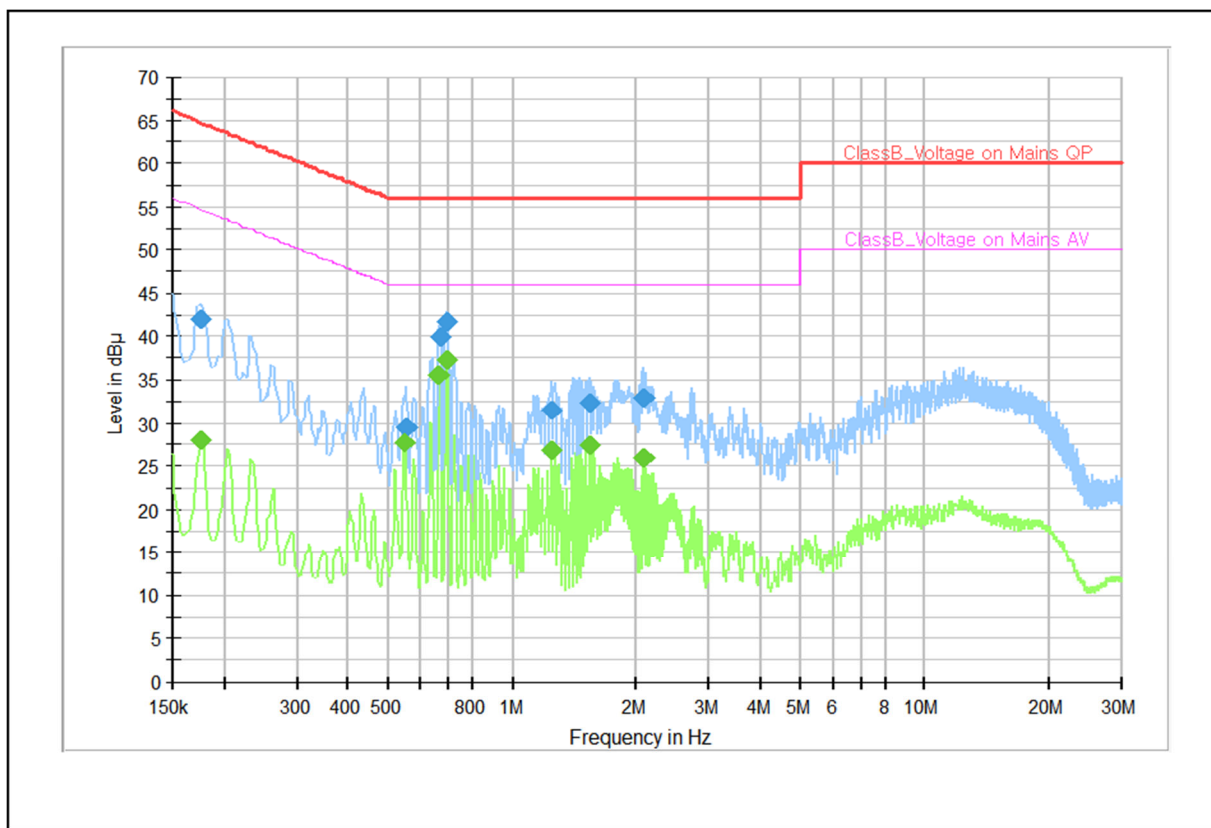

Note 1) Two graphs measured for both Live(L1) and Neutral(N) of the LISN are combined into one graph.

QP / CAV final measurement results table:

Frequency (MHz)	QP (dBµV)	CAV (dBµV)	Limit (dBµV)	Margin (dB)	Line	Corr. (dB)
0.175	---	27.9	54.7	26.8	N	9.9
0.175	42.0	---	64.7	22.8	L1	10.0
0.548	---	27.9	46.0	18.1	N	10.1
0.553	29.5	---	56.0	26.5	N	10.1
0.665	---	35.6	46.0	10.4	L1	10.1
0.668	39.8	---	56.0	16.2	L1	10.1
0.695	---	37.3	46.0	8.7	L1	10.1
0.695	41.7	---	56.0	14.3	L1	10.1
1.244	---	26.7	46.0	19.3	N	9.9
1.244	31.4	---	56.0	24.6	L1	10.0
1.532	32.3	---	56.0	23.7	L1	9.9
1.536	---	27.4	46.0	18.6	N	9.9
2.085	---	25.9	46.0	20.1	N	9.9
2.087	32.9	---	56.0	23.1	L1	9.9

Note 2) Level (QP and/or CAV) = Meter Reading (QP and/or CAV) + Corr. (LISN Insertion Loss + Cable Loss)  
 Margin (QP and/or CAV) = Limit – Level (QP and/or CAV)  
 QP = Quasi-Peak, CAV = CISPR-Average, Corr. = Correction Factor

□ **Operating Mode 3: AC Mains**

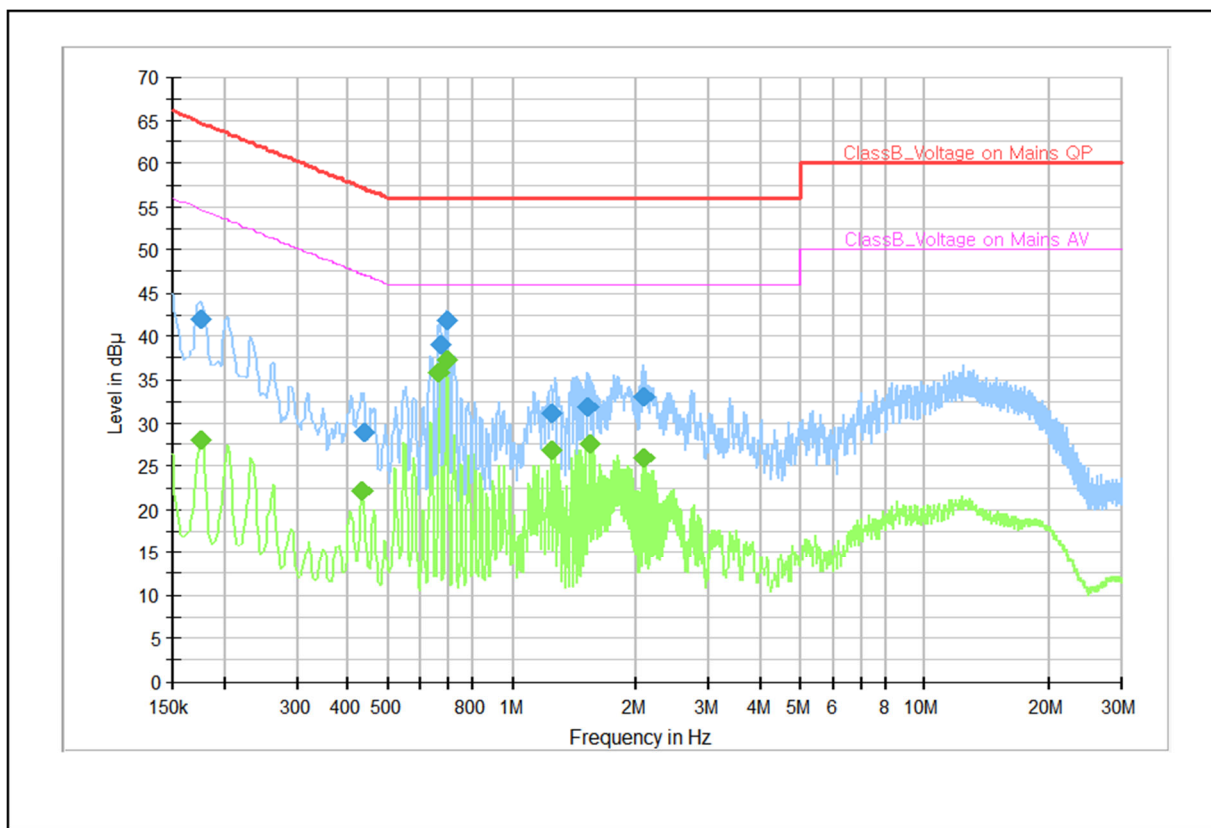

Note 1) Two graphs measured for both Live(L1) and Neutral(N) of the LISN are combined into one graph.

QP / CAV final measurement results table:

Frequency (MHz)	QP (dBµV)	CAV (dBµV)	Limit (dBµV)	Margin (dB)	Line	Corr. (dB)
0.175	---	27.9	54.7	26.8	N	9.9
0.175	42.0	---	64.7	22.8	L1	10.0
0.431	---	22.2	47.2	25.1	N	10.1
0.436	29.0	---	57.1	28.2	N	10.1
0.665	---	35.7	46.0	10.3	L1	10.1
0.670	39.0	---	56.0	17.0	L1	10.1
0.695	---	37.4	46.0	8.6	L1	10.1
0.695	41.8	---	56.0	14.2	L1	10.1
1.244	---	26.8	46.0	19.2	N	9.9
1.246	31.2	---	56.0	24.8	L1	10.0
1.529	31.9	---	56.0	24.1	L1	9.9
1.536	---	27.5	46.0	18.5	N	9.9
2.085	---	26.0	46.0	20.0	N	9.9
2.087	33.0	---	56.0	23.0	L1	9.9

Note 2) Level (QP and/or CAV) = Meter Reading (QP and/or CAV) + Corr. (LISN Insertion Loss + Cable Loss)  
 Margin (QP and/or CAV) = Limit – Level (QP and/or CAV)  
 QP = Quasi-Peak, CAV = CISPR-Average, Corr. = Correction Factor

□ Operating Mode 4: AC Mains

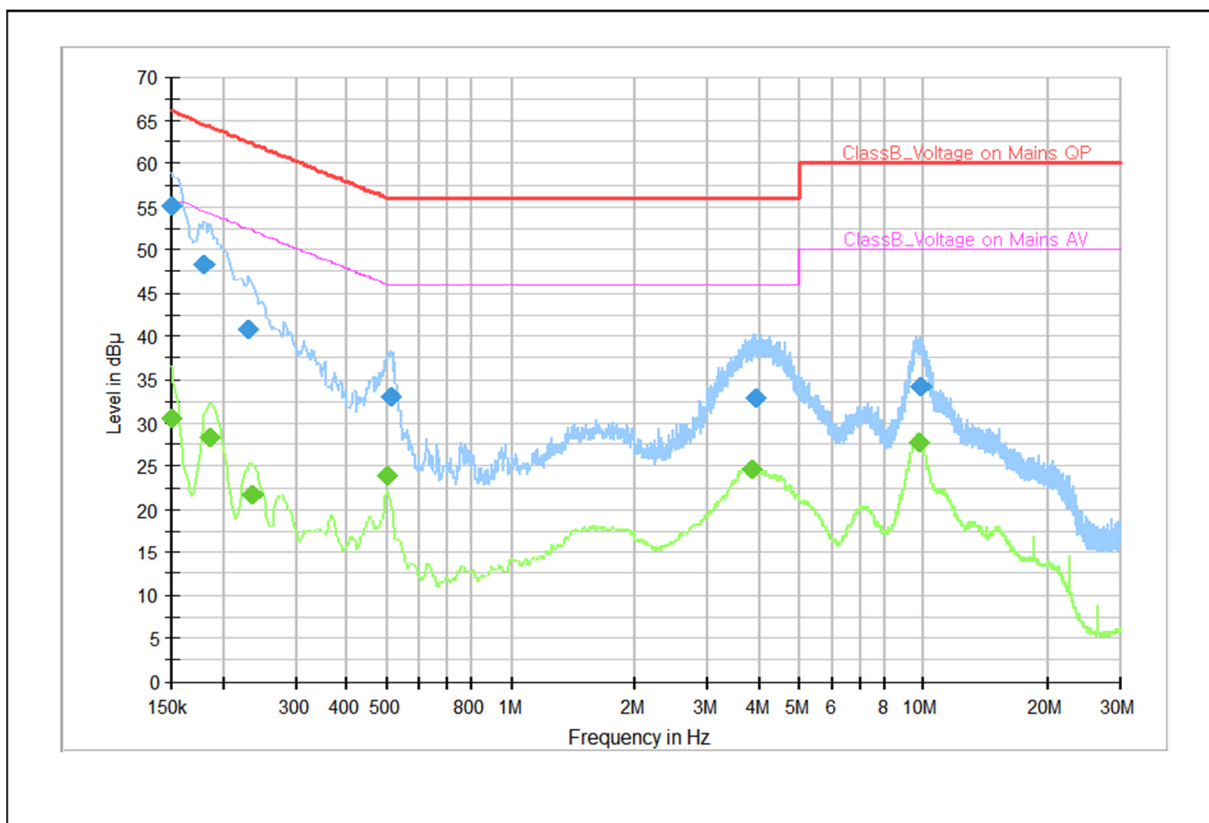

Note 1) Two graphs measured for both Live(L1) and Neutral(N) of the LISN are combined into one graph.

QP / CAV final measurement results table:

Frequency (MHz)	QP (dBµV)	CAV (dBµV)	Limit (dBµV)	Margin (dB)	Line	Corr. (dB)
0.150	55.1	---	66.0	10.9	N	9.8
0.150	---	30.6	56.0	25.4	L1	9.8
0.179	48.2	---	64.5	16.3	N	9.9
0.186	---	28.3	54.2	25.9	L1	9.9
0.231	40.8	---	62.4	21.6	N	9.7
0.236	---	21.8	52.3	30.5	L1	9.8
0.501	---	23.8	46.0	22.2	L1	10.1
0.512	33.0	---	56.0	23.0	L1	10.1
3.838	---	24.6	46.0	21.4	N	9.7
3.932	32.8	---	56.0	23.2	L1	9.8
9.695	---	27.8	50.0	22.2	L1	9.9
9.902	34.3	---	60.0	25.7	L1	9.9

Note 2) Level (QP and/or CAV) = Meter Reading (QP and/or CAV) + Corr. (LISN Insertion Loss + Cable Loss)  
 Margin (QP and/or CAV) = Limit – Level (QP and/or CAV)  
 QP = Quasi-Peak, CAV = CISPR-Average, Corr. = Correction Factor



## 5.2 Radiated Emission

The following data lists the significant emission frequencies, measured levels, correction factors (for antenna and cables), orientation of table, polarization and height of antenna, the corrected reading, the limit, and the amount of margin.

Peak measurements were made over the changeable frequency range 30 MHz to 1 GHz at a measurement distance of 10 m for the following antenna and turntable arrangements:

Antenna Height [ cm ]	Antenna Polarization	Resolution Bandwidth [ kHz ]	Video Bandwidth [ kHz ]	Turntable position [ degrees ]
100 ~ 400	Horizontal, Vertical	120	300	Continuous

Measurements within 6 dB of the limit were then maximized by adjusting turntable position.

Final measurements were made using quasi-peak detector.

Peak/CISPR-Average measurements were made over the changeable frequency range 1 GHz to 40 GHz or 5th harmonics of the highest frequency generated or used in the device or on which the device operates or tunes at a measurement distance of 3 m for the following antenna and turntable arrangements. The measurements above 1 GHz were performed with the bore-sighting antenna aimed at the EUT.

Antenna Height [ cm ]	Antenna Polarization	Resolution Bandwidth [ MHz ]	Video Bandwidth [ MHz ]	Turntable position [ degrees ]
100 ~ 400	Horizontal, Vertical	1	3	Continuous

Measurements within 6 dB of the limit were then maximized by adjusting turntable position.

Final measurements were made using peak and CISPR-average detectors.

### Limits for Radiated emission of Class B at a measuring distance of 3 m and 10 m

Frequency range Limits [ MHz ]	Field Strength		
	3 m [ $\mu\text{V/m}$ ]	3 m [ dB( $\mu\text{V/m}$ ) ]	10 m [ dB( $\mu\text{V/m}$ ) ]
30 to 88	100	40.0	29.5
88 to 216	150	43.5	33.0
216 to 960	200	46.0	35.5
Above 960	500	54.0	43.5

Note) Distance correction formula from D1(3m) to D2(10m)

: Limit at D2 = Limit at D1 + 20Log(D1 / D2)

Results checked manually; and points close to the limit line were re-measured.

## 5.2.1 Test instrumentation

EMC No.	Test Instrument	Model name	Manufacturer	Serial No.	Next Calibration	
					Date	Interval (Month)
E5I-021	EMI Test Receiver	ESU40	R&S	100376	2022-02-04	12
E5I-018	EMI Test Receiver	ESU8	R&S	100484	2022-05-26	12
E5I-020	EMI Test Receiver	ESU40	R&S	100375	2022-09-23	12
E5I-072	BiLog Antenna	CBL6112D	TESEQ	36009	2022-05-15	24
E5I-223	6 dB Fixed Attenuator	8491B-006	Agilent	58359	2022-05-15	24
E5I-120	BiLog Antenna	CBL6112D	TESEQ	36997	2022-05-15	24
E5I-189	6 dB Fixed Attenuator	8491A	Keysight	MY52462295	2022-05-15	24
E5I-093	Preamplifier	310N	SONOMA	273122	2022-01-21	12
E5I-094	Preamplifier	310N	SONOMA	282363	2022-01-21	12
E5I-149	Horn Antenna	HF907	R&S	102525	2022-07-10	24
E5I-040	Signal Conditioning Unit	SCU-18	R&S	10210	2022-04-06	12
E5I-037	WideBand Horn Antenna	WBH 18-40K	R&S	11201	2023-02-15	24
E5I-042	Signal Conditioning Unit	SCU-40A	R&S	10004	2022-09-10	12
-	Test software	EP7RE	TOYO	Ver 8.0.20	-	-
-	Test software	EMC32	R&S	Ver 9.25.00	-	-

## 5.2.1 Temperature and humidity condition

<b>Test date</b>	2021-12-30, 2022-01-06	<b>Test engineer</b>	Sung-Wook Choi
<b>Climate condition</b>	Ambient temperature	(23.1 ± 0.5) °C	Limit (15.0 to 35.0) °C
	Relative humidity	(41.7 ± 0.5) % R.H.	Limit (25.0 to 75.0) % R.H.
	Atmospheric pressure	(101.8 ± 0.5) kPa	Limit (86.0 to 106.0) kPa
<b>Test place</b>	Semi-Anechoic Chamber (SAC5)		

### 5.2.3 Test Results

□ Operating Mode 1

- Frequencies below 1 GHz

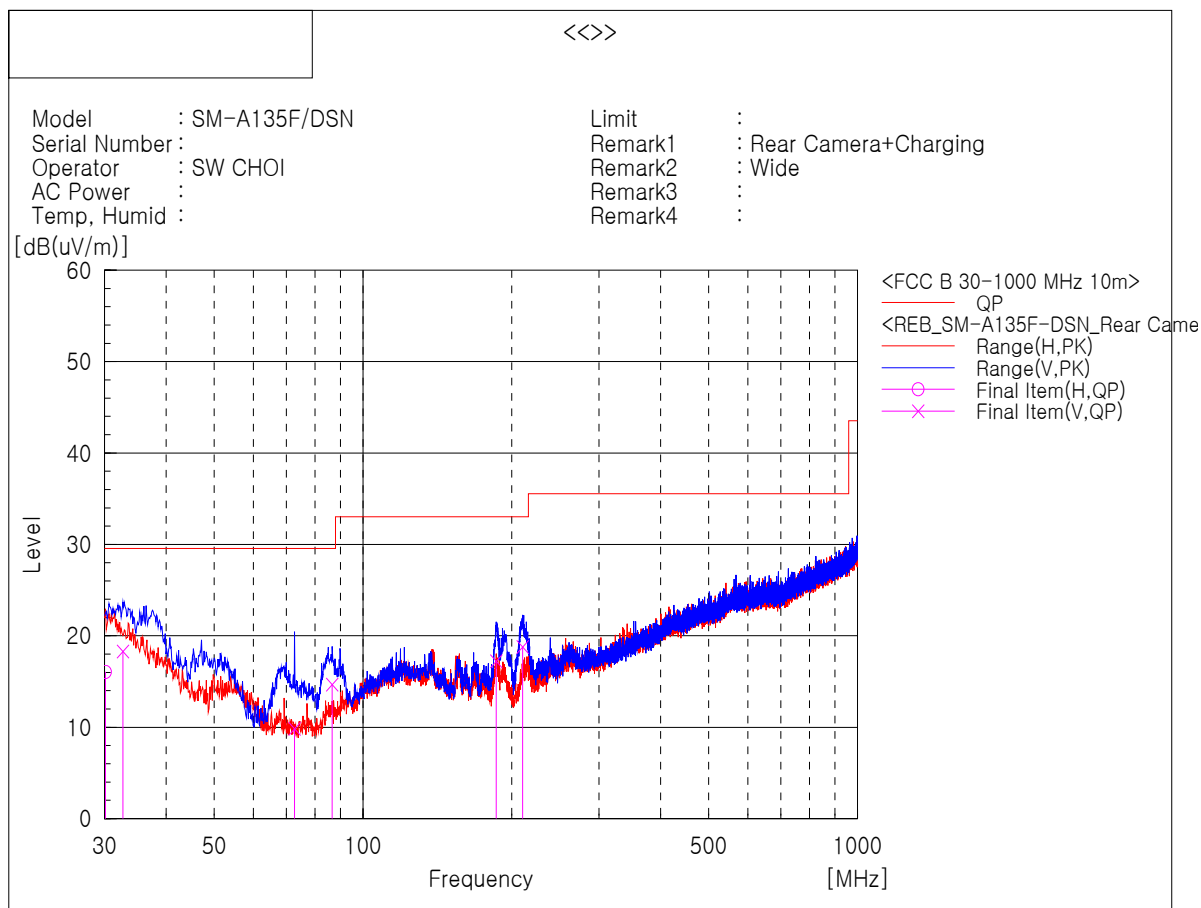

Final Result

No.	Frequency [MHz]	(P)	Reading QP [dB(uV)]	c.f [dB(1/m)]	Result QP [dB(uV/m)]	Limit QP [dB(uV/m)]	Margin QP [dB]	Height [cm]	Angle [deg]	System	Remark
1	30.121	H	22.9	-6.9	16.0	29.5	13.5	102	109	1	
2	32.668	V	24.8	-6.5	18.3	29.5	11.2	104	287	2	
3	72.680	V	27.4	-17.6	9.8	29.5	19.7	193	0	2	
4	86.624	V	30.2	-15.5	14.7	29.5	14.8	165	229	2	
5	185.806	V	31.1	-13.9	17.2	33.0	15.8	100	31	2	
6	210.299	V	32.5	-13.7	18.8	33.0	14.2	100	5	2	

Note1) Receiving antenna polarization : Horizontal, Vertical

Test Distance : 10 m, Antenna Height : 1 to 4 meters

Result (QP) = Reading (QP) + c.f (Antenna Factor + Cable Loss - Amp. Gain)

Margin (QP) = Limit – Level (QP)

QP = Quasi-Peak, c.f = Correction Factor

**- Frequencies above 1 GHz**

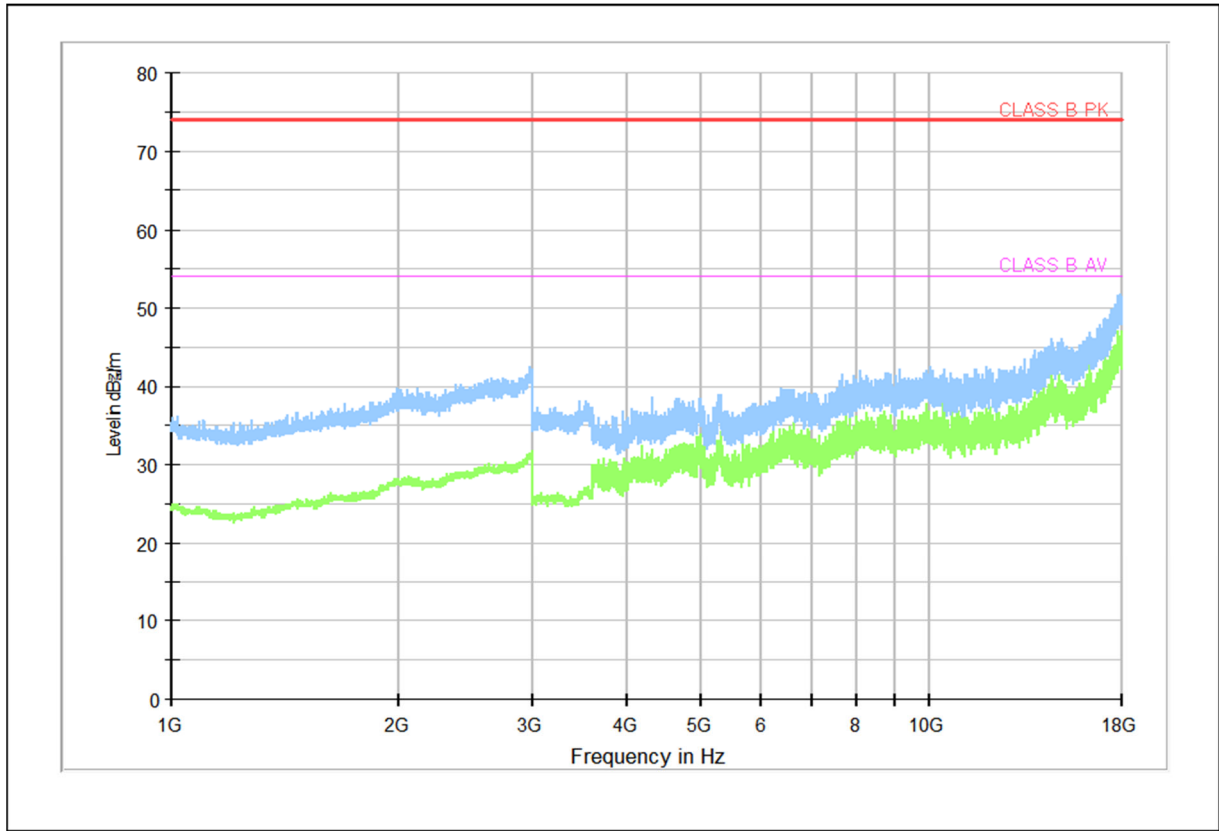

Note 1) We have also tested from 18 GHz to 30 GHz and found no emissions.

Note 2) Receiving antenna polarization : Horizontal, Vertical

Test Distance : 3 m, Antenna Height : 1 to 4 meters

Level (PK and/or CAV) = Reading (PK and/or CAV) + Corr. (Antenna Factor + Cable Loss - Amp. Gain)

Margin (PK and/or CAV) = Limit – Level (PK and/or CAV)

PK = Peak, CAV = CISPR-Average, Corr. = Correction Factor

□ Operating Mode 2

- Frequencies below 1 GHz

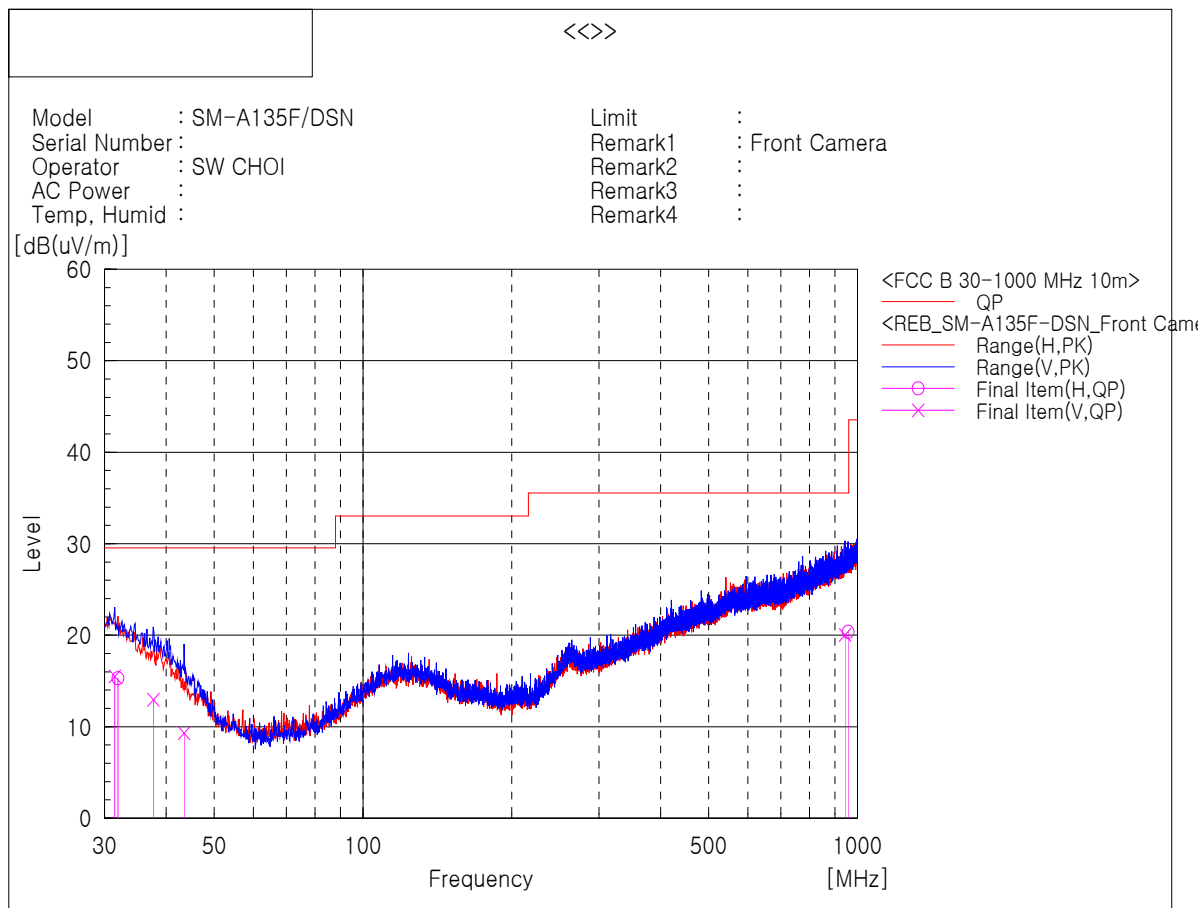

Final Result

No.	Frequency (P) [MHz]	Reading QP [dB(uV)]	c.f [dB(1/m)]	Result QP [dB(uV/m)]	Limit QP [dB(uV/m)]	Margin QP [dB]	Height [cm]	Angle [deg]	System	Remark
1	31.455 V	21.7	-6.2	15.5	29.5	14.0	346	99	2	
2	31.940 H	23.1	-7.8	15.3	29.5	14.2	106	116	1	
3	37.639 V	21.1	-8.2	12.9	29.5	16.6	110	155	2	
4	43.459 V	20.9	-11.6	9.3	29.5	20.2	116	265	2	
5	943.619 V	18.8	1.2	20.0	35.5	15.5	342	95	2	
6	957.805 H	20.5	-0.1	20.4	35.5	15.1	286	353	1	

Note1) Receiving antenna polarization : Horizontal, Vertical

Test Distance : 10 m, Antenna Height : 1 to 4 meters

Result (QP) = Reading (QP) + c.f (Antenna Factor + Cable Loss - Amp. Gain)

Margin (QP) = Limit - Level (QP)

QP = Quasi-Peak, c.f = Correction Factor

**- Frequencies above 1 GHz**

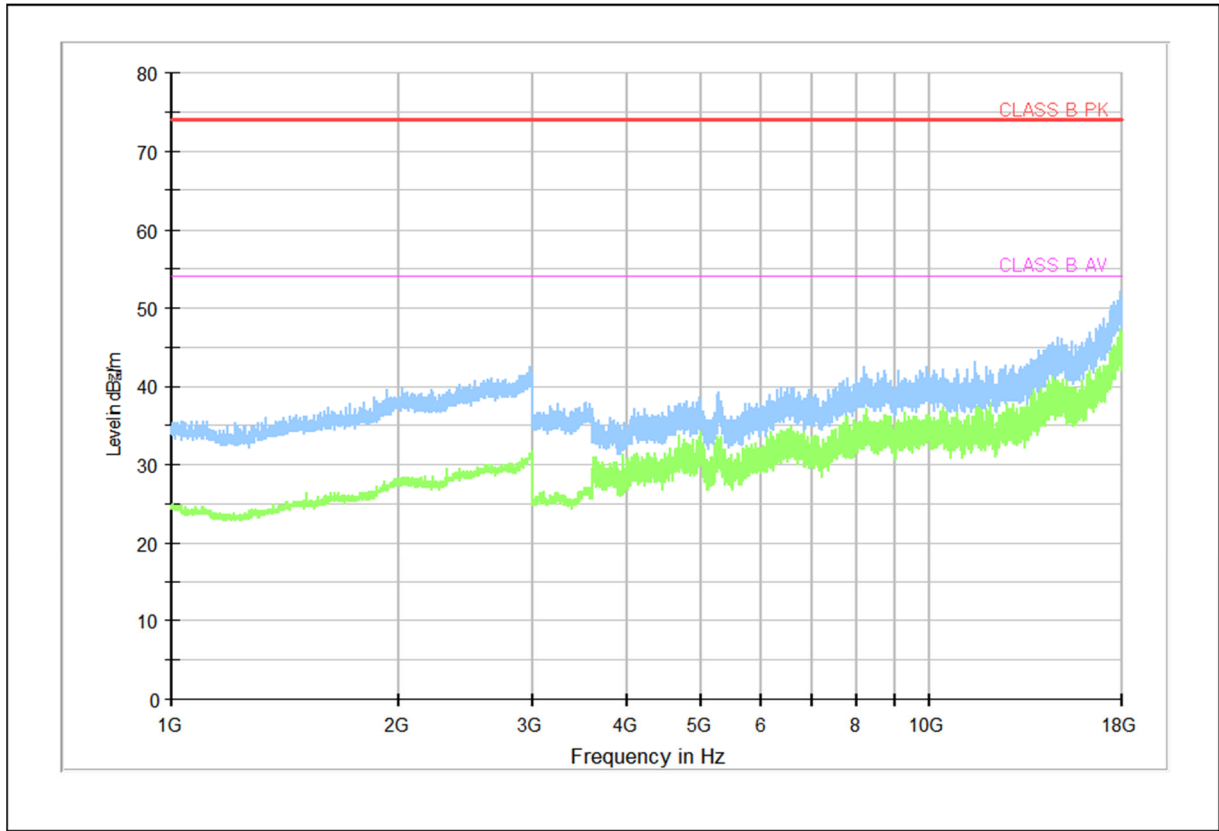

Note 1) We have also tested from 18 GHz to 30 GHz and found no emissions.

Note 2) Receiving antenna polarization : Horizontal, Vertical

Test Distance : 3 m, Antenna Height : 1 to 4 meters

Level (PK and/or CAV) = Reading (PK and/or CAV) + Corr. (Antenna Factor + Cable Loss - Amp. Gain)

Margin (PK and/or CAV) = Limit – Level (PK and/or CAV)

PK = Peak, CAV = CISPR-Average, Corr. = Correction Factor

□ Operating Mode 3

- Frequencies below 1 GHz

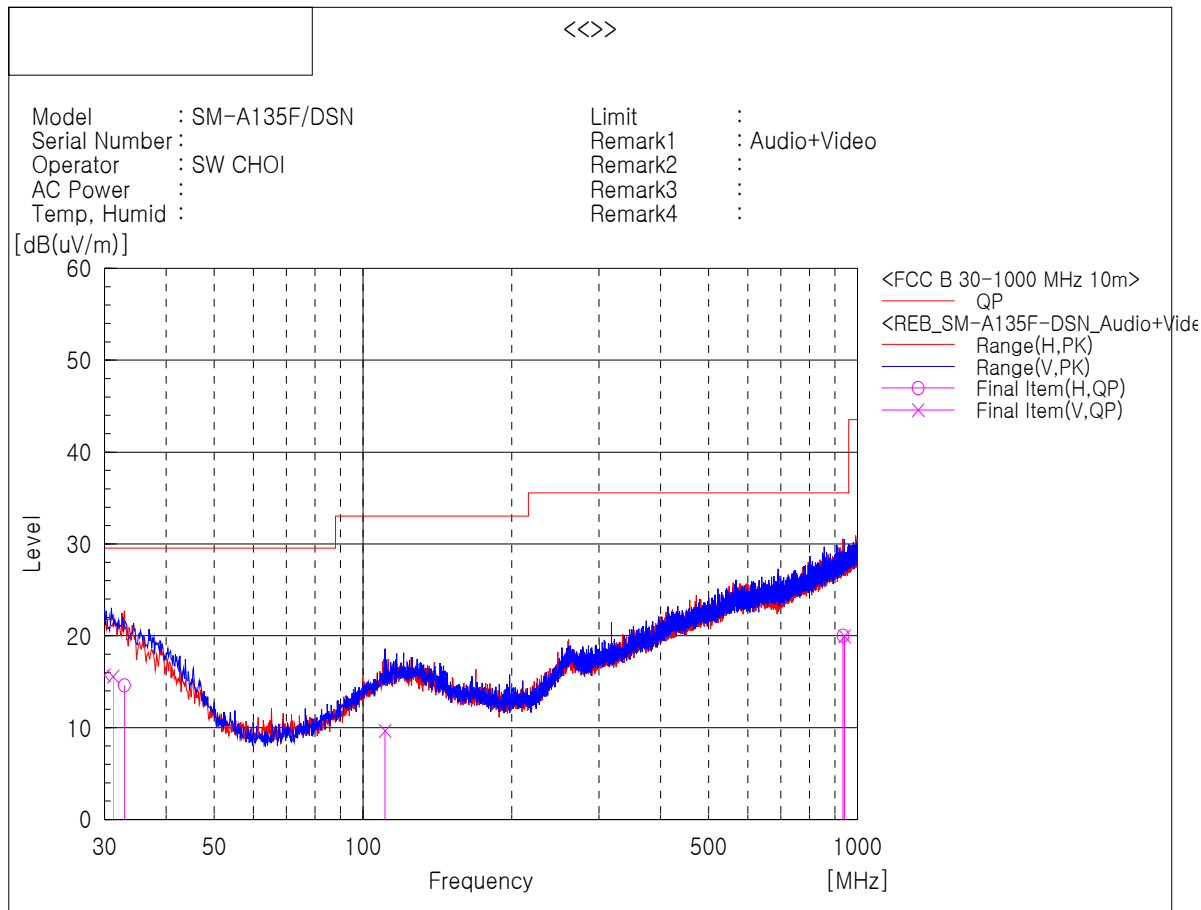

Final Result

No.	Frequency (P) [MHz]	Reading QP [dB(uV)]	c.f [dB(1/m)]	Result QP [dB(uV/m)]	Limit QP [dB(uV/m)]	Margin QP [dB]	Height [cm]	Angle [deg]	System	Remark
1	30.000	V 21.5	-5.8	15.7	29.5	13.8	387	56	2	
2	31.213	V 21.7	-6.1	15.6	29.5	13.9	373	318	2	
3	32.910	H 22.8	-8.2	14.6	29.5	14.9	103	101	1	
4	110.753	V 21.1	-11.4	9.7	33.0	23.3	297	199	2	
5	934.889	H 20.6	-0.6	20.0	35.5	15.5	188	335	1	
6	940.951	V 18.9	1.1	20.0	35.5	15.5	180	165	2	

Note1) Receiving antenna polarization : Horizontal, Vertical

Test Distance : 10 m, Antenna Height : 1 to 4 meters

Result (QP) = Reading (QP) + c.f (Antenna Factor + Cable Loss - Amp. Gain)

Margin (QP) = Limit - Level (QP)

QP = Quasi-Peak, c.f = Correction Factor

**- Frequencies above 1 GHz**

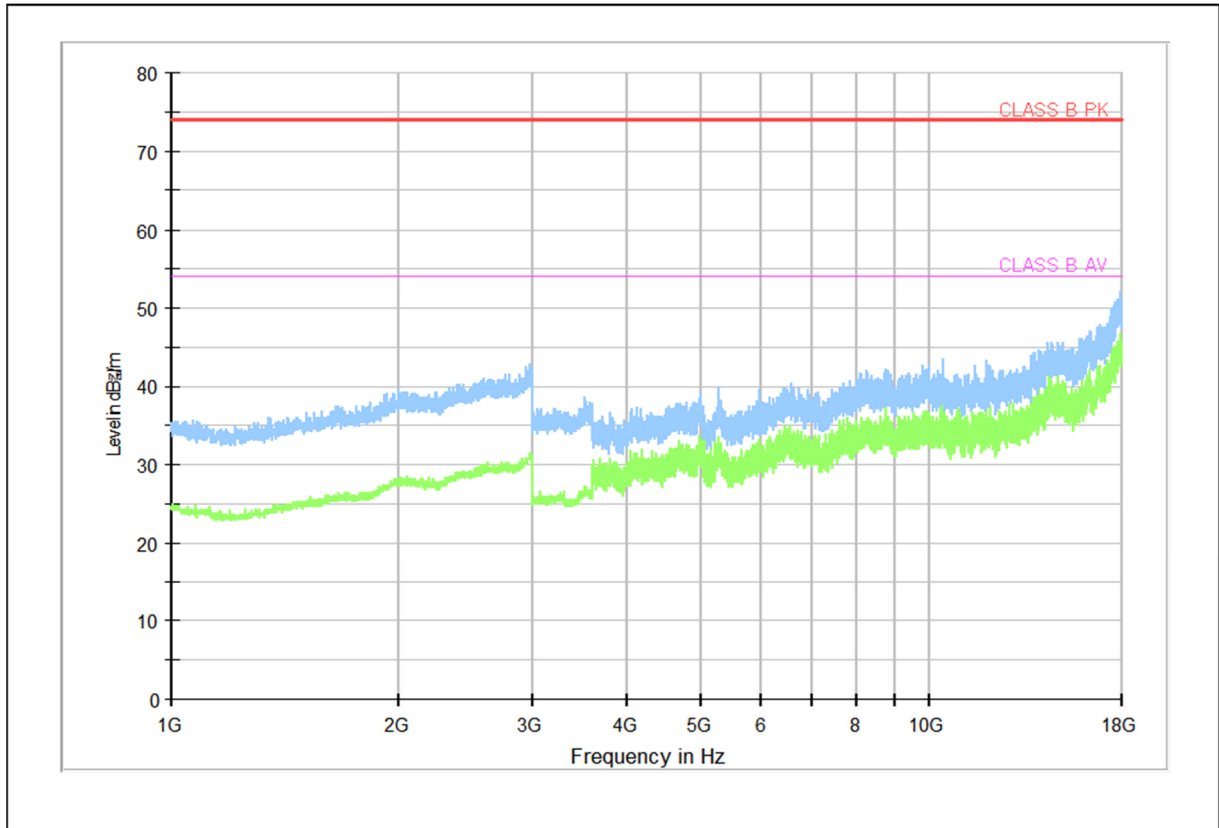

Note 1) We have also tested from 18 GHz to 30 GHz and found no emissions.

Note 2) Receiving antenna polarization : Horizontal, Vertical

Test Distance : 3 m, Antenna Height : 1 to 4 meters

Level (PK and/or CAV) = Reading (PK and/or CAV) + Corr. (Antenna Factor + Cable Loss - Amp. Gain)

Margin (PK and/or CAV) = Limit – Level (PK and/or CAV)

PK = Peak, CAV = CISPR-Average, Corr. = Correction Factor



□ Operating Mode 4

- Frequencies below 1 GHz

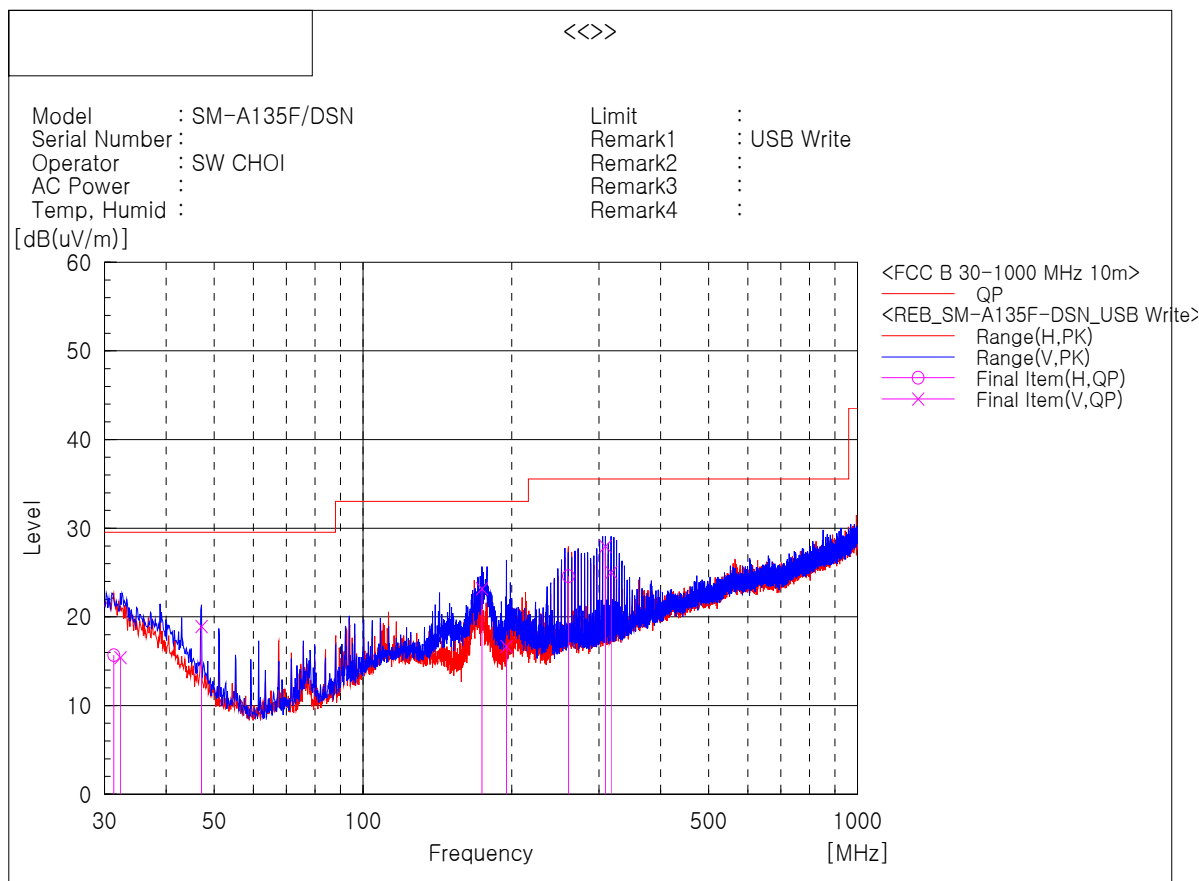

Final Result

No.	Frequency [MHz]	(P)	Reading QP [dB(uV)]	c.f [dB(1/m)]	Result QP [dB(uV/m)]	Limit QP [dB(uV/m)]	Margin QP [dB]	Height [cm]	Angle [deg]	System	Remark
1	31.334	H	23.2	-7.5	15.7	29.5	13.8	111	357	1	
2	32.304	V	21.8	-6.4	15.4	29.5	14.1	366	324	2	
3	47.096	V	33.1	-14.2	18.9	29.5	10.6	107	83	2	
4	174.045	V	36.7	-13.5	23.2	33.0	9.8	111	296	2	
5	195.021	V	30.5	-13.8	16.7	33.0	16.3	133	286	2	
6	260.133	H	35.5	-10.9	24.6	35.5	10.9	358	272	1	
7	309.239	V	37.0	-9.0	28.0	35.5	7.5	100	168	2	
8	317.484	V	33.8	-8.8	25.0	35.5	10.5	100	11	2	

Note1) Receiving antenna polarization : Horizontal, Vertical

Test Distance : 10 m, Antenna Height : 1 to 4 meters

Result (QP) = Reading (QP) + c.f (Antenna Factor + Cable Loss - Amp. Gain)

Margin (QP) = Limit - Level (QP)

QP = Quasi-Peak, c.f = Correction Factor

**- Frequencies above 1 GHz**

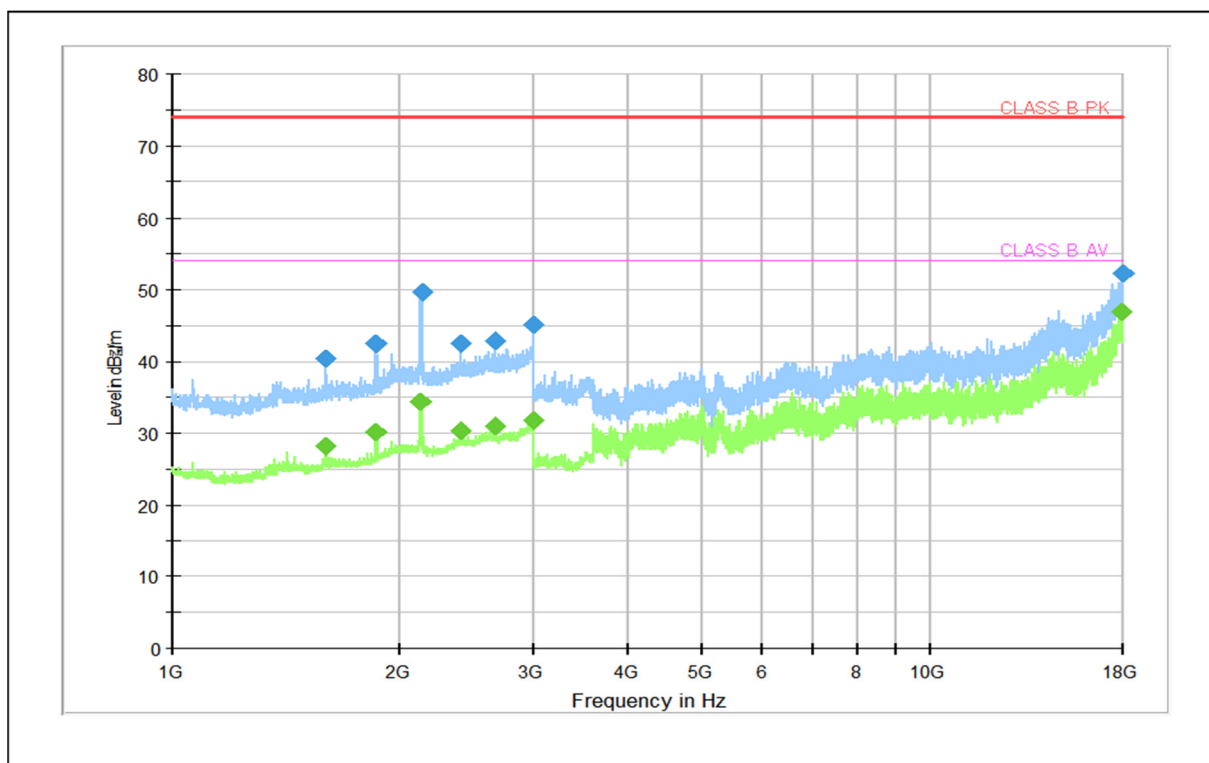

Frequency (MHz)	PK (dBµV/m)	CAV (dBµV/m)	Limit (dBµV/m)	Margin (dB)	Height (cm)	Pol	Azimuth (deg)	Corr. (dB)
1 592.500	---	28.15	54.00	25.85	101.20	V	158.00	9.26
1 594.000	40.49	---	74.00	33.51	100.00	V	117.00	9.28
1 860.000	42.38	---	74.00	31.62	102.30	V	12.00	10.36
1 861.500	---	30.16	54.00	23.84	100.30	V	15.00	10.38
2 129.500	---	34.43	54.00	19.57	104.50	V	337.00	11.90
2 132.000	49.72	---	74.00	24.28	103.60	V	106.00	11.90
2 395.500	42.49	---	74.00	31.51	100.70	V	0.00	12.72
2 397.000	---	30.33	54.00	23.67	100.10	V	0.00	12.73
2 657.500	42.98	---	74.00	31.02	100.60	V	262.00	13.97
2 660.000	---	30.97	54.00	23.03	101.80	V	342.00	13.97
3 000.000	---	31.66	54.00	22.34	100.90	V	219.00	15.76
3 000.000	45.24	---	74.00	28.76	101.30	V	219.00	15.76
17 845.500	---	46.88	54.00	7.12	100.00	V	253.00	38.80
17 946.500	52.27	---	74.00	21.73	100.50	V	0.00	38.44

Note 1) We have also tested from 18 GHz to 30 GHz and found no emissions.

Note 2) Receiving antenna polarization : Horizontal, Vertical

Test Distance : 3 m, Antenna Height : 1 to 4 meters

Level (PK and/or CAV) = Reading (PK and/or CAV) + Corr. (Antenna Factor + Cable Loss - Amp. Gain)

Margin (PK and/or CAV) = Limit – Level (PK and/or CAV)

PK = Peak, CAV = CISPR-Average, Corr. = Correction Factor