



SAR EVALUATION REPORT

Applicant Name:
 Samsung Electronics Co., Ltd.
 129, Samsung-ro, Maetan dong,
 Yeongtong-gu, Suwon-si
 Gyeonggi-do, 16677, Korea

Date of Testing:
 05/31/2021 - 07/07/2021
Test Site/Location:
 PCTEST Lab, Columbia, MD, USA
Document Serial No.:
 1M2106030063-01.A3L (Rev1)

FCC ID: A3LSMA127M

APPLICANT: SAMSUNG ELECTRONICS CO., LTD.

DUT Type: Portable Handset
Application Type: Certification
FCC Rule Part(s): CFR §2.1093
Model(s): SM-A127M/DS, SM-A127M

Equipment Class	Band & Mode	Tx Frequency	SAR			
			1g Head (W/kg)	1g Body-Worn (W/kg)	1g Hotspot (W/kg)	10g Phablet (W/kg)
PCE	GSM/GPRS/EDGE 850	824.20 - 848.80 MHz	0.23	0.25	0.53	N/A
PCE	GSM/GPRS/EDGE 1900	1850.20 - 1909.80 MHz	0.12	0.16	0.40	N/A
PCE	UMTS 850	826.40 - 846.60 MHz	0.28	0.41	0.53	N/A
PCE	UMTS 1750	1712.4 - 1752.6 MHz	0.32	0.52	1.08	2.63
PCE	UMTS 1900	1852.4 - 1907.6 MHz	0.37	0.53	0.92	2.71
PCE	LTE Band 12	704 - 711 MHz	0.17	0.30	0.32	N/A
PCE	LTE Band 17	709 - 711 MHz	N/A	N/A	N/A	N/A
PCE	LTE Band 26 (Cell)	821.5 - 841.5 MHz	0.24	0.28	0.47	N/A
PCE	LTE Band 5 (Cell)	829 - 844 MHz	N/A	N/A	N/A	N/A
PCE	LTE Band 66 (AWS)	1720 - 1770 MHz	0.39	0.45	1.16	2.51
PCE	LTE Band 4 (AWS)	1720 - 1745 MHz	N/A	N/A	N/A	N/A
PCE	LTE Band 2 (PCS)	1860 - 1900 MHz	0.27	0.49	1.05	2.58
PCE	LTE Band 41	2498.5 - 2687.5 MHz	0.54	0.88	0.26	1.81
DTS	2.4 GHz WLAN	2412 - 2472 MHz	0.17	< 0.1	0.16	N/A
DSS/DTS	Bluetooth	2402 - 2480 MHz	< 0.1	< 0.1	< 0.1	N/A
Simultaneous SAR per KDB 690783 D01v01r03:			0.71	0.95	1.32	2.71

Note: This revised Test Report supersedes and replaces the previously issued test report on the same subject device for the same type of testing as indicated. Please discard or destroy the previously issued test report(s) and dispose of it accordingly.

This wireless portable device has been shown to be capable of compliance for localized specific absorption rate (SAR) for uncontrolled environment/general population exposure limits specified in ANSI/IEEE C95.1-1992 and has been tested in accordance with the measurement procedures specified in Section 1.7 of this report; for North American frequency bands only.

I attest to the accuracy of data. All measurements reported herein were performed by me or were made under my supervision and are correct to the best of my knowledge and belief. I assume full responsibility for the completeness of these measurements and vouch for the qualifications of all persons taking them. Test results reported herein relate only to the item(s) tested.

Randy Ortanez
 President





The SAR Tick is an initiative of the Mobile & Wireless Forum (MWF). While a product may be considered eligible, use of the SAR Tick logo requires an agreement with the MWF. Further details can be obtained by emailing: sartick@mwfai.info.

FCC ID: A3LSMA127M	 SAR EVALUATION REPORT		Approved by: Quality Manager
Document S/N: 1M2106030063-01.A3L (Rev 1)	Test Dates: 05/31/2021 - 07/07/2021	DUT Type: Portable Handset	Page 1 of 68

TABLE OF CONTENTS

1	DEVICE UNDER TEST	3
2	LTE INFORMATION	10
3	INTRODUCTION	11
4	DOSIMETRIC ASSESSMENT	12
5	DEFINITION OF REFERENCE POINTS	13
6	TEST CONFIGURATION POSITIONS	14
7	RF EXPOSURE LIMITS	18
8	FCC MEASUREMENT PROCEDURES.....	19
9	RF CONDUCTED POWERS	24
10	SYSTEM VERIFICATION.....	36
11	SAR DATA SUMMARY	41
12	FCC MULTI-TX AND ANTENNA SAR CONSIDERATIONS.....	57
13	SAR MEASUREMENT VARIABILITY	62
14	EQUIPMENT LIST.....	64
15	MEASUREMENT UNCERTAINTIES.....	65
16	CONCLUSION.....	66
17	REFERENCES	67
APPENDIX A:	SAR TEST PLOTS	
APPENDIX B:	SAR DIPOLE VERIFICATION PLOTS	
APPENDIX C:	SAR TISSUE SPECIFICATIONS	
APPENDIX D:	SAR SYSTEM VALIDATION	
APPENDIX E:	DUT ANTENNA DIAGRAM & SAR TEST SETUP PHOTOGRAPHS	
APPENDIX F:	LTE LOWER BANDWIDTH RF CONDUCTED POWERS	
APPENDIX G:	POWER REDUCTION VERIFICATION	
APPENDIX H:	PROBE AND DIPOLE CALIBRATION CERTIFICATES	

FCC ID: A3LSMA127M	 <small>Proud to be part of Samsung</small>	SAR EVALUATION REPORT		Approved by: Quality Manager
Document S/N: 1M2106030063-01.A3L (Rev 1)	Test Dates: 05/31/2021 - 07/07/2021	DUT Type: Portable Handset	Page 2 of 68	

1 DEVICE UNDER TEST

1.1 Device Overview



Band & Mode	Operating Modes	Tx Frequency
GSM/GPRS/EDGE 850	Voice/Data	824.20 - 848.80 MHz
GSM/GPRS/EDGE 1900	Voice/Data	1850.20 - 1909.80 MHz
UMTS 850	Voice/Data	826.40 - 846.60 MHz
UMTS 1750	Voice/Data	1712.4 - 1752.6 MHz
UMTS 1900	Voice/Data	1852.4 - 1907.6 MHz
LTE Band 12	Voice/Data	704 - 711 MHz
LTE Band 17	Voice/Data	709 - 711 MHz
LTE Band 26 (Cell)	Voice/Data	821.5 - 841.5 MHz
LTE Band 5 (Cell)	Voice/Data	829 - 844 MHz
LTE Band 66 (AWS)	Voice/Data	1720 - 1770 MHz
LTE Band 4 (AWS)	Voice/Data	1720 - 1745 MHz
LTE Band 2 (PCS)	Voice/Data	1860 - 1900 MHz
LTE Band 41	Voice/Data	2498.5 - 2687.5 MHz
2.4 GHz WLAN	Voice/Data	2412 - 2472 MHz
Bluetooth	Data	2402 - 2480 MHz

1.2 Power Reduction for SAR

This device utilizes a power reduction mechanism for some wireless modes and bands for SAR compliance under portable hotspot conditions and under some conditions when the device is being used in close proximity to the user's hand. All hotspot SAR evaluations for this device were performed at the maximum allowed output power when hotspot is enabled. FCC KDB Publication 616217 D04v01r02 Section 6 was used as a guideline for selecting SAR test distances for this device when being used in phablet use conditions. Detailed descriptions of the power reduction mechanism are included in the operational description.

This device also utilizes a power reduction mechanism for some wireless modes and bands for SAR compliance during voice or VoIP held to ear scenarios.

This device uses an independent fixed level power reduction mechanism for WLAN operations during voice or VoIP held to ear scenarios. Per FCC Guidance, the held-to-ear exposure conditions were evaluated at reduced power according to the head SAR positions described in IEEE 1528-2013. Detailed descriptions of the power reduction mechanism are included in the operational description.

FCC ID: A3LSMA127M	 PCTEST <small>Proud to be part of Samsung</small>	SAR EVALUATION REPORT		Approved by: Quality Manager
Document S/N: 1M2106030063-01.A3L (Rev 1)	Test Dates: 05/31/2021 - 07/07/2021	DUT Type: Portable Handset	Page 3 of 68	



1.3 Nominal and Maximum Output Power Specifications

This device operates using the following maximum and nominal output power specifications. SAR values were scaled to the maximum allowed power to determine compliance per KDB Publication 447498 D01v06.

1.3.1 2G/3G/4G Output Power

GSM/GPRS/EDGE 850										
Power Level		Voice (in dBm)	Data - Burst Average GMSK (in dBm)				Data - Burst Average 8-PSK (in dBm)			
		1 TX Slot	1 TX Slots	2 TX Slots	3 TX Slots	4 TX Slots	1 TX Slots	2 TX Slots	3 TX Slots	4 TX Slots
Max	Max allowed power	33.5	33.5	31.5	30.0	28.5	27.5	25.5	24.0	23.0
	Nominal	32.5	32.5	30.5	29.0	27.5	26.5	24.5	23.0	22.0
GSM/GPRS/EDGE 1900										
Power Level		Voice (in dBm)	Data - Burst Average GMSK (in dBm)				Data - Burst Average 8-PSK (in dBm)			
		1 TX Slot	1 TX Slots	2 TX Slots	3 TX Slots	4 TX Slots	1 TX Slots	2 TX Slots	3 TX Slots	4 TX Slots
Max	Max allowed power	30.5	30.5	28.0	26.0	24.5	23.0	21.5	20.0	19.0
	Nominal	29.5	29.5	27.0	25.0	23.5	22.0	20.5	19.0	18.0

UMTS Band 5 (850 MHz)					
Power Level		Modulated Average Output Power (in dBm)			
		3GPP WCDMA Rel 99	3GPP HSDPA Rel 5	3GPP HSUPA Rel 6	3GPP DC-HSDPA Rel 8
Max	Max allowed power	25.0	23.0	22.5	22.5
	Nominal	24.0	22.0	21.5	21.5
UMTS Band 4 (1750 MHz)					
Power Level		Modulated Average Output Power (in dBm)			
		3GPP WCDMA Rel 99	3GPP HSDPA Rel 5	3GPP HSUPA Rel 6	3GPP DC-HSDPA Rel 8
Max	Max allowed power	25.0	23.0	23.0	23.0
	Nominal	24.0	22.0	22.0	22.0
RCV Mode Active	Max allowed power	23.0	23.0	23.0	23.0
	Nominal	22.0	22.0	22.0	22.0
Proximity Sensor Active	Max allowed power	23.0	23.0	23.0	23.0
	Nominal	22.0	22.0	22.0	22.0
UMTS Band 2 (1900 MHz)					
Power Level		Modulated Average Output Power (in dBm)			
		3GPP WCDMA Rel 99	3GPP HSDPA Rel 5	3GPP HSUPA Rel 6	3GPP DC-HSDPA Rel 8
Max	Max allowed power	25.0	23.0	23.0	23.0
	Nominal	24.0	22.0	22.0	22.0
RCV Mode Active	Max allowed power	23.0	23.0	23.0	23.0
	Nominal	22.0	22.0	22.0	22.0
Hotspot Mode Active	Max allowed power	23.0	23.0	23.0	23.0
	Nominal	22.0	22.0	22.0	22.0
Proximity Sensor Active	Max allowed power	23.0	23.0	23.0	23.0
	Nominal	22.0	22.0	22.0	22.0



FCC ID: A3LSMA127M	 PCTEST Proud to be part of  Samsung	SAR EVALUATION REPORT		Approved by: Quality Manager
Document S/N: 1M2106030063-01.A3L (Rev 1)	Test Dates: 05/31/2021 - 07/07/2021	DUT Type: Portable Handset		Page 4 of 68

Mode / Band		Modulated Average Output Power (in dBm)			
		Max	RCV Mode Active	Hotspot Mode Active	Proximity Sensor Active
LTE FDD Band 12	Max allowed power	24.5	24.5	24.5	24.5
	Nominal	23.5	23.5	23.5	23.5
LTE FDD Band 17	Max allowed power	24.0	24.0	24.0	24.0
	Nominal	23.0	23.0	23.0	23.0
LTE FDD Band 5	Max allowed power	25.0	25.0	25.0	25.0
	Nominal	24.0	24.0	24.0	24.0
LTE FDD Band 26	Max allowed power	25.0	25.0	25.0	25.0
	Nominal	24.0	24.0	24.0	24.0
LTE FDD Band 4	Max allowed power	25.0	23.0	25.0	23.0
	Nominal	24.0	22.0	24.0	22.0
LTE FDD Band 66	Max allowed power	25.0	23.0	25.0	23.0
	Nominal	24.0	22.0	24.0	22.0
LTE FDD Band 2	Max allowed power	25.0	22.0	25.0	22.0
	Nominal	24.0	21.0	24.0	21.0
LTE TDD Band 41 (PC3)	Max allowed power	23.5	17.0	17.0	17.0
	Nominal	22.5	16.0	16.0	16.0

1.3.2 WLAN and Bluetooth Maximum Output Power

Mode	Band	IEEE 802.11 (in dBm)					
		SISO					
Maximum / Nominal Power		Max	Nom.	Max	Nom.	Max	Nom.
2.4 GHz WIFI	2.45 GHz	18.5	17.5	17.0	16.0	17.0	16.0
		ch. 1: 15.0	14.0	ch. 1: 15.0	14.0	ch. 1: 15.0	14.0
		ch. 10: 16.0	15.0	ch. 10: 16.0	15.0	ch. 10: 16.0	15.0
		ch. 11: 13.0	12.0	ch. 11: 13.0	12.0	ch. 11: 13.0	12.0
		ch. 12: 9.0	8.0	ch. 12: 9.0	8.0	ch. 12: 9.0	8.0
		ch. 13: 9.0	8.0	ch. 13: 5.0	4.0	ch. 13: 5.0	4.0

Mode / Band	Modulated Average (dBm)	
Bluetooth (1Mbps)	Maximum	9.5
	Nominal	8.5
Bluetooth (EDR)	Maximum	8.0
	Nominal	7.0
Bluetooth LE 2Mbps	Maximum	9.0
	Nominal	8.0
Bluetooth LE 1Mbps, 125/500Kbps	Maximum	5.5
	Nominal	4.5



FCC ID: A3LSMA127M	 PCTEST Proud to be part of Samsung	SAR EVALUATION REPORT		Approved by: Quality Manager
Document S/N: 1M2106030063-01.A3L (Rev 1)	Test Dates: 05/31/2021 - 07/07/2021	DUT Type: Portable Handset		Page 5 of 68

1.3.3 WLAN Reduced Output Power

The below table is applicable for the following conditions:

- Head Conditions

Mode	Band	IEEE 802.11 (in dBm)					
		SISO					
Maximum / Nominal Power		Max	Nom.	Max	Nom.	Max	Nom.
2.4 GHz WIFI	2.45 GHz	13.0	12.0	13.0	12.0	13.0	12.0
		ch. 12: 9.0	8.0	ch. 12: 9.0	8.0	ch. 12: 9.0	8.0
		ch. 13: 9.0	8.0	ch. 13: 5.0	4.0	ch. 13: 5.0	4.0

FCC ID: A3LSMA127M	 PCTEST <small>Proud to be part of Samsung</small>	SAR EVALUATION REPORT		Approved by: Quality Manager
Document S/N: 1M2106030063-01.A3L (Rev 1)	Test Dates: 05/31/2021 - 07/07/2021	DUT Type: Portable Handset		Page 6 of 68



1.4 DUT Antenna Locations

The overall dimensions of this device are > 9 x 5 cm. A diagram showing the location of the device antennas can be found in Appendix E. Since the diagonal dimension of this device is > 160 mm and <200 mm, it is considered a “phablet.”

**Table 1-1
Device Edges/Sides for SAR Testing**

Mode	Back	Front	Top	Bottom	Right	Left
GPRS 850	Yes	Yes	No	Yes	Yes	Yes
GPRS 1900	Yes	Yes	No	Yes	Yes	Yes
UMTS 850	Yes	Yes	No	Yes	Yes	Yes
UMTS 1750	Yes	Yes	No	Yes	Yes	Yes
UMTS 1900	Yes	Yes	No	Yes	Yes	Yes
LTE Band 12	Yes	Yes	No	Yes	Yes	Yes
LTE Band 26 (Cell)	Yes	Yes	No	Yes	Yes	Yes
LTE Band 66 (AWS)	Yes	Yes	No	Yes	Yes	Yes
LTE Band 2 (PCS)	Yes	Yes	No	Yes	Yes	Yes
LTE Band 41	Yes	Yes	Yes	No	No	Yes
2.4 GHz WLAN	Yes	Yes	Yes	No	No	Yes
Bluetooth	Yes	Yes	Yes	No	No	Yes

Note: Particular DUT edges were not required to be evaluated for wireless router SAR or phablet SAR if the edges were greater than 2.5 cm from the transmitting antenna according to FCC KDB Publication 941225 D06v02r01 Section III and FCC KDB Publication 648474 D04v01r03. The distances between the transmit antennas and the edges of the device are included in the filing.

FCC ID: A3LSMA127M	 PCTEST <small>Proud to be part of Samsung</small>	SAR EVALUATION REPORT		Approved by: Quality Manager
Document S/N: 1M2106030063-01.A3L (Rev 1)	Test Dates: 05/31/2021 - 07/07/2021	DUT Type: Portable Handset		Page 7 of 68

1.5 Simultaneous Transmission Capabilities

According to FCC KDB Publication 447498 D01v06, transmitters are considered to be operating simultaneously when there is overlapping transmission, with the exception of transmissions during network hand-offs with maximum hand-off duration less than 30 seconds.

This device contains multiple transmitters that may operate simultaneously, and therefore requires a simultaneous transmission analysis according to FCC KDB Publication 447498 D01v06 4.3.2 procedures.

**Table 1-2
Simultaneous Transmission Scenarios**

No.	Capable Transmit Configuration	Head	Body-Worn Accessory	Wireless Router	Phablet	Notes
1	GSM voice + 2.4 GHz WLAN	Yes	Yes	N/A	Yes	
2	GSM voice + 2.4 GHz Bluetooth	Yes^	Yes	N/A	Yes	^ Bluetooth Tethering is considered
3	UMTS + 2.4 GHz WLAN	Yes	Yes	Yes	Yes	
4	UMTS + 2.4 GHz Bluetooth	Yes^	Yes	Yes^	Yes	^ Bluetooth Tethering is considered
5	LTE + 2.4 GHz WLAN	Yes	Yes	Yes	Yes	
6	LTE + 2.4 GHz Bluetooth	Yes^	Yes	Yes^	Yes	^ Bluetooth Tethering is considered
7	GPRS/EDGE + 2.4 GHz WLAN	N/A	N/A	Yes	Yes	
8	GPRS/EDGE + 2.4 GHz Bluetooth	N/A	N/A	Yes^	Yes	^ Bluetooth Tethering is considered

- 2.4 GHz WLAN, and 2.4 GHz Bluetooth share the same antenna path and cannot transmit simultaneously.
- All licensed modes share the same antenna path and cannot transmit simultaneously.
- When the user utilizes multiple services in UMTS 3G mode it uses multi-Radio Access Bearer or multi-RAB. The power control is based on a physical control channel (Dedicated Physical Control Channel [DPCCH]) and power control will be adjusted to meet the needs of both services. Therefore, the UMTS+WLAN scenario also represents the UMTS Voice/DATA + WLAN Hotspot scenario.
- Per the manufacturer, WIFI Direct is not expected to be used in conjunction with a held-to-ear or body-worn accessory voice call. Therefore, there are no simultaneous transmission scenarios involving WIFI direct beyond that listed in the above table.
- This device supports VOLTE.
- This device supports VOWIFI.
- This device supports Bluetooth Tethering.



1.6 Miscellaneous SAR Test Considerations

(A) WIFI/BT

2.4 GHz WLAN and 2.4 GHz Bluetooth Hotspot SAR tests and combinations are considered for SAR with respect to Wireless Router configurations according to FCC KDB Publication 941225 D06v02r01.

This device supports channel 1-13 for 2.4 GHz WLAN. Because channel 12/13 targets are not higher than that of channels 1-11, channels 1, 6, and 11 were considered for SAR testing per FCC KDB 248227 D01V02r02.

Per FCC KDB Publication 648474 D04v01r03, this device is considered a "phablet" since the diagonal dimension is greater than 160mm and less than 200mm. Phablet SAR tests are required when wireless router mode does not apply or if wireless router 1g SAR > 1.2 W/kg. Phablet SAR was not evaluated for 2.4 GHz WLAN operations since wireless router 1g SAR was < 1.2 W/kg.

FCC ID: A3LSMA127M	 PCTEST <small>Proved to be part of Samsung</small>	SAR EVALUATION REPORT		Approved by: Quality Manager
Document S/N: 1M2106030063-01.A3L (Rev 1)	Test Dates: 05/31/2021 - 07/07/2021	DUT Type: Portable Handset	Page 8 of 68	

(B) Licensed Transmitter(s)

GSM/GPRS/EDGE DTM is not supported for US bands. Therefore, the GSM Voice modes in this report do not transmit simultaneously with GPRS/EDGE Data.

This device is only capable of QPSK HSUPA in the uplink. Therefore, no additional SAR tests are required beyond that described for devices with HSUPA in KDB 941225 D01v03r01.

LTE SAR for the higher modulations and lower bandwidths were not tested since the maximum average output power of all required channels and configurations was not more than 0.5 dB higher than the highest bandwidth; and the reported LTE SAR for the highest bandwidth was less than 1.45 W/kg for all configurations according to FCC KDB 941225 D05v02r04.

Per FCC KDB Publication 648474 D04v01r03, this device is considered a "phablet" since the diagonal dimension is greater than 160mm and less than 200mm. Therefore, phablet SAR tests are required when wireless router mode does not apply or if wireless router 1g SAR > 1.2 W/kg. Additional SAR tests for phablet SAR were evaluated per KDB 616217 Section 6 (See Section 6.9 for more information)



This device supports LTE capabilities with overlapping transmission frequency ranges. When the supported frequency range of an LTE Band falls completely within an LTE band with a larger transmission frequency range, both LTE bands have the same target power (or the band with the larger transmission frequency range has a higher target power), and both LTE bands share the same transmission path and signal characteristics, SAR was only assessed for the band with the larger transmission frequency range.

1.7 Guidance Applied

- IEEE 1528-2013
- FCC KDB Publication 941225 D01v03r01, D05v02r04, D05Av01r02, D06v02r01 (2G/3G/4G and Hotspot)
- FCC KDB Publication 248227 D01v02r02 (SAR Considerations for 802.11 Devices)
- FCC KDB Publication 447498 D01v06 (General SAR Guidance)
- FCC KDB Publication 865664 D01v01r04, D02v01r02 (SAR Measurements up to 6 GHz)
- FCC KDB Publication 648474 D04v01r03 (Phablet Procedures)
- FCC KDB Publication 616217 D04v01r02 (Proximity Sensor)
- October 2013 TCB Workshop Notes (GPRS Testing Considerations)



1.8 Device Serial Numbers

Several samples with identical hardware were used to support SAR testing. The manufacturer has confirmed that the device(s) tested have the same physical, mechanical and thermal characteristics and are within operational tolerances expected for production units. The serial numbers used for each test are indicated alongside the results in Section 11.

FCC ID: A3LSMA127M	 PCTEST <small>Proven to be part of the solution</small>	SAR EVALUATION REPORT		Approved by: Quality Manager
Document S/N: 1M2106030063-01.A3L (Rev 1)	Test Dates: 05/31/2021 - 07/07/2021	DUT Type: Portable Handset		Page 9 of 68

2 LTE INFORMATION

LTE Information					
Form Factor	Portable Handset				
	LTE Band 12 (704 - 711 MHz)				
	LTE Band 17 (709 - 711 MHz)				
	LTE Band 26 (Cell) (821.5 - 841.5 MHz)				
	LTE Band 5 (Cell) (829 - 844 MHz)				
	LTE Band 66 (AWS) (1720 - 1770 MHz)				
	LTE Band 4 (AWS) (1720 - 1745 MHz)				
	LTE Band 2 (PCS) (1860 - 1900 MHz)				
	LTE Band 41 (2498.5 - 2687.5 MHz)				
	LTE Band 12: 1.4 MHz, 3 MHz, 5 MHz, 10 MHz				
	LTE Band 17: 5 MHz, 10 MHz				
	LTE Band 26 (Cell): 1.4 MHz, 3 MHz, 5 MHz, 10 MHz, 15 MHz				
	LTE Band 5 (Cell): 1.4 MHz, 3 MHz, 5 MHz, 10 MHz				
	LTE Band 66 (AWS): 1.4 MHz, 3 MHz, 5 MHz, 10 MHz, 15 MHz, 20 MHz				
	LTE Band 4 (AWS): 1.4 MHz, 3 MHz, 5 MHz, 10 MHz, 15 MHz, 20 MHz				
	LTE Band 2 (PCS): 1.4 MHz, 3 MHz, 5 MHz, 10 MHz, 15 MHz, 20 MHz				
	LTE Band 41: 5 MHz, 10 MHz, 15 MHz, 20 MHz				
Channel Numbers and Frequencies (MHz)	Low	Low-Mid	Mid	Mid-High	High
LTE Band 12: 1.4 MHz	699.7 (23017)		707.5 (23095)		715.3 (23173)
LTE Band 12: 3 MHz	700.5 (23025)		707.5 (23095)		714.5 (23165)
LTE Band 12: 5 MHz	701.5 (23035)		707.5 (23095)		713.5 (23155)
LTE Band 12: 10 MHz	704 (23060)		707.5 (23095)		711 (23130)
LTE Band 17: 5 MHz	706.5 (23755)		710 (23790)		713.5 (23825)
LTE Band 17: 10 MHz	709 (23780)		710 (23790)		711 (23800)
LTE Band 26 (Cell): 1.4 MHz	814.7 (26697)		831.5 (26865)		848.3 (27033)
LTE Band 26 (Cell): 3 MHz	815.5 (26705)		831.5 (26865)		847.5 (27025)
LTE Band 26 (Cell): 5 MHz	816.5 (26715)		831.5 (26865)		846.5 (27015)
LTE Band 26 (Cell): 10 MHz	819 (26740)		831.5 (26865)		844 (26990)
LTE Band 26 (Cell): 15 MHz	821.5 (26765)		831.5 (26865)		841.5 (26965)
LTE Band 5 (Cell): 1.4 MHz	824.7 (20407)		836.5 (20525)		848.3 (20643)
LTE Band 5 (Cell): 3 MHz	825.5 (20415)		836.5 (20525)		847.5 (20635)
LTE Band 5 (Cell): 5 MHz	826.5 (20425)		836.5 (20525)		846.5 (20625)
LTE Band 5 (Cell): 10 MHz	829 (20450)		836.5 (20525)		844 (20600)
LTE Band 66 (AWS): 1.4 MHz	1710.7 (131979)		1745 (132322)		1779.3 (132665)
LTE Band 66 (AWS): 3 MHz	1711.5 (131987)		1745 (132322)		1778.5 (132657)
LTE Band 66 (AWS): 5 MHz	1712.5 (131997)		1745 (132322)		1777.5 (132647)
LTE Band 66 (AWS): 10 MHz	1715 (132022)		1745 (132322)		1775 (132622)
LTE Band 66 (AWS): 15 MHz	1717.5 (132047)		1745 (132322)		1772.5 (132597)
LTE Band 66 (AWS): 20 MHz	1720 (132072)		1745 (132322)		1770 (132572)
LTE Band 4 (AWS): 1.4 MHz	1710.7 (19957)		1732.5 (20175)		1754.3 (20393)
LTE Band 4 (AWS): 3 MHz	1711.5 (19965)		1732.5 (20175)		1753.5 (20385)
LTE Band 4 (AWS): 5 MHz	1712.5 (19975)		1732.5 (20175)		1752.5 (20375)
LTE Band 4 (AWS): 10 MHz	1715 (20000)		1732.5 (20175)		1750 (20350)
LTE Band 4 (AWS): 15 MHz	1717.5 (20025)		1732.5 (20175)		1747.5 (20325)
LTE Band 4 (AWS): 20 MHz	1720 (20050)		1732.5 (20175)		1745 (20300)
LTE Band 2 (PCS): 1.4 MHz	1850.7 (18607)		1880 (18900)		1909.3 (19193)
LTE Band 2 (PCS): 3 MHz	1851.5 (18615)		1880 (18900)		1908.5 (19185)
LTE Band 2 (PCS): 5 MHz	1852.5 (18625)		1880 (18900)		1907.5 (19175)
LTE Band 2 (PCS): 10 MHz	1855 (18650)		1880 (18900)		1905 (19150)
LTE Band 2 (PCS): 15 MHz	1857.5 (18675)		1880 (18900)		1902.5 (19125)
LTE Band 2 (PCS): 20 MHz	1860 (18700)		1880 (18900)		1900 (19100)
LTE Band 41: 5 MHz	2506 (39750)	2549.5 (40185)	2593 (40620)	2636.5 (41055)	2680 (41490)
LTE Band 41: 10 MHz	2506 (39750)	2549.5 (40185)	2593 (40620)	2636.5 (41055)	2680 (41490)
LTE Band 41: 15 MHz	2506 (39750)	2549.5 (40185)	2593 (40620)	2636.5 (41055)	2680 (41490)
LTE Band 41: 20 MHz	2506 (39750)	2549.5 (40185)	2593 (40620)	2636.5 (41055)	2680 (41490)
UE Category	DL UE Cat 4, UL UE Cat 4				
Modulations Supported in UL	QPSK, 16QAM				
LTE MPR Permanently implemented per 3GPP TS 36.101 section 6.2.3~6.2.5? (manufacturer attestation to be provided)	YES				
A-MPR (Additional MPR) disabled for SAR Testing?	YES				
LTE Additional Information	This device does not support full CA features on 3GPP Release 10. All uplink communications are identical to the Release 8 Specifications. The following LTE Release 10 Features are not supported: Carrier Aggregation, Relay, HetNet, Enhanced MIMO, eICIC, WIFI Offloading, eMBMS, Cross-Carrier Scheduling, Enhanced SC-FDMA.				

FCC ID: A3LSMA127M	 PCTEST Proud to be part of 	SAR EVALUATION REPORT		Approved by: Quality Manager
Document S/N: 1M2106030063-01.A3L (Rev 1)	Test Dates: 05/31/2021 - 07/07/2021	DUT Type: Portable Handset		Page 10 of 68

3 INTRODUCTION

The FCC and Innovation, Science, and Economic Development Canada have adopted the guidelines for evaluating the environmental effects of radio frequency (RF) radiation in ET Docket 93-62 on Aug. 6, 1996 and Health Canada Safety Code 6 to protect the public and workers from the potential hazards of RF emissions due to FCC-regulated portable devices. [1]

The safety limits used for the environmental evaluation measurements are based on the criteria published by the American National Standards Institute (ANSI) for localized specific absorption rate (SAR) in IEEE/ANSI C95.1-1992 Standard for Safety Levels with Respect to Human Exposure to Radio Frequency Electromagnetic Fields, 3 kHz to 300 GHz [3] and Health Canada RF Exposure Guidelines Safety Code 6 [22]. The measurement procedure described in IEEE/ANSI C95.3-2002 Recommended Practice for the Measurement of Potentially Hazardous Electromagnetic Fields - RF and Microwave [4] is used for guidance in measuring the Specific Absorption Rate (SAR) due to the RF radiation exposure from the Equipment Under Test (EUT). These criteria for SAR evaluation are similar to those recommended by the International Committee for Non-ionizing Radiation Protection (ICNIRP) in Biological Effects and Exposure Criteria for Radiofrequency Electromagnetic Fields,” Report No. Vol 74. SAR is a measure of the rate of energy absorption due to exposure to an RF transmitting source. SAR values have been related to threshold levels for potential biological hazards.

3.1 SAR Definition

Specific Absorption Rate is defined as the time derivative (rate) of the incremental energy (dU) absorbed by (dissipated in) an incremental mass (dm) contained in a volume element (dV) of a given density (ρ). It is also defined as the rate of RF energy absorption per unit mass at a point in an absorbing body (see Equation 3-1).

Equation 3-1
SAR Mathematical Equation

$$SAR = \frac{d}{dt} \left(\frac{dU}{dm} \right) = \frac{d}{dt} \left(\frac{dU}{\rho dv} \right)$$



SAR is expressed in units of Watts per Kilogram (W/kg).

$$SAR = \frac{\sigma \cdot E^2}{\rho}$$

where:

- σ = conductivity of the tissue-simulating material (S/m)
- ρ = mass density of the tissue-simulating material (kg/m³)
- E = Total RMS electric field strength (V/m)

NOTE: The primary factors that control rate of energy absorption were found to be the wavelength of the incident field in relation to the dimensions and geometry of the irradiated organism, the orientation of the organism in relation to the polarity of field vectors, the presence of reflecting surfaces, and whether conductive contact is made by the organism with a ground plane.[6]

FCC ID: A3LSMA127M	 PCTEST <small>Proven to be part of the solution</small>	SAR EVALUATION REPORT		Approved by: Quality Manager
Document S/N: 1M2106030063-01.A3L (Rev 1)	Test Dates: 05/31/2021 - 07/07/2021	DUT Type: Portable Handset	Page 11 of 68	

4 DOSIMETRIC ASSESSMENT

4.1 Measurement Procedure

The evaluation was performed using the following procedure compliant to FCC KDB Publication 865664 D01v01r04 and IEEE 1528-2013:

1. The SAR distribution at the exposed side of the head or body was measured at a distance no greater than 5.0 mm from the inner surface of the shell. The area covered the entire dimension of the device-head and body interface and the horizontal grid resolution was determined per FCC KDB Publication 865664 D01v01r04 (See Table 4-1) and IEEE 1528-2013.
2. The point SAR measurement was taken at the maximum SAR region determined from Step 1 to enable the monitoring of SAR fluctuations/drifts during the 1g/10g cube evaluation. SAR at this fixed point was measured and used as a reference value.
3. Based on the area scan data, the peak of the region with maximum SAR was determined by spline interpolation. Around this point, a volume was assessed according to the measurement resolution and volume size requirements of FCC KDB Publication 865664 D01v01r04 (See Table 4-1) and IEEE 1528-2013. On the basis of this data set, the spatial peak SAR value was evaluated with the following procedure (see references or the DASY manual online for more details):
 - a. SAR values at the inner surface of the phantom are extrapolated from the measured values along the line away from the surface with spacing no greater than that in Table 4-1. The extrapolation was based on a least-squares algorithm. A polynomial of the fourth order was calculated through the points in the z-axis (normal to the phantom shell).
 - b. After the maximum interpolated values were calculated between the points in the cube, the SAR was averaged over the spatial volume (1g or 10g) using a 3D-Spline interpolation algorithm. The 3D-spline is composed of three one-dimensional splines with the “Not a knot” condition (in x, y, and z directions). The volume was then integrated with the trapezoidal algorithm. One thousand points (10 x 10 x 10) were obtained through interpolation, in order to calculate the averaged SAR.
 - c. All neighboring volumes were evaluated until no neighboring volume with a higher average value was found.
4. The SAR reference value, at the same location as step 2, was re-measured after the zoom scan was complete to calculate the SAR drift. If the drift deviated by more than 5%, the SAR test and drift measurements were repeated.

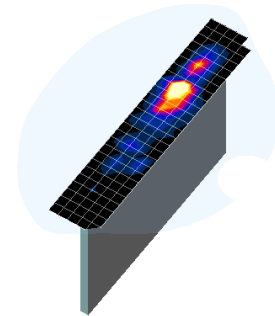



Figure 4-1
Sample SAR Area Scan

Table 4-1
Area and Zoom Scan Resolutions per FCC KDB Publication 865664 D01v01r04*

Frequency	Maximum Area Scan Resolution (mm) ($\Delta x_{\text{area}}, \Delta y_{\text{area}}$)	Maximum Zoom Scan Resolution (mm) ($\Delta x_{\text{zoom}}, \Delta y_{\text{zoom}}$)	Maximum Zoom Scan Spatial Resolution (mm)			Minimum Zoom Scan Volume (mm) (x,y,z)
			Uniform Grid	Graded Grid		
			$\Delta z_{\text{zoom}}(n)$	$\Delta z_{\text{zoom}}(1)^*$	$\Delta z_{\text{zoom}}(n>1)^*$	
≤ 2 GHz	≤ 15	≤ 8	≤ 5	≤ 4	≤ 1.5* $\Delta z_{\text{zoom}}(n-1)$	≥ 30
2-3 GHz	≤ 12	≤ 5	≤ 5	≤ 4	≤ 1.5* $\Delta z_{\text{zoom}}(n-1)$	≥ 30
3-4 GHz	≤ 12	≤ 5	≤ 4	≤ 3	≤ 1.5* $\Delta z_{\text{zoom}}(n-1)$	≥ 28
4-5 GHz	≤ 10	≤ 4	≤ 3	≤ 2.5	≤ 1.5* $\Delta z_{\text{zoom}}(n-1)$	≥ 25
5-6 GHz	≤ 10	≤ 4	≤ 2	≤ 2	≤ 1.5* $\Delta z_{\text{zoom}}(n-1)$	≥ 22

*Also compliant to IEEE 1528-2013 Table 6

FCC ID: A3LSMA127M	 PCTEST <small>Proved to be part of @ samsung</small>	SAR EVALUATION REPORT		Approved by: Quality Manager
Document S/N: 1M2106030063-01.A3L (Rev 1)	Test Dates: 05/31/2021 - 07/07/2021	DUT Type: Portable Handset		Page 12 of 68

5 DEFINITION OF REFERENCE POINTS

5.1 EAR REFERENCE POINT

Figure 5-2 shows the front, back and side views of the SAM Twin Phantom. The point “M” is the reference point for the center of the mouth, “LE” is the left ear reference point (ERP), and “RE” is the right ERP. The ERP is 15mm posterior to the entrance to the ear canal (EEC) along the B-M line (Back-Mouth), as shown in Figure 5-1. The plane passing through the two ear canals and M is defined as the Reference Plane. The line N-F (Neck-Front), also called the Reference Pivoting Line, is not perpendicular to the reference plane (see Figure 5-1). Line B-M is perpendicular to the N-F line. Both N-F and B-M lines are marked on the external phantom shell to facilitate handset positioning [5].

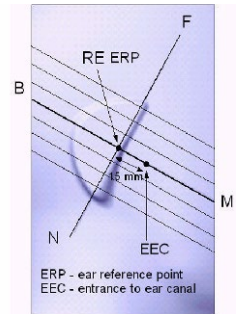

Figure 5-1
Close-Up Side view of ERP

5.2 HANDSET REFERENCE POINTS

Two imaginary lines on the handset were established: the vertical centerline and the horizontal line. The test device was placed in a normal operating position with the acoustic output located along the “vertical centerline” on the front of the device aligned to the “ear reference point” (See Figure 5-3). The acoustic output was then located at the same level as the center of the ear reference point. The test device was positioned so that the “vertical centerline” was bisecting the front surface of the handset at its top and bottom edges, positioning the “ear reference point” on the outer surface of the both the left and right head phantoms on the ear reference point.

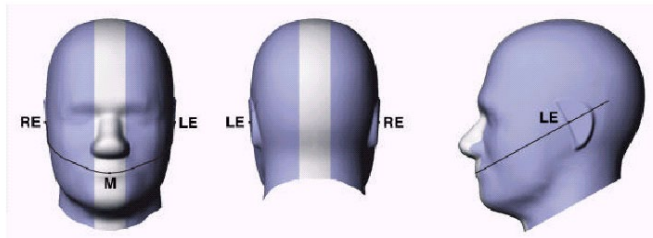

Figure 5-2
Front, back and side view of SAM Twin Phantom

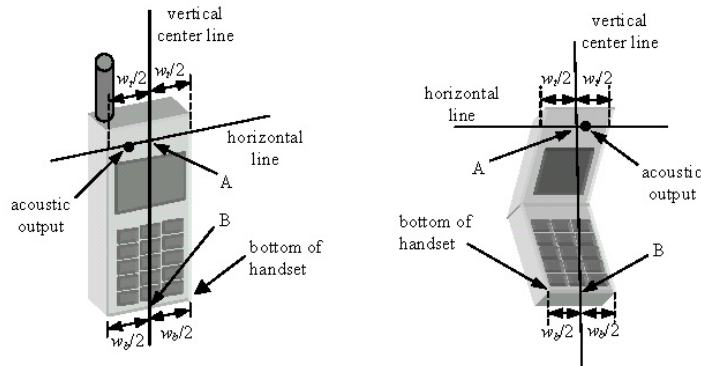





Figure 5-3
Handset Vertical Center & Horizontal Line Reference Points

FCC ID: A3LSMA127M	 PCTEST Proud to be part of 	SAR EVALUATION REPORT		Approved by: Quality Manager
Document S/N: 1M2106030063-01.A3L (Rev 1)	Test Dates: 05/31/2021 - 07/07/2021	DUT Type: Portable Handset		Page 13 of 68

6 TEST CONFIGURATION POSITIONS

6.1 Device Holder

The device holder is made out of low-loss POM material having the following dielectric parameters: relative permittivity $\epsilon = 3$ and loss tangent $\delta = 0.02$.

6.2 Positioning for Cheek

1. The test device was positioned with the device close to the surface of the phantom such that point A is on the (virtual) extension of the line passing through points RE and LE on the phantom (see Figure 6-1), such that the plane defined by the vertical center line and the horizontal line of the phone is approximately parallel to the sagittal plane of the phantom.

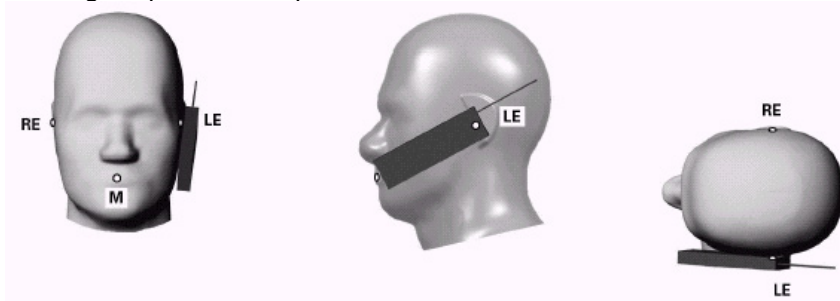



Figure 6-1 Front, Side and Top View of Cheek Position

2. The handset was translated towards the phantom along the line passing through RE & LE until the handset touches the pinna.
3. While maintaining the handset in this plane, the handset was rotated around the LE-RE line until the vertical centerline was in the reference plane.
4. The phone was then rotated around the vertical centerline until the phone (horizontal line) was symmetrical with respect to the line NF.
5. While maintaining the vertical centerline in the reference plane, keeping point A on the line passing through RE and LE, and maintaining the device contact with the ear, the device was rotated about the NF line until any point on the handset made contact with a phantom point below the ear (cheek) (See Figure 6-2).

6.3 Positioning for Ear / 15° Tilt

With the test device aligned in the “Cheek Position”:

1. While maintaining the orientation of the phone, the phone was retracted parallel to the reference plane far enough to enable a rotation of the phone by 15 degrees.
2. The phone was then rotated around the horizontal line by 15 degrees.
3. While maintaining the orientation of the phone, the phone was moved parallel to the reference plane until any part of the handset touched the head. (In this position, point A was located on the line RE-LE). The tilted position is obtained when the contact is on the pinna. If the contact was at any location other than the pinna, the angle of the phone would then be reduced. In this situation, the tilted position was obtained when any part of the phone was in contact of the ear as well as a second part of the phone was in contact with the head (see Figure 6-2).

FCC ID: A3LSMA127M	 PCTEST Proud to be part of Samsung	SAR EVALUATION REPORT		Approved by: Quality Manager
Document S/N: 1M2106030063-01.A3L (Rev 1)	Test Dates: 05/31/2021 - 07/07/2021	DUT Type: Portable Handset		Page 14 of 68

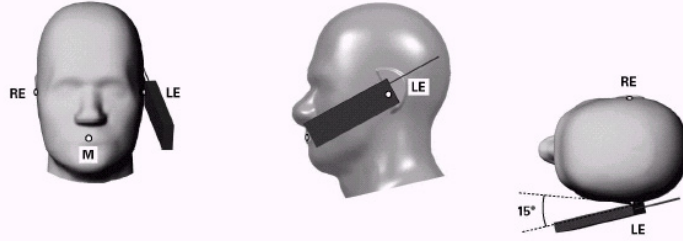

Figure 6-2 Front, Side and Top View of Ear/15° Tilt Position

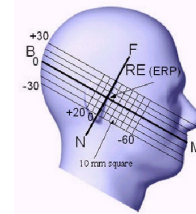

Figure 6-3 Side view w/ relevant markings

6.4 SAR Evaluations near the Mouth/Jaw Regions of the SAM Phantom

Antennas located near the bottom of a phone may require SAR measurements around the mouth and jaw regions of the SAM head phantom. This typically applies to clam-shell style phones that are generally longer in the unfolded normal use positions or to certain older style long rectangular phones. Per IEEE 1528-2013, a rotated SAM phantom is necessary to allow probe access to such regions. Both SAM heads of the TwinSAM-Chin20 are rotated 20 degrees around the NF line. Each head can be removed from the table for emptying and cleaning.

Under these circumstances, the following procedures apply, adopted from the FCC guidance on SAR handsets document FCC KDB Publication 648474 D04v01r03. The SAR required in these regions of SAM should be measured using a flat phantom. The phone should be positioned with a separation distance of 4 mm between the ear reference point (ERP) and the outer surface of the flat phantom shell. While maintaining this distance at the ERP location, the low (bottom) edge of the phone should be lowered from the phantom to establish the same separation distance between the peak SAR location identified by the truncated partial SAR distribution measured with the SAM phantom. The distance from the peak SAR location to the phone is determined by the straight line passing perpendicularly through the phantom surface. When it is not feasible to maintain 4 mm separation at the ERP while also establishing the required separation at the peak SAR location, the top edge of the phone will be allowed to touch the phantom with a separation < 4 mm at the ERP. The phone should not be tilted to the left or right while placed in this inclined position to the flat phantom.

6.5 Body-Worn Accessory Configurations

Body-worn operating configurations are tested with the belt-clips and holsters attached to the device and positioned against a flat phantom in a normal use configuration (see Figure 6-4). Per FCC KDB Publication 648474 D04v01r03, Body-worn accessory exposure is typically related to voice mode operations when handsets are carried in body-worn accessories. The body-worn accessory procedures in FCC KDB Publication 447498 D01v06 should be used to test for body-worn accessory SAR compliance, without a headset connected to it. This enables the test results for such configuration to be compatible with that required for hotspot mode when the body-worn accessory test separation distance is greater than or equal to that required for hotspot mode, when applicable. When the reported SAR for a body-worn accessory, measured without a headset connected to the handset, is > 1.2 W/kg, the highest reported SAR configuration for that wireless mode and frequency band should be repeated for that body-worn accessory with a headset attached to the handset.

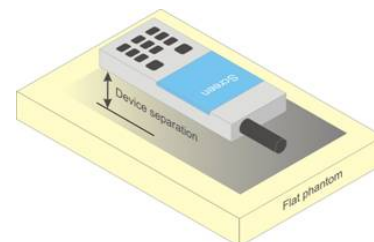



Figure 6-4 Sample Body-Worn Diagram

Accessories for Body-worn operation configurations are divided into two categories: those that do not contain metallic components and those that do contain metallic components. When multiple accessories that do not

FCC ID: A3LSMA127M	 PCTEST Proud to be part of Samsung	SAR EVALUATION REPORT		Approved by: Quality Manager
Document S/N: 1M2106030063-01.A3L (Rev 1)	Test Dates: 05/31/2021 - 07/07/2021	DUT Type: Portable Handset	Page 15 of 68	

contain metallic components are supplied with the device, the device is tested with only the accessory that dictates the closest spacing to the body. Then multiple accessories that contain metallic components are tested with the device with each accessory. If multiple accessories share an identical metallic component (i.e. the same metallic belt-clip used with different holsters with no other metallic components) only the accessory that dictates the closest spacing to the body is tested.

Body-worn accessories may not always be supplied or available as options for some devices intended to be authorized for body-worn use. In this case, a test configuration with a separation distance between the back of the device and the flat phantom is used. Test position spacing was documented. Transmitters that are designed to operate in front of a person's face, as in push-to-talk configurations, are tested for SAR compliance with the front of the device positioned to face the flat phantom in head fluid. For devices that are carried next to the body such as a shoulder, waist or chest-worn transmitters, SAR compliance is tested with the accessories, including headsets and microphones, attached to the device and positioned against a flat phantom in a normal use configuration.

6.6 Extremity Exposure Configurations



Devices that are designed or intended for use on extremities or mainly operated in extremity only exposure conditions; i.e., hands, wrists, feet and ankles, may require extremity SAR evaluation. When the device also operates in close proximity to the user's body, SAR compliance for the body is also required. The 1g body and 10g extremity SAR Exclusion Thresholds found in KDB Publication 447498 D01v06 should be applied to determine SAR test requirements.

Per KDB Publication 447498 D01v06, Cell phones (handsets) are not normally designed to be used on extremities or operated in extremity only exposure conditions. The maximum output power levels of handsets generally do not require extremity SAR testing to show compliance. Therefore, extremity SAR was not evaluated for this device.

6.7 Wireless Router Configurations

Some battery-operated handsets have the capability to transmit and receive user data through simultaneous transmission of WIFI simultaneously with a separate licensed transmitter. The FCC has provided guidance in FCC KDB Publication 941225 D06v02r01 where SAR test considerations for handsets ($L \times W \geq 9 \text{ cm} \times 5 \text{ cm}$) are based on a composite test separation distance of 10 mm from the front, back and edges of the device containing transmitting antennas within 2.5 cm of their edges, determined from general mixed use conditions for this type of devices. Since the hotspot SAR results may overlap with the body-worn accessory SAR requirements, the more conservative configurations can be considered, thus excluding some body-worn accessory SAR tests.

When the user enables the personal wireless router functions for the handset, actual operations include simultaneous transmission of both the WIFI transmitter and another licensed transmitter. Both transmitters often do not transmit at the same transmitting frequency and thus cannot be evaluated for SAR under actual use conditions due to the limitations of the SAR assessment probes. Therefore, SAR must be evaluated for each frequency transmission and mode separately and spatially summed with the WIFI transmitter according to FCC KDB Publication 447498 D01v06 procedures. The "Portable Hotspot" feature on the handset was NOT activated during SAR assessments, to ensure the SAR measurements were evaluated for a single transmission frequency RF signal at a time.

FCC ID: A3LSMA127M	 <small>Proud to be part of the</small>	SAR EVALUATION REPORT	 Approved by: Quality Manager
Document S/N: 1M2106030063-01.A3L (Rev 1)	Test Dates: 05/31/2021 - 07/07/2021	DUT Type: Portable Handset	Page 16 of 68

6.8 Phablet Configurations



For smart phones with a display diagonal dimension > 150 mm or an overall diagonal dimension > 160 mm that provide similar mobile web access and multimedia support found in mini-tablets or UMPC mini-tablets that support voice calls next to the ear, the phablets procedures outlined in KDB Publication 648474 D04v01r03 should be applied to evaluate SAR compliance. A device marketed as phablets, regardless of form factors and operating characteristics must be tested as a phablet to determine SAR compliance. In addition to the normally required head and body-worn accessory SAR test procedures required for handsets, the UMPC mini-tablet procedures must also be applied to test the SAR of all surfaces and edges with an antenna ≤ 25 mm from that surface or edge, in direct contact with the phantom, for 10g SAR. The UMPC mini-tablet 1g SAR at 5 mm is not required. When hotspot mode applies, 10g SAR is required only for the surfaces and edges with hotspot mode 1g SAR > 1.2 W/kg.

6.9 Proximity Sensor Considerations

This device uses a power reduction mechanism to reduce output powers in certain use conditions when the device is used close the user's body.

When the device's antenna is within a certain distance of the user, the sensor activates and reduces the maximum allowed output power. However, the sensor is not active when the device is moved beyond the sensor triggering distance and the maximum output power is no longer limited. Therefore, additional evaluation is needed in the vicinity of the triggering distance to ensure SAR is compliant when the device is allowed to operate at a non-reduced output power level. FCC KDB Publication 616217 D04v01r02 Section 6 was used as a guideline for selecting SAR test distances for this device at these additional test positions. Sensor triggering distance summary data is included in Appendix G.

The sensor is designed to support sufficient detection range and sensitivity to cover regions of the sensors in all applicable directions since the sensor entirely covers the antennas.

FCC ID: A3LSMA127M	 PCTEST <small>Proud to be part of Samsung</small>	SAR EVALUATION REPORT		Approved by: Quality Manager
Document S/N: 1M2106030063-01.A3L (Rev 1)	Test Dates: 05/31/2021 - 07/07/2021	DUT Type: Portable Handset	Page 17 of 68	

7 RF EXPOSURE LIMITS

7.1 Uncontrolled Environment

UNCONTROLLED ENVIRONMENTS are defined as locations where there is the exposure of individuals who have no knowledge or control of their exposure. The general population/uncontrolled exposure limits are applicable to situations in which the general public may be exposed or in which persons who are exposed as a consequence of their employment may not be made fully aware of the potential for exposure or cannot exercise control over their exposure. Members of the general public would come under this category when exposure is not employment-related; for example, in the case of a wireless transmitter that exposes persons in its vicinity.



7.2 Controlled Environment

CONTROLLED ENVIRONMENTS are defined as locations where there is exposure that may be incurred by persons who are aware of the potential for exposure, (i.e. as a result of employment or occupation). In general, occupational/controlled exposure limits are applicable to situations in which persons are exposed as a consequence of their employment, who have been made fully aware of the potential for exposure and can exercise control over their exposure. This exposure category is also applicable when the exposure is of a transient nature due to incidental passage through a location where the exposure levels may be higher than the general population/uncontrolled limits, but the exposed person is fully aware of the potential for exposure and can exercise control over his or her exposure by leaving the area or by some other appropriate means.

**Table 7-1
SAR Human Exposure Specified in ANSI/IEEE C95.1-1992 and Health Canada Safety Code 6**

HUMAN EXPOSURE LIMITS		
	UNCONTROLLED ENVIRONMENT <i>General Population</i> (W/kg) or (mW/g)	CONTROLLED ENVIRONMENT <i>Occupational</i> (W/kg) or (mW/g)
Peak Spatial Average SAR Head	1.6	8.0
Whole Body SAR	0.08	0.4
Peak Spatial Average SAR Hands, Feet, Ankle, Wrists, etc.	4.0	20

1. The Spatial Peak value of the SAR averaged over any 1 gram of tissue (defined as a tissue volume in the shape of a cube) and over the appropriate averaging time.
2. The Spatial Average value of the SAR averaged over the whole body.
3. The Spatial Peak value of the SAR averaged over any 10 grams of tissue (defined as a tissue volume in the shape of a cube) and over the appropriate averaging time.

FCC ID: A3LSMA127M	 PCTEST <small>Prove it to be part of @ctest</small>	SAR EVALUATION REPORT		Approved by: Quality Manager
Document S/N: 1M2106030063-01.A3L (Rev 1)	Test Dates: 05/31/2021 - 07/07/2021	DUT Type: Portable Handset	Page 18 of 68	

8 FCC MEASUREMENT PROCEDURES

Power measurements for licensed transmitters are performed using a base station simulator under digital average power.

8.1 Measured and Reported SAR

Per FCC KDB Publication 447498 D01v06, when SAR is not measured at the maximum power level allowed for production units, the results must be scaled to the maximum tune-up tolerance limit according to the power applied to the individual channels tested to determine compliance. For simultaneous transmission, the measured aggregate SAR must be scaled according to the sum of the differences between the maximum tune-up tolerance and actual power used to test each transmitter. When SAR is measured at or scaled to the maximum tune-up tolerance limit, the results are referred to as *reported* SAR. The highest *reported* SAR results are identified on the grant of equipment authorization according to procedures in KDB 690783 D01v01r03.

8.2 3G SAR Test Reduction Procedure

In FCC KDB Publication 941225 D01v03r01, certain transmission modes within a frequency band and wireless mode evaluated for SAR are defined as primary modes. The equivalent modes considered for SAR test reduction are denoted as secondary modes. When the maximum output power including tune-up tolerance specified for production units in a secondary mode is ≤ 0.25 dB higher than the primary mode or when the highest reported SAR of the primary mode, scaled by the ratio of specified maximum output power and tune-up tolerance of secondary to primary mode, is ≤ 1.2 W/kg, SAR measurements are not required for the secondary mode. These criteria are referred to as the 3G SAR test reduction procedure. When the 3G SAR test reduction procedure is not satisfied, SAR measurements are additionally required for the secondary mode.

8.3 Procedures Used to Establish RF Signal for SAR



The following procedures are according to FCC KDB Publication 941225 D01v03r01 “3G SAR Measurement Procedures.”

The device is placed into a simulated call using a base station simulator in a RF shielded chamber. Establishing connections in this manner ensure a consistent means for testing SAR and are recommended for evaluating SAR [4]. Devices under test are evaluated prior to testing, with a fully charged battery and were configured to operate at maximum output power. In order to verify that the device is tested throughout the SAR test at maximum output power, the SAR measurement system measures a “point SAR” at an arbitrary reference point at the start and end of the 1 gram SAR evaluation, to assess for any power drifts during the evaluation. If the power drift deviates by more than 5%, the SAR test and drift measurements are repeated.

8.4 SAR Measurement Conditions for UMTS

8.4.1 Output Power Verification

Maximum output power is verified on the High, Middle and Low channels according to the general descriptions in section 5.2 of 3GPP TS 34.121, using the appropriate RMC with TPC (transmit power control) set to all “1s” or applying the required inner loop power control procedures to maintain maximum output power while HSUPA is active. Results for all applicable physical channel configurations (DPCCH, DPDCHn and spreading codes, HS-DPCCH etc) are tabulated in this test report. All configurations that are not supported by the DUT or cannot be measured due to technical or equipment limitations are identified.

FCC ID: A3LSMA127M	 PCTEST <small>Proven to be part of @ solutions</small>	SAR EVALUATION REPORT		Approved by: Quality Manager
Document S/N: 1M2106030063-01.A3L (Rev 1)	Test Dates: 05/31/2021 - 07/07/2021	DUT Type: Portable Handset		Page 19 of 68

8.4.2 Head SAR Measurements

SAR for next to the ear head exposure is measured using a 12.2 kbps RMC with TPC bits configured to all “1’s”. The 3G SAR test reduction procedure is applied to AMR configurations with 12.2 kbps RMC as the primary mode. Otherwise, SAR is measured for 12.2 kbps AMR in 3.4 kbps SRB (signaling radio bearer) using the highest reported SAR configuration in 12.2 kbps RMC for head exposure.

8.4.3 Body SAR Measurements

SAR for body exposure configurations is measured using the 12.2 kbps RMC with the TPC bits all “1s”. The 3G SAR test reduction procedure is applied to other spreading codes and multiple DPDCH_n configurations supported by the handset with 12.2 kbps RMC as the primary mode. Otherwise, SAR is measured using an applicable RMC configuration with the corresponding spreading code or DPDCH_n, for the highest reported SAR configuration in 12.2 kbps RMC.

8.4.4 SAR Measurements with Rel 5 HSDPA

The 3G SAR test reduction procedure is applied to HSDPA body configurations with 12.2 kbps RMC as the primary mode. Otherwise, Body SAR for HSDPA is measured using an FRC with H-Set 1 in Sub-test 1 and a 12.2 kbps RMC configured in Test Loop Mode 1, for the highest reported SAR configuration in 12.2 kbps RMC without HSDPA. Handsets with both HSDPA and HSUPA are tested according to Release 6 HSPA test procedures.

8.4.5 SAR Measurements with Rel 6 HSUPA

The 3G SAR test reduction procedure is applied to HSPA (HSUPA/HSDPA with RMC) body configurations with 12.2 kbps RMC as the primary mode. Otherwise, Body SAR for HSPA is measured with E-DCH Sub-test 5, using H-Set 1 and QPSK for FRC and a 12.2 kbps RMC configured in Test Loop Mode 1 and power control algorithm 2, according to the highest reported body SAR configuration in 12.2 kbps RMC without HSPA.



When VOIP applies to head exposure, the 3G SAR test reduction procedure is applied with 12.2 kbps RMC as the primary mode; otherwise, the same HSPA configuration used for body SAR measurements are applied to head exposure testing.

8.4.6 SAR Measurement Conditions for DC-HSDPA

SAR is required for Rel. 8 DC-HSDPA when SAR is required for Rel. 5 HSDPA; otherwise, the 3G SAR test reduction procedure is applied to DC-HSDPA with 12.2 kbps RMC as the primary mode. Power is measured for DC-HSDPA according to the H-Set 12, FRC configuration in Table C.8.1.12 of 3GPP TS 34.121-1 to determine SAR test reduction. A primary and a secondary serving HS-DSCH Cell are required to perform the power measurement and for the results to be acceptable.

8.5 SAR Measurement Conditions for LTE

LTE modes are tested according to FCC KDB 941225 D05v02r04 publication. Establishing connections with base station simulators ensure a consistent means for testing SAR and are recommended for evaluating SAR [4]. The R&S CMW500 or Anritsu MT8820C simulators are used for LTE output power measurements and SAR testing. Closed loop power control was used so the UE transmits with maximum output power during SAR testing. SAR tests were performed with the same number of RB and RB offsets transmitting on all TTI frames (maximum TTI).

FCC ID: A3LSMA127M	 PCTEST Proud to be part of Samsung	SAR EVALUATION REPORT		Approved by: Quality Manager
Document S/N: 1M2106030063-01.A3L (Rev 1)	Test Dates: 05/31/2021 - 07/07/2021	DUT Type: Portable Handset	Page 20 of 68	

8.5.1 Spectrum Plots for RB Configurations

A properly configured base station simulator was used for SAR tests and power measurements. Therefore, spectrum plots for RB configurations were not required to be included in this report.

8.5.2 MPR

MPR is permanently implemented for this device by the manufacturer. The specific manufacturer target MPR is indicated alongside the SAR results. MPR is enabled for this device, according to 3GPP TS36.101 Section 6.2.3 – 6.2.5 under Table 6.2.3-1.

8.5.3 A-MPR

A-MPR (Additional MPR) has been disabled for all SAR tests by setting NS=01 on the base station simulator.

8.5.4 Required RB Size and RB Offsets for SAR Testing

According to FCC KDB 941225 D05v02r04:



- a. Per Section 5.2.1, SAR is required for QPSK 1 RB Allocation for the largest bandwidth
 - i. The required channel and offset combination with the highest maximum output power is required for SAR.
 - ii. When the reported SAR is ≤ 0.8 W/kg, testing of the remaining RB offset configurations and required test channels is not required. Otherwise, SAR is required for the remaining required test channels using the RB offset configuration with highest output power for that channel.
 - iii. When the reported SAR for a required test channel is > 1.45 W/kg, SAR is required for all RB offset configurations for that channel.
- b. Per Section 5.2.2, SAR is required for 50% RB allocation using the largest bandwidth following the same procedures outlined in Section 5.2.1.
- c. Per Section 5.2.3, QPSK SAR is not required for the 100% allocation when the highest maximum output power for the 100% allocation is less than the highest maximum output power of the 1 RB and 50% RB allocations and the reported SAR for the 1 RB and 50% RB allocations is < 0.8 W/kg.
- d. Per Section 5.2.4 and 5.3, SAR tests for higher order modulations and lower bandwidths configurations are not required when the conducted power of the required test configurations determined by Sections 5.2.1 through 5.2.3 is less than or equal to $\frac{1}{2}$ dB higher than the equivalent configuration using QPSK modulation and when the QPSK SAR for those configurations is < 1.45 W/kg.

8.5.5 TDD

LTE TDD testing is performed using the SAR test guidance provided in FCC KDB 941225 D05v02r04. TDD is tested at the highest duty factor using UL-DL configuration 0 with special subframe configuration 6 and applying the FDD LTE procedures in KDB 941225 D05v02r04. SAR testing is performed using the extended cyclic prefix listed in 3GPP TS 36.211 Section 4.

8.5.6 Downlink Only Carrier Aggregation

Conducted power measurements with LTE Carrier Aggregation (CA) (downlink only) active are made in accordance to KDB Publication 941225 D05Av01r02. The RRC connection is only handled by one cell, the primary component carrier (PCC) for downlink and uplink communications. After making a data connection to the PCC, the UE device adds secondary component carrier(s) (SCC) on the downlink only.

FCC ID: A3LSMA127M	 PCTEST <small>Proved to be part of @intertek</small>	SAR EVALUATION REPORT		Approved by: Quality Manager
Document S/N: 1M2106030063-01.A3L (Rev 1)	Test Dates: 05/31/2021 - 07/07/2021	DUT Type: Portable Handset	Page 21 of 68	

All uplink communications and acknowledgements remain identical to specifications when downlink carrier aggregation is inactive on the PCC. Additional conducted output powers are measured with the downlink carrier aggregation active for the configuration with highest measured maximum conducted power with downlink carrier aggregation inactive measured among the channel bandwidth, modulation, and RB combinations in each frequency band. Per FCC KDB Publication 941225 D05Av01r02, no SAR measurements are required for downlink only carrier aggregation configurations when the average output power with downlink only carrier aggregation active is not more than 0.25 dB higher than the average output power with downlink only carrier aggregation inactive.

8.6 SAR Testing with 802.11 Transmitters

The normal network operating configurations of 802.11 transmitters are not suitable for SAR measurements. Unpredictable fluctuations in network traffic and antenna diversity conditions can introduce undesirable variations in SAR results. The SAR for these devices should be measured using chipset based test mode software to ensure the results are consistent and reliable. See KDB Publication 248227 D01v02r02 for more details.

8.6.1 General Device Setup

Chipset based test mode software is hardware dependent and generally varies among manufacturers. The device operating parameters established in test mode for SAR measurements must be identical to those programmed in production units, including output power levels, amplifier gain settings and other RF performance tuning parameters.

A periodic duty factor is required for current generation SAR systems to measure SAR. When 802.11 frame gaps are accounted for in the transmission, a maximum transmission duty factor of 92 - 96% is typically achievable in most test mode configurations. A minimum transmission duty factor of 85% is required to avoid certain hardware and device implementation issues related to wide range SAR scaling. The reported SAR is scaled to 100% transmission duty factor to determine compliance at the maximum tune-up tolerance limit.



8.6.2 Initial Test Position Procedure

For exposure conditions with multiple test positions, such as handset operating next to the ear, devices with hotspot mode or UMPC mini-tablet, procedures for initial test position can be applied. Using the transmission mode determined by the DSSS procedure or initial test configuration, area scans are measured for all positions in an exposure condition. The test position with the highest extrapolated (peak) SAR is used as the initial test position. When reported SAR for the initial test position is ≤ 0.4 W/kg, no additional testing for the remaining test positions is required. Otherwise, SAR is evaluated at the subsequent highest peak SAR positions until the reported SAR result is ≤ 0.8 W/kg or all test positions are measured. When 10g SAR measurement is considered, a factor of 2.5 is applied to the thresholds above.

8.6.3 2.4 GHz SAR Test Requirements

SAR is measured for 2.4 GHz 802.11b DSSS using either the fixed test position or, when applicable, the initial test position procedure. SAR test reduction is determined according to the following:

- 1) When the reported SAR of the highest measured maximum output power channel for the exposure configuration is ≤ 0.8 W/kg, no further SAR testing is required for 802.11b DSSS in that exposure configuration.

FCC ID: A3LSMA127M	 <small>Proud to be part of the Samsung</small>	SAR EVALUATION REPORT	 Approved by: Quality Manager
Document S/N: 1M2106030063-01.A3L (Rev 1)	Test Dates: 05/31/2021 - 07/07/2021	DUT Type: Portable Handset	Page 22 of 68

- 2) When the reported SAR is > 0.8 W/kg, SAR is required for that position using the next highest measured output power channel. When any reported SAR is > 1.2 W/kg, SAR is required for the third channel; i.e., all channels require testing.

2.4 GHz 802.11 g/n OFDM are additionally evaluated for SAR if the highest reported SAR for 802.11b, adjusted by the ratio of the OFDM to DSSS specified maximum output power, is > 1.2 W/kg. When SAR is required for OFDM modes in 2.4 GHz band, the Initial Test Configuration Procedures should be followed. When 10g SAR measurement is considered, a factor of 2.5 is applied to the thresholds above.

8.6.4 OFDM Transmission Mode and SAR Test Channel Selection

When the same maximum output power was specified for multiple OFDM transmission mode configurations in a frequency band or aggregated band, SAR is measured using the configuration with the largest channel bandwidth, lowest order modulation and lowest data rate. When the maximum output power of a channel is the same for equivalent OFDM configurations; for example, 802.11a, 802.11n and 802.11ac or 802.11g and 802.11n with the same channel bandwidth, modulation and data rate etc., the lower order 802.11 mode i.e., 802.11a, then 802.11n and 802.11ac or 802.11g then 802.11n, is used for SAR measurement. When the maximum output power are the same for multiple test channels, either according to the default or additional power measurement requirements, SAR is measured using the channel closest to the middle of the frequency band or aggregated band. When there are multiple channels with the same maximum output power, SAR is measured using the higher number channel.



8.6.5 Initial Test Configuration Procedure

For OFDM, an initial test configuration is determined for each frequency band and aggregated band, according to the transmission mode with the highest maximum output power specified for SAR measurements. When the same maximum output power is specified for multiple OFDM transmission mode configurations in a frequency band or aggregated band, SAR is measured using the configuration(s) with the largest channel bandwidth, lowest order modulation, lowest data rate and lowest order IEEE 802.11 mode. The channel of the transmission mode with the highest average RF output conducted power will be the initial test configuration.

When the reported SAR is ≤ 0.8 W/kg, no additional measurements on other test channels are required. Otherwise, SAR is evaluated using the subsequent highest average RF output channel until the reported SAR result is ≤ 1.2 W/kg or all channels are measured. When there are multiple untested channels having the same subsequent highest average RF output power, the channel with higher frequency from the lowest 802.11 mode is considered for SAR measurements (See Section 8.6.4). When 10g SAR measurement is considered, a factor of 2.5 is applied to the thresholds above.

8.6.6 Subsequent Test Configuration Procedures

For OFDM configurations in each frequency band and aggregated band, SAR is evaluated for initial test configuration using the fixed test position or the initial test position procedure. When the highest reported SAR (for the initial test configuration), adjusted by the ratio of the specified maximum output power of the subsequent test configuration to initial test configuration, is ≤ 1.2 W/kg, no additional SAR tests for the subsequent test configurations are required. When 10g SAR measurement is considered, a factor of 2.5 is applied to the thresholds above.

FCC ID: A3LSMA127M	 <small>Proved to be part of Samsung</small>	SAR EVALUATION REPORT	 Approved by: Quality Manager
Document S/N: 1M2106030063-01.A3L (Rev 1)	Test Dates: 05/31/2021 - 07/07/2021	DUT Type: Portable Handset	Page 23 of 68

9 RF CONDUCTED POWERS



9.1 GSM Conducted Powers

**Table 9-1
Maximum Conducted Power**

Maximum Burst-Averaged Output Power										
Band	Channel	Voice	GPRS/EDGE Data (GMSK)				EDGE Data (8-PSK)			
		GSM [dBm] CS (1 Slot)	GPRS [dBm] 1 Tx Slot	GPRS [dBm] 2 Tx Slot	GPRS [dBm] 3 Tx Slot	GPRS [dBm] 4 Tx Slot	EDGE [dBm] 1 Tx Slot	EDGE [dBm] 2 Tx Slot	EDGE [dBm] 3 Tx Slot	EDGE [dBm] 4 Tx Slot
GSM 850	128	32.84	32.94	30.85	29.27	28.22	27.20	24.94	23.70	22.28
	190	32.91	32.90	30.93	29.37	28.08	27.26	24.91	23.52	22.26
	251	32.88	33.03	30.77	29.44	28.20	27.14	24.74	23.50	22.13
GSM 1900	512	29.72	29.76	27.01	25.29	23.79	26.03	23.77	22.53	21.06
	661	29.68	29.62	26.94	25.19	23.65	26.09	23.59	22.69	20.86
	810	29.81	29.80	27.17	25.30	23.80	26.33	23.97	22.50	21.26

Calculated Maximum Frame-Averaged Output Power										
Band	Channel	Voice	GPRS/EDGE Data (GMSK)				EDGE Data (8-PSK)			
		GSM [dBm] CS (1 Slot)	GPRS [dBm] 1 Tx Slot	GPRS [dBm] 2 Tx Slot	GPRS [dBm] 3 Tx Slot	GPRS [dBm] 4 Tx Slot	EDGE [dBm] 1 Tx Slot	EDGE [dBm] 2 Tx Slot	EDGE [dBm] 3 Tx Slot	EDGE [dBm] 4 Tx Slot
GSM 850	128	23.64	23.74	24.66	24.84	25.04	18.00	18.75	19.27	19.10
	190	23.71	23.70	24.74	24.94	24.90	18.06	18.72	19.09	19.08
	251	23.68	23.83	24.58	25.01	25.02	17.94	18.55	19.07	18.95
GSM 1900	512	20.52	20.56	20.82	20.86	20.61	16.83	17.58	18.10	17.88
	661	20.48	20.42	20.75	20.76	20.47	16.89	17.40	18.26	17.68
	810	20.61	20.60	20.98	20.87	20.62	17.13	17.78	18.07	18.08

GSM 850	Frame Avg. Targets:	23.30	23.30	24.31	24.57	24.32	17.30	18.31	18.57	18.82
GSM 1900		20.30	20.30	20.81	20.57	20.32	16.80	17.31	18.07	17.82

FCC ID: A3LSMA127M	 PCTEST Proud to be part of  Samsung	SAR EVALUATION REPORT		Approved by: Quality Manager
Document S/N: 1M2106030063-01.A3L (Rev 1)	Test Dates: 05/31/2021 - 07/07/2021	DUT Type: Portable Handset		Page 24 of 68

Note:

- Both burst-averaged and calculated frame-averaged powers are included. Frame-averaged power was calculated from the measured burst-averaged power by converting the slot powers into linear units and calculating the energy over 8 timeslots.
- GPRS/EDGE (GMSK) output powers were measured with coding scheme setting of 1 (CS1) on the base station simulator. CS1 was configured to measure GPRS output power measurements and SAR to ensure GMSK modulation in the signal. Our Investigation has shown that CS1 - CS4 settings do not have any impact on the output levels or modulation in the GPRS modes.
- EDGE (8-PSK) output powers were measured with MCS7 on the base station simulator. MCS7 coding scheme was used to measure the output powers for EDGE since investigation has shown that choosing MCS7 coding scheme will ensure 8-PSK modulation. It has been shown that MCS levels that produce 8-PSK modulation do not have an impact on output power.

GSM Class: B
GPRS Multislot class: 33 (Max 4 Tx uplink slots)
EDGE Multislot class: 33 (Max 4 Tx uplink slots)
DTM Multislot Class: N/A





Figure 9-1
Power Measurement Setup

9.2 UMTS Conducted Powers



Table 9-2
Maximum Conducted Power

3GPP Release Version	Mode	3GPP 34.121 Subtest	Cellular Band [dBm]			AWS Band [dBm]			PCS Band [dBm]			3GPP MPR [dB]
			4132	4183	4233	1312	1412	1513	9262	9400	9538	
99	WCDMA	12.2 kbps RMC	23.76	23.81	23.75	24.30	24.27	24.20	24.28	24.51	24.78	-
99		12.2 kbps AMR	23.78	23.86	23.80	24.26	24.10	23.76	24.30	24.32	24.80	-
6	HSDPA	Subtest 1	21.69	21.71	21.65	22.36	22.27	21.94	22.82	22.99	23.00	0
6		Subtest 2	21.68	21.71	21.67	22.40	22.33	21.98	22.86	22.97	22.99	0
6		Subtest 3	20.80	20.83	20.73	21.47	21.39	21.08	21.87	22.04	22.42	0.5
6		Subtest 4	21.09	21.11	21.01	21.76	21.69	21.37	22.20	22.38	22.43	0.5
6	HSUPA	Subtest 1	21.31	21.30	21.26	21.49	21.41	21.09	21.88	22.06	22.34	0
6		Subtest 2	19.29	19.31	19.26	19.49	19.41	19.05	19.93	20.21	20.49	2
6		Subtest 3	20.26	20.34	20.31	21.03	20.99	20.67	21.00	21.17	21.45	1
6		Subtest 4	19.26	19.29	19.19	19.52	19.34	19.05	19.99	20.11	20.49	2
6		Subtest 5	21.28	21.28	21.23	21.90	21.83	21.53	21.80	21.95	22.42	0
8	DC-HSDPA	Subtest 1	21.80	21.70	21.77	22.38	22.41	22.16	23.00	22.89	22.95	0
8		Subtest 2	21.76	21.70	21.51	22.40	22.45	22.16	22.98	22.98	23.00	0
8		Subtest 3	20.34	20.37	20.30	21.03	21.02	20.84	21.62	21.75	21.62	0.5
8		Subtest 4	21.16	21.00	20.82	21.76	21.79	21.58	22.43	22.46	22.43	0.5

FCC ID: A3LSMA127M	 PCTEST Proud to be part of  hewlett-packard	SAR EVALUATION REPORT		Approved by: Quality Manager
Document S/N: 1M2106030063-01.A3L (Rev 1)	Test Dates: 05/31/2021 - 07/07/2021	DUT Type: Portable Handset		Page 25 of 68

**Table 9-3
Reduced RCV/Proximity Sensor and/or Earjack Active Conducted Power**

3GPP Release Version	Mode	3GPP 34.121 Subtest	AWS Band [dBm]			3GPP MPR [dB]
			1312	1412	1513	
99	WCDMA	12.2 kbps RMC	22.41	22.30	21.89	-
99		12.2 kbps AMR	22.35	22.31	21.85	-
6	HSDPA	Subtest 1	22.36	22.27	21.94	0
6		Subtest 2	22.40	22.33	21.98	0
6		Subtest 3	21.47	21.39	21.08	0.5
6		Subtest 4	21.76	21.69	21.37	0.5
6	HSUPA	Subtest 1	21.49	21.41	21.09	0
6		Subtest 2	19.49	19.41	19.05	2
6		Subtest 3	21.03	20.99	20.67	1
6		Subtest 4	19.52	19.34	19.05	2
6		Subtest 5	21.90	21.83	21.53	0
8	DC-HSDPA	Subtest 1	22.38	22.41	22.16	0
8		Subtest 2	22.40	22.45	22.16	0
8		Subtest 3	21.03	21.02	20.84	0.5
8		Subtest 4	21.76	21.79	21.58	0.5

FCC ID: A3LSMA127M	 PCTEST <small>Proud to be part of Samsung</small>	SAR EVALUATION REPORT		Approved by: Quality Manager
Document S/N: 1M2106030063-01.A3L (Rev 1)	Test Dates: 05/31/2021 - 07/07/2021	DUT Type: Portable Handset		Page 26 of 68

**Table 9-4
Reduced RCV/Hotspot/Proximity Sensor and/or Earjack Active Conducted Power**

3GPP Release Version	Mode	3GPP 34.121 Subtest	PCS Band [dBm]			3GPP MPR [dB]
			9262	9400	9538	
99	WCDMA	12.2 kbps RMC	22.64	22.85	23.00	-
99		12.2 kbps AMR	22.63	22.85	23.00	-
6	HSDPA	Subtest 1	22.82	22.99	23.00	0
6		Subtest 2	22.86	22.97	22.99	0
6		Subtest 3	21.87	22.04	22.42	0.5
6		Subtest 4	22.20	22.38	22.43	0.5
6	HSUPA	Subtest 1	21.88	22.06	22.34	0
6		Subtest 2	19.93	20.21	20.49	2
6		Subtest 3	21.00	21.17	21.45	1
6		Subtest 4	19.99	20.11	20.49	2
6		Subtest 5	21.80	21.95	22.42	0
8	DC-HSDPA	Subtest 1	23.00	22.89	22.95	0
8		Subtest 2	22.98	22.98	23.00	0
8		Subtest 3	21.62	21.75	21.62	0.5
8		Subtest 4	22.43	22.46	22.43	0.5



DC-HSDPA considerations

- 3GPP Specification 34.121-1 Release 8 Ver 8.10.0 was used for DC-HSDPA guidance
- H-Set 12 (QPSK) was confirmed to be used during DC-HSDPA measurements
- The DUT supports UE category 24 for HSDPA

It is expected by the manufacturer that MPR for some HSPA subtests may be up to 2 dB more than specified by 3GPP, but also as low as 0 dB according to the chipset implementation in this model.



**Figure 9-2
Power Measurement Setup**

FCC ID: A3LSMA127M	 PCTEST <small>Proven to be part of Samsung</small>	SAR EVALUATION REPORT		Approved by: Quality Manager
Document S/N: 1M2106030063-01.A3L (Rev 1)	Test Dates: 05/31/2021 - 07/07/2021	DUT Type: Portable Handset	Page 27 of 68	

9.3 LTE Conducted Powers



Note: Per FCC KDB Publication 941225 D05v02r05, LTE SAR for the lower bandwidths was not required for testing since the maximum average output power of all required channels and configurations was not more than 0.5 dB higher than the highest bandwidth and the reported LTE SAR for the highest bandwidth was less than 1.45 W/kg. Lower bandwidth conducted powers for all LTE bands can be found in Appendix F.

9.3.1 LTE Band 12

**Table 9-5
LTE Band 12 Maximum Conducted Powers – 10 MHz Bandwidth**

LTE Band 12 10 MHz Bandwidth					
Modulation	RB Size	RB Offset	Mid Channel	MPR Allowed per 3GPP [dB]	MPR [dB]
			23095 (707.5 MHz)		
			Conducted Power [dBm]		
QPSK	1	0	24.17	0	0
	1	25	24.14		0
	1	49	24.20		0
	25	0	23.14	0-1	1
	25	12	23.14		1
	25	25	23.17		1
	50	0	23.15		1
16QAM	1	0	23.04	0-1	1
	1	25	22.99		1
	1	49	23.09		1
	25	0	22.23	0-2	2
	25	12	22.19		2
	25	25	22.25		2
	50	0	22.22		2

Note: LTE Band 12 at 10 MHz bandwidth does not support three non-overlapping channels. Per KDB Publication 941225 D05v02, when a device supports overlapping channel assignment in a channel bandwidth configuration, the middle channel of the group of overlapping channels should be selected for testing.

FCC ID: A3LSMA127M	 PCTEST <small>Proud to be part of Samsung</small>	SAR EVALUATION REPORT		Approved by: Quality Manager
Document S/N: 1M2106030063-01.A3L (Rev 1)	Test Dates: 05/31/2021 - 07/07/2021	DUT Type: Portable Handset	Page 28 of 68	



9.3.2

LTE Band 26 (Cell)

Table 9-6
 LTE Band 26 (Cell) Maximum Conducted Powers – 15 MHz Bandwidth

LTE Band 26 (Cell) 15 MHz Bandwidth					
Modulation	RB Size	RB Offset	Mid Channel	MPR Allowed per 3GPP [dB]	MPR [dB]
			26865 (831.5 MHz)		
			Conducted Power [dBm]		
QPSK	1	0	24.26	0	0
	1	36	24.25		0
	1	74	24.25		0
	36	0	23.39	0-1	1
	36	18	23.30		1
	36	37	23.31		1
	75	0	23.34		1
16QAM	1	0	23.11	0-1	1
	1	36	23.08		1
	1	74	23.05		1
	36	0	22.37	0-2	2
	36	18	22.27		2
	36	37	22.24		2
	75	0	22.24		2

Note: LTE Band 26 at 15 MHz bandwidth does not support three non-overlapping channels. Per KDB Publication 941225 D05v02, when a device supports overlapping channel assignment in a channel bandwidth configuration, the middle channel of the group of overlapping channels should be selected for testing.

FCC ID: A3LSMA127M	 PCTEST <small>Proud to be part of Samsung</small>	SAR EVALUATION REPORT		Approved by: Quality Manager
Document S/N: 1M2106030063-01.A3L (Rev 1)	Test Dates: 05/31/2021 - 07/07/2021	DUT Type: Portable Handset		Page 29 of 68

9.3.3



LTE Band 66 (AWS)

Table 9-7
 LTE Band 66 (AWS) Maximum Conducted Powers – 20 MHz Bandwidth

LTE Band 66 (AWS) 20 MHz Bandwidth							
Modulation	RB Size	RB Offset	Low Channel	Mid Channel	High Channel	MPR Allowed per 3GPP [dB]	MPR [dB]
			132072 (1720.0 MHz)	132322 (1745.0 MHz)	132572 (1770.0 MHz)		
			Conducted Power [dBm]				
QPSK	1	0	23.90	23.25	23.09	0	0
	1	50	23.84	23.23	23.08		0
	1	99	23.83	23.28	23.06		0
	50	0	23.26	22.42	22.55	0-1	1
	50	25	22.92	22.33	22.11		1
	50	50	22.84	22.32	22.08		1
16QAM	100	0	22.86	22.32	22.07	0-1	1
	1	0	22.74	22.20	21.67		1
	1	50	22.70	22.21	21.75		1
	1	99	22.68	22.22	21.70	0-2	1
	50	0	22.25	21.57	21.43		2
	50	25	21.94	21.43	21.17		2
	50	50	21.86	21.41	21.16	2	
	100	0	21.88	21.40	21.17	2	

Table 9-8
 LTE Band 66 (AWS) Reduced RCV/Proximity Sensor and/or Earjack Active – 20 MHz Bandwidth

LTE Band 66 (AWS) 20 MHz Bandwidth							
Modulation	RB Size	RB Offset	Low Channel	Mid Channel	High Channel	MPR Allowed per 3GPP [dB]	MPR [dB]
			132072 (1720.0 MHz)	132322 (1745.0 MHz)	132572 (1770.0 MHz)		
			Conducted Power [dBm]				
QPSK	1	0	21.90	21.37	21.15	0	0
	1	50	21.80	21.35	21.14		0
	1	99	21.73	21.36	21.12		0
	50	0	21.89	21.43	21.18	0-1	0
	50	25	21.93	21.38	21.17		0
	50	50	21.92	21.39	21.15		0
16QAM	100	0	21.89	21.41	21.13	0-1	0
	1	0	21.95	21.19	21.09		0
	1	50	21.93	21.17	21.00		0
	1	99	21.87	21.21	20.96	0-2	0
	50	0	21.94	21.29	21.05		0
	50	25	22.02	21.40	21.16		0
	50	50	21.95	21.40	21.16	0	
	100	0	21.98	21.40	21.17	0	

FCC ID: A3LSMA127M	 PCTEST Proud to be part of Samsung	SAR EVALUATION REPORT		Approved by: Quality Manager
Document S/N: 1M2106030063-01.A3L (Rev 1)	Test Dates: 05/31/2021 - 07/07/2021	DUT Type: Portable Handset		Page 30 of 68

9.3.4



LTE Band 2 (PCS)

Table 9-9
LTE Band 2 (PCS) Maximum Conducted Powers – 20 MHz Bandwidth

LTE Band 2 (PCS) 20 MHz Bandwidth							
Modulation	RB Size	RB Offset	Low Channel	Mid Channel	High Channel	MPR Allowed per 3GPP [dB]	MPR [dB]
			18700 (1860.0 MHz)	18900 (1880.0 MHz)	19100 (1900.0 MHz)		
			Conducted Power [dBm]				
QPSK	1	0	24.04	24.18	24.40	0	0
	1	50	24.07	24.16	24.39		0
	1	99	23.97	24.02	24.24		0
	50	0	23.04	23.34	23.35	0-1	1
	50	25	23.00	23.24	23.34		1
	50	50	23.02	23.22	23.23		1
16QAM	100	0	23.01	23.19	23.30	0-1	1
	1	0	22.76	23.14	23.04		1
	1	50	22.85	23.15	22.93		1
	1	99	22.83	23.02	22.79	0-2	1
	50	0	22.09	22.43	22.37		2
	50	25	22.07	22.32	22.31		2
	50	50	22.02	22.27	22.24	2	
	100	0	22.08	22.27	22.40	2	

Table 9-10
LTE Band 2 (PCS) Reduced RCV/Proximity Sensor and/or Earjack Active – 20 MHz Bandwidth

LTE Band 2 (PCS) 20 MHz Bandwidth							
Modulation	RB Size	RB Offset	Low Channel	Mid Channel	High Channel	MPR Allowed per 3GPP [dB]	MPR [dB]
			18700 (1860.0 MHz)	18900 (1880.0 MHz)	19100 (1900.0 MHz)		
			Conducted Power [dBm]				
QPSK	1	0	21.17	21.38	21.83	0	0
	1	50	21.18	21.37	21.79		0
	1	99	21.22	21.40	21.72		0
	50	0	21.15	21.41	21.63	0-1	0
	50	25	21.21	21.42	21.65		0
	50	50	21.18	21.41	21.62		0
16QAM	100	0	21.16	21.40	21.60	0-1	0
	1	0	20.95	21.18	21.45		0
	1	50	20.95	21.10	21.43		0
	1	99	20.98	21.11	21.38	0-2	0
	50	0	21.20	21.41	21.67		0
	50	25	21.14	21.44	21.62		0
	50	50	21.19	21.44	21.56	0	
	100	0	21.20	21.45	21.65	0	

FCC ID: A3LSMA127M	 PCTEST <small>Proven to be part of Samsung</small>	SAR EVALUATION REPORT		Approved by: Quality Manager
Document S/N: 1M2106030063-01.A3L (Rev 1)	Test Dates: 05/31/2021 - 07/07/2021	DUT Type: Portable Handset		Page 31 of 68

9.3.5



LTE Band 41

Table 9-11
LTE Band 41 Maximum Conducted Powers – 20 MHz Bandwidth

LTE Band 41 20 MHz Bandwidth									
Modulation	RB Size	RB Offset	Low Channel	Low-Mid Channel	Mid Channel	Mid-High Channel	High Channel	MPR Allowed per 3GPP [dB]	MPR [dB]
			39750 (2506.0 MHz)	40185 (2549.5 MHz)	40620 (2593.0 MHz)	41055 (2636.5 MHz)	41490 (2680.0 MHz)		
			Conducted Power [dBm]						
QPSK	1	0	23.25	22.63	22.95	23.23	23.32	0	0
	1	50	23.19	22.64	23.01	23.17	22.98		0
	1	99	23.21	22.78	23.08	23.08	22.93		0
	50	0	22.45	21.96	22.21	22.30	22.49	0-1	1
	50	25	22.43	22.00	22.26	22.29	22.30		1
	50	50	22.43	22.03	22.27	22.25	22.24		1
100	0	22.34	22.03	22.25	22.28	22.42	1		
16QAM	1	0	22.41	21.84	21.74	22.19	22.47	0-1	1
	1	50	22.39	21.88	21.81	22.10	22.35		1
	1	99	22.40	21.99	21.86	22.03	22.25		1
	50	0	21.40	20.93	21.26	21.29	21.19	0-2	2
	50	25	21.38	20.98	21.30	21.27	21.20		2
	50	50	21.39	21.00	21.30	21.23	21.16		2
100	0	21.38	20.98	21.24	21.28	21.20	2		

Table 9-12
LTE Band 41 Reduced RCV/Hotspot/Proximity Sensor and/or Earjack Active – 20 MHz Bandwidth

LTE Band 41 20 MHz Bandwidth									
Modulation	RB Size	RB Offset	Low Channel	Low-Mid Channel	Mid Channel	Mid-High Channel	High Channel	MPR Allowed per 3GPP [dB]	MPR [dB]
			39750 (2506.0 MHz)	40185 (2549.5 MHz)	40620 (2593.0 MHz)	41055 (2636.5 MHz)	41490 (2680.0 MHz)		
			Conducted Power [dBm]						
QPSK	1	0	16.92	16.51	16.84	16.90	16.95	0	0
	1	50	16.90	16.56	16.91	16.82	16.86		0
	1	99	16.91	16.65	16.90	16.77	16.80		0
	50	0	16.92	16.48	16.74	16.88	16.93	0-1	0
	50	25	16.90	16.51	16.79	16.86	16.87		0
	50	50	16.91	16.57	16.85	16.81	16.80		0
100	0	16.89	16.54	16.82	16.89	16.90	0		
16QAM	1	0	16.55	16.40	16.90	16.63	16.75	0-1	0
	1	50	16.54	16.44	16.95	16.56	16.66		0
	1	99	16.57	16.54	17.00	16.47	16.60		0
	50	0	16.92	16.51	16.84	16.83	16.87	0-2	0
	50	25	16.90	16.56	16.89	16.83	16.82		0
	50	50	16.91	16.58	16.97	16.78	16.76		0
100	0	16.94	16.56	16.89	16.88	16.84	0		

FCC ID: A3LSMA127M	 PCTEST <small>Prove it to be part of @ctest</small>	SAR EVALUATION REPORT		Approved by: Quality Manager
Document S/N: 1M2106030063-01.A3L (Rev 1)	Test Dates: 05/31/2021 - 07/07/2021	DUT Type: Portable Handset		Page 32 of 68



9.4 WLAN Conducted Powers

Table 9-13
2.4 GHz WLAN Maximum Average RF Power

2.4GHz Conducted Power [dBm]				
Freq [MHz]	Channel	IEEE Transmission Mode		
		802.11b	802.11g	802.11n
		Average	Average	Average
2412	1	17.66	14.96	14.77
2417	2	N/A	16.37	16.34
2437	6	17.97	16.44	16.27
2452	9	N/A	16.69	16.55
2457	10	N/A	15.93	15.72
2462	11	18.01	12.98	12.99
2467	12	8.41	8.74	8.41
2472	13	8.72	4.77	4.97

Table 9-14
2.4 GHz WLAN Reduced Average RF Power

2.4GHz Conducted Power [dBm]				
Freq [MHz]	Channel	IEEE Transmission Mode		
		802.11b	802.11g	802.11n
		Average	Average	Average
2412	1	12.55	12.99	12.95
2437	6	12.76	12.88	12.91
2462	11	12.97	12.98	12.99
2467	12	8.41	8.74	8.41
2472	13	8.72	4.77	4.97

FCC ID: A3LSMA127M	 PCTEST Proud to be part of Samsung	SAR EVALUATION REPORT		Approved by: Quality Manager
Document S/N: 1M2106030063-01.A3L (Rev 1)	Test Dates: 05/31/2021 - 07/07/2021	DUT Type: Portable Handset		Page 33 of 68

Justification for test configurations for WLAN per KDB Publication 248227 D01v02r02:

- Power measurements were performed for the transmission mode configuration with the highest maximum output power specified for production units.
- For transmission modes with the same maximum output power specification, powers were measured for the largest channel bandwidth, lowest order modulation and lowest data rate.
- For transmission modes with identical maximum specified output power, channel bandwidth, modulation and data rates, power measurements were required for all identical configurations.
- For each transmission mode configuration, powers were measured for the highest and lowest channels; and at the mid-band channel(s) when there were at least 3 channels supported. For configurations with multiple mid-band channels, due to an even number of channels, both channels were measured.

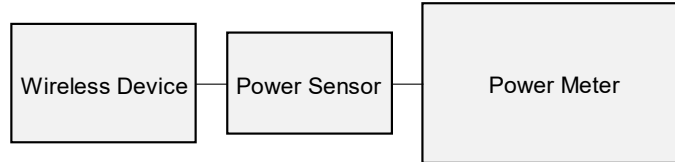



Figure 9-3
Power Measurement Setup

9.5 Bluetooth Conducted Powers

Table 9-15
Bluetooth Average RF Power

Frequency [MHz]	Data Rate [Mbps]	Mod.	Channel No.	Avg Conducted Power	
				[dBm]	[mW]
2402	1.0	GFSK	0	8.88	7.720
2441	1.0	GFSK	39	8.88	7.723
2480	1.0	GFSK	78	9.05	8.031
2402	2.0	$\pi/4$ -DQPSK	0	7.16	5.204
2441	2.0	$\pi/4$ -DQPSK	39	7.81	6.045
2480	2.0	$\pi/4$ -DQPSK	78	7.40	5.500
2402	3.0	8DPSK	0	7.14	5.179
2441	3.0	8DPSK	39	7.84	6.087
2480	3.0	8DPSK	78	6.14	4.115

FCC ID: A3LSMA127M	 PCTEST <small>Proud to be part of Samsung</small>	SAR EVALUATION REPORT		Approved by: Quality Manager
Document S/N: 1M2106030063-01.A3L (Rev 1)	Test Dates: 05/31/2021 - 07/07/2021	DUT Type: Portable Handset	Page 34 of 68	

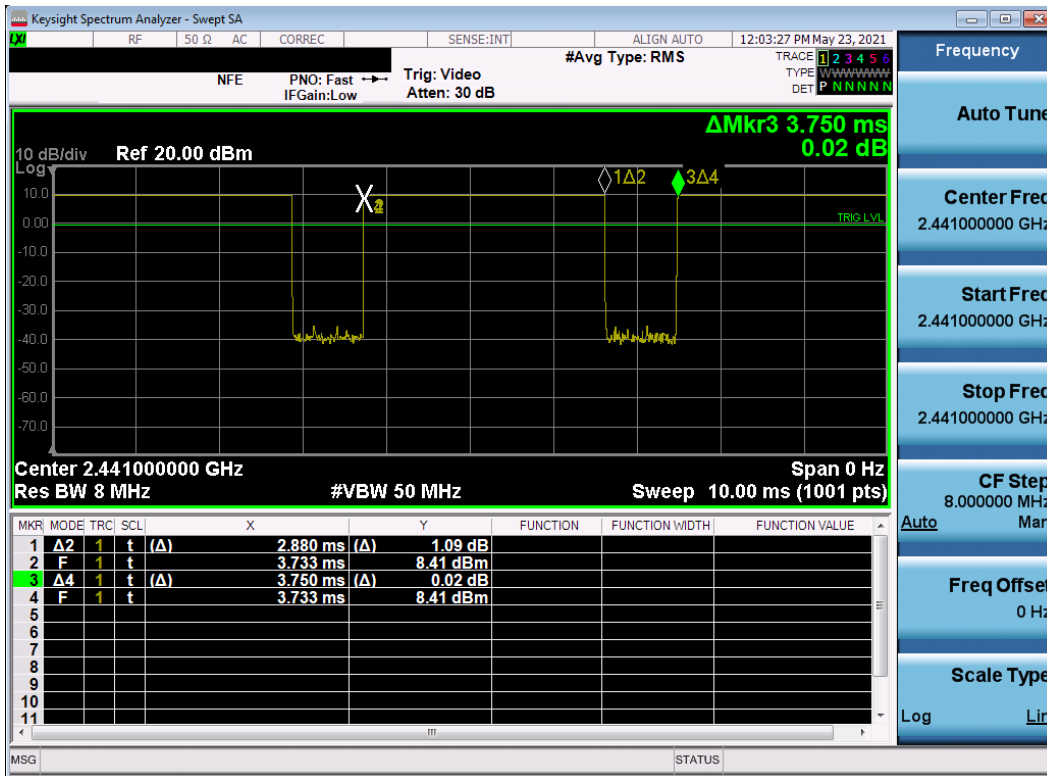

Figure 9-4
Bluetooth Transmission Plot

Equation 9-1
Bluetooth Duty Cycle Calculation

$$Duty\ Cycle = \frac{Pulse\ Width}{Period} * 100\% = \frac{2.88ms}{3.75ms} * 100\% = 76.8\%$$

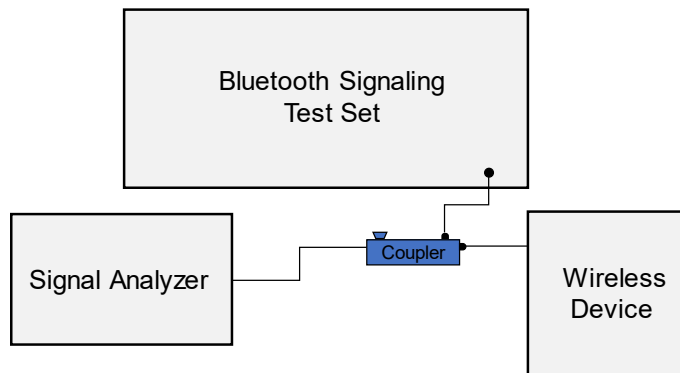

Figure 9-5
Power Measurement Setup



FCC ID: A3LSMA127M	PCTEST Proud to be part of HPE	SAR EVALUATION REPORT		Approved by: Quality Manager
Document S/N: 1M2106030063-01.A3L (Rev 1)	Test Dates: 05/31/2021 - 07/07/2021	DUT Type: Portable Handset		Page 35 of 68

10 SYSTEM VERIFICATION

10.1 Tissue Verification



**Table 10-1
Measured Head Tissue Properties**

Calibrated for Tests Performed on:	Tissue Type	Tissue Temp During Calibration (°C)	Measured Frequency (MHz)	Measured Conductivity, σ (S/m)	Measured Dielectric Constant, ϵ	TARGET Conductivity, σ (S/m)	TARGET Dielectric Constant, ϵ	% dev σ	% dev ϵ
06/08/2021	750 Head	22.8	680	0.889	41.496	0.888	42.305	0.11%	-1.91%
			695	0.894	41.439	0.889	42.227	0.56%	-1.87%
			700	0.896	41.421	0.889	42.201	0.79%	-1.85%
			710	0.900	41.393	0.890	42.149	1.12%	-1.79%
			725	0.905	41.361	0.891	42.071	1.57%	-1.69%
			750	0.914	41.304	0.894	41.942	2.24%	-1.52%
			770	0.921	41.249	0.895	41.838	2.91%	-1.41%
			785	0.926	41.200	0.896	41.760	3.35%	-1.34%
06/06/2021	835 Head	21.0	800	0.932	41.151	0.897	41.682	3.90%	-1.27%
			820	0.915	39.629	0.899	41.578	1.78%	-4.69%
			835	0.920	39.605	0.900	41.500	2.22%	-4.57%
06/06/2021	1750 Head	23.0	850	0.926	39.576	0.916	41.500	1.09%	-4.64%
			1710	1.373	40.454	1.348	40.142	1.85%	0.78%
			1720	1.378	40.439	1.354	40.126	1.77%	0.78%
			1745	1.393	40.382	1.368	40.087	1.83%	0.74%
			1750	1.396	40.369	1.371	40.079	1.82%	0.72%
06/08/2021	1900 Head	22.0	1770	1.408	40.324	1.383	40.047	1.81%	0.69%
			1790	1.420	40.289	1.394	40.016	1.87%	0.68%
			1850	1.419	39.196	1.400	40.000	1.36%	-2.01%
			1860	1.425	39.179	1.400	40.000	1.79%	-2.05%
			1880	1.437	39.144	1.400	40.000	2.64%	-2.14%
06/14/2021	2450 Head	21.4	1900	1.450	39.114	1.400	40.000	3.57%	-2.22%
			1905	1.453	39.108	1.400	40.000	3.79%	-2.23%
			1910	1.456	39.101	1.400	40.000	4.00%	-2.25%
			2300	1.738	39.006	1.670	39.500	4.07%	-1.25%
			2310	1.746	38.993	1.679	39.480	3.99%	-1.23%
			2320	1.754	38.977	1.687	39.460	3.97%	-1.22%
			2400	1.815	38.865	1.756	39.289	3.36%	-1.08%
			2450	1.854	38.787	1.800	39.200	3.00%	-1.05%
			2480	1.877	38.745	1.833	39.162	2.40%	-1.06%
			2500	1.892	38.715	1.855	39.136	1.99%	-1.08%
			2510	1.899	38.699	1.866	39.123	1.77%	-1.08%
			2535	1.921	38.660	1.893	39.092	1.48%	-1.11%
			2550	1.933	38.641	1.909	39.073	1.26%	-1.11%
			2560	1.942	38.627	1.920	39.060	1.15%	-1.11%
07/07/2021	2450 Head	24.0	2600	1.974	38.568	1.964	39.009	0.51%	-1.13%
			2650	2.015	38.480	2.018	38.945	-0.15%	-1.19%
			2680	2.039	38.439	2.051	38.907	-0.59%	-1.20%
			2700	2.054	38.408	2.073	38.882	-0.92%	-1.22%
			2400	1.784	37.366	1.756	39.289	1.59%	-4.89%
			2450	1.820	37.301	1.800	39.200	1.11%	-4.84%
			2480	1.841	37.270	1.833	39.162	0.44%	-4.83%
			2500	1.856	37.248	1.855	39.136	0.05%	-4.82%
			2510	1.864	37.235	1.866	39.123	-0.11%	-4.83%
			2535	1.884	37.199	1.893	39.092	-0.48%	-4.84%
			2550	1.895	37.179	1.909	39.073	-0.73%	-4.85%
			2560	1.903	37.167	1.920	39.060	-0.89%	-4.85%
			2600	1.934	37.112	1.964	39.009	-1.53%	-4.86%
			2650	1.972	37.039	2.018	38.945	-2.28%	-4.89%
2680	1.995	36.992	2.051	38.907	-2.73%	-4.92%			
2700	2.009	36.958	2.073	38.882	-3.09%	-4.95%			
2650	2.015	38.480	2.018	38.945	-0.15%	-1.19%			
2680	2.039	38.439	2.051	38.907	-0.59%	-1.20%			
2700	2.054	38.408	2.073	38.882	-0.92%	-1.22%			

FCC ID: A3LSMA127M	 PCTEST <small>Proved to be part of @intertek</small>	SAR EVALUATION REPORT		Approved by: Quality Manager
Document S/N: 1M2106030063-01.A3L (Rev 1)	Test Dates: 05/31/2021 - 07/07/2021	DUT Type: Portable Handset		Page 36 of 68

**Table 10-2
Measured Body Tissue Properties**



Calibrated for Tests Performed on:	Tissue Type	Tissue Temp During Calibration (C)	Measured Frequency (MHz)	Measured Conductivity, σ (S/m)	Measured Dielectric Constant, ϵ	TARGET Conductivity, σ (S/m)	TARGET Dielectric Constant, ϵ	% dev σ	% dev ϵ
05/31/2021	750 Body	23.0	680	0.958	54.843	0.958	55.804	0.00%	-1.72%
			695	0.963	54.807	0.959	55.745	0.42%	-1.68%
			700	0.965	54.795	0.959	55.726	0.63%	-1.67%
			710	0.968	54.774	0.960	55.687	0.83%	-1.64%
			725	0.974	54.745	0.961	55.629	1.35%	-1.59%
			750	0.983	54.697	0.964	55.531	1.97%	-1.50%
			770	0.989	54.640	0.965	55.453	2.49%	-1.47%
			785	0.995	54.595	0.966	55.395	3.00%	-1.44%
06/06/2021	835 Body	20.0	800	1.000	54.554	0.967	55.336	3.41%	-1.41%
			820	0.942	52.949	0.969	55.258	-2.79%	-4.18%
			835	0.958	52.788	0.970	55.200	-1.24%	-4.37%
06/06/2021	1750 Body	21.5	850	0.975	52.620	0.988	55.154	-1.32%	-4.59%
			1710	1.450	53.483	1.463	53.537	-0.89%	-0.10%
			1720	1.455	53.463	1.469	53.511	-0.95%	-0.09%
			1745	1.472	53.383	1.485	53.445	-0.88%	-0.12%
			1750	1.476	53.367	1.488	53.432	-0.81%	-0.12%
06/16/2021	1750 Body	23.3	1770	1.493	53.329	1.501	53.379	-0.53%	-0.09%
			1790	1.508	53.326	1.514	53.326	-0.40%	0.00%
			1710	1.484	51.590	1.463	53.537	1.44%	-3.64%
			1720	1.495	51.549	1.469	53.511	1.77%	-3.67%
			1745	1.524	51.443	1.485	53.445	2.63%	-3.75%
06/20/2021	1750 Body	21.2	1750	1.530	51.423	1.488	53.432	2.82%	-3.76%
			1770	1.552	51.354	1.501	53.379	3.40%	-3.79%
			1790	1.574	51.291	1.514	53.326	3.96%	-3.82%
			1710	1.498	51.057	1.463	53.537	2.39%	-4.63%
			1720	1.509	51.011	1.469	53.511	2.72%	-4.67%
06/15/2021	1900 Body	24.9	1745	1.536	50.900	1.485	53.445	3.43%	-4.76%
			1750	1.542	50.880	1.488	53.432	3.63%	-4.78%
			1770	1.564	50.803	1.501	53.379	4.20%	-4.83%
			1790	1.586	50.728	1.514	53.326	4.76%	-4.87%
			1850	1.487	52.575	1.520	53.300	-2.17%	-1.36%
06/22/2021	1900 Body	25.0	1860	1.498	52.544	1.520	53.300	-1.45%	-1.42%
			1880	1.519	52.486	1.520	53.300	-0.07%	-1.53%
			1900	1.541	52.431	1.520	53.300	1.38%	-1.63%
			1905	1.547	52.418	1.520	53.300	1.78%	-1.65%
			1910	1.552	52.406	1.520	53.300	2.11%	-1.68%
06/24/2021	1900 Body	25.0	1850	1.458	52.453	1.520	53.300	-4.08%	-1.59%
			1860	1.469	52.420	1.520	53.300	-3.36%	-1.65%
			1880	1.490	52.352	1.520	53.300	-1.97%	-1.78%
			1900	1.511	52.285	1.520	53.300	-0.59%	-1.90%
			1905	1.517	52.267	1.520	53.300	-0.20%	-1.94%
06/24/2021	1900 Body	25.0	1910	1.522	52.251	1.520	53.300	0.13%	-1.97%
			1850	1.479	52.279	1.520	53.300	-2.70%	-1.92%
			1860	1.489	52.240	1.520	53.300	-2.04%	-1.99%
			1880	1.511	52.165	1.520	53.300	-0.59%	-2.13%
			1900	1.532	52.096	1.520	53.300	0.79%	-2.26%
06/24/2021	1900 Body	25.0	1905	1.538	52.080	1.520	53.300	1.18%	-2.29%
			1910	1.543	52.063	1.520	53.300	1.51%	-2.32%

FCC ID: A3LSMA127M	 PCTEST <small>Proven to be part of @samsung</small>	SAR EVALUATION REPORT		Approved by: Quality Manager
Document S/N: 1M2106030063-01.A3L (Rev 1)	Test Dates: 05/31/2021 - 07/07/2021	DUT Type: Portable Handset		Page 37 of 68

**Table 10-3
Measured Body Tissue Properties**

Calibrated for Tests Performed on:	Tissue Type	Tissue Temp During Calibration (°C)	Measured Frequency (MHz)	Measured Conductivity, σ (S/m)	Measured Dielectric Constant, ϵ	TARGET Conductivity, σ (S/m)	TARGET Dielectric Constant, ϵ	% dev σ	% dev ϵ
06/14/2021	2450 Body	24.2	2300	1.881	52.284	1.809	52.900	3.98%	-1.16%
			2310	1.890	52.278	1.816	52.887	4.07%	-1.15%
			2320	1.899	52.270	1.826	52.873	4.00%	-1.14%
			2400	1.966	52.185	1.902	52.767	3.36%	-1.10%
			2450	2.012	52.120	1.950	52.700	3.18%	-1.10%
			2480	2.038	52.090	1.993	52.662	2.26%	-1.09%
			2500	2.056	52.059	2.021	52.636	1.73%	-1.10%
			2510	2.065	52.041	2.035	52.623	1.47%	-1.11%
			2535	2.088	51.994	2.071	52.592	0.82%	-1.14%
			2550	2.103	51.971	2.092	52.573	0.53%	-1.15%
			2560	2.112	51.958	2.106	52.560	0.28%	-1.15%
			2600	2.148	51.903	2.163	52.509	-0.69%	-1.15%
			2650	2.193	51.800	2.234	52.445	-1.84%	-1.23%
			2680	2.222	51.757	2.277	52.407	-2.42%	-1.24%
2700	2.239	51.734	2.305	52.382	-2.86%	-1.24%			
06/14/2021	2450 Body	23.5	2300	1.877	51.486	1.809	52.900	3.76%	-2.67%
			2310	1.888	51.447	1.816	52.887	3.96%	-2.72%
			2320	1.899	51.412	1.826	52.873	4.00%	-2.76%
			2400	1.989	51.158	1.902	52.767	4.57%	-3.05%
			2450	2.047	50.998	1.950	52.700	4.97%	-3.23%
			2480	2.081	50.904	1.993	52.662	4.42%	-3.34%
			2500	2.104	50.839	2.021	52.636	4.11%	-3.41%
			2510	2.115	50.806	2.035	52.623	3.93%	-3.45%
			2535	2.144	50.728	2.071	52.592	3.52%	-3.54%
			2550	2.162	50.687	2.092	52.573	3.35%	-3.59%
			2560	2.174	50.659	2.106	52.560	3.23%	-3.62%
			2600	2.221	50.544	2.163	52.509	2.68%	-3.74%
			2650	2.281	50.400	2.234	52.445	2.10%	-3.90%
			2680	2.318	50.315	2.277	52.407	1.80%	-3.99%
2700	2.342	50.257	2.305	52.382	1.61%	-4.06%			
07/06/2021	2450 Body	24.0	2300	1.875	52.085	1.809	52.900	3.65%	-1.54%
			2310	1.887	52.053	1.816	52.887	3.91%	-1.58%
			2320	1.898	52.023	1.826	52.873	3.94%	-1.61%
			2400	1.989	51.788	1.902	52.767	4.57%	-1.86%
			2450	2.046	51.634	1.950	52.700	4.92%	-2.02%
			2480	2.079	51.544	1.993	52.662	4.32%	-2.12%
			2500	2.102	51.481	2.021	52.636	4.01%	-2.19%
			2510	2.113	51.450	2.035	52.623	3.83%	-2.23%
			2535	2.143	51.377	2.071	52.592	3.48%	-2.31%
			2550	2.160	51.335	2.092	52.573	3.25%	-2.35%
			2560	2.172	51.308	2.106	52.560	3.13%	-2.38%
			2600	2.218	51.188	2.163	52.509	2.54%	-2.52%
			2650	2.277	51.044	2.234	52.445	1.92%	-2.67%
			2680	2.312	50.961	2.277	52.407	1.54%	-2.76%
2700	2.335	50.901	2.305	52.382	1.30%	-2.83%			

The above measured tissue parameters were used in the DASY software. The DASY software was used to perform interpolation to determine the dielectric parameters at the SAR test device frequencies (per KDB Publication 865664 D01v01r04 and IEEE 1528-2013 6.6.1.2). The tissue parameters listed in the SAR test plots may slightly differ from the table above due to significant digit rounding in the software.

FCC ID: A3LSMA127M	 PCTEST <small>Proud to be part of the Samsung</small>	SAR EVALUATION REPORT		Approved by: Quality Manager
Document S/N: 1M2106030063-01.A3L (Rev 1)	Test Dates: 05/31/2021 - 07/07/2021	DUT Type: Portable Handset	Page 38 of 68	

10.2 Test System Verification



Prior to SAR assessment, the system is verified to $\pm 10\%$ of the SAR measurement on the reference dipole at the time of calibration by the calibration facility. Full system validation status and result summary can be found in Appendix D.

Table 10-4
System Verification Results – 1g

System Verification TARGET & MEASURED												
SAR System	Tissue Frequency (MHz)	Tissue Type	Date	Amb. Temp. (C)	Liquid Temp. (C)	Input Power (W)	Source SN	Probe SN	Measured SAR1g (W/kg)	1W Target SAR1g (W/kg)	1W Normalized SAR 1g (W/kg)	Deviation1g (%)
G	750	HEAD	06/08/2021	23.8	22.5	0.2	1003	7357	1.82	8.78	9.100	3.64%
J	835	HEAD	06/06/2021	21.1	21.0	0.2	4d132	7526	2.07	9.66	10.350	7.14%
L	1750	HEAD	06/06/2021	21.9	21.5	0.1	1148	7539	3.67	35.90	36.700	2.23%
J	1900	HEAD	06/08/2021	21.7	22.0	0.1	5d149	7526	4.24	39.30	42.400	7.89%
J	2450	HEAD	06/14/2021	21.5	21.4	0.1	719	7526	5.40	51.40	54.000	5.06%
E	2450	HEAD	07/07/2021	25.0	24.0	0.1	719	7571	5.28	51.40	52.800	2.72%
J	2600	HEAD	06/14/2021	21.5	21.4	0.1	1064	7526	5.74	58.10	57.400	-1.20%
E	2600	HEAD	07/07/2021	25.0	24.0	0.1	1064	7571	6.00	58.10	60.000	3.27%
G	750	BODY	05/31/2021	23.8	23.0	0.2	1003	7357	1.74	8.61	8.700	1.05%
P	835	BODY	06/06/2021	22.3	20.0	0.2	4d047	7308	1.96	9.47	9.800	3.48%
L	1750	BODY	06/06/2021	22.9	21.8	0.1	1148	7539	3.74	36.30	37.400	3.03%
P	1750	BODY	06/16/2021	24.5	21.3	0.1	1148	7308	3.73	36.30	37.300	2.75%
P	1750	BODY	06/20/2021	22.0	21.2	0.1	1150	7308	3.60	36.60	36.000	-1.64%
H	1900	BODY	06/15/2021	23.8	24.4	0.1	5d080	7410	4.22	39.20	42.200	7.65%
H	1900	BODY	06/24/2021	22.6	24.0	0.1	5d149	7410	4.25	39.40	42.500	7.87%
L	2450	BODY	06/14/2021	21.3	22.9	0.1	981	7539	5.10	50.10	51.000	1.80%
K	2450	BODY	06/14/2021	23.3	23.5	0.1	719	7538	5.15	50.70	51.500	1.58%
K	2450	BODY	07/06/2021	23.8	22.2	0.1	719	7538	5.22	50.70	52.200	2.96%
L	2600	BODY	06/14/2021	21.3	22.9	0.1	1071	7539	5.21	54.30	52.100	-4.05%
K	2600	BODY	07/06/2021	23.8	22.2	0.1	1064	7538	5.55	55.60	55.500	-0.18%

Table 10-5
System Verification Results – 10g

System Verification TARGET & MEASURED												
SAR System	Tissue Frequency (MHz)	Tissue Type	Date	Amb. Temp. (C)	Liquid Temp. (C)	Input Power (W)	Source SN	Probe SN	Measured SAR10g (W/kg)	1W Target SAR10g (W/kg)	1W Normalized SAR10g (W/kg)	Deviation10g (%)
P	1750	BODY	06/20/2021	22.0	21.2	0.1	1150	7308	1.860	19.40	18.600	-4.12%
H	1900	BODY	06/22/2021	24.0	24.5	0.1	5d149	7410	2.190	20.70	21.900	5.80%
H	1900	BODY	06/24/2021	22.6	24.0	0.1	5d149	7410	2.220	20.70	22.200	7.25%
K	2450	BODY	07/06/2021	23.8	22.2	0.1	719	7538	2.400	23.90	24.000	0.42%
K	2600	BODY	07/06/2021	23.8	22.2	0.1	1064	7538	2.450	25.00	24.500	-2.00%

FCC ID: A3LSMA127M	 PCTEST Proud to be part of Samsung	SAR EVALUATION REPORT		Approved by: Quality Manager
Document S/N: 1M2106030063-01.A3L (Rev 1)	Test Dates: 05/31/2021 - 07/07/2021	DUT Type: Portable Handset	Page 39 of 68	

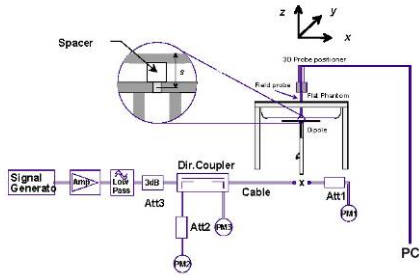



Figure 10-1
System Verification Setup Diagram



Figure 10-2
System Verification Setup Photo

FCC ID: A3LSMA127M	 <small>Proud to be part of Samsung</small>	SAR EVALUATION REPORT	 Approved by: Quality Manager
Document S/N: 1M2106030063-01.A3L (Rev 1)	Test Dates: 05/31/2021 - 07/07/2021	DUT Type: Portable Handset	Page 40 of 68

11 SAR DATA SUMMARY

11.1 Standalone Head SAR Data

**Table 11-1
GSM 850 Head SAR**



MEASUREMENT RESULTS														
FREQUENCY		Mode	Service	Maximum Allowed Power [dBm]	Conducted Power [dBm]	Power Drift [dB]	Side	Test Position	Device Serial Number	Duty Cycle	SAR (1g)	Scaling Factor	Reported SAR (1g)	Plot #
MHz	Ch.										(W/kg)		(W/kg)	
836.60	190	GSM 850	GSM	33.5	32.91	-0.20	Right	Cheek	07356	1:8.3	0.199	1.146	0.228	
836.60	190	GSM 850	GSM	33.5	32.91	0.06	Right	Tilt	07356	1:8.3	0.086	1.146	0.099	
836.60	190	GSM 850	GSM	33.5	32.91	0.03	Left	Cheek	07356	1:8.3	0.203	1.146	0.233	A1
836.60	190	GSM 850	GSM	33.5	32.91	0.03	Left	Tilt	07356	1:8.3	0.103	1.146	0.118	
ANSI / IEEE C95.1 1992 - SAFETY LIMIT Spatial Peak Uncontrolled Exposure/General Population							Head 1.6 W/kg (mW/g) averaged over 1 gram							

**Table 11-2
GSM 1900 Head SAR**

MEASUREMENT RESULTS														
FREQUENCY		Mode	Service	Maximum Allowed Power [dBm]	Conducted Power [dBm]	Power Drift [dB]	Side	Test Position	Device Serial Number	Duty Cycle	SAR (1g)	Scaling Factor	Reported SAR (1g)	Plot #
MHz	Ch.										(W/kg)		(W/kg)	
1909.80	810	GSM 1900	GSM	30.5	29.81	0.06	Right	Cheek	07356	1:8.3	0.070	1.172	0.082	
1909.80	810	GSM 1900	GSM	30.5	29.81	-0.15	Right	Tilt	07356	1:8.3	0.073	1.172	0.086	
1909.80	810	GSM 1900	GSM	30.5	29.81	-0.03	Left	Cheek	07356	1:8.3	0.104	1.172	0.122	A2
1909.80	810	GSM 1900	GSM	30.5	29.81	0.20	Left	Tilt	07356	1:8.3	0.059	1.172	0.069	
ANSI / IEEE C95.1 1992 - SAFETY LIMIT Spatial Peak Uncontrolled Exposure/General Population							Head 1.6 W/kg (mW/g) averaged over 1 gram							

**Table 11-3
UMTS 850 Head SAR**

MEASUREMENT RESULTS														
FREQUENCY		Mode	Service	Maximum Allowed Power [dBm]	Conducted Power [dBm]	Power Drift [dB]	Side	Test Position	Device Serial Number	Duty Cycle	SAR (1g)	Scaling Factor	Reported SAR (1g)	Plot #
MHz	Ch.										(W/kg)		(W/kg)	
836.60	4183	UMTS 850	RMC	25.0	23.81	0.08	Right	Cheek	07356	1:1	0.208	1.315	0.274	
836.60	4183	UMTS 850	RMC	25.0	23.81	0.16	Right	Tilt	07356	1:1	0.093	1.315	0.122	
836.60	4183	UMTS 850	RMC	25.0	23.81	0.05	Left	Cheek	07356	1:1	0.215	1.315	0.283	A3
836.60	4183	UMTS 850	RMC	25.0	23.81	0.05	Left	Tilt	07356	1:1	0.109	1.315	0.143	
ANSI / IEEE C95.1 1992 - SAFETY LIMIT Spatial Peak Uncontrolled Exposure/General Population							Head 1.6 W/kg (mW/g) averaged over 1 gram							

FCC ID: A3LSMA127M	 PCTEST Proud to be part of 	SAR EVALUATION REPORT		Approved by: Quality Manager
Document S/N: 1M2106030063-01.A3L (Rev 1)	Test Dates: 05/31/2021 - 07/07/2021	DUT Type: Portable Handset		Page 41 of 68

**Table 11-4
UMTS 1750 Head SAR**



MEASUREMENT RESULTS														
FREQUENCY		Mode	Service	Maximum Allowed Power [dBm]	Conducted Power [dBm]	Power Drift [dB]	Side	Test Position	Device Serial Number	Duty Cycle	SAR (1g)	Scaling Factor	Reported SAR (1g)	Plot #
MHz	Ch.										(W/kg)		(W/kg)	
1712.40	1312	UMTS 1750	RMC	23.0	22.41	0.11	Right	Cheek	06267	1:1	0.224	1.146	0.257	
1712.40	1312	UMTS 1750	RMC	23.0	22.41	0.16	Right	Tilt	06267	1:1	0.218	1.146	0.250	
1712.40	1312	UMTS 1750	RMC	23.0	22.41	0.01	Left	Cheek	06267	1:1	0.279	1.146	0.320	A4
1712.40	1312	UMTS 1750	RMC	23.0	22.41	0.08	Left	Tilt	06267	1:1	0.208	1.146	0.238	
ANSI / IEEE C95.1 1992 - SAFETY LIMIT Spatial Peak Uncontrolled Exposure/General Population							Head 1.6 W/kg (mW/g) averaged over 1 gram							

**Table 11-5
UMTS 1900 Head SAR**

MEASUREMENT RESULTS														
FREQUENCY		Mode	Service	Maximum Allowed Power [dBm]	Conducted Power [dBm]	Power Drift [dB]	Side	Test Position	Device Serial Number	Duty Cycle	SAR (1g)	Scaling Factor	Reported SAR (1g)	Plot #
MHz	Ch.										(W/kg)		(W/kg)	
1907.60	9538	UMTS 1900	RMC	23.0	23.00	-0.05	Right	Cheek	07356	1:1	0.273	1.000	0.273	
1907.60	9538	UMTS 1900	RMC	23.0	23.00	-0.11	Right	Tilt	07356	1:1	0.250	1.000	0.250	
1907.60	9538	UMTS 1900	RMC	23.0	23.00	0.06	Left	Cheek	07356	1:1	0.371	1.000	0.371	A5
1907.60	9538	UMTS 1900	RMC	23.0	23.00	0.02	Left	Tilt	07356	1:1	0.208	1.000	0.208	
ANSI / IEEE C95.1 1992 - SAFETY LIMIT Spatial Peak Uncontrolled Exposure/General Population							Head 1.6 W/kg (mW/g) averaged over 1 gram							

**Table 11-6
LTE Band 12 Head SAR**

MEASUREMENT RESULTS																			
FREQUENCY			Mode	Bandwidth [MHz]	Maximum Allowed Power [dBm]	Conducted Power [dBm]	Power Drift [dB]	MPR [dB]	Side	Test Position	Modulation	RB Size	RB Offset	Device Serial Number	Duty Cycle	SAR (1g)	Scaling Factor	Reported SAR (1g)	Plot #
MHz	Ch.															(W/kg)		(W/kg)	
707.50	23095	Mid	LTE Band 12	10	24.5	24.20	0.06	0	Right	Cheek	QPSK	1	49	06655	1:1	0.162	1.072	0.174	A6
707.50	23095	Mid	LTE Band 12	10	23.5	23.17	0.10	1	Right	Cheek	QPSK	25	25	06655	1:1	0.122	1.079	0.132	
707.50	23095	Mid	LTE Band 12	10	24.5	24.20	-0.06	0	Right	Tilt	QPSK	1	49	06655	1:1	0.075	1.072	0.080	
707.50	23095	Mid	LTE Band 12	10	23.5	23.17	0.06	1	Right	Tilt	QPSK	25	25	06655	1:1	0.055	1.079	0.059	
707.50	23095	Mid	LTE Band 12	10	24.5	24.20	-0.04	0	Left	Cheek	QPSK	1	49	06655	1:1	0.140	1.072	0.150	
707.50	23095	Mid	LTE Band 12	10	23.5	23.17	0.18	1	Left	Cheek	QPSK	25	25	06655	1:1	0.115	1.079	0.124	
707.50	23095	Mid	LTE Band 12	10	24.5	24.20	0.13	0	Left	Tilt	QPSK	1	49	06655	1:1	0.068	1.072	0.073	
707.50	23095	Mid	LTE Band 12	10	23.5	23.17	0.11	1	Left	Tilt	QPSK	25	25	06655	1:1	0.055	1.079	0.059	
ANSI / IEEE C95.1 1992 - SAFETY LIMIT Spatial Peak Uncontrolled Exposure/General Population							Head 1.6 W/kg (mW/g) averaged over 1 gram												

FCC ID: A3LSMA127M	 PCTEST <small>Proud to be part of @intertek</small>	SAR EVALUATION REPORT		Approved by: Quality Manager
Document S/N: 1M2106030063-01.A3L (Rev 1)	Test Dates: 05/31/2021 - 07/07/2021	DUT Type: Portable Handset		Page 42 of 68

**Table 11-7
LTE Band 26 (Cell) Head SAR**



MEASUREMENT RESULTS																			
FREQUENCY		Mode	Bandwidth [MHz]	Maximum Allowed Power [dBm]	Conducted Power [dBm]	Power Drift [dB]	MPR [dB]	Side	Test Position	Modulation	RB Size	RB Offset	Device Serial Number	Duty Cycle	SAR (1g)	Scaling Factor	Reported SAR (1g)	Plot #	
MHz	Ch.														(W/kg)		(W/kg)		
831.50	26865	Mid	LTE Band 26 (Cell)	15	25.0	24.26	-0.13	0	Right	Cheek	QPSK	1	0	07356	1:1	0.200	1.186	0.237	A7
831.50	26865	Mid	LTE Band 26 (Cell)	15	24.0	23.39	0.02	1	Right	Cheek	QPSK	36	0	07356	1:1	0.157	1.151	0.181	
831.50	26865	Mid	LTE Band 26 (Cell)	15	25.0	24.26	-0.01	0	Right	Tilt	QPSK	1	0	07356	1:1	0.101	1.186	0.120	
831.50	26865	Mid	LTE Band 26 (Cell)	15	24.0	23.39	0.06	1	Right	Tilt	QPSK	36	0	07356	1:1	0.077	1.151	0.089	
831.50	26865	Mid	LTE Band 26 (Cell)	15	25.0	24.26	0.05	0	Left	Cheek	QPSK	1	0	07356	1:1	0.195	1.186	0.231	
831.50	26865	Mid	LTE Band 26 (Cell)	15	24.0	23.39	0.13	1	Left	Cheek	QPSK	36	0	07356	1:1	0.156	1.151	0.180	
831.50	26865	Mid	LTE Band 26 (Cell)	15	25.0	24.26	-0.03	0	Left	Tilt	QPSK	1	0	07356	1:1	0.105	1.186	0.125	
831.50	26865	Mid	LTE Band 26 (Cell)	15	24.0	23.39	-0.04	1	Left	Tilt	QPSK	36	0	07356	1:1	0.087	1.151	0.100	
ANSI / IEEE C95.1 1992 - SAFETY LIMIT Spatial Peak Uncontrolled Exposure/General Population										Head 1.6 W/kg (mW/g) averaged over 1 gram									

**Table 11-8
LTE Band 66 (AWS) Head SAR**

MEASUREMENT RESULTS																			
FREQUENCY		Mode	Bandwidth [MHz]	Maximum Allowed Power [dBm]	Conducted Power [dBm]	Power Drift [dB]	MPR [dB]	Side	Test Position	Modulation	RB Size	RB Offset	Device Serial Number	Duty Cycle	SAR (1g)	Scaling Factor	Reported SAR (1g)	Plot #	
MHz	Ch.														(W/kg)		(W/kg)		
1720.00	132072	Low	LTE Band 66 (AWS)	20	23.0	21.90	-0.18	0	Right	Cheek	QPSK	1	0	06267	1:1	0.200	1.288	0.258	
1720.00	132072	Low	LTE Band 66 (AWS)	20	23.0	21.93	0.21	0	Right	Cheek	QPSK	50	25	06267	1:1	0.149	1.279	0.191	
1720.00	132072	Low	LTE Band 66 (AWS)	20	23.0	21.90	0.02	0	Right	Tilt	QPSK	1	0	06267	1:1	0.183	1.288	0.236	
1720.00	132072	Low	LTE Band 66 (AWS)	20	23.0	21.93	0.18	0	Right	Tilt	QPSK	50	25	06267	1:1	0.154	1.279	0.197	
1720.00	132072	Low	LTE Band 66 (AWS)	20	23.0	21.90	-0.13	0	Left	Cheek	QPSK	1	0	06267	1:1	0.304	1.288	0.392	A8
1720.00	132072	Low	LTE Band 66 (AWS)	20	23.0	21.93	-0.14	0	Left	Cheek	QPSK	50	25	06267	1:1	0.222	1.279	0.284	
1720.00	132072	Low	LTE Band 66 (AWS)	20	23.0	21.90	-0.20	0	Left	Tilt	QPSK	1	0	06267	1:1	0.163	1.288	0.210	
1720.00	132072	Low	LTE Band 66 (AWS)	20	23.0	21.93	-0.18	0	Left	Tilt	QPSK	50	25	06267	1:1	0.124	1.279	0.159	
ANSI / IEEE C95.1 1992 - SAFETY LIMIT Spatial Peak Uncontrolled Exposure/General Population										Head 1.6 W/kg (mW/g) averaged over 1 gram									

**Table 11-9
LTE Band 2 (PCS) Head SAR**

MEASUREMENT RESULTS																			
FREQUENCY		Mode	Bandwidth [MHz]	Maximum Allowed Power [dBm]	Conducted Power [dBm]	Power Drift [dB]	MPR [dB]	Side	Test Position	Modulation	RB Size	RB Offset	Device Serial Number	Duty Cycle	SAR (1g)	Scaling Factor	Reported SAR (1g)	Plot #	
MHz	Ch.														(W/kg)		(W/kg)		
1900.00	19100	High	LTE Band 2 (PCS)	20	22.0	21.83	-0.13	0	Right	Cheek	QPSK	1	0	07356	1:1	0.175	1.040	0.182	
1900.00	19100	High	LTE Band 2 (PCS)	20	22.0	21.65	-0.11	0	Right	Cheek	QPSK	50	25	07356	1:1	0.164	1.084	0.178	
1900.00	19100	High	LTE Band 2 (PCS)	20	22.0	21.83	0.00	0	Right	Tilt	QPSK	1	0	07356	1:1	0.161	1.040	0.167	
1900.00	19100	High	LTE Band 2 (PCS)	20	22.0	21.65	0.03	0	Right	Tilt	QPSK	50	25	07356	1:1	0.154	1.084	0.167	
1900.00	19100	High	LTE Band 2 (PCS)	20	22.0	21.83	-0.09	0	Left	Cheek	QPSK	1	0	07356	1:1	0.263	1.040	0.274	A9
1900.00	19100	High	LTE Band 2 (PCS)	20	22.0	21.65	0.03	0	Left	Cheek	QPSK	50	25	07356	1:1	0.248	1.084	0.269	
1900.00	19100	High	LTE Band 2 (PCS)	20	22.0	21.83	0.09	0	Left	Tilt	QPSK	1	0	07828	1:1	0.156	1.040	0.162	
1900.00	19100	High	LTE Band 2 (PCS)	20	22.0	21.65	0.15	0	Left	Tilt	QPSK	50	25	07828	1:1	0.122	1.084	0.132	
ANSI / IEEE C95.1 1992 - SAFETY LIMIT Spatial Peak Uncontrolled Exposure/General Population										Head 1.6 W/kg (mW/g) averaged over 1 gram									

FCC ID: A3LSMA127M	 PCTEST Proud to be part of the 	SAR EVALUATION REPORT		Approved by: Quality Manager
Document S/N: 1M2106030063-01.A3L (Rev 1)	Test Dates: 05/31/2021 - 07/07/2021	DUT Type: Portable Handset		Page 43 of 68

**Table 11-10
LTE Band 41 Head SAR**



MEASUREMENT RESULTS																			
FREQUENCY		Mode	Bandwidth [MHz]	Maximum Allowed Power [dBm]	Conducted Power [dBm]	Power Drift [dB]	MPR [dB]	Side	Test Position	Modulation	RB Size	RB Offset	Device Serial Number	Duty Cycle	SAR (1g)	Scaling Factor	Reported SAR (1g)	Plot #	
MHz	Ch.														(W/kg)		(W/kg)		
2680.00	41490	High	LTE Band 41	20	17.0	16.95	-0.12	0	Right	Cheek	QPSK	1	0	06481	1:1.58	0.537	1.012	0.543	A10
2680.00	41490	High	LTE Band 41	20	17.0	16.93	0.18	0	Right	Cheek	QPSK	50	0	06481	1:1.58	0.535	1.016	0.544	
2680.00	41490	High	LTE Band 41	20	17.0	16.95	-0.11	0	Right	Tilt	QPSK	1	0	06481	1:1.58	0.171	1.012	0.173	
2680.00	41490	High	LTE Band 41	20	17.0	16.93	-0.01	0	Right	Tilt	QPSK	50	0	06481	1:1.58	0.168	1.016	0.171	
2680.00	41490	High	LTE Band 41	20	17.0	16.95	0.06	0	Left	Cheek	QPSK	1	0	06481	1:1.58	0.159	1.012	0.161	
2680.00	41490	High	LTE Band 41	20	17.0	16.93	0.01	0	Left	Cheek	QPSK	50	0	06481	1:1.58	0.158	1.016	0.161	
2680.00	41490	High	LTE Band 41	20	17.0	16.95	0.02	0	Left	Tilt	QPSK	1	0	06481	1:1.58	0.048	1.012	0.049	
2680.00	41490	High	LTE Band 41	20	17.0	16.93	0.14	0	Left	Tilt	QPSK	50	0	06481	1:1.58	0.050	1.016	0.051	
ANSI / IEEE C95.1 1992 - SAFETY LIMIT Spatial Peak Uncontrolled Exposure/General Population										Head 1.6 W/kg (mW/g) averaged over 1 gram									

**Table 11-11
DTS Head SAR**

MEASUREMENT RESULTS																		
FREQUENCY		Mode	Service	Bandwidth [MHz]	Maximum Allowed Power [dBm]	Conducted Power [dBm]	Power Drift [dB]	Side	Test Position	Device Serial Number	Data Rate (Mbps)	Duty Cycle (%)	Peak SAR of Area Scan	SAR (1g)	Scaling Factor (Power)	Scaling Factor (Duty Cycle)	Reported SAR (1g)	Plot #
MHz	Ch.												(W/kg)	(W/kg)			(W/kg)	
2462	11	802.11b	DSSS	22	13.0	12.97	0.17	Right	Cheek	07356	1	98.6	0.263	0.165	1.007	1.014	0.168	A11
2462	11	802.11b	DSSS	22	13.0	12.97	-0.18	Right	Tilt	07356	1	98.6	0.123	-	1.007	1.014	-	
2462	11	802.11b	DSSS	22	13.0	12.97	0.09	Left	Cheek	07356	1	98.6	0.101	-	1.007	1.014	-	
2462	11	802.11b	DSSS	22	13.0	12.97	0.16	Left	Tilt	07356	1	98.6	0.106	-	1.007	1.014	-	
ANSI / IEEE C95.1 1992 - SAFETY LIMIT Spatial Peak Uncontrolled Exposure/General Population										Head 1.6 W/kg (mW/g) averaged over 1 gram								

**Table 11-12
DSS Head SAR**

MEASUREMENT RESULTS																		
FREQUENCY		Mode	Service	Maximum Allowed Power [dBm]	Conducted Power [dBm]	Power Drift [dB]	Side	Test Position	Device Serial Number	Data Rate (Mbps)	Duty Cycle (%)	SAR (1g)	Scaling Factor (Cond Power)	Scaling Factor (Duty Cycle)	Reported SAR (1g)	Plot #		
MHz	Ch.											(W/kg)			(W/kg)			
2480.00	78	Bluetooth	FHSS	9.5	9.05	0.08	Right	Cheek	07356	1	76.80	0.057	1.109	1.302	0.082	A12		
2480.00	78	Bluetooth	FHSS	9.5	9.05	-0.13	Right	Tilt	07356	1	76.80	0.037	1.109	1.302	0.053			
2480.00	78	Bluetooth	FHSS	9.5	9.05	0.07	Left	Cheek	07356	1	76.80	0.023	1.109	1.302	0.033			
2480.00	78	Bluetooth	FHSS	9.5	9.05	-0.03	Left	Tilt	07356	1	76.80	0.026	1.109	1.302	0.038			
ANSI / IEEE C95.1 1992 - SAFETY LIMIT Spatial Peak Uncontrolled Exposure/General Population										Head 1.6 W/kg (mW/g) averaged over 1 gram								

FCC ID: A3LSMA127M		SAR EVALUATION REPORT		Approved by: Quality Manager
Document S/N: 1M2106030063-01.A3L (Rev 1)	Test Dates: 05/31/2021 - 07/07/2021	DUT Type: Portable Handset		Page 44 of 68

11.2 Standalone Body-Worn SAR Data



**Table 11-13
GSM/UMTS Body-Worn SAR Data**

MEASUREMENT RESULTS														
FREQUENCY		Mode	Service	Maximum Allowed Power [dBm]	Conducted Power [dBm]	Power Drift [dB]	Spacing	Device Serial Number	Duty Cycle	Side	SAR (1g)	Scaling Factor	Reported SAR (1g)	Plot #
MHz	Ch.										(W/kg)		(W/kg)	
836.60	190	GSM 850	GSM	33.5	32.91	-0.16	15 mm	04650	1:1	back	0.221	1.146	0.253	A13
1909.80	810	GSM 1900	GSM	30.5	29.81	0.03	15 mm	07356	1:1	back	0.139	1.172	0.163	A15
836.60	4183	UMTS 850	RMC	25.0	23.81	0.03	15 mm	04650	1:1	back	0.315	1.315	0.414	A17
1712.40	1312	UMTS 1750	RMC	25.0	24.30	0.06	15 mm	06507	1:1	back	0.443	1.175	0.521	A19
1907.60	9538	UMTS 1900	RMC	25.0	24.78	0.00	15 mm	07356	1:1	back	0.505	1.052	0.531	A21
ANSI / IEEE C95.1 1992 - SAFETY LIMIT Spatial Peak Uncontrolled Exposure/General Population							Body 1.6 W/kg (mW/g) averaged over 1 gram							

**Table 11-14
LTE Body-Worn SAR Data**

MEASUREMENT RESULTS																			
FREQUENCY		Mode	Bandwidth [MHz]	Maximum Allowed Power [dBm]	Conducted Power [dBm]	Power Drift [dB]	MPR [dB]	Device Serial Number	Modulation	RB Size	RB Offset	Spacing	Side	Duty Cycle	SAR (1g)	Scaling Factor	Reported SAR (1g)	Plot #	
MHz	Ch.														(W/kg)		(W/kg)		
707.50	23095	Mid	LTE Band 12	10	24.5	24.20	-0.05	0	06655	QPSK	1	49	15 mm	back	1:1	0.279	1.072	0.299	A23
707.50	23095	Mid	LTE Band 12	10	23.5	23.17	0.04	1	06655	QPSK	25	25	15 mm	back	1:1	0.207	1.079	0.223	
831.50	26865	Mid	LTE Band 26 (Cell)	15	25.0	24.26	0.05	0	06655	QPSK	1	0	15 mm	back	1:1	0.237	1.186	0.281	A25
831.50	26865	Mid	LTE Band 26 (Cell)	15	24.0	23.39	-0.11	1	06655	QPSK	36	0	15 mm	back	1:1	0.177	1.151	0.204	
1720.00	132072	Low	LTE Band 66 (AWS)	20	25.0	23.90	0.04	0	06267	QPSK	1	0	15 mm	back	1:1	0.352	1.288	0.453	A27
1720.00	132072	Low	LTE Band 66 (AWS)	20	24.0	23.26	0.04	1	06267	QPSK	50	0	15 mm	back	1:1	0.283	1.186	0.336	
1900.00	19100	High	LTE Band 2 (PCS)	20	25.0	24.40	-0.02	0	07828	QPSK	1	0	15 mm	back	1:1	0.425	1.148	0.488	A29
1900.00	19100	High	LTE Band 2 (PCS)	20	24.0	23.35	0.01	1	07828	QPSK	50	0	15 mm	back	1:1	0.284	1.161	0.330	
2506.00	39750	Low	LTE Band 41	20	23.5	23.25	0.00	0	06481	QPSK	1	0	15 mm	back	1:1.58	0.282	1.059	0.299	
2549.50	40185	Low-Mid	LTE Band 41	20	23.5	22.78	0.03	0	06481	QPSK	1	99	15 mm	back	1:1.58	0.542	1.180	0.640	
2593.00	40620	Mid	LTE Band 41	20	23.5	23.08	0.03	0	06481	QPSK	1	99	15 mm	back	1:1.58	0.505	1.102	0.557	
2636.50	41055	Mid-High	LTE Band 41	20	23.5	23.23	-0.08	0	06481	QPSK	1	0	15 mm	back	1:1.58	0.610	1.064	0.649	
2680.00	41490	High	LTE Band 41	20	23.5	23.32	0.06	0	06481	QPSK	1	0	15 mm	back	1:1.58	0.842	1.042	0.877	A31
2506.00	39750	Low	LTE Band 41	20	22.5	22.45	0.02	1	06481	QPSK	50	0	15 mm	back	1:1.58	0.264	1.012	0.267	
2549.50	40185	Low-Mid	LTE Band 41	20	22.5	22.03	-0.01	1	06481	QPSK	50	50	15 mm	back	1:1.58	0.471	1.114	0.525	
2593.00	40620	Mid	LTE Band 41	20	22.5	22.27	0.03	1	06481	QPSK	50	50	15 mm	back	1:1.58	0.457	1.054	0.482	
2636.50	41055	Mid-High	LTE Band 41	20	22.5	22.30	-0.01	1	06481	QPSK	50	0	15 mm	back	1:1.58	0.512	1.047	0.536	
2680.00	41490	High	LTE Band 41	20	22.5	22.49	0.01	1	06481	QPSK	50	0	15 mm	back	1:1.58	0.666	1.002	0.667	
2680.00	41490	High	LTE Band 41	20	22.5	22.42	-0.02	1	06481	QPSK	100	0	15 mm	back	1:1.58	0.681	1.019	0.694	
2680.00	41490	High	LTE Band 41	20	23.5	23.32	-0.02	0	06481	QPSK	1	0	15 mm	back	1:1.58	0.837	1.042	0.872	
ANSI / IEEE C95.1 1992 - SAFETY LIMIT Spatial Peak Uncontrolled Exposure/General Population							Body 1.6 W/kg (mW/g) averaged over 1 gram												

Note: Blue entries represent variability measurements.



FCC ID: A3LSMA127M	 PCTEST Proud to be part of  Samsung	SAR EVALUATION REPORT		Approved by: Quality Manager
Document S/N: 1M2106030063-01.A3L (Rev 1)	Test Dates: 05/31/2021 - 07/07/2021	DUT Type: Portable Handset		Page 45 of 68

**Table 11-15
DTS Body-Worn SAR Data**

MEASUREMENT RESULTS																		
FREQUENCY		Mode	Service	Bandwidth [MHz]	Maximum Allowed Power [dBm]	Conducted Power [dBm]	Power Drift [dB]	Spacing	Device Serial Number	Data Rate (Mbps)	Side	Duty Cycle (%)	Peak SAR of Area Scan	SAR (1g)	Scaling Factor (Power)	Scaling Factor (Duty Cycle)	Reported SAR (1g)	Plot #
MHz	Ch.												(W/kg)	(W/kg)			(W/kg)	
2462	11	802.11b	DSSS	22	18.5	18.01	0.04	15 mm	04254	1	back	98.6	0.079	0.066	1.119	1.014	0.075	A33
ANSI / IEEE C95.1 1992 - SAFETY LIMIT Spatial Peak Uncontrolled Exposure/General Population							Body 1.6 W/kg (mW/g) averaged over 1 gram											

**Table 11-16
DSS Body-Worn SAR Data**

MEASUREMENT RESULTS																	
FREQUENCY		Mode	Service	Maximum Allowed Power [dBm]	Conducted Power [dBm]	Power Drift [dB]	Spacing	Device Serial Number	Data Rate (Mbps)	Side	Duty Cycle (%)	SAR (1g)	Scaling Factor (Cond Power)	Scaling Factor (Duty Cycle)	Reported SAR (1g)	Plot #	
MHz	Ch.											(W/kg)			(W/kg)		
2480	78	Bluetooth	FHSS	9.5	9.05	-0.15	15 mm	04254	1	back	76.8	0.006	1.109	1.302	0.009	A35	
ANSI / IEEE C95.1 1992 - SAFETY LIMIT Spatial Peak Uncontrolled Exposure/General Population							Body 1.6 W/kg (mW/g) averaged over 1 gram										



FCC ID: A3LSMA127M	 <small>Proved to be part of Samsung</small>	SAR EVALUATION REPORT		Approved by: Quality Manager
Document S/N: 1M2106030063-01.A3L (Rev 1)	Test Dates: 05/31/2021 - 07/07/2021	DUT Type: Portable Handset		Page 46 of 68

11.3 Standalone Hotspot SAR Data

**Table 11-17
GPRS/UMTS Hotspot SAR Data**

MEASUREMENT RESULTS															
FREQUENCY		Mode	Service	Maximum Allowed Power [dBm]	Conducted Power [dBm]	Power Drift [dB]	Spacing	Device Serial Number	# of Time Slots	Duty Cycle	Side	SAR (1g)	Scaling Factor	Reported SAR	Plot #
MHz	Ch.											(W/kg)		(W/kg)	
848.80	251	GSM 850	GPRS	30.0	29.44	0.17	10 mm	04650	3	1:2.76	back	0.464	1.138	0.528	A14
848.80	251	GSM 850	GPRS	30.0	29.44	0.00	10 mm	04650	3	1:2.76	front	0.263	1.138	0.299	
848.80	251	GSM 850	GPRS	30.0	29.44	0.04	10 mm	04650	3	1:2.76	bottom	0.147	1.138	0.167	
848.80	251	GSM 850	GPRS	30.0	29.44	0.17	10 mm	04650	3	1:2.76	right	0.309	1.138	0.352	
848.80	251	GSM 850	GPRS	30.0	29.44	0.01	10 mm	04650	3	1:2.76	left	0.191	1.138	0.217	
1909.80	810	GSM 1900	GPRS	26.0	25.30	0.04	10 mm	07356	3	1:2.76	back	0.341	1.175	0.401	A16
1909.80	810	GSM 1900	GPRS	26.0	25.30	-0.07	10 mm	07356	3	1:2.76	front	0.195	1.175	0.229	
1909.80	810	GSM 1900	GPRS	26.0	25.30	0.16	10 mm	07356	3	1:2.76	bottom	0.272	1.175	0.320	
1909.80	810	GSM 1900	GPRS	26.0	25.30	-0.09	10 mm	07356	3	1:2.76	right	0.088	1.175	0.103	
1909.80	810	GSM 1900	GPRS	26.0	25.30	0.03	10 mm	07356	3	1:2.76	left	0.157	1.175	0.184	
836.60	4183	UMTS 850	RMC	25.0	23.81	-0.04	10 mm	04650	N/A	1:1	back	0.399	1.315	0.525	A18
836.60	4183	UMTS 850	RMC	25.0	23.81	0.03	10 mm	04650	N/A	1:1	front	0.198	1.315	0.260	
836.60	4183	UMTS 850	RMC	25.0	23.81	0.08	10 mm	04650	N/A	1:1	bottom	0.091	1.315	0.120	
836.60	4183	UMTS 850	RMC	25.0	23.81	0.02	10 mm	04650	N/A	1:1	right	0.262	1.315	0.345	
836.60	4183	UMTS 850	RMC	25.0	23.81	0.03	10 mm	04650	N/A	1:1	left	0.169	1.315	0.222	
1712.40	1312	UMTS 1750	RMC	25.0	24.30	-0.02	10 mm	06507	N/A	1:1	back	0.823	1.175	0.967	
1732.40	1412	UMTS 1750	RMC	25.0	24.27	-0.09	10 mm	06507	N/A	1:1	back	0.910	1.183	1.077	A20
1752.60	1513	UMTS 1750	RMC	25.0	24.20	0.02	10 mm	06507	N/A	1:1	back	0.805	1.202	0.968	
1712.40	1312	UMTS 1750	RMC	25.0	24.30	0.04	10 mm	06507	N/A	1:1	front	0.830	1.175	0.975	
1732.40	1412	UMTS 1750	RMC	25.0	24.27	0.01	10 mm	06507	N/A	1:1	front	0.850	1.183	1.006	
1752.60	1513	UMTS 1750	RMC	25.0	24.20	0.00	10 mm	06507	N/A	1:1	front	0.780	1.202	0.938	
1712.40	1312	UMTS 1750	RMC	25.0	24.30	0.01	10 mm	06507	N/A	1:1	bottom	0.815	1.175	0.958	
1732.40	1412	UMTS 1750	RMC	25.0	24.27	-0.06	10 mm	06507	N/A	1:1	bottom	0.839	1.183	0.993	
1752.60	1513	UMTS 1750	RMC	25.0	24.20	0.00	10 mm	06507	N/A	1:1	bottom	0.819	1.202	0.984	
1712.40	1312	UMTS 1750	RMC	25.0	24.30	-0.01	10 mm	06507	N/A	1:1	right	0.345	1.175	0.405	
1712.40	1312	UMTS 1750	RMC	25.0	24.30	-0.05	10 mm	06507	N/A	1:1	left	0.666	1.175	0.783	
1732.40	1412	UMTS 1750	RMC	25.0	24.27	0.02	10 mm	06507	N/A	1:1	back	0.872	1.183	1.032	
1852.40	9262	UMTS 1900	RMC	23.0	22.64	0.01	10 mm	06655	N/A	1:1	back	0.512	1.086	0.556	
1880.00	9400	UMTS 1900	RMC	23.0	22.85	-0.01	10 mm	06655	N/A	1:1	back	0.452	1.035	0.468	
1907.60	9538	UMTS 1900	RMC	23.0	23.00	-0.04	10 mm	06655	N/A	1:1	back	0.917	1.000	0.917	A22
1907.60	9538	UMTS 1900	RMC	23.0	23.00	0.02	10 mm	06655	N/A	1:1	front	0.389	1.000	0.389	
1907.60	9538	UMTS 1900	RMC	23.0	23.00	-0.04	10 mm	06655	N/A	1:1	bottom	0.382	1.000	0.382	
1907.60	9538	UMTS 1900	RMC	23.0	23.00	0.06	10 mm	06655	N/A	1:1	right	0.161	1.000	0.161	
1907.60	9538	UMTS 1900	RMC	23.0	23.00	-0.04	10 mm	06655	N/A	1:1	left	0.337	1.000	0.337	
1907.60	9538	UMTS 1900	RMC	23.0	23.00	-0.04	10 mm	06655	N/A	1:1	back	0.895	1.000	0.895	
ANSI / IEEE C95.1 1992 - SAFETY LIMIT Spatial Peak Uncontrolled Exposure/General Population							Body 1.6 W/kg (mW/g) averaged over 1 gram								

Note: Blue entries represent variability measurements.



FCC ID: A3LSMA127M	 PCTEST Proud to be part of the  Samsung	SAR EVALUATION REPORT		Approved by: Quality Manager
Document S/N: 1M2106030063-01.A3L (Rev 1)	Test Dates: 05/31/2021 - 07/07/2021	DUT Type: Portable Handset		Page 47 of 68

**Table 11-18
LTE Band 12 Hotspot SAR Data**

MEASUREMENT RESULTS																			
FREQUENCY		Mode	Bandwidth [MHz]	Maximum Allowed Power [dBm]	Conducted Power [dBm]	Power Drift [dB]	MPR [dB]	Device Serial Number	Modulation	RB Size	RB Offset	Spacing	Side	Duty Cycle	SAR (1g)	Scaling Factor	Reported SAR (1g)	Plot #	
MHz	Ch.														(W/kg)		(W/kg)		
707.50	23095	Mid	LTE Band 12	10	24.5	24.20	0.02	0	06655	QPSK	1	49	10 mm	back	1:1	0.301	1.072	0.323	A24
707.50	23095	Mid	LTE Band 12	10	23.5	23.17	0.03	1	06655	QPSK	25	25	10 mm	back	1:1	0.267	1.079	0.288	
707.50	23095	Mid	LTE Band 12	10	24.5	24.20	0.17	0	06655	QPSK	1	49	10 mm	front	1:1	0.164	1.072	0.176	
707.50	23095	Mid	LTE Band 12	10	23.5	23.17	0.08	1	06655	QPSK	25	25	10 mm	front	1:1	0.126	1.079	0.136	
707.50	23095	Mid	LTE Band 12	10	24.5	24.20	0.16	0	06655	QPSK	1	49	10 mm	bottom	1:1	0.052	1.072	0.056	
707.50	23095	Mid	LTE Band 12	10	23.5	23.17	0.21	1	06655	QPSK	25	25	10 mm	bottom	1:1	0.041	1.079	0.044	
707.50	23095	Mid	LTE Band 12	10	24.5	24.20	-0.03	0	06655	QPSK	1	49	10 mm	right	1:1	0.207	1.072	0.222	
707.50	23095	Mid	LTE Band 12	10	23.5	23.17	-0.03	1	06655	QPSK	25	25	10 mm	right	1:1	0.155	1.079	0.167	
707.50	23095	Mid	LTE Band 12	10	24.5	24.20	0.15	0	06655	QPSK	1	49	10 mm	left	1:1	0.151	1.072	0.162	
707.50	23095	Mid	LTE Band 12	10	23.5	23.17	0.01	1	06655	QPSK	25	25	10 mm	left	1:1	0.116	1.079	0.125	
ANSI / IEEE C95.1 1992 - SAFETY LIMIT Spatial Peak Uncontrolled Exposure/General Population									Body 1.6 W/kg (mW/g) averaged over 1 gram										

**Table 11-19
LTE Band 26 (Cell) Hotspot SAR Data**

MEASUREMENT RESULTS																			
FREQUENCY		Mode	Bandwidth [MHz]	Maximum Allowed Power [dBm]	Conducted Power [dBm]	Power Drift [dB]	MPR [dB]	Device Serial Number	Modulation	RB Size	RB Offset	Spacing	Side	Duty Cycle	SAR (1g)	Scaling Factor	Reported SAR (1g)	Plot #	
MHz	Ch.														(W/kg)		(W/kg)		
831.50	26865	Mid	LTE Band 26 (Cell)	15	25.0	24.26	-0.01	0	06655	QPSK	1	0	10 mm	back	1:1	0.392	1.186	0.465	A26
831.50	26865	Mid	LTE Band 26 (Cell)	15	24.0	23.39	-0.08	1	06655	QPSK	36	0	10 mm	back	1:1	0.318	1.151	0.366	
831.50	26865	Mid	LTE Band 26 (Cell)	15	25.0	24.26	0.01	0	06655	QPSK	1	0	10 mm	front	1:1	0.196	1.186	0.232	
831.50	26865	Mid	LTE Band 26 (Cell)	15	24.0	23.39	0.00	1	06655	QPSK	36	0	10 mm	front	1:1	0.148	1.151	0.170	
831.50	26865	Mid	LTE Band 26 (Cell)	15	25.0	24.26	0.01	0	06655	QPSK	1	0	10 mm	bottom	1:1	0.081	1.186	0.096	
831.50	26865	Mid	LTE Band 26 (Cell)	15	24.0	23.39	0.16	1	06655	QPSK	36	0	10 mm	bottom	1:1	0.063	1.151	0.073	
831.50	26865	Mid	LTE Band 26 (Cell)	15	25.0	24.26	-0.02	0	06655	QPSK	1	0	10 mm	right	1:1	0.228	1.186	0.270	
831.50	26865	Mid	LTE Band 26 (Cell)	15	24.0	23.39	0.10	1	06655	QPSK	36	0	10 mm	right	1:1	0.174	1.151	0.200	
831.50	26865	Mid	LTE Band 26 (Cell)	15	25.0	24.26	0.16	0	06655	QPSK	1	0	10 mm	left	1:1	0.140	1.186	0.166	
831.50	26865	Mid	LTE Band 26 (Cell)	15	24.0	23.39	0.07	1	06655	QPSK	36	0	10 mm	left	1:1	0.114	1.151	0.131	
ANSI / IEEE C95.1 1992 - SAFETY LIMIT Spatial Peak Uncontrolled Exposure/General Population									Body 1.6 W/kg (mW/g) averaged over 1 gram										



FCC ID: A3LSMA127M		SAR EVALUATION REPORT		Approved by: Quality Manager
Document S/N: 1M2106030063-01.A3L (Rev 1)	Test Dates: 05/31/2021 - 07/07/2021	DUT Type: Portable Handset		Page 48 of 68

**Table 11-20
LTE Band 66 (AWS) Hotspot SAR Data**

MEASUREMENT RESULTS																			
FREQUENCY		Mode	Bandwidth [MHz]	Maximum Allowed Power [dBm]	Conducted Power [dBm]	Power Drift [dB]	MPR [dB]	Device Serial Number	Modulation	RB Size	RB Offset	Spacing	Side	Duty Cycle	SAR (1g)	Scaling Factor	Reported SAR (1g)	Plot #	
MHz	Ch.														(W/kg)		(W/kg)		
1720.00	132072	Low	LTE Band 66 (AWS)	20	25.0	23.90	-0.04	0	06267	QPSK	1	0	10 mm	back	1:1	0.688	1.288	0.886	
1745.00	132322	Mid	LTE Band 66 (AWS)	20	25.0	23.28	-0.09	0	06267	QPSK	1	99	10 mm	back	1:1	0.777	1.486	1.155	A28
1770.00	132572	High	LTE Band 66 (AWS)	20	25.0	23.09	-0.06	0	06267	QPSK	1	0	10 mm	back	1:1	0.585	1.552	0.908	
1720.00	132072	Low	LTE Band 66 (AWS)	20	24.0	23.26	-0.01	1	06267	QPSK	50	0	10 mm	back	1:1	0.566	1.186	0.671	
1720.00	132072	Low	LTE Band 66 (AWS)	20	24.0	22.86	-0.12	1	06267	QPSK	100	0	10 mm	back	1:1	0.611	1.300	0.794	
1720.00	132072	Low	LTE Band 66 (AWS)	20	25.0	23.90	0.10	0	06267	QPSK	1	0	10 mm	front	1:1	0.757	1.288	0.975	
1745.00	132322	Mid	LTE Band 66 (AWS)	20	25.0	23.28	0.04	0	06267	QPSK	1	99	10 mm	front	1:1	0.735	1.486	1.092	
1770.00	132572	High	LTE Band 66 (AWS)	20	25.0	23.09	0.09	0	06267	QPSK	1	0	10 mm	front	1:1	0.560	1.552	0.869	
1720.00	132072	Low	LTE Band 66 (AWS)	20	24.0	23.26	0.05	1	06267	QPSK	50	0	10 mm	front	1:1	0.612	1.186	0.726	
1720.00	132072	Low	LTE Band 66 (AWS)	20	24.0	22.86	0.05	1	06267	QPSK	100	0	10 mm	front	1:1	0.620	1.300	0.806	
1720.00	132072	Low	LTE Band 66 (AWS)	20	25.0	23.90	-0.01	0	06267	QPSK	1	0	10 mm	bottom	1:1	0.561	1.288	0.723	
1720.00	132072	Low	LTE Band 66 (AWS)	20	24.0	23.26	0.03	1	06267	QPSK	50	0	10 mm	bottom	1:1	0.447	1.186	0.530	
1720.00	132072	Low	LTE Band 66 (AWS)	20	25.0	23.90	-0.05	0	06267	QPSK	1	0	10 mm	right	1:1	0.282	1.288	0.363	
1720.00	132072	Low	LTE Band 66 (AWS)	20	24.0	23.26	0.06	1	06267	QPSK	50	0	10 mm	right	1:1	0.236	1.186	0.280	
1720.00	132072	Low	LTE Band 66 (AWS)	20	25.0	23.90	-0.10	0	06267	QPSK	1	0	10 mm	left	1:1	0.515	1.288	0.663	
1720.00	132072	Low	LTE Band 66 (AWS)	20	24.0	23.26	0.04	1	06267	QPSK	50	0	10 mm	left	1:1	0.422	1.186	0.500	
ANSI / IEEE C95.1 1992 - SAFETY LIMIT Spatial Peak Uncontrolled Exposure/General Population									Body 1.6 W/kg (mW/g) averaged over 1 gram										

**Table 11-21
LTE Band 2 (PCS) Hotspot SAR Data**

MEASUREMENT RESULTS																			
FREQUENCY		Mode	Bandwidth [MHz]	Maximum Allowed Power [dBm]	Conducted Power [dBm]	Power Drift [dB]	MPR [dB]	Device Serial Number	Modulation	RB Size	RB Offset	Spacing	Side	Duty Cycle	SAR (1g)	Scaling Factor	Reported SAR (1g)	Plot #	
MHz	Ch.														(W/kg)		(W/kg)		
1860.00	18700	Low	LTE Band 2 (PCS)	20	25.0	24.07	-0.11	0	07828	QPSK	1	50	10 mm	back	1:1	0.710	1.239	0.880	
1880.00	18900	Mid	LTE Band 2 (PCS)	20	25.0	24.18	-0.06	0	07828	QPSK	1	0	10 mm	back	1:1	0.692	1.208	0.836	
1900.00	19100	High	LTE Band 2 (PCS)	20	25.0	24.40	-0.05	0	07828	QPSK	1	0	10 mm	back	1:1	0.916	1.148	1.052	A30
1860.00	18700	Low	LTE Band 2 (PCS)	20	24.0	23.04	0.01	1	07828	QPSK	50	0	10 mm	back	1:1	0.534	1.247	0.666	
1880.00	18900	Mid	LTE Band 2 (PCS)	20	24.0	23.34	-0.02	1	07828	QPSK	50	0	10 mm	back	1:1	0.501	1.164	0.583	
1900.00	19100	High	LTE Band 2 (PCS)	20	24.0	23.35	-0.03	1	07828	QPSK	50	0	10 mm	back	1:1	0.791	1.161	0.918	
1900.00	19100	High	LTE Band 2 (PCS)	20	24.0	23.30	0.03	1	07828	QPSK	100	0	10 mm	back	1:1	0.864	1.175	1.015	
1900.00	19100	High	LTE Band 2 (PCS)	20	25.0	24.40	0.04	0	07828	QPSK	1	0	10 mm	front	1:1	0.481	1.148	0.552	
1900.00	19100	High	LTE Band 2 (PCS)	20	24.0	23.35	0.00	1	07828	QPSK	50	0	10 mm	front	1:1	0.414	1.161	0.481	
1900.00	19100	High	LTE Band 2 (PCS)	20	25.0	24.40	-0.05	0	07828	QPSK	1	0	10 mm	bottom	1:1	0.403	1.148	0.463	
1900.00	19100	High	LTE Band 2 (PCS)	20	24.0	23.35	-0.19	1	07828	QPSK	50	0	10 mm	bottom	1:1	0.323	1.161	0.375	
1900.00	19100	High	LTE Band 2 (PCS)	20	25.0	24.40	-0.04	0	07828	QPSK	1	0	10 mm	right	1:1	0.164	1.148	0.188	
1900.00	19100	High	LTE Band 2 (PCS)	20	24.0	23.35	-0.03	1	07828	QPSK	50	0	10 mm	right	1:1	0.135	1.161	0.157	
1900.00	19100	High	LTE Band 2 (PCS)	20	25.0	24.40	-0.04	0	07828	QPSK	1	0	10 mm	left	1:1	0.398	1.148	0.457	
1900.00	19100	High	LTE Band 2 (PCS)	20	24.0	23.35	0.02	1	07828	QPSK	50	0	10 mm	left	1:1	0.350	1.161	0.406	
ANSI / IEEE C95.1 1992 - SAFETY LIMIT Spatial Peak Uncontrolled Exposure/General Population									Body 1.6 W/kg (mW/g) averaged over 1 gram										

FCC ID: A3LSMA127M	 PCTEST Proud to be part of 	SAR EVALUATION REPORT		Approved by: Quality Manager
Document S/N: 1M2106030063-01.A3L (Rev 1)	Test Dates: 05/31/2021 - 07/07/2021	DUT Type: Portable Handset		Page 49 of 68

**Table 11-22
LTE Band 41 Hotspot SAR Data**



MEASUREMENT RESULTS																			
FREQUENCY		Mode	Bandwidth [MHz]	Maximum Allowed Power [dBm]	Conducted Power [dBm]	Power Drift [dB]	MPR [dB]	Device Serial Number	Modulation	RB Size	RB Offset	Spacing	Side	Duty Cycle	SAR (1g) (W/kg)	Scaling Factor	Reported SAR (1g) (W/kg)	Plot #	
MHz	Ch.																		
2680.00	41490	High	LTE Band 41	20	17.0	16.95	0.11	0	06481	QPSK	1	0	10 mm	back	1:1.58	0.243	1.012	0.246	
2680.00	41490	High	LTE Band 41	20	17.0	16.93	0.05	0	06481	QPSK	50	0	10 mm	back	1:1.58	0.259	1.016	0.263	A32
2680.00	41490	High	LTE Band 41	20	17.0	16.95	0.17	0	06481	QPSK	1	0	10 mm	front	1:1.58	0.063	1.012	0.064	
2680.00	41490	High	LTE Band 41	20	17.0	16.93	0.19	0	06481	QPSK	50	0	10 mm	front	1:1.58	0.065	1.016	0.066	
2680.00	41490	High	LTE Band 41	20	17.0	16.95	0.16	0	06481	QPSK	1	0	10 mm	top	1:1.58	0.023	1.012	0.023	
2680.00	41490	High	LTE Band 41	20	17.0	16.93	0.19	0	06481	QPSK	50	0	10 mm	top	1:1.58	0.024	1.016	0.024	
2680.00	41490	High	LTE Band 41	20	17.0	16.95	0.05	0	06481	QPSK	1	0	10 mm	left	1:1.58	0.202	1.012	0.204	
2680.00	41490	High	LTE Band 41	20	17.0	16.93	0.03	0	06481	QPSK	50	0	10 mm	left	1:1.58	0.215	1.016	0.218	
ANSI / IEEE C95.1 1992 - SAFETY LIMIT Spatial Peak Uncontrolled Exposure/General Population										Body 1.6 W/kg (mW/g) averaged over 1 gram									

**Table 11-23
WLAN Hotspot SAR Data**

MEASUREMENT RESULTS																		
FREQUENCY		Mode	Service	Bandwidth [MHz]	Maximum Allowed Power [dBm]	Conducted Power [dBm]	Power Drift [dB]	Spacing	Device Serial Number	Data Rate (Mbps)	Side	Duty Cycle (%)	Peak SAR of Area Scan (W/kg)	SAR (1g) (W/kg)	Scaling Factor (Power)	Scaling Factor (Duty Cycle)	Reported SAR (1g) (W/kg)	Plot #
MHz	Ch.																	
2462	11	802.11b	DSSS	22	18.5	18.01	0.00	10 mm	04254	1	back	98.6	0.181	0.143	1.119	1.014	0.162	A34
2462	11	802.11b	DSSS	22	18.5	18.01	-0.21	10 mm	04254	1	front	98.6	0.107	-	1.119	1.014	-	
2462	11	802.11b	DSSS	22	18.5	18.01	-0.10	10 mm	04254	1	top	98.6	0.119	-	1.119	1.014	-	
2462	11	802.11b	DSSS	22	18.5	18.01	-0.19	10 mm	04254	1	left	98.6	0.102	-	1.119	1.014	-	
ANSI / IEEE C95.1 1992 - SAFETY LIMIT Spatial Peak Uncontrolled Exposure/General Population										Body 1.6 W/kg (mW/g) averaged over 1 gram								

**Table 11-24
DSS Hotspot SAR Data**

MEASUREMENT RESULTS																	
FREQUENCY		Mode	Service	Maximum Allowed Power [dBm]	Conducted Power [dBm]	Power Drift [dB]	Spacing	Device Serial Number	Data Rate (Mbps)	Side	Duty Cycle (%)	SAR (1g) (W/kg)	Scaling Factor (Cond Power)	Scaling Factor (Duty Cycle)	Reported SAR (1g) (W/kg)	Plot #	
MHz	Ch.																
2480	78	Bluetooth	FHSS	9.5	9.05	-0.01	10 mm	04254	1	back	76.80	0.011	1.109	1.302	0.016	A36	
2480	78	Bluetooth	FHSS	9.5	9.05	0.14	10 mm	04254	1	front	76.80	0.010	1.109	1.302	0.014		
2480	78	Bluetooth	FHSS	9.5	9.05	0.00	10 mm	04254	1	top	76.80	0.010	1.109	1.302	0.014		
2480	78	Bluetooth	FHSS	9.5	9.05	0.12	10 mm	04254	1	left	76.80	0.007	1.109	1.302	0.010		
ANSI / IEEE C95.1 1992 - SAFETY LIMIT Spatial Peak Uncontrolled Exposure/General Population										Body 1.6 W/kg (mW/g) averaged over 1 gram							



FCC ID: A3LSMA127M	 PCTEST Proud to be part of 	SAR EVALUATION REPORT		Approved by: Quality Manager
Document S/N: 1M2106030063-01.A3L (Rev 1)	Test Dates: 05/31/2021 - 07/07/2021	DUT Type: Portable Handset		Page 50 of 68

11.4 Standalone Phablet SAR Data

**Table 11-25
UMTS Phablet SAR Data**



MEASUREMENT RESULTS														
FREQUENCY		Mode	Service	Maximum Allowed Power [dBm]	Conducted Power [dBm]	Power Drift [dB]	Spacing	Device Serial Number	Duty Cycle	Side	SAR (10g)	Scaling Factor	Reported SAR (10g)	Plot #
MHz	Ch.										(W/kg)		(W/kg)	
1712.40	1312	UMTS 1750	RMC	25.0	24.30	-0.10	8 mm	06267	1:1	back	0.419	1.175	0.492	
1712.40	1312	UMTS 1750	RMC	25.0	24.30	0.02	0 mm	06267	1:1	front	1.360	1.175	1.598	
1712.40	1312	UMTS 1750	RMC	25.0	24.30	-0.07	0 mm	06267	1:1	bottom	1.490	1.175	1.751	
1712.40	1312	UMTS 1750	RMC	25.0	24.30	-0.02	0 mm	06267	1:1	right	0.292	1.175	0.343	
1712.40	1312	UMTS 1750	RMC	25.0	24.30	-0.09	0 mm	06267	1:1	left	1.310	1.175	1.539	
1712.40	1312	UMTS 1750	RMC	23.0	22.41	-0.11	0 mm	06267	1:1	back	2.280	1.146	2.613	A37
1732.40	1412	UMTS 1750	RMC	23.0	22.30	-0.17	0 mm	06267	1:1	back	2.240	1.175	2.632	
1752.60	1513	UMTS 1750	RMC	23.0	21.89	-0.20	0 mm	06267	1:1	back	1.920	1.291	2.479	
1712.40	1312	UMTS 1750	RMC	23.0	22.41	-0.15	0 mm	06267	1:1	back	2.200	1.146	2.521	
1907.60	9538	UMTS 1900	RMC	25.0	24.78	-0.02	8 mm	06655	1:1	back	0.602	1.052	0.633	
1907.60	9538	UMTS 1900	RMC	25.0	24.78	0.02	0 mm	06655	1:1	front	1.620	1.052	1.704	
1907.60	9538	UMTS 1900	RMC	25.0	24.78	-0.08	0 mm	06655	1:1	bottom	1.310	1.052	1.378	
1907.60	9538	UMTS 1900	RMC	25.0	24.78	0.11	0 mm	06655	1:1	right	0.382	1.052	0.402	
1907.60	9538	UMTS 1900	RMC	25.0	24.78	-0.05	0 mm	06655	1:1	left	1.570	1.052	1.652	
1852.40	9262	UMTS 1900	RMC	23.0	22.64	-0.02	0 mm	06655	1:1	back	1.660	1.086	1.803	
1880.00	9400	UMTS 1900	RMC	23.0	22.85	-0.01	0 mm	06655	1:1	back	1.660	1.035	1.718	
1907.60	9538	UMTS 1900	RMC	23.0	23.00	-0.03	0 mm	06655	1:1	back	2.710	1.000	2.710	A38
1907.60	9538	UMTS 1900	RMC	23.0	23.00	0.00	0 mm	06655	1:1	back	2.580	1.000	2.580	
ANSI / IEEE C95.1 1992 - SAFETY LIMIT Spatial Peak Uncontrolled Exposure/General Population							Phablet 4.0 W/kg (mW/g) averaged over 10 grams							

Note: Blue entries represent variability measurements.

FCC ID: A3LSMA127M	 PCTEST Proud to be part of  SAMSUNG	SAR EVALUATION REPORT	Approved by: Quality Manager
Document S/N: 1M2106030063-01.A3L (Rev 1)	Test Dates: 05/31/2021 - 07/07/2021	DUT Type: Portable Handset	Page 51 of 68



**Table 11-26
LTE Band 66 (AWS) Phablet SAR Data**

MEASUREMENT RESULTS																			
FREQUENCY		Mode	Bandwidth [MHz]	Maximum Allowed Power [dBm]	Conducted Power [dBm]	Power Drift [dB]	MPR [dB]	Serial Number	Modulation	RB Size	RB Offset	Spacing	Side	Duty Cycle	SAR (10g)	Scaling Factor	Reported SAR (10g)	Plot #	
MHz	Ch.														(W/kg)		(W/kg)		
1720.00	132072	Low	LTE Band 66 (AWS)	20	25.0	23.90	-0.04	0	06267	QPSK	1	0	8 mm	back	1:1	0.486	1.288	0.626	
1720.00	132072	Low	LTE Band 66 (AWS)	20	24.0	23.26	-0.02	1	06267	QPSK	50	0	8 mm	back	1:1	0.397	1.186	0.471	
1720.00	132072	Low	LTE Band 66 (AWS)	20	25.0	23.90	0.00	0	06267	QPSK	1	0	0 mm	front	1:1	1.440	1.288	1.855	
1720.00	132072	Low	LTE Band 66 (AWS)	20	24.0	23.26	0.09	1	06267	QPSK	50	0	0 mm	front	1:1	1.180	1.186	1.399	
1720.00	132072	Low	LTE Band 66 (AWS)	20	25.0	23.90	-0.09	0	06267	QPSK	1	0	0 mm	bottom	1:1	1.900	1.288	2.447	A39
1745.00	132322	Mid	LTE Band 66 (AWS)	20	25.0	23.28	-0.02	0	06267	QPSK	1	99	0 mm	bottom	1:1	1.680	1.486	2.496	
1770.00	132572	High	LTE Band 66 (AWS)	20	25.0	23.09	-0.09	0	06267	QPSK	1	0	0 mm	bottom	1:1	1.460	1.552	2.266	
1720.00	132072	Low	LTE Band 66 (AWS)	20	24.0	23.26	-0.06	1	06267	QPSK	50	0	0 mm	bottom	1:1	1.500	1.186	1.779	
1720.00	132072	Low	LTE Band 66 (AWS)	20	24.0	22.86	-0.07	1	06267	QPSK	100	0	0 mm	bottom	1:1	1.500	1.300	1.950	
1720.00	132072	Low	LTE Band 66 (AWS)	20	25.0	23.90	-0.02	0	06267	QPSK	1	0	0 mm	right	1:1	0.388	1.288	0.500	
1720.00	132072	Low	LTE Band 66 (AWS)	20	24.0	23.26	0.03	1	06267	QPSK	50	0	0 mm	right	1:1	0.327	1.186	0.388	
1720.00	132072	Low	LTE Band 66 (AWS)	20	25.0	23.90	-0.01	0	06267	QPSK	1	0	0 mm	left	1:1	1.580	1.288	2.035	
1745.00	132322	Mid	LTE Band 66 (AWS)	20	25.0	23.28	0.00	0	06267	QPSK	1	99	0 mm	left	1:1	1.430	1.486	2.125	
1770.00	132572	High	LTE Band 66 (AWS)	20	25.0	23.09	-0.02	0	06267	QPSK	1	0	0 mm	left	1:1	1.410	1.552	2.188	
1720.00	132072	Low	LTE Band 66 (AWS)	20	24.0	23.26	-0.03	1	06267	QPSK	50	0	0 mm	left	1:1	1.260	1.186	1.494	
1720.00	132072	Low	LTE Band 66 (AWS)	20	24.0	22.86	-0.02	1	06267	QPSK	100	0	0 mm	left	1:1	1.280	1.300	1.664	
1720.00	132072	Low	LTE Band 66 (AWS)	20	23.0	21.90	-0.11	0	06267	QPSK	1	0	0 mm	back	1:1	1.880	1.288	2.421	
1745.00	132322	Mid	LTE Band 66 (AWS)	20	23.0	21.37	-0.12	0	06267	QPSK	1	0	0 mm	back	1:1	1.570	1.455	2.284	
1770.00	132572	High	LTE Band 66 (AWS)	20	23.0	21.15	-0.13	0	06267	QPSK	1	0	0 mm	back	1:1	1.640	1.531	2.511	
1720.00	132072	Low	LTE Band 66 (AWS)	20	23.0	21.93	-0.12	0	06267	QPSK	50	25	0 mm	back	1:1	1.830	1.279	2.341	
1745.00	132322	Mid	LTE Band 66 (AWS)	20	23.0	21.43	-0.15	0	06267	QPSK	50	0	0 mm	back	1:1	1.590	1.435	2.282	
1770.00	132572	High	LTE Band 66 (AWS)	20	23.0	21.18	-0.12	0	06267	QPSK	50	0	0 mm	back	1:1	1.640	1.521	2.494	
1720.00	132072	Low	LTE Band 66 (AWS)	20	23.0	21.89	-0.19	0	06267	QPSK	100	0	0 mm	back	1:1	1.840	1.291	2.375	
ANSI / IEEE C95.1 1992 - SAFETY LIMIT Spatial Peak Uncontrolled Exposure/General Population									Phablet 4.0 W/kg (mW/g) averaged over 10 grams										

FCC ID: A3LSMA127M	 PCTEST <small>Prove to be part of the solution</small>	SAR EVALUATION REPORT		Approved by: Quality Manager
Document S/N: 1M2106030063-01.A3L (Rev 1)	Test Dates: 05/31/2021 - 07/07/2021	DUT Type: Portable Handset		Page 52 of 68



**Table 11-27
LTE Band 2 (PCS) Phablet SAR Data**

MEASUREMENT RESULTS																			
FREQUENCY		Mode	Bandwidth [MHz]	Maximum Allowed Power [dBm]	Conducted Power [dBm]	Power Drift [dB]	MPR [dB]	Serial Number	Modulation	RB Size	RB Offset	Spacing	Side	Duty Cycle	SAR (10g)	Scaling Factor	Reported SAR (10g)	Plot #	
MHz	Ch.														(W/kg)		(W/kg)		
1900.00	19100	High	LTE Band 2 (PCS)	20	25.0	24.40	-0.01	0	07828	QPSK	1	0	8 mm	back	1:1	0.716	1.148	0.822	
1900.00	19100	High	LTE Band 2 (PCS)	20	24.0	23.35	0.08	1	07828	QPSK	50	0	8 mm	back	1:1	0.513	1.161	0.596	
1860.00	18700	Low	LTE Band 2 (PCS)	20	25.0	24.07	0.08	0	07828	QPSK	1	50	0 mm	front	1:1	1.330	1.239	1.648	
1880.00	18900	Mid	LTE Band 2 (PCS)	20	25.0	24.18	0.12	0	07828	QPSK	1	0	0 mm	front	1:1	1.310	1.208	1.582	
1900.00	19100	High	LTE Band 2 (PCS)	20	25.0	24.40	0.04	0	07828	QPSK	1	0	0 mm	front	1:1	1.980	1.148	2.273	
1860.00	18700	Low	LTE Band 2 (PCS)	20	24.0	23.04	-0.12	1	07828	QPSK	50	0	0 mm	front	1:1	1.200	1.247	1.496	
1880.00	18900	Mid	LTE Band 2 (PCS)	20	24.0	23.34	-0.13	1	07828	QPSK	50	0	0 mm	front	1:1	1.070	1.164	1.245	
1900.00	19100	High	LTE Band 2 (PCS)	20	24.0	23.35	-0.06	1	07828	QPSK	50	0	0 mm	front	1:1	1.820	1.161	2.113	
1900.00	19100	High	LTE Band 2 (PCS)	20	24.0	23.30	0.04	1	07828	QPSK	100	0	0 mm	front	1:1	1.620	1.175	1.904	
1860.00	18700	Low	LTE Band 2 (PCS)	20	25.0	24.07	-0.19	0	07828	QPSK	1	50	0 mm	bottom	1:1	1.930	1.239	2.391	
1880.00	18900	Mid	LTE Band 2 (PCS)	20	25.0	24.18	-0.18	0	07828	QPSK	1	0	0 mm	bottom	1:1	1.910	1.208	2.307	
1900.00	19100	High	LTE Band 2 (PCS)	20	25.0	24.40	-0.19	0	07828	QPSK	1	0	0 mm	bottom	1:1	2.070	1.148	2.376	
1900.00	19100	High	LTE Band 2 (PCS)	20	24.0	23.35	-0.15	1	07828	QPSK	50	0	0 mm	bottom	1:1	1.600	1.161	1.858	
1900.00	19100	High	LTE Band 2 (PCS)	20	24.0	23.30	-0.12	1	07828	QPSK	100	0	0 mm	bottom	1:1	1.580	1.175	1.857	
1900.00	19100	High	LTE Band 2 (PCS)	20	25.0	24.40	-0.17	0	07828	QPSK	1	0	0 mm	right	1:1	0.371	1.148	0.426	
1900.00	19100	High	LTE Band 2 (PCS)	20	24.0	23.35	0.04	1	07828	QPSK	50	0	0 mm	right	1:1	0.348	1.161	0.404	
1860.00	18700	Low	LTE Band 2 (PCS)	20	25.0	24.07	0.00	0	07828	QPSK	1	50	0 mm	left	1:1	1.390	1.239	1.722	
1880.00	18900	Mid	LTE Band 2 (PCS)	20	25.0	24.18	0.00	0	07828	QPSK	1	0	0 mm	left	1:1	1.350	1.208	1.631	
1900.00	19100	High	LTE Band 2 (PCS)	20	25.0	24.40	-0.07	0	07828	QPSK	1	0	0 mm	left	1:1	2.250	1.148	2.583	A40
1860.00	18700	Low	LTE Band 2 (PCS)	20	24.0	23.04	-0.02	1	07828	QPSK	50	0	0 mm	left	1:1	1.120	1.247	1.397	
1880.00	18900	Mid	LTE Band 2 (PCS)	20	24.0	23.34	-0.12	1	07828	QPSK	50	0	0 mm	left	1:1	1.060	1.164	1.234	
1900.00	19100	High	LTE Band 2 (PCS)	20	24.0	23.35	-0.12	1	07828	QPSK	50	0	0 mm	left	1:1	1.770	1.161	2.055	
1900.00	19100	High	LTE Band 2 (PCS)	20	24.0	23.30	-0.08	1	07828	QPSK	100	0	0 mm	left	1:1	1.730	1.175	2.033	
1860.00	18700	Low	LTE Band 2 (PCS)	20	22.0	21.22	0.05	0	06655	QPSK	1	99	0 mm	back	1:1	1.150	1.197	1.377	
1880.00	18900	Mid	LTE Band 2 (PCS)	20	22.0	21.40	-0.01	0	06655	QPSK	1	99	0 mm	back	1:1	1.170	1.148	1.343	
1900.00	19100	High	LTE Band 2 (PCS)	20	22.0	21.83	-0.01	0	06655	QPSK	1	0	0 mm	back	1:1	2.100	1.040	2.184	
1860.00	18700	Low	LTE Band 2 (PCS)	20	22.0	21.21	-0.06	0	06655	QPSK	50	25	0 mm	back	1:1	1.180	1.199	1.415	
1880.00	18900	Mid	LTE Band 2 (PCS)	20	22.0	21.42	-0.04	0	06655	QPSK	50	25	0 mm	back	1:1	1.210	1.143	1.383	
1900.00	19100	High	LTE Band 2 (PCS)	20	22.0	21.65	-0.04	0	06655	QPSK	50	25	0 mm	back	1:1	1.900	1.084	2.060	
1900.00	19100	High	LTE Band 2 (PCS)	20	22.0	21.60	-0.04	0	06655	QPSK	100	0	0 mm	back	1:1	1.930	1.096	2.115	
ANSI / IEEE C95.1 1992 - SAFETY LIMIT Spatial Peak Uncontrolled Exposure/General Population							Phablet 4.0 W/kg (mW/g) averaged over 10 grams												

FCC ID: A3LSMA127M	 PCTEST <small>Proved to be part of the network</small>	SAR EVALUATION REPORT		Approved by: Quality Manager
Document S/N: 1M2106030063-01.A3L (Rev 1)	Test Dates: 05/31/2021 - 07/07/2021	DUT Type: Portable Handset		Page 53 of 68

**Table 11-28
LTE Band 41 Phablet SAR Data**

MEASUREMENT RESULTS																			
FREQUENCY		Mode	Bandwidth [MHz]	Maximum Allowed Power [dBm]	Conducted Power [dBm]	Power Drift [dB]	MPR [dB]	Serial Number	Modulation	RB Size	RB Offset	Spacing	Side	Duty Cycle	SAR (10g)	Scaling Factor	Reported SAR (10g)	Plot #	
MHz	Ch.														(W/kg)		(W/kg)		
2680.00	41490	High	LTE Band 41	20	23.5	23.32	0.01	0	06481	QPSK	1	0	14 mm	back	1:1.58	0.499	1.042	0.520	
2680.00	41490	High	LTE Band 41	20	22.5	22.49	0.01	1	06481	QPSK	50	0	14 mm	back	1:1.58	0.403	1.002	0.404	
2506.00	39750	Low	LTE Band 41	20	23.5	23.25	0.01	0	06481	QPSK	1	0	0 mm	front	1:1.58	0.625	1.059	0.662	
2549.50	40185	Low-Mid	LTE Band 41	20	23.5	22.78	-0.03	0	06481	QPSK	1	99	0 mm	front	1:1.58	1.090	1.180	1.286	
2593.00	40620	Mid	LTE Band 41	20	23.5	23.08	0.05	0	06481	QPSK	1	99	0 mm	front	1:1.58	1.040	1.102	1.146	
2636.50	41055	Mid-High	LTE Band 41	20	23.5	23.23	-0.03	0	06481	QPSK	1	0	0 mm	front	1:1.58	1.210	1.064	1.287	
2680.00	41490	High	LTE Band 41	20	23.5	23.32	-0.02	0	06481	QPSK	1	0	0 mm	front	1:1.58	1.500	1.042	1.563	
2680.00	41490	High	LTE Band 41	20	22.5	22.49	0.01	1	06481	QPSK	50	0	0 mm	front	1:1.58	1.210	1.002	1.212	
2680.00	41490	High	LTE Band 41	20	22.5	22.42	0.00	1	06481	QPSK	100	0	0 mm	front	1:1.58	1.230	1.019	1.253	
2680.00	41490	High	LTE Band 41	20	23.5	23.32	-0.05	0	06481	QPSK	1	0	0 mm	top	1:1.58	0.219	1.042	0.228	
2680.00	41490	High	LTE Band 41	20	22.5	22.49	-0.01	1	06481	QPSK	50	0	0 mm	top	1:1.58	0.181	1.002	0.181	
2506.00	39750	Low	LTE Band 41	20	23.5	23.25	-0.03	0	06481	QPSK	1	0	11 mm	left	1:1.58	0.466	1.059	0.493	
2549.50	40185	Low-Mid	LTE Band 41	20	23.5	22.78	-0.01	0	06481	QPSK	1	99	11mm	left	1:1.58	0.986	1.180	1.163	
2593.00	40620	Mid	LTE Band 41	20	23.5	23.08	0.04	0	06481	QPSK	1	99	11mm	left	1:1.58	1.040	1.102	1.146	
2636.50	41055	Mid-High	LTE Band 41	20	23.5	23.23	-0.07	0	06481	QPSK	1	0	11mm	left	1:1.58	1.120	1.064	1.192	
2680.00	41490	High	LTE Band 41	20	23.5	23.32	0.04	0	06481	QPSK	1	0	11mm	left	1:1.58	1.740	1.042	1.813	A41
2680.00	41490	High	LTE Band 41	20	22.5	22.49	0.01	1	06481	QPSK	50	0	11mm	left	1:1.58	1.420	1.002	1.423	
2680.00	41490	High	LTE Band 41	20	22.5	22.42	0.01	1	06481	QPSK	100	0	11mm	left	1:1.58	1.440	1.019	1.467	
2680.00	41490	High	LTE Band 41	20	17.0	16.95	0.04	0	06481	QPSK	1	0	0 mm	back	1:1.58	1.250	1.012	1.265	
2680.00	41490	High	LTE Band 41	20	17.0	16.93	0.01	0	06481	QPSK	50	0	0 mm	back	1:1.58	1.230	1.016	1.250	
2680.00	41490	High	LTE Band 41	20	17.0	16.95	-0.01	0	06481	QPSK	1	0	0 mm	left	1:1.58	1.340	1.012	1.356	
2680.00	41490	High	LTE Band 41	20	17.0	16.93	-0.02	0	06481	QPSK	50	0	0 mm	left	1:1.58	1.320	1.016	1.341	
ANSI / IEEE C95.1 1992 - SAFETY LIMIT Spatial Peak Uncontrolled Exposure/General Population										Phablet 4.0 W/kg (mW/g) averaged over 10 grams									

FCC ID: A3LSMA127M	 PCTEST <small>Proved to be part of Samsung</small>	SAR EVALUATION REPORT		Approved by: Quality Manager
Document S/N: 1M2106030063-01.A3L (Rev 1)	Test Dates: 05/31/2021 - 07/07/2021	DUT Type: Portable Handset		Page 54 of 68

11.5 SAR Test Notes

General Notes:



1. The test data reported are the worst-case SAR values according to test procedures specified in IEEE 1528-2013, and FCC KDB Publication 447498 D01v06.
2. Batteries are fully charged at the beginning of the SAR measurements.
3. Liquid tissue depth was at least 15.0 cm for all frequencies.
4. The manufacturer has confirmed that the device(s) tested have the same physical, mechanical, and thermal characteristics and are within operational tolerances expected for production units.
5. SAR results were scaled to the maximum allowed power to demonstrate compliance per FCC KDB Publication 447498 D01v06.
6. Device was tested using a fixed spacing for body-worn accessory testing. A separation distance of 15 mm was considered because the manufacturer has determined that there will be body-worn accessories available in the marketplace for users to support this separation distance.
7. Per FCC KDB Publication 648474 D04v01r03, body-worn SAR was evaluated without a headset connected to the device. Since the standalone reported body-worn SAR was ≤ 1.2 W/kg, no additional body-worn SAR evaluations using a headset cable were required.
8. Per FCC KDB 865664 D01v01r04, variability SAR tests were performed when the measured SAR results for a frequency band were greater than or equal to 0.8 W/kg. Repeated SAR measurements are highlighted in the tables above for clarity. Please see Section 13 for variability analysis.
9. During SAR Testing for the Wireless Router conditions per FCC KDB Publication 941225 D06v02r01, the actual Portable Hotspot operation (with actual simultaneous transmission of a transmitter with WIFI) was not activated (See Section 6.7 for more details).
10. Per FCC KDB Publication 648474 D04v01r03, this device is considered a "phablet" since the diagonal dimension is > 160 mm and < 200 mm. Therefore, phablet SAR tests are required when wireless router mode does not apply or if wireless router 1g SAR > 1.2 W/kg.
11. Additional SAR tests for phablet SAR were evaluated per KDB 616217 Section 6 (See Section 6.9 for more information).
12. This device utilizes power reduction for some wireless modes and technologies, as outlined in Section 1.3. The maximum output power allowed for each transmitter and exposure condition was evaluated for SAR compliance based on expected use conditions and simultaneous transmission scenarios.
13. Unless otherwise noted, when 10g SAR measurement is considered, a factor of 2.5 is applied to the thresholds below.

GSM Test Notes:

1. Body-Worn accessory testing is typically associated with voice operations. Therefore, GSM voice was evaluated for body-worn SAR.
2. Justification for reduced test configurations per KDB Publication 941225 D01v03r01 and October 2013 TCB Workshop Notes: The source-based frame-averaged output power was evaluated for all GPRS/EDGE slot configurations. The configuration with the highest target frame averaged output power was evaluated for hotspot SAR. When the maximum frame-averaged powers are equivalent across two or more slots (within 0.25 dB), the configuration with the most number of time slots was tested.
3. Per FCC KDB Publication 447498 D01v06, if the reported (scaled) SAR measured at the highest output power channel for each test configuration is ≤ 0.8 W/kg for 1g evaluations then testing at the other channels is not required for such test configuration(s).

UMTS Notes:

1. UMTS mode was tested under RMC 12.2 kbps with HSPA Inactive per KDB Publication 941225 D01v03r01. AMR and HSPA SAR was not required per the 3G Test Reduction Procedure in KDB Publication 941225 D01v03r01.
2. Per FCC KDB Publication 447498 D01v06, if the reported (scaled) SAR measured at the highest output power channel for each test configuration is ≤ 0.8 W/kg for 1g evaluations then testing at the other channels is not required for such test configuration(s).

FCC ID: A3LSMA127M	 <small>Proved to be part of Samsung</small>	SAR EVALUATION REPORT	 Approved by: Quality Manager
Document S/N: 1M2106030063-01.A3L (Rev 1)	Test Dates: 05/31/2021 - 07/07/2021	DUT Type: Portable Handset	Page 55 of 68

LTE Notes:



1. LTE test configurations are determined according to SAR Evaluation Considerations for LTE Devices in FCC KDB Publication 941225 D05v02r04. The general test procedures used for testing can be found in Section 8.5.4.
2. MPR is permanently implemented for this device by the manufacturer. The specific manufacturer target MPR is indicated alongside the SAR results. MPR is enabled for this device, according to 3GPP TS36.101 Section 6.2.3 – 6.2.5 under Table 6.2.3-1.
3. A-MPR was disabled for all SAR tests by setting NS=01 and MCC=001 on the base station simulator. SAR tests were performed with the same number of RB and RB offsets transmitting on all TTI frames (maximum TTI).
4. Per FCC KDB Publication 447498 D01v06, when the reported LTE Band 41 SAR measured at the highest output power channel in a given a test configuration was > 0.6 W/kg for 1g evaluations, testing at the other channels was required for such test configurations.
5. TDD LTE was tested per the guidance provided in FCC KDB Publication 941225 D05v02r04. Testing was performed using UL-DL configuration 0 with 6 UL subframes and 2 S subframes using extended cyclic prefix only and special subframe configuration 6. SAR tests were performed at maximum output power and worst-case transmission duty factor in extended cyclic prefix. Per 3GPP 36.211 Section 4, the duty factor for special subframe configuration 6 using extended cyclic prefix is 0.633.

WLAN Notes:

1. For held-to-ear, and hotspot, and phablet operations, the initial test position procedures were applied. The test position with the highest extrapolated peak SAR will be used as the initial test position. When reported SAR for the initial test position is ≤ 0.4 W/kg for 1g evaluations, no additional testing for the remaining test positions was required. Otherwise, SAR is evaluated at the subsequent highest peak SAR positions until the reported SAR result is ≤ 0.8 W/kg or all test positions are measured.
2. Justification for test configurations for WLAN per KDB Publication 248227 D01v02r02 for 2.4 GHz WIFI single transmission chain operations, the highest measured maximum output power channel for DSSS was selected for SAR measurement. SAR for OFDM modes (2.4 GHz 802.11g/n) was not required due to the maximum allowed powers and the highest reported DSSS SAR. See Section 8.6.3 for more information.
3. When the maximum reported 1g averaged SAR is ≤ 0.8 W/kg, SAR testing on additional channels was not required. Otherwise, SAR for the next highest output power channel was required until the reported SAR result was ≤ 1.20 W/kg for 1g evaluations or all test channels were measured.
4. The device was configured to transmit continuously at the required data rate, channel bandwidth and signal modulation, using the highest transmission duty factor supported by the test mode tools. The reported SAR was scaled to the 100% transmission duty factor to determine compliance. Procedures used to measure the duty factor are identical to that in the associated EMC test reports.

Bluetooth Notes

1. Bluetooth SAR was measured with the device connected to a call box with hopping disabled with DH5 operation and Tx Tests test mode type. Per October 2016 TCB Workshop Notes, the reported SAR was scaled to the 100% transmission duty factor to determine compliance. See Section 9.5 for the time domain plot and calculation for the duty factor of the device.
2. Head and Hotspot Bluetooth SAR were evaluated for BT BDR tethering applications.

FCC ID: A3LSMA127M	 <small>Proud to be part of the Samsung</small>	SAR EVALUATION REPORT 	Approved by: Quality Manager
Document S/N: 1M2106030063-01.A3L (Rev 1)	Test Dates: 05/31/2021 - 07/07/2021	DUT Type: Portable Handset	Page 56 of 68

12 FCC MULTI-TX AND ANTENNA SAR CONSIDERATIONS

12.1 Introduction

The following procedures adopted from FCC KDB Publication 447498 D01v06 are applicable to devices with built-in unlicensed transmitters such as 802.11 and Bluetooth devices which may simultaneously transmit with the licensed transmitter.

12.2 Simultaneous Transmission Procedures

This device contains transmitters that may operate simultaneously. Therefore, simultaneous transmission analysis is required. Per FCC KDB Publication 447498 D01v06 4.3.2 and IEEE 1528-2013 Section 6.3.4.1.2, simultaneous transmission SAR test exclusion may be applied when the sum of the 1g SAR for all the simultaneous transmitting antennas in a specific a physical test configuration is ≤ 1.6 W/kg. The different test positions in an exposure condition may be considered collectively to determine SAR test exclusion according to the sum of 1g or 10g SAR.

Per FCC KDB Publication 648474 D04 Handset SAR, Phablet SAR tests were not required if wireless router 1g SAR (scaled to the maximum output power, including tolerance) < 1.2 W/kg. Therefore, no further analysis beyond the tables included in this section was required to determine that possible simultaneous transmission scenarios would not exceed the SAR limit.

12.3 Head SAR Simultaneous Transmission Analysis

Table 12-1
Simultaneous Transmission Scenario with 2.4 GHz WLAN (Held to Ear)

Configuration	Mode	2G/3G/4G SAR (W/kg)	2.4 GHz WLAN SAR (W/kg)	Σ SAR (W/kg)
		1	2	1+2
Head SAR	GSM 850	0.233	0.168	0.401
	GSM 1900	0.122	0.168	0.290
	UMTS 850	0.283	0.168	0.451
	UMTS 1750	0.320	0.168	0.488
	UMTS 1900	0.371	0.168	0.539
	LTE Band 12	0.174	0.168	0.342
	LTE Band 26 (Cell)	0.237	0.168	0.405
	LTE Band 66 (AWS)	0.392	0.168	0.560
	LTE Band 2 (PCS)	0.274	0.168	0.442
	LTE Band 41	0.544	0.168	0.712



FCC ID: A3LSMA127M	 PCTEST Proud to be part of  Samsung	SAR EVALUATION REPORT		Approved by: Quality Manager
Document S/N: 1M2106030063-01.A3L (Rev 1)	Test Dates: 05/31/2021 - 07/07/2021	DUT Type: Portable Handset		Page 57 of 68

Table 12-2
Simultaneous Transmission Scenario with Bluetooth (Held to Ear)

Configuration	Mode	2G/3G/4G SAR (W/kg)	2.4 GHz Bluetooth SAR (W/kg)	Σ SAR (W/kg)
		1	2	
Head SAR	GSM 850	0.233	0.082	0.315
	GSM 1900	0.122	0.082	0.204
	UMTS 850	0.283	0.082	0.365
	UMTS 1750	0.320	0.082	0.402
	UMTS 1900	0.371	0.082	0.453
	LTE Band 12	0.174	0.082	0.256
	LTE Band 26 (Cell)	0.237	0.082	0.319
	LTE Band 66 (AWS)	0.392	0.082	0.474
	LTE Band 2 (PCS)	0.274	0.082	0.356
	LTE Band 41	0.544	0.082	0.626

12.4 Body-Worn Simultaneous Transmission Analysis

Table 12-3
Simultaneous Transmission Scenario with 2.4 GHz WLAN (Body-Worn at 1.5 cm)

Configuration	Mode	2G/3G/4G SAR (W/kg)	2.4 GHz WLAN SAR (W/kg)	Σ SAR (W/kg)
		1	2	
Body - Worn SAR	GSM 850	0.253	0.075	0.328
	GSM 1900	0.163	0.075	0.238
	UMTS 850	0.414	0.075	0.489
	UMTS 1750	0.521	0.075	0.596
	UMTS 1900	0.531	0.075	0.606
	LTE Band 12	0.299	0.075	0.374
	LTE Band 26 (Cell)	0.281	0.075	0.356
	LTE Band 66 (AWS)	0.453	0.075	0.528
	LTE Band 2 (PCS)	0.488	0.075	0.563
	LTE Band 41	0.877	0.075	0.952





FCC ID: A3LSMA127M	 PCTEST <small>Proud to be part of Samsung</small>	SAR EVALUATION REPORT		Approved by: Quality Manager
Document S/N: 1M2106030063-01.A3L (Rev 1)	Test Dates: 05/31/2021 - 07/07/2021	DUT Type: Portable Handset	Page 58 of 68	

Table 12-4
Simultaneous Transmission Scenario with Bluetooth (Body-Worn at 1.5 cm)

Configuration	Mode	2G/3G/4G SAR (W/kg)	2.4 GHz Bluetooth SAR (W/kg)	Σ SAR (W/kg)
		1	2	1+2
Body - Worn SAR	GSM 850	0.253	0.009	0.262
	GSM 1900	0.163	0.009	0.172
	UMTS 850	0.414	0.009	0.423
	UMTS 1750	0.521	0.009	0.530
	UMTS 1900	0.531	0.009	0.540
	LTE Band 12	0.299	0.009	0.308
	LTE Band 26 (Cell)	0.281	0.009	0.290
	LTE Band 66 (AWS)	0.453	0.009	0.462
	LTE Band 2 (PCS)	0.488	0.009	0.497
	LTE Band 41	0.877	0.009	0.886

FCC ID: A3LSMA127M	 PCTEST <small>Proud to be part of Samsung</small>	SAR EVALUATION REPORT		Approved by: Quality Manager
Document S/N: 1M2106030063-01.A3L (Rev 1)	Test Dates: 05/31/2021 - 07/07/2021	DUT Type: Portable Handset		Page 59 of 68



12.5 Hotspot SAR Simultaneous Transmission Analysis

Table 12-5
Simultaneous Transmission Scenario with 2.4 GHz WLAN (Hotspot at 1.0 cm)

Configuration	Mode	2G/3G/4G SAR (W/kg)	2.4 GHz WLAN SAR (W/kg)	Σ SAR (W/kg)
		1	2	
Hotspot SAR	GPRS 850	0.528	0.162	0.690
	GPRS 1900	0.401	0.162	0.563
	UMTS 850	0.525	0.162	0.687
	UMTS 1750	1.077	0.162	1.239
	UMTS 1900	0.917	0.162	1.079
	LTE Band 12	0.323	0.162	0.485
	LTE Band 26 (Cell)	0.465	0.162	0.627
	LTE Band 66 (AWS)	1.155	0.162	1.317
	LTE Band 2 (PCS)	1.052	0.162	1.214
	LTE Band 41	0.263	0.162	0.425



Table 12-6
Simultaneous Transmission Scenario with Bluetooth (Hotspot at 1.0 cm)

Configuration	Mode	2G/3G/4G SAR (W/kg)	2.4 GHz Bluetooth SAR (W/kg)	Σ SAR (W/kg)
		1	2	
Hotspot SAR	GPRS 850	0.528	0.016	0.544
	GPRS 1900	0.401	0.016	0.417
	UMTS 850	0.525	0.016	0.541
	UMTS 1750	1.077	0.016	1.093
	UMTS 1900	0.917	0.016	0.933
	LTE Band 12	0.323	0.016	0.339
	LTE Band 26 (Cell)	0.465	0.016	0.481
	LTE Band 66 (AWS)	1.155	0.016	1.171
	LTE Band 2 (PCS)	1.052	0.016	1.068
	LTE Band 41	0.263	0.016	0.279

FCC ID: A3LSMA127M	 PCTEST Proud to be part of Samsung	SAR EVALUATION REPORT		Approved by: Quality Manager
Document S/N: 1M2106030063-01.A3L (Rev 1)	Test Dates: 05/31/2021 - 07/07/2021	DUT Type: Portable Handset		Page 60 of 68

12.6 Simultaneous Transmission Conclusion

The above numerical summed SAR results for all the worst-case simultaneous transmission conditions were below the SAR limit. Therefore, the above analysis is sufficient to determine that simultaneous transmission cases will not exceed the SAR limit and therefore no measured volumetric simultaneous SAR summation is required per FCC KDB Publication 447498 D01v06 and IEEE 1528-2013 Section 6.3.4.1.2.

FCC ID: A3LSMA127M	 SAR EVALUATION REPORT 		Approved by: Quality Manager
Document S/N: 1M2106030063-01.A3L (Rev 1)	Test Dates: 05/31/2021 - 07/07/2021	DUT Type: Portable Handset	Page 61 of 68

13 SAR MEASUREMENT VARIABILITY

13.1 Measurement Variability

Per FCC KDB Publication 865664 D01v01r04, SAR measurement variability was assessed for each frequency band, which was determined by the SAR probe calibration point and tissue-equivalent medium used for the device measurements. When both head and body tissue-equivalent media were required for SAR measurements in a frequency band, the variability measurement procedures were applied to the tissue medium with the highest measured SAR, using the highest measured SAR configuration for that tissue-equivalent medium. These additional measurements were repeated after the completion of all measurements requiring the same head or body tissue-equivalent medium in a frequency band. The test device was returned to ambient conditions (normal room temperature) with the battery fully charged before it was re-mounted on the device holder for the repeated measurement(s) to minimize any unexpected variations in the repeated results.

SAR Measurement Variability was assessed using the following procedures for each frequency band:



- 1) When the original highest measured SAR is ≥ 0.80 W/kg, the measurement was repeated once.
- 2) A second repeated measurement was performed only if the ratio of largest to smallest SAR for the original and first repeated measurements was > 1.20 or when the original or repeated measurement was ≥ 1.45 W/kg (~ 10% from the 1g SAR limit).
- 3) A third repeated measurement was performed only if the original, first or second repeated measurement was ≥ 1.5 W/kg and the ratio of largest to smallest SAR for the original, first and second repeated measurements is > 1.20 .
- 4) Repeated measurements are not required when the original highest measured SAR is < 0.80 W/kg
- 5) When 10g SAR measurement is considered, a factor of 2.5 is applied to the thresholds above.

**Table 13-1
Body SAR Measurement Variability Results**

BODY VARIABILITY RESULTS															
Band	FREQUENCY		Mode	Service	# of Time Slots	Data Rate (Mbps)	Side	Spacing	Measured SAR (1g)	1st Repeated SAR (1g)	Ratio	2nd Repeated SAR (1g)	Ratio	3rd Repeated SAR (1g)	Ratio
	MHz	Ch.							(W/kg)	(W/kg)		(W/kg)		(W/kg)	
1750	1732.40	1412	UMTS 1750	RMC	N/A	N/A	back	10 mm	0.910	0.872	1.04	N/A	N/A	N/A	N/A
1900	1907.60	9538	UMTS 1900	RMC	N/A	N/A	back	10 mm	0.917	0.895	1.02	N/A	N/A	N/A	N/A
2600	2680.00	41490	LTE Band 41, 20 MHz Bandwidth	QPSK, 1 RB, 0 RB Offset	N/A	N/A	back	15 mm	0.842	0.837	1.01	N/A	N/A	N/A	N/A
ANSI / IEEE C95.1 1992 - SAFETY LIMIT Spatial Peak Uncontrolled Exposure/General Population								Body 1.6 W/kg (mW/g) averaged over 1 gram							



**Table 13-2
Phablet SAR Measurement Variability Results**

PHABLET VARIABILITY RESULTS													
Band	FREQUENCY		Mode	Service	Side	Spacing	Measured SAR (10g)	1st Repeated SAR (10g)	Ratio	2nd Repeated SAR (10g)	Ratio	3rd Repeated SAR (10g)	Ratio
	MHz	Ch.					(W/kg)	(W/kg)		(W/kg)		(W/kg)	
1750	1712.40	1312	UMTS 1750	RMC	back	0 mm	2.280	2.200	1.04	N/A	N/A	N/A	N/A
1900	1907.60	9538	UMTS 1900	RMC	back	0 mm	2.710	2.580	1.05	N/A	N/A	N/A	N/A
ANSI / IEEE C95.1 1992 - SAFETY LIMIT Spatial Peak Uncontrolled Exposure/General Population							Phablet 4.0 W/kg (mW/g) averaged over 10 grams						

FCC ID: A3LSMA127M	 PCTEST Proud to be part of Samsung	SAR EVALUATION REPORT		Approved by: Quality Manager
Document S/N: 1M2106030063-01.A3L (Rev 1)	Test Dates: 05/31/2021 - 07/07/2021	DUT Type: Portable Handset		Page 62 of 68

13.2 Measurement Uncertainty



The measured SAR was <1.5 W/kg for 1g and <3.75 W/kg for 10g for all frequency bands. Therefore, per KDB Publication 865664 D01v01r04, the extended measurement uncertainty analysis per IEEE 1528-2013 was not required.

FCC ID: A3LSMA127M	 SAR EVALUATION REPORT 		Approved by: Quality Manager
Document S/N: 1M2106030063-01.A3L (Rev 1)	Test Dates: 05/31/2021 - 07/07/2021	DUT Type: Portable Handset	Page 63 of 68

14 EQUIPMENT LIST

Manufacturer	Model	Description	Cal Date	Cal Interval	Cal Due	Serial Number
Agilent	8594A	(9kHz-2.9GHz) Spectrum Analyzer	N/A	N/A	N/A	3051A00187
Agilent	8753ES	Network Analyzer	2/19/2021	Annual	2/19/2022	MY40001472
Agilent	8753ES	S-Parameter Network Analyzer	9/16/2020	Annual	9/16/2021	MY40000670
Agilent	8753ES	S-Parameter Vector Network Analyzer	12/15/2020	Annual	12/15/2021	MY40003841
Agilent	E4438C	ESG Vector Signal Generator	9/18/2020	Annual	9/18/2021	MY45091346
Agilent	E4438C	ESG Vector Signal Generator	9/29/2020	Annual	9/29/2021	MY45093852
Agilent	E4440A	PSA Series Spectrum Analyzer	1/29/2021	Annual	1/29/2022	MY46186272
Agilent	E5515C	Wireless Communications Test Set	12/15/2020	Annual	12/15/2021	GB42361078
Agilent	E5515C	Wireless Communications Test Set	2/4/2021	Annual	2/4/2022	GB43193563
Agilent	N4010A	Wireless Connectivity Test Set	N/A	N/A	N/A	GB46170464
Agilent	N5182A	MXG Vector Signal Generator	9/25/2020	Annual	9/25/2021	US46240505
Agilent	N5182A	MXG Vector Signal Generator	12/1/2020	Annual	12/1/2021	MY47420837
Agilent	N9020A	MXA Signal Analyzer	12/21/2020	Annual	12/21/2021	MY50200571
Amplifier Research	150A100C	Amplifier	CBT	N/A	CBT	350132
Amplifier Research	15S1G6	Amplifier	CBT	N/A	CBT	433972
Anritsu	MA24106A	USB Power Sensor	10/14/2020	Annual	10/14/2021	1827529
Anritsu	MA24106A	USB Power Sensor	10/14/2020	Annual	10/14/2021	1827530
Anritsu	MA24106A	USB Power Sensor	10/19/2020	Annual	10/19/2021	1344545
Anritsu	MA24106A	USB Power Sensor	10/19/2020	Annual	10/19/2021	1344559
Anritsu	MA2411B	Pulse Power Sensor	7/28/2020	Annual	7/28/2021	1339018
Anritsu	MA2411B	Pulse Power Sensor	8/12/2020	Annual	8/12/2021	1207364
Anritsu	ML2495A	Power Meter	11/3/2020	Annual	11/3/2021	1039008
Anritsu	ML2495A	Power Meter	1/18/2021	Annual	1/18/2022	941001
Anritsu	MT8820C	Radio Communication Analyzer	9/17/2020	Annual	9/17/2021	6201300731
Anritsu	MT8820C	Radio Communication Analyzer	9/30/2020	Annual	9/30/2021	6201240328
Anritsu	MT8821C	Radio Communication Analyzer	2/1/2021	Annual	2/1/2022	6201664756
Anritsu	MT8821C	Radio Communication Analyzer	3/23/2021	Annual	3/23/2022	6201144418
Anritsu	MT8862A	Wireless Connectivity Test Set	10/29/2020	Annual	10/29/2021	6261782395
Control Company	4040	Therm./ Clock/ Humidity Monitor	2/23/2021	Annual	2/23/2022	160574418
Control Company	4040	Therm./ Clock/ Humidity Monitor	2/17/2020	Biennial	2/17/2022	200113269
Control Company	4352	Long Stem Thermometer	5/16/2020	Biennial	5/16/2022	200294430
Control Company	4352	Long Stem Thermometer	5/16/2020	Biennial	5/16/2022	200294416
Control Company	4352	Ultra Long Stem Thermometer	3/2/2021	Annual	3/2/2022	160508097
Keysight	772D	Dual Directional Coupler	CBT	N/A	CBT	MY52180215
Keysight Technologies	85033E	Standard Mechanical Calibration Kit (DC to 9GHz, 3.5mm)	9/1/2020	Annual	9/1/2021	MY53401181
Keysight Technologies	N6705B	DC Power Analyzer	5/5/2021	Triennial	5/5/2024	MY53004059
Keysight Technologies	U3401A	Digital Multimeter	5/14/2020	Biennial	5/14/2022	MY57201470
MCL	BW-NGW5+	6dB Attenuator	CBT	N/A	CBT	1139
MiniCircuits	SLP-2400+	Low Pass Filter	CBT	N/A	CBT	R8979500903
MiniCircuits	VLF-6000+	Low Pass Filter	CBT	N/A	CBT	N/A
Mini-Circuits	BW-N20W5	Power Attenuator	CBT	N/A	CBT	1226
Mini-Circuits	BW-N20W5+	DC to 18 GHz Precision Fixed 20 dB Attenuator	CBT	N/A	CBT	N/A
Mini-Circuits	NLP-1200+	Low Pass Filter DC to 1000 MHz	CBT	N/A	CBT	N/A
Mini-Circuits	NLP-2950+	Low Pass Filter DC to 2700 MHz	CBT	N/A	CBT	N/A
Narda	4772-3	Attenuator (3dB)	CBT	N/A	CBT	9406
Narda	BW-53W2	Attenuator (3dB)	CBT	N/A	CBT	120
Pasternack	NC-100	Torque Wrench	12/1/2020	Annual	12/1/2021	N/A
Pasternack	NC-100	Torque Wrench	8/4/2020	Biennial	8/4/2022	N/A
Pasternack	PE2208-6	Bidirectional Coupler	CBT	N/A	CBT	N/A
Pasternack	PE2209-10	Bidirectional Coupler	CBT	N/A	CBT	N/A
Rohde & Schwarz	CMW500	Radio Communication Tester	9/8/2020	Annual	9/8/2021	116743
Rohde & Schwarz	CMW500	Radio Communication Tester	10/16/2020	Annual	10/16/2021	101699
Rohde & Schwarz	CMW500	Radio Communication Tester	10/27/2020	Annual	10/27/2021	108843
Rohde & Schwarz	ZNL65	Vector Network Analyzer	9/29/2020	Annual	9/29/2021	101307
SPEAG	D1750V2	1750 MHz SAR Dipole	10/22/2018	Triennial	10/22/2021	1150
SPEAG	D1750V2	1750 MHz SAR Dipole	5/12/2020	Biennial	5/12/2022	1148
SPEAG	D1900V2	1900 MHz SAR Dipole	10/23/2018	Triennial	10/23/2021	50080
SPEAG	D1900V2	1900 MHz SAR Dipole	10/23/2018	Triennial	10/23/2021	50149
SPEAG	D2450V2	2450 MHz SAR Dipole	8/14/2020	Annual	8/14/2021	719
SPEAG	D2450V2	2450 MHz SAR Dipole	1/19/2021	Annual	1/19/2022	981
SPEAG	D2600V2	2600 MHz SAR Dipole	6/14/2019	Biennial	6/14/2022	1064
SPEAG	D2600V2	2600 MHz SAR Dipole	11/12/2019	Biennial	11/12/2021	1071
SPEAG	D750V3	750 MHz SAR Dipole	3/16/2020	Biennial	3/16/2022	1003
SPEAG	D835V2	835 MHz SAR Dipole	1/21/2021	Annual	1/21/2022	40132
SPEAG	D835V2	835 MHz SAR Dipole	3/13/2019	Triennial	3/13/2022	40047
SPEAG	DAE4	Dasy Data Acquisition Electronics	7/15/2020	Annual	7/15/2021	1322
SPEAG	DAE4	Dasy Data Acquisition Electronics	8/11/2020	Annual	8/11/2021	1450
SPEAG	DAE4	Dasy Data Acquisition Electronics	9/10/2020	Annual	9/10/2021	1449
SPEAG	DAE4	Dasy Data Acquisition Electronics	3/10/2021	Annual	3/10/2022	1415
SPEAG	DAE4	Dasy Data Acquisition Electronics	3/18/2021	Annual	3/18/2022	1272
SPEAG	DAE4	Dasy Data Acquisition Electronics	4/7/2021	Annual	4/7/2022	1407
SPEAG	DAE4	Data Acquisition Electronics	12/7/2020	Annual	12/7/2021	1533
SPEAG	DAK-3.5	Dielectric Assessment Kit	10/14/2020	Annual	10/14/2021	1091
SPEAG	EX3DV4	SAR Probe	7/20/2020	Annual	7/20/2021	7410
SPEAG	EX3DV4	SAR Probe	7/31/2020	Annual	7/31/2021	7308
SPEAG	EX3DV4	SAR Probe	4/19/2021	Annual	4/19/2022	7357
SPEAG	EX3DV4	SAR Probe	3/16/2021	Annual	3/16/2022	7526
SPEAG	EX3DV4	SAR Probe	11/23/2020	Annual	11/23/2021	7538
SPEAG	EX3DV4	SAR Probe	10/20/2020	Annual	10/20/2021	7539
SPEAG	EX3DV4	SAR Probe	12/11/2020	Annual	12/11/2021	7571



Note: CBT (Calibrated Before Testing). Prior to testing, the measurement paths containing a cable, amplifier, attenuator, coupler or filter were connected to a calibrated source (i.e. a signal generator) to determine the losses of the measurement path. The power meter offset was then adjusted to compensate for the measurement system losses. This level offset is stored within the power meter before measurements are made. This calibration verification procedure applies to the system verification and output power measurements. The calibrated reading is then taken directly from the power meter after compensation of the losses for all final power measurements.

FCC ID: A3LSMA127M	 PCTEST Proud to be part of the  network	SAR EVALUATION REPORT		Approved by: Quality Manager
Document S/N: 1M2106030063-01.A3L (Rev 1)	Test Dates: 05/31/2021 - 07/07/2021	DUT Type: Portable Handset	Page 64 of 68	

15 MEASUREMENT UNCERTAINTIES

a	b	c	d	e= f(d,k)	f	g	h = c x f/e	i = c x g/e	k	
Uncertainty Component	IEEE 1528 Sec.	Tol. (± %)	Prob. Dist.	Div.	c _i 1gm	c _i 10 gms	1gm u _i (± %)	10gms u _i (± %)	v _i	
Measurement System										
Probe Calibration	E.2.1	7	N	1	1	1	7.0	7.0	∞	
Axial Isotropy	E.2.2	0.25	N	1	0.7	0.7	0.2	0.2	∞	
Hemishperical Isotropy	E.2.2	1.3	N	1	0.7	0.7	0.9	0.9	∞	
Boundary Effect	E.2.3	2	R	1.73	1	1	1.2	1.2	∞	
Linearity	E.2.4	0.3	N	1	1	1	0.3	0.3	∞	
System Detection Limits	E.2.4	0.25	R	1.73	1	1	0.1	0.1	∞	
Modulation Response	E.2.5	4.8	R	1.73	1	1	2.8	2.8	∞	
Readout Electronics	E.2.6	0.3	N	1	1	1	0.3	0.3	∞	
Response Time	E.2.7	0.8	R	1.73	1	1	0.5	0.5	∞	
Integration Time	E.2.8	2.6	R	1.73	1	1	1.5	1.5	∞	
RF Ambient Conditions - Noise	E.6.1	3	R	1.73	1	1	1.7	1.7	∞	
RF Ambient Conditions - Reflections	E.6.1	3	R	1.73	1	1	1.7	1.7	∞	
Probe Positioner Mechanical Tolerance	E.6.2	0.8	R	1.73	1	1	0.5	0.5	∞	
Probe Positioning w/ respect to Phantom	E.6.3	6.7	R	1.73	1	1	3.9	3.9	∞	
Extrapolation, Interpolation & Integration algorithms for Max. SAR Evaluation	E.5	4	R	1.73	1	1	2.3	2.3	∞	
Test Sample Related										
Test Sample Positioning	E.4.2	3.12	N	1	1	1	3.1	3.1	35	
Device Holder Uncertainty	E.4.1	1.67	N	1	1	1	1.7	1.7	5	
Output Power Variation - SAR drift measurement	E.2.9	5	R	1.73	1	1	2.9	2.9	∞	
SAR Scaling	E.6.5	0	R	1.73	1	1	0.0	0.0	∞	
Phantom & Tissue Parameters										
Phantom Uncertainty (Shape & Thickness tolerances)	E.3.1	7.6	R	1.73	1.0	1.0	4.4	4.4	∞	
Liquid Conductivity - measurement uncertainty	E.3.3	4.3	N	1	0.78	0.71	3.3	3.0	76	
Liquid Permittivity - measurement uncertainty	E.3.3	4.2	N	1	0.23	0.26	1.0	1.1	75	
Liquid Conductivity - Temperature Uncertainty	E.3.4	3.4	R	1.73	0.78	0.71	1.5	1.4	∞	
Liquid Permittivity - Temperature Uncertainty	E.3.4	0.6	R	1.73	0.23	0.26	0.1	0.1	∞	
Liquid Conductivity - deviation from target values	E.3.2	5.0	R	1.73	0.64	0.43	1.8	1.2	∞	
Liquid Permittivity - deviation from target values	E.3.2	5.0	R	1.73	0.60	0.49	1.7	1.4	∞	
Combined Standard Uncertainty (k=1)							RSS	12.2	12.0	191
Expanded Uncertainty (95% CONFIDENCE LEVEL)							k=2	24.4	24.0	

The above measurement uncertainties are according to IEEE Std. 1528-2013



FCC ID: A3LSMA127M	 PCTEST <small>Proved to be part of Samsung</small>	SAR EVALUATION REPORT		Approved by: Quality Manager
Document S/N: 1M2106030063-01.A3L (Rev 1)	Test Dates: 05/31/2021 - 07/07/2021	DUT Type: Portable Handset		Page 65 of 68

16 CONCLUSION

16.1 Measurement Conclusion



The SAR evaluation indicates that the EUT complies with the RF radiation exposure limits of the FCC and Innovation, Science, and Economic Development Canada, with respect to all parameters subject to this test. These measurements were taken to simulate the RF effects of RF exposure under worst-case conditions. Precise laboratory measures were taken to assure repeatability of the tests. The results and statements relate only to the item(s) tested.

Please note that the absorption and distribution of electromagnetic energy in the body are very complex phenomena that depend on the mass, shape, and size of the body, the orientation of the body with respect to the field vectors, and the electrical properties of both the body and the environment. Other variables that may play a substantial role in possible biological effects are those that characterize the environment (e.g. ambient temperature, air velocity, relative humidity, and body insulation) and those that characterize the individual (e.g. age, gender, activity level, debilitation, or disease). Because various factors may interact with one another to vary the specific biological outcome of an exposure to electromagnetic fields, any protection guide should consider maximal amplification of biological effects as a result of field-body interactions, environmental conditions, and physiological variables. [3]



FCC ID: A3LSMA127M	 PCTEST <small>Proud to be part of @steris</small>	SAR EVALUATION REPORT		Approved by: Quality Manager
Document S/N: 1M2106030063-01.A3L (Rev 1)	Test Dates: 05/31/2021 - 07/07/2021	DUT Type: Portable Handset	Page 66 of 68	

17 REFERENCES

- [1] Federal Communications Commission, ET Docket 93-62, Guidelines for Evaluating the Environmental Effects of Radiofrequency Radiation, Aug. 1996.
- [2] ANSI/IEEE C95.1-2005, American National Standard safety levels with respect to human exposure to radio frequency electromagnetic fields, 3kHz to 300GHz, New York: IEEE, 2006.
- [3] ANSI/IEEE C95.1-1992, American National Standard safety levels with respect to human exposure to radio frequency electromagnetic fields, 3kHz to 300GHz, New York: IEEE, Sept. 1992.
- [4] ANSI/IEEE C95.3-2002, IEEE Recommended Practice for the Measurement of Potentially Hazardous Electromagnetic Fields - RF and Microwave, New York: IEEE, December 2002.
- [5] IEEE Standards Coordinating Committee 39 –Standards Coordinating Committee 34 – IEEE Std. 1528-2013, IEEE Recommended Practice for Determining the Peak Spatial-Average Specific Absorption Rate (SAR) in the Human Head from Wireless Communications Devices: Measurement Techniques.
- [6] NCRP, National Council on Radiation Protection and Measurements, Biological Effects and Exposure Criteria for RadioFrequency Electromagnetic Fields, NCRP Report No. 86, 1986. Reprinted Feb. 1995.
- [7] T. Schmid, O. Egger, N. Kuster, Automated E-field scanning system for dosimetric assessments, IEEE Transaction on Microwave Theory and Techniques, vol. 44, Jan. 1996, pp. 105-113.
- [8] K. Pokovic, T. Schmid, N. Kuster, Robust setup for precise calibration of E-field probes in tissue simulating liquids at mobile communications frequencies, ICECOM97, Oct. 1997, pp. 1 -124.
- [9] K. Pokovic, T. Schmid, and N. Kuster, E-field Probe with improved isotropy in brain simulating liquids, Proceedings of the ELMAR, Zadar, Croatia, June 23-25, 1996, pp. 172-175.
- [10] Schmid & Partner Engineering AG, Application Note: Data Storage and Evaluation, June 1998, p2.
- [11] V. Hombach, K. Meier, M. Burkhardt, E. Kuhn, N. Kuster, The Dependence of EM Energy Absorption upon Human Modeling at 900 MHz, IEEE Transaction on Microwave Theory and Techniques, vol. 44 no. 10, Oct. 1996, pp. 1865-1873.
- [12] N. Kuster and Q. Balzano, Energy absorption mechanism by biological bodies in the near field of dipole antennas above 300MHz, IEEE Transaction on Vehicular Technology, vol. 41, no. 1, Feb. 1992, pp. 17-23.
- [13] G. Hartsgrove, A. Kraszewski, A. Surowiec, Simulated Biological Materials for Electromagnetic Radiation Absorption Studies, University of Ottawa, Bioelectromagnetics, Canada: 1987, pp. 29-36.
- [14] Q. Balzano, O. Garay, T. Manning Jr., Electromagnetic Energy Exposure of Simulated Users of Portable Cellular Telephones, IEEE Transactions on Vehicular Technology, vol. 44, no.3, Aug. 1995.
- [15] W. Gander, Computermathematik, Birkhaeuser, Basel, 1992.
- [16] W.H. Press, S.A. Teukolsky, W.T. Vetterling, and B.P. Flannery, Numerical Recipes in C, The Art of Scientific Computing, Second edition, Cambridge University Press, 1992.
- [17] N. Kuster, R. Kastle, T. Schmid, Dosimetric evaluation of mobile communications equipment with known precision, IEEE Transaction on Communications, vol. E80-B, no. 5, May 1997, pp. 645-652.
- [18] CENELEC CLC/SC111B, European Prestandard (prENV 50166-2), Human Exposure to Electromagnetic Fields High-frequency: 10kHz-300GHz, Jan. 1995.

FCC ID: A3LSMA127M	 PCTEST <small>Prove to be part of @intertek</small>	SAR EVALUATION REPORT		Approved by: Quality Manager
Document S/N: 1M2106030063-01.A3L (Rev 1)	Test Dates: 05/31/2021 - 07/07/2021	DUT Type: Portable Handset	Page 67 of 68	

- [19] Prof. Dr. Niels Kuster, ETH, Eidgenössische Technische Hochschule Zürich, Dosimetric Evaluation of the Cellular Phone.
- [20] IEC 62209-1, Measurement procedure for the assessment of specific absorption rate of human exposure to radio frequency fields from hand-held and body-mounted wireless communication devices - Part 1: Devices used next to the ear (Frequency range of 300 MHz to 6 GHz), July 2016.
- [21] Innovation, Science, Economic Development Canada RSS-102 Radio Frequency Exposure Compliance of Radiocommunication Apparatus (All Frequency Bands) Issue 5, March 2015.
- [22] Health Canada Safety Code 6 Limits of Human Exposure to Radio Frequency Electromagnetic Fields in the Frequency Range from 3 kHz – 300 GHz, 2015
- [23] FCC SAR Test Procedures for 2G-3G Devices, Mobile Hotspot and UMPC Devices KDB Publications 941225, D01-D07
- [24] SAR Measurement Guidance for IEEE 802.11 Transmitters, KDB Publication 248227 D01
- [25] FCC SAR Considerations for Handsets with Multiple Transmitters and Antennas, KDB Publications 648474 D03-D04
- [26] FCC SAR Evaluation Considerations for Laptop, Notebook, Netbook and Tablet Computers, FCC KDB Publication 616217 D04
- [27] FCC SAR Measurement and Reporting Requirements for 100MHz – 6 GHz, KDB Publications 865664 D01-D02
- [28] FCC General RF Exposure Guidance and SAR Procedures for Dongles, KDB Publication 447498, D01-D02
- [29] Anexo à Resolução No. 533, de 10 de Setembro de 2009.
- [30] IEC 62209-2, Human exposure to radio frequency fields from hand-held and body-mounted wireless communication devices - Human models, instrumentation, and procedures - Part 2: Procedure to determine the specific absorption rate (SAR) for wireless communication devices used in close proximity to the human body (frequency range of 30 MHz to 6 GHz), Mar. 2010.

FCC ID: A3LSMA127M	 PCTEST <small>Prova to be part of @intertek</small>	SAR EVALUATION REPORT		Approved by: Quality Manager
Document S/N: 1M2106030063-01.A3L (Rev 1)	Test Dates: 05/31/2021 - 07/07/2021	DUT Type: Portable Handset	Page 68 of 68	