

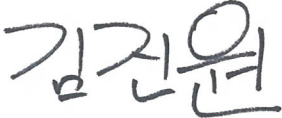



TEST REPORT

KCTL Inc. 65, Sinwon-ro, Yeongtong-gu, Suwon-si, Gyeonggi-do, 16677, Korea Tel: 82-31-285-0894 Fax: 82-505-299-8311 www.kctl.co.kr	Report No.: KR20-SEF0127 Page (1) of (22)	
1. Client		
<ul style="list-style-type: none"> ◦ Name : Samsung Electronics Co., Ltd. ◦ Address : 129, Samsung-ro, Yeongtong-gu, Suwon-si, Gyeonggi-do, 16677, Rep. of Korea ◦ Date of Receipt : 2020-07-21 		
2. Use of Report : -		
3. Name of Product / Model : Mobile phone / SC-42A, SCV49		
4. Manufacturer / Country of Origin : Samsung Electronics Co., Ltd. / VIETNAM		
5. Date of Test : 2020-08-21 to 2020-08-24		
6. Location of Test : <input checked="" type="checkbox"/> Permanent Testing Lab <input type="checkbox"/> On Site Testing (Address: -)		
7. Test method used : ANSI C63.4:2014, Class B		
8. FCC ID : A3LSMA102UJPN		
9. Test Results : Refer to the test result in the test report		
Affirmation	Tested by  Name : Jinwon Kim (Signature)	Technical Manager  Name : Gunsu Park (Signature)
2020-08-25		
KCTL Inc.		
As a test result of the sample which was submitted from the client, this report does not guarantee the whole product quality. This test report should not be used and copied without a written agreement by KCTL Inc.		

REPORT REVISION HISTORY

Date	Revision	Page No
2020-08-25	Originally issued	-

This report shall not be reproduced except in full, without the written approval of KCTL Inc. This document may be altered or revised by KCTL Inc. personnel only, and shall be noted in the revision section of the document. Any alteration of this document not carried out by KCTL Inc. will constitute fraud and shall nullify the document. This test report is a general report that does not use the KOLAS accreditation mark and is not related to KS Q ISO/IEC 17025 and KOLAS accreditation.

General remarks for test reports

Nothing significant to report.



KCTL Inc.

65, Sinwon-ro, Yeongtong-gu,
Suwon-si, Gyeonggi-do, 16677, Korea
Tel: 82-31-285-0894 Fax: 82-505-299-8311
www.kctl.co.kr

Report No.:
KR20-SEF0127
Page (3) of (22)



Contents

1. Applicant information	4
2. Laboratory information	5
3. Test system configuration	6
3.1 Operation environment	6
3.2 Measurement Uncertainty	7
4. Description of EUT	9
4.1 General information	9
4.2 Product description	10
4.3 Auxiliary equipments	11
4.4 Test configuration	12
4.5 Operating conditions	13
5. Summary of test results	14
5.1 Summary of EMI emission test results	14
6. Test results	15
6.1 Conducted Emissions	15
6.2 Radiated Emission	18

KCTL Inc.

65, Sinwon-ro, Yeongtong-gu,
Suwon-si, Gyeonggi-do, 16677, Korea
Tel: 82-31-285-0894 Fax: 82-505-299-8311
www.kctl.co.kr

Report No.:
KR20-SEF0127
Page (4) of (22)



1. Applicant information

Applicant: Samsung Electronics Co., Ltd.
Address: 129, Samsung-ro, Yeongtong-gu, Suwon-si, Gyeonggi-do,
16677, Rep. of Korea
E-mail: hojun7.choi@samsung.com
Contact name: Hojun Choi

Manufacturer: Samsung Electronics Co., Ltd.
Address: 129, Samsung-ro, Yeongtong-gu, Suwon-si, Gyeonggi-do,
16677, Rep. of Korea
E-mail: hojun7.choi@samsung.com
Contact name: Hojun Choi

Factory: Samsung Electronics Vietnam Co., Ltd. (SEV)
Address: Yen Phong Industrial Zone 1, Yen Trung, Yen Phong,
Bac Ninh, Viet Nam

KCTL Inc.

65, Sinwon-ro, Yeongtong-gu,
Suwon-si, Gyeonggi-do, 16677, Korea
Tel: 82-31-285-0894 Fax: 82-505-299-8311
www.kctl.co.kr

Report No.:
KR20-SEF0127
Page (5) of (22)

KCTL

2. Laboratory information

Address

KCTL Inc. (Suwon Lab.)

65, Sinwon-ro, Yeongtong-gu, Suwon-si, Gyeonggi-do, 16677, Korea

Telephone Number: 82 31 285 0894

Facsimile Number: 82 505 299 8311

FCC Site Designation No: KR0040

VCCI Registration No.: R-20080, G-20078, C-20059, T-20056

Industry Canada Registration No. : 8035A

KOLAS NO.: KT231

SITE MAP

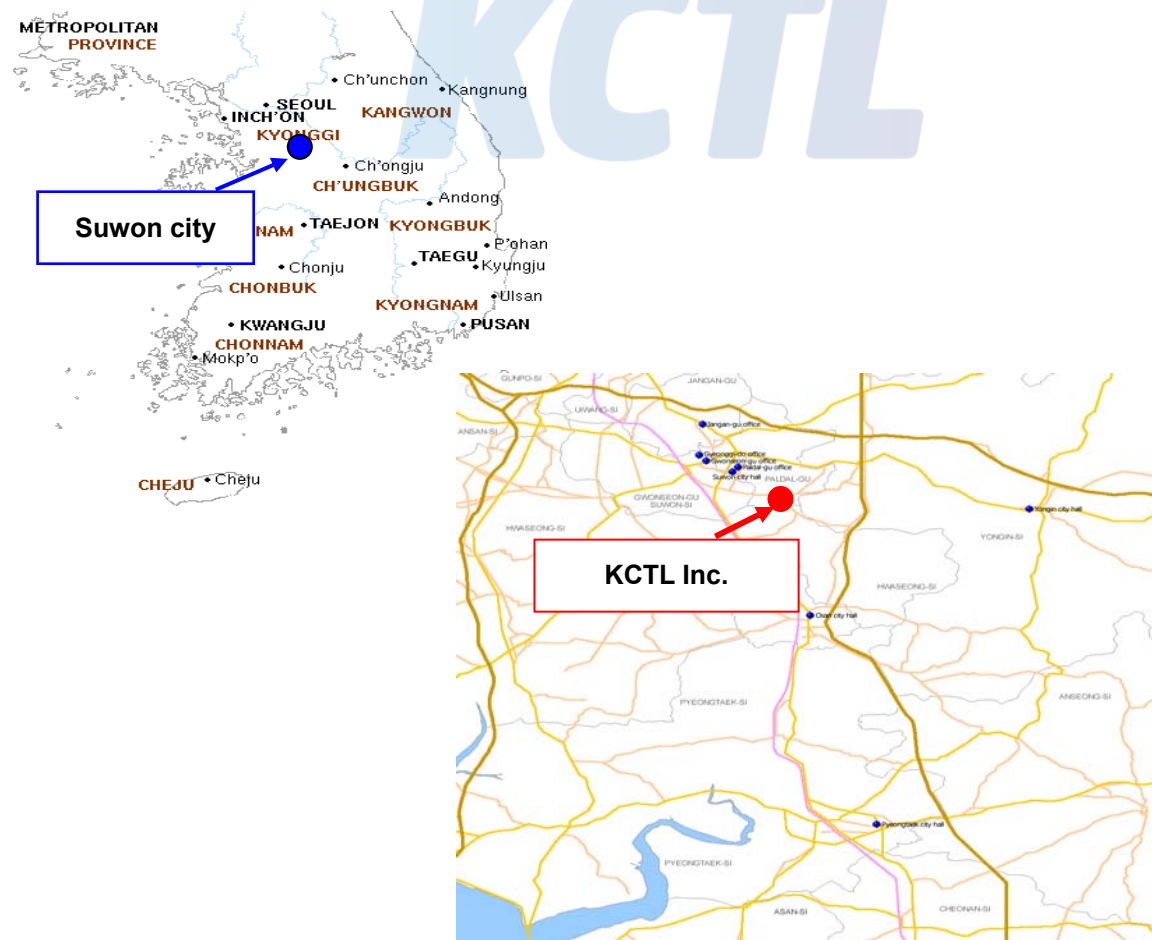

3. Test system configuration

3.1 Operation environment

	Temperature	Humidity	Pressure
Chamber 10 m (RE)	23.5 °C / 22.6 °C	38.7 % R.H. / 36.9 % R.H.	-
Shielded room(CE)	22.6 °C	39.1 % R.H.	-

Test site

These testing items were performed following locations;

Test item	Test site
Conducted Emission	Shielded Room
Radiated Emission	10 m Chamber

KCTL Inc.

65, Sinwon-ro, Yeongtong-gu,
Suwon-si, Gyeonggi-do, 16677, Korea
Tel: 82-31-285-0894 Fax: 82-505-299-8311
www.kctl.co.kr

Report No.:
KR20-SEF0127
Page (7) of (22)



3.2 Measurement Uncertainty

All measurements involve certain levels of uncertainties, especially in field of EMC.

The factors contributing to uncertainties are test receiver, cable loss, antenna factor calibration, Antenna directivity, antenna factor variation with height, antenna phase center variation, antenna frequency interpolation, measurement distance variation, site imperfection, mismatch, and system repeatability. Based on CISPR 16-4-2, the measurement uncertainty level with a 95 % confidence level was applied.

Conducted Emission measurement (Confidence level about 95 %, $k = 2$)		
Shielded Room (CE#1)	9 kHz ~ 150 kHz: 3.7 dB	
	150 kHz ~ 30 MHz: 3.3 dB	
Shielded Room (CE#2)	9 kHz ~ 150 kHz: 3.5 dB	
	150 kHz ~ 30 MHz: 3.1 dB	
Radiated Emission measurement (Confidence level about 95 %, $k = 2$)		
10 m Chamber (4F)	30 MHz ~ 300 MHz	3 m: 5.4 dB
		10 m: 5.3 dB
	300 MHz ~ 1 000 MHz	3 m: 5.5 dB
		10 m: 5.4 dB
	1 GHz ~ 6 GHz	3 m: 6.4 dB
	6 GHz ~ 18 GHz	3 m: 6.6 dB
	18 GHz ~ 30 GHz	3 m: 6.7 dB
30 GHz ~ 40 GHz	3 m: 6.2 dB	
10 m Chamber (2F)	30 MHz ~ 300 MHz	3 m: 5.0 dB
		10 m: 5.0 dB
	300 MHz ~ 1 000 MHz	3 m: 5.2 dB
		10 m: 5.0 dB
1 GHz ~ 6 GHz	3 m: 6.4 dB	
6 GHz ~ 18 GHz	3 m: 6.6 dB	

3.3 Measurement Program

These test items were performed by software programs;

Test item	Measurement Program		Used
Conducted Emission	EP5CE_V 5.4.0(TOYO)		☒
Radiated Emission	2F	EP5RE_V 4.6.0(TOYO)	☒
	4F	EP5RE_V 5.11.10(TOYO)	



4. Description of EUT

4.1 General information

Declared Hardware Version	REV1.0
Declared Software Version	SC42A.001
IMEI No	354300880003484/01
Operating Band(s)	GSM 850/900/1800/1900 WCDMA FDD 1/5/6/19 LTE FDD 1/3/5/12/17/18/19/26
Testing Band(s)	LTE FDD 12



KCTL Inc.

65, Sinwon-ro, Yeongtong-gu,
Suwon-si, Gyeonggi-do, 16677, Korea
Tel: 82-31-285-0894 Fax: 82-505-299-8311
www.kctl.co.kr

Report No.:
KR20-SEF0127
Page (10) of (22)



4.2 Product description

Type of product	Mobile phone
Model name (Basic)	SC-42A, SCV49
Model name (Variant)	-
Difference	-
Serial no	-
Testing voltage	120 V, 60 Hz
Input/Output rating	Adapter (EP-TA200) Input: AC 100 V - 240 V, 50/60 Hz, 0.5 A Output: DC 9.0 V, 1.67 A or DC 5.0 V, 2.0 A Serial no: R37M44S5NL1SE3
Internal clock frequency	Above 108 MHz
RF Frequency	Bluetooth(BDR/EDR/BLE)_2 402 MHz ~ 2 480 MHz 2 412 MHz ~ 2 462 MHz (802.11b/g/n_HT20) UNII-1: 5 180 MHz ~ 5 240 MHz (802.11a/n/ac_HT20/VHT20) UNII-1: 5 190 MHz ~ 5 230 MHz (802.11n/ac_HT40/VHT40) UNII-1: 5 210 MHz (802.11ac_VHT80) UNII-2A: 5 260 MHz ~ 5 320 MHz (802.11a/n/ac_HT20/VHT20) UNII-2A: 5 270 MHz ~ 5 310 MHz (802.11n/ac_HT40/VHT40) UNII-2A: 5 290 MHz (802.11ac_VHT80) UNII-2C: 5 500 MHz ~ 5 720 MHz (802.11a/n/ac_HT20/VHT20) UNII-2C: 5 510 MHz ~ 5 710 MHz (802.11n/ac_HT40/VHT40) UNII-2C: 5 530 MHz ~ 5 690 MHz (802.11ac_VHT80) UNII-3: 5 745 MHz ~ 5 825 MHz (802.11a/n/ac_HT20/VHT20) UNII-3: 5 755 MHz ~ 5 795 MHz (802.11n/ac_HT40/VHT40) UNII-3: 5 775 MHz (802.11ac_VHT80) NFC_13.56 MHz LTE Band 5_824.7 MHz ~ 848.3 MHz LTE Band 12_699.7 MHz ~ 715.3 MHz LTE Band 17_706.5 MHz ~ 713.5 MHz LTE Band 26_824.7 MHz ~ 848.3 MHz, 814.7 MHz ~ 824.0 MHz LTE Band 41_2 498.5 MHz ~ 2 687.5 MHz GSM 850_824.2 MHz ~ 848.8 MHz GSM 1900_1 850.2 MHz ~ 1 909.8 MHz WCDMA 850_826.4 MHz ~ 846.6 MHz
Note	-

KCTL Inc.

65, Sinwon-ro, Yeongtong-gu,
Suwon-si, Gyeonggi-do, 16677, Korea
Tel: 82-31-285-0894 Fax: 82-505-299-8311
www.kctl.co.kr

Report No.:
KR20-SEF0127
Page (11) of (22)



4.3 Auxiliary equipments

Type	Model / Part #	S/N	Manufacturer
Adapter (EUT)	EP-TA200	R37M44S5NL1SE3	Dongyang
Earphone (EUT)	EHS64AVFWE	-	ALMUS
Battery (EUT)	EB-BA102ABY	-	SDI
USB Cable (EUT)	EP-DR140AWE	-	KSD
USIM Card	-	-	-
Micro SD Card (64 GB)	Samsung Pro Plus MB-MD64G	-	SAMSUNG
Wide Band Radio Communication Tester	CMW500	141780	R&S
Spiral ANT	PSA-75301R/170	406827-0001	COBHAM



4.4 Test configuration

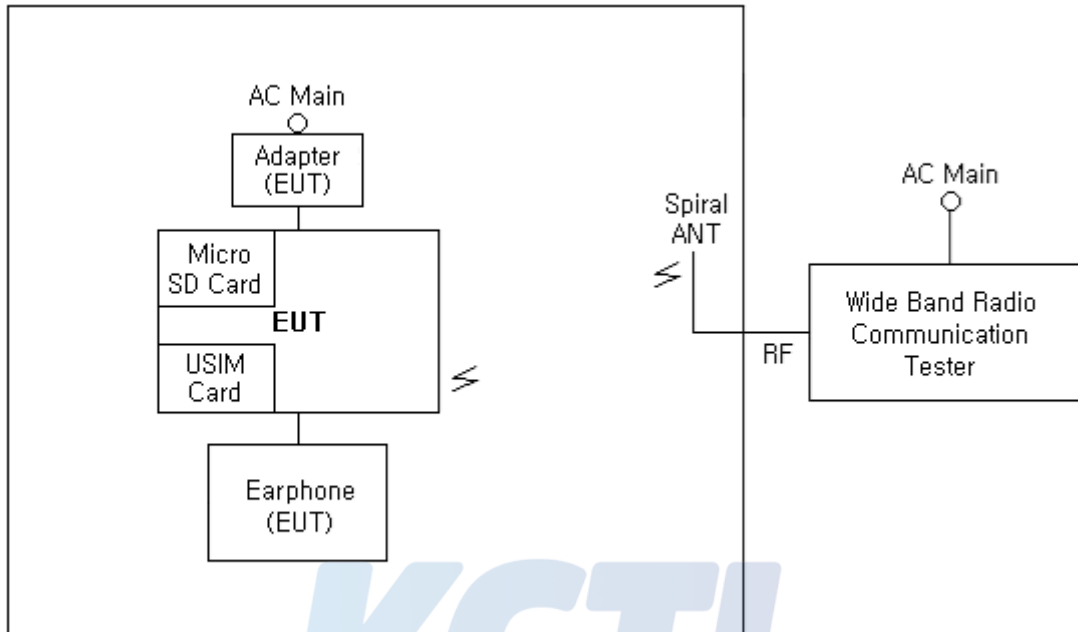

	Start		End		Cable	
	Name	I/O port	Name	I/O port	Length (m)	Spec.
1	EUT	Power(USB)	Adapter (EUT)	-	1.0	Shield
2		Earphone	Earphone(EUT)	-	1.25	Unshield
3		Micro SD	Micro SD Card	-	Direct	-
4		USIM	USIM Card	-	Direct	-
5	Adapter (EUT)	Power	AC Main	-	Direct	-
6	Wide Band Radio Communication Tester	RF	Spiral ANT	-	2.0	Shield

4.5 Operating conditions

The EUT was configured as normal intended use.

Test mode	Normal operating
Test #1	Charging (w/TA) + Cellular receiver (LTE FDD 12_Center frequency)

Note 1. All cellular RX bands operating below 1 GHz, including GSM, WCDMA and LTE have been investigated with low/mid/high channels. Among the bands, LTE FDD 12 is the worst mode.

Note 2. It means this device needs to be tested with 3 orientations (x,y and z) and at least the worst case orientation shall be set for final test.

It was determined that Z orientation was worst-case orientation. Therefore, all final radiated testing was performed with the EUT in Z orientation.



5. Summary of test results

5.1 Summary of EMI emission test results

Applied	Test items	Test method	Result
☒	Conducted Emission	FCC Part 15 Subpart B (Class B), ANSI C63.4:2014	Pass
☒	Radiated Emission	FCC Part 15 Subpart B (Class B), ANSI C63.4:2014	Pass



6. Test results

6.1 Conducted Emissions

Test specification	ANSI C63.4:2014, Class B FCC Part 15 Subpart B		
Testing voltage	120 V, 60 Hz		
Test facility	Shielded room (CE#2)		
Date	2020-08-21		
Temperature (°C)	22.6 °C	Humidity (% R.H.)	39.1 % R.H.
Remarks	Pass		

6.1.1 Limits of conducted emissions measurement

Frequency [MHz]	Class A (dB(μ V))		Class B (dB(μ V))	
	Quasi-peak	Average	Quasi-peak	Average
0.15 ~ 0.5	79	66	66 ~ 56 ¹⁾	56 ~ 46 ¹⁾
0.5 ~ 5	73	60	56	46
5 ~ 30	73	60	60	50

¹⁾ The limit decreases linearly with the logarithm of frequency

6.1.2 Measurement procedure

The measurements were performed in a shielded room. EUT was setup as shown in photograph and placed on a non-metallic table height of 0.8 m above the reference ground plane. The rear of table was located 0.4 m to the vertical conducted plane. EUT was power through the LISN, which was bonded to the ground plane. The LISN power was filtered. Each EUT power lead, except ground (safety) lead was individually connected through a LISN to input power source. EUT signal cables that hung closer than 0.4 m to the Horizontal metal ground 0.3 m ~ 0.4 m long. The power cord was bundles in the center. All peripheral equipment was powered from a sub LISN. The LISN and ISN were positioned 0.8 m from the EUT. Peak and Average detection were used in preliminary testing and Quasi-peak and Average detections were used at final measurement.

6.1.3 Used equipments

Equipment	Model no.	Serial no.	Makers	Next Cal. Date	Used
EMI TEST RECEIVER	ESCI	100710	R&S	2021.08.20	<input checked="" type="checkbox"/>
TWO-LINE V-NETWORK	ENV216	101584	R&S	2021.04.06	<input checked="" type="checkbox"/>
TWO-LINE V-NETWORK	NNLK8121	8121-472	SCHWARZBECK	2021.08.20	<input type="checkbox"/>

KCTL Inc.

65, Sinwon-ro, Yeongtong-gu,
Suwon-si, Gyeonggi-do, 16677, Korea
Tel: 82-31-285-0894 Fax: 82-505-299-8311
www.kctl.co.kr

Report No.:
KR20-SEF0127
Page (17) of (22)



6.1.4 Conducted emissions measurement result

AC Main

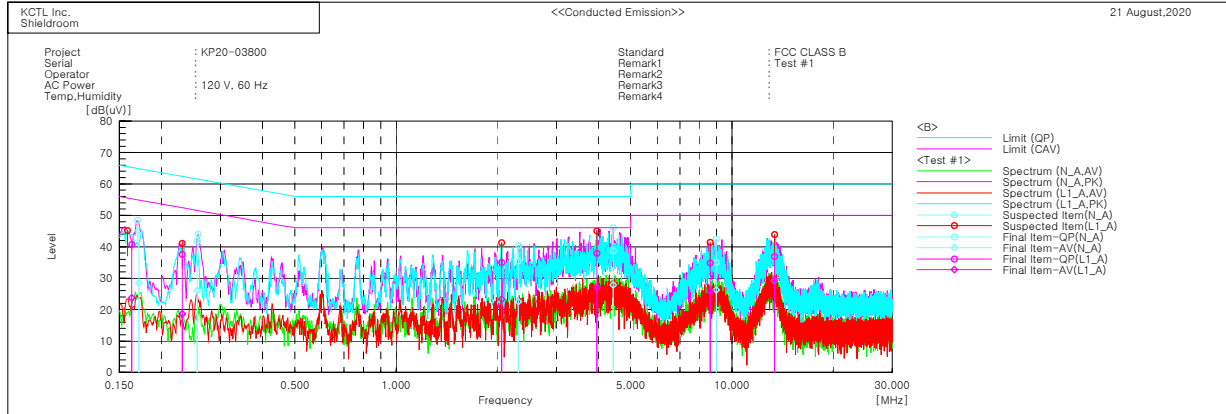

Final Result

--- N_A Phase ---

No.	Frequency [MHz]	Reading QP [dB(uV)]	Reading CAV [dB(uV)]	c. f [dB]	Result QP [dB(uV)]	Result CAV [dB(uV)]	Limit QP [dB(uV)]	Limit AV [dB(uV)]	Margin QP [dB]	Margin CAV [dB]
1	0.17167	34.8	18.2	10.3	45.1	28.5	64.9	54.9	19.8	26.4
2	0.25581	31.9	16.1	9.9	41.8	26.0	61.6	51.6	19.8	25.6
3	2.31357	25.3	12.4	10.1	35.4	22.5	56.0	46.0	20.6	23.5
4	4.43066	28.6	17.7	10.1	38.7	27.8	56.0	46.0	17.3	18.2
5	8.98267	24.6	15.9	10.3	34.9	26.2	60.0	50.0	25.1	23.8
6	13.38777	26.4	18.7	10.5	36.9	29.2	60.0	50.0	23.1	20.8

--- L1_A Phase ---

No.	Frequency [MHz]	Reading QP [dB(uV)]	Reading CAV [dB(uV)]	c. f [dB]	Result QP [dB(uV)]	Result CAV [dB(uV)]	Limit QP [dB(uV)]	Limit AV [dB(uV)]	Margin QP [dB]	Margin CAV [dB]
1	0.1634	30.6	13.6	10.1	40.7	23.7	65.3	55.3	24.6	31.6
2	0.23108	27.8	8.9	9.8	37.6	18.7	62.4	52.4	24.8	33.7
3	2.06081	25.1	13.4	9.9	35.0	23.3	56.0	46.0	21.0	22.7
4	3.95931	28.0	17.1	9.9	37.9	27.0	56.0	46.0	18.1	19.0
5	8.60977	24.8	15.8	10.1	34.9	25.9	60.0	50.0	25.1	24.1
6	13.39212	26.5	19.0	10.3	36.8	29.3	60.0	50.0	23.2	20.7

6.2 Radiated Emission

Test specification	ANSI C63.4:2014, Class B FCC Part 15 Subpart B		
Testing voltage	120 V, 60 Hz		
Test facility	10 m Chamber (4F)		
Test distance	3 m		
Date	2020-08-24		
Temperature (°C)	23.5 °C / 22.6 °C	Humidity (% R.H.)	38.7 % R.H. / 36.9 % R.H.
Remarks	Pass		

6.2.1 Limits of radiated emission measurement

Frequency [MHz]	Class A (dB(μ V/m)) @ 10 m	Class B (dB(μ V/m)) @ 3 m
30-88	39	40
88-216	43.5	43.5
216-960	46.4	46
Above 960	49.5	54

Note- Alternative standard: CISPR, Pub. 22

6.2.2 Measurement procedure

The test was done at a 10 m chamber with a quasi-peak detector. EUT was placed on a non-metallic table height of 0.8 m above the reference ground plane. Cables were folded back and forth forming a bundle 0.3 m to 0.4 m long and were hanged at a 0.4 m height to the ground plane.

Cables connected to EUT were fixed to cause maximum emission. Test was made with the antenna positioned in both the horizontal and vertical planes of polarization. The measurement antenna was varied in height above the conducting ground plane to obtain the maximum signal strength.

6.2.3 Used equipments

Equipment	Model no.	Serial no.	Makers	Next Cal. Date	Used
EMI TEST RECEIVER	ESR7	101078	R&S	2021.08.20	☒
Bilog Antenna	CBL 6112D	55545	TESEQ	2022.04.24	☒
AMPLIFIER	310N	293004	SONOMA	2021.08.20	☒
ATTENUATOR	8491B-6dB	MY39271060	KEYSIGHT	-	☒
Antenna Mast	MA4640-XP-ET	-	Innco Systems	-	☒
Turn Table	TT 3.0-3t	-	MATURO	-	☒
AMPLIFIER	JS44-18004000-33-8P	2000996	L-3Narda-MITEQ	2021.01.22	☒
Horn antenna	3116	00086635	ETS-LINDGREN	2021.05.12	☒
DOUBLE RIDGED HORN ANTENNA	3117-PA	00161083	ETS-LINDGREN	2020.09.18	☒
Spectrum Analyzer	FSV40	100988	R&S	2021.01.03	☒

6.2.4 Sample calculation

The field strength is calculated adding the antenna Factor, cable loss and, Antenna pad adding, subtracting the amplifier gain from the measured reading.

The sample calculation is as follow:

$$\text{Result} = \text{M.R} + \text{C.F}(\text{A.F} + \text{C.L} + 6 \text{ dB Att} - \text{A.G})$$

M.R = Meter Reading

C.F = Correction Factor

A.F = Antenna Factor

C.L = Cable Loss

A.G = Amplifier Gain

6 dB Att = 6 dB Attenuator

If M.R is 30 dB, A.F 12 dB, C.L 5 dB, 6 dB, A.G 35 dB

The result is $30 + 12 + 5 + 6 - 35 = 18 \text{ dB } (\mu\text{V/m})$

Bilog Antenna and ATTENUATOR (6 dB) were calibrated together.

AV = CAV : Abbreviation of CISPR Average

KCTL Inc.

65, Sinwon-ro, Yeongtong-gu,
Suwon-si, Gyeonggi-do, 16677, Korea
Tel: 82-31-285-0894 Fax: 82-505-299-8311
www.kctl.co.kr

Report No.:
KR20-SEF0127
Page (20) of (22)



6.2.5 Radiated emission measurement result 30 MHz ~ 1 GHz

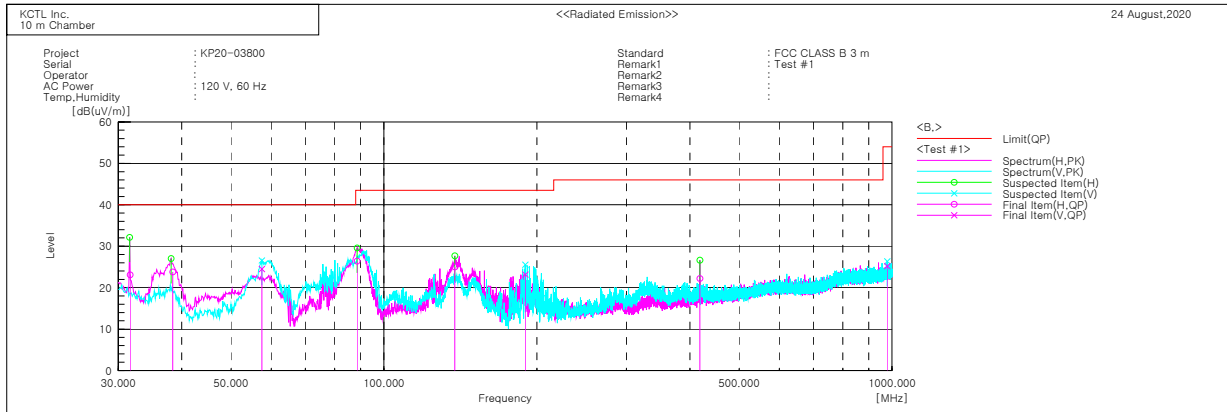

Final Result

No.	Frequency [MHz]	(P)	Reading QP [dB(uV)]	c.f [dB(1/m)]	Result QP [dB(uV/m)]	Limit QP [dB(uV/m)]	Margin QP [dB]	Height [cm]	Angle [deg]
1	31.668	H	29.2	-6.1	23.1	40.0	16.9	316.0	83.0
2	38.412	H	33.7	-9.9	23.8	40.0	16.2	109.0	214.0
3	57.524	V	41.2	-16.7	24.5	40.0	15.5	388.0	304.0
4	88.564	H	40.2	-13.8	26.4	43.5	17.1	196.0	24.0
5	137.913	H	35.2	-10.2	25.0	43.5	18.5	103.0	358.0
6	189.808	V	34.9	-11.7	23.2	43.5	20.3	289.0	261.0
7	418.728	H	25.3	-3.1	22.2	46.0	23.8	104.0	334.0
8	979.024	V	19.0	6.2	25.2	54.0	28.8	302.0	329.0

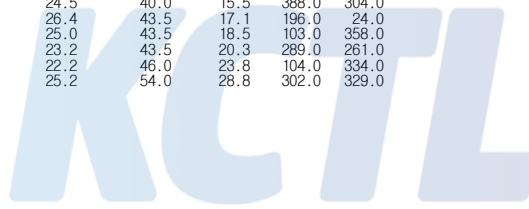

KCTL Inc.

65, Sinwon-ro, Yeongtong-gu,
Suwon-si, Gyeonggi-do, 16677, Korea
Tel: 82-31-285-0894 Fax: 82-505-299-8311
www.kctl.co.kr

Report No.:
KR20-SEF0127
Page (21) of (22)



1 GHz ~ 18 GHz

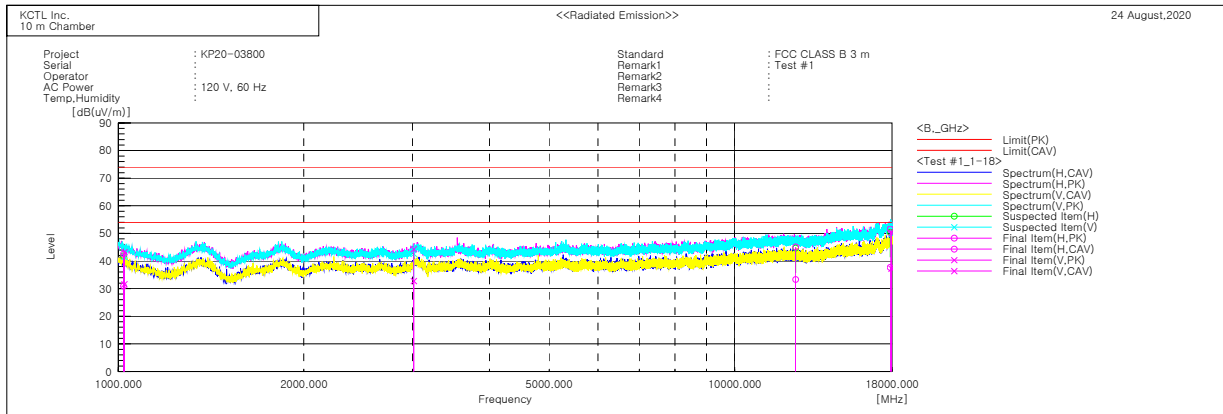

Final Result

No.	Frequency [MHz]	(P)	Reading PK [dB(uV)]	Reading CAV [dB(uV)]	c.f [dB(1/m)]	Result PK [dB(uV/m)]	Result CAV [dB(uV/m)]	Limit PK [dB(uV/m)]	Limit AV [dB(uV/m)]	Margin PK [dB]	Margin CAV [dB]	Height [cm]	Angle [deg]
1	1019.551	H	58.7	47.1	-16.2	42.5	30.9	74.0	54.0	31.5	23.1	304.0	343.0
2	1022.951	V	59.4	47.8	-16.2	43.2	31.6	74.0	54.0	30.8	22.4	400.0	339.0
3	3015.451	V	53.5	42.0	-9.2	44.3	32.8	74.0	54.0	29.7	21.2	115.0	327.0
4	12554.630	H	44.1	32.3	1.0	45.1	33.3	74.0	54.0	28.9	20.7	280.0	278.0
5	17872.490	H	42.5	28.6	9.1	51.6	37.7	74.0	54.0	22.4	16.3	116.0	58.0
6	17968.550	V	40.7	27.7	9.5	50.2	37.2	74.0	54.0	23.8	16.8	241.0	134.0



KCTL Inc.

65, Sinwon-ro, Yeongtong-gu,
Suwon-si, Gyeonggi-do, 16677, Korea
Tel: 82-31-285-0894 Fax: 82-505-299-8311
www.kctl.co.kr

Report No.:
KR20-SEF0127
Page (22) of (22)



18 GHz ~ 30 GHz

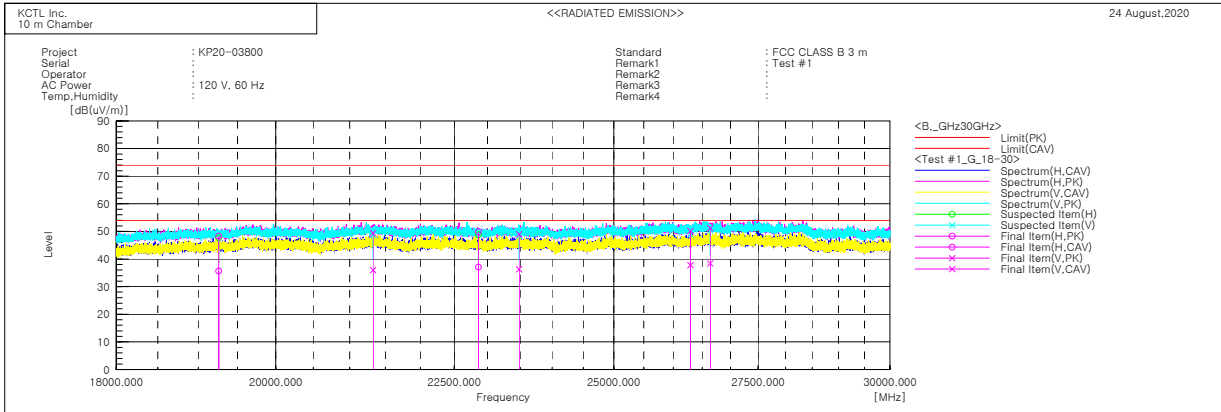

Final Result

No.	Frequency [MHz]	(P)	Reading PK [dB(uV)]	Reading CAV [dB(uV)]	c.f [dB(1/m)]	Result PK [dB(uV/m)]	Result CAV [dB(uV/m)]	Limit PK [dB(uV/m)]	Limit AV [dB(uV/m)]	Margin PK [dB]	Margin CAV [dB]	Height [cm]	Angle [deg]
1	19258.860	H	46.7	34.1	1.6	48.3	35.7	74.0	54.0	25.7	18.3	109.0	260.0
2	21325.970	V	46.1	32.7	3.3	49.4	36.0	74.0	54.0	24.6	18.0	301.0	344.0
3	22862.040	H	46.7	33.9	3.2	49.9	37.1	74.0	54.0	24.1	16.9	197.0	58.0
4	23482.470	V	45.1	32.4	3.9	49.0	36.3	74.0	54.0	25.0	17.7	105.0	206.0
5	26296.020	V	42.8	30.5	7.3	50.1	37.8	74.0	54.0	23.9	16.2	397.0	16.0
6	26642.230	V	43.3	30.5	7.9	51.2	38.4	74.0	54.0	22.8	15.6	117.0	194.0

