



TEST REPORT

<p>KCTL KCTL Inc. 65, Sinwon-ro, Yeongtong-gu, Suwon-si, Gyeonggi-do, 16677, Korea TEL: 82-31-285-0894 FAX: 82-505-299-8311 www.kctl.co.kr</p>	<p>Report No.: KR20-SRF0222 Page (1) of (18)</p>	
---	--	--

1. Client

- Name : Samsung Electronics Co., Ltd.
- Address : 129, Samsung-ro, Yeongtong-gu, Suwon-si, Gyeonggi-do, 16677, Rep. of Korea
- Date of Receipt : 2020-07-21

2. Use of Report : Certification

3. Name of Product / Model : Mobile phone / SC-42A, SCV49

4. Manufacturer / Country of Origin : Samsung Electronics Co., Ltd. / Vietnam

5. FCC ID : A3LSMA102UJPN

6. Date of Test : 2020-07-23 to 2020-08-18

7. Location of Test : Permanent Testing Lab On Site Testing (Address: Address of testing location)

8. Test method used : FCC Part 15 Subpart C, 15.407

9. Test Result : Refer to the test result in the test report

<p>Affirmation</p>	<p>Tested by Name : Myeongjun Kwon (Signature)</p>	<p>Technical Manager Name : Seungyong Kim (Signature)</p>
--------------------	--	---

2020-08-28

KCTL Inc.

As a test result of the sample which was submitted from the client, this report does not guarantee the whole product quality. This test report should not be used and copied without a written agreement by KCTL Inc.

REPORT REVISION HISTORY

Date	Revision	Page No
2020-08-28	Originally issued	-

This report shall not be reproduced except in full, without the written approval of KCTL Inc. This document may be altered or revised by KCTL Inc. personnel only, and shall be noted in the revision section of the document. Any alteration of this document not carried out by KCTL Inc. will constitute fraud and shall nullify the document. This test report is a general report that does not use the KOLAS accreditation mark and is not related to KS Q ISO/IEC 17025 and KOLAS accreditation.

General remarks for test reports

Nothing significant to report.



CONTENTS

1. General information	4
2. Device information	4
2.1. Accessory information	6
2.2. Frequency/channel operations.....	7
3. Summary of tests	8
4 Test results	9
4.1. DFS (Dynamic Frequency Selection).....	9
5. Measurement equipment	18



1. General information

Client : Samsung Electronics Co., Ltd.
Address : 129, Samsung-ro, Yeongtong-gu, Suwon-si, Gyeonggi-do, 16677,
Rep. of Korea
Manufacturer : Samsung Electronics Co., Ltd.
Address : 129, Samsung-ro, Yeongtong-gu, Suwon-si, Gyeonggi-do, 16677,
Rep. of Korea
Factory : Samsung Electronics Vietnam Co., Ltd. (SEV)
Address : Yen Phong Industrial Zone 1, Yen Trung, Yen Phong, Bac Ninh, Viet Nam
Laboratory : KCTL Inc.
Address : 65, Sinwon-ro, Yeongtong-gu, Suwon-si, Gyeonggi-do, 16677, Korea
Accreditations : FCC Site Designation No: KR0040, FCC Site Registration No: 687132
VCCI Registration No. : R-20080, G-20078, C-20059, T-20056
Industry Canada Registration No. : 8035A
KOLAS No.: KT231

2. Device information

Equipment under test : Mobile phone
Model : SC-42A, SCV49
Difference in : Model SCV49 is electrically identical to model SC-42A. Two model
Model name : numbers are allocated for marketing and logistic purposes only.
Modulation technique : Bluetooth(BDR/EDR)_GFSK, $\pi/4$ DQPSK, 8DPSK
Bluetooth(BLE)_GFSK
WIFI(802.11a/b/g/n/ac)_DSSS, OFDM
NFC_ASK
LTE_QPSK, 16QAM
WCDMA_QPSK
GSM_GMSK, 8-PSK
Number of channels : Bluetooth(BDR/EDR)_79 ch / Bluetooth(BLE)_40 ch
802.11b/g/n_HT20 : 11 ch
UNII-1: 4 ch (20 MHz), 2 ch (40 MHz), 1 ch (80 MHz)
UNII-2A: 4 ch (20 MHz), 2 ch (40 MHz), 1 ch (80 MHz)
UNII-2C: 12 ch (20 MHz), 6 ch (40 MHz), 3 ch (80 MHz)
UNII-3: 5 ch (20 MHz), 2 ch (40 MHz), 1 ch (80 MHz)
Power source : DC 3.86 V
Antenna specification : LTE/WCDMA_LDS+SUS Insert Antenna
WIFI/Bluetooth(BDR/EDR/BLE)_LDS Antenna
NFC_FPCB Antenna

Antenna gain	: WIFI/Bluetooth(BDR/EDR/BLE) : -0.9 dBi UNII-1 : -1.8 dBi, UNII-2A : -1.7 dBi UNII-2C : -1.8 dBi UNII-3 : -3.1 dBi
Frequency range	: Bluetooth(BDR/EDR/BLE)_2 402 MHz ~ 2 480 MHz 2 412 MHz ~ 2 462 MHz (802.11b/g/n_HT20) UNII-1: 5 180 MHz ~ 5 240 MHz (802.11a/n/ac_HT20/VHT20) UNII-1: 5 190 MHz ~ 5 230 MHz (802.11n/ac_HT40/VHT40) UNII-1: 5 210 MHz (802.11ac_VHT80) UNII-2A: 5 260 MHz ~ 5 320 MHz (802.11a/n/ac_HT20/VHT20) UNII-2A: 5 270 MHz ~ 5 310 MHz (802.11n/ac_HT40/VHT40) UNII-2A: 5 290 MHz (802.11ac_VHT80) UNII-2C: 5 500 MHz ~ 5 720 MHz (802.11a/n/ac_HT20/VHT20) UNII-2C: 5 510 MHz ~ 5 710 MHz (802.11n/ac_HT40/VHT40) UNII-2C: 5 530 MHz ~ 5 690 MHz (802.11ac_VHT80) UNII-3: 5 745 MHz ~ 5 825 MHz (802.11a/n/ac_HT20/VHT20) UNII-3: 5 755 MHz ~ 5 795 MHz (802.11n/ac_HT40/VHT40) UNII-3: 5 775 MHz (802.11ac_VHT80) NFC_13.56 MHz LTE Band 5_824.7 MHz ~ 848.3 MHz LTE Band 12_699.7 MHz ~ 715.3 MHz LTE Band 17_706.5 MHz ~ 713.5 MHz LTE Band 26_824.7 MHz ~ 848.3 MHz, 814.7 MHz ~ 824.0 MHz LTE Band 41_2 498.5 MHz ~ 2 687.5 MHz GSM 850_824.2 MHz ~ 848.8 MHz GSM 1900_1 850.2 MHz ~ 1 909.8 MHz WCDMA 850_826.4 MHz ~ 846.6 MHz
Software version	: SC42A.001
Hardware version	: REV1.0
Test device serial No.	: Conducted(R38N50519PM) Radiated(3200cc5953f116c3, 3200cc3b5349161d)
Operation temperature	: -30 °C ~ 50 °C

2.1. Accessory information

Equipment	Manufacturer	Model	Serial No.	Power source	Note.
Travel Adapter	Samsung Electronics Co., Ltd.	EP-TA200	R37N47E1AR1SE3	INPUT : 100-240V, 50-60Hz 0.5A Output : 9V/1.67A, 5V/2A	-

KCTL

2.2. Frequency/channel operations

This device contains the following capabilities:

WIFI(802.11a/b/g/n/ac), Bluetooth(BDR/EDR/BLE), NFC,
LTE Band 5, LTE Band 12, LTE Band 17, LTE Band 26, LTE Band 41, GSM 850, GSM 1900,
WCDMA 850

UNII-2A

Ch.	Frequency (MHz)
52	5 260
56	5 280
64	5 320

UNII-2C

Ch.	Frequency (MHz)
100	5 500
120	5 600
140	5 700
144	5 720

Table 2.2-1. 802.11a/n/ac_HT20/VHT20 mode

UNII-2A

Ch.	Frequency (MHz)
54	5 270
62	5 310

UNII-2C

Ch.	Frequency (MHz)
102	5 510
118	5 590
134	5 670
142	5 710

Table 2.2-2. 802.11n/ac_HT40/VHT40 mode

UNII-2A

Ch.	Frequency (MHz)
58	5 290

UNII-2C

Ch.	Frequency (MHz)
106	5 530
122	5 610
138	5 690

Table 2.2-3 802.11ac_VHT80 mode

Notes:

1. The device supports DFS bands between UNII-2A and UNII-2C and operates as a slave device controlled by master.

3. Summary of tests

FCC Part section(s)	Parameter	Test Limit	Test Condition	Test results
15.407(h)	DFS -Channel closing transmission time -Channel move time -Non occupied period	N/A	Conducted	Pass

Notes:

- The test procedure(s) in this report were performed in accordance as following.
 - ◆ KDB 905462 D02 UNII DFS compliance procedure new rules .
 - ◆ KDB 905462 D03 UNII client without radar detection new rules.
- The device does not support radar detection feature.

KCTL

4 Test results**4.1. DFS (Dynamic Frequency Selection)****Test description****- Applicability of DFS requirements prior to use of a channel**

Requirement	Operational Mode		
	Master	Client (without radar detection)	Client (with radar detection)
Non-Occupancy Period	Yes	Not required	Yes
DFS Detection Threshold	Yes	Not required	Yes
Channel Availability Check Time	Yes	Not required	Not required
U-NII Detection Bandwidth	Yes	Not required	Yes

- Applicability of DFS requirements during normal operation

Requirement	Operational Mode	
	Master Device or Client with Radar Detection	Client Without Radar Detection
DFS Detection Threshold	Yes	Not required
Channel Closing Transmission Time	Yes	<u>Yes</u>
Channel Move Time	Yes	<u>Yes</u>
Bandwidth	Yes	Not required

Additional requirements for devices with multiple bandwidth modes	Master Device or Client with Radar Detection	Client Without Radar Detection
U-NII Detection Bandwidth and Statistical Performance Check	All BW modes must be tested	Not required
Channel Move Time and Channel Closing Transmission Time	Test using widest BW mode available	<u>Test using the widest BW mode available for the link</u>
All other tests	Any single BW mode	Not required

Note: Frequencies selected for statistical performance check (Section 7.8.4) should include several frequencies within the radar detection bandwidth and frequencies near the edge of the radar detection bandwidth. For 802.11 devices it is suggested to select frequencies in each of the bonded 20 MHz channels and the channel center frequency.

- Requirements of client devices

- a) A Client Device will not transmit before having received appropriate control signals from a Master Device.
- b) A Client Device will stop all its transmissions whenever instructed by a Master Device to which it is associated and will meet the Channel Move Time and Channel Closing Transmission Time requirements. The Client Device will not resume any transmissions until it has again received control signals from a Master Device.
- c) If a Client Device is performing In-Service Monitoring and detects a Radar Waveform above the DFS Detection Threshold, it will inform the Master Device. This is equivalent to the Master Device detecting the Radar Waveform and d) through f) of section 5.1.1 apply.
- d) Irrespective of Client Device or Master Device detection the Channel Move Time and Channel Closing Transmission Time requirements remain the same.
- e) The client test frequency must be monitored to ensure no transmission of any type has occurred for 30 minutes. Note: If the client moves with the master, the device is considered compliant if nothing appears in the client non-occupancy

- DFS Response requirement values

Parameter	Value
Non-occupancy period	Minimum 30 minutes
Channel Availability Check Time	60 seconds
Channel Move Time	10 seconds See Note 1.
Channel Closing Transmission Time	200 milliseconds + an aggregate of 60 milliseconds over remaining 10 second period. See Notes 1 and 2.
<p>Note 1: Channel Move Time and the Channel Closing Transmission Time should be performed with Radar Type 0. The measurement timing begins at the end of the Radar Type 0 burst.</p> <p>Note 2: The Channel Closing Transmission Time is comprised of 200 milliseconds starting at the beginning of the Channel Move Time plus any additional intermittent control signals required to facilitate a Channel move (an aggregate of 60 milliseconds) during the remainder of the 10 second period. The aggregate duration of control signals will not count quiet periods in between transmissions.</p>	

- Interference Threshold values, Master or Client incorporating In-Service Monitoring

Maximum Transmit Power	Value (see note)
≥ 200 milliwatt	-64 dBm
< 200 milliwatt power spectral density < 10 dBm/MHz	-62 dBm
EIRP < 200 milliwatt that do not meet the power spectral density requirement	-64 dBm

Note 1: This is the level at the input of the receiver assuming a 0 dBi receive antenna

Note 2: Throughout these test procedures an additional 1 dB has been added to the amplitude of the test transmission waveforms to account for variations in measurement equipment. This will ensure that the test signal is at or above the detection threshold level to trigger a DFS response.

Note3: EIRP is based on the highest antenna gain. For MIMO devices refer to KDB Publication 662911 D01.

- Radar test waveforms

Type	Pulse Width (μ sec)	PRI (μ sec)	Number of Pulses	Minimum Percentage of Successful Detection	Minimum Number of Trials
0	1	1428	18	See Note 1	See Note 1
1	1	Test A: 15 unique PRI values randomly selected from the list of 23 PRI values in Table 5a	$\text{Roundup}\left\{\left(\frac{1}{360}\right) \cdot \left(\frac{19 \cdot 10^6}{PRI_{\mu\text{sec}}}\right)\right\}$	60%	30
		Test B: 15 unique PRI values randomly selected within the range of 518-3066 μ sec, with a minimum increment of 1 μ sec, excluding PRI values selected in Test A			
2	1-5	150-230	23-29	60%	30
3	6-10	200-500	16-18	60%	30
4	11-20	200-500	12-16	60%	30
Aggregate (Radar Types 1-4)				80%	120

Note 1: Short Pulse Radar Type 0 should be used for the detection bandwidth test, channel move time, and channel closing time tests.

Note 2: This report was applied Short Pulse Radar Type 0.

*Short Pulse Radar Test Waveforms

Radar Type	Pulse Width (μ s)	Chirp Width (MHz)	PRI (μ s)	Number of Pulses per Burst	Number of Bursts	Minimum percentage of Successful Detection	Minimum Number of Trials
5	50-100	5-20	1000-2000	1-3	8-20	80%	30

*Long Pulse Radar Test Waveform

Radar Waveform	Pulse Width (μ sec)	PRI (μ sec)	Pulses per Hop	Hopping Rate (kHz)	Hopping Sequence Length (μ s)	Minimum Percentage of Successful Detection	Minimum Trials
6	1	333	9	0.333	300	70%	30

*Frequency Hopping Radar Test Waveform

KCTL

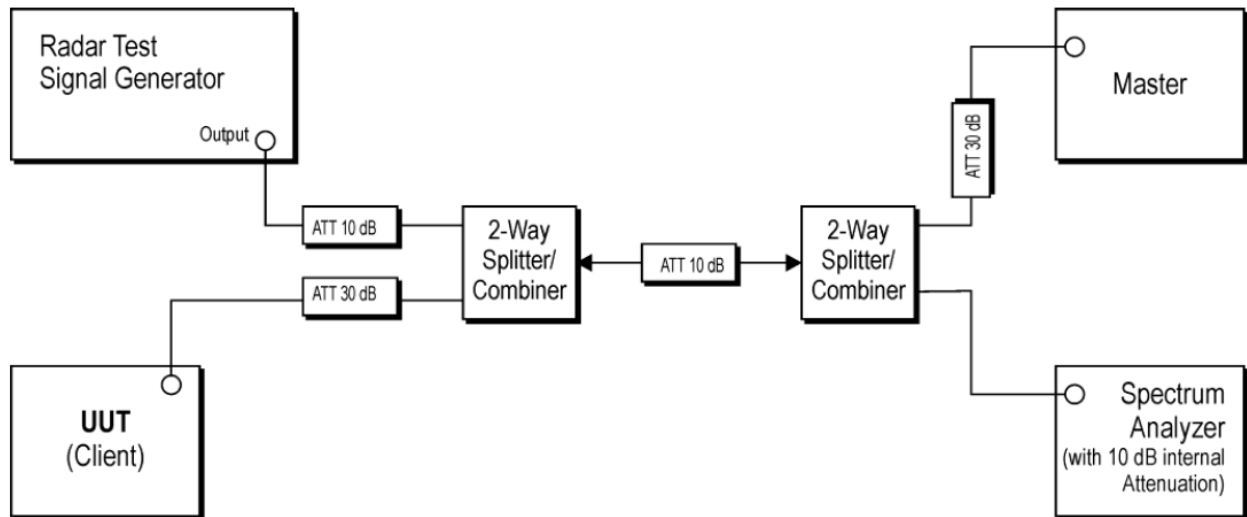
Test setup**- Setup for Client with injection at the Master****- Spectrum analyzer setting parameter**

This setting parameter is shown below and it according to the 905462 D02 UNII DFS Compliance Procedures New Rules.

- 1) RBW/VBW ≥ 3 MHz
- 2) Detector = peak
- 3) Span = zero span

- Conducted test procedure

- 1) One frequency will be chosen from the Operating Channels of the UUT within the 5 250-5 350 MHz or 5 470-5 725 MHz bands.
- 2) The Client Device (EUT) is set up the above diagram and communications between the Master device and the Client is established.
- 3) Stream the channel loading test file from the Master Device to the Client Device on the test Channel for the entire period of the test.
- 4) An additional 1 dB is added to the radar test signal to ensure it is at or above the DFS Detection Threshold, accounting for equipment variations/errors.
- 5) Observe the transmissions of the UUT at the end of the Burst on the Operating Channel for duration greater than 12 seconds for Radar Type 0 to ensure detection occurs.
- 6) After the initial radar burst the channel is monitored for 30 minutes to ensure no transmissions or beacons occur. A second monitoring setup is used to verify that the Master and Client have both moved to different channels.

- Master device information

Equipment Name	Manufacturer	Model No.	Serial No.	FCC ID
Access Point	ASUSTeK Computer Inc	RT-AX88U	J9IAHP000993	MSQ-RTAXHP00

Test result

Plot of radar waveform

5 290 MHz

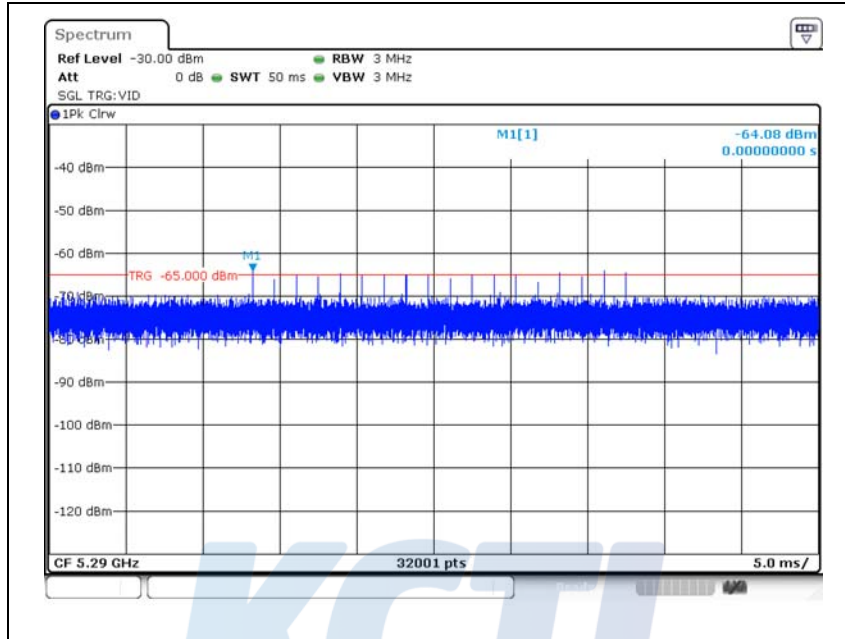

5 530 MHz

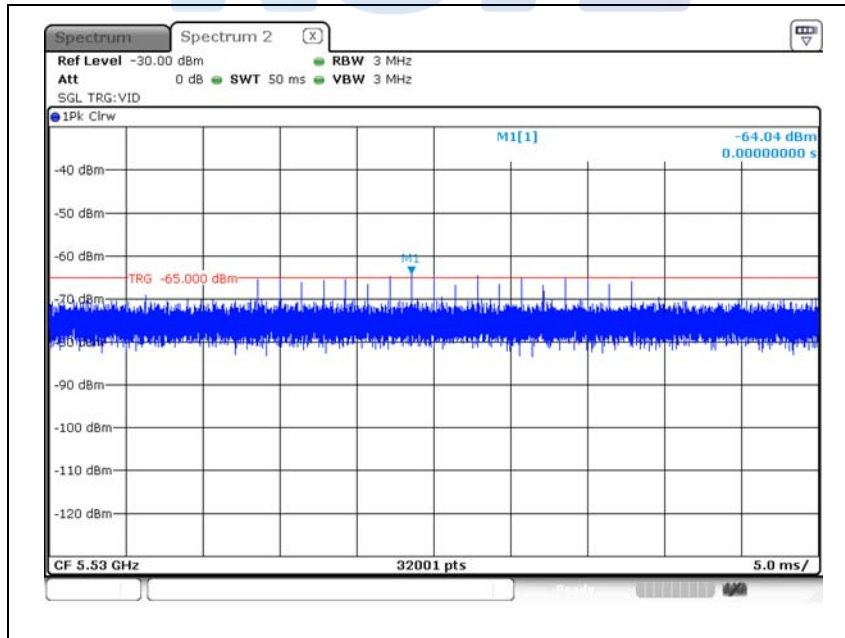

Plot of LAN traffic

5 290 MHz

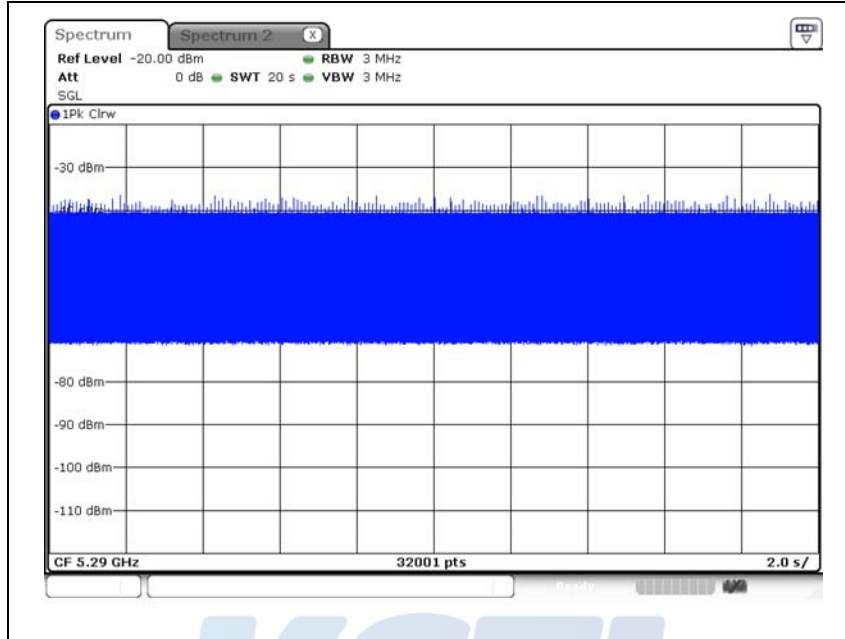

5 530 MHz

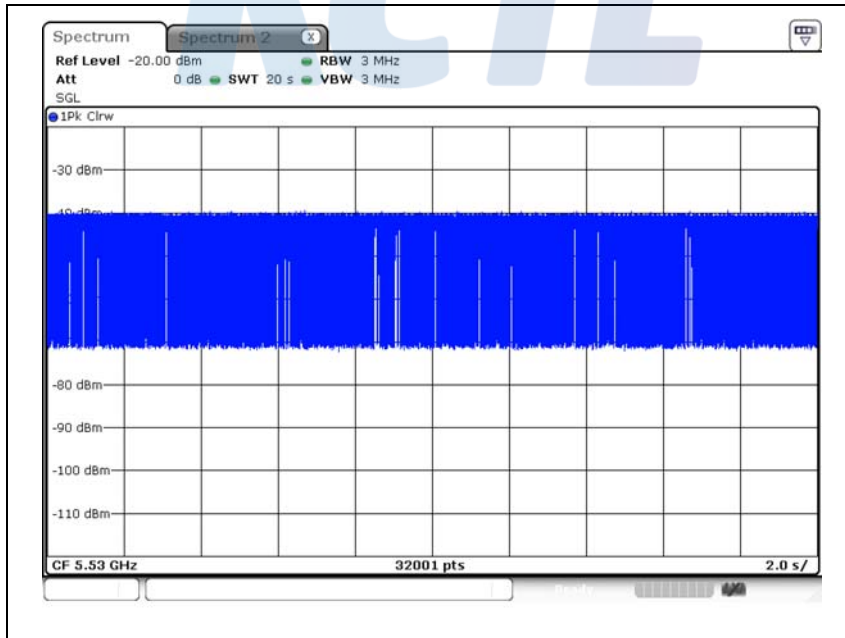

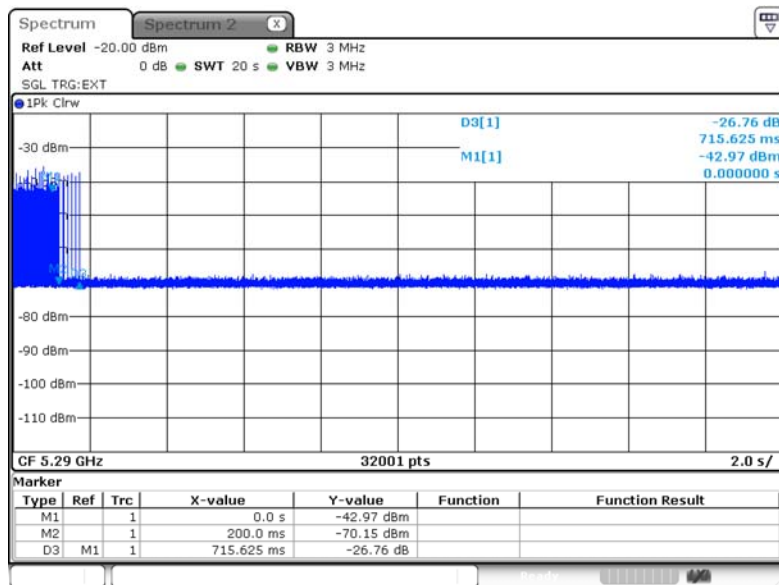
Plot of channel move time and aggregate time

Channel move time = 0.715 625 s

Closing time = 0.000 625 s x 11 = 0.006 875 s

(Closing time : Burst unit time(20 s / 32 001 points) * Number of burst(between 2 markers))

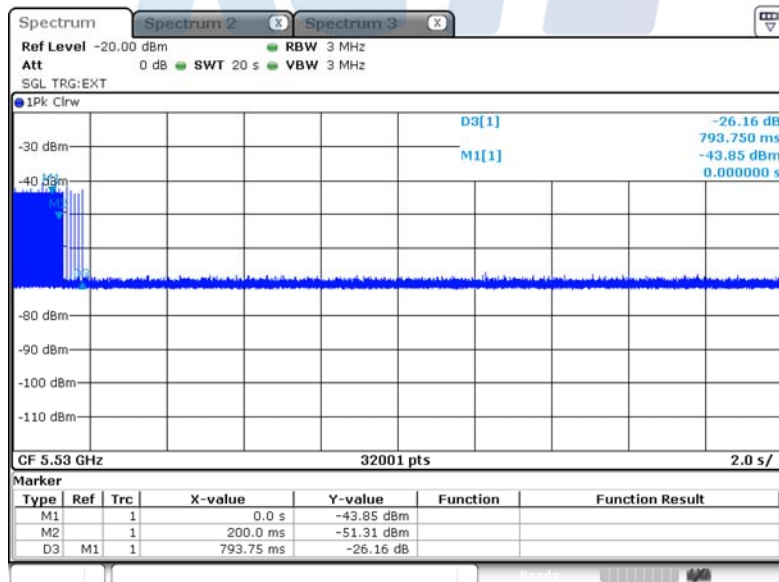
UNII-2A : 802.11 ac VHT80, 5 290 MHz

Channel move time = 0.793 75 s

Closing time = 0.000 625 s x 85 = 0.053 125 s

(Closing time : Burst unit time(20 s / 32 001 points) * Number of burst(between 2 markers))

UNII-2C : 802.11 ac VHT80, 5 530 MHz

Plot of Non-occupancy period

5 290 MHz

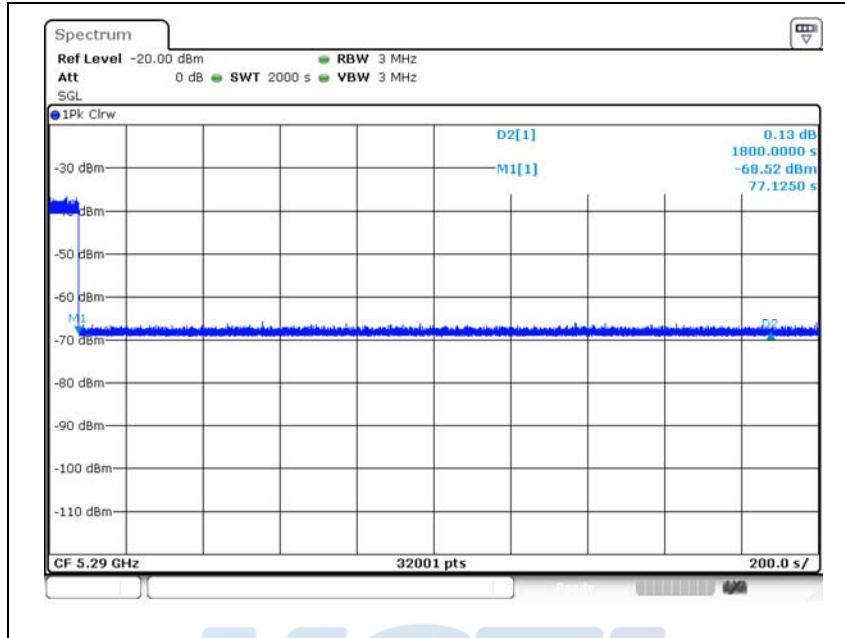

5 530 MHz

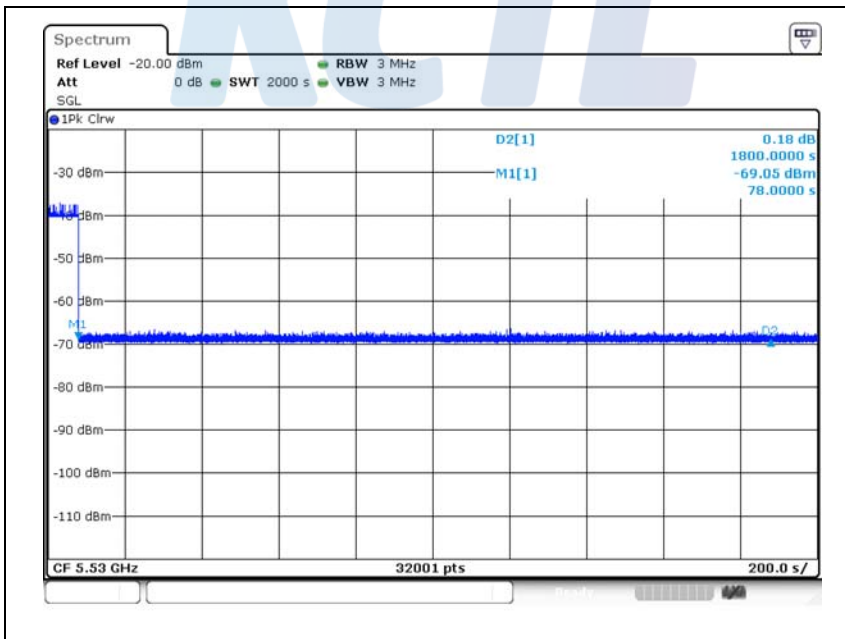

5. Measurement equipment

Equipment Name	Manufacturer	Model No.	Serial No.	Next Cal. Date
Spectrum Analyzer	R&S	FSV30	100810	21.07.29*
Power Divider	AGILENT	11636B	54456	21.01.06
Power Divider	Aeroflex / Weinschel, Inc	1580-1	RZ184	21.01.06
Attenuator	API Inmet	40AH2W-10	10	21.07.29*
Attenuator	API Inmet	40AH2W-10	17	21.05.12
Step Attenuator	HP	8496A	3308A16640	21.07.28*
Step Attenuator	AGILENT	8495D	MY42144296	21.01.22
Vector Signal Generator	R&S	SMBV100A	257566	21.07.13
Signal Generator	R&S	SMB100A	176206	21.01.21

*The equipment was used before finished calibration.

End of test report**KCTL**