

FCC NFC REPORT

Certification

Applicant Name:
SAMSUNG Electronics Co., Ltd.

Date of Issue:
July 04, 2022

Address:
129, Samsung-ro, Yeongtong-gu, Suwon-si, Gyeonggi-do,
16677, Rep. of Korea

Test Site/Location:
74, Seoicheon-ro 578beon-gil, Majang-myeon, Icheon-
si, Gyeonggi-do, 17383 KOREA

Report No.: HCT-RF-2206-FC047

FCC ID: A3LSMA047FN

APPLICANT: SAMSUNG Electronics Co., Ltd.

Model: SM-A047F/DSN

Additional Model: -

EUT Type: Mobile Phone

RF Output Field Strength: 21.58 dB μ V/m @30 m

Frequency of Operation: 13.56 MHz

Modulation type: ASK

FCC Classification: Low Power Communication Device Transmitter (DXX)

FCC Rule Part(s): FCC Part 15.225 Subpart C

Engineering Statement:

The measurements shown in this report were made in accordance with the procedures indicated, and the emissions from this equipment were found to be within the limits applicable. I assume full responsibility for the accuracy and completeness of these measurements, and for the qualifications of all persons taking them. It is further stated that upon the basis of the measurements made, the equipment tested is capable of operation in accordance with the requirements of the FCC Rules under normal use and maintenance.

Report No.: HCT-RF-2206-FC047

REVIEWED BY



Report prepared by : Chang Hee Hwang
Engineer of Telecommunication Testing Center

Report approved by : Jong Seok Lee
Manager of Telecommunication Testing Center

This test results were applied only to the test methods required by the standard.

This laboratory is not accredited for the test results marked *.

The above Test Report is the accredited test result by (KS Q) ISO/IEC 17025 and KOLAS(Korea Laboratory Accreditation Scheme), which signed the ILAC-MRA. (HCT Accreditation No.: KT197)

* The report shall not be reproduced except in full(only partly) without approval of the laboratory.

Version

TEST REPORT NO.	DATE	DESCRIPTION
HCT-RF-2206-FC047	July 04, 2022	- First Approval Report

Table of Contents

REVIEWED BY	2
1. EUT DESCRIPTION	5
2. TEST METHODOLOGY	6
EUT CONFIGURATION	6
EUT EXERCISE	6
GENERAL TEST PROCEDURES	6
DESCRIPTION OF TEST MODES	6
3. INSTRUMENT CALIBRATION.....	7
4. FACILITIES AND ACCREDITATIONS	7
FACILITIES	7
EQUIPMENT	7
5. ANTENNA REQUIREMENTS	7
6. MEASUREMENT UNCERTAINTY	8
7. DESCRIPTION OF TESTS.....	9
8. TEST SUMMARY	17
9. TEST RESULT	18
9.1. Operation within the band 13.110 MHz – 14.010 MHz.....	18
9.2. Radiated Emission 9kHz – 30 MHz	20
9.3. Radiated Emission 30 MHz – 1000 MHz	21
9.4. 20 dB Bandwidth	22
9.5. Frequency Stability	23
9.6. POWERLINE CONDUCTED EMISSIONS	27
10. LIST OF TEST EQUIPMENT	31
11. ANNEX A_ TEST SETUP PHOTO	33

1. EUT DESCRIPTION

Model	SM-A047F/DSN
Additional Model	-
EUT Type	Mobile Phone
Power Supply	DC 3.85 V
Frequency of Operation	13.56 MHz
Transmit Power	21.58 dB μ V/m @30 m
Modulation Type	ASK
Date(s) of Tests	June 01, 2022 ~ June 30, 2022
Serial number	Radiated : 4200624c907ec825

2. TEST METHODOLOGY

The measurement procedure described in the American National Standard of Procedures for Compliance Testing of Unlicensed Wireless Devices (ANSI C63.10-2013) is used in the measurement of the test device.

EUT CONFIGURATION

The EUT configuration for testing is installed on RF field strength measurement to meet the Commissions requirement and operating in a manner that intends to maximize its emission characteristics in a continuous normal application.

EUT EXERCISE

The EUT was operated in the engineering mode to fix the Tx frequency that was for the purpose of the measurements. According to its specifications, the EUT must comply with the requirements of the Section 15.207, 15.209 and 15.225 under the FCC Rules Part 15 Subpart C.

GENERAL TEST PROCEDURES

Conducted Emissions

The EUT is placed on the turntable, which is 0.8 m above ground plane. According to the requirements in Section 6.2 of ANSI C63.10. (Version :2013) Conducted emissions from the EUT measured in the frequency range between 0.15 MHz and 30MHz using CISPR Quasi-peak and average detector modes.

Radiated Emissions

The EUT is placed on a turn table, which is 0.8 m above ground plane. The turntable shall rotate 360 degrees to determine the position of maximum emission level. EUT is set 3 m away from the receiving antenna, which varied from 1 m to 4 m to find out the highest emission. And also, each emission was to be maximized by changing the polarization of receiving antenna both horizontal and vertical. In order to find out the max. emission, the relative positions of this hand-held transmitter (EUT) was rotated through three orthogonal axes according to the requirements in Section 6.6.5 of ANSI C63.10. (Version: 2013).

DESCRIPTION OF TEST MODES

The EUT has been tested under operating condition. Test program used to control the EUT for staying in continuous transmitting and receiving mode is programmed.

3. INSTRUMENT CALIBRATION

The measuring equipment, which was utilized in performing the tests documented herein, has been calibrated in accordance with the manufacturer's recommendations for utilizing calibration equipment, which is traceable to recognized national standards.

Especially, all antenna for measurement is calibrated in accordance with the requirements of C63.5 (Version : 2017).

4. FACILITIES AND ACCREDITATIONS

FACILITIES

The SAC(Semi-Anechoic Chamber) and conducted measurement facility used to collect the radiated data are located at the 74, Seoicheon-ro 578beon-gil, Majang-myeon, Icheon-si, Gyeonggi-do, 17383, Rep. of KOREA.

The site is constructed in conformance with the requirements of ANSI C63.4. (Version :2014) and CISPR Publication 22.

Detailed description of test facility was submitted to the Commission and accepted dated April 02, 2018 (Registration Number: KR0032).

EQUIPMENT

Radiated emissions are measured with one or more of the following types of Linearly polarized antennas: tuned dipole, bi-conical, log periodic, bi-log, and/or ridged waveguide, horn. Spectrum analyzers with pre-selectors and quasi-peak detectors are used to perform radiated measurements.

Conducted emissions are measured with Line Impedance Stabilization Networks and EMI Test Receivers. Calibrated wideband preamplifiers, coaxial cables, and coaxial attenuators are also used for making measurements.

All receiving equipment conforms to CISPR Publication 16-1, "Radio Interference Measuring Apparatus and Measurement Methods."

5. ANTENNA REQUIREMENTS

According to FCC 47 CFR §15.203:

"An intentional radiator antenna shall be designed to ensure that no antenna other than that furnished by the responsible party can be used with the device. The use of a permanently attached antenna or of an antenna that uses a unique coupling to the intentional radiator shall be considered sufficient to comply with the provisions of this section."

(1) The antennas of this E.U.T are permanently attached.

(2)The E.U.T Complies with the requirement of §15.203

6. MEASUREMENT UNCERTAINTY

The measurement uncertainties shown below were calculated in accordance with the requirements of ANSI C63.10-2013.

All measurement uncertainty values are shown with a coverage factor of $k = 2$ to indicate a 95 % level of confidence.

The measurement data shown herein meets or exceeds the U_{CISPR} measurement uncertainty values specified in CISPR 16-4-2 and, thus, can be compared directly to specified limits to determine compliance.

Parameter	Expanded Uncertainty (dB)
Conducted Disturbance (150 kHz ~ 30 MHz)	2.00 (Confidence level about 95 %, $k=2$)
Radiated Disturbance (9 kHz ~ 30 MHz)	4.40 (Confidence level about 95 %, $k=2$)
Radiated Disturbance (30 MHz ~ 1 GHz)	5.74 (Confidence level about 95 %, $k=2$)
Radiated Disturbance (1 GHz ~ 18 GHz)	5.51 (Confidence level about 95 %, $k=2$)
Radiated Disturbance (18 GHz ~ 40 GHz)	5.92 (Confidence level about 95 %, $k=2$)
Radiated Disturbance (Above 40 GHz)	5.48 (Confidence level about 95 %, $k=2$)

7. DESCRIPTION OF TESTS

7.1. Radiated Test

Limit (Operation within the band 13.110 MHz – 14.010 MHz)

Frequency (MHz)	Field Strength ($\mu\text{V/m}$)	Measurement Distance (m)
13.553 – 13.567	15,848	30
13.410 \leq f \leq 13.553 13.567 \leq f \leq 13.710	334	30
13.110 \leq f \leq 13.410 13.710 \leq f \leq 14.010	106	30

Note:

1. 15,848 $\mu\text{V/m}$ = 84.0dB $\mu\text{V/m}$
2. 334 $\mu\text{V/m}$ = 50.47 dB $\mu\text{V/m}$
3. 106 $\mu\text{V/m}$ = 40.51dB $\mu\text{V/m}$

Limit(Radiated Spurious Emissions)

Frequency (MHz)	Field Strength ($\mu\text{V/m}$)	Measurement Distance (m)
0.009 – 0.490	2400/F(kHz)	300
0.490 – 1.705	24000/F(kHz)	30
1.705 – 30	30	30
30-88	* 100	3
88-216	* 150	3
216-960	* 200	3
Above 960	500	3

※.

Except as provided in 15.209(g), fundamental emissions from intentional radiators operating under this Section shall not be located in the frequency bands 54-72MHz, 76-88MHz, 174-216MHz or 470-806MHz. However, operation within these frequency bands is permitted under other sections of this Part, e.g. 15.231 and 15.241.

Test Configuration

Below 30 MHz

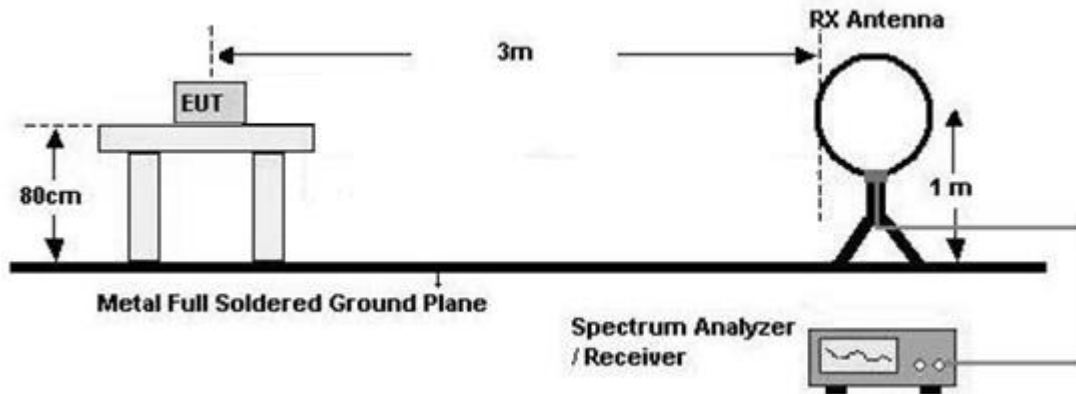

30 MHz - 1 GHz

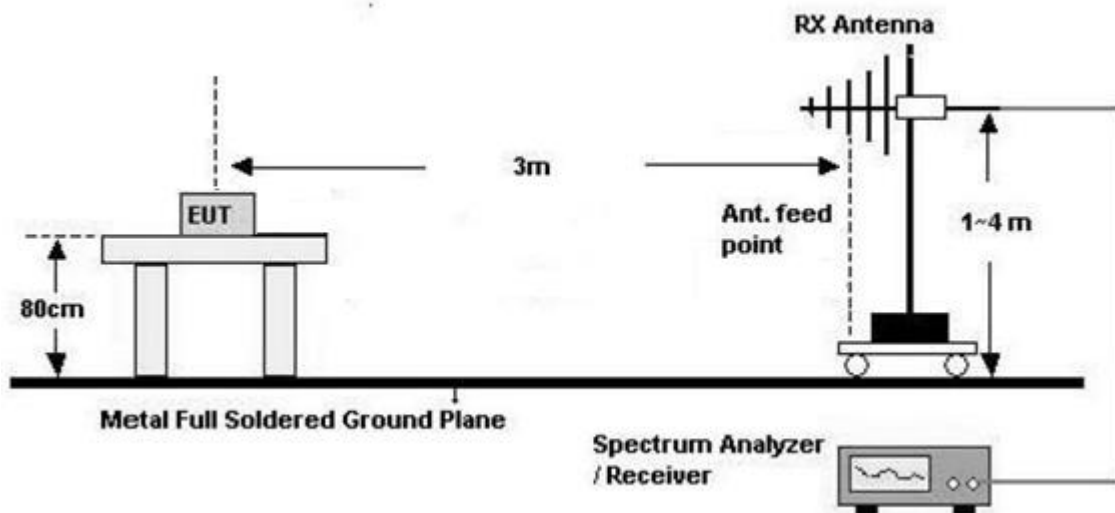

Test Procedure of in-band

1. The EUT was placed on a non-conductive table located on semi-anechoic chamber.
2. The loop antenna was placed at a location 3 m from the EUT
3. The EUT is placed on a turntable, which is 0.8m above ground plane.
4. We have done x, y, z planes in EUT and horizontal and vertical polarization and Parallel to the ground plane in detecting antenna.
5. The turntable shall be rotated for 360 degrees to determine the position of maximum emission level.
6. Distance Correction Factor = $40\log(3\text{ m}/30\text{ m}) = -40\text{ dB}$
Measurement Distance : 3 m(Below30 MHz)
7. Spectrum Setting

- Detector = Peak
- Trace = Max Hold
- RBW = 9 kHz
- VBW $\geq 3 \times$ RBW

8.Total = Measured Value + Antenna Factor(A.F) + Cable Loss(C.L) + Distance Factor(D.F)

Test Procedure of Radiated spurious emissions(Below30 MHz)

1. The EUT was placed on a non-conductive table located on semi-anechoic chamber.
2. The loop antenna was placed at a location 3 m from the EUT
3. The EUT is placed on a turntable, which is 0.8m above ground plane.
4. We have done x, y, z planes in EUT and horizontal and vertical polarization and Parallel to the ground plane in detecting antenna.
5. The turntable shall be rotated for 360 degrees to determine the position of maximum emission level.
6. Distance Correction Factor(0.009 MHz – 0.490 MHz) = $40\log(3 \text{ m}/300 \text{ m}) = - 80 \text{ dB}$
Measurement Distance : 3 m
7. Distance Correction Factor(0.490 MHz – 30 MHz) = $40\log(3 \text{ m}/30 \text{ m}) = - 40 \text{ dB}$
Measurement Distance : 3 m
8. Spectrum Setting
 - Frequency Range = 9 kHz ~ 30 MHz
 - Detector = Peak
 - Trace = Maxhold
 - RBW = 9 kHz
 - VBW $\geq 3 \times$ RBW
- 9.Total = Measured Value + Antenna Factor(A.F) + Cable Loss(C.L) + Distance Factor(D.F)
10. Measurement value only up to 6 maximum emissions noted, or would be lesser if no specific emissions from the EUT are recorded (ie: margin > 20 dB from the applicable limit) and considered that's already beyond the background noise floor.

KDB 414788 OFS and Chamber Correlation Justification

Base on FCC 15.31 (f) (2): measurements may be performed at a distance closer than that specified in the regulations; however, an attempt should be made to avoid making measurements in the near field.

OFS and chamber correlation testing had been performed and chamber measured test result is the worst case test result.

Test Procedure of Radiated spurious emissions(Above30 MHz)

1. The EUT was placed on a non-conductive table located on semi-anechoic chamber.
2. The EUT is placed on a turntable, which is 0.8m above ground plane.
3. The Hybrid antenna was placed at a location 3 m from the EUT, which is varied from 1m to 4m to find out the highest emissions.
4. We have done x, y, z planes in EUT and horizontal and vertical polarization in detecting antenna.
5. The turntable shall be rotated for 360 degrees to determine the position of maximum emission level.
6. Spectrum Setting
 - Frequency Range = 30 MHz ~ 1 GHz
 - Detector = Peak
 - Trace = Maxhold
 - RBW = 100 kHz
 - VBW \geq 3 x RBW
7. Total = Measured Value + Antenna Factor(A.F) + Cable Loss(C.L)
8. Measurement value only up to 6 maximum emissions noted, or would be lesser if no specific emissions from the EUT are recorded (ie: margin > 20 dB from the applicable limit) and considered that's already beyond the background noise floor.

7.2. 20 dB Bandwidth

Test Configuration

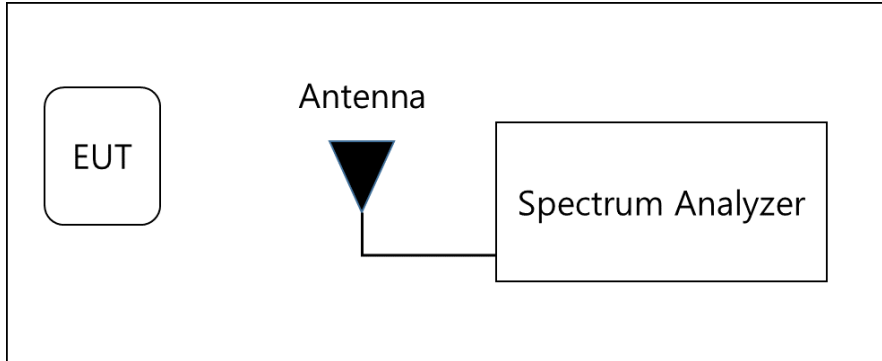

Test Procedure

The 20 dB bandwidth was measured by using a spectrum analyzer.

(Procedure 6.9.2 in ANSI 63.10-2013)

- 1) RBW = 1 %~5 % of the OBW
- 2) VBW = approximately three times RBW
- 3) Span = between two times and five times the OBW
- 4) Detector = Peak
- 5) Trace mode = Max hold
- 6) Allow the trace to stabilize

Note :

We tested Occupied Bandwidth using the automatic bandwidth measurement capability of a spectrum analyzer.

7.3. Frequency Stability

Limit

The frequency tolerance of the carrier signal shall be maintained within $\pm 0.01\%$ of the operating frequency.

Test Configuration

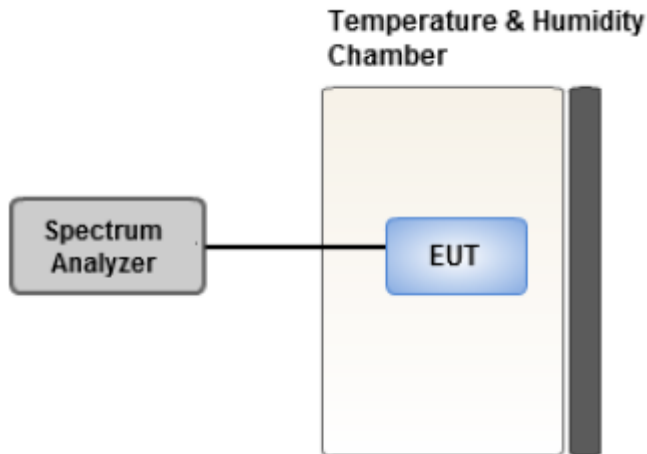

Test Procedure.

For battery operated equipment, the equipment tests shall be performed using a new battery.

- 1) Turn the EUT OFF and place it inside the environmental temperature chamber.
For devices that have oscillator heaters, energize only the heater circuit.
- 2) Set the temperature control on the chamber to the highest specified in the regulatory requirements for the type of device and allow the oscillator heater and the chamber temperature to stabilize.
- 3) While maintaining a constant temperature inside the environmental chamber, turn the EUT ON and record the operating frequency at startup, and at 2 minutes, 5 minutes, and 10 minutes after the EUT is energized. Four measurements in total are made.
- 4) The frequency tolerance of the carrier signal shall be maintained within $\pm 0.01\%$ of the operating frequency.

Note:

- 1) Temperature:
The temperature is varied from -20°C to $+50^{\circ}\text{C}$ using an environmental chamber.
- 2) Primary Supply Voltage :
The primary supply voltage is varied from 85% to 115% of the nominal value for non hand-carried battery and AC powered equipment.
For hand-carried, battery-powered equipment, primary supply voltage is reduced to the battery operating end point which shall be specified by the manufacturer.

7.4. AC Power line Conducted Emissions

Limit

For an intentional radiator that is designed to be connected to the public utility (AC) power line, the radio frequency voltage that is conducted back onto the AC power line on any frequency or frequencies, within the band 150 kHz to 30 MHz, shall not exceed the limits in the following table, as measured using a 50 μ H/50 ohms line impedance stabilization network (LISN).

Frequency Range (MHz)	Limits (dB μ V)	
	Quasi-peak	Average
0.15 to 0.50	66 to 56 ^(a)	56 to 46 ^(a)
0.50 to 5	56	46
5 to 30	60	50

^(a)Decreases with the logarithm of the frequency.

Compliance with this provision shall be based on the measurement of the radio frequency voltage between each power line (LINE and NEUTRAL) and ground at the power terminals.

Test Configuration

See test photographs attached in Annex A for the actual connections between EUT and support equipment.

Test Procedure

1. The EUT is placed on a wooden table 80 cm above the reference ground plane.
2. The EUT is connected via LISN to a test power supply.
3. The measurement results are obtained as described below:
4. Detectors : Quasi Peak and Average Detector.
5. The EUT is the device operating below 30 MHz.
 - For unterminated the Antenna, the AC line conducted tests are performed with the antenna connected
 - For terminated the Antenna, the AC line conducted tests are performed with a dummy load connected to the EUT antenna output terminal.

Sample Calculation

Quasi-peak(Final Result) = Measured Value + Correction Factor

7.5. Worst case configuration and mode

Radiated test

1. All modes of operation were investigated and the worst case configuration results are reported.
 - Mode : Stand alone, Stand alone + external accessories(Earphone, etc)
 - Worst case : Stand alone
2. EUT Axis : X
3. All type and bitrate were investigated and the worst case results are reported.
 - Worst case : Type A, 106 kbps
4. All mode of without tag and with tag were investigated and the worst case configuration results are reported.
 - Worst case : Without Tag
5. All position of loop antenna were investigated and the worst case configuration results are reported.
 - Position : Horizontal, Vertical, Parallel to the ground plane
 - Worst case : Horizontal

AC Power line Conducted Emissions

1. All modes of operation were investigated and the worst case configuration results are reported.
 - Mode : Stand alone + Earphone + Travel Adapter, Stand alone + Travel Adapter
 - Worst case : Stand alone + Travel Adapter
2. All modes(For unterminated the Antenna, terminated the Antenna) of operation were investigated and the worst case configuration results are reported.
 - Worst case : Unterminated the Antenna

20 dB Bandwidth & Frequency Stability

1. All type and bitrate were investigated and the worst case results are reported.
 - Worst case : Type A, 106 kbps

8. TEST SUMMARY

Regulation	Requirement	Result
Part 15.225 (a)	Radiated Electric Field Emissions (13.553MHz to 13.567MHz)	Pass
Part 15.225 (b)	Radiated Electric Field Emissions ($13.410 \leq f \leq 13.553$, $13.567 \leq f \leq 13.710$)	Pass
Part 15.225 (c)	Radiated Electric Field Emissions ($13.110 \leq f \leq 13.410$, $13.710 \leq f \leq 14.010$)	Pass
Part 15.209	Radiated Electric Field Emissions (9kHz to 30MHz)	Pass
Part 15.209	Radiated Electric Field Emissions (30MHz to 1GHz)	Pass
Part 15.225 (e)	Frequency Stability	Pass
Part 15.207	AC power conducted emissions (150kHz to 30MHz)	Pass
Part 15.215 (c)	20 dB Bandwidth	Pass

9. TEST RESULT

9.1. Operation within the band 13.110 MHz – 14.010 MHz

Measured Frequency Range : 13.553 MHz-13.567 MHz							
Frequency (MHz)	Measured Value (dB μ V/m) @3 m	Ant. Factor +Cable Loss (dB/m)	Distance Correction (dB)	Ant. POL (H/V)	Total (dB μ V/m) @30 m	Limit (dB μ V/m) @30 m	Margin (dB)
13.5597	41.15	20.43	-40.00	H	21.58	84.00	62.42
13.5604	39.40	20.43	-40.00	V	19.83	84.00	64.17

Measured Frequency Range : 13.410 MHz-13.553 MHz and 13.567 MHz-13.710 MHz							
Frequency (MHz)	Measured Value (dB μ V/m) @3 m	Ant. Factor +Cable Loss (dB/m)	Distance Correction (dB)	Ant. POL (H/V)	Total (dB μ V/m) @30 m	Limit (dB μ V/m) @30 m	Margin (dB)
13.5529	35.19	20.43	-40.00	H	15.62	50.47	34.85
13.5670	34.99	20.43	-40.00	H	15.42	50.47	35.05

Measured Frequency Range : 13.110 MHz – 13.410 MHz and 13.710 MHz-14.010 MHz							
Frequency (MHz)	Measured Value (dB μ V/m) @3 m	Ant. Factor +Cable Loss (dB/m)	Distance Correction (dB)	Ant. POL (H/V)	Total (dB μ V/m) @30 m	Limit (dB μ V/m) @30 m	Margin (dB)
13.3478	25.04	20.43	-40.00	H	5.47	40.51	35.04
13.7710	23.59	20.43	-40.00	H	4.02	40.51	36.49

Test Plot

13.553 MHz ~ 13.567 MHz

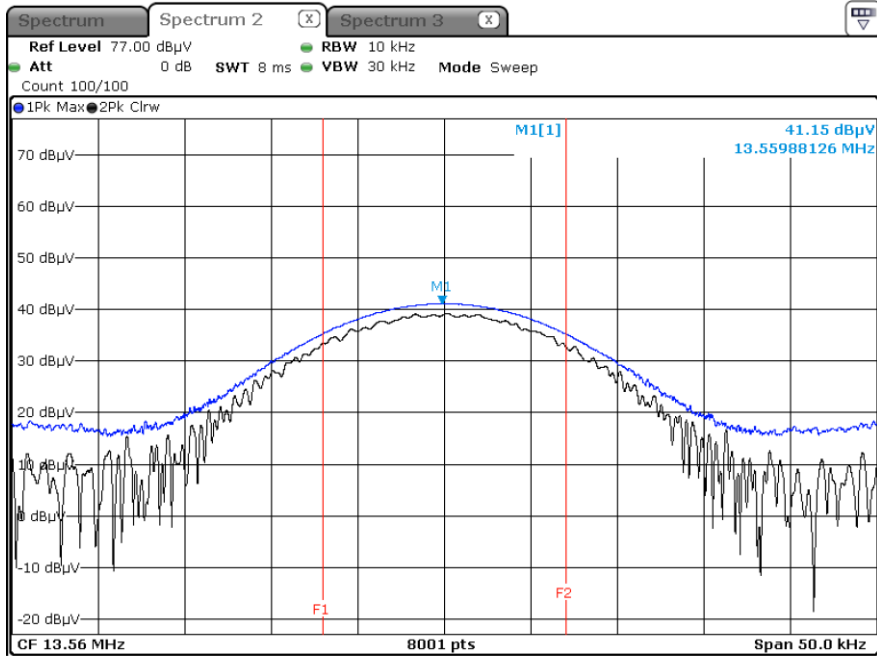

Worst Case (13.410 MHz ~ 13.553 MHz)

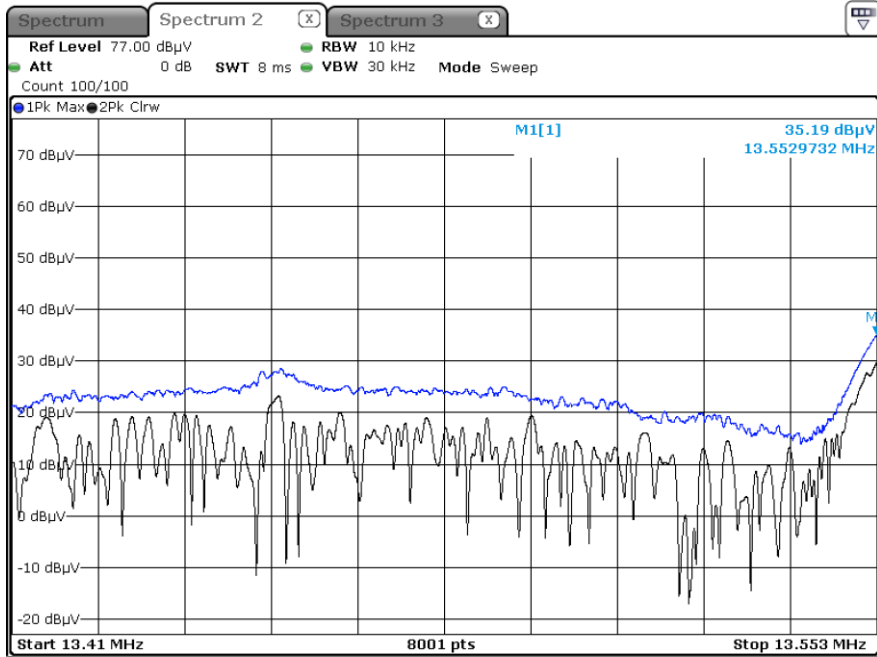

Note:

Plot of worst case are only reported.

9.2. Radiated Emission 9kHz – 30 MHz

Measured Frequency Range : 9 kHz - 30 MHz							
Frequency (MHz)	Measured Value (dB μ V/m) @3 m	Ant. Factor +Cable Loss (dB/m)	Distance Correction (dB)	Ant. POL (H/V)	Total (dB μ V/m) @30 m	Limit (dB μ V/m) @30 m	Margin (dB)
12.2102	10.46	20.43	-40.00	H	-9.11	29.54	38.65
19.8686	10.49	20.75	-40.00	H	-8.76	29.54	38.30
27.0388	8.34	20.58	-40.00	H	-11.08	29.54	40.62
26.6854	8.23	20.58	-40.00	V	-11.19	29.54	40.73

9.3. Radiated Emission 30 MHz – 1000 MHz

Measured Frequency Range : 30 MHz - 1000 MHz							
Frequency (MHz)	Measured Value (dBμV/m) @3 m	Ant. Factor (dB/m)	Cable Loss (dB)	Ant. Pol (H/V)	Total (dBμV/m)	Limit (dBμV/m)	Margin (dB)
#37.752	9.626	19.50	0.49	H	29.616	40.00	10.384
54.62	8.786	20.16	0.56	H	29.506	40.00	10.494
105.32	7.607	16.04	0.94	V	24.587	43.50	18.913
#120.225	8.51	16.40	1.07	H	25.98	43.50	17.52
#137.325	8.394	18.20	1.14	H	27.734	43.50	15.766
149.96	7.184	19.10	1.20	V	27.484	43.50	16.016

Note:

1. # is the result for restricted band.

Test Plot

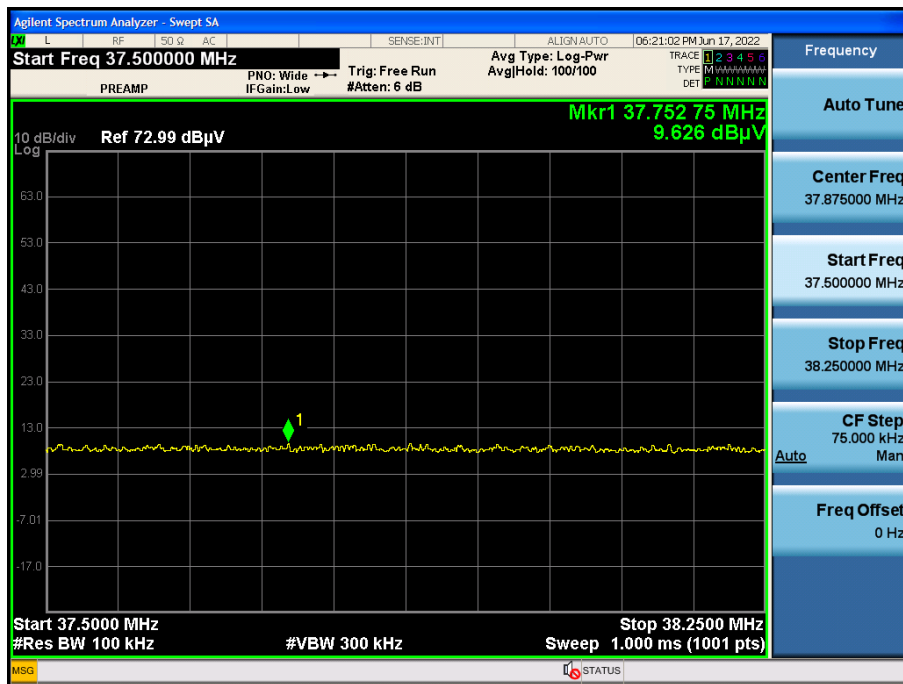

Note:

Plot of worst case are only reported

9.4. 20 dB Bandwidth

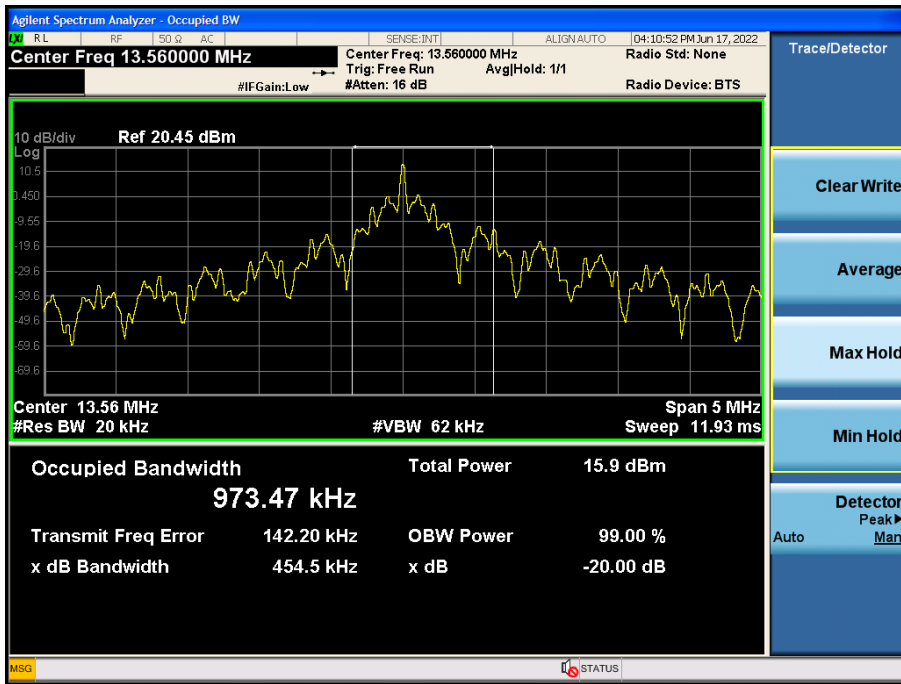

9.5. Frequency Stability

Startup

PERATING FREQUENCY: 13.56 MHz
REFERENCE VOLTAGE: 3.85 VDC
DEVIATION LIMIT: ±0.01 % = ± 1356 Hz

Voltage (%)	Power (VDC)	Temp. (°C)	Frequency (MHz)	Frequency Dev. (Hz)	Frequency Dev (%)
100%	3.85	-20	13.560062	62	0.0004572
100%		-10	13.560033	33	0.0002434
100%		0	13.560019	19	0.0001401
100%		+10	13.560026	26	0.0001917
100%		+20(Ref.)	13.560018	18	0.0001327
100%		+30	13.560024	24	0.0001770
100%		+40	13.560026	26	0.0001917
100%		+50	13.560039	39	0.0002876
LOW	3.60	+20	13.560075	75	0.0005531
HIGH	4.40	+20	13.560042	42	0.0003097

2 minutesOPERATING FREQUENCY: 13.56 MHzREFERENCE VOLTAGE: 3.85 VDCDEVIATION LIMIT: ±0.01 % = ± 1356 Hz

Voltage (%)	Power (VDC)	Temp. (°C)	Frequency (MHz)	Frequency Dev. (Hz)	Frequency Dev (%)
100%	3.85	-20	13.560022	22	0.0001622
100%		-10	13.560029	29	0.0002139
100%		0	13.560035	35	0.0002581
100%		+10	13.560033	33	0.0002434
100%		+20(Ref.)	13.560018	18	0.0001327
100%		+30	13.560041	41	0.0003024
100%		+40	13.560026	26	0.0001917
100%		+50	13.560071	71	0.0005236
LOW		3.60	+20	13.560025	25
HIGH	4.40	+20	13.560057	57	0.0004204

5 minutesOPERATING FREQUENCY: 13.56 MHzREFERENCE VOLTAGE: 3.85 VDCDEVIATION LIMIT: ±0.01 % = ± 1356 Hz

Voltage (%)	Power (VDC)	Temp. (°C)	Frequency (MHz)	Frequency Dev. (Hz)	Frequency Dev (%)
100%	3.85	-20	13.560022	22	0.0001622
100%		-10	13.560072	72	0.0005310
100%		0	13.560083	83	0.0006121
100%		+10	13.560026	26	0.0001917
100%		+20(Ref.)	13.560084	84	0.0006195
100%		+30	13.560042	42	0.0003097
100%		+40	13.560060	60	0.0004425
100%		+50	13.560017	17	0.0001254
LOW		3.60	+20	13.560054	54
HIGH	4.40	+20	13.560069	69	0.0005088

10 minutesOPERATING FREQUENCY: 13.56 MHzREFERENCE VOLTAGE: 3.85 VDCDEVIATION LIMIT: ±0.01 % = ± 1356 Hz

Voltage (%)	Power (VDC)	Temp. (°C)	Frequency (MHz)	Frequency Dev. (Hz)	Frequency Dev (%)
100%	3.85	-20	13.560071	71	0.0005236
100%		-10	13.560029	29	0.0002139
100%		0	13.560034	34	0.0002507
100%		+10	13.560026	26	0.0001917
100%		+20(Ref.)	13.560044	44	0.0003245
100%		+30	13.560082	82	0.0006047
100%		+40	13.560032	32	0.0002360
100%		+50	13.560050	50	0.0003687
LOW		3.60	+20	13.560061	61
HIGH	4.40	+20	13.560049	49	0.0003614

9.6. POWERLINE CONDUCTED EMISSIONS

Conducted Emissions (Line 1)

Test

1 / 2

Test Report

Common Information

EUT : SM-A047F/DSN
 Manufacturer : SAMSUNG Electronics Co., Ltd.
 Test Site : SHIELD ROOM
 Operating Conditions : NFC UnT L1

Full Spectrum

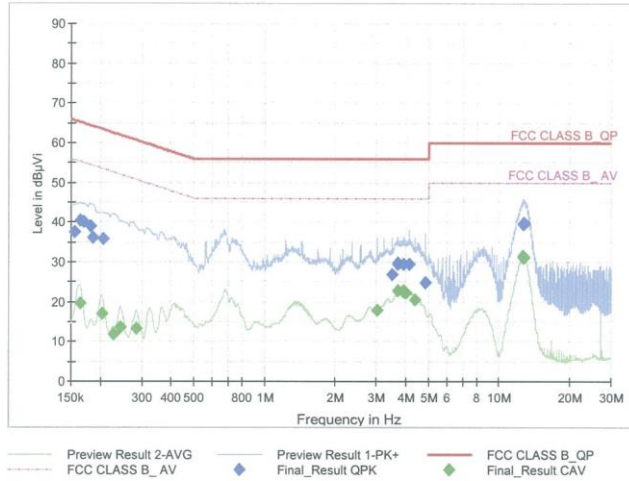

Final Result QPK

Frequency (MHz)	QuasiPeak (dBµV)	Limit (dBµV)	Margin (dB)	Bandwidth (kHz)	Line	Filter	Corr. (dB)
0.1545	37.38	65.75	28.37	9.000	L1	OFF	9.6
0.1635	40.48	65.28	24.80	9.000	L1	OFF	9.6
0.1703	40.19	64.95	24.76	9.000	L1	OFF	9.6
0.1815	38.89	64.42	25.53	9.000	L1	OFF	9.6
0.1860	35.92	64.21	28.29	9.000	L1	OFF	9.6
0.2063	35.87	63.36	27.49	9.000	L1	OFF	9.6
3.4880	26.96	56.00	29.04	9.000	L1	OFF	9.8
3.6973	29.67	56.00	26.33	9.000	L1	OFF	9.8
3.7040	29.56	56.00	26.44	9.000	L1	OFF	9.8
3.9133	29.41	56.00	26.59	9.000	L1	OFF	9.8
4.1585	29.55	56.00	26.45	9.000	L1	OFF	9.8
4.8290	24.77	56.00	31.23	9.000	L1	OFF	9.8
12.6568	39.47	60.00	20.53	9.000	L1	OFF	10.1
12.7018	39.74	60.00	20.26	9.000	L1	OFF	10.1
12.7468	39.60	60.00	20.40	9.000	L1	OFF	10.1
12.7648	39.77	60.00	20.23	9.000	L1	OFF	10.1
12.7918	39.40	60.00	20.60	9.000	L1	OFF	10.1
12.8120	39.66	60.00	20.34	9.000	L1	OFF	10.1

Final Result_CAV

2022-06-17

오전 10:54:10

Test

2 / 2

Frequency (MHz)	CAverage (dBμV)	Limit (dBμV)	Margin (dB)	Bandwidth (kHz)	Line	Filter	Corr. (dB)
0.1635	19.61	55.28	35.67	9.000	L1	OFF	9.6
0.2040	17.15	53.45	36.30	9.000	L1	OFF	9.6
0.2265	11.73	52.58	40.84	9.000	L1	OFF	9.6
0.2445	13.57	51.94	38.37	9.000	L1	OFF	9.6
0.2850	13.37	50.67	37.30	9.000	L1	OFF	9.6
3.0313	17.85	46.00	28.15	9.000	L1	OFF	9.8
3.6950	22.70	46.00	23.30	9.000	L1	OFF	9.8
3.9133	22.61	46.00	23.39	9.000	L1	OFF	9.8
3.9178	22.73	46.00	23.27	9.000	L1	OFF	9.8
4.0033	22.07	46.00	23.93	9.000	L1	OFF	9.8
4.3723	20.62	46.00	25.38	9.000	L1	OFF	9.8
12.6208	31.30	50.00	18.70	9.000	L1	OFF	10.1
12.6523	31.39	50.00	18.61	9.000	L1	OFF	10.1
12.6793	31.25	50.00	18.75	9.000	L1	OFF	10.1
12.7603	31.21	50.00	18.79	9.000	L1	OFF	10.1
12.7738	31.22	50.00	18.78	9.000	L1	OFF	10.1
12.7850	31.14	50.00	18.86	9.000	L1	OFF	10.1
12.8255	31.15	50.00	18.85	9.000	L1	OFF	10.1

2022-06-17

오전 10:54:10

Conducted Emissions (Line 2)

Test

1 / 2

Test Report

Common Information

EUT : SM-A047F/DSN
 Manufacturer : SAMSUNG Electronics Co., Ltd.
 Test Site: SHIELD ROOM
 Operating Conditions : NFC UnT N

Full Spectrum

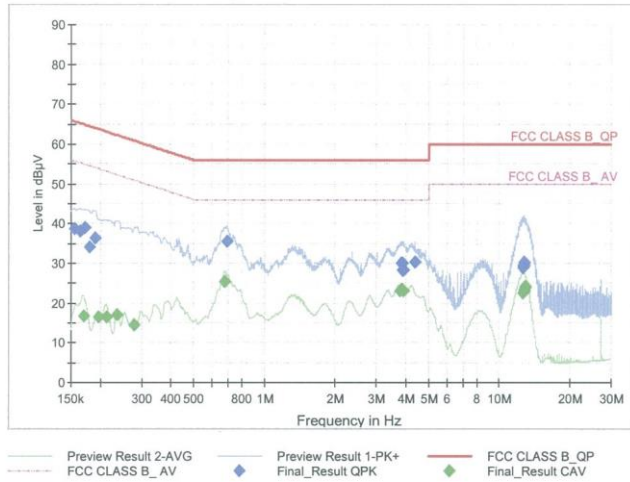

Final Result QPK

Frequency (MHz)	QuasiPeak (dBµV)	Limit (dBµV)	Margin (dB)	Bandwidth (kHz)	Line	Filter	Corr. (dB)
0.1545	38.61	65.75	27.14	9.000	N	OFF	9.6
0.1635	37.96	65.28	27.33	9.000	N	OFF	9.6
0.1725	38.87	64.84	25.97	9.000	N	OFF	9.6
0.1793	34.15	64.52	30.37	9.000	N	OFF	9.6
0.1905	36.29	64.02	27.72	9.000	N	OFF	9.6
0.6935	35.60	56.00	20.40	9.000	N	OFF	9.7
3.8278	29.92	56.00	26.08	9.000	N	OFF	9.8
3.8705	30.00	56.00	26.00	9.000	N	OFF	9.8
3.8750	29.98	56.00	26.02	9.000	N	OFF	9.8
3.8840	28.37	56.00	27.63	9.000	N	OFF	9.8
3.9200	28.30	56.00	27.70	9.000	N	OFF	9.8
4.3745	30.40	56.00	25.60	9.000	N	OFF	9.8
12.6343	28.79	60.00	31.21	9.000	N	OFF	10.2
12.6815	29.55	60.00	30.45	9.000	N	OFF	10.2
12.6973	29.55	60.00	30.45	9.000	N	OFF	10.2
12.7288	30.04	60.00	29.96	9.000	N	OFF	10.2
12.7490	30.39	60.00	29.61	9.000	N	OFF	10.2
12.8008	30.41	60.00	29.59	9.000	N	OFF	10.2

Final_Result_CAV

2022-06-17

오전 10:59:45

Test

2 / 2

Frequency (MHz)	CAverage (dBμV)	Limit (dBμV)	Margin (dB)	Bandwidth (kHz)	Line	Filter	Corr. (dB)
0.1703	16.64	54.95	38.30	9.000	N	OFF	9.6
0.1973	16.43	53.73	37.29	9.000	N	OFF	9.6
0.2130	16.35	53.09	36.74	9.000	N	OFF	9.6
0.2355	16.97	52.25	35.28	9.000	N	OFF	9.6
0.2783	14.40	50.87	36.47	9.000	N	OFF	9.6
0.6778	25.43	46.00	20.57	9.000	N	OFF	9.7
3.7873	22.96	46.00	23.04	9.000	N	OFF	9.8
3.7985	23.15	46.00	22.85	9.000	N	OFF	9.8
3.8435	23.41	46.00	22.59	9.000	N	OFF	9.8
3.8503	23.32	46.00	22.68	9.000	N	OFF	9.8
3.8728	23.27	46.00	22.73	9.000	N	OFF	9.8
3.9358	23.17	46.00	22.83	9.000	N	OFF	9.8
12.5870	22.40	50.00	27.60	9.000	N	OFF	10.2
12.6365	22.54	50.00	27.46	9.000	N	OFF	10.2
12.7040	23.09	50.00	26.91	9.000	N	OFF	10.2
12.7468	23.44	50.00	26.56	9.000	N	OFF	10.2
12.8368	23.82	50.00	26.18	9.000	N	OFF	10.2
12.8638	24.11	50.00	25.89	9.000	N	OFF	10.2

2022-06-17

오전 10:59:45

10. LIST OF TEST EQUIPMENT

Conducted Test

Equipment	Model	Manufacturer	Serial No.	Due to Calibration	Calibration Interval
LISN	ENV216	Rohde & Schwarz	102245	08/23/2022	Annual
EMI Test Receiver	ESR	Rohde & Schwarz	101910	06/07/2023	Annual
Temperature Chamber	SU-642	ESPEC	0093008124	03/04/2023	Annual
Signal Analyzer	N9030A	Agilent	MY49431210	01/11/2023	Annual
DC Power Supply	E3646A	Agilent	MY40002937	12/14/2022	Annual
Attenuator(10 dB)	8493C	Hewlett Packard	07560	06/14/2023	Annual
Software	EMC32	Rohde & Schwarz	N/A	N/A	N/A

Note:

1. Equipment listed above that calibrated during the testing period was set for test after the calibration.
2. Equipment listed above that has a calibration due date during the testing period, the testing is completed before equipment expiration date.

Radiated Test

Equipment	Model	Manufacturer	Serial No.	Due to Calibration	Calibration Interval
Controller(Antenna mast)	CO3000	Innco system	CO3000-4p	N/A	N/A
Antenna Position Tower	MA4640/800-XP-EP	Innco system	N/A	N/A	N/A
Controller	EM1000	Audix	060520	N/A	N/A
Turn Table	N/A	Audix	N/A	N/A	N/A
Loop Antenna	FMZB 1513	Rohde & Schwarz	1513-333	03/17/2024	Biennial
Hybrid Antenna	VULB 9168	Schwarzbeck	760	02/22/2023	Biennial
Horn Antenna	BBHA 9120D	Schwarzbeck	02299	03/24/2024	Biennial
Spectrum Analyzer	FSV40-N	Rohde & Schwarz	102168	07/05/2022	Annual
Signal Analyzer	N9030A	Agilent	MY49431210	01/11/2023	Annual
Attenuator (3 dB)	18B-03	Api tech.	1	01/21/2023	Annual
Attenuator(10 dB)	8493C-10	Agilent	08285	01/21/2023	Annual
Power Amplifier	CBLU1183540	CERNEX	22964	01/21/2023	Annual
Power Amplifier	CBL06185030	CERNEX	22965	01/21/2023	Annual
Power Amplifier	CBL18265035	CERNEX	22966	12/02/2022	Annual
Power Amplifier	CBL26405040	CERNEX	25956	03/11/2023	Annual

Note:

1. Equipment listed above that calibrated during the testing period was set for test after the calibration.
2. Equipment listed above that has a calibration due date during the testing period, the testing is completed before equipment expiration date.
3. Especially, all antenna for measurement is calibrated in accordance with the requirements of C63.5(Version : 2017).

11. ANNEX A_ TEST SETUP PHOTO

Please refer to test setup photo file no. as follows;

No.	Description
1	HCT-RF-2206-FC047-P