



PCTEST ENGINEERING LABORATORY, INC.

6660-B Dobbin Road, Columbia, MD 21045 USA
Tel. 410.290.6652 / Fax 410.290.6554
<http://www.pctestlab.com>



HEARING AID COMPATIBILITY CERTIFICATE

Applicant Name:
Samsung Electronics, Co. Ltd.
18600 Broadwick St.
Rancho Dominguez, CA 90220 USA
United States

Date of Testing:
June 29 - July 3, 2006
Test Site/Location:
PCTEST Lab, Columbia, MD, USA
Test Report Serial No.:
0606200529

FCC ID: A3LSGHZX20

APPLICANT: SAMSUNG ELECTRONICS, CO. LTD.

Scope of Test:	Audio Band Magnetic Testing (T-Coil)
Application Type:	Class II Permissive Change
FCC Rule Part(s):	§ 20.19(b), §6.3(v), §7.3(v)
HAC Standard:	ANSI C63.19-2006 v3.12
FCC Classification:	Licensed Transmitter Held to Ear (PCE)
EUT Type:	Dual-Band GSM/WCDMA Phone with Bluetooth
Model(s):	SGH-ZX20
Tx Frequency:	824.20 - 848.80 MHz (Cellular GSM) 1850.20 - 1909.80 MHz (GSM PCS) 826.40 - 846.60 MHz (Cellular WCDMA) 1852.4 - 1907.6 MHz (PCS WCDMA)
Test Device Serial No.:	<i>Pre-Production Sample</i> [S/N: FD-091-E]
Class II Permissive Change(s):	Adding T-Coil Rating, See Attachments
HAC RF Emissions Rating:	M3 (ANSI C63.19-2006)
Original Grant Date:	4/12/2006

C63.19 HAC Rated Category: T4 (SIGNAL TO NOISE CATEGORY)

This wireless portable device has been shown to be hearing-aid compatible under the above rated category, specified in ANSI/IEEE Std. C63.19-2006 and had been tested in accordance with the specified measurement procedures. The RF Emissions for this device was M3 and is covered under a separate test report. Hearing-Aid Compatibility is based on the assumption that all production units will be designed electrically identical to the device tested in this report.

I attest to the accuracy of data. All measurements reported herein were performed by me or were made under my supervision and are correct to the best of my knowledge and belief. I assume full responsibility for the completeness of these measurements and vouch for the qualifications of all persons taking them.

PCTEST certifies that no party to this application has been denied the FCC benefits pursuant to Section 5301 of the Anti-Drug Abuse Act of 1988, 21 U.S.C. 862.



Randy Ortanez
President



FCC ID: A3LSGHZX20		C63.19-2006 v3.12 §6 HAC TEST REPORT		Reviewed by: Quality Manager
Filename: 0606200529	Test Dates: June 29 - July 3, 2006	EUT Type: Dual-Band GSM/WCDMA Phone with Bluetooth		Page 1 of 37

TABLE OF CONTENTS

1.	INTRODUCTION	3
2.	TEST SITE LOCATION	4
3.	EUT DESCRIPTION	5
4.	ANSI/IEEE C63.19 PERFORMANCE CATEGORIES	6
5.	METHOD OF MEASUREMENT	9
6.	TEST SUMMARY	19
7.	FCC 3G MEASUREMENTS – JUNE 2006	24
8.	MEASUREMENT UNCERTAINTY	25
9.	EQUIPMENT LIST	26
10.	CALIBRATION CERTIFICATES.....	27
11.	CONCLUSION.....	33
12.	REFERENCES	34
13.	TEST SETUP PHOTOGRAPHS	36

FCC ID: A3LSGHZX20	 PCTEST	C63.19-2006 v3.12 §6 HAC TEST REPORT	 SAMSUNG	Reviewed by: Quality Manager
Filename: 0606200529	Test Dates: June 29 - July 3, 2006	EUT Type: Dual-Band GSM/WCDMA Phone with Bluetooth		Page 2 of 37

1. INTRODUCTION

On July 10, 2003, the Federal Communications Commission (FCC) adopted new rules requiring wireless manufacturers and service providers to provide digital wireless phones that are compatible with hearing aids. The FCC has modified the exemption for wireless phones under the Hearing Aid Compatibility Act of 1998 (HAC Act) in WT Docket 01-309 RM-8658¹ to extend the benefits of wireless telecommunications to individuals with hearing disabilities. These benefits encompass business, social and emergency communications, which increase the value of the wireless network for everyone. An estimated more than 10% of the population in the United States show signs of hearing impairment and of that fraction, almost 80% use hearing aids. Approximately 500 million people worldwide suffer from hearing loss.

Compatibility Tests Involved:

The standard calls for wireless communications devices to be measured for:

- RF Electric-field emissions
- RF Magnetic-field emissions
- T-coil mode, magnetic-signal strength in the audio band
- T-coil mode, magnetic-signal frequency response through the audio band
- T-coil mode, magnetic-signal and noise articulation index

The hearing aid must be measured for:



- RF immunity in microphone mode
- RF immunity in T-coil mode

In the following tests and results, this report includes the evaluation for a wireless communications device.



Figure 1-1 Hearing Aid *in-vitu*

¹ FCC Rule & Order, WT Docket 01-309 RM-8658

FCC ID: A3LSGHZX20	 PCTEST	C63.19-2006 v3.12 §6 HAC TEST REPORT	 SAMSUNG	Reviewed by: Quality Manager
Filename: 0606200529	Test Dates: June 29 - July 3, 2006	EUT Type: Dual-Band GSM/WCDMA Phone with Bluetooth		Page 3 of 37

2. TEST SITE LOCATION

I. Introduction

The map at the right shows the location of the PCTEST LABORATORY in Columbia, Maryland. It is in proximity to the FCC Laboratory, the Baltimore-Washington International (BWI) airport, the city of Baltimore and Washington, DC (See Figure 2-1).

These measurement tests were conducted at the PCTEST Engineering Laboratory, Inc. facility in New Concept Business Park, Guilford Industrial Park, Columbia, Maryland. The site address is 6660-B Dobbin Road, Columbia, MD 21045. The test site is one of the highest points in the Columbia area with an elevation of 390 feet above mean sea level. The site coordinates are 39° 11'15" N latitude and 76° 49' 38" W longitude. The facility is 1.5 miles north of the FCC laboratory, and the ambient signal and ambient signal strength are approximately equal to those of the FCC laboratory. There are no FM or TV transmitters within 15 miles of the site. The detailed description of the measurement facility was found to be in compliance with the requirements of § 2.948 according to ANSI C63.4-2003 on January 27, 2006 and Industry Canada.





Figure 2-1
Map of the Greater Baltimore and Metropolitan Washington, D.C. Area

II. Test Facility / A2LA Accreditation:

Measurements were performed at an independent accredited PCTEST Engineering Lab located in Columbia, MD 21045, U.S.A.



- PCTEST facility is an FCC registered (PCTEST Reg. No. 90864) test facility with the site description report on file and has met all the requirements specified in Section 2.948 of the FCC Rules and Industry Canada (IC 2451).
- PCTEST Lab is accredited to ISO 17025 by U.S. National Institute of Standards and Technology (NIST) under the National Voluntary Laboratory Accreditation Program (NVLAP Lab code: 100431-0) in EMC, FCC and Telecommunications.
- PCTEST Lab is accredited to ISO 17025 by the American Association for Laboratory Accreditation (A2LA) in Specific Absorption Rate (SAR) testing, CTIA Test Plans, and wireless testing for FCC, Hearing-Aid Compatibility (HAC), CTIA OTA and Industry Canada Rules.
- PCTEST Lab is a recognized U.S. Conformity Assessment Body (CAB) in EMC and R&TTE (n.b. 0982) under the U.S.-EU Mutual Recognition Agreement (MRA).
- PCTEST TCB is a Telecommunication Certification Body (TCB) accredited to ISO/IEC Guide 65 by the American National Standards Institute (ANSI) in all scopes of FCC Rules and Industry Canada Standards (RSS).
- PCTEST facility is an IC registered (IC-2451) test laboratory with the site description on file at Industry Canada.
- PCTEST is a CTIA Authorized Test Laboratory (CATL) in AMPS and CDMA mobile phones.

FCC ID: A3LSGHZX20		C63.19-2006 v3.12 §6 HAC TEST REPORT		Reviewed by: Quality Manager
Filename: 0606200529	Test Dates: June 29 - July 3, 2006	EUT Type: Dual-Band GSM/WCDMA Phone with Bluetooth	Page 4 of 37	

3. EUT DESCRIPTION



FCC ID: A3LSGHZX20
Manufacturer: Samsung Electronics, Co. Ltd.
 18600 Broadwick St.
 Rancho Dominguez, CA 90220 USA
 United States
Trade Name: Samsung
Model(s): SGH-ZX20
Serial Number: FD-091-E
Tx Frequencies: 824.20 - 848.80 MHz (Cellular GSM)
 1850.20 - 1909.80 MHz (GSM PCS)
 826.40 - 846.60 MHz (Cellular WCDMA)
 1852.4 - 1907.6 MHz (PCS WCDMA)
HW Version: FD-091-E
SW Version: ZX20TUCFE3
Maximum Conducted Power (EMC/SAR): 32 dBm (GSM850), 29.4 dBm (GSM PCS), 23.7 dBm (WCDMA850), 22.9 dBm (WCDMA PCS)
Maximum Conducted Power (HAC): 32.5 dBm (GSM850), 29.8 dBm (GSM PCS), 23.5 dBm (WCDMA850), 23.4 dBm (WCDMA PCS)
HAC Test Configurations: GSM850, 128, 190, 251, BT Off
 PCS GSM, 512, 661, 810, BT Off
 WCDMA 850, 4132, 4175, 4233, BT Off
 WCDMA PCS, 9262, 9400, 9538, BT Off
FCC Classification: Licensed Transmitter Held to Ear (PCE)
EUT Type: Dual-Band GSM/WCDMA Phone with Bluetooth
Antenna: Fixed Antenna

		HSDPA Inactive		HSDPA Active					
UMTS	Channel	12.2 kbps RMC	12.2 kbps AMR	12.2 kbps RMC	12.2 kbps RMC	GSM	Channel	Max Power (dBm)	
	4132	23.44	23.39	23.30	23.25		128	32.5	
	4175	22.41	22.70	23.30	22.70		190	32.5	
	4233	23.30	23.30	23.21	23.20		251	32.4	
PCS	9262	23.48	23.50	23.40	23.45	PCS	512	29.7	
	9400	23.60	23.60	23.50	23.55		661	29.8	
	9538	23.37	23.56	23.33	23.50		810	29.5	

FCC ID: A3LSGHZX20		C63.19-2006 v3.12 §6 HAC TEST REPORT		Reviewed by: Quality Manager
Filename: 0606200529	Test Dates: June 29 - July 3, 2006	EUT Type: Dual-Band GSM/WCDMA Phone with Bluetooth		Page 5 of 37

4. ANSI/IEEE C63.19 PERFORMANCE CATEGORIES



I. RF EMISSIONS

The ANSI Standard presents performance requirements for acceptable interoperability of hearing aids with wireless communications devices. When these parameters are met, a hearing aid operates acceptably in close proximity to a wireless communications device.

Category	Telephone RF Parameters	
Near field Category	E-field emissions CW dB(V/m)	H-field emissions CW dB(A/m)
f < 960 MHz		
M1	56 to 61 + 0.5 x AWF	5.6 to 10.6 +0.5 x AWF
M2	51 to 56 + 0.5 x AWF	0.6 to 5.6 +0.5 x AWF
M3	46 to 51 + 0.5 x AWF	-4.4 to 0.6 +0.5 x AWF
M4	< 46 + 0.5 x AWF	< -4.4 + 0.5 x AWF
f > 960 MHz		
M1	46 to 51 + 0.5 x AWF	-4.4 to 0.6 +0.5 x AWF
M2	41 to 46 + 0.5 x AWF	-9.4 to -4.4 +0.5 x AWF
M3	36 to 41 + 0.5 x AWF	-14.4 to -9.4 +0.5 x AWF
M4	< 36 + 0.5 x AWF	< -14.4 + 0.5 x AWF
Table 4-1 Hearing aid and WD near-field categories as defined in ANSI C63.19-2006 v3.12 [2]		

II. ARTICULATION WEIGHTING FACTOR (AWF)

Standard	Technology	Articulation Weighing Factor (AWF)
T1/T1P1/3GPP	UMTS (WCDMA)	0
IS-95	CDMA	0
iDEN™	TDMA (22 and 11 Hz)	0
J-STD-007	GSM (217 Hz)	-5
<p>Table 6.2</p> <p>AWF has been developed from information presented to the committee regarding the interference potential of the various modulation types according to ANSI C63.19</p>		

FCC ID: A3LSGHZX20	 PCTEST	C63.19-2006 v3.12 §6 HAC TEST REPORT	 SAMSUNG	Reviewed by: Quality Manager
Filename: 0606200529	Test Dates: June 29 - July 3, 2006	EUT Type: Dual-Band GSM/WCDMA Phone with Bluetooth	Page 6 of 37	

III. MAGNETIC COUPLING

Axial Field Intensity

The axial component of the magnetic field, directed along the measurement axis and located at the measurement plane, shall be $\geq -13\text{dB(A/m)}$ at 1 kHz.

Radial Field Intensity

The radial components of the magnetic field, in the horizontal and vertical position along the measurement plane shall be both $\geq -18\text{dB(A/m)}$ at 1 kHz.

Frequency Response

The frequency response of the axial component of the magnetic field shall follow the response curve specified in EIA RS-504-1983, over the frequency range 300 Hz – 3300 Hz

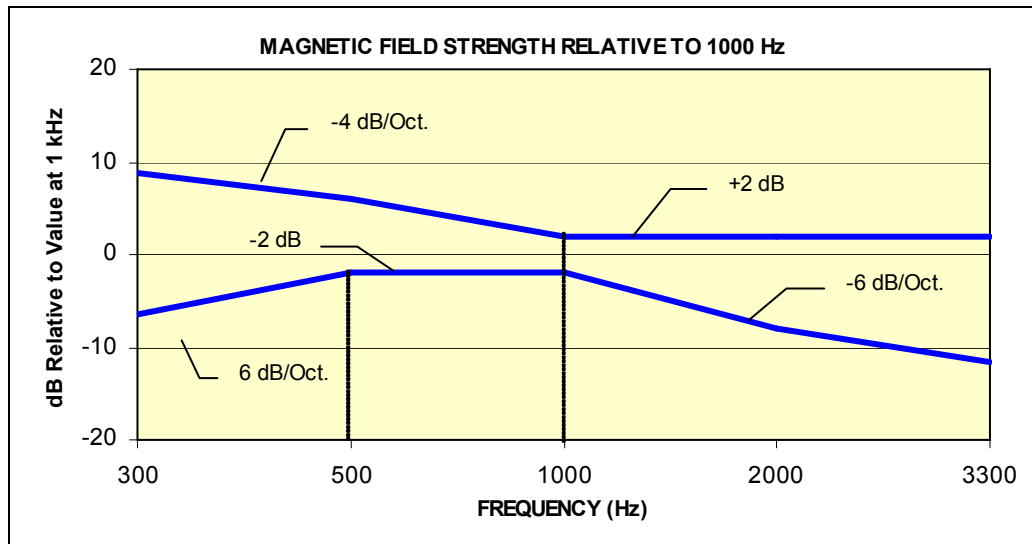



Figure 4-1
Magnetic field frequency response for Wireless Devices with an axial field between -10 dB to -13 dB (A/m) at 1 kHz

FCC ID: A3LSGHZX20	 PCTEST	C63.19-2006 v3.12 §6 HAC TEST REPORT	 SAMSUNG	Reviewed by: Quality Manager
Filename: 0606200529	Test Dates: June 29 - July 3, 2006	EUT Type: Dual-Band GSM/WCDMA Phone with Bluetooth		Page 7 of 37

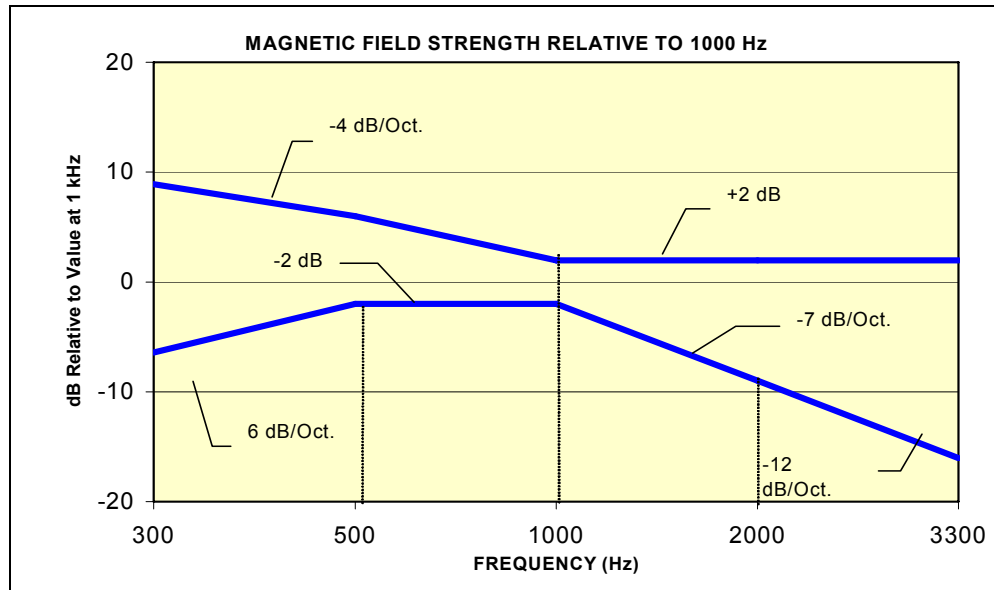

Figure 4-2
Magnetic Field frequency response for wireless devices with an axial field that exceeds -10 dB(A/m) at 1 kHz

Signal Quality

The table below provides the signal quality requirement for the intended audio magnetic signal from a wireless device. Only the RF immunity of the hearing aid is measured in T-coil mode. It is assumed that a hearing aid can have no immunity to an interference signal in the audio band, which is the intended reception band for this mode. The only criterion that can be measured is the RF immunity in T-coil mode. This is measured using the same procedure as the audio coupling mode at the same levels.

The signal quality of the axial and radial components of the magnetic field was used to determine the T-coil mode category.

A device is classified beginning with its RF emissions category (i.e. M1 through M4). If the device meets the additional requirements here, it qualifies for the T-designation (T1, etc.)

Category	Hearing aid RF Parameters	Telephone RF Parameters
	Near field immunity (w/ 0.6W CW into dipole)	Wireless Device Signal Quality (Signal + Noise-to-noise ratio in dB)
T1	75 to 85 dB (IRIL)	-10 to -20 dB + AWF
T2	65 to 75 dB (IRIL)	0 to -10 dB + AWF
T3	55 to 65 dB (IRIL)	10 to 0 dB + AWF
T4	< 55 dB (IRIL)	> 10 dB + AWF

Table 4-2 Magnetic Coupling Parameters

FCC ID: A3LSGHZX20	PCTEST	C63.19-2006 v3.12 §6 HAC TEST REPORT	SAMSUNG	Reviewed by: Quality Manager
Filename: 0606200529	Test Dates: June 29 - July 3, 2006	EUT Type: Dual-Band GSM/WCDMA Phone with Bluetooth		Page 8 of 37

5. METHOD OF MEASUREMENT

I. Test Setup

The equipment was connected as shown in an acoustic/RF hemi-anechoic chamber:

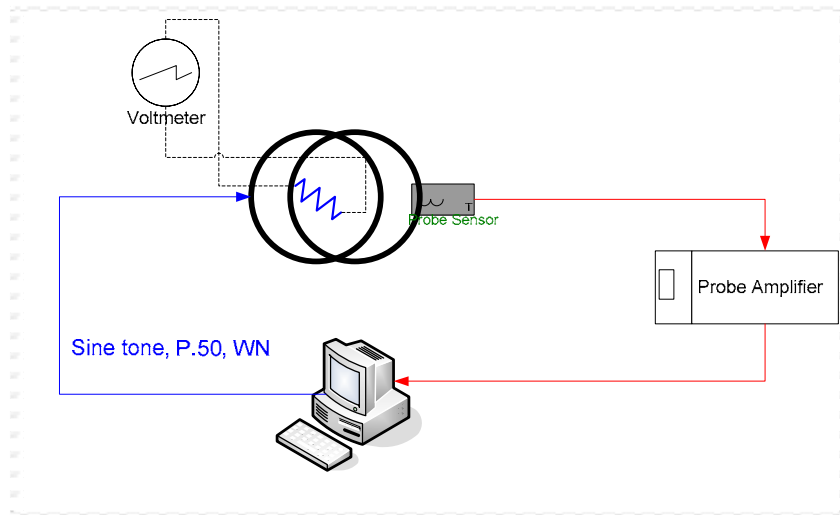

Figure 5-1 Validation Setup with Helmholtz Coil

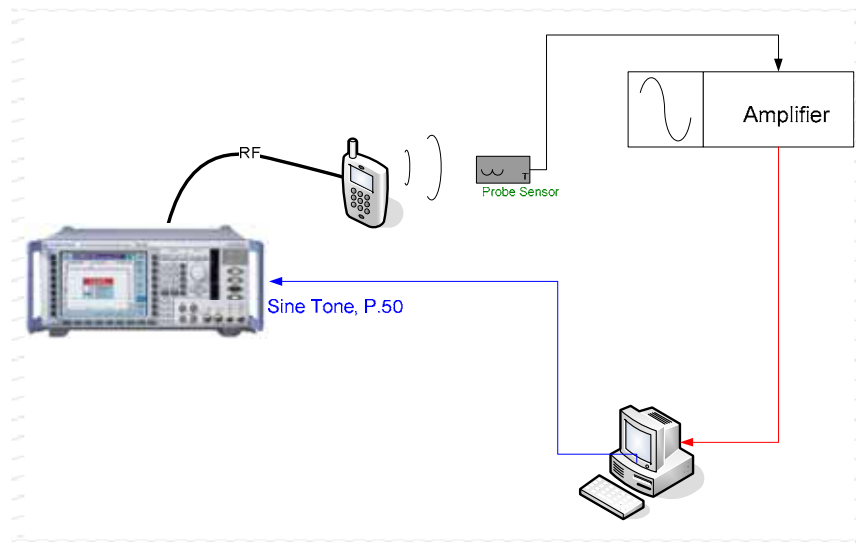



Figure 5-2 T-Coil Test Setup

FCC ID: A3LSGHZX20	 PCTEST	C63.19-2006 v3.12 §6 HAC TEST REPORT	 SAMSUNG	Reviewed by: Quality Manager
Filename: 0606200529	Test Dates: June 29 - July 3, 2006	EUT Type: Dual-Band GSM/WCDMA Phone with Bluetooth		Page 9 of 37

II. Scanning Mechanism

Manufacturer: TEM
 Accuracy: ± 0.83 cm/meter
 Minimum Step Size: 0.1 mm
 Maximum speed: 6.1 cm/sec
 Line Voltage: 115 VAC
 Line Frequency: 60 Hz
 Material Composite: Delrin (Acetal)
 Data Control: Parallel Port
 Dynamic Range (X-Y-Z): 45 x 31.75 x 47 cm
 Dimensions: 36" x 25" x 38"
 Operating Area: 36" x 49" x 55"
 Reflections: < -20 dB (in anechoic chamber)

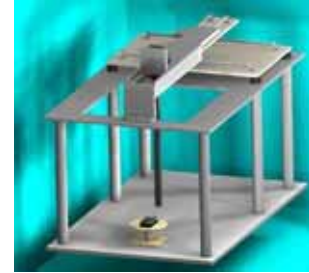

Figure 5-3
RF Near-Field Scanner

III. ITU-T P.50 Artificial Voice

Manufacturer: ITU-T
 Active Frequency Range: 100 Hz – 8 kHz
 Stimulus Type: Male and Female, no spaces
 Single Sample Duration: 20.96 seconds
 Activity Level: 100%

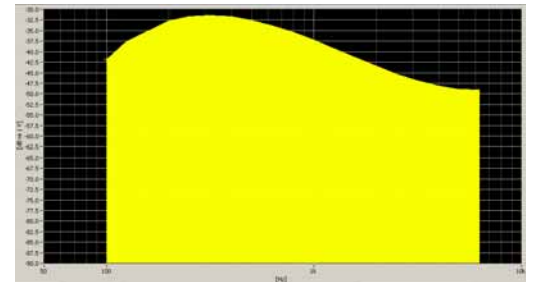

Figure 5-4
Spectral Characteristic of full P.50

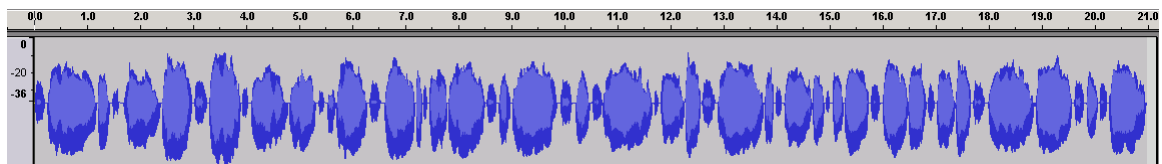

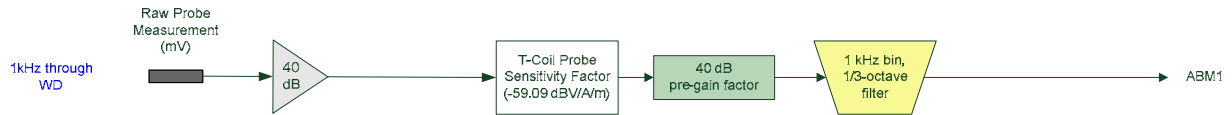

Figure 5-5
Temporal Characteristic of full P.50

FCC ID: A3LSGHZX20		C63.19-2006 v3.12 §6 HAC TEST REPORT		Reviewed by: Quality Manager
Filename: 0606200529	Test Dates: June 29 - July 3, 2006	EUT Type: Dual-Band GSM/WCDMA Phone with Bluetooth	Page 10 of 37	

ABM1 Measurement Block Diagram:



ABM2 Measurement Block Diagram:

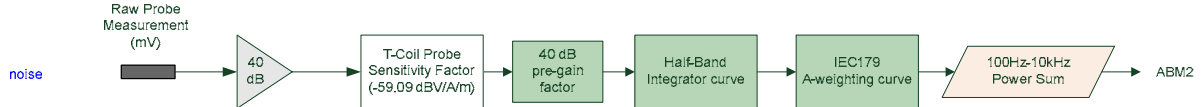

Figure 5-6 Magnetic Measurement Processing Steps

IV. Test Procedure

1. Ambient Noise Check per C63.19 §6.2.1
 - a. Ambient interference was monitored using a Real-Time Analyzer between 100-10,000 Hz with 1/3 octave filtering.
 - b. “A-weighting” and Half-Band Integration was applied to the measurements.
 - c. Since this measurement was measured in the same method as ABM2 measurements, this level was verified to be less than 10 dB below the lowest measurement signal (which is the highest ABM2 measurement for a T4 WD). Therefore the maximum noise level for a T4 WD with an ABM1 = -18 dBA/m is:

$$-18 - 10 - 10 + AWF = -43 \text{ dBA/m}$$

2. Measurement System Validation (See Figure 5-1)
 - a. The measurement system including the probe, pre-amplifier and acquisition system were validated as an entire system to ensure the reliability of test measurements.
 - b. ABM1 Validation
The magnetic field at the center of the Helmholtz coil is given by the equation (per C63.19 Annex D.9.1):



$$H_c = \frac{NI}{r\sqrt{1.25^3}} = \frac{N\left(\frac{V}{R}\right)}{r\sqrt{1.25^3}}$$

Where H_c = magnetic field strength in amperes per meter
 N = number of turns per coil

For the Helmholtz Coil, $N=20$; $r=0.08\text{m}$; $R=10.193\Omega$ and using $V=57\text{mV}$:

$$H_c = \frac{20 \cdot \left(\frac{0.057}{10.193}\right)}{0.08 \cdot \sqrt{1.25^3}} = 1.0003 \text{ A/m}$$

Therefore a pure tone of 1kHz was applied into the coils such that 57 mV was observed across the 10 Ω resistor. The voltmeter used for measurement was verified to be capable of measurements in the audio band range. This theoretically generates an expected field of 1 A/m in the center of the Helmholtz coil which was used to validate the probe measurement at 1 A/m. This was verified to be within ± 0.5 dB of the 1 A/m value (see Page 20).

FCC ID: A3LSGHZX20		C63.19-2006 v3.12 §6 HAC TEST REPORT		Reviewed by: Quality Manager
Filename: 0606200529	Test Dates: June 29 - July 3, 2006	EUT Type: Dual-Band GSM/WCDMA Phone with Bluetooth		Page 11 of 37

c. Frequency Response Validation

The frequency response through the Helmholtz Coil was verified to be within 0.5 dB relative to 1 kHz, between 300 – 3300 Hz using the ITU-P.50 artificial speech signal as shown below:

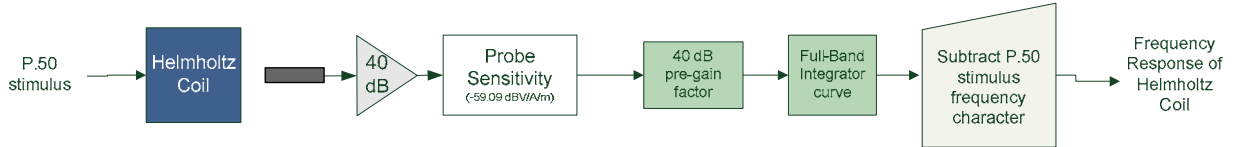

Figure 5-7 Frequency Response Validation

d. ABM2 Measurement Validation

WD noise measurements are filtered with A-weighting and Half-Band Integration over a frequency range of 100Hz – 10kHz to process ABM2 measurements. Below is the verification of the system processing A-weighting and Half-Band integration between system input to output within 0.5 dB of the theoretical result:

**Table 5-1
ABM2 Frequency Response Validation**

f (Hz)	HBI, A - Measured (dB re 1kHz)	HBI, A - Theoretical (dB re 1kHz)	dB Var.
100	-16.180	-16.170	-0.010
125	-13.257	-13.250	-0.007
160	-10.347	-10.340	-0.007
200	-8.017	-8.010	-0.007
250	-5.925	-5.920	-0.005
315	-4.045	-4.040	-0.005
400	-2.405	-2.400	-0.005
500	-1.212	-1.210	-0.002
630	-0.349	-0.350	0.001
800	0.071	0.070	0.001
1000	0.000	0.000	0.000
1250	-0.503	-0.500	-0.003
1600	-1.513	-1.510	-0.003
2000	-2.778	-2.780	0.002
2500	-4.316	-4.320	0.004
3150	-6.166	-6.170	0.004
4000	-8.322	-8.330	0.008
5000	-10.573	-10.590	0.017
6300	-13.178	-13.200	0.022
8000	-16.241	-16.270	0.029
10000	-19.495	-19.520	0.025

FCC ID: A3LSGHZX20	PCTEST	C63.19-2006 v3.12 §6 HAC TEST REPORT	SAMSUNG	Reviewed by: Quality Manager
Filename: 0606200529	Test Dates: June 29 - July 3, 2006	EUT Type: Dual-Band GSM/WCDMA Phone with Bluetooth		Page 12 of 37

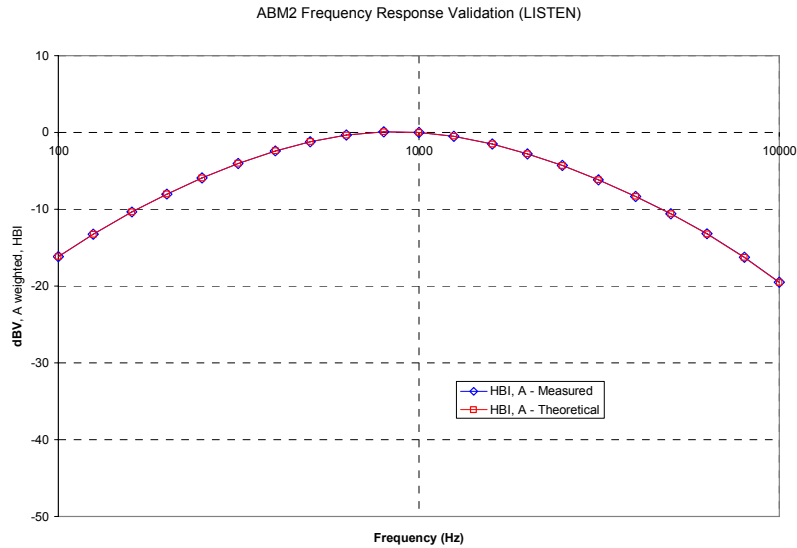

Figure 5-8
ABM2 Frequency Response Validation

The ABM2 result is a power sum from 100 Hz to 10 kHz with half-band integration and A-weighting. To verify the power sum measurement, a power sum over the full band was measured and verified to track with the source level (See Figure 5-9). Therefore the setup in this step was used to verify the power sum post-processing for ABM2 measurements. See below block diagram:

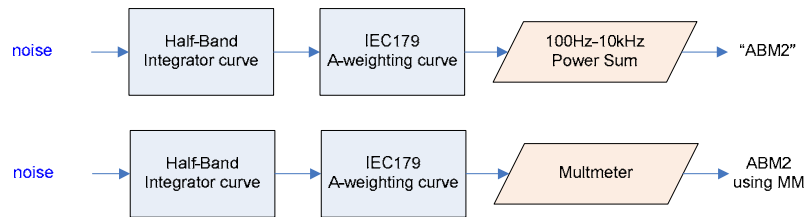

Figure 5-9
ABM2 Validation Block Diagram

The power summed output results for a known input were compared to the multi-meter results to verify any deviation in the post-processing implemented with the power-sum.

Table 5-2
ABM2 Power Sum Validation

WN Input (dBV)	Power Sum (dBV)	Multimeter-Full (dBV)	Dev (dB)
-60	-60.36	-60.2	0.16
-50	-50.19	-50.13	0.06
-40	-40.14	-40.03	0.11
-30	-30.13	-30.01	0.12
-20	-20.12	-20	0.12
-10	-10.14	-10	0.14

FCC ID: A3LSGHZX20		C63.19-2006 v3.12 §6 HAC TEST REPORT		Reviewed by: Quality Manager
Filename: 0606200529	Test Dates: June 29 - July 3, 2006	EUT Type: Dual-Band GSM/WCDMA Phone with Bluetooth		Page 13 of 37

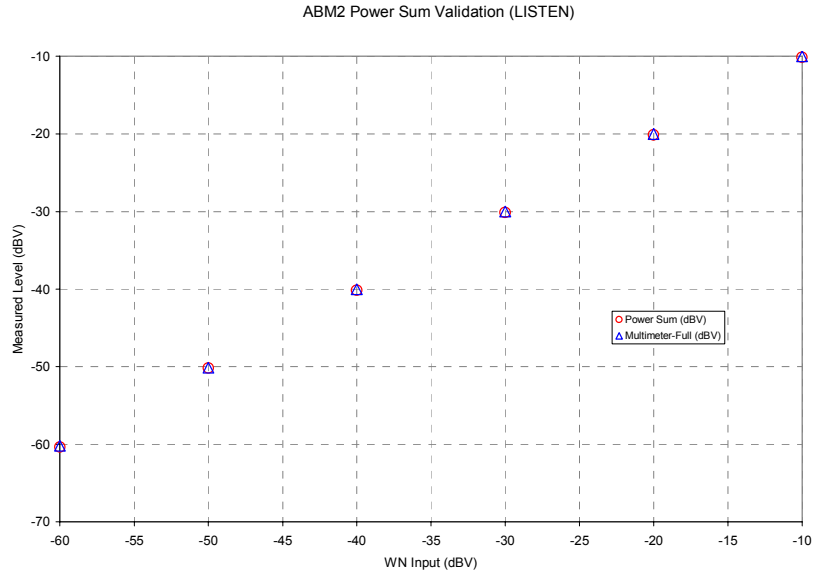

Figure 5-10
ABM2 Power Sum Validation

3. Measurement Test Setup

a. Fine scan above the WD (TEM)

- i. A 1 kHz tone was applied to the handset at the acoustic output level at the C63.19 specified levels (below). The measurement step size was in 2 mm increments at a distance of 10 mm between the surface of the wireless device as shown below:

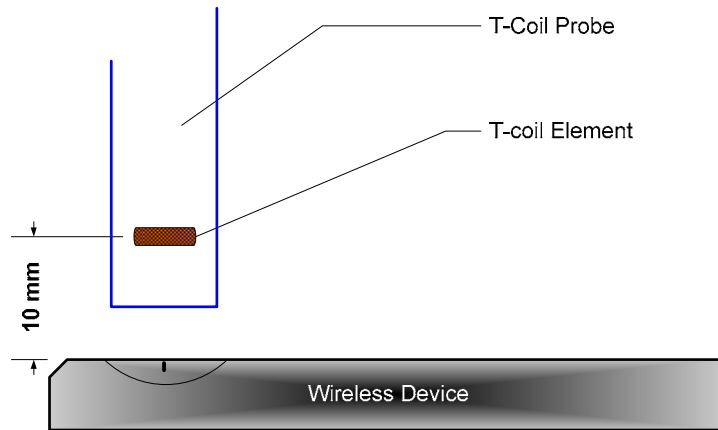

Figure 5-11
Measurement Distance

- ii. After scanning, the planar field maximum point was determined. The position of the probe was moved to this location to setup the test using the sound check system.
- iii. These steps were repeated for the other T-coil orientations (of axial, radial transverse, or radial longitudinal) per Figure 5-16 after a T-coil orientation was fully measured with the sound check system.

FCC ID: A3LSGHZX20	PCTEST	C63.19-2006 v3.12 §6 HAC TEST REPORT	SAMSUNG	Reviewed by: Quality Manager
Filename: 0606200529	Test Dates: June 29 - July 3, 2006	EUT Type: Dual-Band GSM/WCDMA Phone with Bluetooth	Page 14 of 37	

- b. Speech Signal Setup to Base Station Simulator
 - i. C63.19 Table 6-1 states audio reference input levels for various technologies:

Standard	Technology	Input Level (dBm0)
TIA/EIA/IS 2000	CDMA	-18
J-STD-007	GSM (217)	-16
T1/T1P1/3GPP	UMTS (WCDMA)	-16
iDEN™	TDMA (22 and 11 Hz)	-18

The CMU200 audio levels were determined using base station simulator manufacturer calibration procedures resulting in the below corresponding voltages relative to handset test point level (in dBm0):

**Table 5-3
CMU200 Voltage Input Levels for Audio**



dBm0 Ref.	Voltage		Notes
3.14 dBm0	1068.5 mV	0.58 dBV	From UMTS "DECODER CAL". (What is needed through Encoder for FS)
-16 dBm0	118.0 mV	-18.6 dBV	For Handset Low

- c. Real-Time Analyzer (RTA)
 - i. The Real-Time Analyzer was configured to analyze measurements using 1/3 Octave band weighted filtering.
- d. WD Radio Configuration Selection
 - i. The device was chosen to be tested in the worst-case ABM2 condition under EFR (GSM), AMR 12.2k (WCDMA) at the maxima signal location (see below):



**Figure 5-12
Vocoder Analysis for ABM Noise**

- 4. Signal Quality Data Analysis
 - a. Narrow-band Magnetic Intensity
 - i. The standard specifies a 1 kHz 1/3 octave band minimum field intensity for a sine tone. The ABM1 measurements were evaluated at 1kHz with 1/3 octave band filtering over an averaged period of 10 seconds.
 - b. Frequency Response

FCC ID: A3LSGHZX20		C63.19-2006 v3.12 §6 HAC TEST REPORT		Reviewed by: Quality Manager
Filename: 0606200529	Test Dates: June 29 - July 3, 2006	EUT Type: Dual-Band GSM/WCDMA Phone with Bluetooth		Page 15 of 37

- i. The appropriate frequency response curve was measured to curves in Figure 4-1 or Figure 4-2 between 300 – 3300 Hz using digital linear averaging (limit lines chosen according to measurement found in step 4a.) A linear average over 3x the length of the artificial voice signal (3x sampling) was performed. A 10 second delay was configured in the measurement process of the stimulus to ensure handset vocoder latency effects and echo cancellation devices (if any) were appropriately stabilized during measurements.
- ii. The appropriate post-processing was applied according to the system processing chain illustrated in Figure 5-13. All R10 frequencies were plotted with respect to 0dB at 1 kHz value and aligned with respect to the EIA-504 mask.

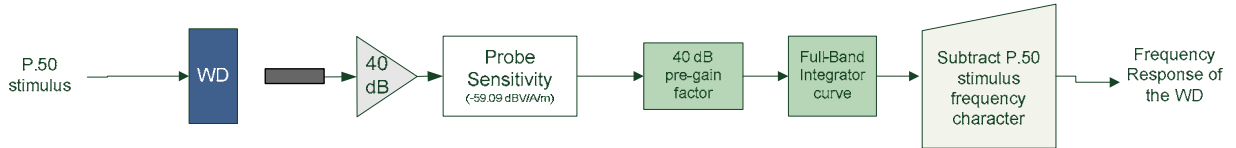

Figure 5-13 Frequency Response Block Diagram

- iii. The margin is represented by the closest measured data point on the curve to the EIA-504 limit lines, in dB.
- c. Signal Quality Index
 - i. Ensuring the WD was at maximum RF power, maximum volume, backlight on, display on, maximum contrast setting, keypad lights on (when possible) with no audio signal through the vocoder, the WD was measured over at least 100 Hz – 10,000 Hz, maximized over 5 seconds with a 50ms sample time for the ABM2 measurement (5 second time period is used in noise measurements according to acoustic standards such as IEEE 269, etc.)
 - ii. After applying half-band integration and A-weighting to the result, a power sum was applied over each 1/3 octave bandwidth frequency for an ABM2 value
 - iii. This result was subtracted from the ABM1 result in step a, to obtain the Signal Quality.

V. Test Setup

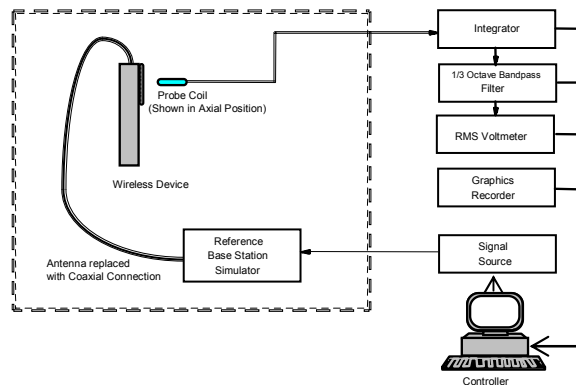

Figure 5-14 Audio Magnetic Field Test Setup

VI. Deviation from C63.19 Test Procedure

Scan increments at 2mm; radiated

FCC ID: A3LSGHZX20		C63.19-2006 v3.12 §6 HAC TEST REPORT		Reviewed by: Quality Manager
Filename: 0606200529	Test Dates: June 29 - July 3, 2006	EUT Type: Dual-Band GSM/WCDMA Phone with Bluetooth		Page 16 of 37

VII. Wireless Device Channels and Frequencies

The frequencies listed in the table below are those that lie in the center of the bands used for cellular telephony. Low, middle and high channels were tested in each band for FCC compliance evaluation to ensure the maximum emission is captured across the entire band.

To facilitate setting of a base station simulator for ABM measurements, specific band plan channel numbers are listed that may be used in lieu of the band center frequencies.

**Table 5-4
Center Channels and Frequencies**

Test frequencies & associated channels	
Channel	Frequency (MHz)
Cellular 850	
384 (CDMA)	836.52
UARFCN 4175 (UMTS)	835.00
190 (GSM)	836.60
PCS 1900	
661 (GSM)	1880
600 (CDMA)	1880
UARFCN 9400 (UMTS)	1880

VIII. RF Emission Effect on T-coil Measurements

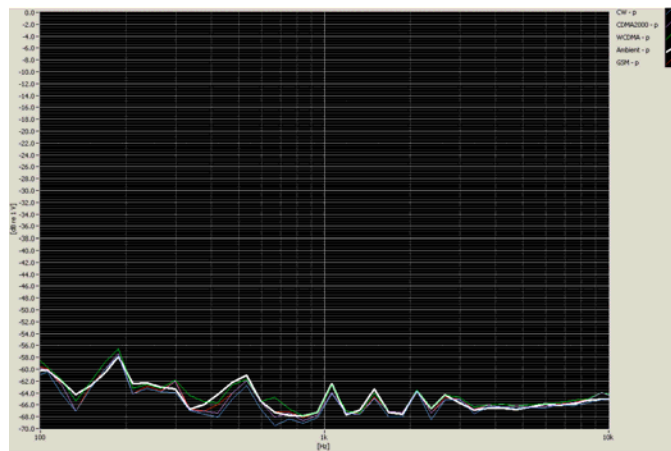



Figure 5-15

High power RF Emissions Effect with HAC Dipole on the T-coil Probe System

FCC ID: A3LSGHZX20	 PCTEST	C63.19-2006 v3.12 §6 HAC TEST REPORT	 SAMSUNG	Reviewed by: Quality Manager
Filename: 0606200529	Test Dates: June 29 - July 3, 2006	EUT Type: Dual-Band GSM/WCDMA Phone with Bluetooth	Page 17 of 37	

IX. Test Flow

The flow diagram below was followed (From C63.19):

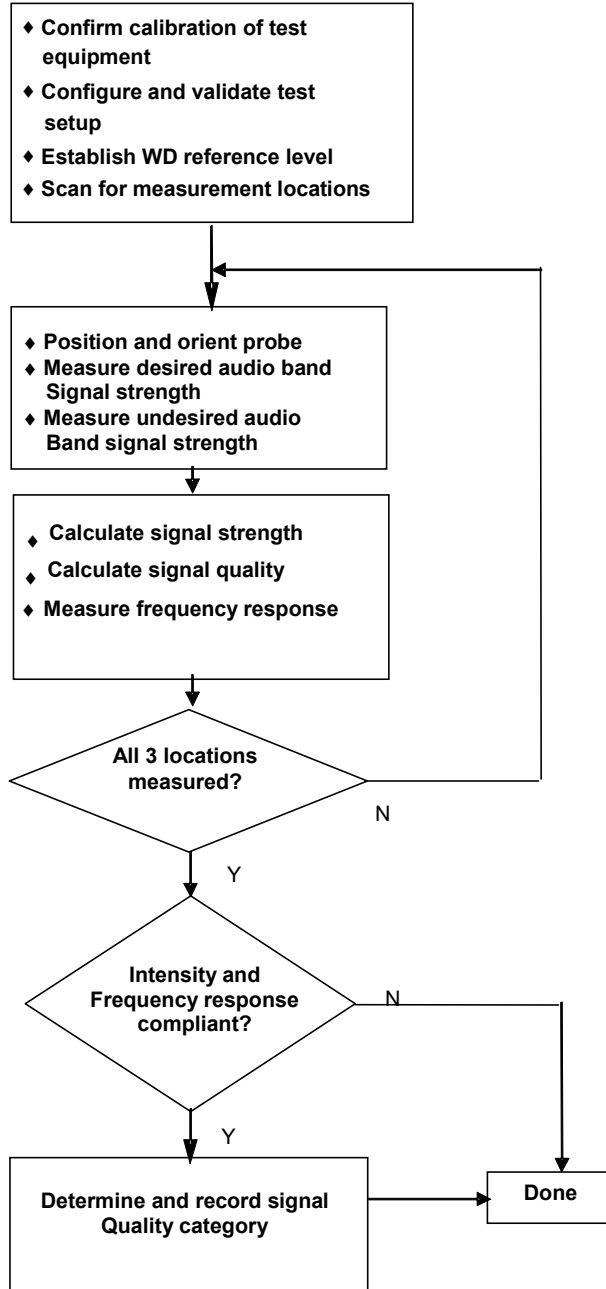



Figure 5-16
C63.19 T-Coil Signal Test Process

FCC ID: A3LSGHZX20	 PCTEST	C63.19-2006 v3.12 §6 HAC TEST REPORT	 SAMSUNG	Reviewed by: Quality Manager
Filename: 0606200529	Test Dates: June 29 - July 3, 2006	EUT Type: Dual-Band GSM/WCDMA Phone with Bluetooth		Page 18 of 37

6. TEST SUMMARY

I. T-Coil Test Summary

GSM Mode



Table 6-1
Table of Results for GSM

C63.19 Sec.	Band	Test Description	Minimum Limit*	Measured	Verdict
			<i>dBa/m</i>	<i>dBa/m</i>	<i>PASS/FAIL</i>
7.3.1.1	Cellular	Intensity, Axial	-13	0.5	PASS
7.3.1.2		Intensity, RadialH	-18	-9.3	PASS
7.3.1.2		Intensity, RadialV	-18	-9.5	PASS
7.3.3		Signal-to-Noise/Noise, Axial	5	35.8	PASS
7.3.3		Signal-to-Noise/Noise, RadialH	5	37.4	PASS
7.3.3		Signal-to-Noise/Noise, RadialV	5	29.3	PASS
7.3.2		Frequency Response, Axial	0	2.0	PASS
7.3.1.1	PCS	Intensity, Axial	-13	0.5	PASS
7.3.1.2		Intensity, RadialH	-18	-9.3	PASS
7.3.1.2		Intensity, RadialV	-18	-9.9	PASS
7.3.3		Signal-to-Noise/Noise, Axial	5	39.0	PASS
7.3.3		Signal-to-Noise/Noise, RadialH	5	37.9	PASS
7.3.3		Signal-to-Noise/Noise, RadialV	5	29.3	PASS
7.3.2		Frequency Response, Axial	0	2.0	PASS

UMTS Mode

Table 6-2
Table of Results for UMTS

C63.19 Sec.	Band	Test Description	Minimum Limit*	Measured	Verdict
			<i>dBa/m</i>	<i>dBa/m</i>	<i>PASS/FAIL</i>
7.3.1.1	Cellular	Intensity, Axial	-13	0.1	PASS
7.3.1.2		Intensity, RadialH	-18	-9.3	PASS
7.3.1.2		Intensity, RadialV	-18	-9.3	PASS
7.3.3		Signal-to-Noise/Noise, Axial	0	46.8	PASS
7.3.3		Signal-to-Noise/Noise, RadialH	0	40.7	PASS
7.3.3		Signal-to-Noise/Noise, RadialV	0	42.2	PASS
7.3.2		Frequency Response, Axial	0	2.0	PASS
7.3.1.1	PCS	Intensity, Axial	-13	0.1	PASS
7.3.1.2		Intensity, RadialH	-18	-9.3	PASS
7.3.1.2		Intensity, RadialV	-18	-9.4	PASS
7.3.3		Signal-to-Noise/Noise, Axial	0	46.9	PASS
7.3.3		Signal-to-Noise/Noise, RadialH	0	40.6	PASS
7.3.3		Signal-to-Noise/Noise, RadialV	0	41.5	PASS
7.3.2		Frequency Response, Axial	0	2.0	PASS

FCC ID: A3LSGHZX20		C63.19-2006 v3.12 §6 HAC TEST REPORT		Reviewed by: Quality Manager
Filename: 0606200529	Test Dates: June 29 - July 3, 2006	EUT Type: Dual-Band GSM/WCDMA Phone with Bluetooth		Page 19 of 37

**Table 6-3
Consolidated Tabled Results with Rating**

	Volume Setting	Cellular			PCS		
		Axial	RadialH	RadialV	Axial	RadialH	RadialV
Freq. Response Margin	Maximum	PASS	PASS	PASS	PASS	PASS	PASS
Magnetic Intensity Verdict		PASS	PASS	PASS	PASS	PASS	PASS
FCC SNR Verdict		PASS	PASS	PASS	PASS	PASS	PASS

Note: Radial Orientation for Frequency Response not required for rating category determination. Result shown is for T-coil category only.

II. Raw Handset Data

**Table 6-4
Raw Data Results**

	Volume	Cellular Band								
		Axial			RadialH			RadialV		
		128	190	251	128	190	251	128	190	251
Freq. Response Margin (dB)	Maximum	1.92	1.93	1.91	1.92	1.90	1.91	1.90	1.93	1.90
ABM1, dBA/m		0.49	0.49	0.48	-6.09	-6.10	-6.09	-6.56	-6.56	-6.57
ABM2, dBA/m		-34.63	-35.05	-35.12	-50.66	-50.92	-51.46	-40.01	-40.39	-40.63
S+N/N (dB)		35.12	35.54	35.61	44.57	44.82	45.37	33.45	33.83	34.06
S+N/N per orientation (dB)		35.12			44.57			33.45		
	Volume	PCS Band								
		Axial			RadialH			RadialV		
		512	661	810	512	661	810	512	661	810
Freq. Response Margin (dB)	Maximum	1.95	1.91	1.94	1.91	1.93	1.93	1.91	1.88	1.91
ABM1, dBA/m		0.46	0.49	0.47	-6.09	-6.09	-6.09	-6.55	-6.54	-6.66
ABM2, dBA/m		-34.92	-35.97	-36.19	-50.24	-50.62	-50.79	-39.84	-40.82	-40.98
S+N/N (dB)		35.38	36.45	36.67	44.14	44.53	44.70	33.28	34.28	34.32
S+N/N per orientation (dB)		35.38			44.14			33.28		

	Volume	Cellular Band								
		Axial			RadialH			RadialV		
		4132	4175	4233	4132	4175	4233	4132	4175	4233
Freq. Response Margin (dB)	Maximum	2.00	2.00	2.00	2.00	2.00	2.00	2.00	2.00	2.00
ABM1, dBA/m		0.07	0.06	0.06	-9.23	-8.97	-9.27	-9.32	-9.30	-9.31
ABM2, dBA/m		-46.69	-46.92	-46.86	-49.99	-50.04	-49.93	-51.54	-51.56	-51.47
S+N/N (dB)		46.77	46.99	46.91	40.77	41.07	40.65	42.23	42.26	42.16
S+N/N per orientation (dB)		46.77			40.65			42.16		
	Volume	PCS Band								
		Axial			RadialH			RadialV		
		9262	9400	9538	9262	9400	9538	9262	9400	9538
Freq. Response Margin (dB)	Maximum	2.00	2.00	2.00	2.00	2.00	2.00	2.00	2.00	2.00
ABM1, dBA/m		0.13	0.10	0.07	-9.22	-9.28	-9.27	-9.31	-9.10	-9.37
ABM2, dBA/m		-46.93	-46.97	-46.86	-49.96	-49.92	-49.98	-51.63	-50.57	-51.36
S+N/N (dB)		47.06	47.08	46.93	40.74	40.64	40.71	42.32	41.47	41.98
S+N/N per orientation (dB)		46.93			40.64			41.47		

Test Dates: June 29 - July 3, 2006

Facility: PCTEST Engineering Laboratory, Inc.



Radio Configuration: EFR (GSM), AMR 12.2k (WCDMA)

Power Configuration: PCL=5 (GSM850), PCL=0 (GSM PCS), TPC="All 1" (WCDMA)

Phone Condition: Mute on; Backlight on; Contrast High, Max Volume, T-Coil Mode ON, BT off

III. RF Measurement Details for RT Category Determination

RF Emissions Category (C63.19-2006) within SNR measured location	M3
Signal to Noise Category (C63.19-2006):	T4
RT Category (C63.19-2006):	M3 T3

FCC ID: A3LSGHZX20		C63.19-2006 v3.12 §6 HAC TEST REPORT		Reviewed by: Quality Manager
Filename: 0606200529	Test Dates: June 29 - July 3, 2006	EUT Type: Dual-Band GSM/WCDMA Phone with Bluetooth	Page 21 of 37	

IV. Frequency Response Graph

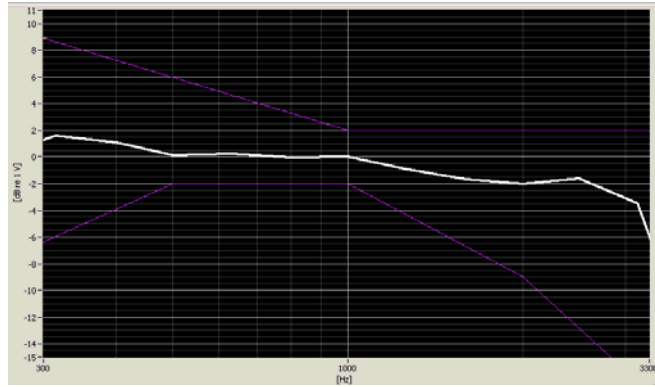
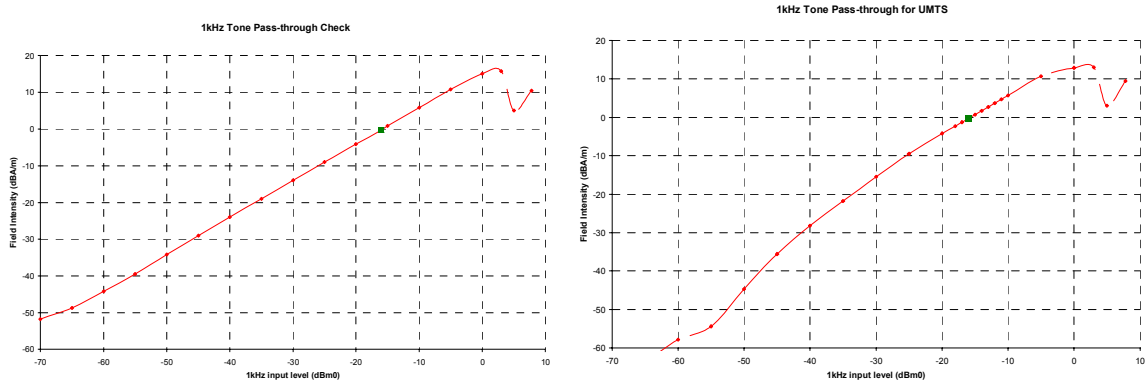

Figure 6-1
Axial Frequency Response

V. 1 kHz Vocoder Application Check



This model was verified to be within the linear region for ABM1 measurements at -16 dBm0.

VI. Undesirable Audio Magnetic Band Plot (ABM2)

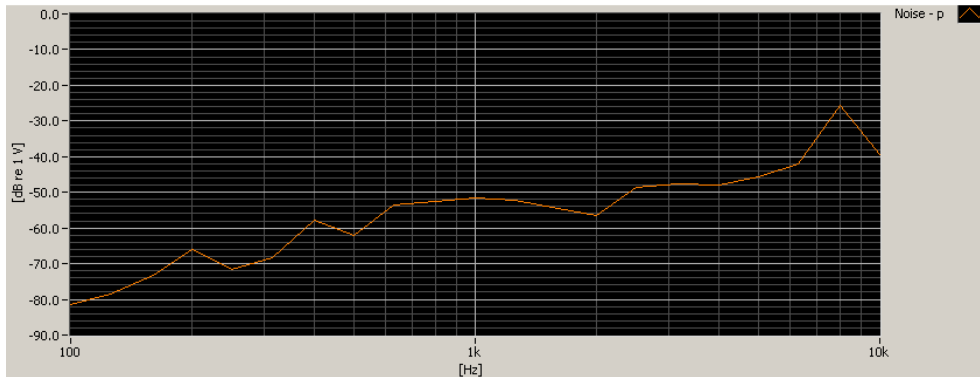



Figure 6-2
Worst-case ABM2 Plot for WD

FCC ID: A3LSGHZX20	 PCTEST	C63.19-2006 v3.12 §6 HAC TEST REPORT	 SAMSUNG	Reviewed by: Quality Manager
Filename: 0606200529	Test Dates: June 29 - July 3, 2006	EUT Type: Dual-Band GSM/WCDMA Phone with Bluetooth		Page 22 of 37

VII. T-Coil Validation Test Results

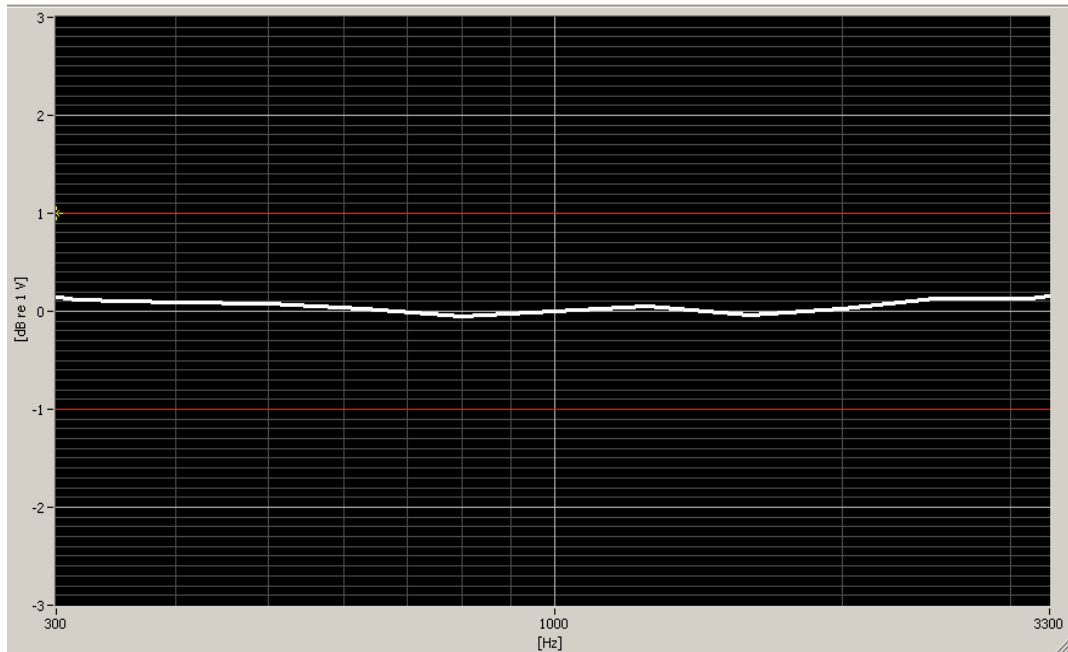



Figure 6-3
Helmholtz Coil Validation for Frequency Response

Table 6-5
Helmholtz Coil Validation Table of Results

Item	Target	Measured dB About Target	Verdict
Signal Validation			
Frequency Response, from limits	$0 \pm 0.5 \text{ dB}$	0.16	PASS
Magnetic Intensity, 0 dBA/m	$0 \pm 0.5 \text{ dB}$	-0.142	PASS
Noise Validation			
Environmental Noise	$< - (38 - \text{AWF})$	-59.23	PASS

FCC ID: A3LSGHZX20	 PCTEST	C63.19-2006 v3.12 §6 HAC TEST REPORT	 SAMSUNG	Reviewed by: Quality Manager
Filename: 0606200529	Test Dates: June 29 - July 3, 2006	EUT Type: Dual-Band GSM/WCDMA Phone with Bluetooth	Page 23 of 37	

7. FCC 3G MEASUREMENTS – JUNE 2006

AMR at 12.2kbps was used for the testing as the worst-case configuration for the handset. See below plot for ABM noise comparison between vocoder rates:

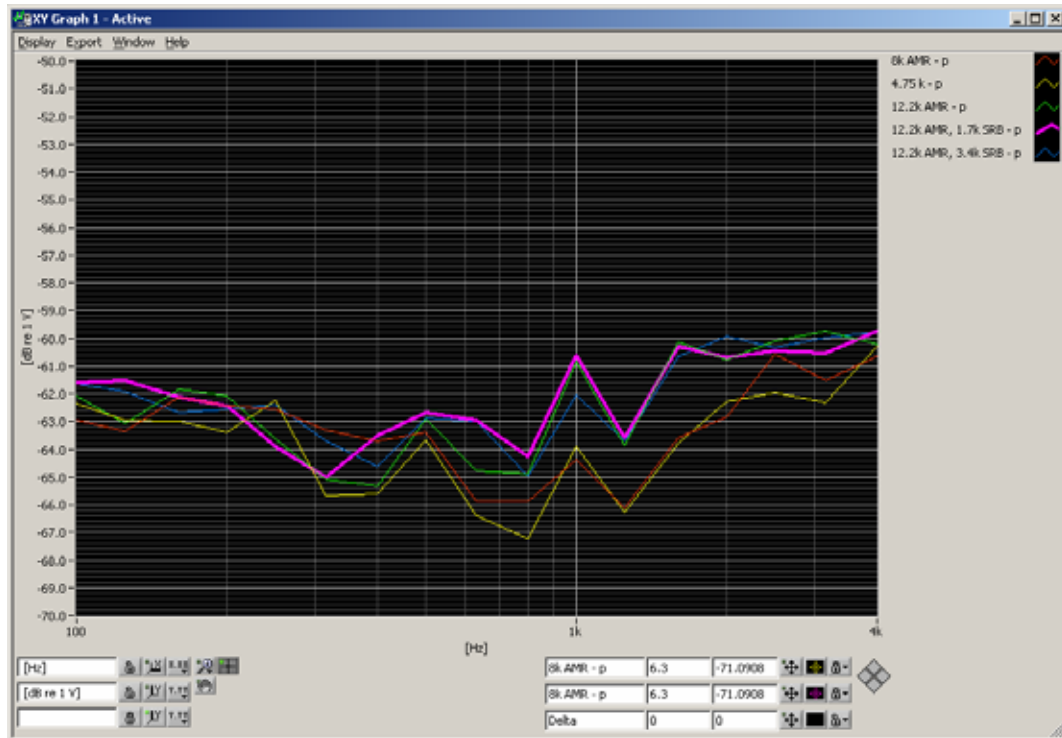

Figure 7-1
WCDMA Audio Band Magnetic Noise

I. Handset Setup Conditions:

- Mute on; Backlight on; Contrast High, Max Volume, T-Coil Mode ON, BT off
- PCL=5 (GSM850), PCL=0 (GSM PCS), TPC="All 1" (WCDMA)



Figure 7-2
Audio Band Magnetic Curve Measurement Block Diagram

FCC ID: A3LSGHZX20	PCTEST	C63.19-2006 v3.12 §6 HAC TEST REPORT	SAMSUNG	Reviewed by: Quality Manager
Filename: 0606200529	Test Dates: June 29 - July 3, 2006	EUT Type: Dual-Band GSM/WCDMA Phone with Bluetooth		Page 24 of 37

8. MEASUREMENT UNCERTAINTY



**Table 8-1
Uncertainty Estimation Table**

Contribution	Data +/- %	Data +/- dB	Data Type	Probability distribution	Divisor	Standard uncertainty	Standard Uncertainty (dB)
ABM Noise	7.0%	0.29	Std. Dev.	Normal k=1	1.00	7.0%	
RF Reflections	4.7%	0.20	Specification	Rectangular	1.73	2.7%	
Reference Signal Level	12.2%	0.50	Specification	Rectangular	1.73	7.0%	
Positioning Accuracy	10.0%	0.41	Uncertainty	Rectangular	1.73	5.8%	
Probe Coil Sensitivity	12.2%	0.50	Specification	Rectangular	1.73	7.0%	
Probe Linearity	2.4%	0.10	Std. Dev.	Normal k=1	1.00	2.4%	
Cable Loss	2.8%	0.12	Specification	Rectangular	1.73	1.6%	
Frequency Analyzer	5.0%	0.21	Specification	Rectangular	1.73	2.9%	
System Repeatability	5.0%	0.21	Std. Dev.	Normal k=1	1.00	5.0%	
WD Repeatability	9.0%	0.37	Std. Dev.	Normal k=1	1.00	9.0%	
Positioner Accuracy	1.0%	0.04	Specification	Rectangular	1.73	0.6%	
Combined standard uncertainty, uc						17.7%	0.71
Expanded uncertainty (k=2), 95% confidence level						35.3%	1.31

Notes:

1. Test equipments are calibrated according to techniques outlined in NIS81, NIS3003 and NIST Tech Note 1297.
2. All equipments have traceability according to NIST. Measurement Uncertainties are defined in further detail in NIS 81 and NIST Tech Note 1297 and UKAS M3003.



Measurement uncertainty reflects the quality and accuracy of a measured result as compared to the true value. Such statements are generally required when stating results of measurements so that it is clear to the intended audience that the results may differ when reproduced by different facilities. Measurement results vary due to the measurement uncertainty of the instrumentation, measurement technique, and test engineer. Most uncertainties are calculated using the tolerances of the instrumentation used in the measurement, the measurement setup variability, and the technique used in performing the test. While not generally included, the variability of the equipment under test also figures into the overall measurement uncertainty. Another component of the overall uncertainty is based on the variability of repeated measurements (so-called Type A uncertainty). This may mean that the Hearing Aid compatibility tests may have to be repeated by taking down the test setup and resetting it up so that there are a statistically significant number of repeat measurements to identify the measurement uncertainty. By combining the repeat measurement results with that of the instrumentation chain using the technique contained in NIS 81 and NIS 3003, the overall measurement uncertainty was estimated.

FCC ID: A3LSGHZX20		C63.19-2006 v3.12 §6 HAC TEST REPORT		Reviewed by: Quality Manager
Filename: 0606200529	Test Dates: June 29 - July 3, 2006	EUT Type: Dual-Band GSM/WCDMA Phone with Bluetooth	Page 25 of 37	



9. EQUIPMENT LIST

Manufacturer	Make / Equipment	Calibration Due	Asset No.
MicroCoax	(1.0-26.5GHz) Microwave Cables	N/A	N/A
HP	8648D (9kHz-4GHz) Signal Generator	-	3613A00315
Rohde & Schwarz	(0.1-1000MHz) Signal Generator	September 2006	894215/012
Narda	3020A (50-1000MHz) Bi-Directional Coax Coupler	-	
HP	34401A Multimeter	June 2007	
NI	4474 Data Acquisition Card	N/A	
HP	437B Power Meter	May 2007	3125U24437
Amplifier Research	5S1G4 (5W, 800MHz-4.2GHz)	-	22322
Gigatronics	80701A (0.05-18GHz) Power Sensor	April 2007	1833460
HP	8482H (30mW-3W) Power Sensor	-	2237A02084
HP	8594A Spectrum Analyzer	-	3051A00187
Gigatronics	8657A Universal Power Meter	April 2007	1835256
HP	8753E (30kHz-6GHz) Network Analyzer	February 2007	JP38020182
Agilent	8960 Base Station Simulator	January 2007	
PCTEST	9-pin Audio Cable	N/A	N/A
TEM	Axial Telecoil Probe	March 2007	TEM-1109
TEM	Radial Telecoil Probe	March 2007	TEM-1108
Agilent	Base Station Simulator	May 2007	661
TEM	C63.19 Helmholtz Coil	March 2007	PCT925
Rohde & Schwarz	CMU200 Base Station Simulator	September 2006	650378
SPEAG	DAE4	October 2006	637
Agilent	ESG-D Signal Generator	October 2006	
Optix	Fiber-Optic Line	N/A	
SPEAG	Freespace 1880 MHz Dipole	February 2007	1002
TDK	Freespace 1900 MHz Dipole	October 2007	130116
SPEAG	Freespace 2450 MHz Dipole	February 2007	1004
ETS	Freespace 835 MHz Dipole	February 2007	A005
SPEAG	Freespace 835 MHz Dipole	February 2007	1003
EMCO	Freespace E-field Probe	January 2007	9704-1441
SPEAG	Freespace E-field Probe	January 2007	2332
SPEAG	Freespace H-field Probe	October 2006	6180
TEM	HAC Positioner	N/A	PCT918
Bruel & Kjaer	HATS System	January 2007	687
Hosa	High Precision TRS Cable	N/A	
EMCO	Model 3115 (1-18GHz) Horn Antenna	October 2006	9203-2178
TEM	HAC System Controller with Software	October 2006	9704-5182
Rohde & Schwarz	NRVS Power Meter	April 2007	
RF Lindgren Model 26-2/2-0	Shielded Screen Room	N/A	6710 (PCT270)
Ray Proof Model S81	Shielded Semi-Anechoic Chamber	-	R2437 (PCT278)
AudioScan	Telecoil Magnetic Field Simulator	February 2007	22005

* Traceable to NIST

FCC ID: A3LSGHZX20		C63.19-2006 v3.12 §6 HAC TEST REPORT		Reviewed by: Quality Manager
Filename: 0606200529	Test Dates: June 29 - July 3, 2006	EUT Type: Dual-Band GSM/WCDMA Phone with Bluetooth		Page 26 of 37

10. CALIBRATION CERTIFICATES

FCC ID: A3LSGHZX20	 PCTEST	C63.19-2006 v3.12 §6 HAC TEST REPORT		Reviewed by: Quality Manager
Filename: 0606200529	Test Dates: June 29 - July 3, 2006	EUT Type: Dual-Band GSM/WCDMA Phone with Bluetooth		Page 27 of 37

I. System Manufacturer Calibration Certificates

TEM Consulting, LP

140 River Rd.
Georgetown, Texas 78628

Certificate of Calibration

Date: October 12, 2005
Cert I.D.: 1017-051012

Calibration Standard(s)

The instrument identified below has been individually calibrated to the following standards:

IEEE Standard 1027

Instrument Identification

Manufacturer: TEM Consulting, LP
Unit Description: Helmholtz Coil

Calibration Instrumentation



Equipment Used	Make/Model - S/N	Calibration Date
Digital Multi-Meter Ruler	Fluke 8860A - SN 3085046	1/26/04

1

TEM Consulting, LP
www.temconsulting.com

140 River Rd.
Georgetown, Tx. 78628



Tel: (512) 864-3365
Mobile (512) 466-0833
Fax: (512) 869-8709
E-MAIL stephen.berger@ieee.org

FCC ID: A3LSGHZX20		C63.19-2006 v3.12 §6 HAC TEST REPORT		Reviewed by: Quality Manager
Filename: 0606200529	Test Dates: June 29 - July 3, 2006	EUT Type: Dual-Band GSM/WCDMA Phone with Bluetooth	Page 28 of 37	

Calibration Instrumentation

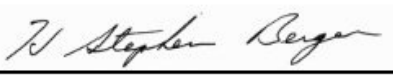
Equipment Used	Make/Model - S/N	Calibration Date
Digital Multi-Meter	Fluke 8860A - SN 3085046	1/26/04
Helmholtz Coil	TEM Consulting	NA

Calibration Completed by: 
 Stephen Berger, Calibration Laboratory Supervisor

FCC ID: A3LSGHZX20		C63.19-2006 v3.12 §6 HAC TEST REPORT		Reviewed by: Quality Manager
Filename: 0606200529	Test Dates: June 29 - July 3, 2006	EUT Type: Dual-Band GSM/WCDMA Phone with Bluetooth	Page 29 of 37	



Certificate of Calibration Conformance

This instrument identified below has been individually calibrated in compliance with the following standard(s):

Internal Quality Standards.

Environment: Laboratory MTE is maintained in a temperature-controlled environment with ambient conditions from 18 to 28 C, relative humidity less than 90%. The instrument under test has been calibrated in a suitable environment to maintaining accurate and reliable measurement quality.

Manufacturer: TEM Consulting
Model Number: T-Coil Probe Set
Serial Number: 1108 / 1109
Tracking Number: TEM051206
Date Completed: March 12, 2006

Operating Range: 100Hz – 10KHz
Instrument Type: T-Coil Probes

Test remarks: None

Calibration Traceability: All Measuring and Test Equipment (M/TE) identified below are traceable to the National Institute for Standards and Technology (NIST). Calibration Laboratory and Quality System controls are compliant with ISO/IEC 17025-1999.

Standards and Equipment Used:
Make / Model / Name/S/N / Recall Date
3478A Multimeter 2301A18249 6/30/2006
8116A Pulse/Function Generator 50Mhz
2516A01852 6/30/2006

Condition of Instrument Upon Receipt:
In tolerance to Internal Quality Standards

On Release:
In Tolerance to Internal Quality Standards

This document provides traceability of measurements to recognized national standards using controlled processes at the ETS-Lindgren Calibration Laboratory. This certificate and report may not be reproduced, except in full, without the written approval of ETS-Lindgren Calibration Laboratory in accordance with ISO/IEC 17025-1999. QAF 1127 (07/03).

FCC ID: A3LSGHZX20		C63.19-2006 v3.12 §6 HAC TEST REPORT		Reviewed by: Quality Manager
Filename: 0606200529	Test Dates: June 29 - July 3, 2006	EUT Type: Dual-Band GSM/WCDMA Phone with Bluetooth		Page 30 of 37



Certificate of Calibration Conformance

Sensor Factor **0.6**
 Factor to convert dB mV to dB A/m

Dynamic Range

Probe **1108**

Freq	Field Strength		Output	Sensor Factor	Sensor Linearity
	Hz	dB (A/m) A/m			
1000	28	25.1	26.52	0.5	0.0
1000	23	14.1	14.99	0.5	0.0
1000	18	7.9	8.48	0.6	0.1

Probe **1109**

Freq	Field Strength		Output	Sensor Factor	Sensor Linearity
	Hz	dB (A/m) A/m			
1000	28	25.1	26.52	0.4	0.0
1000	23	14.1	14.85	0.4	0.0
1000	18	7.9	8.47	0.6	0.1

FCC ID: A3LSGHZX20		C63.19-2006 v3.12 §6 HAC TEST REPORT		Reviewed by: Quality Manager
Filename: 0606200529	Test Dates: June 29 - July 3, 2006	EUT Type: Dual-Band GSM/WCDMA Phone with Bluetooth		Page 31 of 37

II. Frequency Response Check with probe system:

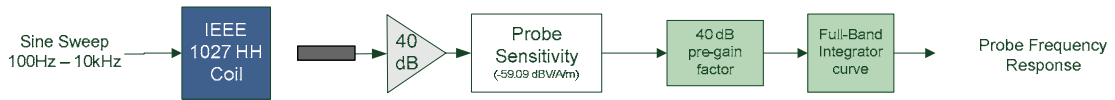
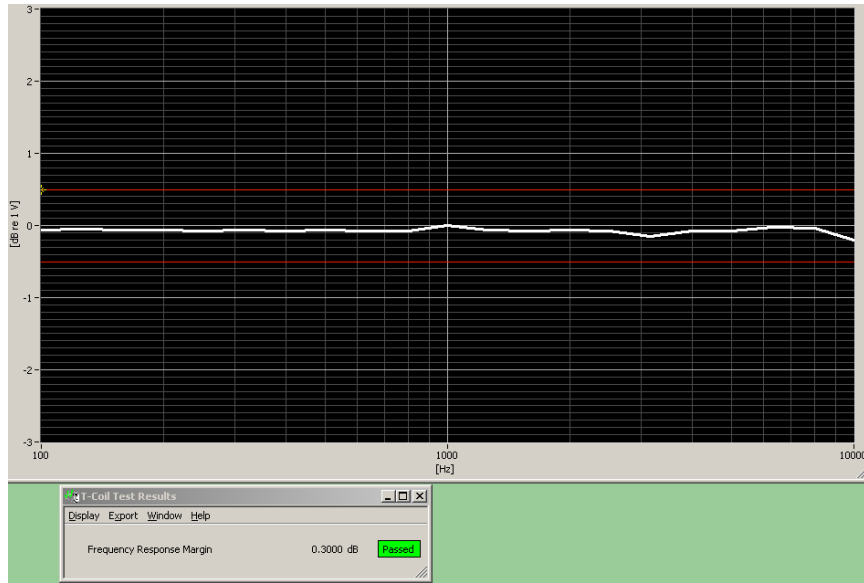

III. Linearity Check with probe system:

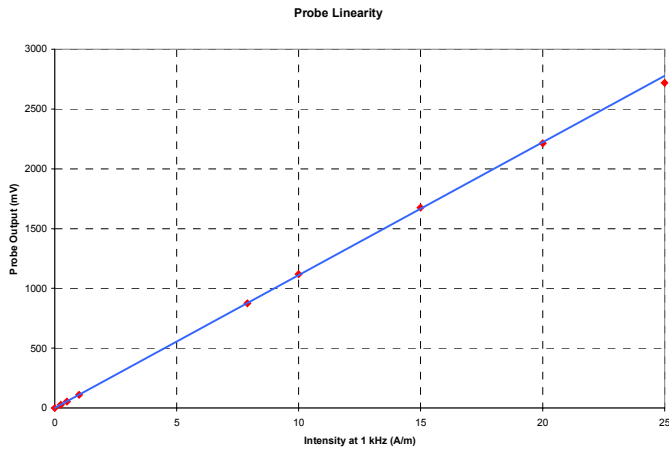

F/S (A/m)	Output (mV)	Variation (dB)
25	2718	-0.09
20	2212	-0.02
15	1676	0.03
10	1118	0.03
7.9	876	-0.01
1	111.076	0.00
0.5	55.500	0.00
0.25	27.670	-0.02
0	0	0.00

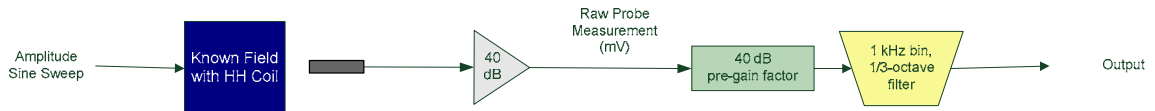



FCC ID: A3LSGHZX20	PCTEST	C63.19-2006 v3.12 §6 HAC TEST REPORT	SAMSUNG	Reviewed by: Quality Manager
Filename: 0606200529	Test Dates: June 29 - July 3, 2006	EUT Type: Dual-Band GSM/WCDMA Phone with Bluetooth		Page 32 of 37

11. CONCLUSION



The measurements indicate that the wireless communications device complies with the HAC limits specified in accordance with the ANSI C63.19 Standard and FCC WT Docket No. 01-309 RM-8658. Precise laboratory measures were taken to assure repeatability of the tests. The tested device complies with the requirements in respect to all parameters specific to the test. The test results and statements relate only to the item(s) tested.

The measurement system and techniques presented in this evaluation are proposed in the ANSI standard as a means of best approximating wireless device compatibility with a hearing-aid. The literature is under continual re-construction.



FCC ID: A3LSGHZX20		C63.19-2006 v3.12 §6 HAC TEST REPORT		Reviewed by: Quality Manager
Filename: 0606200529	Test Dates: June 29 - July 3, 2006	EUT Type: Dual-Band GSM/WCDMA Phone with Bluetooth		Page 33 of 37

12. REFERENCES

1. ANSI C63.19-2006 v3.12, American National Standard for Methods of Measurement of Compatibility between Wireless communication devices and Hearing Aids.", New York, NY, IEEE, January 2006
2. FCC Public Notice DA 06-1215, *Wireless Telecommunications Bureau and Office of Engineering and Technology Clarify Use of Revised Wireless Phone Hearing Aid Compatibility Standard*, June 6, 2006
3. Berger, H. S., "Compatibility Between Hearing Aids and Wireless Devices," Electronic Industries Forum, Boston, MA, May, 1997
4. Berger, H. S., "Hearing Aid and Cellular Phone Compatibility: Working Toward Solutions," *Wireless Telephones and Hearing Aids: New Challenges for Audiology*, Gallaudet University, Washington, D.C., May, 1997 (To be reprinted in the American Journal of Audiology).
5. Berger, H. S., "Hearing Aid Compatibility with Wireless Communications Devices," IEEE International Symposium on Electromagnetic Compatibility, Austin, TX, August, 1997.
6. Bronaugh, E. L., "Simplifying EMI Immunity (Susceptibility) Tests in TEM Cells," in the 1990 IEEE International Symposium on Electromagnetic Compatibility Symposium Record, Washington, D.C., August 1990, pp. 488-491
7. Byrne, D. and Dillon, H., The National Acoustics Laboratory (NAL) New Procedure for Selecting the Gain and Frequency Response of a Hearing Aid, *Ear and Hearing* 7:257-265, 1986.
8. Crawford, M. L., "Measurement of Electromagnetic Radiation from Electronic Equipment using TEM Transmission Cells," U.S. Department of Commerce, National Bureau of Standards, NBSIR 73-306, Feb. 1973.
9. Crawford, M. L., and Workman, J. L., "Using a TEM Cell for EMC Measurements of Electronic Equipment," U.S. Department of Commerce, National Bureau of Standards. Technical Note 1013, July 1981.
10. EHIMA GSM Project, Development phase, Project Report (1st part) Revision A. Technical-Audiological Laboratory and Telecom Denmark, October 1993.
11. EHIMA GSM Project, Development phase, Part II Project Report. Technical-Audiological Laboratory and Telecom Denmark, June 1994.
12. EHIMA GSM Project Final Report, Hearing Aids and GSM Mobile Telephones: Interference Problems, Methods of Measurement and Levels of Immunity. Technical-Audiological Laboratory and Telecom Denmark, 1995.
13. HAMPIS Report, Comparison of Mobile phone electromagnetic near field with an upscaled electromagnetic far field, using hearing aid as reference, 21 October 1999.
14. Hearing Aids/GSM, Report from OTWIDAM, Technical-Audiological Laboratory and Telecom Denmark, April 1993.
15. IEEE 100, The Authoritative Dictionary of IEEE Standards Terms, Seventh Edition.

FCC ID: A3LSGHZX20		C63.19-2006 v3.12 §6 HAC TEST REPORT		Reviewed by: Quality Manager
Filename: 0606200529	Test Dates: June 29 - July 3, 2006	EUT Type: Dual-Band GSM/WCDMA Phone with Bluetooth	Page 34 of 37	

16. Joyner, K. H., et. al., Interference to Hearing Aids by the New Digital Mobile Telephone System, Global System for Mobile (GSM) Communication Standard, National Acoustic Laboratory, Australian Hearing Series, Sydney 1993.
17. Joyner, K. H., et. al., Interference to Hearing Aids by the Digital Mobile Telephone System, Global System for Mobile Communications (GSM), NAL Report #131, National Acoustic Laboratory, Australian Hearing Series, Sydney, 1995.
18. Kecker, W. T., Crawford, M. L., and Wilson, W. A., "Construction of a Transverse Electromagnetic Cell", U.S. Department of Commerce, National Bureau of Standards, Technical Note 1011, Nov. 1978.
19. Konigstein, D., and Hansen, D., "A New Family of TEM Cells with enlarged bandwidth and Optimized working Volume," in the Proceedings of the 7th International Symposium on EMC, Zurich, Switzerland, March 1987; 50:9, pp. 127-132.
20. Kuk, F., and Hjorstgaard, N. K., "Factors affecting interference from digital cellular telephones," Hearing Journal, 1997; 50:9, pp 32-34.
21. Ma, M. A., and Kanda, M., "Electromagnetic Compatibility and Interference Metrology," U.S. Department of Commerce, National Bureau of Standards, Technical Note 1099, July 1986, pp. 17-43.
22. Ma, M. A., Sreenivashiah, I. , and Chang, D. C., "A Method of Determining the Emission and Susceptibility Levels of Electrically Small Objects Using a TEM Cell," U.S. Department of Commerce, National Bureau of Standards, Technial Note 1040, July 1981.
23. McCandless, G. A., and Lyregaard, P. E., Prescription of Gain/Output (POGO) for Hearing Aids, Hearing Instruments 1:16-21, 1983
24. Skopec, M., "Hearing Aid Electromagnetic Interference from Digital Wireless Telephones, "IEEE Transactions on Rehabilitation Engineering, vol. 6, no. 2, pp. 235-239, June 1998.
25. Technical Report, GSM 05.90, GSM EMC Considerations, European Telecommunications Standards Institute, January 1993.
26. Victorian, T. A., "Digital Cellular Telephone Interference and Hearing Aid Compatibility—an Update," Hearing Journal 1998; 51:10, pp. 53-60
27. Wong, G. S. K., and Embleton, T. F. W., eds., AIP Handbook of Condenser Microphones: Theory, Calibration and Measurements, AIP Press.

FCC ID: A3LSGHZX20		C63.19-2006 v3.12 §6 HAC TEST REPORT		Reviewed by: Quality Manager
Filename: 0606200529	Test Dates: June 29 - July 3, 2006	EUT Type: Dual-Band GSM/WCDMA Phone with Bluetooth		Page 35 of 37