



**Accredited testing laboratory**

**DAR registration number: TTI-P-G 166/98**

**Federal Motor Transport Authority (KBA)  
DAR registration number: KBA-P 00070-97**

**Appendix to the Report 4-0674-1-1b/02  
Calibration Data, Phantom Certificate  
and detail Information of the DASY 3 System**

## Table of Content

1	Calibration report “Probe ET3DV6” .....	3
2	Calibration report “1900 MHz System validation dipole” .....	13
3	Certificate of Conformity “SAM Twin Phantom V4.0/V4.0C” .....	20
4	Application Note Validation and system Check .....	22

## 1 Calibration report "Probe ET3DV6"

**Schmid & Partner  
Engineering AG**

---

Zeughausstrasse 43, 8004 Zurich, Switzerland, Telephone +41 1 245 97 00, Fax +41 1 245 97 79

---

# Probe ET3DV6

## SN:1558

Manufactured:	December 1, 2000
Last calibration:	February 20, 2001
Recalibrated:	March 22, 2002

Calibrated for System DASY3

ET3DV6 SN:1558

March 22, 2002

### DASY3 - Parameters of Probe: ET3DV6 SN:1558

#### Sensitivity in Free Space

NormX	<b>1.47</b> $\mu\text{V}/(\text{V}/\text{m})^2$
NormY	<b>1.34</b> $\mu\text{V}/(\text{V}/\text{m})^2$
NormZ	<b>1.39</b> $\mu\text{V}/(\text{V}/\text{m})^2$

#### Diode Compression

DCP X	<b>98</b>	mV
DCP Y	<b>98</b>	mV
DCP Z	<b>98</b>	mV

#### Sensitivity in Tissue Simulating Liquid

Head                      **900 MHz**                       $\epsilon_r = 41.5 \pm 5\%$                        $\sigma = 0.97 \pm 5\% \text{ mho/m}$

ConvF X	<b>6.8</b> $\pm 8.9\%$ (k=2)	Boundary effect:
ConvF Y	<b>6.8</b> $\pm 8.9\%$ (k=2)	Alpha <b>0.37</b>
ConvF Z	<b>6.8</b> $\pm 8.9\%$ (k=2)	Depth <b>2.28</b>

Head                      **1800 MHz**                       $\epsilon_r = 40.0 \pm 5\%$                        $\sigma = 1.40 \pm 5\% \text{ mho/m}$

ConvF X	<b>5.4</b> $\pm 8.9\%$ (k=2)	Boundary effect:
ConvF Y	<b>5.4</b> $\pm 8.9\%$ (k=2)	Alpha <b>0.43</b>
ConvF Z	<b>5.4</b> $\pm 8.9\%$ (k=2)	Depth <b>2.49</b>

#### Boundary Effect

Head                      **900 MHz**                      Typical SAR gradient: 5 % per mm

Probe Tip to Boundary		<b>1 mm</b>	<b>2 mm</b>
SAR <sub>be</sub> [%] Without Correction Algorithm		8.1	4.5
SAR <sub>be</sub> [%] With Correction Algorithm		0.2	0.4

Head                      **1800 MHz**                      Typical SAR gradient: 10 % per mm

Probe Tip to Boundary		<b>1 mm</b>	<b>2 mm</b>
SAR <sub>be</sub> [%] Without Correction Algorithm		10.6	7.2
SAR <sub>be</sub> [%] With Correction Algorithm		0.2	0.2

#### Sensor Offset

Probe Tip to Sensor Center	<b>2.7</b>	mm
Optical Surface Detection	<b>1.7 <math>\pm</math> 0.2</b>	mm

ET3DV6 SN:1558

March 22, 2002

Receiving Pattern ( $\phi$ ),  $\theta = 0^\circ$

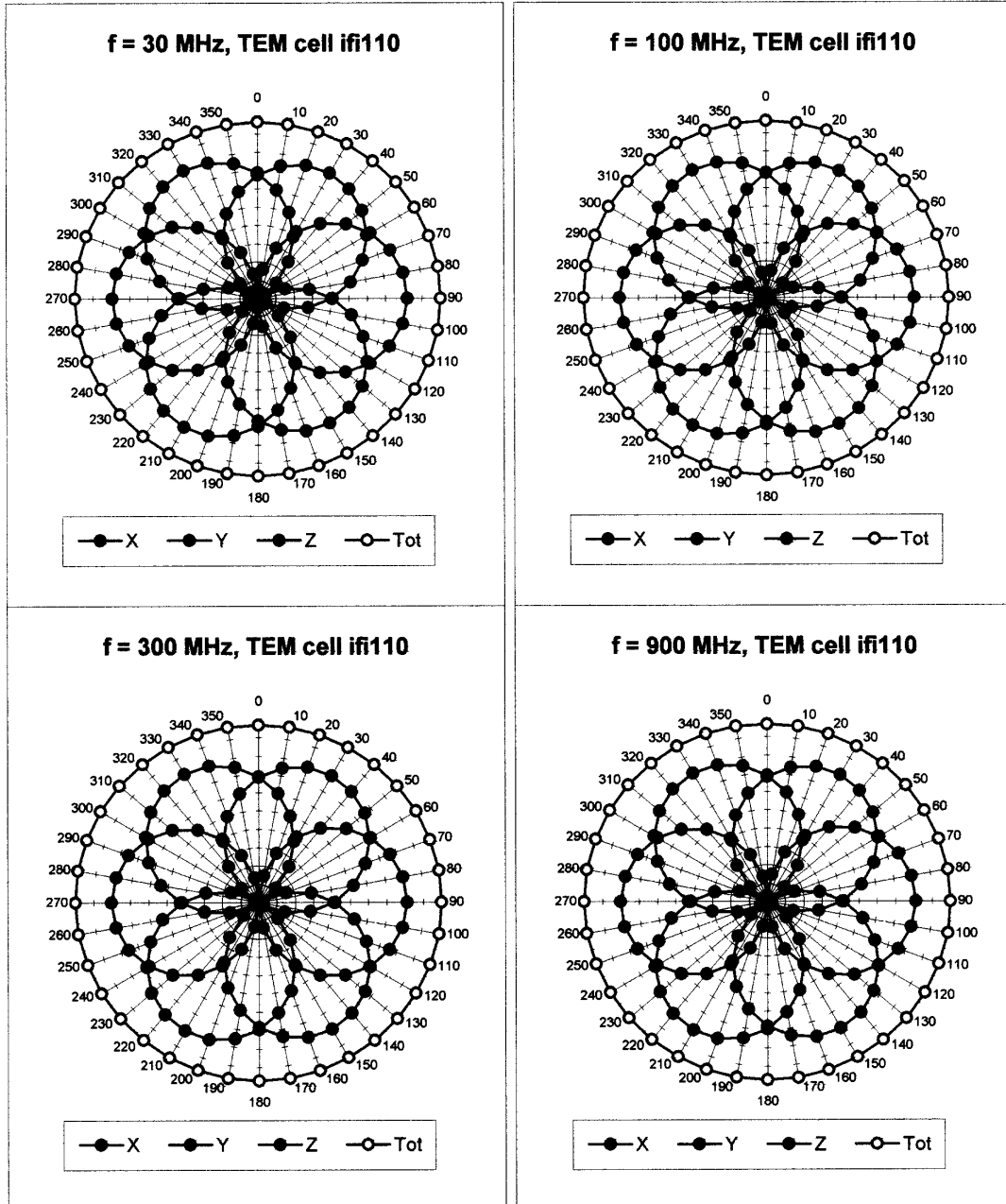

ET3DV6 SN:1558

March 22, 2002

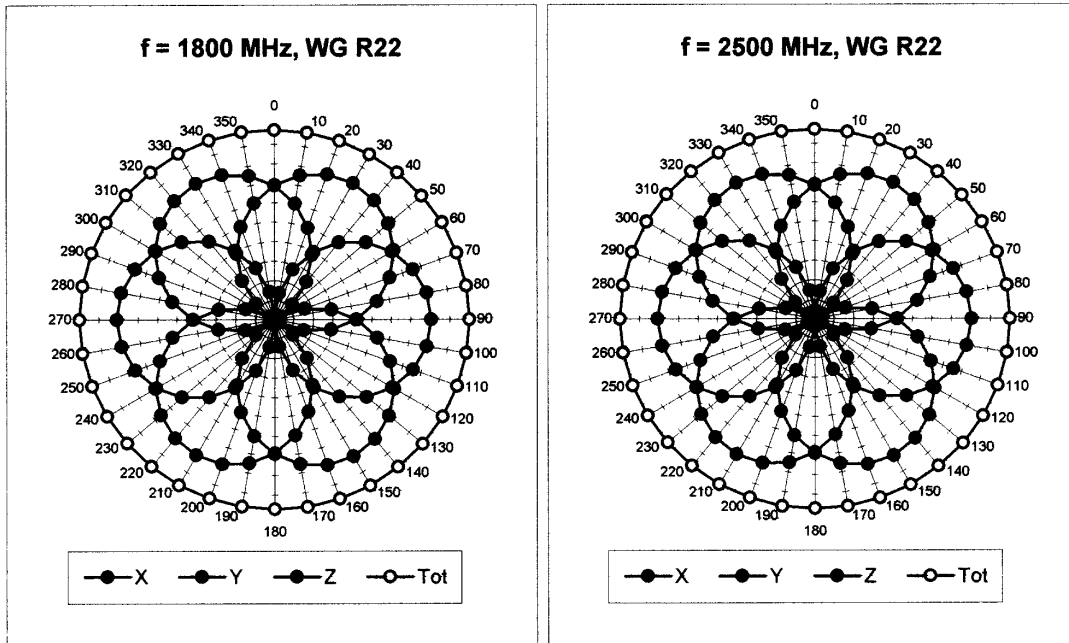

Isotropy Error ( $\phi$ ),  $\theta = 0^\circ$

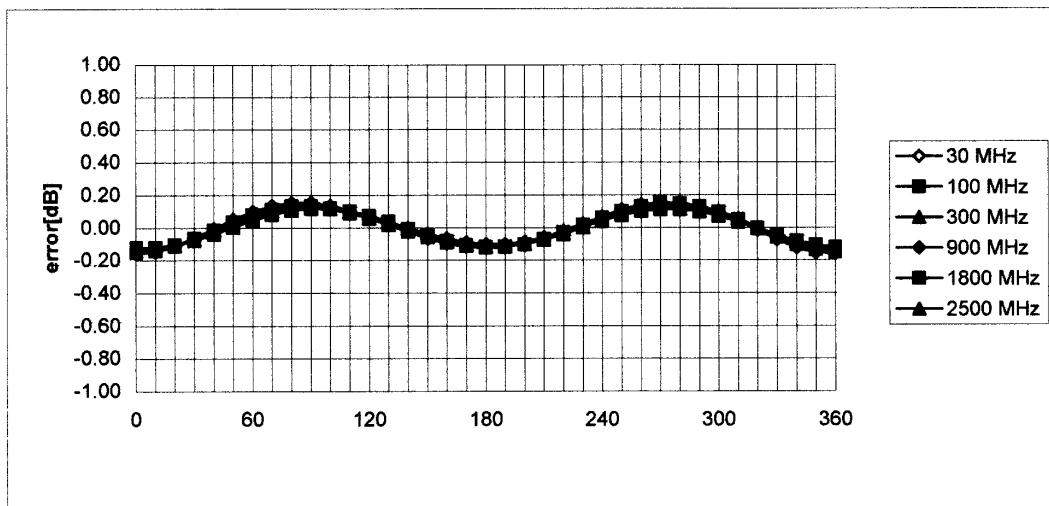

ET3DV6 SN:1558

March 22, 2002

### Frequency Response of E-Field ( TEM-Cell:ifi110, Waveguide R22)

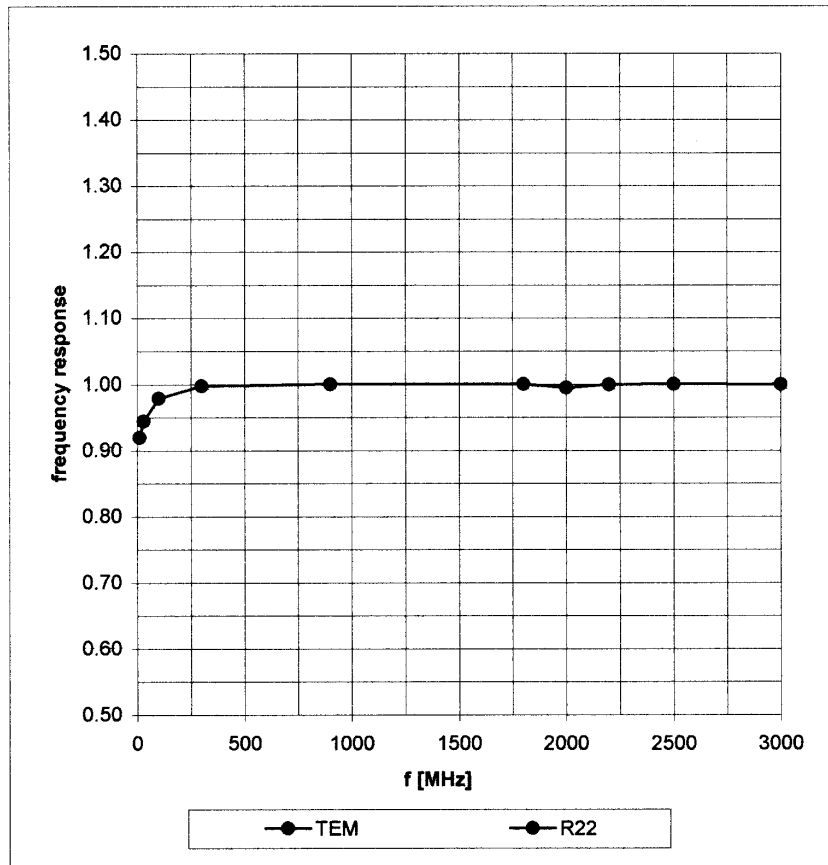

ET3DV6 SN:1558

March 22, 2002

### Dynamic Range f(SAR<sub>brain</sub>) ( Waveguide R22 )

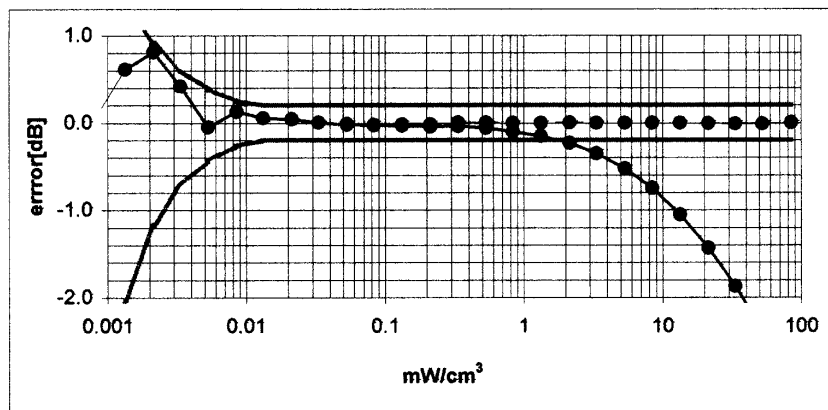
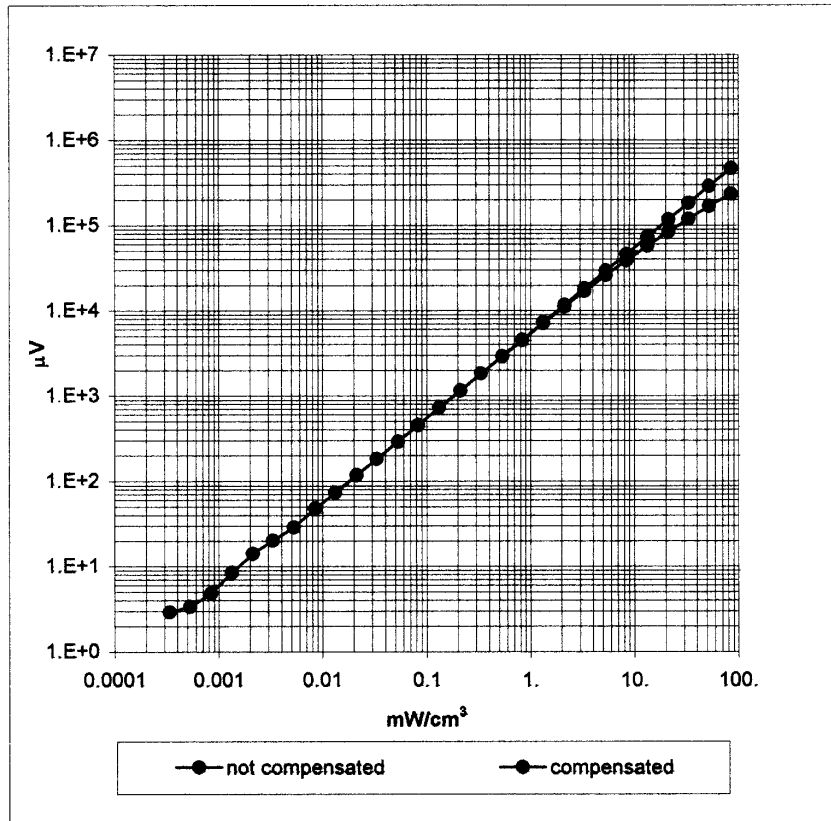

ET3DV6 SN:1558

March 22, 2002

### Conversion Factor Assessment

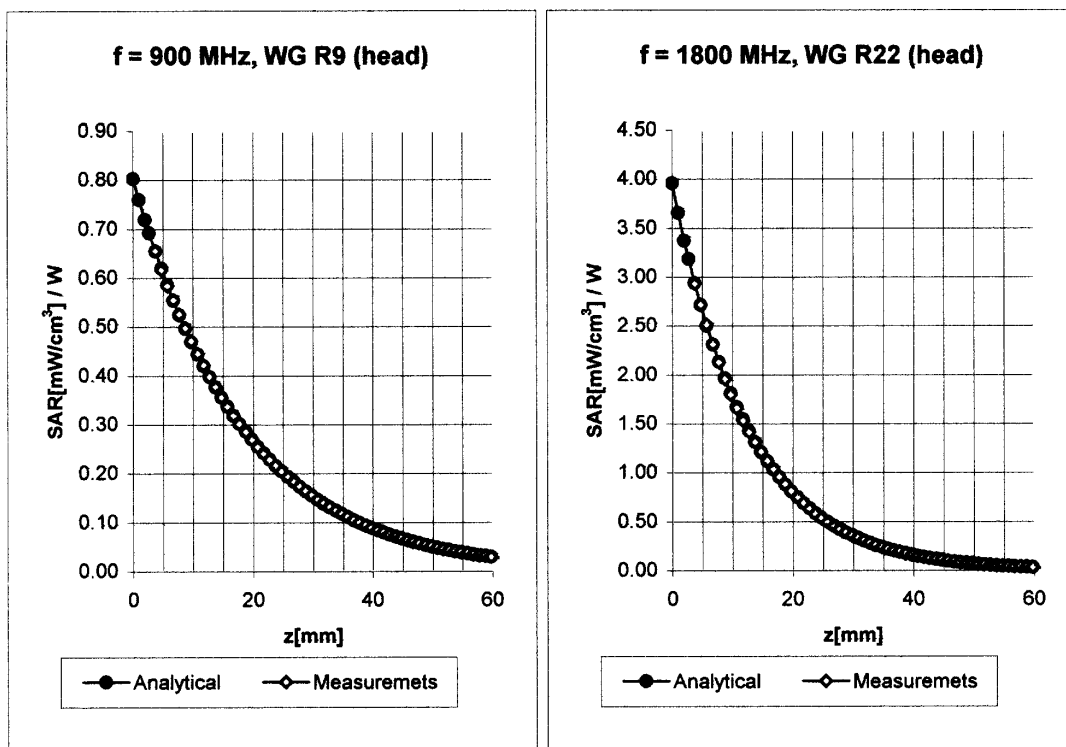

Head                      900 MHz                       $\epsilon_r = 41.5 \pm 5\%$                        $\sigma = 0.97 \pm 5\%$  mho/m

ConvF X	<b>6.8</b> $\pm 8.9\%$ (k=2)	Boundary effect:
ConvF Y	<b>6.8</b> $\pm 8.9\%$ (k=2)	Alpha <b>0.37</b>
ConvF Z	<b>6.8</b> $\pm 8.9\%$ (k=2)	Depth <b>2.28</b>

Head                      1800 MHz                       $\epsilon_r = 40.0 \pm 5\%$                        $\sigma = 1.40 \pm 5\%$  mho/m

ConvF X	<b>5.4</b> $\pm 8.9\%$ (k=2)	Boundary effect:
ConvF Y	<b>5.4</b> $\pm 8.9\%$ (k=2)	Alpha <b>0.43</b>
ConvF Z	<b>5.4</b> $\pm 8.9\%$ (k=2)	Depth <b>2.49</b>

ET3DV6 SN:1558

March 22, 2002

### Conversion Factor Assessment

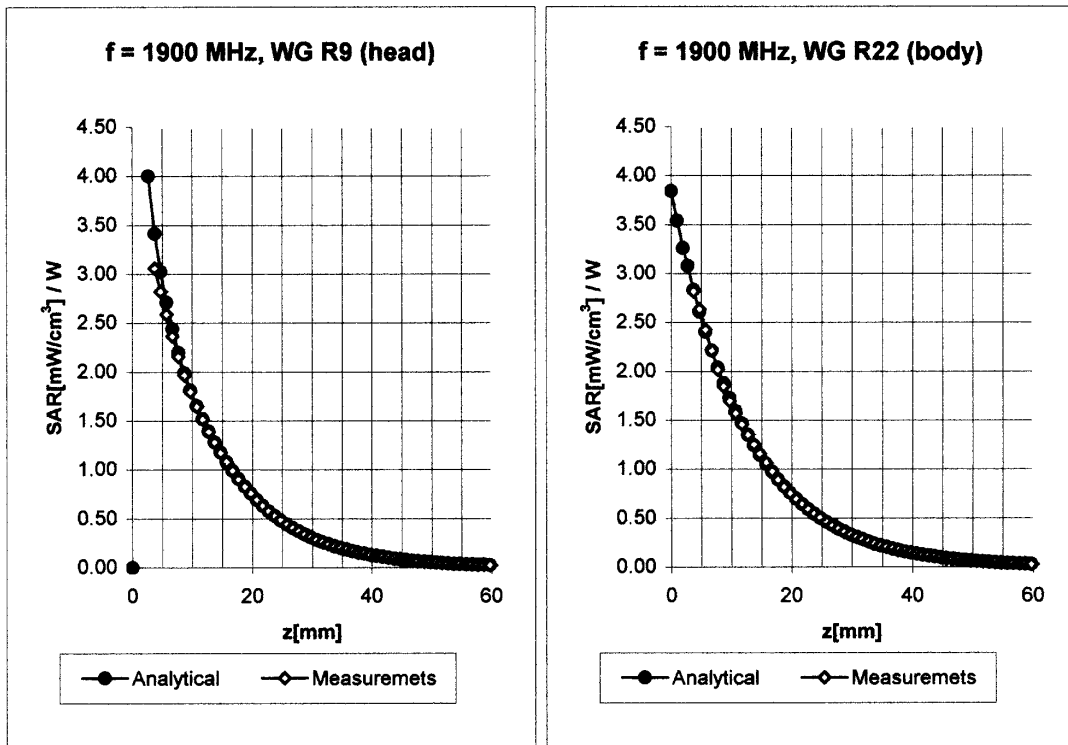

<b>Head</b>	<b>1900 MHz</b>	$\epsilon_r = 40.0 \pm 5\%$	$\sigma = 1.40 \pm 5\% \text{ mho/m}$
	ConvF X	<b>5.2</b> $\pm 8.9\%$ (k=2)	Boundary effect:
	ConvF Y	<b>5.2</b> $\pm 8.9\%$ (k=2)	Alpha <b>0.48</b>
	ConvF Z	<b>5.2</b> $\pm 8.9\%$ (k=2)	Depth <b>2.42</b>
<b>Body</b>	<b>1900 MHz</b>	$\epsilon_r = 53.3 \pm 5\%$	$\sigma = 1.52 \pm 5\% \text{ mho/m}$
	ConvF X	<b>4.6</b> $\pm 8.9\%$ (k=2)	Boundary effect:
	ConvF Y	<b>4.6</b> $\pm 8.9\%$ (k=2)	Alpha <b>0.68</b>
	ConvF Z	<b>4.6</b> $\pm 8.9\%$ (k=2)	Depth <b>2.10</b>

**Schmid & Partner  
Engineering AG**

Zeughausstrasse 43, 8004 Zurich, Switzerland, Phone +41 1 245 97 00, Fax +41 1 245 97 79

**Additional Conversion Factors**  
for Dosimetric E-Field Probe

Type:

ET3DV6

Serial Number:

1558

Place of Assessment:

Zurich

Date of Assessment:

March 25, 2002

Probe Calibration Date:

March 22, 2002

Schmid & Partner Engineering AG hereby certifies that conversion factor(s) of this probe have been evaluated on the date indicated above. The assessment was performed using the FDTD numerical code SEMCAD of Schmid & Partner Engineering AG. Since the evaluation is coupled with measured conversion factors, it has to be recalculated yearly, i.e., following the re-calibration schedule of the probe. The uncertainty of the numerical assessment is based on the extrapolation from measured value at 900 MHz or at 1800 MHz.

Assessed by:

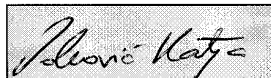

**Dosimetric E-Field Probe ET3DV6 SN:1558**

Conversion factor ( $\pm$  standard deviation)

2450 MHz	ConvF	4.4 $\pm$ 8%	$\epsilon_r = 39.2 \pm 5\%$ $\sigma = 1.80 \pm 5\%$ mho/m (head tissue)
2450 MHz	ConvF	4.0 $\pm$ 8%	$\epsilon_r = 52.7 \pm 5\%$ $\sigma = 1.95 \pm 5\%$ mho/m (body tissue)

## 2 Calibration report “1900 MHz System validation dipole”

### Schmid & Partner Engineering AG

Zeughausstrasse 43, 8004 Zurich, Switzerland, Phone +41 1 245 97 00, Fax +41 1 245 97 79

## Calibration Certificate

### 1900 MHz System Validation Dipole

Type:

**D1900V2**

Serial Number:

**5d009**

Place of Calibration:

**Zurich**

Date of Calibration:

**June 13, 2002**

Calibration Interval:

**24 months**

Schmid & Partner Engineering AG hereby certifies, that this device has been calibrated on the date indicated above. The calibration was performed in accordance with specifications and procedures of Schmid & Partner Engineering AG.

Wherever applicable, the standards used in the calibration process are traceable to international standards. In all other cases the standards of the Laboratory for EMF and Microwave Electronics at the Swiss Federal Institute of Technology (ETH) in Zurich, Switzerland have been applied.

Calibrated by:



Approved by:

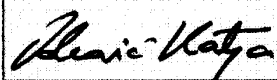

**Schmid & Partner  
Engineering AG**

**Zeughausstrasse 43, 8004 Zurich, Switzerland, Phone +41 1 245 97 00, Fax +41 1 245 97 79**

---

# DASY3

## Dipole Validation Kit

**Type: D1900V2**

**Serial: 5d009**

**Manufactured: February 22, 2002**

**Calibrated: June 13, 2002**

## 1. Measurement Conditions

The measurements were performed in the flat section of the new generic twin phantom filled with brain simulating sugar solution of the following electrical parameters at 1900 MHz:

Relative permittivity	<b>38.5</b>	$\pm 5\%$
Conductivity	<b>1.44 mho/m</b>	$\pm 10\%$

The DASY3 System (Software version 3.1d) with a dosimetric E-field probe ET3DV6 (SN:1507, conversion factor 5.2 at 1900 MHz) was used for the measurements.

The dipole feedpoint was positioned below the center marking and oriented parallel to the body axis (the long side of the phantom). The standard measuring distance was 10mm from dipole center to the solution surface. The included distance holder was used during measurements for accurate distance positioning.

The coarse grid with a grid spacing of 20mm was aligned with the dipole. The 5x5x7 fine cube was chosen for cube integration. Probe isotropy errors were cancelled by measuring the SAR with normal and 90° turned probe orientations and averaging.

The dipole input power (forward power) was 250mW  $\pm 3\%$ . The results are normalized to 1W input power.

### 2.1. SAR Measurement with DASY3 System

Standard SAR-measurements were performed according to the measurement conditions described in section 1. The results (see figure supplied) have been normalized to a dipole input power of 1W (forward power). The resulting averaged SAR-values measured with the dosimetric probe ET3DV6 SN:1507 and applying the worst-case extrapolation are:

averaged over 1 cm <sup>3</sup> (1 g) of tissue:	<b>43.6 mW/g</b>
averaged over 10 cm <sup>3</sup> (10 g) of tissue:	<b>22.5 mW/g</b>

### 2.2 SAR Measurement with DASY4 System

Standard SAR-measurements were performed according to the measurement conditions described in section 1. The results (see figure supplied) have been normalized to a dipole input power of 1W (forward power). The resulting averaged SAR-values measured with the dosimetric probe ET3DV6 SN:1507 and applying the advanced extrapolation are:

averaged over 1 cm <sup>3</sup> (1 g) of tissue:	<b>40.0 mW/g</b>
averaged over 10 cm <sup>3</sup> (10 g) of tissue:	<b>21.0 mW/g</b>



**Validation Dipole D1900V2 SN5d009, d = 10 mm**

Frequency: 1900 MHz; Antenna Input Power: 250 [mW]  
 SAM Phantom; Flat Section; Grid Spacing: Dx = 20.0, Dy = 20.0, Dz = 10.0  
 Probe: ET3DV6 - SN1507; ConvF(5.20,5.20,5.20) at 1900 MHz; IEEE1528 1900 MHz:  $\sigma = 1.44$  mho/m  $\epsilon_r = 38.5$   $\rho = 1.00$  g/cm<sup>3</sup>  
 Cubes (2): Peak: 20.5 mW/g  $\pm$  0.01 dB, SAR (1g): 10.9 mW/g  $\pm$  0.01 dB, SAR (10g): 5.62 mW/g  $\pm$  0.02 dB, (Worst-case extrapolation)  
 Penetration depth: 8.0 (7.7, 8.7) [mm]  
 Powerdrift: 0.01 dB

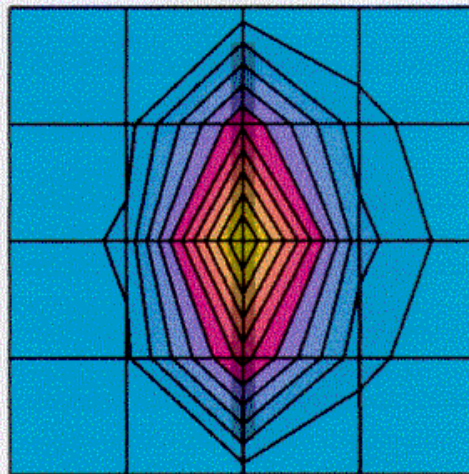
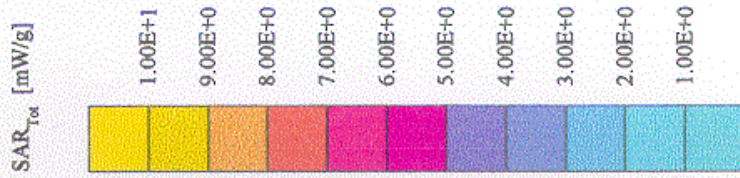

Schmid & Partner Engineering AG, Zurich, Switzerland

**Validation Dipole D1900V2 SN5d009, d = 10 mm**

Frequency: 1900 MHz; Antenna Input Power: 250 [mW]  
 SAM Phantom; Flat Section; Grid Spacing: Dx = 20.0, Dy = 20.0, Dz = 10.0  
 Probe: ET3DV6 - SN1507; ConvF(5.20,5.20,5.20) at 1900 MHz; IEEE1528 1900 MHz:  $\sigma = 1.44 \text{ mho/m}$ ,  $\epsilon_r = 38.5$ ,  $\rho = 1.00 \text{ g/cm}^3$   
 Cubes (2): Peak: 17.7 mW/g  $\pm$  0.01 dB, SAR (1g): 10.0 mW/g  $\pm$  0.01 dB, SAR (10g): 5.26 mW/g  $\pm$  0.02 dB, (Advanced extrapolation)  
 Penetration depth: 8.6 (8.5, 8.8) [mm]  
 Powerdrift: 0.01 dB

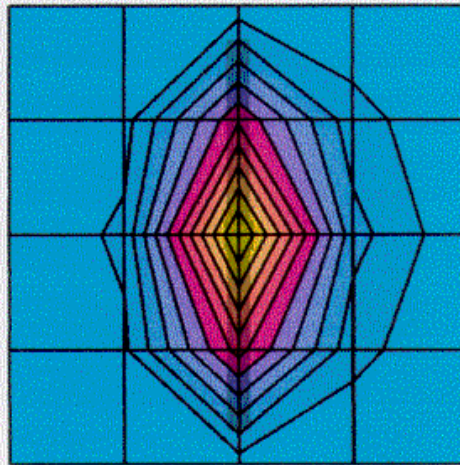

26 Feb 2002 11:23:48

CH1 S11 1 U FS 1: 50.439  $\omega$  1.6543  $\omega$  138.57 pH 1 900.040 000 MHz

Del

Cor

Avg  
16

↑

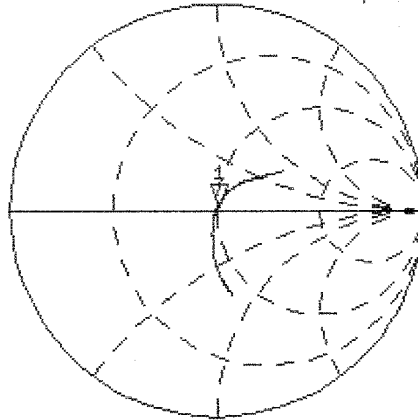

CH2 S11 LOG 5 dB/REF 0 dB 1: -35.133 dB 1 900.040 000 MHz

Cor

↑

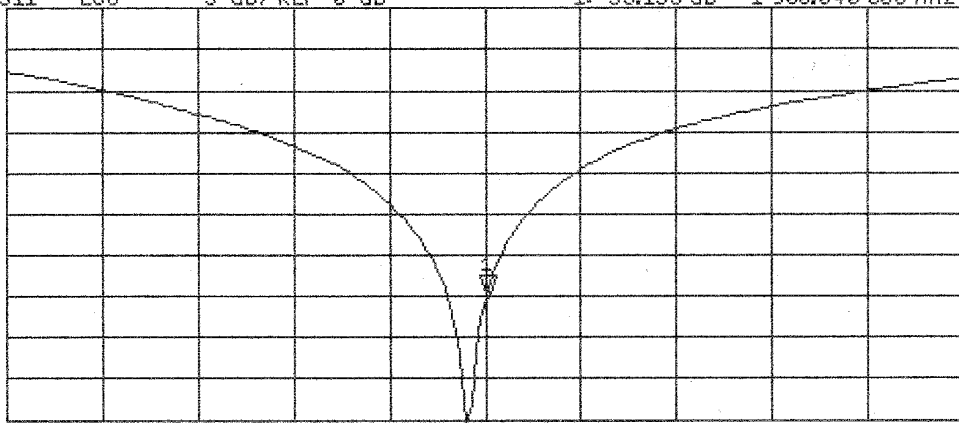

START 1 700.000 000 MHz

STOP 2 100.000 000 MHz

### 3 Certificate of Conformity "SAM Twin Phantom V4.0/V4.0C"

## Schmid & Partner Engineering AG

Zeughausstrasse 43, 8004 Zurich, Switzerland, Phone +41 1 245 97 00, Fax +41 1 245 97 79

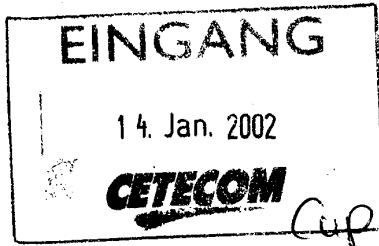

CETECOM ICT Services GmbH  
Bernd Rebmann  
Untertürkheimer Str. 6-10  
66117 Saarbrücken  
Deutschland

Zurich, January 10, 2002

#### Certificate of Conformity

Dear Bernd

It has been a while since you have received your SAM Twin Phantom V4.0/V4.0C.

Several of our customers have required a document to justify to the authorities that the SAM phantom used for SAR measurements is conformant with the respective standards.

For your documentation please find enclosed a copy of the duly signed "Certificate of Conformity/First Article Inspection" (Document No. 881 - QD 000 P40 BA - B). With this certificate we confirm conformity with the CENELEC EN 50361, IEEE P1528-200x draft 6.5 and the IEC PT 62209 draft 0.9 standards.

Please do not hesitate to contact us in case you have any questions or are in need of further clarification. You can always reach us at +41-1-245 97 00 or by e-mail to [info@speg.com](mailto:info@speg.com).

Best regards,

Schmid & Partner Engineering AG

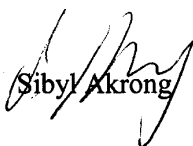

Sibyl Akrong

## Schmid & Partner Engineering AG

Zeughausstrasse 43, 8004 Zurich, Switzerland, Phone +41 1 245 97 00, Fax +41 1 245 97 79

### Certificate of conformity / First Article Inspection

Item	SAM Twin Phantom V4.0
Type No	QD 000 P40 BA
Series No	TP-1002 and higher
Manufacturer / Origin	Untersee Composites Hauptstr. 69 CH-8559 Fruthwilen Switzerland

#### Tests

The series production process used allows the limitation to test of first articles. Complete tests were made on the pre-series Type No. QD 000 P40 AA, Serial No. TP-1001 and on the series first article Type No. QD 000 P40 BA, Serial No. TP-1006. Certain parameters have been retested using further series units (called samples).

Test	Requirement	Details	Units tested
Shape	Compliance with the geometry according to the CAD model.	IT'IS CAD File (*)	First article, Samples
Material thickness	Compliant with the requirements according to the standards	2mm +/- 0.2mm in specific areas	First article, Samples
Material parameters	Dielectric parameters for required frequencies	200 MHz – 3 GHz Relative permittivity < 5 Loss tangent < 0.05.	Material sample TP 104-5
Material resistivity	The material has been tested to be compatible with the liquids defined in the standards	Liquid type HSL 1800 and others according to the standard.	Pre-series, First article

#### Standards

- [1] CENELEC EN 50361
- [2] IEEE P1528-200x draft 6.5
- [3] IEC PT 62209 draft 0.9
- (\*) The IT'IS CAD file is derived from [2] and is also within the tolerance requirements of the shapes of [1] and [3].

#### Conformity

Based on the sample tests above, we certify that this item is in compliance with the uncertainty requirements of SAR measurements specified in standard [1] and draft standards [2] and [3].

Date 18.11.2001

Signature / Stamp  Schmid & Partner Engineering AG   
 Zeughausstrasse 43, CH-8004 Zurich  
 Tel. +41 1 245 97 00, Fax +41 1 245 97 79

## 4 Application Note Validation and system Check

### 4.1.1.1 Purpose of validation

The Validation and system check verify that the system operates within its specifications. System and operator errors can be detected and corrected. It is recommended that the validation be performed prior to any usage of the system in order to guarantee reproducible results.

The measurement of the Specific Absorption Rate (SAR) is a complicated task and the result depends on the proper functioning of many components and the correct settings of many parameters. Faulty results due to drift, failures or incorrect parameters might not be recognized, since they often look similar in distribution to the correct ones. The Dosimetric Assessment System DASY3 incorporates a validation procedure to test the proper functioning of the system. The system validation uses normal SAR measurements in a simplified setup (the flat phantom section of the Generic Twin Phantom) with a well-characterized source (a matched dipole of a specified distance). This setup was selected to give a high sensitivity to all parameters that might fail or vary over time (e.g. probe, liquid parameters, and software settings) and a low sensitivity to external effects inherent in the system (e.g. positioning uncertainty of the device holder). The validation does not replace the calibration of the components. The accuracy of the validation is not sufficient for calibration purposes. It is possible to calculate the field quite accurately in this simple setup; however, due to the open field situation some factors (e.g. laboratory reflections) cannot be accounted for. Calibrations in the flat phantom are possible with transfer calibration methods, using either temperature probes or calibrated E-field probes. The validation also does not test the system performance for arbitrary field situations encountered during real measurements of mobile phones. These checks are performed at SPEAG by testing the components under various conditions (e.g. spherical isotropy measurements in liquid, linearity measurements, temperature variations, etc.), the results of which are used for an error estimation of the system. The validation will indicate situations where the system uncertainty is exceeded due to drift or failure.

### 4.1.1.2 Validation procedure

#### Preparation

The conductivity should be measured before the validation and the measured liquid parameters must be entered in the software. If the measured values differ from targeted values in the dipole document, the liquid composition should be adjusted. If the validation is performed with slightly different (measured) liquid parameters, the expected SAR will also be different. See the application note about SAR sensitivities for an estimate of possible SAR deviations. Note that the liquid parameters are temperature dependent with approximately – 0.5% decrease in permittivity and + 1% increase in conductivity for a temperature decrease of 1° C. The dipole must be placed beneath the flat phantom section of the Generic Twin Phantom with the correct distance holder in place. The distance holder should touch the phantom surface with a light pressure at the reference marking (little hole) and be oriented parallel to the long side of the phantom. Accurate positioning is not necessary, since the system will search for the peak SAR location, except that the dipole arms should be parallel to the surface. The device holder for mobile phones can be left in place but should be rotated away from the dipole. The forward power into the dipole at the dipole SMA connector should be determined as accurately as possible. See section 4 for a description of the recommended setup to measure the dipole input power. The actual dipole input power level can be between 20mW and several watts. The result can later be normalized to any power level. It is strongly recommended to note the actually used power level in the „comment“-window of the measurement file; otherwise you lose this crucial information for later reference.

#### Validation

The DASY3 installation includes predefined files with recommended procedures for measurements and validation. They are read-only document files and destined as fully defined but unmeasured masks, so you must save the finished validation under a different name. The validation document requires the Generic Twin Phantom, so this phantom must be properly installed in your system. (You can create your own measurement procedures by opening a new document or editing an existing document file). Before you start the validation, you just have to tell the system with which components (probe, medium, and device) you are performing the validation; the system will take care of all parameters. After the validation, which will take about 20 minutes, the results of each task are displayed in the document window. Selecting all measured tasks and opening the predefined “validation” graphic

format displays all necessary information for validation. A description of the different measurement tasks in the predefined document is given below, together with the information that can be deduced from their results:

- The „reference“ and „drift“ measurements are located at the beginning and end of the batch process. They measure the field drift at one single point in the liquid over the complete procedure. The indicated drift is mainly the variation of the amplifier output power. If it is too high (above  $\pm 0.1$  dB) the validation should be repeated; some amplifiers have very high drift during warm-up. A stable amplifier gives drift results in the DASY3 system below  $\pm 0.02$  dB.
- The „surface check“ measurement tests the optical surface detection system of the DASY3 system by repeatedly detecting the surface with the optical and mechanical surface detector and comparing the results. The output gives the detecting heights of both systems, the difference between the two systems and the standard deviation of the detection repeatability. Air bubbles or refraction in the liquid due to separation of the sugar-water mixture gives poor repeatability (above  $\pm 0.1$  mm). In that case it is better to abort the validation and stir the liquid. The difference between the optical surface detection and the actual surface depends on the probe and is specified with each probe. (It does not depend on the surface reflectivity or the probe angle to the surface within  $\pm 30^\circ$ .) However, varying breaking indices of different liquid compositions might also influence the distance. If the indicated difference varies from the actual setting, the probe parameter „optical surface distance“ should be changed in the probe settings (see manual). For more information see the application note about SAR evaluation.
- The „coarse scan“ measures the SAR above the dipole on a parallel plane to the surface. It is used to locate the approximate location of the peak SAR with 2D spline interpolation. The proposed scan uses large grid spacing for faster measurement; due to the symmetric field the peak detection is reliable. If a finer graphic is desired, the grid spacing can be reduced. Grid spacing and orientation have no influence on the SAR result.
- The two „cube 5x5x7“ scans measure the field in a volume around the peak SAR value assessed in the previous „coarse“ scan (for more information see the application note on SAR evaluation). Between the two cube scans the probe is rotated  $90^\circ$  around its axis. This allows checking and compensation of the probe isotropy error. In the document, the evaluated peak 1g and 10g averaged SAR values are shown. In the graphic, the mean values and the relative differences between the two cube scans are given for the extrapolated peak value and the 1g and 10g spatial peak values. If the difference between the cubes is larger than the expected isotropy from the probe document (and the power drift measurement is OK), there may be a problem with the parameter settings of the probe (e.g. wrong probe selected) or with the probe itself. The penetration depth is assessed from an exponential curve fitting on the z-axis in the center of the cube. Since the decay is not purely exponential, the values in parentheses give the decay near the surface and further inside the phantom. If these values differ greatly from the values in the dipole document, either the dipole distance or the actual liquid parameters are different to the ones used in the document.

If the validation measurements give reasonable results, the peak 1g and 10g spatial SAR values averaged between the two cubes and normalized to 1W dipole input power give the reference data for comparisons. The next section analyzes the expected uncertainties of these values. Section 6 describes some additional checks for further information or troubleshooting.

#### 4.1.1.3 Validation uncertainty

This section describes the expected deviation of the 1g and 10g validation results with respect to the correct values (absolute uncertainty), to validation results from other laboratories (interlaboratory comparisons) and to earlier results from the same laboratory and setup (repeatability). The uncertainty evaluation includes factors outside of the actual measurement system (conductivity measurement, source power determination and laboratory reflections). Since the uncertainty of these factors depends on the actual equipment and setup at the user location, estimated uncertainty values are given for a typical setup and a state-of-the-art setup. The typical setup assumes the HP dielectric probe kit for conductivity measurements and a simple power setting without directional coupler. The state-of-the-art setup assumes slotted coaxial lines for conductivity measurements and a power setting according to section 4. Section 5 describes the influence and reduction of laboratory reflections. It is assumed that the results of the liquid parameter assessment give the targeted values from the dipole document. All errors are given in percent of SAR, so 0.1dB corresponds to 2.3%. The field error would be half of that.

**Absolute uncertainty**

The table gives the absolute measurement uncertainty with respect to the correct SAR value in a perfect setup. This uncertainty is smaller than the expected uncertainty for mobile phone measurements due to the simplified setup and the symmetric field distribution.

	Error	Error Distribution	SAR Error Std. Dev.	
			Typical setup	State-of-the-art setup
Probe isotropy			± 0.5 %	=
Probe linearity	± 0.1 dB	rectangular	± 1.4 %	=
Probe calibration	± 3.3 %	normal	± 3.3 %	=
Electronics	± 1 %	rectangular	± 0.6 %	=
Drift	± 1 %	normal	± 1 %	=
1g peak SAR evaluation	± 3 %	normal	± 3 %	=
Source to liquid separation	± 0.1 mm	rectangular	± 0.6 %	=
Liquid conductivity	± 5 %	rectangular	± 2.9 %	± 1.5 %
Source power	± 0.2 dB	normal	± 4.8 %	± 2.4 %
Laboratory reflections	± 3 %	normal	± 3 %	± 1 %
Total	K=1		± 8 %	± 5.75 %
Total expanded uncertainty	K=2		± 16 %	± 11.5 %

The probe isotropy is practically cancelled out because the field is normal to the probe axis and the SAR is averaged between two 90° rotated cube measurements.

**Deviation in interlaboratory comparisons**

Since the correct value is not accessible directly, the validation results must be compared to some other measured values. For comparisons between completely different measurement systems, the absolute errors of both systems must be combined (RSS) for the estimated deviation in their results. If two DASY3 systems are compared, some intrinsic system errors are (partially) cancelled out (e.g. evaluation routine errors or calibration errors). The following table gives the estimated deviation of each system for interlaboratory comparisons.

	Deviations	Deviations Distribution	SAR Std. Div.	
			Typical setup	State-of-the-art setup
Probe isotropy			± 0.5 %	=
Probe linearity	± 0.1 dB	rectangular	± 1.4 %	=
Probe calibration	± 2 %	normal	± 2 %	=
Electronic	± 1 %	rectangular	± 0.6 %	=
Drift	± 1 %	normal	± 1 %	=
1g peak SAR evaluation	± 0.6 %	normal	± 0.6 %	=
Source to liquid separation	± 0.1 mm	rectangular	± 0.6 %	=
Dipole variations	± 1 %	normal	± 1 %	=
Liquid conductivity	± 5 %	rectangular	± 2.9 %	± 1.5 %
Source power	± 0.2 dB	normal	± 4.8 %	± 2.4 %
Laboratory reflections	± 3 %	normal	± 3 %	± 1 %
Total deviations	K=1		± 7 %	± 4.25 %

Total expanded deviations	K=2		± 14 %	± 8.5 %
Comparison betw. DASY3 labs	K=2		± 20 %	± 12.0 %

The results of the SAR measurements performed at the ETH Zurich using state of the art methods for power and conductivity measurements are included with each validation dipole. The total deviation (K=1) of these data for interlaboratory comparison is ± 4 %. The differences between different dipole units of the same type are small, so it is not necessary to exchange the dipoles to compare the results. As the table indicates, the main differences in laboratory intercomparisons are due to external factors like conductivity measurements, power settings and the laboratory setup. For good results it is important that the power setting system on both sides is state-of-the-art (see section 4) and that the laboratory setup minimizes reflections from nearby objects. During the system installation, the validation is compared with the ETH results (often also with liquid delivered from and measured at SPEAG) to check for deviations due to laboratory reflections. Typically, deviations within ± 5 % from the ETH value can be reached.

**Validation repeatability**

The repeatability check of the validation is insensitive to external effects and gives an indication of the variations in the DASY3 measurement system, provided that the same power reading setup is used for all validations. The repeatability estimate is given in the following table:

	Repeatab.	Repeatab. Distribution	SAR Std. Dev.	
			Typical setup	State-of-the-art setup
Probe isotropy			± 0 %	=
Probe linearity	± 0.1 dB	rectangular	± 0 %	=
Probe calibration	± 2 %	normal	± 0 %	=
Electronics	± 1 %	rectangular	± 0 %	=
Drift	± 1 %	normal	± 1 %	=
1g peak SAR evaluation	± 0.6 %	normal	± 0.6 %	=
Source to liquid separation	± 0.05 mm	rectangular	± 0.3 %	=
Dipole variations	± 0 %	normal	± 0 %	=
Liquid conductivity	± 5 %	rectangular	± 2.9 %	± 1.5 %
Source power repeatability	± 0.2 dB	normal	± 2 %	± 1 %
Laboratory reflections	± 3 %	normal	± 0 %	± 0 %
Total repeatability	K=1		± 3.75 %	± 2.25 %
Total extended repeatab.	K=2		± 7 %	± 4.5 %

The expected repeatability deviation is low. If the liquid is stable, the short time repeatability should be around ± 1.5% (K=1). Excessive drift (e.g. drift in liquid parameters), partial system failures or incorrect parameter settings (e.g. wrong probe or device settings) will lead to unexpectedly high repeatability deviations. While the interlaboratory comparison gives an indication of the system performance at the initial setup or after changes in the setup, the repeatability gives an indication that the system operates within its initial specifications. Excessive drift, system failure and operator errors are easily detected.

**4.1.1.4 Power set-up for validation**

The uncertainty of the dipole input power is a significant contribution to the absolute uncertainty and the expected deviation in interlaboratory comparisons. The values in Section 2 for a typical and a sophisticated setup are just average values. Refer to the manual of the power meter and the detector head for the evaluation of the uncertainty

in your system. The uncertainty also depends on the source matching and the general setup. Below follows the description of a recommended setup and procedures to increase the accuracy of the power reading:

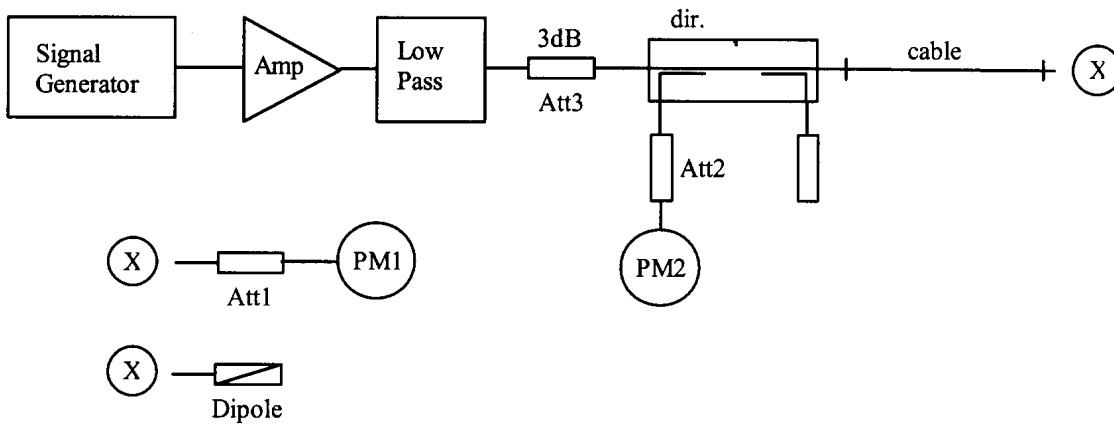

The figure shows the recommended setup. The PM1 (incl. Att1) measures the forward power at the location of the validation dipole connector. The signal generator is adjusted for the desired forward power at the dipole connector and the power meter PM2 is read at that level. After connecting the cable to the dipole, the signal generator is readjusted for the same reading at power meter PM2. If the signal generator does not allow a setting in 0.01dB steps, the remaining difference at PM2 must be noted and considered in the normalization of the validation results. The requirements for the components are:

- The signal generator and amplifier should be stable (after warm-up). The forward power to the dipole should be above 10mW to avoid the influence of measurement noise. If the signal generator can deliver 15dBm or more, an amplifier is not necessary. Some high power amplifiers should not be operated at a level far below their maximum output power level (e.g. a 100W power amplifier operated at 250mW output can be quite noisy). An attenuator between the signal generator and amplifier is recommended to protect the amplifier input.
- The low pass filter after the amplifier reduces the effect of harmonics and noise from the amplifier. For most amplifiers in normal operation the filter is not necessary.
- The attenuator after the amplifier improves the source matching and the accuracy of the power head. (See power meter manual.) It can also be used also to make the amplifier operate at its optimal output level for noise and stability. In a setup without directional coupler, this attenuator should be at least 10dB.
- The directional coupler (recommended <sup>3</sup> 20dB) is used to monitor the forward power and adjust the signal generator output for constant forward power. A medium quality coupler is sufficient because the loads (dipole and power head) are well matched. (If the setup is used for reflective loads, a high quality coupler with respect to directivity and output matching is necessary to avoid additional errors.)
- The power meter PM2 should have a low drift and a resolution of 0.01dBm, but otherwise its accuracy has no impact on the power setting. Calibration is not required.
- The cable between the coupler and dipole must be of high quality, without large attenuation and phase changes when it is moved. Otherwise, the power meter head PM1 should be brought to the location of the dipole for measuring.
- The power meter PM1 and attenuator Att1 must be high quality components. They should be calibrated, preferably together. The attenuator (<sup>3</sup>10dB) improves the accuracy of the power reading. (Some higher power heads come with a built-in calibrated attenuator.) The exact attenuation of the attenuator at the frequency used must be known; many attenuators are up to 0.2dB off from the specified value.
- Use the same power level for the power setup with power meter PM1 as for the actual measurement to avoid linearity and range switching errors in the power meter PM2. If the validation is performed at various power levels, do the power setting procedure at each level.

- The dipole must be connected directly to the cable at location “X”. If the power meter has a different connector system, use high quality couplers. Preferably, use the couplers at the attenuator Att1 and calibrate the attenuator with the coupler.
- Always remember: We are measuring power, so 1% is equivalent to 0.04dB.

#### 4.1.1.5 Laboratory reflections

In near-field situations, the absorption is predominantly caused by induction effects from the magnetic near-field. The absorption from reflected fields in the laboratory is negligible. On the other hand, the magnetic field around the dipole depends on the currents and therefore on the feedpoint impedance. The feedpoint impedance of the dipole is mainly determined from the proximity of the absorbing phantom, but reflections in the laboratory can change the impedance slightly. A 1% increase in the real part of the feedpoint impedance will produce approximately a 1% decrease in the SAR for the same forward power. The possible influence of laboratory reflections should be investigated during installation. The validation setup is suitable for this check, since the validation is sensitive to laboratory reflections. The same tests can be performed with a mobile phone, but most phones are less sensitive to reflections due to the shorter distance to the phantom. The fastest way to check for reflection effects is to position the probe in the phantom above the feedpoint and start a continuous field measurement in the DASY3 multimeter window. Placing absorbers in front of possible reflectors (e.g. on the ground near the dipole or in front of a metallic robot socket) will reveal their influence immediately. A 10dB absorber (e.g. ferrite tiles or flat absorber mats) is probably sufficient, as the influence of the reflections is small anyway. If you place the absorber too near the dipole, the absorber itself will interact with the reactive near-field. Instead of measuring the SAR, it is also possible to monitor the dipole impedance with a network analyzer for reflection effects. The network analyzer must be calibrated at the SMA connector and the electrical delay (two times the forward delay in the dipole document) must be set in the NWA for comparisons with the reflection data in the dipole document. If the absorber has a significant influence on the results, the absorber should be left in place for validation or measurements. The reference data in the dipole document are produced in a low reflection environment.

#### 4.1.1.6 Additional system checks

While the validation gives a good check of the DASY3 system components, it does not include all parameters necessary for real phone measurements (e.g. device modulation or device positioning). For system validation (repeatability) or comparisons between laboratories a reference device can be useful. This can be any mobile phone with a stable output power (preferably a device whose output power can be set through the keyboard). For comparisons, the same device should be sent around, since the SAR variations between samples can be large. Several measurement possibilities in the DASY software allow additional tests of the performance of the DASY system and components. These tests can be useful to localize component failures:

- The validation can be performed at different power levels to check the noise level or the correct compensation of the diode compression in the probe.
- If a pulsed signal with high peak power levels is fed to the dipole, the performance of the diode compression compensation can be tested. The correct crest factor parameter in the DASY software must be set (see manual). The system should give the same SAR output for the same averaged input power.
- The probe isotropy can be checked with a 1D-probe rotation scan above the feedpoint. The automatic probe alignment procedure must be passed through for accurate probe rotation movements (optional DASY3 feature with a robot-mounted light beam unit). Otherwise the probe tip might move on a small circle during rotation, producing some additional isotropy errors in gradient fields.