

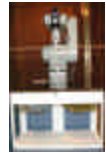

# PCTEST ENGINEERING LABORATORY, INC.

6660-B Dobbin Road, Columbia, MD 21045 USA  
Tel. 410.290.6652 / Fax 410.290.6554  
<http://www.pctestlab.com>



## CERTIFICATE OF COMPLIANCE (SAR EVALUATION)

**Applicant Name:**  
Samsung Electronics Co., LTD  
3351 Michelson Drive, Suite 290  
Irvine, CA 92612

**Date of Testing:**  
June 20, 2005 - June 22, 2005  
**Test Site/Location:**  
PCTEST Lab, Columbia, MD, USA  
**Test Report Serial No.:**  
0506140433

**FCC ID:** A3LSGHD600  
**APPLICANT:** SAMSUNG ELECTRONICS CO., LTD

**Application Type:** Certification  
**FCC Rule Part(s):** § 24(E), §22(H); §2  
**FCC Classification:** Licensed Transmitter Held to Ear (PCE)  
**EUT Type:** Dual-Band GSM Phone  
**Model(s):** SGH-D600, SGH-D608  
**Tx Frequency:** 824.20MHz - 848.8MHz (Cellular GSM)  
1850.20MHz - 1909.8MHz (PCS GSM)  
**RF Output Power:** 1.254 W ERP Cellular GSM (30.983 dBm)  
1.928 W ERP PCS GSM (32.851 dBm)

**Max. SAR Measurement:** Cellular GSM: 0.25 W/kg Head SAR, 0.80 W/kg Body SAR  
PCS GSM: 0.45 W/kg Head SAR, 1.40 W/kg Body SAR

**Test Device Serial No.:** Pre-Production Sample [S/N: R5UY545566V]

This wireless portable device has been shown to be capable of compliance for localized specific absorption rate (SAR) for uncontrolled environment/general population exposure limits specified in ANSI/IEEE Std. C95.1-1992 and had been tested in accordance with the measurement procedures specified in FCC/OET Bulletin 65 Supplement C (2001) and IEEE Std. 1528 – 2003.



I attest to the accuracy of data. All measurements reported herein were performed by me or were made under my supervision and are correct to the best of my knowledge and belief. I assume full responsibility for the completeness of these measurements and vouch for the qualifications of all persons taking them.

Grant Conditions: Power output listed is ERP for Part 22 and EIRP for Part 24. SAR compliance for body-worn operating configuration is based on a separation distance of 1.5 cm between the back of the unit and the body of the user. End-users must be informed of the body-worn operating requirements for satisfying RF exposure compliance. Belt clips or holsters may not contain metallic components.

*PCTEST certifies that no party to this application has been denied the FCC benefits pursuant to Section 5301 of the Anti-Drug Abuse Act of 1988, 21 U.S.C. 862.*

  
Alfred Cirwithian  
Vice President Engineering





PCTEST SAR REPORT		SAR SUMMARY REPORT		Reviewed by: Quality Manager
SAR Filename: 0506140433	Test Dates: June 20,2005 – June 22, 2005	EUT Type: Dual-Band GSM Phone	FCC ID: A3LSGHD600	Page 1 of 25

# T A B L E O F C O N T E N T S

---

1.	INTRODUCTION .....	3
2.	TEST SITE LOCATION.....	4
3.	SAR MEASUREMENT SETUP .....	5
4.	ALIDX-500 E-FIELD PROBE SYSTEM .....	6
5.	PROBE CALIBRATION PROCESS .....	7
6.	PHANTOM AND EQUIVALENT TISSUES .....	8
7.	TEST SYSTEM SPECIFICATIONS .....	10
8.	DOSIMETRIC ASSESSMENT AND PHANTOM SPECS .....	11
9.	DEFINITION OF REFERENCE POINTS .....	12
10.	TEST CONFIGURATION POSITION .....	13
11.	ANSI/IEEE C95.1 - 1992 RF EXPOSURE LIMITS .....	14
12.	MEASUREMENT UNCERTAINTIES.....	15
13.	SAR TEST EQUIPMENT .....	16
14.	CONCLUSION .....	17
15.	REFERENCES.....	18
	EXHIBIT A. SYSTEM VERIFICATION .....	19
	EXHIBIT B. SAR SETUP PROCEDURES .....	20
	EXHIBIT B. SAR DATA SUMMARY .....	21

<b>PCTEST SAR REPORT</b>		<b>SAR SUMMARY REPORT</b>		<b>Reviewed by:</b> Quality Manager
<b>SAR Filename:</b> 0506140433	<b>Test Dates:</b> June 20, 2005 – June 22, 2005	<b>EUT Type:</b> Dual-Band GSM Phone	<b>FCC ID:</b> A3LSGHD600	Page 2 of 25

# 1. INTRODUCTION

The FCC has adopted the guidelines for evaluating the environmental effects of radio frequency (RF) radiation in ET Docket 93-62 on Aug. 6, 1996 to protect the public and workers from the potential hazards of RF emissions due to FCC-regulated portable devices.[1]

The safety limits used for the environmental evaluation measurements are based on the criteria published by the American National Standards Institute (ANSI) for localized specific absorption rate (SAR) in IEEE/ANSI C95.1-1992 Standard for Safety Levels with Respect to Human Exposure to Radio Frequency Electromagnetic Fields, 3 kHz to 300 GHz. (c) 1992 by the Institute of Electrical and Electronics Engineers, Inc., New York, New York 10017.[2] The measurement procedure described in IEEE/ANSI C95.3-1992 Recommended Practice for the Measurement of Potentially Hazardous Electromagnetic Fields - RF and Microwave[3] is used for guidance in measuring the Specific Absorption Rate (SAR) due to the RF radiation exposure from the Equipment Under Test (EUT). These criteria for SAR evaluation are similar to those recommended by the National Council on Radiation Protection and Measurements (NCRP) in Biological Effects and Exposure Criteria for Radiofrequency Electromagnetic Fields," NCRP Report No. 86 (c) NCRP, 1986, Bethesda, MD 20814.[6] SAR is a measure of the rate of energy absorption due to exposure to an RF transmitting source. SAR values have been related to threshold levels for potential biological hazards.

## SAR Definition

Specific Absorption Rate is defined as the time derivative (rate) of the incremental energy (dU) absorbed by (dissipated in) an incremental mass (dm) contained in a volume element (dV) of a given density (ρ). It is also defined as the rate of RF energy absorption per unit mass at a point in an absorbing body (see Fig. 1-1).

$$SAR = \frac{d}{dt} \left( \frac{dU}{dm} \right) = \frac{d}{dt} \left( \frac{dU}{\rho dV} \right)$$

**Figure 1-1**  
**SAR Mathematical Equation**

**SAR is expressed in units of Watts per Kilogram (W/kg).**

$$SAR = \sigma E^2 / \rho$$

where:

- σ = conductivity of the tissue-simulant material (S/m)
- ρ = mass density of the tissue-simulant material (kg/m<sup>3</sup>)
- E = Total RMS electric field strength (V/m)

NOTE: The primary factors that control rate of energy absorption were found to be the wavelength of the incident field in relation to the dimensions and geometry of the irradiated organism, the orientation of the organism in relation to the polarity of field vectors, the presence of reflecting surfaces, and whether conductive contact is made by the organism with a ground plane.[6]

<b>PCTEST SAR REPORT</b>		<b>SAR SUMMARY REPORT</b>		<b>Reviewed by:</b> Quality Manager
<b>SAR Filename:</b> 0506140433	<b>Test Dates:</b> June 20,2005 – June 22, 2005	<b>EUT Type:</b> Dual-Band GSM Phone	<b>FCC ID:</b> A3LSGHD600	Page 3 of 25

## 2. TEST SITE LOCATION

### 2.1 Introduction

The map to the right shows the location of PCTEST ENGINEERING LABORATORY in Columbia, Maryland. It is in proximity to the FCC Laboratory, the Baltimore-Washington International (BWI) airport, and the city of Baltimore and Washington, DC (See Figure 2-1).

These measurement tests were conducted at the PCTEST Engineering Laboratory, Inc. facility in New Concept Business Park, Guilford Industrial Park, Columbia, Maryland. The site address is 6660-B Dobbin Road, Columbia, MD 21045. The test site is one of the highest points in the Columbia area with an elevation of 390 feet above mean sea level. The site coordinates are 39° 11'15" N latitude and 76° 49' 38" W longitude. The facility is 1.5 miles north of the FCC laboratory and the ambient signal and ambient signal strength are approximately equal to those of the FCC laboratory. There are no FM or TV transmitters within 15 miles of the site. The detailed description of the measurement facility was found to be in compliance with the requirements of § 2.948 according to ANSI C63.4 on October 19, 2002.

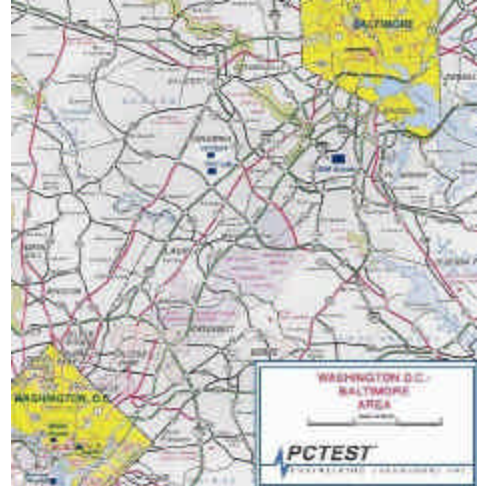

**Figure 2-1**  
Map of the Greater Baltimore and Metropolitan Washington, D.C. area

### 2.2 Test Facility / NVLAP Accreditation:

Measurements were performed at an independent accredited PCTEST Engineering Lab located in Columbia, MD 21045, U.S.A.



- PCTEST facility is an FCC registered (PCTEST Reg. No. 90864) test facility with the site description report on file and has met all the requirements specified in Section 2.948 of the FCC Rules and Industry Canada (IC-2451).
- PCTEST Lab is accredited to ISO 17025 by U.S. National Institute of Standards and Technology (NIST) under the National Voluntary Laboratory Accreditation Program (NVLAP Lab code: 100431-0) in EMC, FCC and Telecommunications.
- PCTEST Lab is accredited to ISO 17025 by the American Association for Laboratory Accreditation (A2LA) in Specific Absorption Rate (SAR) testing, CTIA Test Plans, and wireless testing for FCC and Industry Canada Rules.
- PCTEST Lab is a recognized U.S. Conformity Assessment Body (CAB) in EMC and R&TTE (n.b. 0982) under the U.S.-EU Mutual Recognition Agreement (MRA).
- PCTEST TCB is a Telecommunication Certification Body (TCB) accredited to ISO/IEC Guide 65 by the American National Standards Institute (ANSI) in all scopes of FCC Rules.
- PCTEST facility is an IC registered (IC-2451) test laboratory with the site description on file at Industry Canada.
- PCTEST is a CTIA Authorized Test Laboratory (CATL) in AMPS and CDMA mobile phones.

PCTEST SAR REPORT		SAR SUMMARY REPORT		Reviewed by: Quality Manager
SAR Filename: 0506140433	Test Dates: June 20, 2005 – June 22, 2005	EUT Type: Dual-Band GSM Phone	FCC ID: A3LSGHD600	Page 4 of 25

### 3. SAR MEASUREMENT SETUP

#### Robotic System

Measurements are performed using the ALIDX-500 automated dosimetric assessment system. The ALIDX-500 is made by IDX Robotics, Inc. (IDX) in the United States and consists of high precision robotics system (CRS), robot controller, Pentium 4 computer, near-field probe, probe alignment sensor, and the Left and Right SAM phantoms containing the head/brain equivalent tissue, and the flat phantoms for body/muscle equivalent. The robot is a six-axis industrial robot performing precise movements to position the probe to the location (points) of maximum electromagnetic field (EMF) (see Fig. 3-1).

#### System Hardware

The Robot table consists of the power supply, robot controller, safety computer, teach pendant (Joystick), six-axis robot arm, and the probe. The cell controller consists of DELL Dimension 4300 Pentium-4 1.6 GHz computer with Windows 2000 system and SAR Measurement software, National Instruments analog card, monitor, keyboard, and mouse. The robot controller is connected to the cell controller to communicate between the two computers. The probe data is connected to the cell controller via data acquisition cables.

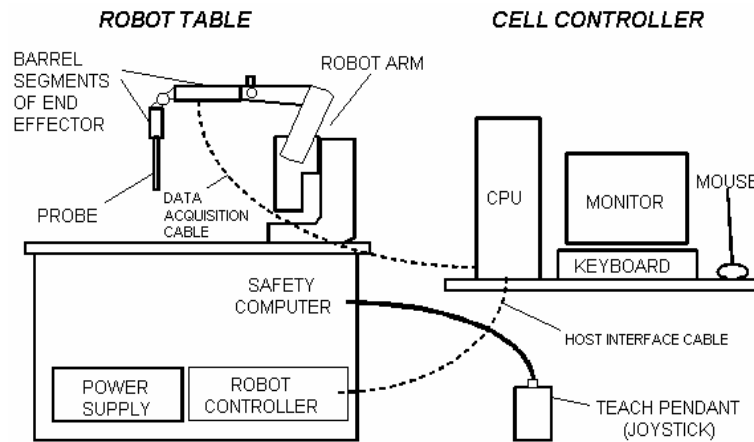

#### System Electronics



**Figure 3-1**  
**SAR Measurement System Setup**

When the robot is in the home position, the Y-axis of the coordinate system parallels the line of intersection between the tabletop and the long axis of the Robot's Large Shoulder. The Teach Pendant may be used to establish the X,Y coordinate directions by depressing the 0-X and 0-Y MOTOR/AXIS switches while in axis mode.

The robot is first taught to position the probe sensor following a specific pattern of points. In the first sweep, the sensor enclosure touches the inside of the phantom head. The SAR is measured on a defined grid of points that are concentrated on the surface of the head closest to the antenna of the transmitting device (EUT).

<b>PCTEST SAR REPORT</b>		<b>SAR SUMMARY REPORT</b>		<b>Reviewed by:</b> Quality Manager
<b>SAR Filename:</b> 0506140433	<b>Test Dates:</b> June 20, 2005 – June 22, 2005	<b>EUT Type:</b> Dual-Band GSM Phone	<b>FCC ID:</b> A3LSGHD600	Page 5 of 25

## 4. ALIDX-500 E-FIELD PROBE SYSTEM

### Probe Measurement System



Figure 4-1  
IDX System

The near-field probe is an implantable isotropic E-field probe that measures the voltages proportional to the  $|E|^2$  (electric) or  $|H|^2$  (magnetic) fields. The probe is enclosed in a hollow glass protective cylinder with a 9mm. outer diameter, 0.5 mm. thickness and 30 cm. length. The E-probe contains three electrically small array of orthogonal dipoles strategically placed to provide greater accuracy and to compensate for near-field spatial gradients. The probe contains diodes that are placed over the gap of the dipoles to improve RF detection. The electrical signal detected by each diode is amplified by three DC amplifiers, which are contained in a shielded container in the robot end effector, so its performance is not affected by the presence of incident electromagnetic fields (see Fig. 4-1).

### Probe Specifications

<b>Frequency Range:</b>	10 kHz – 6.0 GHz
<b>Calibration:</b>	In air from 10 MHz to 6.0 GHz
	In brain and muscle simulating tissue at Frequencies from 835 up to 5800MHz
<b>Sensitivity:</b>	3.5 mV/mW/cm <sup>2</sup> (air – typical)
<b>DC Resistance:</b>	300 kΩ
<b>Isotropic Response:</b>	0.25 dB
<b>Dynamic Range:</b>	10 mW/kg – 100 W/kg
<b>Resistance to Pull:</b>	25 N
<b>Probe Length:</b>	290 mm
<b>Probe Tip Material:</b>	Glass
<b>Probe Tip Length:</b>	40 mm
<b>Application:</b>	7 ± 0.2 mm
	SAR Dosimetry Testing
	Compliance tests of mobile phones



Figure 4-2  
Triangular Probe Configuration

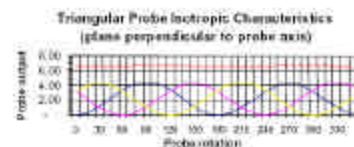

Figure 4-3

PCTEST SAR REPORT		SAR SUMMARY REPORT		Reviewed by: Quality Manager
SAR Filename: 0506140433	Test Dates: June 20,2005 – June 22, 2005	EUT Type: Dual-Band GSM Phone	FCC ID: A3LSGHD600	Page 6 of 25

## 5. PROBE CALIBRATION PROCESS

### Dosimetric Assessment Procedure

Each E-Probe/Probe amplifier combination has unique calibration parameters. A TEM calibration procedure is conducted to determine the proper amplifier settings to enter in the probe parameters. The amplifier settings are determined for a given frequency by subjecting the probe to a known E-field density (1 mW/cm<sup>2</sup>) using an RF Signal generator, TEM cell, and RF Power Meter. The SAR measurement software is used for probe calibration.

### Free Space Assessment

The free space E-field from amplified probe outputs is determined in a test chamber. This calibration can be performed in a TEM cell if the frequency is below 1 GHz and in a waveguide or other methodologies above 1 GHz for free space. For the free space calibration, we place the probe in the volumetric center of the cavity and at the proper orientation with the field. We then rotate the probe 360 degrees until the three channels show the maximum reading. The power density readings equates to 1 mW/cm<sup>2</sup>.

### Temperature Assessment

E-field temperature correlation calibration is performed in a flat phantom filled with the appropriate simulated brain tissue. The measured free space E-field in the medium correlates to temperature rise in a dielectric medium. For temperature correlation calibration a RF transparent thermistor-based temperature probe is used in conjunction with the E-field probe.

$SAR = C \frac{\Delta T}{\Delta t}$ <p>where:  <math>\Delta t</math> = exposure time (30 seconds),  <math>C</math> = heat capacity of tissue (brain or muscle),  <math>\Delta T</math> = temperature increase due to RF exposure.</p> <p>SAR is proportional to <math>\Delta T/\Delta t</math>, the initial rate of tissue heating, before thermal diffusion takes place. Now it's possible to quantify the electric field in the simulated tissue by equating the thermally derived SAR to the E- field;</p>	$SAR = \frac{ E ^2 \cdot s}{r}$ <p>where:  <math>\sigma</math> = simulated tissue conductivity,  <math>\rho</math> = Tissue density (1.25 g/cm<sup>3</sup> for brain tissue)</p>
---	--

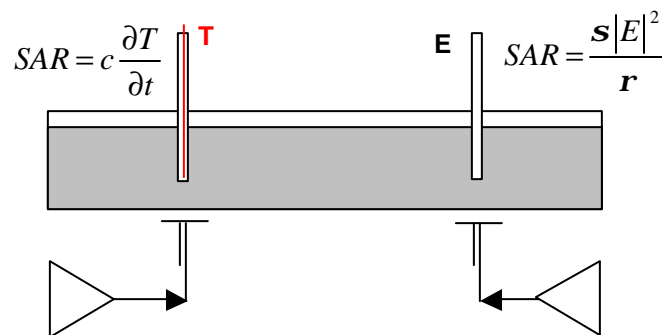

**Figure 5-1 Temperature Assessment Test Configuration**

PCTEST SAR REPORT		SAR SUMMARY REPORT		Reviewed by: Quality Manager
SAR Filename: 0506140433	Test Dates: June 20, 2005 – June 22, 2005	EUT Type: Dual-Band GSM Phone	FCC ID: A3LSGHD600	Page 7 of 25

## 6. PHANTOM AND EQUIVALENT TISSUES



**Figure 6-1  
SAM Phantoms**

The Left and Right SAM Phantoms are constructed of a vivac composite integrated in a corian stand. The shape of the shell is based on data from an anatomical study designed to determine the maximum exposure in at least 90% of all users [7][8]. It enables the dosimetric evaluation of left and right hand phone usage as well as body mounted usage at the flat phantom region. A cover prevents the evaporation of the liquid. Reference markings on the phantom allow the complete setup of all predefined phantom positions and measurement grids by manually teaching three points in the robot. (see Fig. 6-1)

### Brain & Muscle Simulating Mixture Characterization

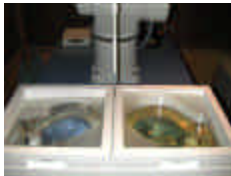

**Figure 6-2  
Head Simulated**

The brain and muscle mixtures consist of a viscous gel using hydroxyethylcellulose (HEC) gelling agent and saline solution (see Table 6-1). Preservation with a bactericide is added and visual inspection is made to make sure air bubbles are not trapped during the mixing process. The mixture is calibrated to obtain proper dielectric constant (permittivity) and conductivity values of the desired tissue. The head tissue dielectric parameters recommended by the IEEE SCC-34/SC-2 have been incorporated in the following table. Other head and body tissue parameters that have not been specified in P1528 are derived from the issue dielectric parameters computed from the 4-Cole-Cole equations. The mixture characterizations used for the brain and muscle tissue simulating liquids are according to the data by C. Gabriel and G. Hartsgrove [9].(see Table 6-1)

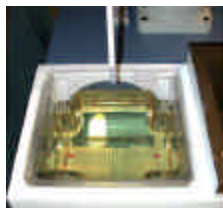

**Figure 6-3  
Body/Muscle  
Simulated Tissue**

Ingredients (% by weight)	Frequency (MHz)									
	450		815		915		1900		2450	
Tissue Type	Head	Body	Head	Body	Head	Body	Head	Body	Head	Body
Water	38.56	51.16	41.45	52.4	41.05	56.0	54.9	40.4	62.7	73.2
Salt (NaCl)	3.55	1.49	1.45	1.4	1.35	0.76	0.38	0.5	0.5	0.04
Sugar	56.32	46.78	56.0	45.0	56.5	41.75	0.0	58.0	0.0	0.0
HEC	0.98	0.52	1.0	1.0	1.0	1.21	0.0	1.0	0.0	0.0
Bactericide	0.19	0.05	0.1	0.1	0.1	0.27	0.0	0.1	0.0	0.0
Triton X-100	0.0	0.0	0.0	0.0	0.0	0.0	0.0	0.0	56.8	0.0
DGBE	0.0	0.0	0.0	0.0	0.0	0.0	44.92	0.0	0.0	26.7

Salt: 99 % Pure Sodium Chloride      Sugar: 96 % Pure Sucrose  
 Water: De-ionized, 16 MΩ resistivity      HEC: Hydroxyethyl Cellulose  
 DGBE: 99 % Di(ethylene glycol) butyl ether, [2-(2-hydroxyethoxy)ethanol]  
 Triton X-100 (ultra pure): Polyethylene glycol mono [4-(1,1,3,3-tetramethylbutyl)phenyl] ether

**Table 6-1  
Composition of the Brain & Muscle Tissue Equivalent Matter**

PCTEST SAR REPORT		SAR SUMMARY REPORT		Reviewed by: Quality Manager
SAR Filename: 0506140433	Test Dates: June 20,2005 – June 22, 2005	EUT Type: Dual-Band GSM Phone	FCC ID: A3LSGHD600	Page 8 of 25



## Device Holder



**Figure 6-4**  
**Device Positioner**

In combination with the SAM Phantom, the EUT Holder (see Fig. 6-4) enables the rotation of the mounted transmitter in spherical coordinates whereby the rotation point is the ear opening. Device positioning is accurate and repeatable according to the FCC and CENELEC specifications. The device holder can be locked at different phantom locations (left head, right head, and flat phantom).

\* Note: A simulating human hand is not used due to the complex anatomical and geometrical structure of the hand that may produce an infinite number of configurations [8]. To produce the worst-case condition (the hand absorbs antenna output power), the hand is omitted during the tests.

<b>PCTEST SAR REPORT</b>		<b>SAR SUMMARY REPORT</b>		<b>Reviewed by:</b> Quality Manager
<b>SAR Filename:</b> 0506140433	<b>Test Dates:</b> June 20, 2005 – June 22, 2005	<b>EUT Type:</b> Dual-Band GSM Phone	<b>FCC ID:</b> A3LSGHD600	Page 9 of 25

## 7. TEST SYSTEM SPECIFICATIONS

### Automated Test System Specifications

#### Positioner

**Robot:** CRS Robotics, Inc. Robot Model: F3  
**Repeatability:**  $\pm 0.05$  mm (0.002 in.)  
**No. of axes:** 6

#### Data Acquisition Electronic (DAE) System

##### Cell Controller

**Processor:** Pentium 4  
**Clock Speed:** 1.6 GHz  
**Operating System:** Windows 2000™ Professional  
**Data Card:** NI DAQ Card (in CPU)

##### Data Converter

**Software:** IDX Flexware  
**Connecting Lines:** Data Acquisition Cable  
 RS-232 Host Interface Cable  
**Sampling Rate:** 6000 samples/sec

##### E-Field Probes



**Model:** E-020 S/N: PCT005  
**Construction:** Triangular core absolute encoder system  
**Frequency:** 10 MHz to 6.0 GHz

##### Phantom

**Phantom:** SAM Phantoms (Left & Right)  
**Shell Material:** Vivac Composite  
**Thickness:**  $2.0 \pm 0.2$  mm



**Figure 7-1  
ALIDX-500 Test System**

PCTEST SAR REPORT		SAR SUMMARY REPORT		Reviewed by: Quality Manager
SAR Filename: 0506140433	Test Dates: June 20, 2005 – June 22, 2005	EUT Type: Dual-Band GSM Phone	FCC ID: A3LSGHD600	Page 10 of 25

## 8. DOSIMETRIC ASSESSMENT AND PHANTOM SPECS

### Measurement Procedure

The measurement procedure consists of the process parameters, probe parameters, EUT product data, and measurement scans (teach points). The measurement procedure is a set of predefined points to be scanned and measured by the probe, DC amplified and processed by the cell controller. The corresponding voltages determined by the electric and magnetic fields are extrapolated to determine peak SAR value.

The SAR Measurement System measures field strength by employing two different types of systematic measurement scans; a coarse scan and a fine scan. Coarse and fine scans measure field strength in a rectangular area within the XY plane (a plane parallel to the top of the Robot Table). The measurement area is divided into a grid of small squares defined by equally spaced grid lines. During an actual measurement process, the probe moves along grid lines, systematically recording the field strength at grid line intersections. Typically, after a coarse scan is completed, a fine scan is conducted at the peak field strength value (hot spot) that was measured in the coarse scan. The fine scan has a greater resolution (smaller grid squares) than the coarse scan and covers only a fraction of the measurement area in the coarse scan.



*Deviation from measurement procedure – None*

### Specific Anthropomorphic Mannequin (SAM) Specifications

The phantom for handset SAR assessment testing is a low-loss dielectric shell, with shape and dimensions derived from the anthropometric data of the 90th percentile adult male head dimensions as tabulated by the United States Army. The SAM Phantom shell is bisected along the mid-sagittal plane into right and left halves (see Fig. 8-1). The perimeter sidewalls of each phantom halves are extended to allow filling with liquid to a depth that is sufficient to minimize reflections from the upper surface. The liquid depth is maintained at a minimum depth of 15cm to minimize reflections from the upper surface. The SAM shell thickness is  $2.0 \pm 0.2$  mm.



**Figure 8-1**  
**Left and Right SAM Phantom shells**

PCTEST SAR REPORT		SAR SUMMARY REPORT		Reviewed by: Quality Manager
SAR Filename: 0506140433	Test Dates: June 20, 2005 – June 22, 2005	EUT Type: Dual-Band GSM Phone	FCC ID: A3LSGHD600	Page 11 of 25

## 9. DEFINITION OF REFERENCE POINTS

### Ear Reference Point (ERP)

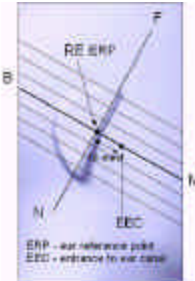

Figure 9-1 Close-up side view of ERPs

Figure 9-1 shows the front, back and side views of the SAM Twin Phantom. The point “M” is the reference point for the center of the mouth, “LE” is the left ear reference point (ERP), and “RE” is the right ERP. The ERPs are 15mm posterior to the entrance to the ear canal (EEC) along the B-M line (Back-Mouth), as shown in Figure 92. The plane passing through the two ear canals and M is defined as the Reference Plane. The line N-F (Neck-Front) is perpendicular to the reference plane and passing through the RE (or LE) is called the Reference Pivoting Line (see Figure 92). Line B-M is perpendicular to the N-F line. Both N-F and B-M lines are marked on the external phantom shell to facilitate handset positioning [5].



Figure 9-2 Front, back and side view of SAM Twin Phantom

### Handset Reference Points

Two imaginary lines on the handset were established: the vertical centerline and the horizontal line. The test device was placed in a normal operating position with the “test device reference point” located along the “vertical centerline” on the front of the device aligned to the “ear reference point” (See Fig. 9-3). The “test device reference point” was then located at the same level as the center of the ear reference point. The test device was positioned so that the “vertical centerline” was bisecting the front surface of the handset at it’s top and bottom edges, positioning the “ear reference point” on the outer surface of the both the left and right head phantoms on the ear reference point.

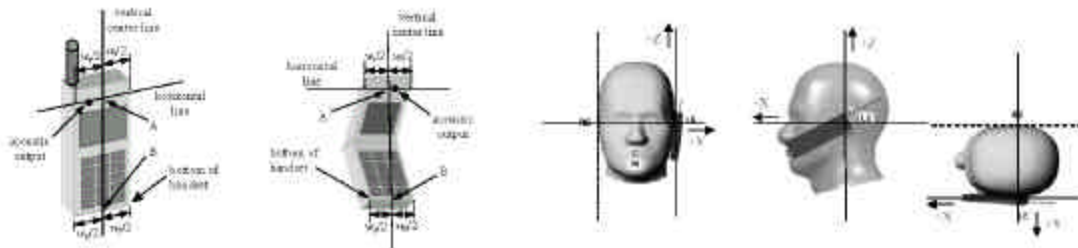



Figure 9-3 Handset Vertical Center & Horizontal Line Reference Points

PCTEST SAR REPORT		SAR SUMMARY REPORT		Reviewed by: Quality Manager
SAR Filename: 0506140433	Test Dates: June 20,2005 – June 22, 2005	EUT Type: Dual-Band GSM Phone	FCC ID: A3LSGHD600	Page 12 of 25

## 10. TEST CONFIGURATION POSITION

### Body Holster /Belt Clip Configurations

Body-worn operating configurations are tested with the belt-clips and holsters attached to the device and positioned against a flat phantom in a normal use configuration (see Figure 10-1). A device with a headset output is tested with a headset connected to the device. Body dielectric parameters are used.

Accessories for Body-worn operation configurations are divided into two categories: those that do not contain metallic components and those that do contain metallic components. When multiple accessories that do not contain metallic components are supplied with the device, the device is tested with only the accessory that dictates the closest spacing to the body. Then multiple accessories that contain metallic components are supplied with the device, the device is tested with each accessory that contains a unique metallic component. If multiple accessories share an identical metallic component (i.e. the same metallic belt-clip used with different holsters with no other metallic components) only the accessory that dictates the closest spacing to the body is tested.

Body-worn accessories may not always be supplied or available as options for some devices intended to be authorized for body-worn use. In this case, a test configuration where a separation distance between the back of the device and the flat phantom is used. All test position spacings are documented.



Transmitters that are designed to operate in front of a person's face, as in push-to-talk configurations, are tested for SAR compliance with the front of the device positioned to face the flat phantom. For devices that are carried next to the body such as a shoulder, waist or chest-worn transmitters, SAR compliance is tested with the accessory(ies), including headsets and microphones, attached to the device and positioned against a flat phantom in a normal use configuration.

In all cases SAR measurements are performed to investigate the worst-case positioning. Worst-case positioning is then documented and used to perform Body SAR testing.

In order for users to be aware of the body-worn operating requirements for meeting RF exposure compliance, operating instructions and cautions statements must be included in the user's manual.



**Figure 10-1 Body Belt Clip & Holster Configurations**

<b>PCTEST SAR REPORT</b>		<b>SAR SUMMARY REPORT</b>		<b>Reviewed by:</b> Quality Manager
<b>SAR Filename:</b> 0506140433	<b>Test Dates:</b> June 20,2005 – June 22, 2005	<b>EUT Type:</b> Dual-Band GSM Phone	<b>FCC ID:</b> A3LSGHD600	Page 13 of 25

## 11. ANSI/IEEE C95.1 - 1992 RF EXPOSURE LIMITS

### Uncontrolled Environment

Uncontrolled environments are defined as locations where there is the exposure of individuals who have no knowledge or control of their exposure. The general population/uncontrolled exposure limits are applicable to situations in which the general public may be exposed or in which persons who are exposed as a consequence of their employment may not be made fully aware of the potential for exposure or cannot exercise control over their exposure. Members of the general public would come under this category when exposure is not employment-related; for example, in the case of a wireless transmitter that exposes persons in its vicinity.

### Controlled Environment

Controlled environments defined as locations where there is exposure that may be incurred by persons who are aware of the potential for exposure, (i.e. as a result of employment or occupation). In general, occupational/controlled exposure limits are applicable to situations in which persons are exposed as a consequence of their employment, who have been made fully aware of the potential for exposure and can exercise control over their exposure. This exposure category is also applicable when the exposure is of a transient nature due to incidental passage through a location where the exposure levels may be higher than the general population/uncontrolled limits, but the exposed person is fully aware of the potential for exposure and can exercise control over his or her exposure by leaving the area or by some other appropriate means.



	Human Exposure Limits	
	UNCONTROLLED ENVIRONMENT General Population (W/kg) or (mW/g)	CONTROLLED ENVIRONMENT General Population (W/kg) or (mW/g)
SPATIAL PEAK SAR Brain	1.60	8.00
SPATIAL AVERAGE SAR Whole Body	0.08	0.40
SPATIAL PEAK SAR Hands, Feet, Ankles, Wrists	4.00	20.00

**Table 11-1. Safety Limits for Partial Body Exposure [2]**

1 The Spatial Peak value of the SAR averaged over any 1 gram of tissue (defined as a tissue volume in the shape of a cube) and over the appropriate averaging time.

2 The Spatial Average value of the SAR averaged over the whole body.



3 The Spatial Peak value of the SAR averaged over any 10 grams of tissue (defined as a tissue volume in the shape of a cube) and over the appropriate averaging time.

<b>PCTEST SAR REPORT</b>		<b>SAR SUMMARY REPORT</b>		<b>Reviewed by:</b> Quality Manager
<b>SAR Filename:</b> 0506140433	<b>Test Dates:</b> June 20, 2005 – June 22, 2005	<b>EUT Type:</b> Dual-Band GSM Phone	<b>FCC ID:</b> A3LSGHD600	Page 14 of 25

## 12. MEASUREMENT UNCERTAINTIES

a	b	c	d	e= f(d,k)	f	g	h= cxf/e	i= cxg/e	k
Uncertainty Component	Sec.	Tol. (±%)	Prob. Dist.	Div.	$c_i$ (1-g)	$c_i$ (10-g)	1-g $u_i$ (±%)	10-g $u_i$ (±%)	$v_i$
<b>Measurement System</b>									
Probe Calibration	E1.1	11.4	N	$\sqrt{3}$	1	1	6.6	6.6	$\infty$
Axial Isotropy	E1.2	3.4	R	$\sqrt{3}$	0.7	0.7	1.4	1.4	$\infty$
Hemishperical Isotropy	E1.2	5.2	R	$\sqrt{3}$	1	1	3.0	3.0	$\infty$
Boundary Effect	E1.3	4.7	R	$\sqrt{3}$	1	1	2.7	2.7	$\infty$
Linearity	E1.4	5.9	R	$\sqrt{3}$	1	1	3.4	3.4	$\infty$
System Detection Limits	E1.5	1.0	R	$\sqrt{3}$	1	1	0.6	0.6	$\infty$
Readout Electronics	E1.6	1.0	R	1	1	1	1.0	1.0	$\infty$
Response Time	E1.7	0.8	R	$\sqrt{3}$	1	1	0.5	0.5	$\infty$
Integration Time	E1.8	1.7	R	$\sqrt{3}$	1	1	1.0	1.0	$\infty$
RF Ambient Conditions	E5.1	1.2	R	$\sqrt{3}$	1	1	0.7	0.7	$\infty$
Probe Positioner Mechanical Tolerance	E5.2	0.4	R	$\sqrt{3}$	1	1	0.2	0.2	$\infty$
Probe Positioning w/ respect to Phantom Shell	E5.3	2.9	R	$\sqrt{3}$	1	1	1.7	1.7	$\infty$
Extrapolation, Interpolation & Integration Algorithms for Max. SAR Evaluation	E4.2	3.9	R	$\sqrt{3}$	1	1	2.3	2.3	$\infty$
<b>Test Sample Related</b>									
Test Sample Positioning	E3.2.1	10.6	R	$\sqrt{3}$	1	1	6.1	6.1	11
Device Holder Uncertainty	E3.1.1	8.7	R	$\sqrt{3}$	1	1	5.0	5.0	8
Output Power Variation - SAR drift measurement	5.6.2	5.0	R	$\sqrt{3}$	1	1	2.9	2.9	$\infty$
<b>Phantom &amp; Tissue Parameters</b>									
Phantom Uncertainty (Shape & Thickness tolerances)	E2.1	4.0	R	$\sqrt{3}$	1	1	2.3	2.3	$\infty$
Liquid Conductivity - deviation from target values	E2.2	5.0	R	$\sqrt{3}$	0.7	0.5	2.0	1.4	$\infty$
Liquid Conductivity - measurement uncertainty	E2.2	5.0	R	$\sqrt{3}$	0.7	0.5	2.0	1.4	$\infty$
Liquid Permittivity - deviation from target values	E2.2	5.0	R	$\sqrt{3}$	0.6	0.5	1.7	1.4	$\infty$
Liquid Permittivity - measurement uncertainty	E2.2	5.0	R	$\sqrt{3}$	0.6	0.5	1.7	1.4	$\infty$
<b>Combined Standard Uncertainty (k=1)</b>			RSS						
<b>Expanded Uncertainty (k=2)</b>									
(95% CONFIDENCE LEVEL)									
The above measurement uncertainties are according to IEEE Std. 1528 - 2003									

**Table 1  
Uncertainty Budget for SAR**

PCTEST SAR REPORT		SAR SUMMARY REPORT		Reviewed by: Quality Manager
SAR Filename: 0506140433	Test Dates: June 20,2005 – June 22, 2005	EUT Type: Dual-Band GSM Phone	FCC ID: A3LSGHD600	Page 15 of 25

## 13. SAR TEST EQUIPMENT



### Equipment Calibration

EQUIPMENT SPECIFICATIONS			
Type	Calibration Date	Serial Number	
CRS Robot F3	February 2005	RAF0134133	
CRS C500C Motion Controller	February 2005	RCB0003303	
CRS Teach Pendant (Joystick)	February 2005	STP0132231	
DELL Computer, Pentium 4 1.6 GHz, Windows 2000TM	February 2005	4PJZ111	
E-Field Probe E-020	January 2005	PCT005	
Right Ear SAM Phantom (P-SAM-R)	February 2005	94X-113	
Left Ear SAM Phantom (P-SAM-L)	February 2005	94X-019	
Flat SAM Phantom (P-SAM-FLAT)	February 2005	94X-097	
IDX Robot End Effector (EE-103-C)	February 2005	07111223	
IDX Probe Amplifier	February 2005	07111113	
Validation Dipole D-835S	June 2005	PCT640	
Validation Dipole D-1900S	June 2005	PCT641	
Brain Equivalent Matter (835MHz)	June 2005	PCTBEM101	
Brain Equivalent Matter (1900MHz)	June 2005	PCTBEM301	
Muscle Equivalent Matter (835MHz)	June 2005	PCTMEM201	
Muscle Equivalent Matter (1900MHz)	June 2005	PCTMEM401	
Amplifier Research 5S1G4 Power Amp	January 2005	PCT540	
Agilent E8241A (250kHz ~ 20GHz) Signal Generator	November 2005	US42110432	
HP-8753E (30kHz ~ 6GHz) Network Analyzer	January 2005	PCT552	
HP85070B Dielectric Probe Kit	January 2005	PCT501	
Ambient Noise/Reflection, etc.	(<12mW/kg/<3%of SAR)	January 2005	Anechoic Room PCT01

**Table 14-1 Test Equipment Calibration**

**NOTE:**

Dipole Validation measurement was performed by PCTEST Lab before each test. The brain simulating material is calibrated by PCTEST using the dielectric probe system and network analyzer to determine the conductivity and permittivity (dielectric constant) of the brain-equivalent material.



PCTEST SAR REPORT		SAR SUMMARY REPORT		Reviewed by: Quality Manager
SAR Filename: 0506140433	Test Dates: June 20,2005 – June 22, 2005	EUT Type: Dual-Band GSM Phone	FCC ID: A3LSGHD600	Page 16 of 25

## 14. CONCLUSION

### Measurement Conclusion



The SAR measurement indicates that the EUT complies with the RF radiation exposure limits of the FCC. These measurements are taken to simulate the RF effects exposure under worst-case conditions. Precise laboratory measures were taken to assure repeatability of the tests. The tested device complies with the requirements in respect to all parameters subject to the test. The test results and statements relate only to the item(s) tested.

Please note that the absorption and distribution of electromagnetic energy in the body are very complex phenomena that depend on the mass, shape, and size of the body, the orientation of the body with respect to the field vectors, and the electrical properties of both the body and the environment. Other variables that may play a substantial role in possible biological effects are those that characterize the environment (e.g. ambient temperature, air velocity, relative humidity, and body insulation) and those that characterize the individual (e.g. age, gender, activity level, debilitation, or disease). Because innumerable factors may interact to determine the specific biological outcome of an exposure to electromagnetic fields, any protection guide shall consider maximal amplification of biological effects as a result of field-body interactions, environmental conditions, and physiological variables.[3]

<b>PCTEST SAR REPORT</b>		<b>SAR SUMMARY REPORT</b>		<b>Reviewed by:</b> Quality Manager
<b>SAR Filename:</b> 0506140433	<b>Test Dates:</b> June 20,2005 – June 22, 2005	<b>EUT Type:</b> Dual-Band GSM Phone	<b>FCC ID:</b> A3LSGHD600	Page 17 of 25

## 15. REFERENCES

- [1] Federal Communications Commission, ET Docket 93-62, Guidelines for Evaluating the Environmental Effects of Radiofrequency Radiation, Aug. 1996.
- [2] ANSI/IEEE C95.1 - 1991, American National Standard safety levels with respect to human exposure to radio frequency electromagnetic fields, 300kHz to 100GHz, New York: IEEE, Aug. 1992.
- [3] ANSI/IEEE C95.3 - 1991, IEEE Recommended Practice for the Measurement of Potentially Hazardous Electromagnetic Fields - RF and Microwave, New York: IEEE, 1992.
- [4] Federal Communications Commission, OET Bulletin 65 (Edition 97-01), Supplement C (Edition 01-01), Evaluating Compliance with FCC Guidelines for Human Exposure to Radiofrequency Electromagnetic Fields, July 2001.
- [5] IEEE Standards Coordinating Committee 34 – IEEE Std. 1528- 2003, Recommended Practice for Determining the Peak Spatial-Average Specific Absorption Rate (SAR) in the Human Body Due to Wireless Communications Devices
- [6] NCRP, National Council on Radiation Protection and Measurements, Biological Effects and Exposure Criteria for RadioFrequency Electromagnetic Fields, NCRP Report No. 86, 1986. Reprinted Feb. 1995.
- [7] V. Hombach, K. Meier, M. Burkhardt, E. Kuhn, N. Kuster, The Dependence of EM Energy Absorption upon Human Head Modeling at 900 MHz, IEEE Transaction on Microwave Theory and Techniques, vol. 44 no. 10, Oct. 1996, pp. 1865-1873.
- [8] N. Kuster and Q. Balzano, Energy absorption mechanism by biological bodies in the near field of dipole antennas above 300MHz, IEEE Transaction on Vehicular Technology, vol. 41, no. 1, Feb. 1992, pp. 17-23.
- [9] G. Hartsgrrove, A. Kraszewski, A. Surowiec, Simulated Biological Materials for Electromagnetic Radiation Absorption Studies, University of Ottawa, Bioelectromagnetics, Canada: 1987, pp. 29-36.
- [10] Q. Balzano, O. Garay, T. Manning Jr., Electromagnetic Energy Exposure of Simulated Users of Portable Cellular Telephones, IEEE Transactions on Vehicular Technology, vol. 44, no.3, Aug. 1995.
- [11] W.H. Press, S.A. Teukolsky, W.T. Vetterling, and B.P. Flannery, Numerical Recipes in C, The Art of Scientific Computing, Second edition, Cambridge University Press, 1992.
- [12] Federal Communications Commission, OET Bulletin 65, Evaluating Compliance with FCC Guidelines for Human Exposure to Radiofrequency Electromagnetic Fields. Supplement C, Dec. 1997.
- [13] CENELEC CLC/SC111B, European Prestandard (prENV 50166-2), Human Exposure to Electromagnetic Fields High-frequency: 10kHz-300GHz, Jan. 1995.

<b>PCTEST SAR REPORT</b>		<b>SAR SUMMARY REPORT</b>		<b>Reviewed by:</b> Quality Manager
<b>SAR Filename:</b> 0506140433	<b>Test Dates:</b> June 20,2005 – June 22, 2005	<b>EUT Type:</b> Dual-Band GSM Phone	<b>FCC ID:</b> A3LSGHD600	Page 18 of 25

# EXHIBIT A. SYSTEM VERIFICATION

## Tissue Verification

	835MHz Brain		835MHz Muscle		1900MHz Brain		1900MHz Muscle	
	Target	Measured	Target	Measured	Target	Measured	Target	Measured
Dielectric Constant	41.50	42.88	55.20	53.02	40.00	38.59	53.30	52.38
Conductivity	0.90	0.9	0.97	0.99	1.4	1.46	1.52	1.58

Table A-1 Simulated Tissue Verification

## Test System Validation



Prior to assessment, the system is verified to  $\pm 10\%$  of the specifications at 835 MHz and 1900 MHz by using the system validation kits. (Graphic Plots Attached)

System Verification TARGET & MEASURED							
Date:	Amb. Temp (?C)	Liquid Temp(?C)	Input Power (W)	Tissue Frequency (Mhz)	Targeted SAR <sub>1g</sub> (mW)	Measured SAR <sub>1g</sub> (mW)	Deviation (%)
06/20/2005	22.5	21.3	0.160	835	1.5	1.61	5.92%
06/20/2005	22.5	21.3	0.040	1900	1.6	1.58	-0.50%

Table A-2 System Validation



Figure A-1 Dipole Validation Test Setup

PCTEST SAR REPORT		SAR SUMMARY REPORT		Reviewed by: Quality Manager
SAR Filename: 0506140433	Test Dates: June 20,2005 – June 22, 2005	EUT Type: Dual-Band GSM Phone	FCC ID: A3LSGHD600	Page 19 of 25



## EXHIBIT B. SAR SETUP PROCEDURES

### Procedures Used To Establish Test Signal

The device was placed into continuous transmit mode using a call box. Such test signals offer a consistent means for testing SAR and are recommended for evaluating SAR [4].

### Device Test Conditions



The device was powered through the battery. In order to verify that the device was tested at full power, conducted output power measurements were performed before and after each SAR measurement to confirm the output power. If a power deviation of more than 5% occurred, the test was repeated.

<b>PCTEST SAR REPORT</b>		<b>SAR SUMMARY REPORT</b>		<b>Reviewed by:</b> Quality Manager
<b>SAR Filename:</b> 0506140433	<b>Test Dates:</b> June 20, 2005 – June 22, 2005	<b>EUT Type:</b> Dual-Band GSM Phone	<b>FCC ID:</b> A3LSGHD600	Page 20 of 25

## EXHIBIT B. SAR DATA SUMMARY



MEASUREMENT RESULTS (GSM850 Right Cheek)										
FREQUENCY		Mode	Power Class		Test Position	Slide Position	Antenna Type	Bluetooth	Battery	SAR (W/kg)
MHz	Ch.		PCL	dBm						
824.20	128	GSM850	5	33.00	Touch	In	Internal	OFF	Standard	0.11
836.60	190	GSM850	5	33.00	Touch	In	Internal	OFF	Standard	0.18
848.80	251	GSM850	5	33.00	Touch	In	Internal	OFF	Standard	0.25
824.20	128	GSM850	5	33.00	Touch	Out	Internal	OFF	Standard	0.04
836.60	190	GSM850	5	33.00	Touch	Out	Internal	OFF	Standard	0.07
848.80	251	GSM850	5	33.00	Touch	Out	Internal	OFF	Standard	0.09
848.80	251	GSM850	5	33.00	Touch	In	Internal	ON	Standard	0.25
MEASUREMENT RESULTS (GSM850 Right Tilt)										
FREQUENCY		Mode	Power Class		Test Position	Slide Position	Antenna Type	Bluetooth	Battery	SAR (W/kg)
MHz	Ch.		PCL	dBm						
824.20	128	GSM850	5	33.00	Tilt	In	Internal	OFF	Standard	0.09
836.60	190	GSM850	5	33.00	Tilt	In	Internal	OFF	Standard	0.15
848.80	251	GSM850	5	33.00	Tilt	In	Internal	OFF	Standard	0.21
824.20	128	GSM850	5	33.00	Tilt	Out	Internal	OFF	Standard	0.03
836.60	190	GSM850	5	33.00	Tilt	Out	Internal	OFF	Standard	0.06
848.80	251	GSM850	5	33.00	Tilt	Out	Internal	OFF	Standard	0.09
<b>ANSI / IEEE C95.1 1992 - SAFETY LIMIT</b>										
<b>Spatial Peak</b>						<b>Brain</b>				
<b>Uncontrolled Exposure/General Population</b>						<b>1.6 W/kg (mW/g)</b> averaged over 1 gram				

1. The test data reported are the worst-case SAR value with the antenna-head position set in a typical configuration. Test procedures used are according to FCC/OET Bulletin 65, Supp.C [July 2001].
2. All modes of operation were investigated, and worst-case results are reported.
3. Battery is fully charged for all readings. Standard batteries are the only options.
4. Power measured is conducted
5. Tissue parameters and temperatures are listed on the SAR plots.
6. Liquid tissue depth is 15.1 cm. ± 0.1

<b>PCTEST SAR REPORT</b>		<b>SAR SUMMARY REPORT</b>		<b>Reviewed by:</b> Quality Manager
SAR Filename: 0506140433	Test Dates: June 20,2005 – June 22, 2005	EUT Type: Dual-Band GSM Phone	FCC ID: A3LSGHD600	Page 21 of 25



MEASUREMENT RESULTS (GSM850 Left Cheek)										
FREQUENCY		Mode	Power Class		Test Position	Slide Position	Antenna Type	Bluetooth	Battery	SAR (W/kg)
MHz	Ch.		PCL	dBm						
824.20	128	GSM850	5	33.00	Touch	In	Internal	OFF	Standard	0.13
836.60	190	GSM850	5	33.00	Touch	In	Internal	OFF	Standard	0.18
848.80	251	GSM850	5	33.00	Touch	In	Internal	OFF	Standard	0.23
824.20	128	GSM850	5	33.00	Touch	Out	Internal	OFF	Standard	0.03
836.60	190	GSM850	5	33.00	Touch	Out	Internal	OFF	Standard	0.05
848.80	251	GSM850	5	33.00	Touch	Out	Internal	OFF	Standard	0.07
848.80	251	GSM850	5	33.00	Touch	In	Internal	ON	Standard	0.23
MEASUREMENT RESULTS (GSM850 Left Tilt)										
FREQUENCY		Mode	Power Class		Test Position	Slide Position	Antenna Type	Bluetooth	Battery	SAR (W/kg)
MHz	Ch.		PCL	dBm						
824.20	128	GSM850	5	33.00	Tilt	In	Internal	OFF	Standard	0.07
836.60	190	GSM850	5	33.00	Tilt	In	Internal	OFF	Standard	0.10
848.80	251	GSM850	5	33.00	Tilt	In	Internal	OFF	Standard	0.13
824.20	128	GSM850	5	33.00	Tilt	Out	Internal	OFF	Standard	0.01
836.60	190	GSM850	5	33.00	Tilt	Out	Internal	OFF	Standard	0.02
848.80	251	GSM850	5	33.00	Tilt	Out	Internal	OFF	Standard	0.03
ANSI / IEEE C95.1 1992 - SAFETY LIMIT Spatial Peak Uncontrolled Exposure/General Population						Brain 1.6 W/kg (mW/g) averaged over 1 gram				

1. The test data reported are the worst-case SAR value with the antenna-head position set in a typical configuration. Test procedures used are according to FCC/OET Bulletin 65, Supp.C [July 2001].
2. All modes of operation were investigated, and worst-case results are reported.
3. Battery is fully charged for all readings. Standard batteries are the only options.
4. Power measured is conducted
5. Tissue parameters and temperatures are listed on the SAR plots.
6. Liquid tissue depth is 15.1 cm. ± 0.1

PCTEST SAR REPORT		SAR SUMMARY REPORT		Reviewed by: Quality Manager
SAR Filename: 0506140433	Test Dates: June 20,2005 – June 22, 2005	EUT Type: Dual-Band GSM Phone	FCC ID: A3LSGHD600	Page 22 of 25



<b>MEASUREMENT RESULTS (GSM1900 Right Cheek)</b>											
FREQUENCY		Mode	Power Class		Test Position	Slide Position	Antenna Type	Bluetooth	Battery	SAR (W/kg)	
MHz	Ch.		PCL	dBm							
1850.20	512	GSM1900	0	30.00	Touch	In	Internal	OFF	Standard	0.25	
1880.00	661	GSM1900	0	30.00	Touch	In	Internal	OFF	Standard	0.26	
1909.80	810	GSM1900	0	30.00	Touch	In	Internal	OFF	Standard	0.15	
1850.20	512	GSM1900	0	30.00	Touch	Out	Internal	OFF	Standard	0.45	
1880.00	661	GSM1900	0	30.00	Touch	Out	Internal	OFF	Standard	0.32	
1909.80	810	GSM1900	0	30.00	Touch	Out	Internal	OFF	Standard	0.19	
1850.20	512	GSM1900	0	30.00	Touch	Out	Internal	ON	Standard	0.36	
<b>MEASUREMENT RESULTS (GSM1900 Right Tilt)</b>											
FREQUENCY		Mode	Power Class		Test Position	Slide Position	Antenna Type	Bluetooth	Battery	SAR (W/kg)	
MHz	Ch.		PCL	dBm							
1850.20	512	GSM1900	0	30.00	Tilt	In	Internal	OFF	Standard	0.24	
1880.00	661	GSM1900	0	30.00	Tilt	In	Internal	OFF	Standard	0.22	
1909.80	810	GSM1900	0	30.00	Tilt	In	Internal	OFF	Standard	0.12	
1850.20	512	GSM1900	0	30.00	Tilt	Out	Internal	OFF	Standard	0.32	
1880.00	661	GSM1900	0	30.00	Tilt	Out	Internal	OFF	Standard	0.26	
1909.80	810	GSM1900	0	30.00	Tilt	Out	Internal	OFF	Standard	0.14	
<b>ANSI / IEEE C95.1 1992 - SAFETY LIMIT</b>						<b>Brain</b>					
<b>Spatial Peak</b>						<b>1.6 W/kg (mW/g)</b>					
<b>Uncontrolled Exposure/General Population</b>						averaged over 1 gram					

1. The test data reported are the worst-case SAR value with the antenna-head position set in a typical configuration. Test procedures used are according to FCC/OET Bulletin 65, Supp.C [July 2001].
2. All modes of operation were investigated, and worst-case results are reported.
3. Battery is fully charged for all readings. Standard batteries are the only options.
4. Power measured is conducted
5. Tissue parameters and temperatures are listed on the SAR plots.
6. Liquid tissue depth is 15.1 cm. ± 0.1

<b>PCTEST SAR REPORT</b>		<b>SAR SUMMARY REPORT</b>		<b>Reviewed by:</b> Quality Manager
<b>SAR Filename:</b> 0506140433	<b>Test Dates:</b> June 20,2005 – June 22, 2005	<b>EUT Type:</b> Dual-Band GSM Phone	<b>FCC ID:</b> A3LSGHD600	Page 23 of 25

MEASUREMENT RESULTS (GSM1900 Left Cheek)										
FREQUENCY		Mode	Power Class		Test Position	Slide Position	Antenna Type	Bluetooth	Battery	SAR (W/kg)
MHz	Ch.		PCL	dBm						
1850.20	512	GSM1900	0	30.00	Touch	In	Internal	OFF	Standard	0.19
1880.00	661	GSM1900	0	30.00	Touch	In	Internal	OFF	Standard	0.16
1909.80	810	GSM1900	0	30.00	Touch	In	Internal	OFF	Standard	0.08
1850.20	512	GSM1900	0	30.00	Touch	Out	Internal	OFF	Standard	0.31
1880.00	661	GSM1900	0	30.00	Touch	Out	Internal	OFF	Standard	0.26
1909.80	810	GSM1900	0	30.00	Touch	Out	Internal	OFF	Standard	0.14
1909.80	512	GSM1900	0	30.00	Touch	Out	Internal	ON	Standard	0.33
MEASUREMENT RESULTS (GSM1900 Left Tilt)										
FREQUENCY		Mode	Power Class		Test Position	Slide Position	Antenna Type	Bluetooth	Battery	SAR (W/kg)
MHz	Ch.		PCL	dBm						
1850.20	512	GSM1900	0	30.00	Tilt	In	Internal	OFF	Standard	0.14
1880.00	661	GSM1900	0	30.00	Tilt	In	Internal	OFF	Standard	0.14
1909.80	810	GSM1900	0	30.00	Tilt	In	Internal	OFF	Standard	0.08
1850.20	512	GSM1900	0	30.00	Tilt	Out	Internal	OFF	Standard	0.19
1880.00	661	GSM1900	0	30.00	Tilt	Out	Internal	OFF	Standard	0.15
1909.80	810	GSM1900	0	30.00	Tilt	Out	Internal	OFF	Standard	0.05
<b>ANSI / IEEE C95.1 1992 - SAFETY LIMIT</b> Spatial Peak Uncontrolled Exposure/General Population						<b>Brain</b> <b>1.6 W/kg (mW/g)</b> averaged over 1 gram				



1. The test data reported are the worst-case SAR value with the antenna-head position set in a typical configuration. Test procedures used are according to FCC/OET Bulletin 65, Supp.C [July 2001].
2. All modes of operation were investigated, and worst-case results are reported.
3. Battery is fully charged for all readings. Standard batteries are the only options.
4. Power measured is conducted
5. Tissue parameters and temperatures are listed on the SAR plots.
6. Liquid tissue depth is 15.1 cm. ± 0.1

PCTEST SAR REPORT		SAR SUMMARY REPORT		Reviewed by: Quality Manager
SAR Filename: 0506140433	Test Dates: June 20,2005 – June 22, 2005	EUT Type: Dual-Band GSM Phone	FCC ID: A3LSGHD600	Page 24 of 25

<b>MEASUREMENT RESULTS (GPRS850 Body SAR)</b>										
FREQUENCY		Mode	Power Class		Test Position	Separation Distance (cm)	Antenna Type	Bluetooth	Battery	SAR (W/kg)
MHz	Ch.		PCL	dBm						
824.20	128	GPRS	5	33.0	Body	1.5	Internal	OFF	Standard	0.48
836.60	190	GPRS	5	33.0	Body	1.5	Internal	OFF	Standard	0.60
848.80	251	GPRS	5	33.0	Body	1.5	Internal	OFF	Standard	0.73
824.20	128	GPRS	5	33.0	Body	1.5	Internal	OFF	Standard	0.41
836.60	190	GPRS	5	33.0	Body	1.5	Internal	OFF	Standard	0.41
848.80	251	GPRS	5	33.0	Body	1.5	Internal	OFF	Standard	0.80
848.80	251	GPRS	5	33.0	Body	1.5	Internal	ON	Standard	0.68
<b>MEASUREMENT RESULTS (GPRS1900 Body SAR)</b>										
FREQUENCY		Mode	Power Class		Test Position	Separation Distance (cm)	Antenna Type	Bluetooth	Battery	SAR (W/kg)
MHz	Ch.		PCL	dBm						
1850.20	512	GPRS	0	30.00	Body	1.5	Internal	OFF	Standard	1.34
1880.00	661	GPRS	0	30.00	Body	1.5	Internal	OFF	Standard	1.11
1909.80	810	GPRS	0	30.00	Body	1.5	Internal	OFF	Standard	0.76
1850.20	512	GPRS	0	30.00	Body	1.5	Internal	OFF	Standard	1.17
1880.00	661	GPRS	0	30.00	Body	1.5	Internal	OFF	Standard	1.01
1909.80	810	GPRS	0	30.00	Body	1.5	Internal	OFF	Standard	0.68
1850.20	512	GPRS	0	30.00	Body	1.5	Internal	ON	Standard	1.40
<b>ANSI / IEEE C95.1 1992 - SAFETY LIMIT</b>						<b>Body</b>				
<b>Spatial Peak</b>						<b>1.6 W/kg (mW/g)</b>				
<b>Uncontrolled Exposure/General Population</b>						averaged over 1 gram				

1. The test data reported are the worst-case SAR value with the antenna-head position set in a typical configuration. Test procedures used are according to FCC/OET Bulletin 65, Supp.C [July 2001].
2. All modes of operation were investigated, and worst-case results are reported.
3. Battery is fully charged for all readings. Standard batteries are the only options.
4. Power measured is conducted
5. Tissue parameters and temperatures are listed on the SAR plots.
6. Liquid tissue depth is 15.1 cm. ± 0.1

  
 Alfred Cirwithian  
 Vice President Engineering

PCTEST SAR REPORT		SAR SUMMARY REPORT		Reviewed by: Quality Manager
SAR Filename: 0506140433	Test Dates: June 20,2005 – June 22, 2005	EUT Type: Dual-Band GSM Phone	FCC ID: A3LSGHD600	Page 25 of 25

## **APPENDIX A: SAR TEST DATA**

SAR Data Report 05062115

Start : 21-Jun-05 12:29:55 pm  
End : 21-Jun-05 12:35:07 pm  
Code Version : 4.08  
Robot Version: 4.08

Product Data:

Type : Samsung Dual-Band GSM Phone  
Model Number : SGH-D600  
Serial Number : FC-081-B  
Frequency : 848.8 MHz  
Transmit Pwr : 2 W  
Antenna Type : Helical  
Antenna Posn. : Internal

Measurement Data:

Phantom Name : SAM-RIGHT  
Phantom Type : Right Ear  
Tissue Type : Brain  
Tissue Dielectric : 42.880  
Tissue Conductivity : 0.900  
Tissue Density : 1.000  
Robot Name : CRS

Probe Data:

Probe Name : PCT005  
Probe Type : E Fld Triangle  
Frequency : 835 MHz  
Tissue Type : Brain  
Calibrated Dielectric : 40.810  
Calibrated Conductivity : 0.870  
Calibrated Density : 1.000  
Probe Offset : 1.600 mm  
Conversion Factor : 5.500  
Probe Sensitivity : 3.807 3.736 3.821 mV/(mW/cm^2)  
Amplifier Gains : 20.00 20.00 20.00

Sample:

Rate: 6000 Samples/Sec  
Count: 1000 Samples  
NIDAQ Gain: 5

Comments:

GSM Mode Ch. 251  
Right Cheek (Slide In)  
CF=8; Amb. Temp= 22.5 'C; Liq. Temp=21.3 'C

Power Drop Test:

Reading @ start = 0.024  
Reading @ End = 0.025  
Power at End = 104.2%

Area Scan - Max Peak SAR Value at x=40.0 y=1.0 = 0.27 W/kg

Zoom Scan - Max Peak SAR Value at x=37.0 y=1.0 z=0.0 = 0.36 W/kg

Max 1g SAR at x=42.0 y=3.0 z=0.0 = 0.25 W/kg

Max 10g SAR at x=43.0 y=4.0 z=0.0 = 0.17 W/kg

SAR - Z Axis  
at Hotspot x:37.0 y:1.0

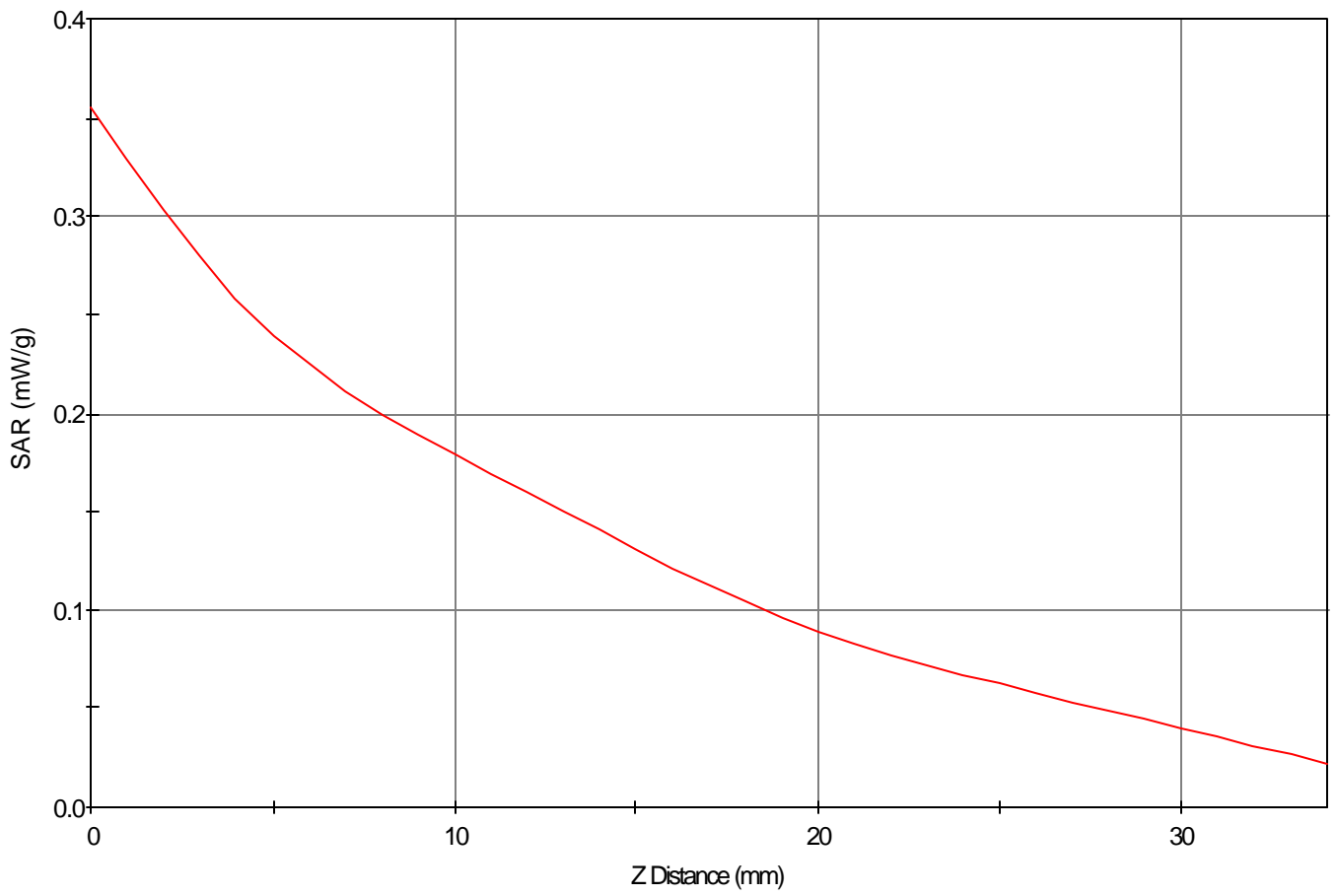

### 1g SAR Values

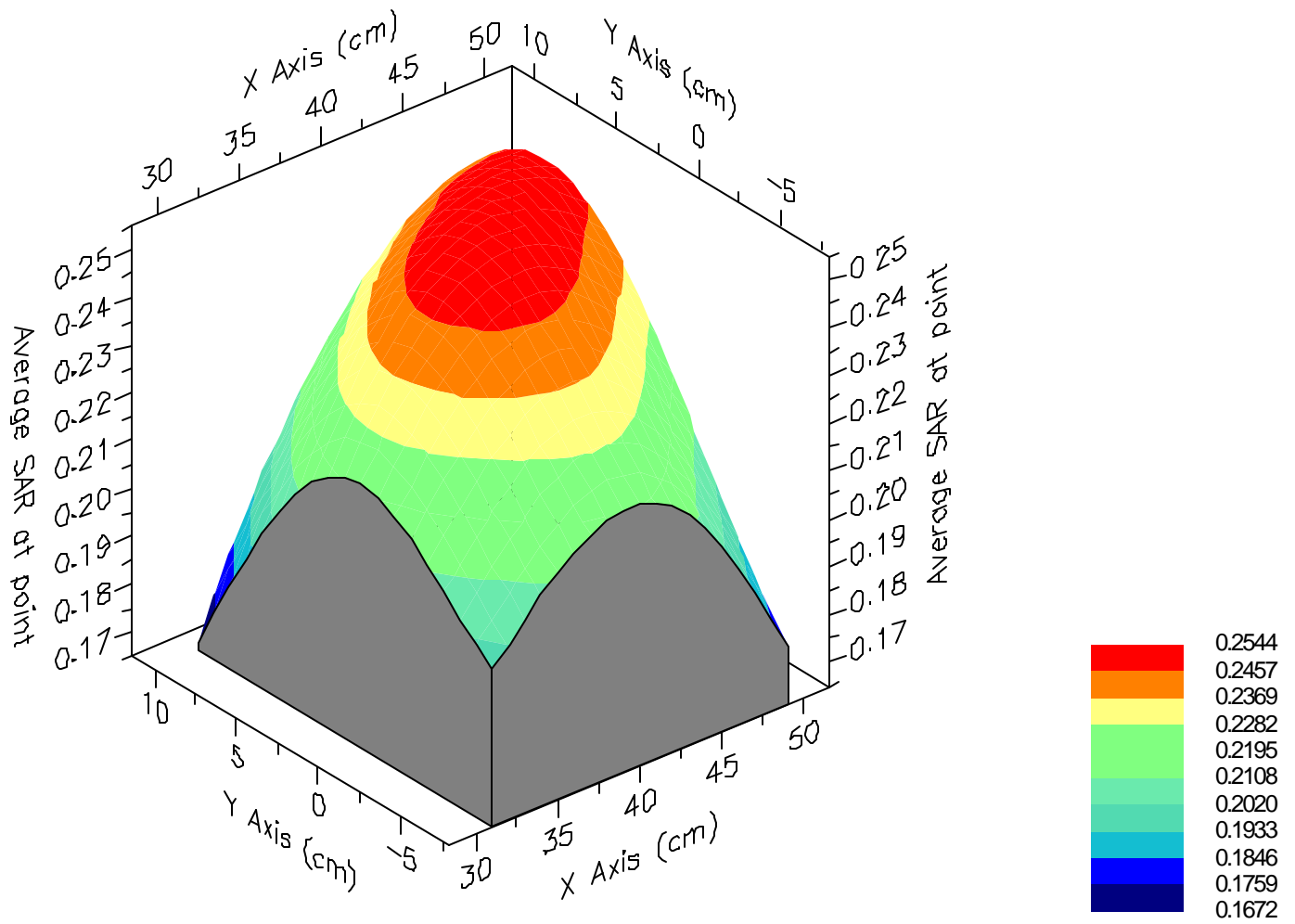



SAR Data Report 05062124

Start : 21-Jun-05 01:30:31 pm  
End : 21-Jun-05 01:35:38 pm  
Code Version : 4.08  
Robot Version: 4.08

Product Data:

Type : Samsung Dual-Band GSM Phone  
Model Number : SGH-D600  
Serial Number : FC-081-B  
Frequency : 848.8 MHz  
Transmit Pwr : 2 W  
Antenna Type : Helical  
Antenna Posn. : Internal

Measurement Data:

Phantom Name : SAM-RIGHT  
Phantom Type : Right Ear  
Tissue Type : Brain  
Tissue Dielectric : 42.880  
Tissue Conductivity : 0.900  
Tissue Density : 1.000  
Robot Name : CRS

Probe Data:

Probe Name : PCT005  
Probe Type : E Fld Triangle  
Frequency : 835 MHz  
Tissue Type : Brain  
Calibrated Dielectric : 40.810  
Calibrated Conductivity : 0.870  
Calibrated Density : 1.000  
Probe Offset : 1.600 mm  
Conversion Factor : 5.500  
Probe Sensitivity : 3.807 3.736 3.821 mV/(mW/cm^2)  
Amplifier Gains : 20.00 20.00 20.00

Sample:

Rate: 6000 Samples/Sec  
Count: 1000 Samples  
NIDAQ Gain: 5

Comments:

GSM Mode Ch. 251  
Right Cheek (Slide Out)  
CF=8; Amb. Temp= 22.5 'C; Liq. Temp=21.3 'C

Power Drop Test:

Reading @ start = 0.000  
Reading @ End = 0.000

Area Scan - Max Peak SAR Value at x=60.0 y=10.0 = 0.10 W/kg

Zoom Scan - Max Peak SAR Value at x=61.0 y=11.0 z=0.0 = 0.14 W/kg

Max 1g SAR at x=61.0 y=10.0 z=0.0 = 0.09 W/kg

Max 10g SAR at x=63.0 y=8.0 z=0.0 = 0.05 W/kg

SAR - Z Axis  
at Hotspot x:61.0 y:11.0

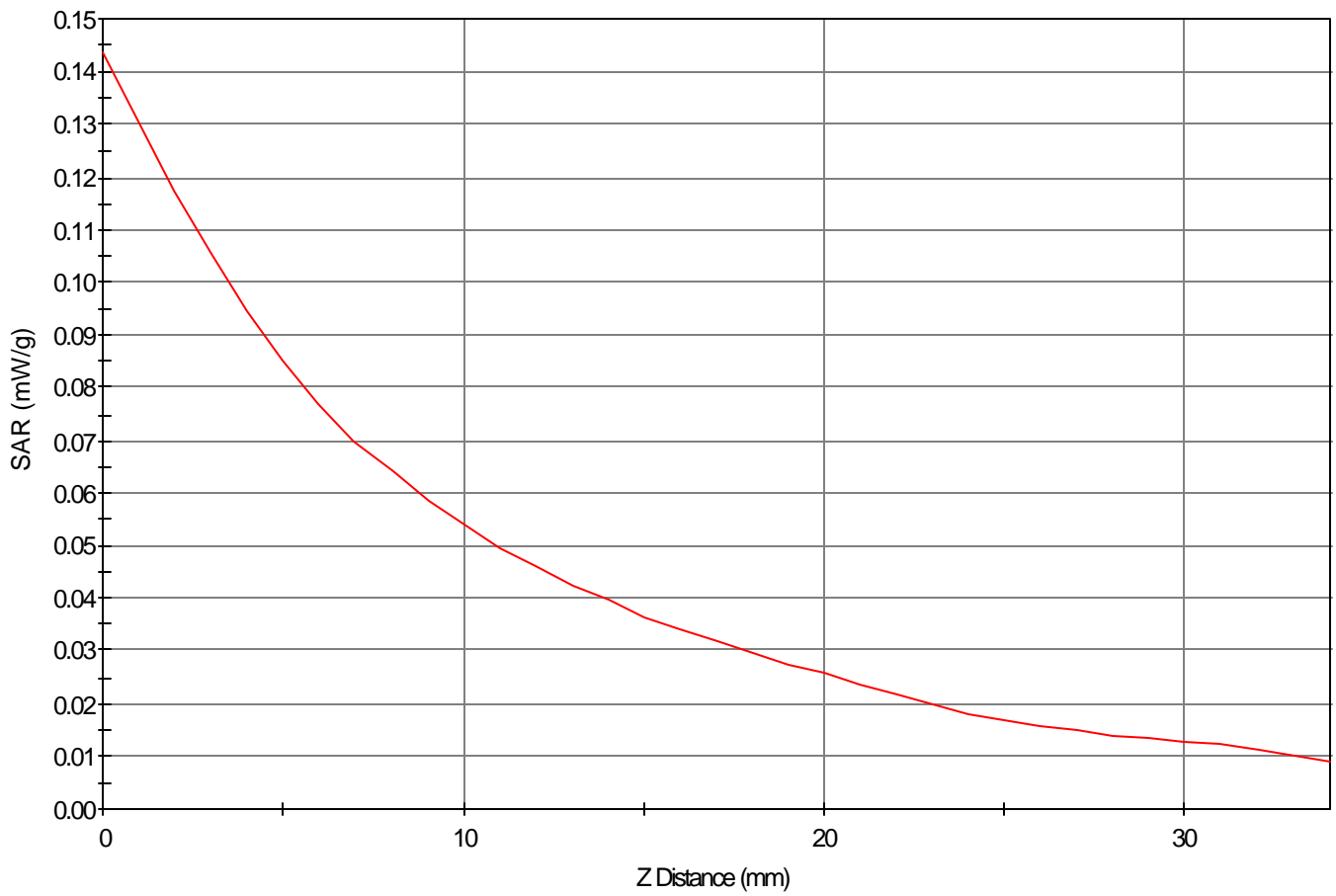

### 1g SAR Values

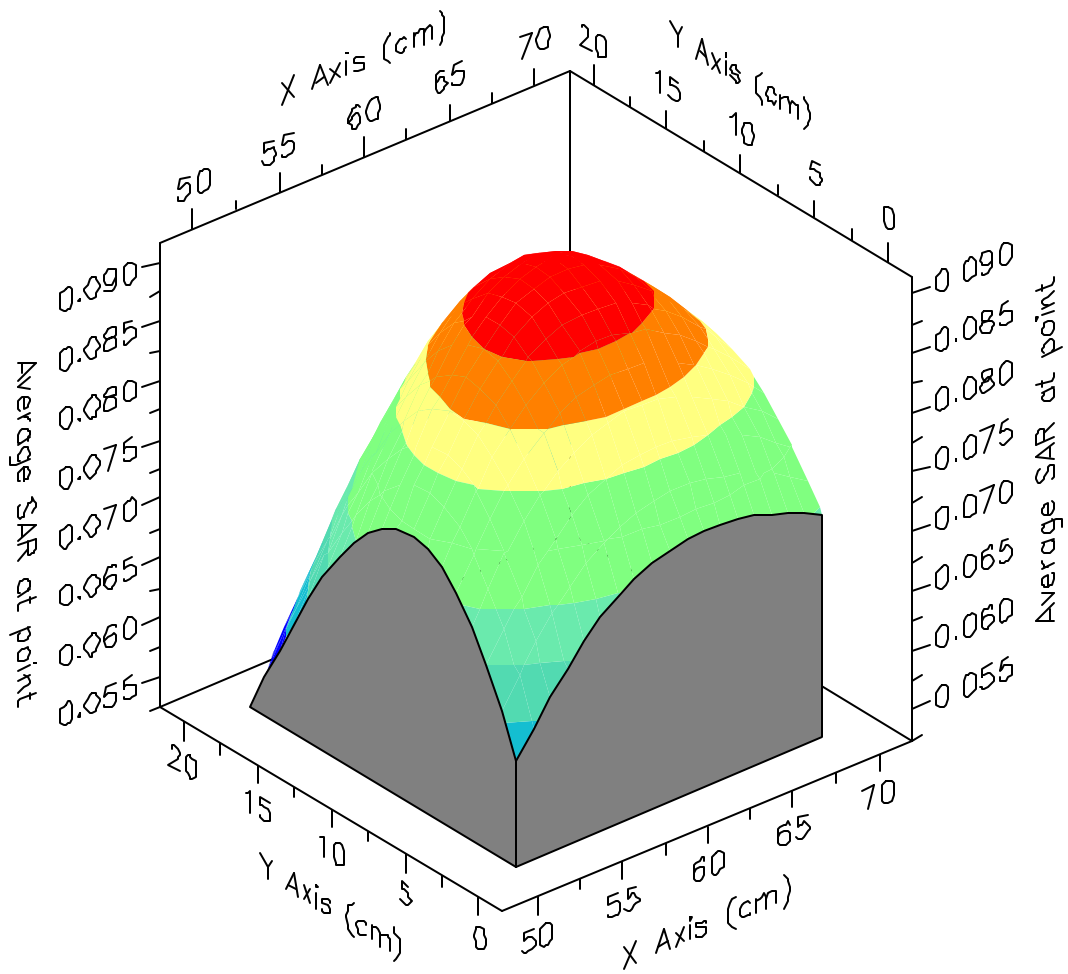

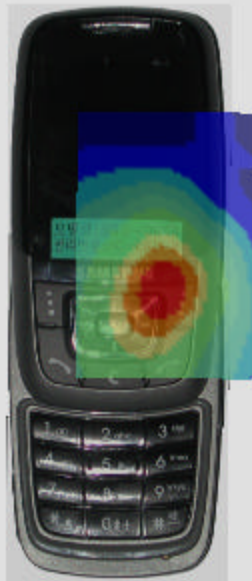

SAR Data Report 05062128

Start : 21-Jun-05 01:51:02 pm  
End : 21-Jun-05 01:55:50 pm  
Code Version : 4.08  
Robot Version: 4.08

Product Data:

Type : Samsung Dual-Band GSM Phone  
Model Number : SGH-D600  
Serial Number : FC-081-B  
Frequency : 848.8 MHz  
Transmit Pwr : 2 W  
Antenna Type : Helical  
Antenna Posn. : Internal

Measurement Data:

Phantom Name : SAM-RIGHT  
Phantom Type : Right Ear  
Tissue Type : Brain  
Tissue Dielectric : 42.880  
Tissue Conductivity : 0.900  
Tissue Density : 1.000  
Robot Name : CRS

Probe Data:

Probe Name : PCT005  
Probe Type : E Fld Triangle  
Frequency : 835 MHz  
Tissue Type : Brain  
Calibrated Dielectric : 40.810  
Calibrated Conductivity : 0.870  
Calibrated Density : 1.000  
Probe Offset : 1.600 mm  
Conversion Factor : 5.500  
Probe Sensitivity : 3.807 3.736 3.821 mV/(mW/cm^2)  
Amplifier Gains : 20.00 20.00 20.00

Sample:

Rate: 6000 Samples/Sec  
Count: 1000 Samples  
NIDAQ Gain: 5

Comments:

GSM Mode Ch. 251  
Right Cheek (Slide In w/ BlueTooth On)  
CF=8; Amb. Temp= 22.5 'C; Liq. Temp=21.3 'C

Power Drop Test:

Reading @ start = 0.033  
Reading @ End = 0.034  
Power at End = 102.9%

Area Scan - Max Peak SAR Value at x=44.0 y=3.0 = 0.26 W/kg

Zoom Scan - Max Peak SAR Value at x=37.0 y=-4.0 z=0.0 = 0.37 W/kg

Max 1g SAR at x=46.0 y=4.0 z=0.0 = 0.25 W/kg

Max 10g SAR at x=44.0 y=4.0 z=0.0 = 0.16 W/kg

SAR - Z Axis  
at Hotspot x:37.0 y:-4.0

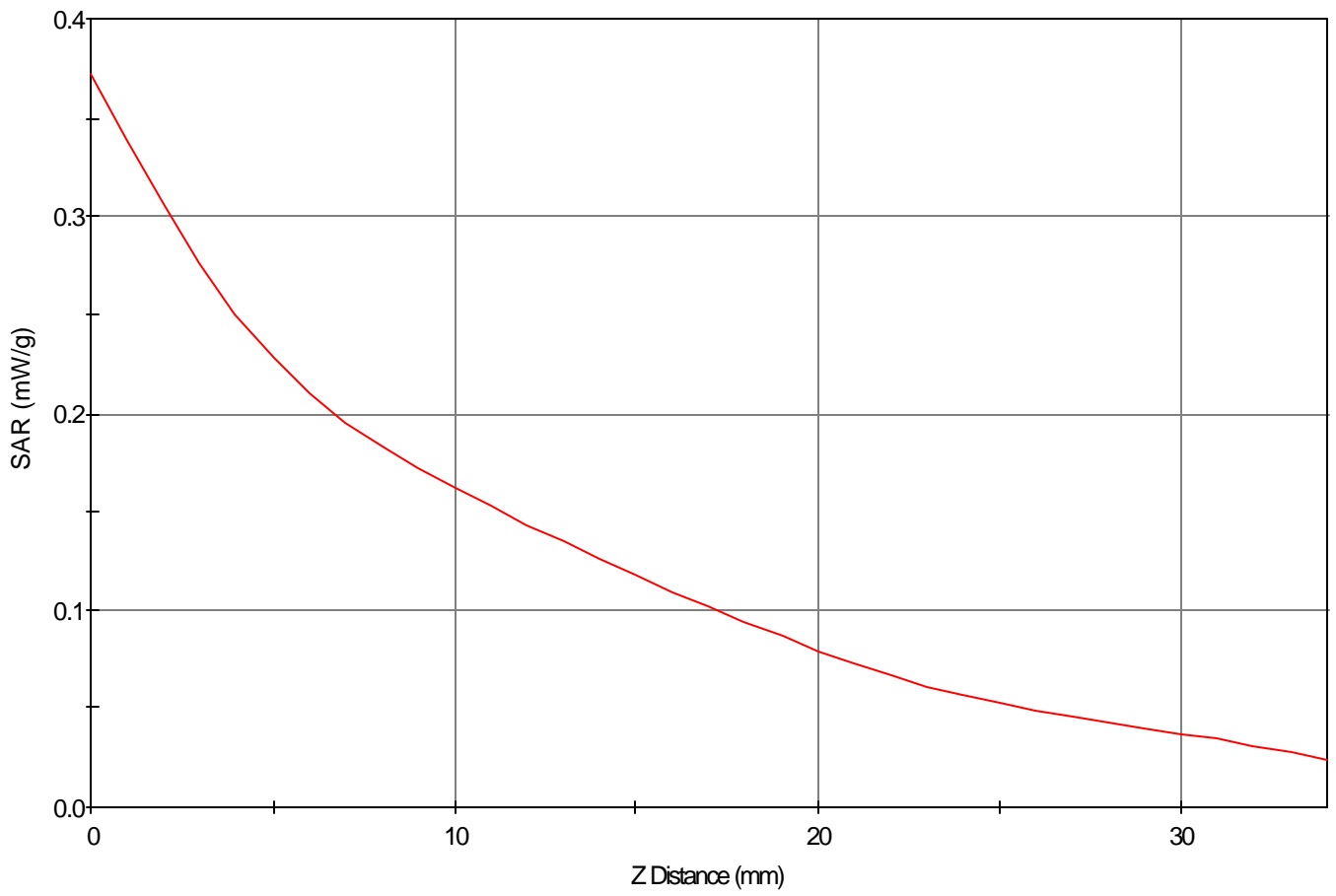

### 1g SAR Values

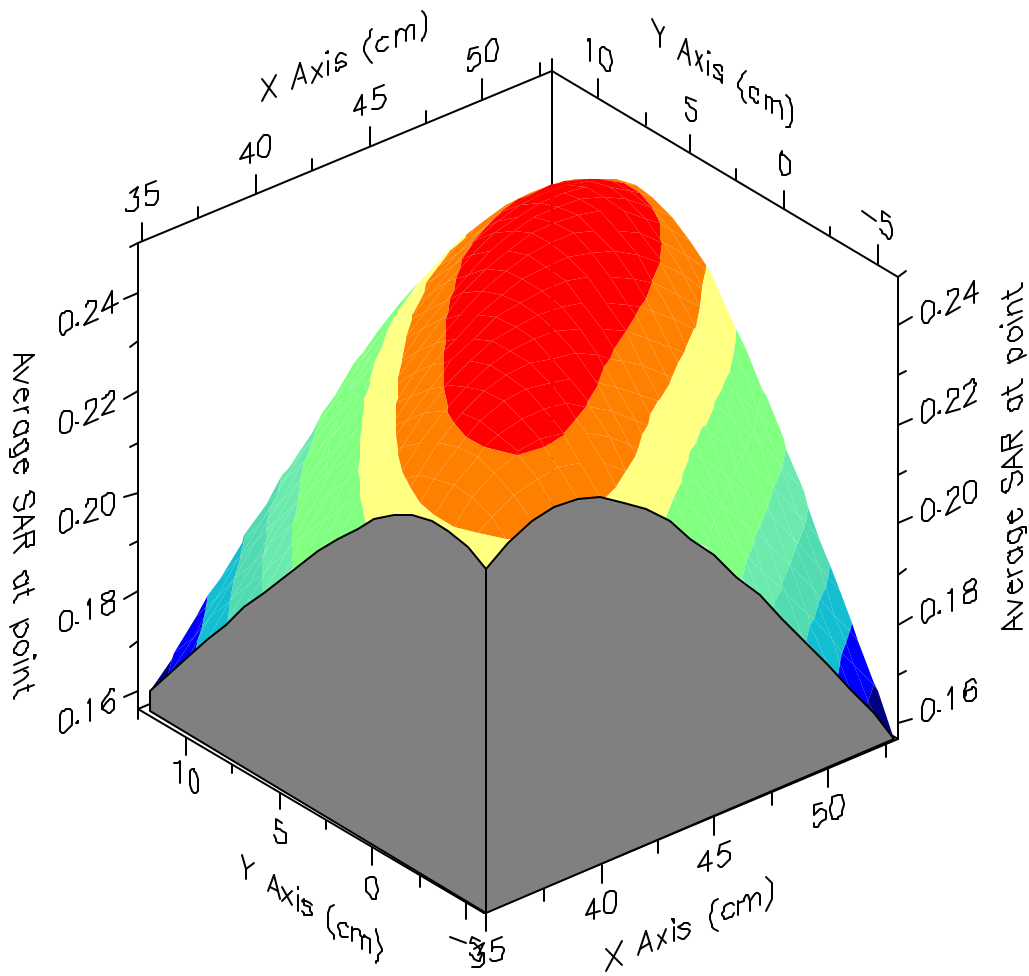

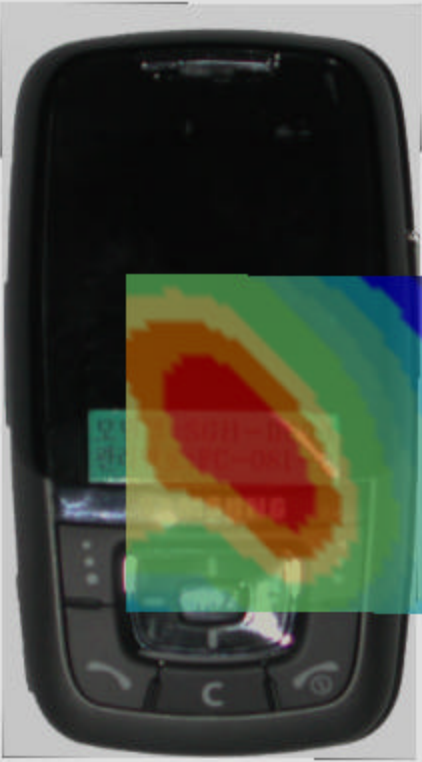

SAR Data Report 05062133

Start : 21-Jun-05 03:58:24 pm  
End : 21-Jun-05 04:03:10 pm  
Code Version : 4.08  
Robot Version: 4.08

Product Data:

Type : Samsung Dual-Band GSM Phone  
Model Number : SGH-D600  
Serial Number : FC-081-B  
Frequency : 848.8 MHz  
Transmit Pwr : 2 W  
Antenna Type : Helical  
Antenna Posn. : Internal

Measurement Data:

Phantom Name : SAM-RIGHT  
Phantom Type : Right Ear  
Tissue Type : Brain  
Tissue Dielectric : 42.880  
Tissue Conductivity : 0.900  
Tissue Density : 1.000  
Robot Name : CRS

Probe Data:

Probe Name : PCT005  
Probe Type : E Fld Triangle  
Frequency : 835 MHz  
Tissue Type : Brain  
Calibrated Dielectric : 40.810  
Calibrated Conductivity : 0.870  
Calibrated Density : 1.000  
Probe Offset : 1.600 mm  
Conversion Factor : 5.500  
Probe Sensitivity : 3.807 3.736 3.821 mV/(mW/cm^2)  
Amplifier Gains : 20.00 20.00 20.00

Sample:

Rate: 6000 Samples/Sec  
Count: 1000 Samples  
NIDAQ Gain: 5

Comments:

GSM Mode Ch. 251  
Right Tilt (Slide In)  
CF=8; Amb. Temp= 22.5 'C; Liq. Temp=21.3 'C

Power Drop Test:

Reading @ start = 0.058  
Reading @ End = 0.055  
Power at End = 95.2%

Area Scan - Max Peak SAR Value at x=38.0 y=-1.0 = 0.22 W/kg

Zoom Scan - Max Peak SAR Value at x=44.0 y=-2.0 z=0.0 = 0.29 W/kg

Max 1g SAR at x=38.0 y=-1.0 z=0.0 = 0.21 W/kg

Max 10g SAR at x=37.0 y=-1.0 z=0.0 = 0.14 W/kg

SAR - Z Axis  
at Hotspot x:44.0 y:-2.0

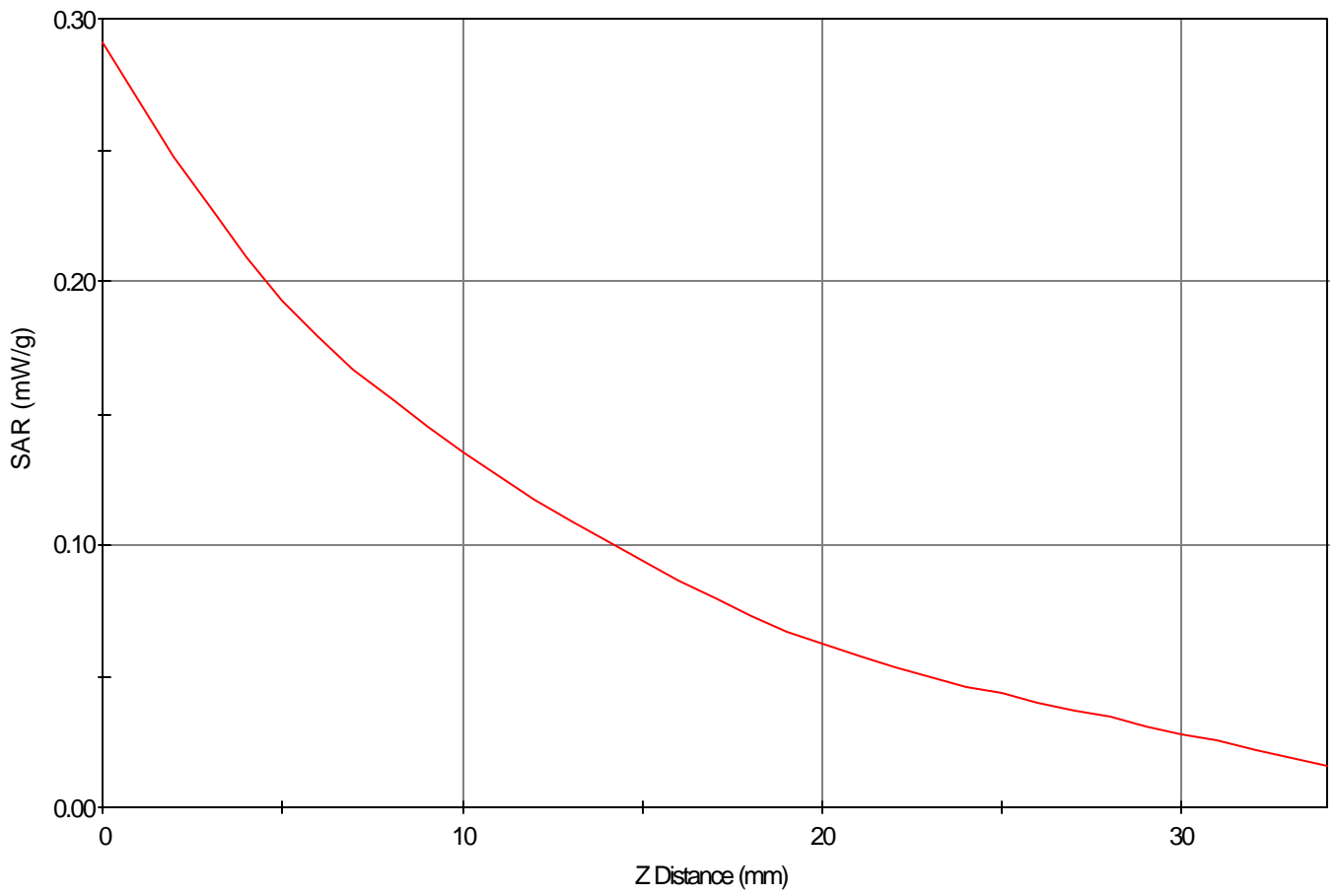

### 1g SAR Values

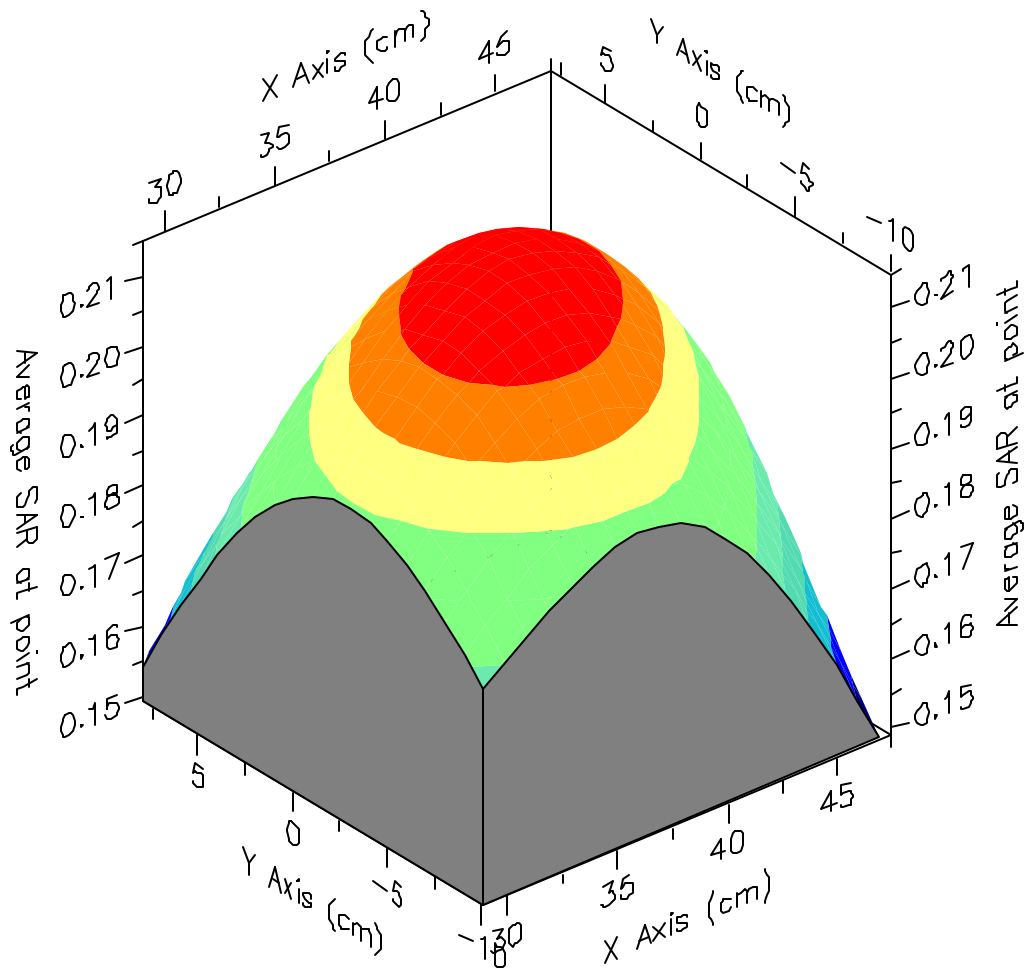

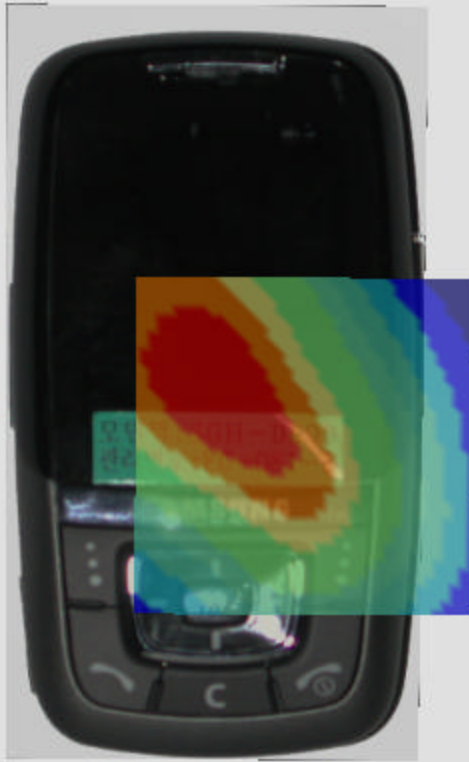

SAR Data Report 05062136

Start : 21-Jun-05 04:24:57 pm  
End : 21-Jun-05 04:29:43 pm  
Code Version : 4.08  
Robot Version: 4.08

Product Data:

Type : Samsung Dual-Band GSM Phone  
Model Number : SGH-D600  
Serial Number : FC-081-B  
Frequency : 848.8 MHz  
Transmit Pwr : 2 W  
Antenna Type : Helical  
Antenna Posn. : Internal

Measurement Data:

Phantom Name : SAM-RIGHT  
Phantom Type : Right Ear  
Tissue Type : Brain  
Tissue Dielectric : 42.880  
Tissue Conductivity : 0.900  
Tissue Density : 1.000  
Robot Name : CRS

Probe Data:

Probe Name : PCT005  
Probe Type : E Fld Triangle  
Frequency : 835 MHz  
Tissue Type : Brain  
Calibrated Dielectric : 40.810  
Calibrated Conductivity : 0.870  
Calibrated Density : 1.000  
Probe Offset : 1.600 mm  
Conversion Factor : 5.500  
Probe Sensitivity : 3.807 3.736 3.821 mV/(mW/cm^2)  
Amplifier Gains : 20.00 20.00 20.00

Sample:

Rate: 6000 Samples/Sec  
Count: 1000 Samples  
NIDAQ Gain: 5

Comments:

GSM Mode Ch. 251  
Right Tilt (Slide Out)  
CF=8; Amb. Temp= 22.5 'C; Liq. Temp=21.3 'C

Power Drop Test:

Reading @ start = 0.000  
Reading @ End = 0.000

Area Scan - Max Peak SAR Value at x=58.0 y=9.0 = 0.09 W/kg

Zoom Scan - Max Peak SAR Value at x=58.0 y=10.0 z=0.0 = 0.16 W/kg

Max 1g SAR at x=58.0 y=10.0 z=0.0 = 0.09 W/kg

Max 10g SAR at x=61.0 y=8.0 z=0.0 = 0.05 W/kg

SAR - Z Axis  
at Hotspot x:58.0 y:10.0

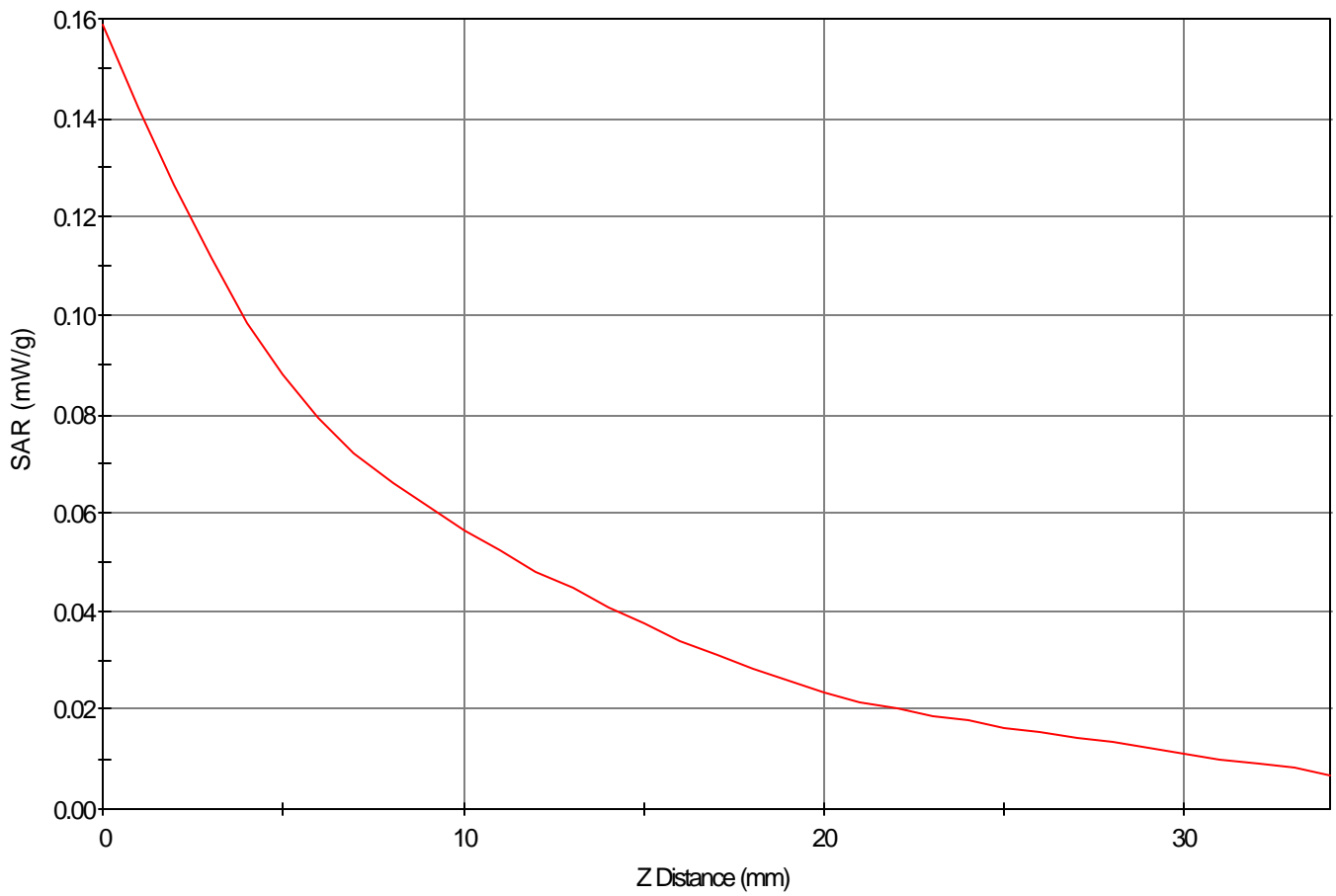

### 1g SAR Values

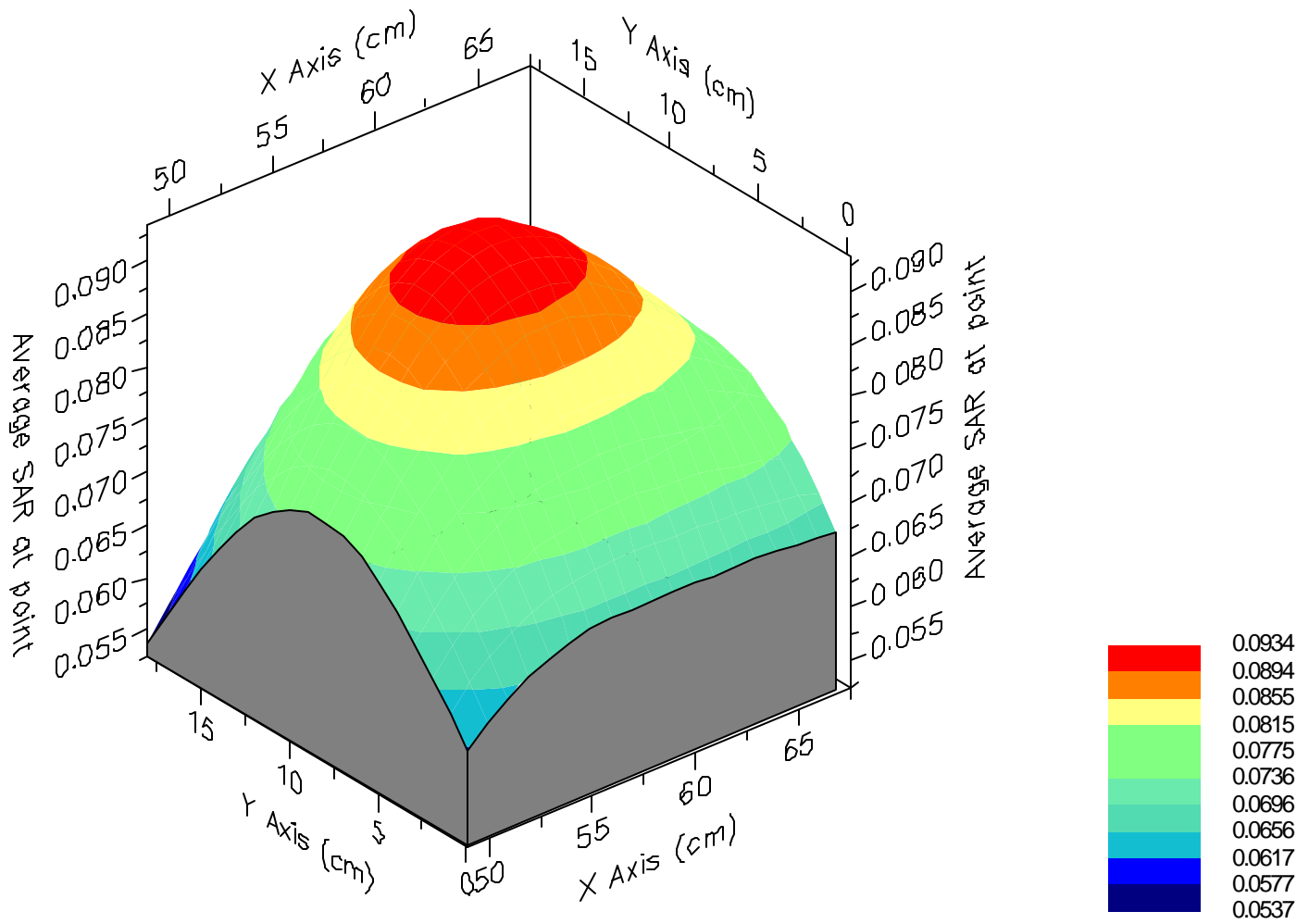



SAR Data Report 05062140

Start : 21-Jun-05 05:05:53 pm  
End : 21-Jun-05 05:10:23 pm  
Code Version : 4.08  
Robot Version: 4.08

Product Data:

Type : Samsung Dual-Band GSM Phone  
Model Number : SGH-D600  
Serial Number : FC-081-B  
Frequency : 848.8 MHz  
Transmit Pwr : 2 W  
Antenna Type : Helical  
Antenna Posn. : Internal

Measurement Data:

Phantom Name : SAM-LEFT  
Phantom Type : Left Ear  
Tissue Type : Brain  
Tissue Dielectric : 42.880  
Tissue Conductivity : 0.900  
Tissue Density : 1.000  
Robot Name : CRS

Probe Data:

Probe Name : PCT005  
Probe Type : E Fld Triangle  
Frequency : 835 MHz  
Tissue Type : Brain  
Calibrated Dielectric : 40.810  
Calibrated Conductivity : 0.870  
Calibrated Density : 1.000  
Probe Offset : 1.600 mm  
Conversion Factor : 5.500  
Probe Sensitivity : 3.807 3.736 3.821 mV/(mW/cm^2)  
Amplifier Gains : 20.00 20.00 20.00

Sample:

Rate: 6000 Samples/Sec  
Count: 1000 Samples  
NIDAQ Gain: 5

Comments:

GSM Mode Ch. 251  
Left Cheek (Slide In)  
CF=8; Amb. Temp= 22.5 'C; Liq. Temp=21.3 'C

Power Drop Test:

Reading @ start = 0.133  
Reading @ End = 0.127  
Power at End = 95.9%

Area Scan - Max Peak SAR Value at x=36.0 y=2.0 = 0.24 W/kg

Zoom Scan - Max Peak SAR Value at x=36.0 y=7.0 z=0.0 = 0.33 W/kg

Max 1g SAR at x=38.0 y=5.0 z=0.0 = 0.23 W/kg

Max 10g SAR at x=39.0 y=4.0 z=0.0 = 0.15 W/kg

SAR - Z Axis  
at Hotspot x:36.0 y:7.0

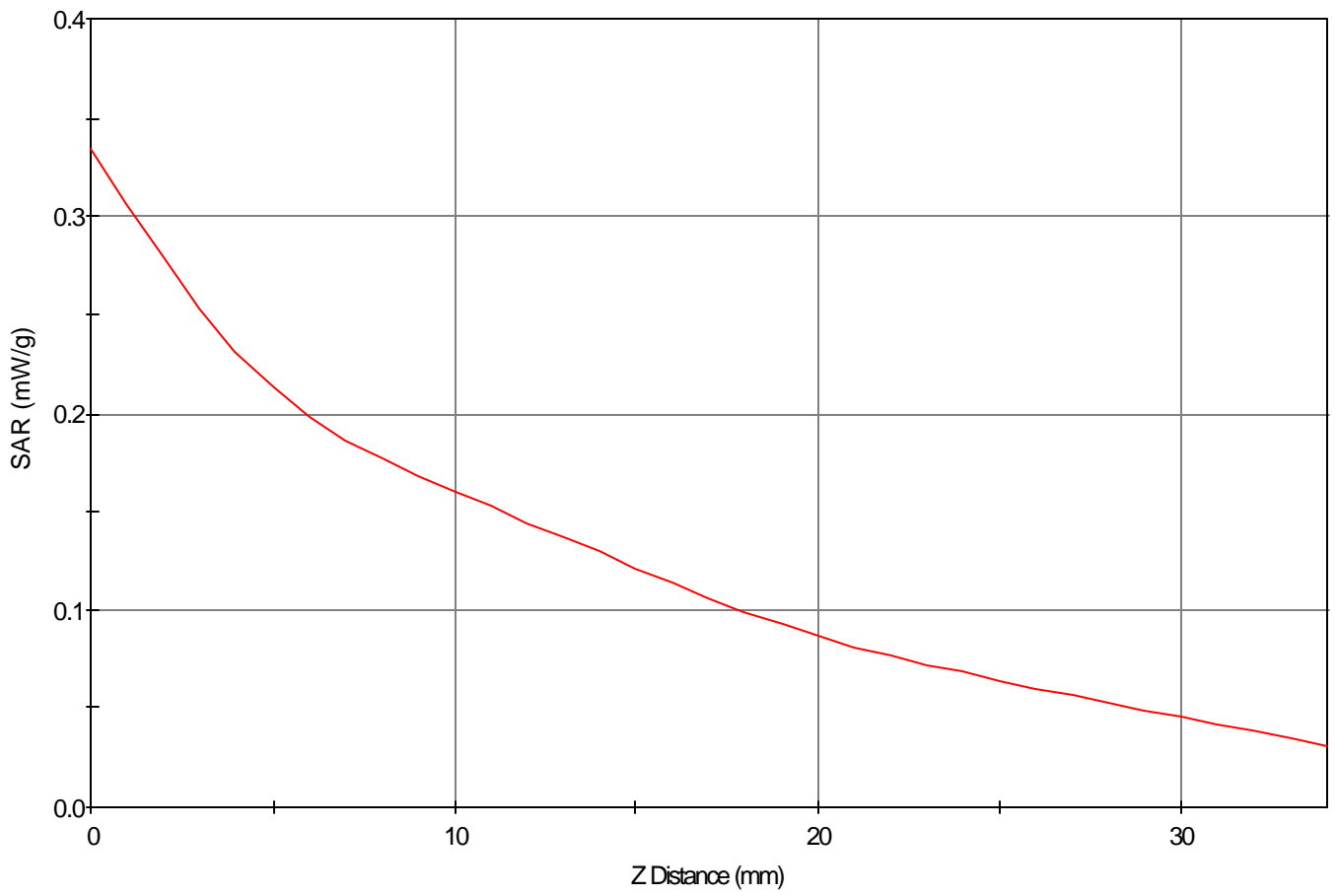

### 1g SAR Values

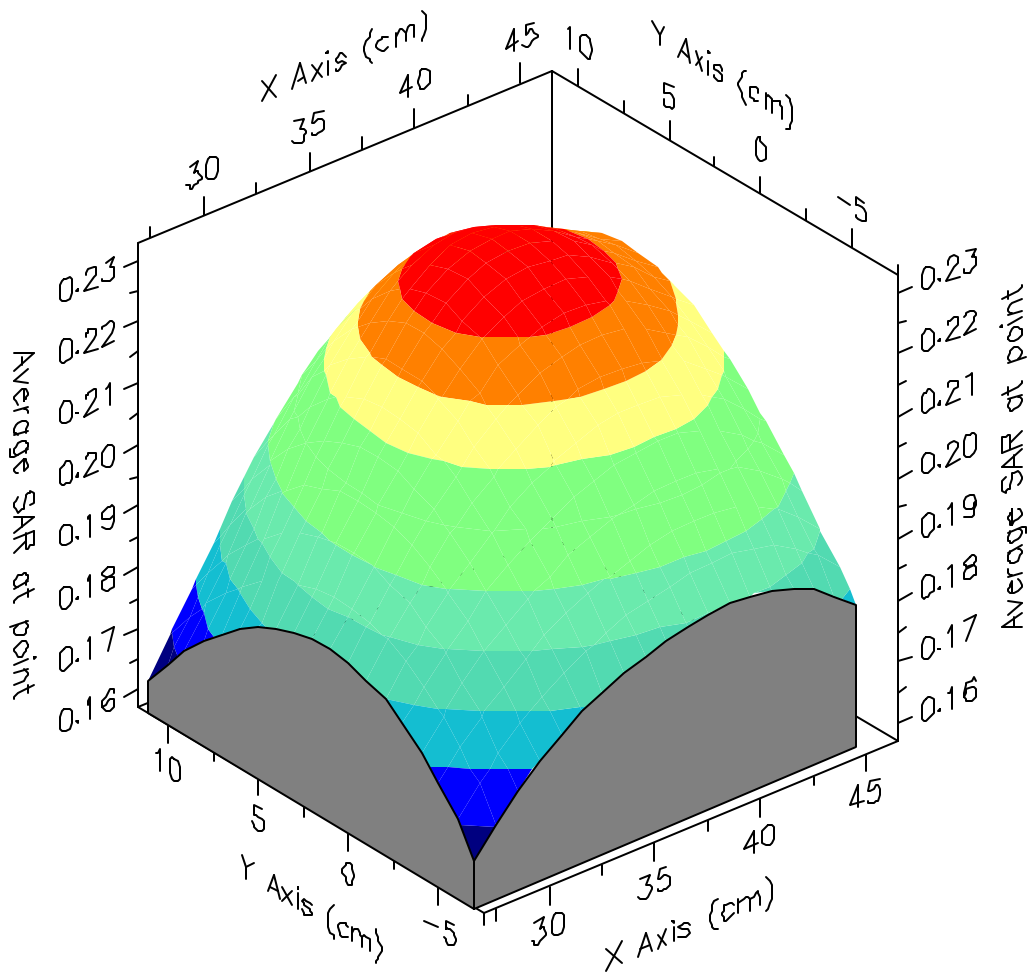



SAR Data Report 05062144

Start : 21-Jun-05 05:39:54 pm  
End : 21-Jun-05 05:44:25 pm  
Code Version : 4.08  
Robot Version: 4.08

Product Data:

Type : Samsung Dual-Band GSM Phone  
Model Number : SGH-D600  
Serial Number : FC-081-B  
Frequency : 848.8 MHz  
Transmit Pwr : 2 W  
Antenna Type : Helical  
Antenna Posn. : Internal

Measurement Data:

Phantom Name : SAM-LEFT  
Phantom Type : Left Ear  
Tissue Type : Brain  
Tissue Dielectric : 42.880  
Tissue Conductivity : 0.900  
Tissue Density : 1.000  
Robot Name : CRS

Probe Data:

Probe Name : PCT005  
Probe Type : E Fld Triangle  
Frequency : 835 MHz  
Tissue Type : Brain  
Calibrated Dielectric : 40.810  
Calibrated Conductivity : 0.870  
Calibrated Density : 1.000  
Probe Offset : 1.600 mm  
Conversion Factor : 5.500  
Probe Sensitivity : 3.807 3.736 3.821 mV/(mW/cm^2)  
Amplifier Gains : 20.00 20.00 20.00

Sample:

Rate: 6000 Samples/Sec  
Count: 1000 Samples  
NIDAQ Gain: 5

Comments:

GSM Mode Ch. 251  
Left Cheek (Slide Out)  
CF=8; Amb. Temp= 22.5 'C; Liq. Temp=21.3 'C

Power Drop Test:

Reading @ start = 0.009  
Reading @ End = 0.009  
Power at End = 100.0%

Area Scan - Max Peak SAR Value at x=56.0 y=11.0 = 0.07 W/kg

Zoom Scan - Max Peak SAR Value at x=55.0 y=10.0 z=0.0 = 0.12 W/kg

Max 1g SAR at x=55.0 y=11.0 z=0.0 = 0.07 W/kg

Max 10g SAR at x=59.0 y=9.0 z=0.0 = 0.04 W/kg

SAR - Z Axis  
at Hotspot x:55.0 y:10.0

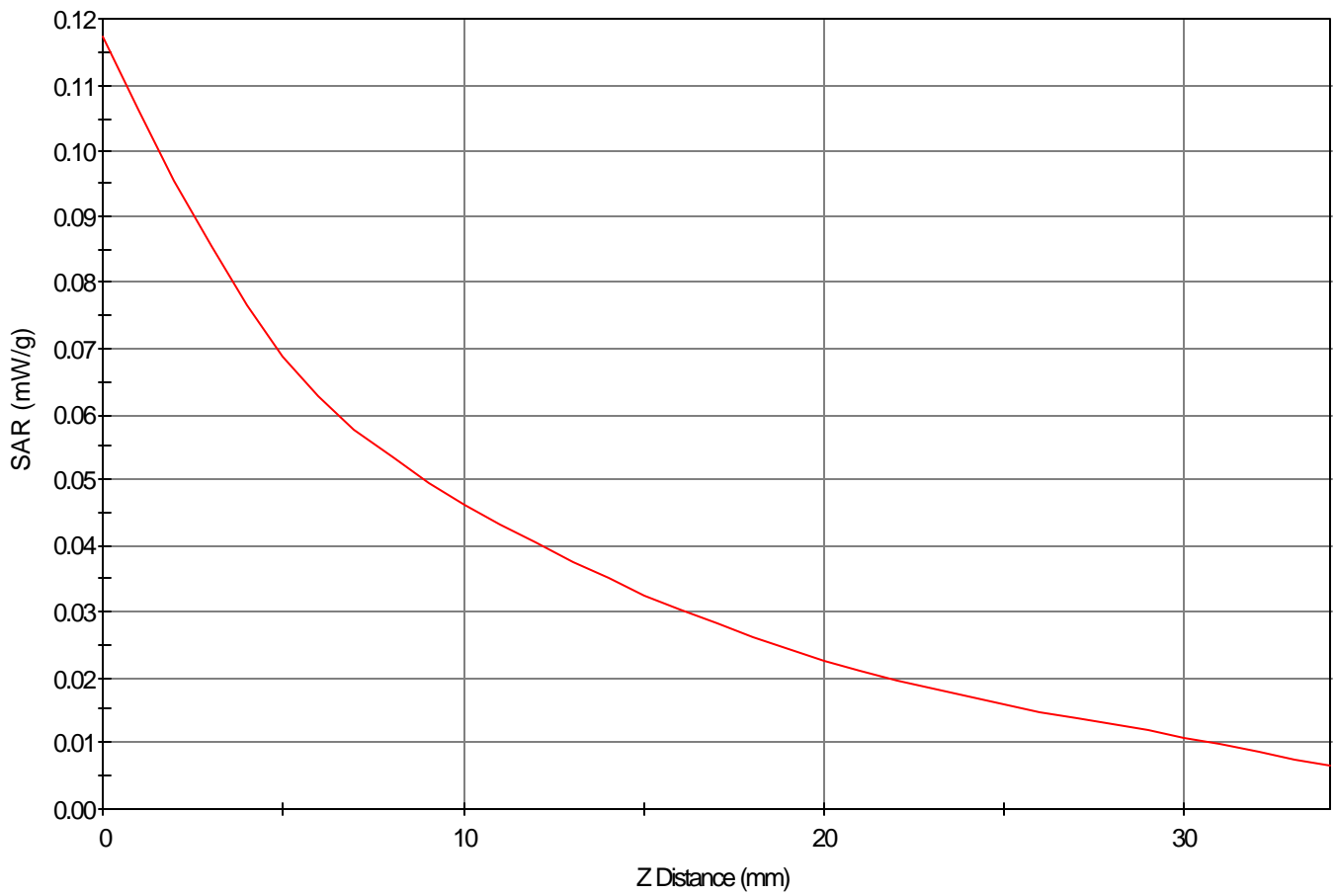

1g SAR Values

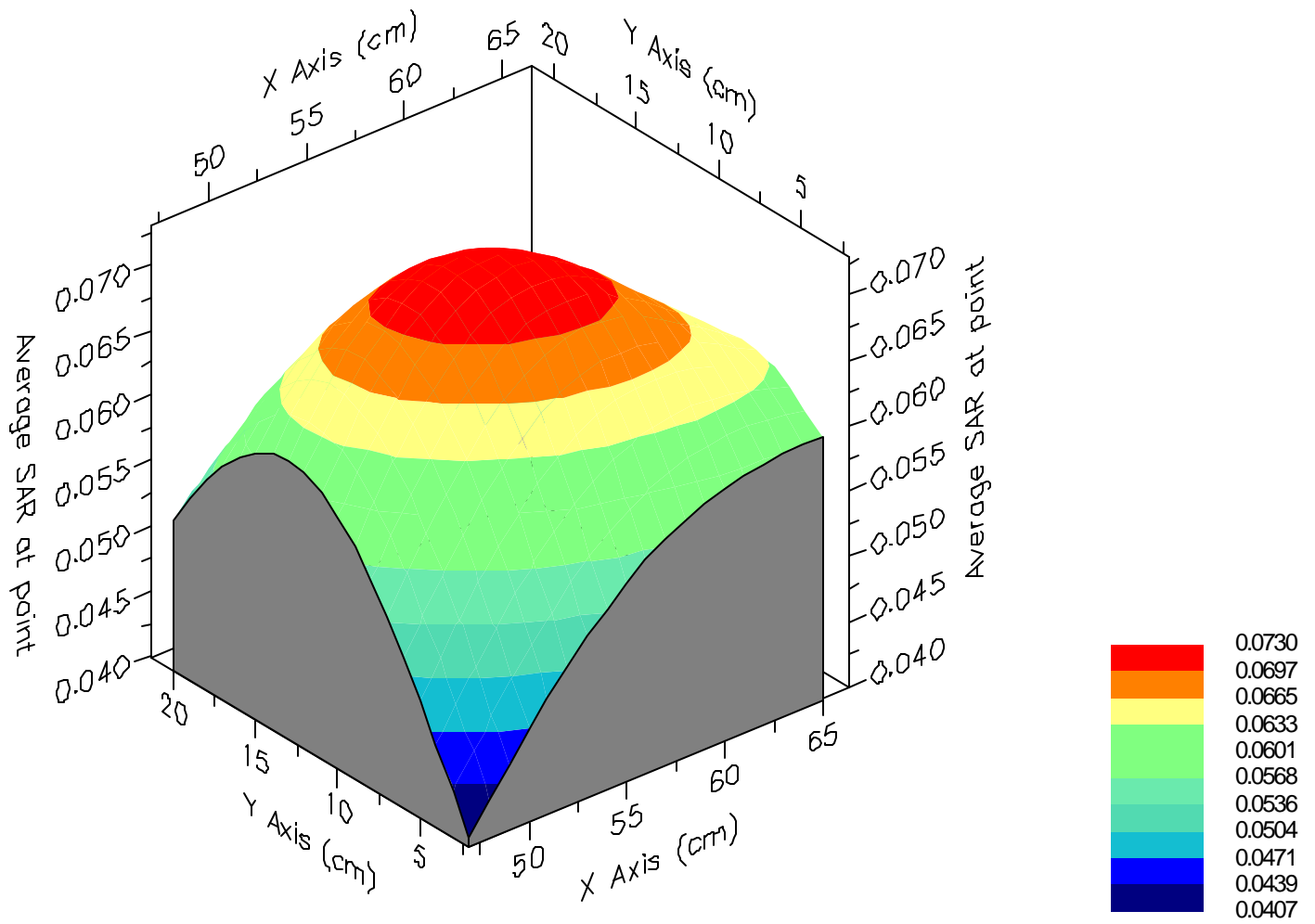



SAR Data Report 05062146

Start : 21-Jun-05 05:55:03 pm  
End : 21-Jun-05 05:59:33 pm  
Code Version : 4.08  
Robot Version: 4.08

Product Data:

Type : Samsung Dual-Band GSM Phone  
Model Number : SGH-D600  
Serial Number : FC-081-B  
Frequency : 848.8 MHz  
Transmit Pwr : 2 W  
Antenna Type : Helical  
Antenna Posn. : Internal

Measurement Data:

Phantom Name : SAM-LEFT  
Phantom Type : Left Ear  
Tissue Type : Brain  
Tissue Dielectric : 42.880  
Tissue Conductivity : 0.900  
Tissue Density : 1.000  
Robot Name : CRS

Probe Data:

Probe Name : PCT005  
Probe Type : E Fld Triangle  
Frequency : 835 MHz  
Tissue Type : Brain  
Calibrated Dielectric : 40.810  
Calibrated Conductivity : 0.870  
Calibrated Density : 1.000  
Probe Offset : 1.600 mm  
Conversion Factor : 5.500  
Probe Sensitivity : 3.807 3.736 3.821 mV/(mW/cm^2)  
Amplifier Gains : 20.00 20.00 20.00

Sample:

Rate: 6000 Samples/Sec  
Count: 1000 Samples  
NIDAQ Gain: 5

Comments:

GSM Mode Ch. 251  
Left Cheek (Slide In w/ BlueTooth On)  
CF=8; Amb. Temp= 22.5 'C; Liq. Temp=21.3 'C

Power Drop Test:

Reading @ start = 0.108  
Reading @ End = 0.111  
Power at End = 102.4%

Area Scan - Max Peak SAR Value at x=47.0 y=8.0 = 0.25 W/kg

Zoom Scan - Max Peak SAR Value at x=48.0 y=3.0 z=0.0 = 0.34 W/kg

Max 1g SAR at x=48.0 y=7.0 z=0.0 = 0.23 W/kg

Max 10g SAR at x=45.0 y=7.0 z=0.0 = 0.15 W/kg

SAR - Z Axis  
at Hotspot x:48.0 y:3.0

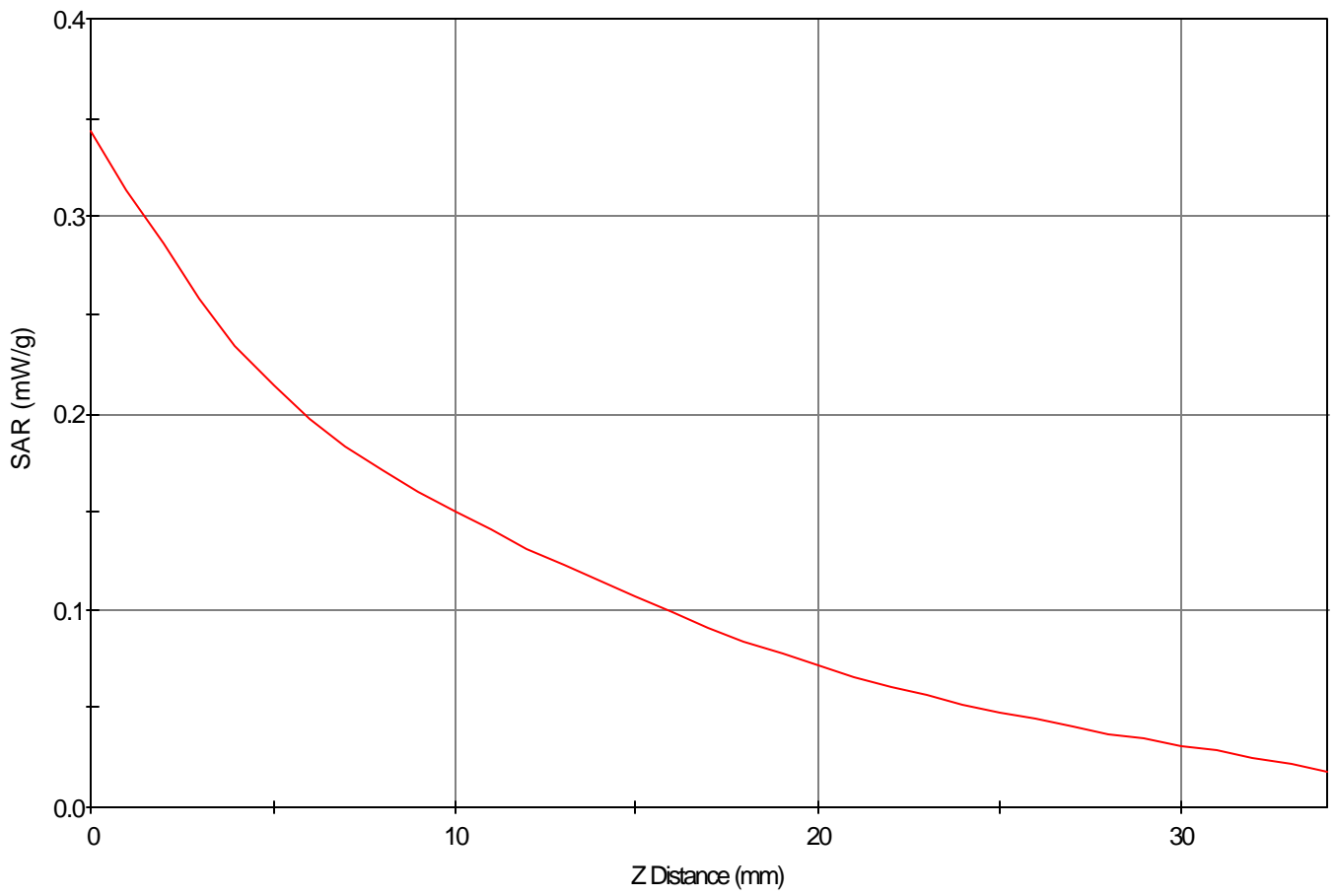

### 1g SAR Values

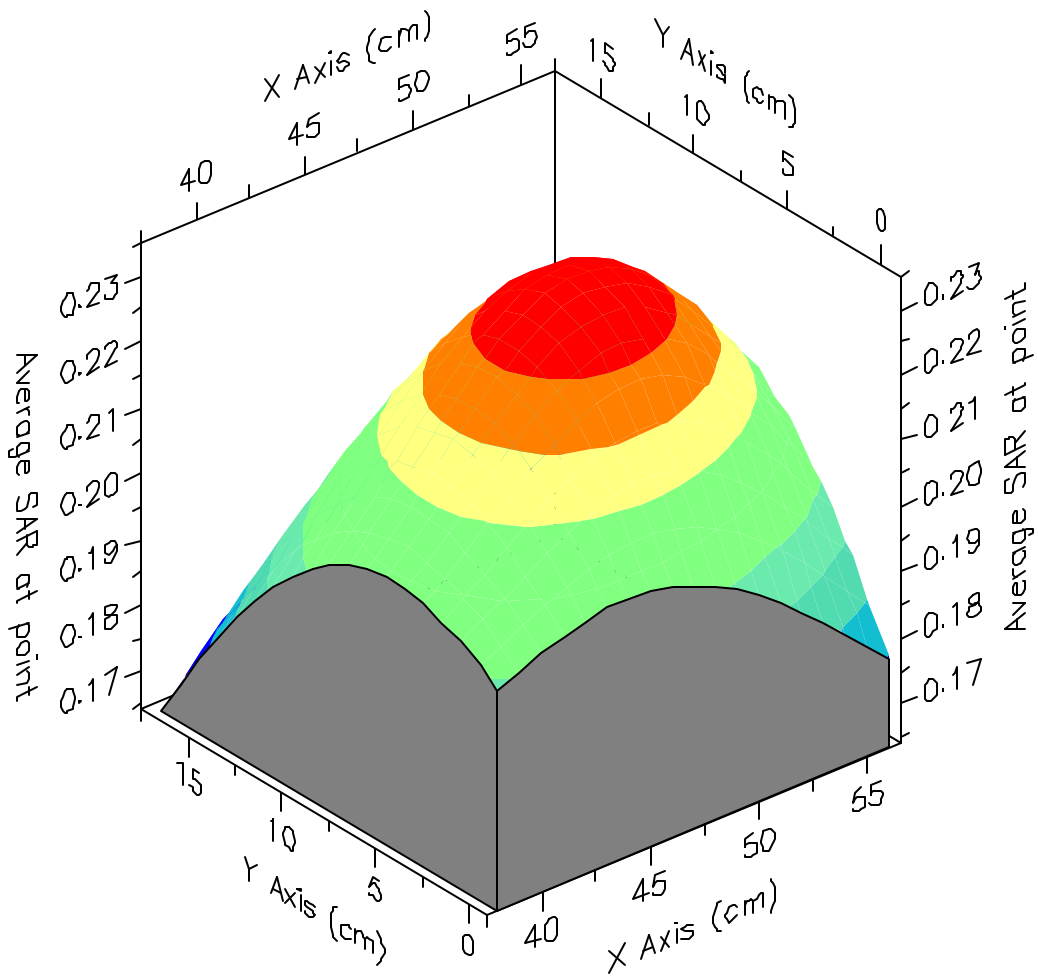



SAR Data Report 05062206

Start : 22-Jun-05 10:10:05 am  
End : 22-Jun-05 10:14:37 am  
Code Version : 4.08  
Robot Version: 4.08

Product Data:

Type : Samsung Dual-Band GSM Phone  
Model Number : SGH-D600  
Serial Number : FC-081-B  
Frequency : 848.8 MHz  
Transmit Pwr : 2 W  
Antenna Type : Helical  
Antenna Posn. : Internal

Measurement Data:

Phantom Name : SAM-LEFT  
Phantom Type : Left Ear  
Tissue Type : Brain  
Tissue Dielectric : 42.880  
Tissue Conductivity : 0.900  
Tissue Density : 1.000  
Robot Name : CRS

Probe Data:

Probe Name : PCT005  
Probe Type : E Fld Triangle  
Frequency : 835 MHz  
Tissue Type : Brain  
Calibrated Dielectric : 40.810  
Calibrated Conductivity : 0.870  
Calibrated Density : 1.000  
Probe Offset : 1.600 mm  
Conversion Factor : 5.500  
Probe Sensitivity : 3.807 3.736 3.821 mV/(mW/cm^2)  
Amplifier Gains : 20.00 20.00 20.00

Sample:

Rate: 6000 Samples/Sec  
Count: 1000 Samples  
NIDAQ Gain: 5

Comments:

GSM Mode Ch. 251  
Left Tilt (Slide In)  
CF=8; Amb. Temp= 22.5 'C; Liq. Temp=21.3 'C

Power Drop Test:

Reading @ start = 0.099  
Reading @ End = 0.095  
Power at End = 95.7%

Area Scan - Max Peak SAR Value at x=34.0 y=0.0 = 0.14 W/kg

Zoom Scan - Max Peak SAR Value at x=34.0 y=1.0 z=0.0 = 0.21 W/kg

Max 1g SAR at x=34.0 y=2.0 z=0.0 = 0.13 W/kg

Max 10g SAR at x=33.0 y=2.0 z=0.0 = 0.09 W/kg

SAR - Z Axis  
at Hotspot x:34.0 y:1.0

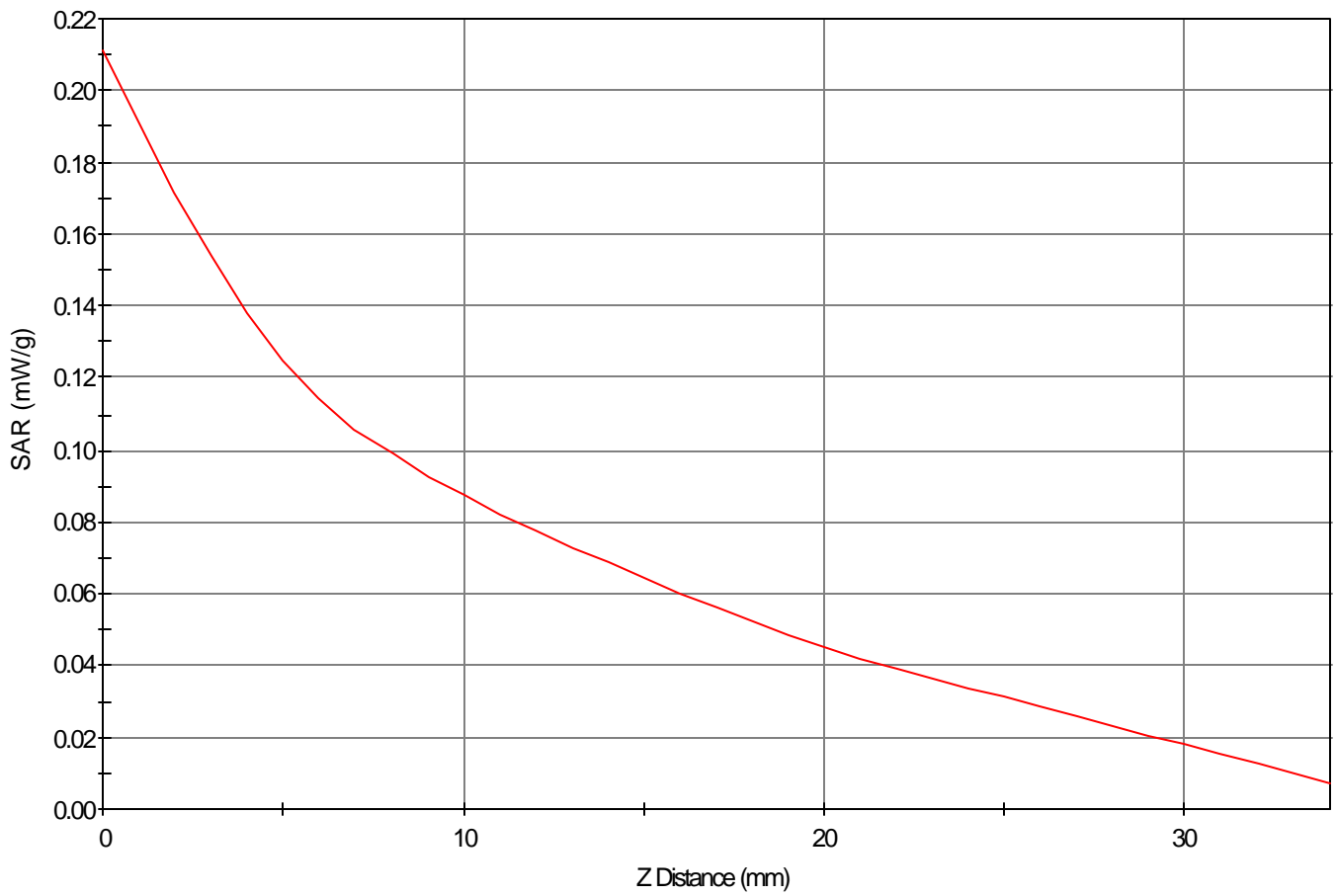

### 1g SAR Values

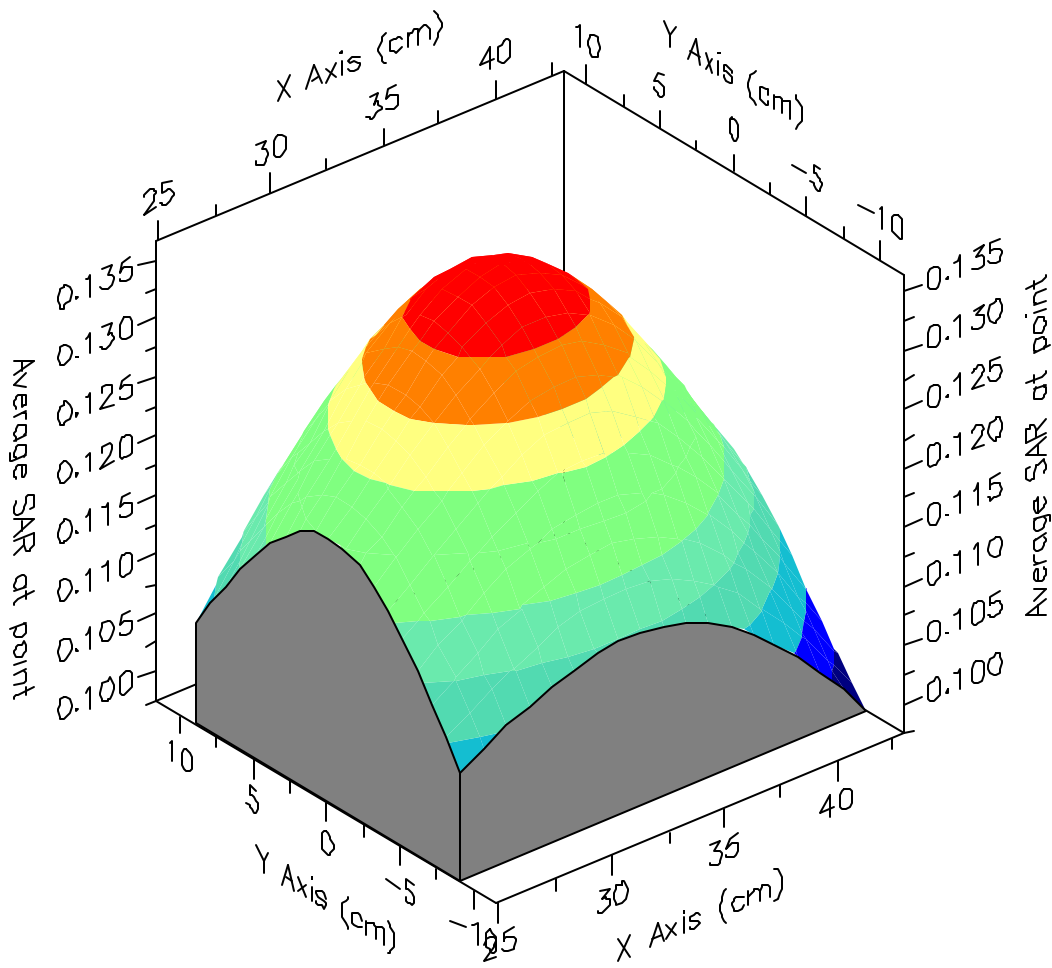

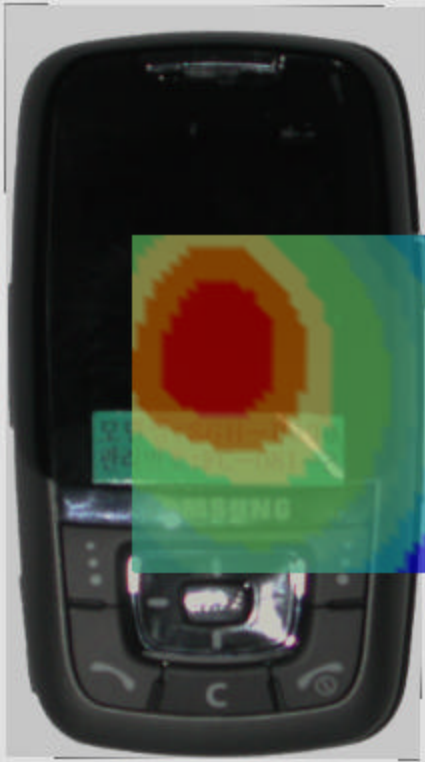

21  
24

MBNG

SAR Data Report 05062210

Start : 22-Jun-05 10:43:19 am  
End : 22-Jun-05 10:48:19 am  
Code Version : 4.08  
Robot Version: 4.08

Product Data:

Type : Samsung Dual-Band GSM Phone  
Model Number : SGH-D600  
Serial Number : FC-081-B  
Frequency : 848.8 MHz  
Transmit Pwr : 2 W  
Antenna Type : Helical  
Antenna Posn. : Internal

Measurement Data:

Phantom Name : SAM-LEFT  
Phantom Type : Left Ear  
Tissue Type : Brain  
Tissue Dielectric : 42.880  
Tissue Conductivity : 0.900  
Tissue Density : 1.000  
Robot Name : CRS

Probe Data:

Probe Name : PCT005  
Probe Type : E Fld Triangle  
Frequency : 835 MHz  
Tissue Type : Brain  
Calibrated Dielectric : 40.810  
Calibrated Conductivity : 0.870  
Calibrated Density : 1.000  
Probe Offset : 1.600 mm  
Conversion Factor : 5.500  
Probe Sensitivity : 3.807 3.736 3.821 mV/(mW/cm^2)  
Amplifier Gains : 20.00 20.00 20.00

Sample:

Rate: 6000 Samples/Sec  
Count: 1000 Samples  
NIDAQ Gain: 5

Comments:

GSM Mode Ch. 251  
Left Tilt (Slide Out)  
CF=8; Amb. Temp= 22.5 'C; Liq. Temp=21.3 'C

Power Drop Test:

Reading @ start = 0.001  
Reading @ End = 0.001  
Power at End = 137.3%

Area Scan - Max Peak SAR Value at x=59.0 y=8.0 = 0.03 W/kg

Zoom Scan - Max Peak SAR Value at x=65.0 y=8.0 z=0.0 = 0.05 W/kg

Max 1g SAR at x=62.0 y=7.0 z=0.0 = 0.03 W/kg

Max 10g SAR at x=62.0 y=6.0 z=0.0 = 0.02 W/kg

SAR - Z Axis  
at Hotspot x:65.0 y:8.0

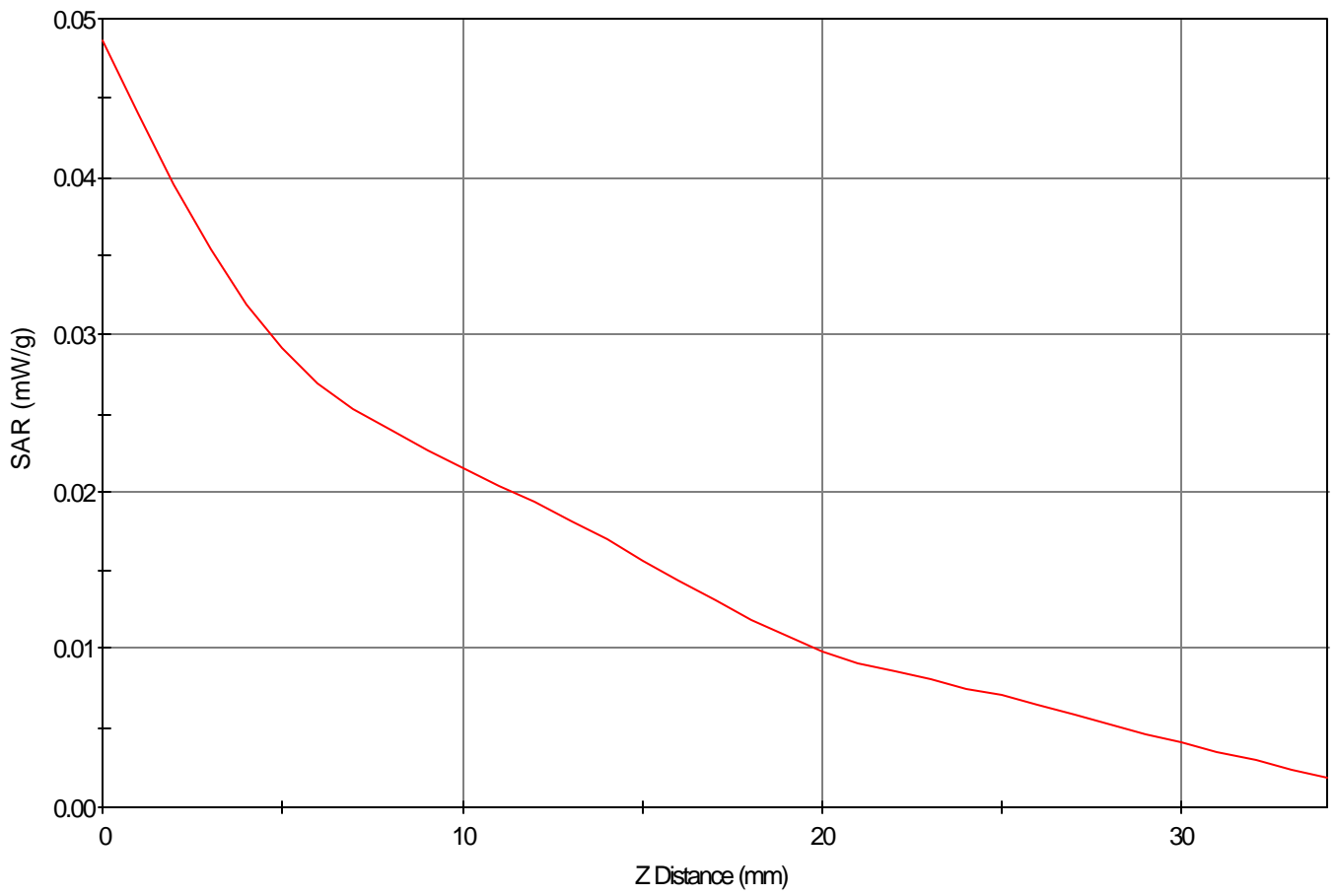

# 1g SAR Values

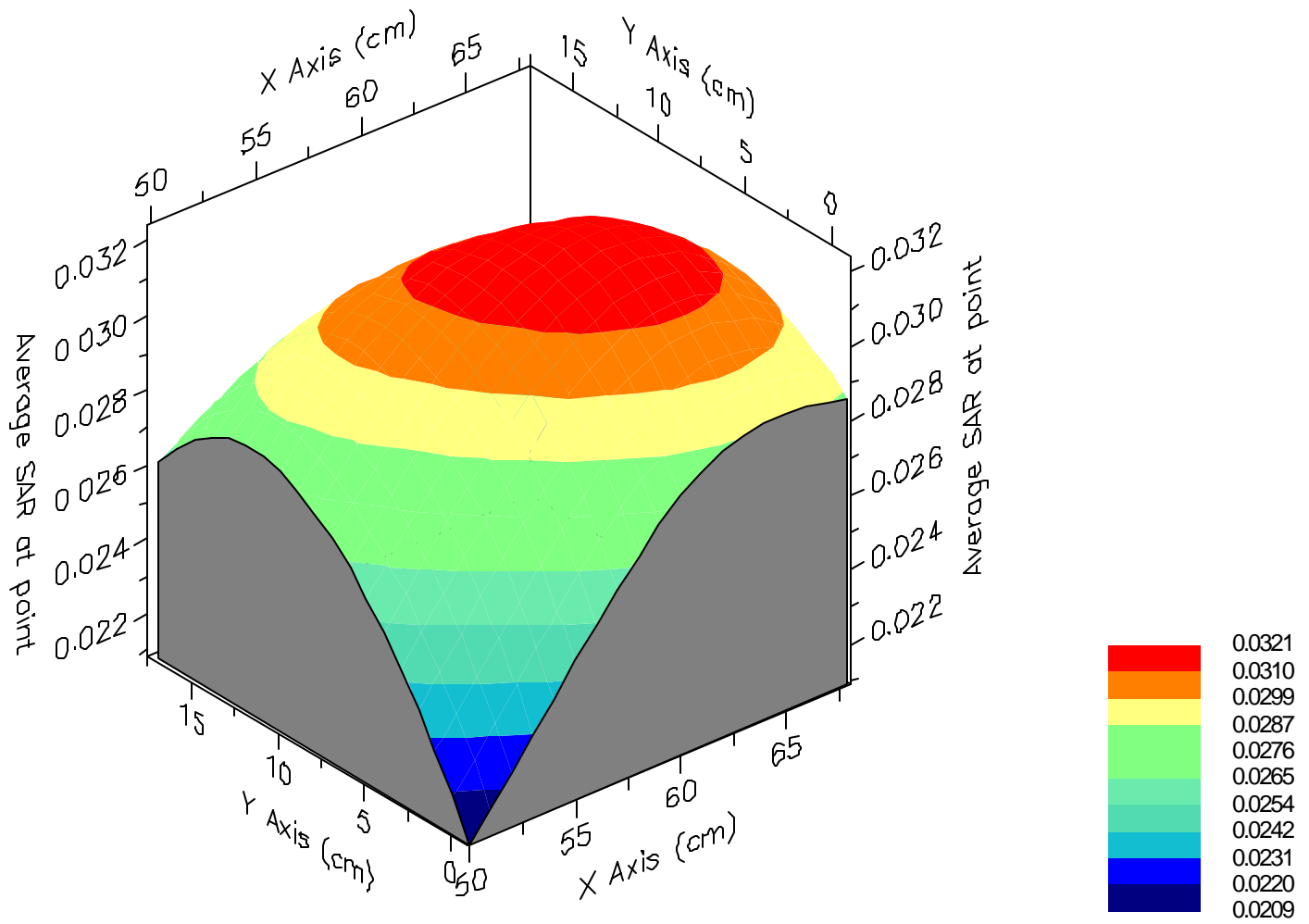



SAR Data Report 05062221

Start : 22-Jun-05 12:09:57 pm  
End : 22-Jun-05 12:15:15 pm  
Code Version : 4.08  
Robot Version: 4.08

Product Data:

Type : Samsung Dual-Band GSM Phone  
Model Number : SGH-D600  
Serial Number : FC-081-B  
Frequency : 848.8 MHz  
Transmit Pwr : 2 W  
Antenna Type : Helical  
Antenna Posn. : Internal

Measurement Data:

Phantom Name : SAM FLAT  
Phantom Type : Uniphantom  
Tissue Type : Muscle  
Tissue Dielectric : 53.020  
Tissue Conductivity : 0.990  
Tissue Density : 1.000  
Robot Name : CRS

Probe Data:

Probe Name : PCT005  
Probe Type : E Fld Triangle  
Frequency : 835 MHz  
Tissue Type : Muscle  
Calibrated Dielectric : 53.660  
Calibrated Conductivity : 0.980  
Calibrated Density : 1.000  
Probe Offset : 1.600 mm  
Conversion Factor : 5.850  
Probe Sensitivity : 3.807 3.736 3.821 mV/(mW/cm^2)  
Amplifier Gains : 20.00 20.00 20.00

Sample:

Rate: 6000 Samples/Sec  
Count: 1000 Samples  
NIDAQ Gain: 5

Comments:

GPRS Mode Ch. 251  
Body (Slide In w/ 1.5cm spacing)  
CF=4; Amb. Temp= 22.5 'C; Liq. Temp=21.3 'C

Power Drop Test:

Reading @ start = 0.164  
Reading @ End = 0.159  
Power at End = 96.9%

Area Scan - Max Peak SAR Value at x=19.0 y=-25.0 = 0.63 W/kg

Zoom Scan - Max Peak SAR Value at x=22.0 y=-25.0 z=0.0 = 2.36 W/kg

Max 1g SAR at x=22.0 y=-25.0 z=0.0 = 0.73 W/kg

Max 10g SAR at x=19.0 y=-25.0 z=0.0 = 0.37 W/kg

SAR - Z Axis  
at Hotspot x:22.0 y:-25.0

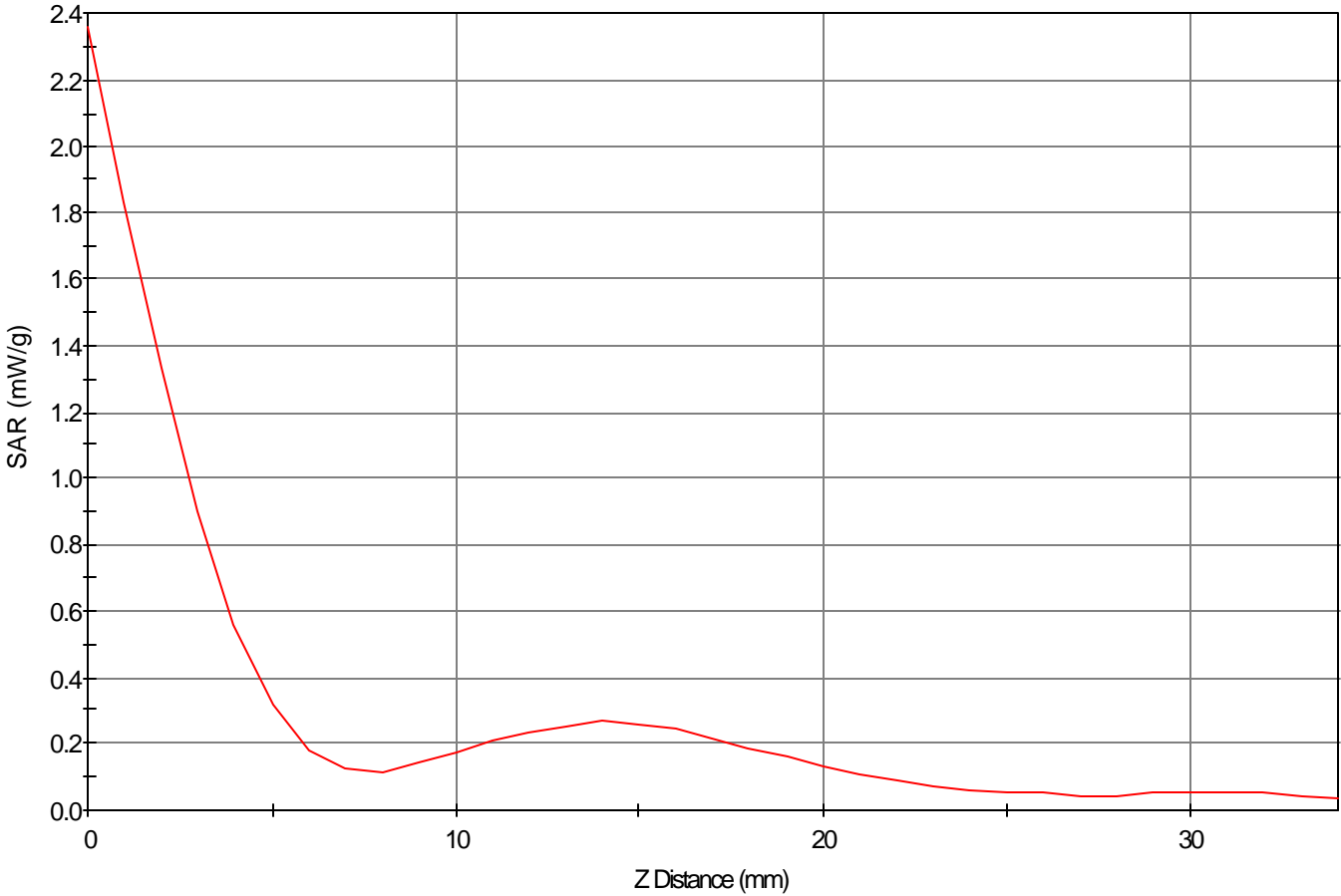

### 1g SAR Values

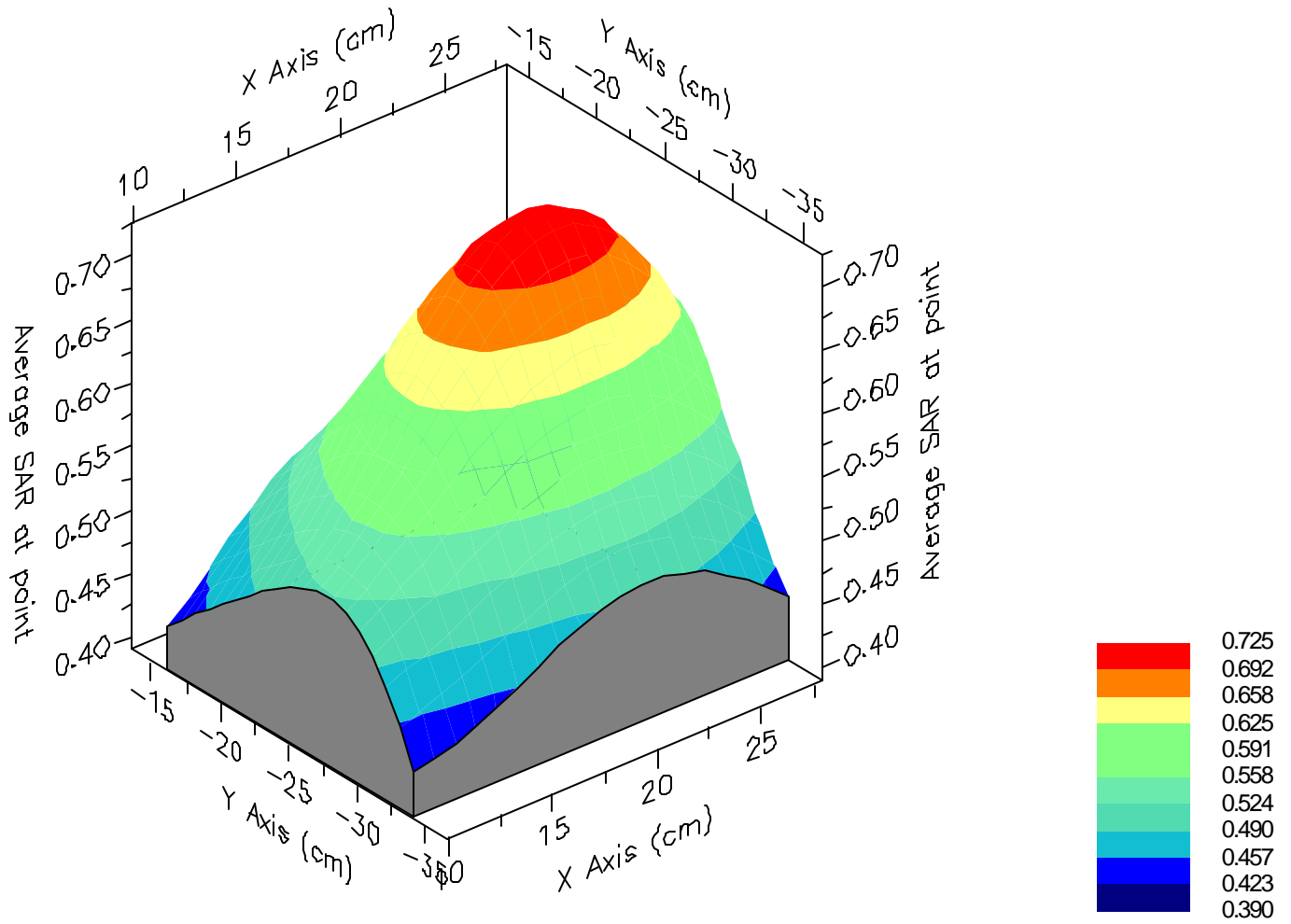

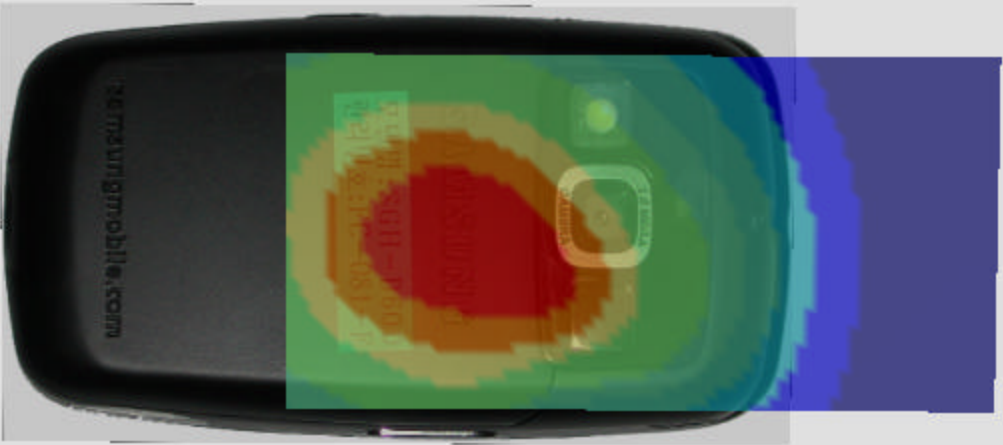

SAR Data Report 05062226

Start : 22-Jun-05 12:45:14 pm  
End : 22-Jun-05 12:50:33 pm  
Code Version : 4.08  
Robot Version: 4.08

Product Data:

Type : Samsung Dual-Band GSM Phone  
Model Number : SGH-D600  
Serial Number : FC-081-B  
Frequency : 848.8 MHz  
Transmit Pwr : 2 W  
Antenna Type : Helical  
Antenna Posn. : Internal

Measurement Data:

Phantom Name : SAM FLAT  
Phantom Type : Uniphantom  
Tissue Type : Muscle  
Tissue Dielectric : 53.020  
Tissue Conductivity : 0.990  
Tissue Density : 1.000  
Robot Name : CRS

Probe Data:

Probe Name : PCT005  
Probe Type : E Fld Triangle  
Frequency : 835 MHz  
Tissue Type : Muscle  
Calibrated Dielectric : 53.660  
Calibrated Conductivity : 0.980  
Calibrated Density : 1.000  
Probe Offset : 1.600 mm  
Conversion Factor : 5.850  
Probe Sensitivity : 3.807 3.736 3.821 mV/(mW/cm^2)  
Amplifier Gains : 20.00 20.00 20.00

Sample:

Rate: 6000 Samples/Sec  
Count: 1000 Samples  
NIDAQ Gain: 5

Comments:

GPRS Mode Ch. 251  
Body (Slide Out w/ 1.5cm spacing)  
CF=4; Amb. Temp= 22.5 'C; Liq. Temp=21.3 'C

Power Drop Test:

Reading @ start = 0.267  
Reading @ End = 0.254  
Power at End = 95.1%

Area Scan - Max Peak SAR Value at x=23.0 y=-27.0 = 0.61 W/kg

Zoom Scan - Max Peak SAR Value at x=21.0 y=-26.0 z=0.0 = 2.65 W/kg

Max 1g SAR at x=21.0 y=-26.0 z=0.0 = 0.80 W/kg

Max 10g SAR at x=23.0 y=-25.0 z=0.0 = 0.40 W/kg