

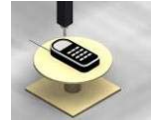

# PCTEST ENGINEERING LABORATORY, INC.

6660-B Dobbin Road, Columbia, MD 21045 USA  
Tel. 410.290.6652 / Fax 410.290.6554  
http://www.pctestlab.com



## HEARING AID COMPATIBILITY CERTIFICATE

**Applicant Name:**  
Samsung Electronics, Co. Ltd.  
18600 Broadwick St.  
Rancho Dominguez, CA 90220  
United States

**Date of Testing:**  
August 25 - 26, 2008  
**Test Site/Location:**  
PCTEST Lab, Columbia, MD, USA  
**Test Report Serial No.:**  
0808221158.A3L

**FCC ID:** A3LSCHR800

**APPLICANT:** SAMSUNG ELECTRONICS, CO. LTD.

**Scope of Test:** Audio Band Magnetic Testing (T-Coil)  
**Application Type:** Class II Permissive Change  
**FCC Rule Part(s):** § 20.19(b), §6.3(v), §7.3(v)  
**HAC Standard:** ANSI C63.19-2007  
**FCC Classification:** Licensed Transmitter Held to Ear (PCE)  
**EUT Type:** Cellular/PCS CDMA Phone with Bluetooth and EvDO  
**Model(s):** SCH-R800  
**Tx Frequency:** 824.70 - 848.31 MHz (Cellular CDMA)  
1851.25 - 1908.75 MHz (PCS CDMA)

**Test Device Serial No.:** Pre-Production Sample [S/N: AF-068-D]

**C63.19-2007 HAC Category:** T3 (SIGNAL TO NOISE CATEGORY)



This wireless portable device has been shown to be hearing-aid compatible under the above rated category, specified in ANSI/IEEE Std. C63.19-2007 and had been tested in accordance with the specified measurement procedures. Hearing-Aid Compatibility is based on the assumption that all production units will be designed electrically identical to the device tested in this report.

I attest to the accuracy of data. All measurements reported herein were performed by me or were made under my supervision and are correct to the best of my knowledge and belief. I assume full responsibility for the completeness of these measurements and vouch for the qualifications of all persons taking them.

*PCTEST certifies that no party to this application has been denied the FCC benefits pursuant to Section 5301 of the Anti-Drug Abuse Act of 1988, 21 U.S.C. 862.*

  
Randy Ortanez  
President





<b>FCC ID:</b> A3LSCHR800		<b>HAC (T-COIL) TEST REPORT</b>		<b>Reviewed by:</b> Quality Manager
<b>Filename:</b> 0808221158.A3L	<b>Test Dates:</b> August 25 - 26, 2008	<b>EUT Type:</b> Cellular/PCS CDMA Phone with Bluetooth and EvDO	Page 1 of 35	

# TABLE OF CONTENTS

---

1.	INTRODUCTION .....	3
2.	TEST SITE LOCATION .....	4
3.	EUT DESCRIPTION .....	5
4.	ANSI C63.19-2006 PERFORMANCE CATEGORIES .....	6
5.	METHOD OF MEASUREMENT .....	9
6.	TEST SUMMARY .....	19
7.	FCC 3G MEASUREMENTS .....	23
8.	MEASUREMENT UNCERTAINTY .....	24
9.	EQUIPMENT LIST .....	25
10.	CALIBRATION CERTIFICATES.....	26
11.	CONCLUSION.....	31
12.	REFERENCES .....	32
13.	TEST SETUP PHOTOGRAPHS .....	34

<b>FCC ID:</b> A3LSCHR800		<b>HAC (T-COIL) TEST REPORT</b>		<b>Reviewed by:</b> Quality Manager
<b>Filename:</b> 0808221158.A3L	<b>Test Dates:</b> August 25 - 26, 2008	<b>EUT Type:</b> Cellular/PCS CDMA Phone with Bluetooth and EvDO		Page 2 of 35

# 1. INTRODUCTION

On July 10, 2003, the Federal Communications Commission (FCC) adopted new rules requiring wireless manufacturers and service providers to provide digital wireless phones that are compatible with hearing aids. The FCC has modified the exemption for wireless phones under the Hearing Aid Compatibility Act of 1998 (HAC Act) in WT Docket 01-309 RM-8658<sup>1</sup> to extend the benefits of wireless telecommunications to individuals with hearing disabilities. These benefits encompass business, social and emergency communications, which increase the value of the wireless network for everyone. Approximately 500 million people worldwide and 30 million people in the United States suffer from hearing loss.

## Compatibility Tests Involved:

The standard calls for wireless communications devices to be measured for:

- RF Electric-field emissions
- RF Magnetic-field emissions
- T-coil mode, magnetic-signal strength in the audio band
- T-coil mode, magnetic-signal frequency response through the audio band
- T-coil mode, magnetic-signal and noise articulation index

The hearing aid must be measured for:

- RF immunity in microphone mode
- RF immunity in T-coil mode

In the following tests and results, this report includes the evaluation for a wireless communications device.

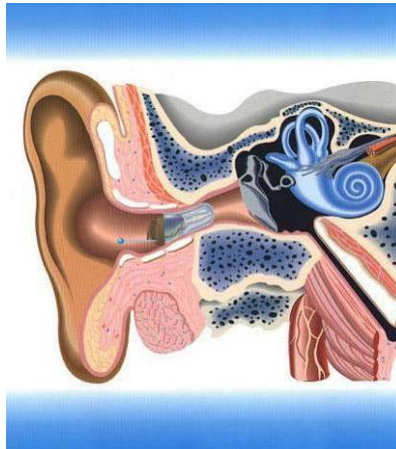



Figure 1-1 Hearing Aid *in-vitu*

<sup>1</sup> FCC Rule & Order, WT Docket 01-309 RM-8658

FCC ID: A3LSCHR800		HAC (T-COIL) TEST REPORT		Reviewed by: Quality Manager
Filename: 0808221158.A3L	Test Dates: August 25 - 26, 2008	EUT Type: Cellular/PCS CDMA Phone with Bluetooth and EvDO	Page 3 of 35	

## 2. TEST SITE LOCATION

### I. Introduction

The map at the right shows the location of the PCTEST LABORATORY in Columbia, Maryland. It is in proximity to the FCC Laboratory, the Baltimore-Washington International (BWI) airport, the city of Baltimore and Washington, DC (See Figure 2-1).

These measurement tests were conducted at the PCTEST Engineering Laboratory, Inc. facility in New Concept Business Park, Guilford Industrial Park, Columbia, Maryland. The site address is 6660-B Dobbin Road, Columbia, MD 21045. The test site is one of the highest points in the Columbia area with an elevation of 390 feet above mean sea level. The site coordinates are 39° 11'15" N latitude and 76° 49' 38" W longitude. The facility is 1.5 miles north of the FCC laboratory, and the ambient signal and ambient signal strength are approximately equal to those of the FCC laboratory. There are no FM or TV transmitters within 15 miles of the site. The detailed description of the measurement facility was found to be in compliance with the requirements of § 2.948 according to ANSI C63.4-2003 on January 27, 2006 and Industry Canada.

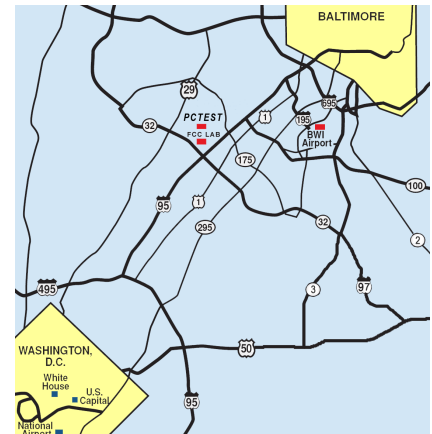

**Figure 2-1**  
**Map of the Greater Baltimore and Metropolitan Washington, D.C. Area**

### II. Test Facility / Accreditations:

Measurements were performed at an independent accredited PCTEST Engineering Lab located in Columbia, MD 21045, U.S.A.



- PCTEST Lab is accredited to ISO 17025-2005 by the American Association for Laboratory Accreditation (A2LA) in Specific Absorption Rate (SAR) testing, Hearing-Aid Compatibility (HAC), CTIA Test Plans, and wireless testing for FCC and Industry Canada Rules.
- PCTEST Lab is accredited to ISO 17025 by U.S. National Institute of Standards and Technology (NIST) under the National Voluntary Laboratory Accreditation Program (NVLAP Lab code: 100431-0) in EMC, FCC and Telecommunications.
- PCTEST facility is an FCC registered (PCTEST Reg. No. 90864) test facility with the site description report on file and has met all the requirements specified in Section 2.948 of the FCC Rules and Industry Canada (IC-2451).
- PCTEST Lab is a recognized U.S. Conformity Assessment Body (CAB) in EMC and R&TTE (n.b. 0982) under the U.S.-EU Mutual Recognition Agreement (MRA).
- PCTEST TCB is a Telecommunication Certification Body (TCB) accredited to ISO/IEC Guide 65 by the American National Standards Institute (ANSI) in all scopes of FCC Rules and all Industry Canada Standards (RSS).
- PCTEST facility is an IC registered (IC-2451) test laboratory with the site description on file at Industry Canada.
- PCTEST is a CTIA Authorized Test Laboratory (CATL) for AMPS and CDMA, and EvDO mobile phones.
- PCTEST is a CTIA Authorized Test Laboratory (CATL) for Over-the-Air (OTA) Antenna Performance testing for AMPS, CDMA, GSM, GPRS, EGPRS, UMTS (W-CDMA), CDMA 1xEVDO Data, CDMA 1xRTT Data.

<b>FCC ID:</b> A3LSCHR800		<b>HAC (T-COIL) TEST REPORT</b>		<b>Reviewed by:</b> Quality Manager
<b>Filename:</b> 0808221158.A3L	<b>Test Dates:</b> August 25 - 26, 2008	<b>EUT Type:</b> Cellular/PCS CDMA Phone with Bluetooth and EvDO		Page 4 of 35

### 3. EUT DESCRIPTION





**FCC ID:** A3LSCHR800  
**Applicant:** Samsung Electronics, Co. Ltd.  
 18600 Broadwick St.  
 Rancho Dominguez, CA 90220  
 United States  
**Trade Name:** SAMSUNG  
**Model(s):** SCH-R800  
**Serial Number:** AF-068-D  
**Tx Frequencies:** 824.70 - 848.31 MHz (Cellular CDMA)  
 1851.25 - 1908.75 MHz (PCS CDMA)

**HW Version:** R800.01  
**SW Version:** R800.BG31

**Maximum Conducted Power (EMC/SAR):** 25.1 dBm (CDMA), 25.3 dBm (PCS)  
**Maximum Conducted Power (HAC):** 25.1 dBm (CDMA), 25.3 dBm (PCS)  
**Antenna:** Internal Antenna  
**HAC Test Configurations:** CDMA, 1013, 384, 777, BT Off  
 PCS, 25, 600, 1175, BT Off

**FCC Classification:** Licensed Transmitter Held to Ear (PCE)  
**EUT Type:** Cellular/PCS CDMA Phone with Bluetooth and EvDO

<b>FCC ID:</b> A3LSCHR800	 <b>PCTEST</b> ENGINEERING LABORATORY, INC.	<b>HAC (T-COIL) TEST REPORT</b>		<b>Reviewed by:</b> Quality Manager
<b>Filename:</b> 0808221158.A3L	<b>Test Dates:</b> August 25 - 26, 2008	<b>EUT Type:</b> Cellular/PCS CDMA Phone with Bluetooth and EvDO	Page 5 of 35	

## 4. ANSI C63.19-2007 PERFORMANCE CATEGORIES



### I. RF EMISSIONS

The ANSI Standard presents performance requirements for acceptable interoperability of hearing aids with wireless communications devices. When these parameters are met, a hearing aid operates acceptably in close proximity to a wireless communications device.

Category	Telephone RF Parameters	
Near field Category	E-field emissions CW dB(V/m)	H-field emissions CW dB(A/m)
<b>f &lt; 960 MHz</b>		
<b>M1</b>	56 to 61 + 0.5 x AWF	5.6 to 10.6 +0.5 x AWF
<b>M2</b>	51 to 56 + 0.5 x AWF	0.6 to 5.6 +0.5 x AWF
<b>M3</b>	46 to 51 + 0.5 x AWF	-4.4 to 0.6 +0.5 x AWF
<b>M4</b>	< 46 + 0.5 x AWF	< -4.4 + 0.5 x AWF
<b>f &gt; 960 MHz</b>		
<b>M1</b>	46 to 51 + 0.5 x AWF	-4.4 to 0.6 +0.5 x AWF
<b>M2</b>	41 to 46 + 0.5 x AWF	-9.4 to -4.4 +0.5 x AWF
<b>M3</b>	36 to 41 + 0.5 x AWF	-14.4 to -9.4 +0.5 x AWF
<b>M4</b>	< 36 + 0.5 x AWF	< -14.4 + 0.5 x AWF
<b>Table 4-1</b> <b>Hearing aid and WD near-field categories</b> <b>as defined in ANSI C63.19-2007 [2]</b>		

### II. ARTICULATION WEIGHTING FACTOR (AWF)

Standard	Technology	Articulation Weighing Factor (AWF)
T1/T1P1/3GPP	UMTS (WCDMA)	0
TIA/EIA/IS-2000	CDMA	0
iDEN™	TDMA (22 and 11 Hz)	0
J-STD-007	GSM (217 Hz)	-5
<b>Table 4-2</b> <b>Articulation Weighting Factors</b>		

FCC ID: A3LSCHR800	 PCTEST ENGINEERING LABORATORY, INC.	HAC (T-COIL) TEST REPORT	 SAMSUNG	Reviewed by: Quality Manager
Filename: 0808221158.A3L	Test Dates: August 25 - 26, 2008	EUT Type: Cellular/PCS CDMA Phone with Bluetooth and EvDO	Page 6 of 35	

### III. MAGNETIC COUPLING

#### Axial and Radial Field Intensity

All orientations of the magnetic field, in the axial, horizontal and vertical position along the measurement plane shall be  $\geq -18$  dB(A/m) at 1 kHz in a 1/3 octave band filter per 7.3.1.

#### Frequency Response

The frequency response of the axial component of the magnetic field shall follow the response curve specified in EIA RS-504-1983, over the frequency range 300 Hz – 3000 Hz per 7.3.2.

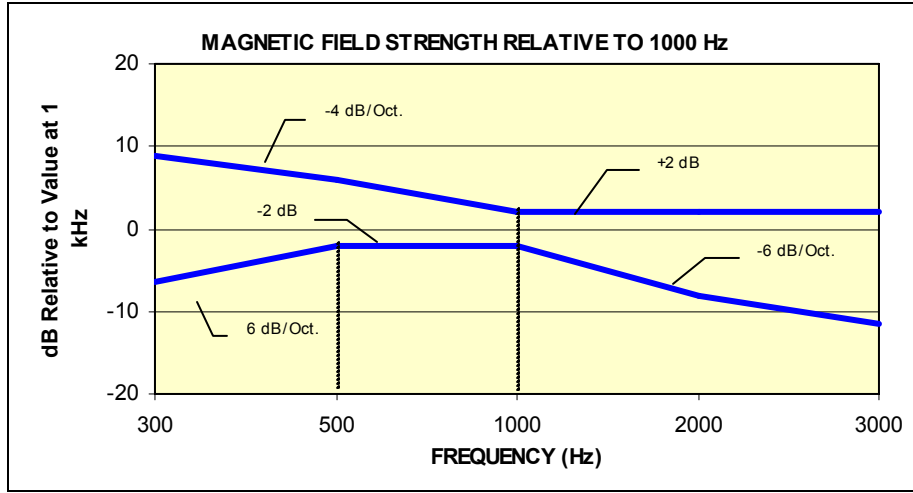

**Figure 4-1**  
Magnetic field frequency response for Wireless Devices with an axial field between  $\leq 15$  dB (A/m) at 1 kHz

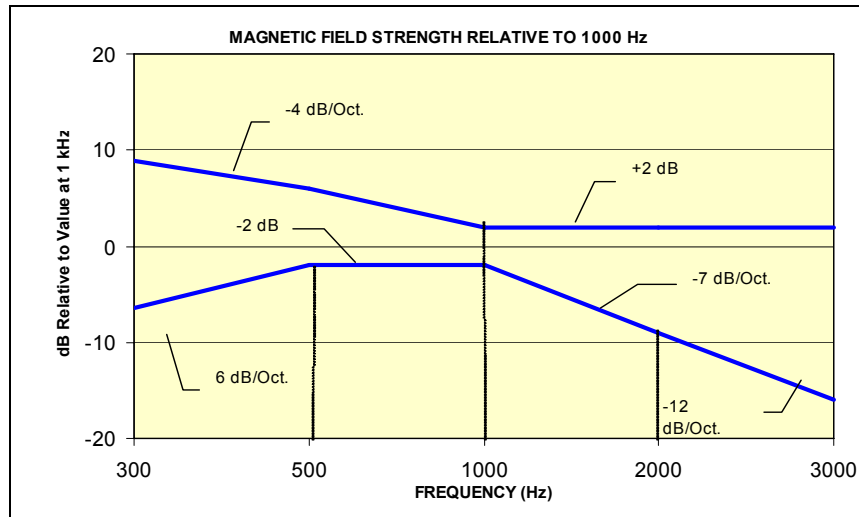

**Figure 4-2**  
Magnetic Field frequency response for wireless devices with an axial field that exceeds  $-15$  dB(A/m) at 1 kHz

FCC ID: A3LSCHR800		HAC (T-COIL) TEST REPORT		Reviewed by: Quality Manager
Filename: 0808221158.A3L	Test Dates: August 25 - 26, 2008	EUT Type: Cellular/PCS CDMA Phone with Bluetooth and EvDO		Page 7 of 35



## Signal Quality

The table below provides the signal quality requirement for the intended audio magnetic signal from a wireless device. Only the RF immunity of the hearing aid is measured in T-coil mode. It is assumed that a hearing aid can have no immunity to an interference signal in the audio band, which is the intended reception band for this mode. The only criterion that can be measured is the RF immunity in T-coil mode. This is measured using the same procedure as the audio coupling mode at the same levels.

The signal quality of the axial and radial components of the magnetic field was used to determine the T-coil mode category.

Category	Telephone RF Parameters
	Wireless Device Signal Quality (Signal + Noise-to-noise ratio in dB)
T1	0 to 10 dB
T2	10 to 20 dB
T3	20 to 30 dB
T4	> 30 dB

Table 4-3  
**Magnetic Coupling Parameters**

FCC ID: A3LSCHR800	 PCTEST ENGINEERING LABORATORY, INC.	HAC (T-COIL) TEST REPORT	 SAMSUNG	Reviewed by: Quality Manager
Filename: 0808221158.A3L	Test Dates: August 25 - 26, 2008	EUT Type: Cellular/PCS CDMA Phone with Bluetooth and EvDO		Page 8 of 35

## 5. METHOD OF MEASUREMENT

### I. Test Setup

The equipment was connected as shown in an acoustic/RF hemi-anechoic chamber:

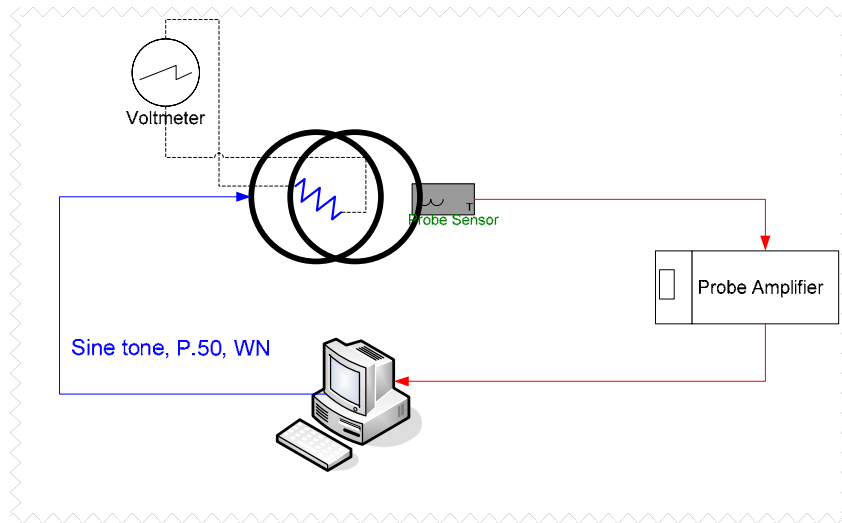

Figure 5-1 Validation Setup with Helmholtz Coil

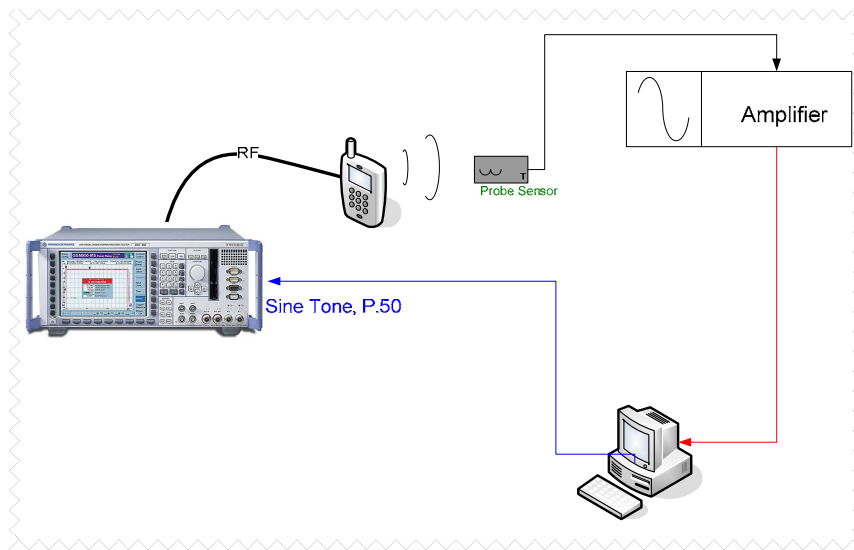

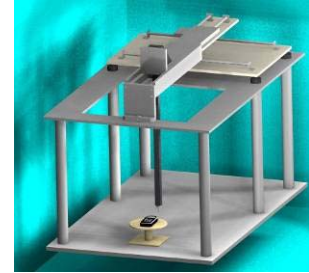

Figure 5-2 T-Coil Test Setup

FCC ID: A3LSCHR800	 PCTEST ENGINEERING LABORATORY, INC.	HAC (T-COIL) TEST REPORT	 SAMSUNG	Reviewed by: Quality Manager
Filename: 0808221158.A3L	Test Dates: August 25 - 26, 2008	EUT Type: Cellular/PCS CDMA Phone with Bluetooth and EvDO		Page 9 of 35

## II. Scanning Mechanism

Manufacturer: TEM  
 Accuracy:  $\pm 0.83$  cm/meter  
 Minimum Step Size: 0.1 mm  
 Maximum speed: 6.1 cm/sec  
 Line Voltage: 115 VAC  
 Line Frequency: 60 Hz  
 Material Composite: Delrin (Acetal)  
 Data Control: Parallel Port  
 Dynamic Range (X-Y-Z): 45 x 31.75 x 47 cm  
 Dimensions: 36" x 25" x 38"  
 Operating Area: 36" x 49" x 55"  
 Reflections: < -20 dB (in anechoic chamber)



**Figure 5-3**  
RF Near-Field Scanner

## III. ITU-T P.50 Artificial Voice

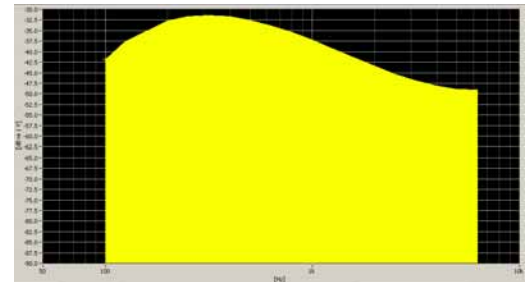

Manufacturer: ITU-T  
 Active Frequency Range: 100 Hz – 8 kHz  
 Stimulus Type: Male and Female, no spaces  
 Single Sample Duration: 20.96 seconds  
 Activity Level: 100%



**Figure 5-4**  
Spectral Characteristic of full P.50



**Figure 5-5**  
Temporal Characteristic of full P.50

FCC ID: A3LSCHR800		HAC (T-COIL) TEST REPORT		Reviewed by: Quality Manager
Filename: 0808221158.A3L	Test Dates: August 25 - 26, 2008	EUT Type: Cellular/PCS CDMA Phone with Bluetooth and EvDO		Page 10 of 35

ABM1 Measurement Block Diagram:



ABM2 Measurement Block Diagram:



**Figure 5-6 Magnetic Measurement Processing Steps**

#### IV. Test Procedure

1. Ambient Noise Check per C63.19 §6.2.1
  - a. Ambient interference was monitored using a Real-Time Analyzer between 100-10,000 Hz with 1/3 octave filtering.
  - b. “A-weighting” and Half-Band Integration was applied to the measurements.
  - c. Since this measurement was measured in the same method as ABM2 measurements, this level was verified to be less than 10 dB below the lowest measurement signal (which is the highest ABM2 measurement for a T4 WD). Therefore the maximum noise level for a T4 WD with an ABM1 = -18 dBA/m is:  

$$-18 - 30 - 10 + AWF = -58 \text{ dBA/m}$$
2. Measurement System Validation (See Figure 5-1)
  - a. The measurement system including the probe, pre-amplifier and acquisition system were validated as an entire system to ensure the reliability of test measurements.
  - b. ABM1 Validation  
 The magnetic field at the center of the Helmholtz coil is given by the equation (per C63.19 Annex D.9.1):

$$H_c = \frac{NI}{r\sqrt{1.25^3}} = \frac{N\left(\frac{V}{R}\right)}{r\sqrt{1.25^3}}$$

Where  $H_c$  = magnetic field strength in amperes per meter  
 N = number of turns per coil

For the Helmholtz Coil,  $N=20$ ;  $r=0.08\text{m}$ ;  $R=10.193\Omega$  and using  $V=57\text{mV}$ :

$$H_c = \frac{20 \cdot \left(\frac{0.057}{10.193}\right)}{0.08 \cdot \sqrt{1.25^3}} = 1.0003 \text{ A/m}$$

Therefore a pure tone of 1kHz was applied into the coils such that 57 mV was observed across the 10 Ω resistor. The voltmeter used for measurement was verified to be capable of measurements in the audio band range. This theoretically generates an expected field of 1 A/m in the center of the Helmholtz coil which was used to validate the probe

<b>FCC ID:</b> A3LSCHR800		<b>HAC (T-COIL) TEST REPORT</b>		<b>Reviewed by:</b> Quality Manager
<b>Filename:</b> 0808221158.A3L	<b>Test Dates:</b> August 25 - 26, 2008	<b>EUT Type:</b> Cellular/PCS CDMA Phone with Bluetooth and EvDO	Page 11 of 35	

measurement at 1 A/m. This was verified to be within  $\pm 0.5$  dB of the 1 A/m value (see Page 20).

c. Frequency Response Validation

The frequency response through the Helmholtz Coil was verified to be within 0.5 dB relative to 1 kHz, between 300 – 3000 Hz using the ITU-P.50 artificial speech signal as shown below:

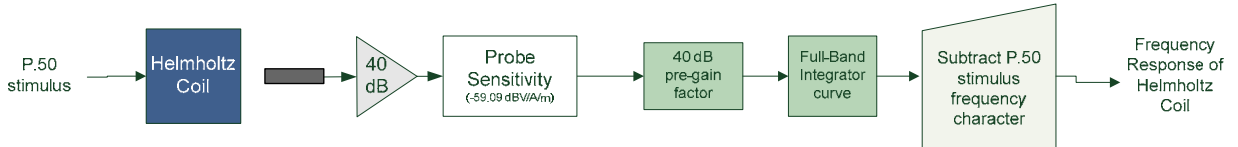

**Figure 5-7 Frequency Response Validation**

d. ABM2 Measurement Validation

WD noise measurements are filtered with A-weighting and Half-Band Integration over a frequency range of 100Hz – 10kHz to process ABM2 measurements. Below is the verification of the system processing A-weighting and Half-Band integration between system input to output within 0.5 dB of the theoretical result:

**Table 5-1  
ABM2 Frequency Response Validation**

f (Hz)	HBI, A - Measured (dB re 1kHz)	HBI, A - Theoretical (dB re 1kHz)	dB Var.
100	-16.180	-16.170	-0.010
125	-13.257	-13.250	-0.007
160	-10.347	-10.340	-0.007
200	-8.017	-8.010	-0.007
250	-5.925	-5.920	-0.005
315	-4.045	-4.040	-0.005
400	-2.405	-2.400	-0.005
500	-1.212	-1.210	-0.002
630	-0.349	-0.350	0.001
800	0.071	0.070	0.001
1000	0.000	0.000	0.000
1250	-0.503	-0.500	-0.003
1600	-1.513	-1.510	-0.003
2000	-2.778	-2.780	0.002
2500	-4.316	-4.320	0.004
3150	-6.166	-6.170	0.004
4000	-8.322	-8.330	0.008
5000	-10.573	-10.590	0.017
6300	-13.178	-13.200	0.022
8000	-16.241	-16.270	0.029
10000	-19.495	-19.520	0.025

FCC ID: A3LSCHR800	PCTEST ENGINEERING LABORATORY, INC.	HAC (T-COIL) TEST REPORT	SAMSUNG	Reviewed by: Quality Manager
Filename: 0808221158.A3L	Test Dates: August 25 - 26, 2008	EUT Type: Cellular/PCS CDMA Phone with Bluetooth and EvDO		Page 12 of 35



**Figure 5-8**  
**ABM2 Frequency Response Validation**

The ABM2 result is a power sum from 100 Hz to 10 kHz with half-band integration and A-weighting. To verify the power sum measurement, a power sum over the full band was measured and verified to track with the source level (See Figure 5-9). Therefore the setup in this step was used to verify the power sum post-processing for ABM2 measurements. See below block diagram:

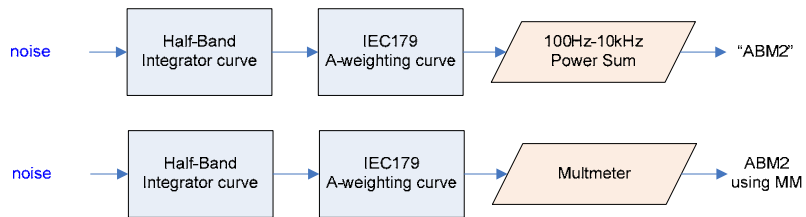



**Figure 5-9**  
**ABM2 Validation Block Diagram**

The power summed output results for a known input were compared to the multi-meter results to verify any deviation in the post-processing implemented with the power-sum.

**Table 5-2**  
**ABM2 Power Sum Validation**

WN Input (dBV)	Power Sum (dBV)	Multimeter-Full (dBV)	Dev (dB)
-60	-60.36	-60.2	0.16
-50	-50.19	-50.13	0.06
-40	-40.14	-40.03	0.11
-30	-30.13	-30.01	0.12
-20	-20.12	-20	0.12
-10	-10.14	-10	0.14

<b>FCC ID:</b> A3LSCHR800	 <b>PCTEST</b> ENGINEERING LABORATORY, INC.	<b>HAC (T-COIL) TEST REPORT</b>		<b>Reviewed by:</b> Quality Manager
<b>Filename:</b> 0808221158.A3L	<b>Test Dates:</b> August 25 - 26, 2008	<b>EUT Type:</b> Cellular/PCS CDMA Phone with Bluetooth and EvDO	Page 13 of 35	

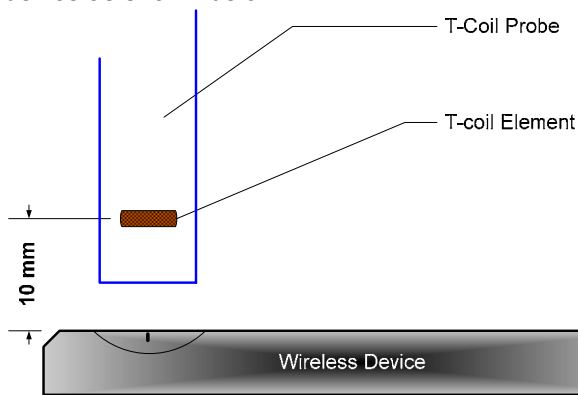

**Figure 5-10**  
**ABM2 Power Sum Validation**

3. Measurement Test Setup



a. Fine scan above the WD (TEM)

- i. A multitone signal was applied to the handset such that the phone acoustic output was stable within 1dB over the probe settling time and with the acoustic output level at the C63.19 specified levels (below). The measurement step size was in 2 mm increments at a distance of 10 mm between the surface of the wireless device as shown below:



**Figure 5-11**  
**Measurement Distance**

- ii. After scanning, the planar field maximum point was determined. The position of the probe was moved to this location to setup the test using the sound check system.
- iii. These steps were repeated for the other T-coil orientations (of axial, radial transverse, or radial longitudinal) per Figure 5-16 after a T-coil orientation was fully measured with the sound check system.

FCC ID: A3LSCHR800		HAC (T-COIL) TEST REPORT		Reviewed by: Quality Manager
Filename: 0808221158.A3L	Test Dates: August 25 - 26, 2008	EUT Type: Cellular/PCS CDMA Phone with Bluetooth and EvDO	Page 14 of 35	

- b. Speech Signal Setup to Base Station Simulator
  - i. C63.19 Table 6-1 states audio reference input levels for various technologies:

Standard	Technology	Input Level (dBm0)
TIA/EIA/IS-2000	CDMA	-18
J-STD-007	GSM (217)	-16
T1/T1P1/3GPP	UMTS (WCDMA)	-16
iDEN™	TDMA (22 and 11 Hz)	-18

The CMU200 audio levels were determined using base station simulator manufacturer calibration procedures resulting in the below corresponding voltages relative to handset test point level (in dBm0):

**Table 5-3  
CMU200 Voltage Input Levels for Audio**

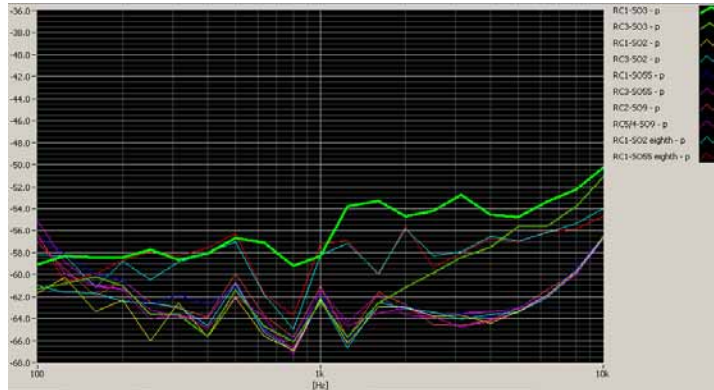

dBm0 Ref.	Input Voltage		Notes
3.14 dBm0	1052.0 mV	0.4 dBV	From CDMA2K "DECODER CAL". (What is needed through Encoder for FS)
-18 dBm0	92.260 mV	-20.7 dBV	For 8k Enhanced (Low)

- c. Real-Time Analyzer (RTA)
  - i. The Real-Time Analyzer was configured to analyze measurements using 1/3 Octave band weighted filtering.
- d. WD Radio Configuration Selection
  - i. The device was chosen to be tested in the worst-case ABM2 condition under RC1/SO3 (see below):



**Figure 5-12  
Vocoder Analysis for ABM Noise**

- 4. Signal Quality Data Analysis
  - a. Narrow-band Magnetic Intensity
    - i. The standard specifies a 1 kHz 1/3 octave band minimum field intensity for a sine tone. The ABM1 measurements were evaluated at 1kHz with 1/3 octave band filtering over an averaged period of 10 seconds.
  - b. Frequency Response
    - i. The appropriate frequency response curve was measured to curves in Figure 4-1 or Figure 4-2 between 300 – 3000 Hz using digital linear averaging (limit lines

FCC ID: A3LSCHR800	 PCTEST ENGINEERING LABORATORY, INC.	HAC (T-COIL) TEST REPORT		Reviewed by: Quality Manager
Filename: 0808221158.A3L	Test Dates: August 25 - 26, 2008	EUT Type: Cellular/PCS CDMA Phone with Bluetooth and EvDO	Page 15 of 35	

chosen according to measurement found in step 4a.) A linear average over 3x the length of the artificial voice signal (3x sampling) was performed. A 10 second delay was configured in the measurement process of the stimulus to ensure handset vocoder latency effects and echo cancellation devices (if any) were appropriately stabilized during measurements.

- ii. The appropriate post-processing was applied according to the system processing chain illustrated in Figure 5-13. All R10 frequencies were plotted with respect to 0dB at 1 kHz value and aligned with respect to the EIA-504 mask.

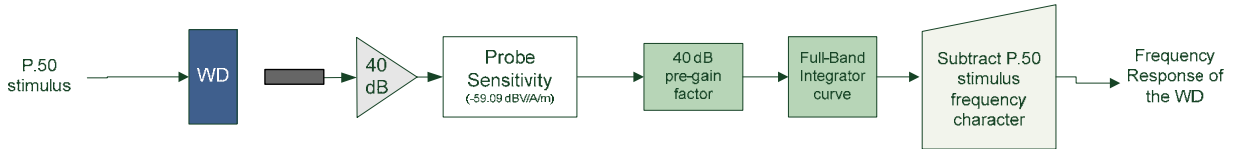

**Figure 5-13 Frequency Response Block Diagram**

- iii. The margin is represented by the closest measured data point on the curve to the EIA-504 limit lines, in dB.
- c. Signal Quality Index
- i. Ensuring the WD was at maximum RF power, maximum volume, backlight on, display on, maximum contrast setting, keypad lights on (when possible) with no audio signal through the vocoder, the WD was measured over at least 100 Hz – 10,000 Hz, maximized over 5 seconds with a 50ms sample time for the ABM2 measurement (5 second time period is used in noise measurements under standards such as IEEE 269, etc.)
  - ii. After applying half-band integration and A-weighting to the result, a power sum was applied over each 1/3 octave bandwidth frequency for an ABM2 value
  - iii. This result was subtracted from the ABM1 result in step a, to obtain the Signal Quality.

## V. Test Setup

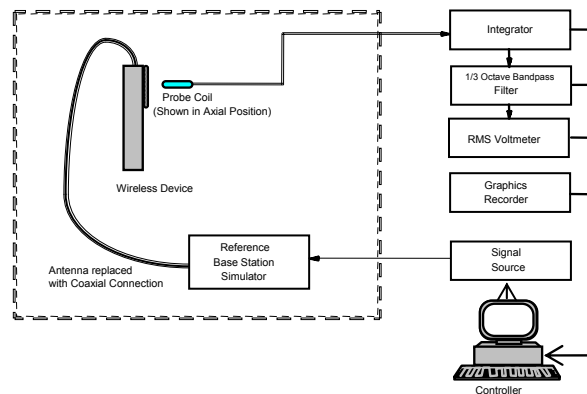

**Figure 5-14 Audio Magnetic Field Test Setup**

## VI. Deviation from C63.19 Test Procedure

Scan increments at 2mm; Radiated

<b>FCC ID:</b> A3LSCHR800		<b>HAC (T-COIL) TEST REPORT</b>		<b>Reviewed by:</b> Quality Manager
<b>Filename:</b> 0808221158.A3L	<b>Test Dates:</b> August 25 - 26, 2008	<b>EUT Type:</b> Cellular/PCS CDMA Phone with Bluetooth and EvDO		Page 16 of 35

## VII. Wireless Device Channels and Frequencies

The frequencies listed in the table below are those that lie in the center of the bands used for cellular telephony. Low, middle and high channels were tested in each band for FCC compliance evaluation to ensure the maximum emission is captured across the entire band.

To facilitate setting of a base station simulator for ABM measurements, specific band plan channel numbers are listed that may be used in lieu of the band center frequencies.

**Table 5-4  
Center Channels and Frequencies**

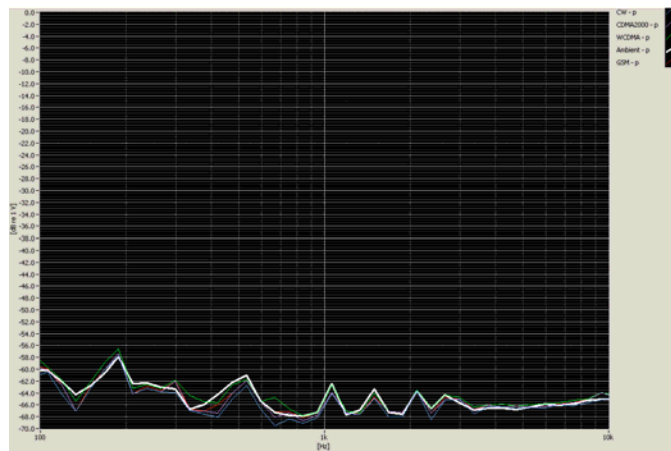

Test frequencies & associated channels	
Channel	Frequency (MHz)
<b>Cellular 850</b>	
384 (CDMA)	836.52
UARFCN 4183(UMTS)	836.60
190 (GSM)	836.60
<b>PCS 1900</b>	
661 (GSM)	1880
600 (CDMA)	1880
UARFCN 9400 (UMTS)	1880

## VIII. RF Emission Effect on T-coil Measurements



**Figure 5-15**

**High power RF Emissions Effect with HAC Dipole on the T-coil Probe System 10mm between dipole maximum and magnetic probe**



FCC ID: A3LSCHR800	 PCTEST ENGINEERING LABORATORY, INC.	HAC (T-COIL) TEST REPORT	 SAMSUNG	Reviewed by: Quality Manager
Filename: 0808221158.A3L	Test Dates: August 25 - 26, 2008	EUT Type: Cellular/PCS CDMA Phone with Bluetooth and EvDO	Page 17 of 35	

## IX. Test Flow

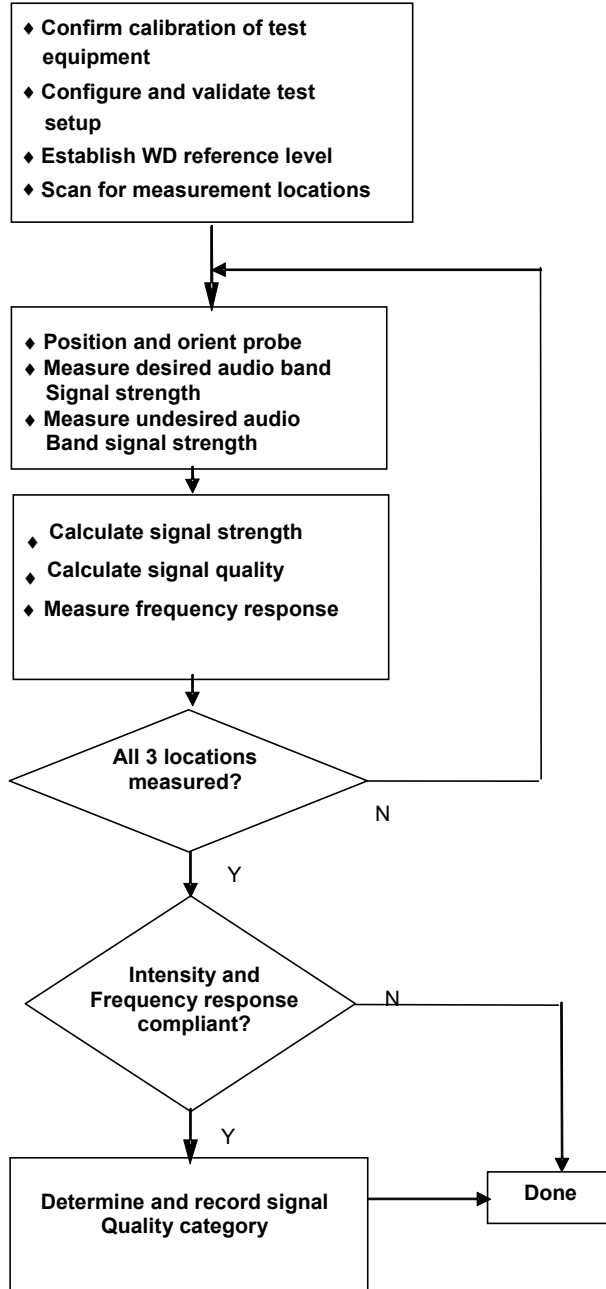
The flow diagram below was followed (From C63.19):



**Figure 5-16**  
**C63.19 T-Coil Signal Test Process**

FCC ID: A3LSCHR800		HAC (T-COIL) TEST REPORT		Reviewed by: Quality Manager
Filename: 0808221158.A3L	Test Dates: August 25 - 26, 2008	EUT Type: Cellular/PCS CDMA Phone with Bluetooth and EvDO		Page 18 of 35

## 6. TEST SUMMARY

### I. T-Coil Test Summary

**Table 6-1  
Table of Results**



C63.19 Sec.	Mode	Band	Test Description	Minimum Limit*	Measured	Verdict
				<i>dBa/m</i>	<i>dBa/m</i>	<i>PASS/FAIL</i>
7.3.1.1	CDMA	Cellular	Intensity, Axial	-18	-4.3	PASS
7.3.1.2			Intensity, RadialH	-18	-10.5	PASS
7.3.1.2			Intensity, RadialV	-18	-12.1	PASS
7.3.3			Signal-to-Noise/Noise, Axial	20	34.0	PASS
7.3.3			Signal-to-Noise/Noise, RadialH	20	30.9	PASS
7.3.3			Signal-to-Noise/Noise, RadialV	20	21.9	PASS
7.3.2			Frequency Response, Axial	0	1.6	PASS
7.3.1.1	CDMA	PCS	Intensity, Axial	-18	-4.3	PASS
7.3.1.2			Intensity, RadialH	-18	-10.6	PASS
7.3.1.2			Intensity, RadialV	-18	-12.0	PASS
7.3.3			Signal-to-Noise/Noise, Axial	20	33.8	PASS
7.3.3			Signal-to-Noise/Noise, RadialH	20	28.7	PASS
7.3.3			Signal-to-Noise/Noise, RadialV	20	21.5	PASS
7.3.2			Frequency Response, Axial	0	1.8	PASS

Note: The above summary table represents the worst-case numerical values according to configurations in Table 6-3.

**Table 6-2  
Consolidated Tabled Results**

	Volume Setting	Cellular			PCS		
		Axial	RadialH	RadialV	Axial	RadialH	RadialV
Freq. Response Margin	Maximum	PASS	PASS	PASS	PASS	PASS	PASS
Magnetic Intensity Verdict		PASS	PASS	PASS	PASS	PASS	PASS
FCC SNR Verdict		PASS	PASS	PASS	PASS	PASS	PASS

Note: The above table represents the pass/fail verdict according to data in Table 6-3.

FCC ID: A3LSCHR800	 PCTEST ENGINEERING LABORATORY, INC.	HAC (T-COIL) TEST REPORT		Reviewed by: Quality Manager
Filename: 0808221158.A3L	Test Dates: August 25 - 26, 2008	EUT Type: Cellular/PCS CDMA Phone with Bluetooth and EvDO		Page 19 of 35

## II. Raw Handset Data



**Table 6-3  
Raw Data Results**

	Volume	Cellular Band								
		Axial			RadialH			RadialV		
		1013	384	777	1013	384	777	1013	384	777
ABM1, dBA/m	Maximum	-4.31	-4.29	-4.04	-10.49	-10.54	-10.36	-12.06	-11.63	-12.01
ABM2, dBA/m		-38.75	-38.28	-40.26	-41.62	-41.45	-42.42	-33.98	-33.81	-34.53
Ambient Noise, dBA/m		-58.83	-58.83	-58.83	-60.08	-60.08	-60.08	-59.70	-59.70	-59.70
Freq. Response Margin (dB)		1.72	2.00	1.60	1.93	2.00	1.97	2.00	2.00	1.92
S+N/N (dB)		34.44	33.98	36.22	31.13	30.91	32.06	21.91	22.18	22.52
S+N/N per orientation (dB)		33.98			30.91			21.91		
	Volume	PCS Band								
		Axial			RadialH			RadialV		
		25	600	1175	25	600	1175	25	600	1175
ABM1, dBA/m	Maximum	-4.08	-4.26	-4.05	-10.55	-10.28	-10.42	-12.00	-11.69	-11.96
ABM2, dBA/m		-37.90	-38.21	-38.22	-39.28	-39.74	-39.77	-33.50	-33.70	-33.60
Ambient Noise, dBA/m		-58.83	-58.83	-58.83	-60.08	-60.08	-60.08	-59.70	-59.70	-59.70
Freq. Response Margin (dB)		1.95	2.00	1.84	2.00	1.87	1.76	2.00	2.00	1.95
S+N/N (dB)		33.81	33.96	34.17	28.72	29.46	29.35	21.49	22.01	21.64
S+N/N per orientation (dB)		33.81			28.72			21.49		
T-coil Coordinates (cm)	[x,y] from bottom left	2.8, 2.6			2.6, 2.0			3.0,2.6		

Note: ABM1 >> Ambient noise

### WD Configuration

1. Radio Configuration: RC1/SO3
2. Power Configuration: Power Control Bits = "All Up"
3. Phone Condition: Mute on; Backlight on; Max Volume, Max Contrast

FCC ID: A3LSCHR800		HAC (T-COIL) TEST REPORT		Reviewed by: Quality Manager
Filename: 0808221158.A3L	Test Dates: August 25 - 26, 2008	EUT Type: Cellular/PCS CDMA Phone with Bluetooth and EvDO	Page 20 of 35	

### III. Frequency Response Graph

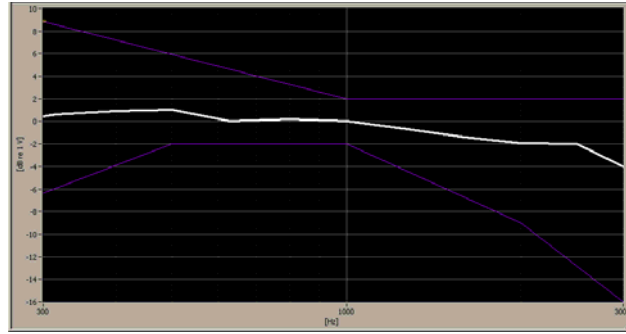

**Figure 6-1**  
**Axial Frequency Response**

Note: This frequency response represents the worst-case ABM2 test configuration according to Table 6-3.

### IV. 1 kHz Vocoder Application Check

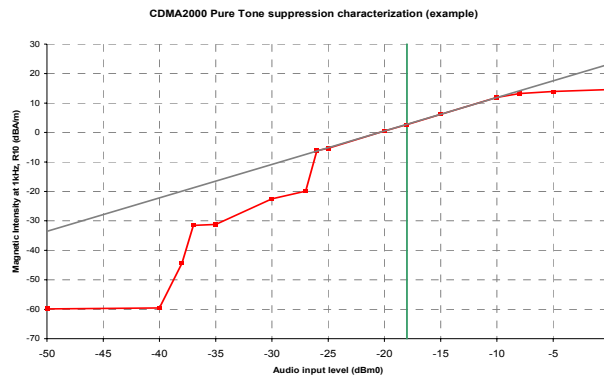

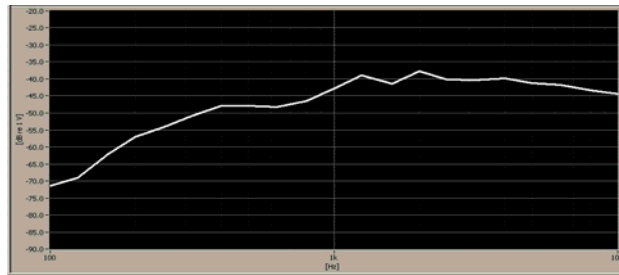

This model was verified to be within the linear region for ABM1 measurements. This measurement was taken in the axial configuration above the ABM1 maximum location/configuration derived from Table 6-3.

### V. Undesirable Audio Magnetic Band Plot (ABM2)

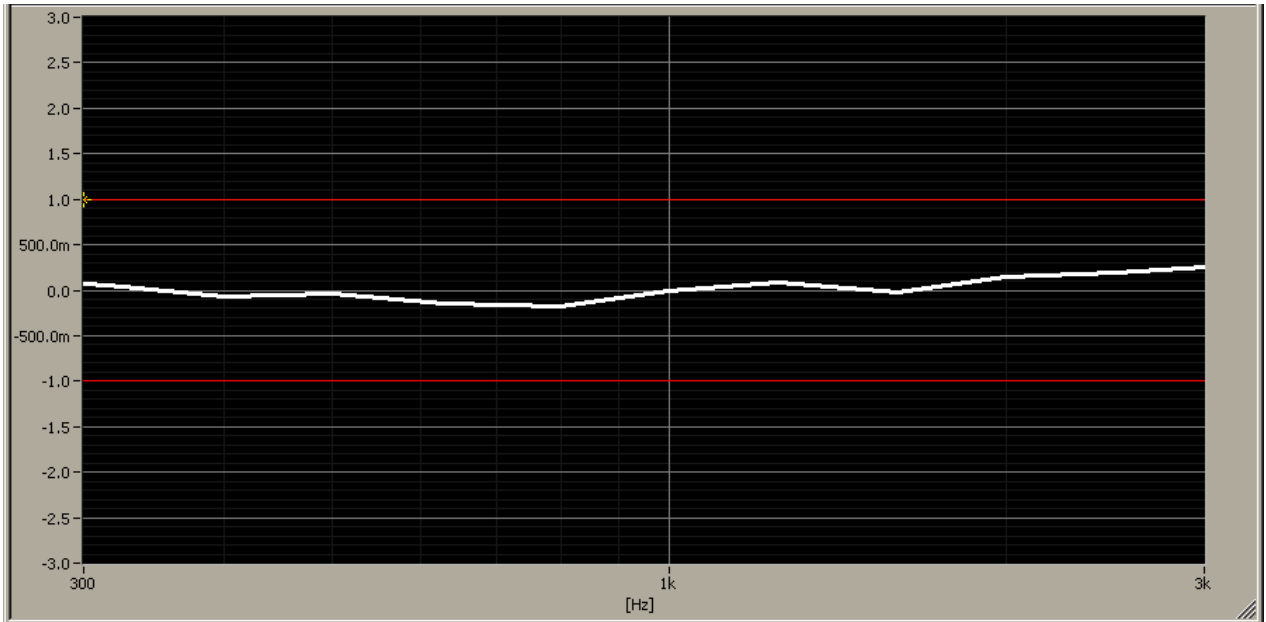

**Figure 6-2**  
**Worst-case ABM2 Plot for WD**

Note: This plot represents the data from the location/configuration resulting in the highest ABM2 result shown in Table 6-3.

FCC ID: A3LSCHR800	 PCTEST ENGINEERING LABORATORY, INC.	HAC (T-COIL) TEST REPORT	 SAMSUNG	Reviewed by: Quality Manager
Filename: 0808221158.A3L	Test Dates: August 25 - 26, 2008	EUT Type: Cellular/PCS CDMA Phone with Bluetooth and EvDO	Page 21 of 35	



## VI. T-Coil Validation Test Results



**Figure 6-3**  
Helmholtz Coil Validation for Frequency Response

**Table 6-4**  
Helmholtz Coil Validation Table of Results

Item	Target	Measured dB About Target	Verdict
<b>Signal Validation</b>			
Frequency Response, from limits	$0 \pm 0.5 \text{ dB}$	0.25	PASS
Magnetic Intensity, 0 dBA/m	$0 \pm 0.5 \text{ dB}$	-0.024	PASS
<b>Noise Validation</b>			
Axial Environmental Noise	< - 58 dBA/m	-58.83	PASS
RadialH Environmental Noise	< - 58 dBA/m	-60.08	PASS
RadialV Environmental Noise	< - 58 dBA/m	-59.70	PASS

FCC ID: A3LSCHR800		HAC (T-COIL) TEST REPORT		Reviewed by: Quality Manager
Filename: 0808221158.A3L	Test Dates: August 25 - 26, 2008	EUT Type: Cellular/PCS CDMA Phone with Bluetooth and EvDO		Page 22 of 35

# 7. FCC 3G MEASUREMENTS

Radio Configuration 1, Service Option 3 (thick, green data curve) was used for the testing as the worst-case configuration for the handset due to vocoder gating from the EVRC logic. See below plot for ABM noise comparison between operational field service options and radio configurations for a CDMA2000 handset:

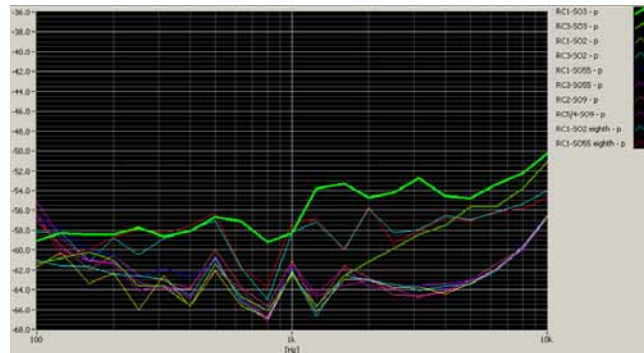

**Figure 7-1**  
**CDMA2000 Audio Band Magnetic Noise**

## I. ABM Measurements

### ABM2 Pre-Test (dBA/m), A, HBI

RC1/SO3	RC3/SO3	RC4/SO3	Orientation	Channel
-33.39	-38.85	-37.89	RadialV	25

### ABM1 Pre-Test (dBA/m)

RC1/SO3	RC3/SO3	RC4/SO3	Orientation	Channel
-12.040	-11.900	-11.760	RadialV	25

- Mute on; Backlight on; Max Volume, Max Contrast
- Power Control Bits = "All Up"



**Figure 7-2**  
**Audio Band Magnetic Curve Measurement Block Diagram**

## II. Handset Capabilities\*:

\*See Device Capabilities attachment for applicable device modes and powers. Voice modes are only applicable for T-coil tests.

FCC ID: A3LSCHR800		HAC (T-COIL) TEST REPORT		Reviewed by: Quality Manager
Filename: 0808221158.A3L	Test Dates: August 25 - 26, 2008	EUT Type: Cellular/PCS CDMA Phone with Bluetooth and EvDO	Page 23 of 35	

## 8. MEASUREMENT UNCERTAINTY



**Table 8-1  
Uncertainty Estimation Table**

Contribution	Data +/- %	Data +/- dB	Data Type	Probability distribution	Divisor	Standard uncertainty	Standard Uncertainty (dB)
ABM Noise	7.0%	0.29	Std. Dev.	Normal k=1	1.00	7.0%	
RF Reflections	4.7%	0.20	Specification	Rectangular	1.73	2.7%	
Reference Signal Level	12.2%	0.50	Specification	Rectangular	1.73	7.0%	
Positioning Accuracy	10.0%	0.41	Uncertainty	Rectangular	1.73	5.8%	
Probe Coil Sensitivity	12.2%	0.50	Specification	Rectangular	1.73	7.0%	
Probe Linearity	2.4%	0.10	Std. Dev.	Normal k=1	1.00	2.4%	
Cable Loss	2.8%	0.12	Specification	Rectangular	1.73	1.6%	
Frequency Analyzer	5.0%	0.21	Specification	Rectangular	1.73	2.9%	
System Repeatability	5.0%	0.21	Std. Dev.	Normal k=1	1.00	5.0%	
WD Repeatability	9.0%	0.37	Std. Dev.	Normal k=1	1.00	9.0%	
Positioner Accuracy	1.0%	0.04	Specification	Rectangular	1.73	0.6%	
<b>Combined standard uncertainty, uc (k=1)</b>						17.7%	0.71
<b>Expanded uncertainty (k=2), 95% confidence level</b>						35.3%	1.31

**Notes:**

1. Test equipments are calibrated according to techniques outlined in NIS81, NIS3003 and NIST Tech Note 1297.
2. All equipments have traceability according to NIST. Measurement Uncertainties are defined in further detail in NIS 81 and NIST Tech Note 1297 and UKAS M3003.



Measurement uncertainty reflects the quality and accuracy of a measured result as compared to the true value. Such statements are generally required when stating results of measurements so that it is clear to the intended audience that the results may differ when reproduced by different facilities. Measurement results vary due to the measurement uncertainty of the instrumentation, measurement technique, and test engineer. Most uncertainties are calculated using the tolerances of the instrumentation used in the measurement, the measurement setup variability, and the technique used in performing the test. While not generally included, the variability of the equipment under test also figures into the overall measurement uncertainty. Another component of the overall uncertainty is based on the variability of repeated measurements (so-called Type A uncertainty). This may mean that the Hearing Aid compatibility tests may have to be repeated by taking down the test setup and resetting it up so that there are a statistically significant number of repeat measurements to identify the measurement uncertainty. By combining the repeat measurement results with that of the instrumentation chain using the technique contained in NIS 81 and NIS 3003, the overall measurement uncertainty was estimated.

<b>FCC ID:</b> A3LSCHR800		<b>HAC (T-COIL) TEST REPORT</b>		<b>Reviewed by:</b> Quality Manager
<b>Filename:</b> 0808221158.A3L	<b>Test Dates:</b> August 25 - 26, 2008	<b>EUT Type:</b> Cellular/PCS CDMA Phone with Bluetooth and EvDO		Page 24 of 35



## 9. EQUIPMENT LIST

**Table 9-1  
Equipment List**

Model	Description	Calibration Date	Cal Interval	Calibration Due	Serial No.
E4407B	ESA Spectrum Analyzer	3/13/08	Annual	3/13/09	US39210313
SoundCheck	Acoustic Analyzer System	3/7/08	Annual	3/7/09	40602697
SoundConnect	Microphone Power Supply	2/27/08	Annual	2/26/09	0899-PS150
CMU200	Base Station Simulator	5/29/08	Annual	5/29/09	836371/0079
CMU200	Base Station Simulator	9/7/07	Annual	9/6/08	833855/0010
CMU200	Base Station Simulator	12/6/07	Annual	12/5/08	107826
CMU200	Base Station Simulator	7/23/08	Annual	7/23/09	109892
NRVS	Single Channel Power Meter	7/3/07	Biennial	7/2/09	835360/0079
NRV-Z53	Power Sensor	7/3/07	Biennial	7/2/09	846076/0007
	HAC System Controller with Software	N/A		N/A	
	HAC Positioner	N/A		N/A	
	T-Coil Probe Set	10/20/06	Biennial	10/20/08	1103/1104

<b>FCC ID:</b> A3LSCHR800		<b>HAC (T-COIL) TEST REPORT</b>		<b>Reviewed by:</b> Quality Manager
<b>Filename:</b> 0808221158.A3L	<b>Test Dates:</b> August 25 - 26, 2008	<b>EUT Type:</b> Cellular/PCS CDMA Phone with Bluetooth and EvDO	Page 25 of 35	

## 10. CALIBRATION CERTIFICATES

<b>FCC ID:</b> A3LSCHR800		<b>HAC (T-COIL) TEST REPORT</b>		<b>Reviewed by:</b> Quality Manager
<b>Filename:</b> 0808221158.A3L	<b>Test Dates:</b> August 25 - 26, 2008	<b>EUT Type:</b> Cellular/PCS CDMA Phone with Bluetooth and EvDO		Page 26 of 35

# I. System Manufacturer Calibration Certificates



An ESCO Technologies Company  
 1301 Arrow Point Drive  
 Cedar Park, Texas 78613  
 (512) 531-6498

**ETS CALIBRATION**  
 Track# J111794 Ltd Cal   
 By SL Date 20-Oct-06  
 Next Cal Due \_\_\_\_\_

Cert I.D.: 58206

## Certificate of Calibration Conformance

Page 1 of 3

The instrument identified below has been individually calibrated in compliance with the following standard(s):

IEEE 1309 - 1996, Institute of Electrical and Electronics Engineers, Standard for Calibration of Electromagnetic Field Sensors and Probes, Excluding Antennas from 9 kHz to 40 GHz

Environment: Laboratory MTE is maintained in a temperature controlled environment with ambient conditions from 18 to 28 C, relative humidity less than 90%. The instrument under test has been calibrated in a suitable environment using an EMCO TEM Cell 5101C, GTEM! 5305 and an RF Shielded EMC Chamber which is conducive to maintaining accurate and reliable measurement quality.

<b>Manufacturer:</b>	TEM Consulting	<b>Operating Range:</b>	100 Hz - 10 kHz
<b>Model Number:</b>	TEM 3002	<b>Instrument Type:</b>	T-Coil Probe Set
<b>Serial Number / ID:</b>	1103/1104		
<b>Tracking Number:</b>	J111794		
<b>Date Completed:</b>	20-Oct-06		
<b>Test Type:</b>	Standard Field, Field Strength		
<b>Calibration Uncertainty:</b>	Std Field Method	*unknown*	
(95% Confidence Level)			

**Test Remarks:**

Calibration Traceability: All Measuring and Test Equipment (MTE) identified below are traceable to the National Institute for Standards and Technology (NIST). Calibration Laboratory and Quality System controls are compliant with ISO/IEC 17025-1999.

Standards and Equipment Used:				Condition of Instrument On Release:	
Make / Model / Name / S/N / Recall Date					
Hewlett Packard 8116A	Pulse/function Generator	2516A01852	31-Jan-07	In Tolerance to Internal Quality Standards	
Hewlett Packard 3478A	Digital Multimeter	2301A18249	14-Jun-07		

Calibration Completed By  
 Slav Ligai, Calibration Technician

Attested and Issued on 20-Oct-06  
 Ronald W. Bethel, Calibration Lab Supervisor

This document provides traceability of measurements to recognized national standards using controlled processes at the ETS-Lindgren Calibration Laboratory. Uncertainties listed are derived from the methods described by NIST Tech Note 1297. This certificate and report may not be reproduced, except in full, without the written approval of ETS-Lindgren Calibration Laboratory in accordance with ISO/IEC 17025-1999. QAF 1107 (07/03)

FCC ID: A3LSCHR800	PCTEST ENGINEERING LABORATORY, INC.	HAC (T-COIL) TEST REPORT		Reviewed by: Quality Manager
Filename: 0808221158.A3L	Test Dates: August 25 - 26, 2008	EUT Type: Cellular/PCS CDMA Phone with Bluetooth and EvDO		Page 27 of 35

S/N TEM 1103  
Date 20-Oct-06

Probe Axial

Sensor Factor 0.4  
Factor to convert dB mV to dB A/m

Dynamic Range

Heimholtz Coil Constant for Formula				24.08			Probe Output	
Freq	Field Strength		Coil Input	Meter Output	Sensor Factor	Sensor Linearity		
Hz	dB (A/m)	A/m	mV Across 10 Ohm resistor	mV	dB dB mV → dB A/m	Delta to Calculated in dB		
1000	28	25.119	1043.34	26.31	0.4	0.0		
1000	23	14.125	586.72	14.83	0.4	0.0		
1000	18	7.943	329.93	8.33	0.4	0.0		

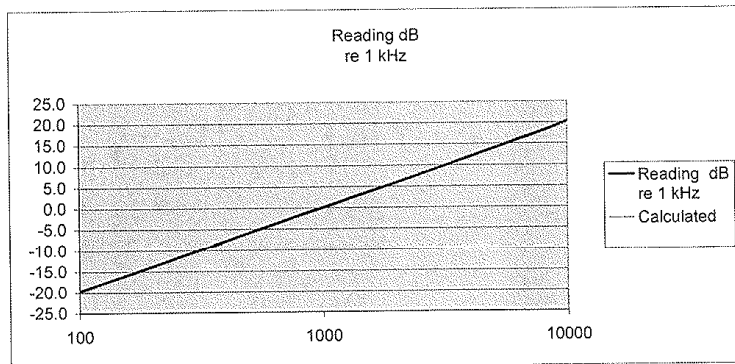

Frequency Response - Voltage into a HP 3478A Multimeter									
Freq	Sig Gen	mV	H	H	Raw Reading	Reading dB mV	Reading	Delta	
Hz	V	Across 10.1 Ohm resistor into Coil	A/m	dB (A/m)	mV	dB	dB re 1 kHz	to	Calculated
100	8.0	932.00	22.43	27.02	2.40	7.60	-19.8	0.2	
125	8.0	931.90	22.43	27.02	2.98	9.47	-17.9	0.2	
160	8.0	931.80	22.43	27.02	3.80	11.58	-15.8	0.1	
200	8.0	931.72	22.43	27.02	4.74	13.51	-13.9	0.1	
250	8.0	931.64	22.42	27.01	5.93	15.44	-11.9	0.1	
315	8.0	931.52	22.42	27.01	7.48	17.46	-9.9	0.1	
400	8.0	931.32	22.42	27.01	9.48	19.52	-7.8	0.1	
500	8.0	931.01	22.41	27.01	11.84	21.46	-5.9	0.1	
630	8.0	930.55	22.40	27.00	14.91	23.47	-3.9	0.1	
800	8.0	929.91	22.38	27.00	18.90	25.53	-1.8	0.1	
1000	8.0	930.31	22.39	27.00	23.37	27.37	0.0	0.0	
1250	8.0	929.83	22.38	27.00	29.11	29.28	1.9	0.0	
1600	8.0	929.31	22.37	26.99	37.09	31.39	4.0	-0.1	
2000	8.0	928.92	22.36	26.99	46.27	33.32	5.9	-0.1	
2500	8.0	928.62	22.35	26.99	57.74	35.25	7.9	-0.1	
3150	8.0	928.21	22.34	26.98	72.75	37.26	9.9	-0.1	
4000	8.0	927.32	22.32	26.97	92.20	39.32	12.0	-0.1	
5000	8.0	925.54	22.28	26.96	115.19	41.27	13.9	-0.1	
6300	8.0	922.06	22.19	26.92	145.31	43.32	16.0	0.0	
8000	8.0	915.93	22.05	26.87	184.79	45.47	18.1	0.0	
10000	8.0	907.67	21.85	26.79	235.11	47.64	20.3	0.3	

FCC ID: A3LSCHR800	PCTEST ENGINEERING LABORATORY, INC.	HAC (T-COIL) TEST REPORT		Reviewed by: Quality Manager
Filename: 0808221158.A3L	Test Dates: August 25 - 26, 2008	EUT Type: Cellular/PCS CDMA Phone with Bluetooth and EvDO		Page 28 of 35

S/N TEM1104  
Date 20-Oct-06

Probe Radial

Sensor Factor 0.4  
Factor to convert dB mV to dB A/m

Dynamic Range

Helmholtz Coil Constant for Formula 24.08

Freq	Field Strength		Coil Input mV Across 10 Ohm resistor	Probe Output		
	dB (A/m)	A/m		Meter Output mV	Sensor Factor dB mV → dB A/m	Sensor Linearity Delta to Calculated in dB
1000	28	25.119	1043.34	26.29	0.4	0.0
1000	23	14.125	586.72	14.81	0.4	0.0
1000	18	7.943	329.93	8.32	0.4	0.0

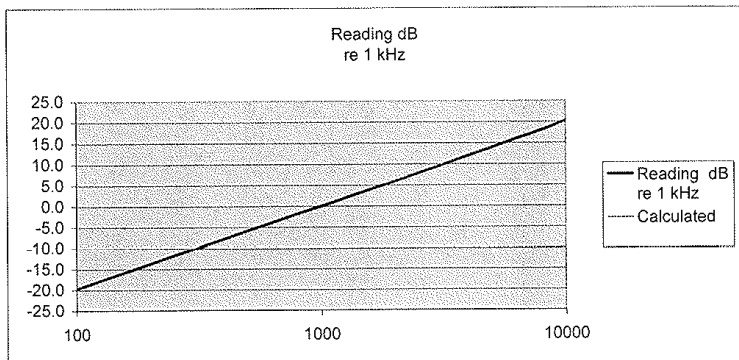



Frequency Response - Voltage into a HP 3478A Multimeter									
Freq	Sig Gen	mV	H	H	Raw Reading	Reading dB mV	Reading	Delta	
Hz	V	Across 10.1 Ohm resistor into Coil	A/m	dB (A/m)	mV	dB	dB re 1 kHz	to	Calculated
100	8.0	932.00	22.43	27.02	2.36	7.46	-19.8	0.2	
125	8.0	931.90	22.43	27.02	2.93	9.32	-17.9	0.2	
160	8.0	931.80	22.43	27.02	3.74	11.44	-15.8	0.1	
200	8.0	931.72	22.43	27.02	4.67	13.37	-13.9	0.1	
250	8.0	931.64	22.42	27.01	5.83	15.31	-11.9	0.1	
315	8.0	931.52	22.42	27.01	7.35	17.32	-9.9	0.1	
400	8.0	931.32	22.42	27.01	9.33	19.38	-7.8	0.1	
500	8.0	931.01	22.41	27.01	11.65	21.32	-5.9	0.1	
630	8.0	930.55	22.40	27.00	14.67	23.33	-3.9	0.1	
800	8.0	929.91	22.38	27.00	18.60	25.39	-1.8	0.1	
1000	8.0	930.31	22.39	27.00	23.00	27.23	0.0	0.0	
1250	8.0	929.83	22.38	27.00	28.64	29.14	1.9	0.0	
1600	8.0	929.31	22.37	26.99	36.49	31.25	4.0	-0.1	
2000	8.0	928.92	22.36	26.99	45.51	33.18	5.9	-0.1	
2500	8.0	928.62	22.35	26.99	56.80	35.10	7.9	-0.1	
3150	8.0	928.21	22.34	26.98	71.55	37.11	9.9	-0.1	
4000	8.0	927.32	22.32	26.97	90.66	39.18	11.9	-0.1	
5000	8.0	925.54	22.28	26.96	113.23	41.12	13.9	-0.1	
6300	8.0	922.06	22.19	26.92	142.80	43.17	15.9	0.0	
8000	8.0	915.93	22.05	26.87	181.49	45.31	18.1	0.0	
10000	8.0	907.67	21.85	26.79	230.74	47.48	20.2	0.2	

FCC ID: A3LSCHR800		HAC (T-COIL) TEST REPORT		Reviewed by: Quality Manager
Filename: 0808221158.A3L	Test Dates: August 25 - 26, 2008	EUT Type: Cellular/PCS CDMA Phone with Bluetooth and EvDO		Page 29 of 35

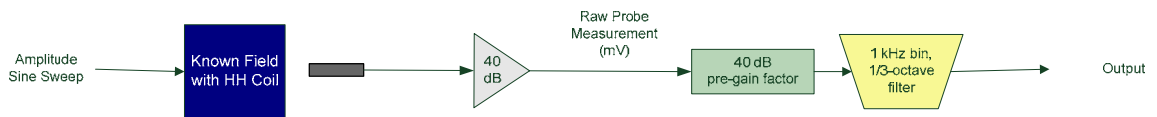
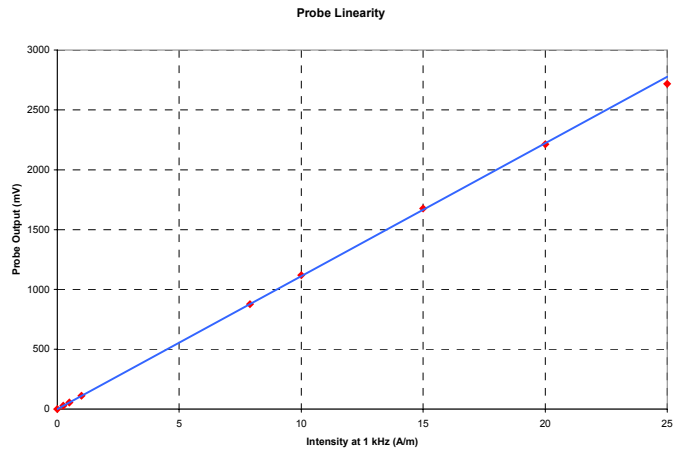
## II. Linearity Check with probe system:





FCC ID: A3LSCHR800	 <b>PCTEST</b> <small>ENGINEERING LABORATORY, INC.</small>	<b>HAC (T-COIL) TEST REPORT</b>	 <b>Reviewed by:</b> Quality Manager
<b>Filename:</b> 0808221158.A3L	<b>Test Dates:</b> August 25 - 26, 2008	<b>EUT Type:</b> Cellular/PCS CDMA Phone with Bluetooth and EvDO	Page 30 of 35

## 11. CONCLUSION



The measurements indicate that the wireless communications device complies with the HAC limits specified in accordance with the ANSI C63.19 Standard and FCC WT Docket No. 01-309 RM-8658. Precise laboratory measures were taken to assure repeatability of the tests. The tested device complies with the requirements in respect to all parameters specific to the test. The test results and statements relate only to the item(s) tested.

The measurement system and techniques presented in this evaluation are proposed in the ANSI standard as a means of best approximating wireless device compatibility with a hearing-aid. The literature is under continual re-construction.



<b>FCC ID:</b> A3LSCHR800		<b>HAC (T-COIL) TEST REPORT</b>		<b>Reviewed by:</b> Quality Manager
<b>Filename:</b> 0808221158.A3L	<b>Test Dates:</b> August 25 - 26, 2008	<b>EUT Type:</b> Cellular/PCS CDMA Phone with Bluetooth and EvDO		Page 31 of 35

## 12. REFERENCES

1. ANSI C63.19-2007, American National Standard for Methods of Measurement of Compatibility between Wireless communication devices and Hearing Aids.", New York, NY, IEEE, June 2007
2. FCC Public Notice DA 06-1215, *Wireless Telecommunications Bureau and Office of Engineering and Technology Clarify Use of Revised Wireless Phone Hearing Aid Compatibility Standard*, June 6, 2006
3. FCC 3G Review Guidance, Laboratory Division OET FCC, May/June 2006
4. Berger, H. S., "Compatibility Between Hearing Aids and Wireless Devices," Electronic Industries Forum, Boston, MA, May, 1997
5. Berger, H. S., "Hearing Aid and Cellular Phone Compatibility: Working Toward Solutions," *Wireless Telephones and Hearing Aids: New Challenges for Audiology*, Gallaudet University, Washington, D.C., May, 1997 (To be reprinted in the American Journal of Audiology).
6. Berger, H. S., "Hearing Aid Compatibility with Wireless Communications Devices," IEEE International Symposium on Electromagnetic Compatibility, Austin, TX, August, 1997.
7. Bronaugh, E. L., "Simplifying EMI Immunity (Susceptibility) Tests in TEM Cells," in the 1990 IEEE International Symposium on Electromagnetic Compatibility Symposium Record, Washington, D.C., August 1990, pp. 488-491
8. Byrne, D. and Dillon, H., The National Acoustics Laboratory (NAL) New Procedure for Selecting the Gain and Frequency Response of a Hearing Aid, *Ear and Hearing* 7:257-265, 1986.
9. Crawford, M. L., "Measurement of Electromagnetic Radiation from Electronic Equipment using TEM Transmission Cells," U.S. Department of Commerce, National Bureau of Standards, NBSIR 73-306, Feb. 1973.
10. Crawford, M. L., and Workman, J. L., "Using a TEM Cell for EMC Measurements of Electronic Equipment," U.S. Department of Commerce, National Bureau of Standards. Technical Note 1013, July 1981.
11. EHIMA GSM Project, Development phase, Project Report (1<sup>st</sup> part) Revision A. Technical-Audiological Laboratory and Telecom Denmark, October 1993.
12. EHIMA GSM Project, Development phase, Part II Project Report. Technical-Audiological Laboratory and Telecom Denmark, June 1994.
13. EHIMA GSM Project Final Report, Hearing Aids and GSM Mobile Telephones: Interference Problems, Methods of Measurement and Levels of Immunity. Technical-Audiological Laboratory and Telecom Denmark, 1995.
14. HAMPIS Report, Comparison of Mobile phone electromagnetic near field with an upscaled electromagnetic far field, using hearing aid as reference, 21 October 1999.
15. Hearing Aids/GSM, Report from OTWIDAM, Technical-Audiological Laboratory and Telecom Denmark, April 1993.

<b>FCC ID:</b> A3LSCHR800		<b>HAC (T-COIL) TEST REPORT</b>		<b>Reviewed by:</b> Quality Manager
<b>Filename:</b> 0808221158.A3L	<b>Test Dates:</b> August 25 - 26, 2008	<b>EUT Type:</b> Cellular/PCS CDMA Phone with Bluetooth and EvDO	Page 32 of 35	

16. IEEE 100, The Authoritative Dictionary of IEEE Standards Terms, Seventh Edition.
17. Joyner, K. H., et. al., Interference to Hearing Aids by the New Digital Mobile Telephone System, Global System for Mobile (GSM) Communication Standard, National Acoustic Laboratory, Australian Hearing Series, Sydney 1993.
18. Joyner, K. H., et. al., Interference to Hearing Aids by the Digital Mobile Telephone System, Global System for Mobile Communications (GSM), NAL Report #131, National Acoustic Laboratory, Australian Hearing Series, Sydney, 1995.
19. Kecker, W. T., Crawford, M. L., and Wilson, W. A., "Construction of a Transverse Electromagnetic Cell", U.S. Department of Commerce, National Bureau of Standards, Technical Note 1011, Nov. 1978.
20. Konigstein, D., and Hansen, D., "A New Family of TEM Cells with enlarged bandwidth and Optimized working Volume," in the Proceedings of the 7<sup>th</sup> International Symposium on EMC, Zurich, Switzerland, March 1987; 50:9, pp. 127-132.
21. Kuk, F., and Hjorstgaard, N. K., "Factors affecting interference from digital cellular telephones," Hearing Journal, 1997; 50:9, pp 32-34.
22. Ma, M. A., and Kanda, M., "Electromagnetic Compatibility and Interference Metrology," U.S. Department of Commerce, National Bureau of Standards, Technical Note 1099, July 1986, pp. 17-43.
23. Ma, M. A., Sreenivashiah, I. , and Chang, D. C., "A Method of Determining the Emission and Susceptibility Levels of Electrically Small Objects Using a TEM Cell," U.S. Department of Commerce, National Bureau of Standards, Technical Note 1040, July 1981.
24. McCandless, G. A., and Lyregaard, P. E., Prescription of Gain/Output (POGO) for Hearing Aids, Hearing Instruments 1:16-21, 1983
25. Skopec, M., "Hearing Aid Electromagnetic Interference from Digital Wireless Telephones, "IEEE Transactions on Rehabilitation Engineering, vol. 6, no. 2, pp. 235-239, June 1998.
26. Technical Report, GSM 05.90, GSM EMC Considerations, European Telecommunications Standards Institute, January 1993.
27. Victorian, T. A., "Digital Cellular Telephone Interference and Hearing Aid Compatibility—an Update," Hearing Journal 1998; 51:10, pp. 53-60
28. Wong, G. S. K., and Embleton, T. F. W., eds., AIP Handbook of Condenser Microphones: Theory, Calibration and Measurements, AIP Press.

<b>FCC ID:</b> A3LSCHR800		<b>HAC (T-COIL) TEST REPORT</b>		<b>Reviewed by:</b> Quality Manager
<b>Filename:</b> 0808221158.A3L	<b>Test Dates:</b> August 25 - 26, 2008	<b>EUT Type:</b> Cellular/PCS CDMA Phone with Bluetooth and EvDO	Page 33 of 35	