

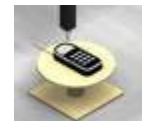

PCTEST ENGINEERING LABORATORY, INC.

6660-B Dobbin Road, Columbia, MD 21045 USA
Tel. 410.290.6652 / Fax 410.290.6554
<http://www.pctestlab.com>



HEARING AID COMPATIBILITY CERTIFICATE

Applicant Name:
Samsung Electronics, Co. Ltd.
18600 Broadwick St.
Rancho Dominguez, CA 90220
United States

Date of Testing:
July 29 - August 5, 2008
Test Site/Location:
PCTEST Lab, Columbia, MD, USA
Test Report Serial No.:
0808061096.A3L

FCC ID: A3LSCHR550

APPLICANT: SAMSUNG ELECTRONICS, CO. LTD.

Application Type: Class II Permissive Change
FCC Rule Part(s): § 20.19(b), §6.3(v), §7.3(v)
HAC Standard: ANSI C63.19-2007;
FCC Classification: Licensed Transmitter Held to Ear (PCE)
EUT Type: Cellular/PCS/AWS CDMA Phone with Bluetooth and EVDO
Model(s): SCH-R550
Tx Frequency: 824.70 - 848.31 MHz (Cellular CDMA)
1711.25 - 1753.75 MHz (AWS CDMA)
1851.25 - 1908.75 MHz (PCS CDMA)
Test Device Serial No.: Pre-Production Sample [S/N: HAC #16]
Class II Permissive Change(s): See FCC Change Document

C63.19-2007 HAC Category: M4 (RF EMISSIONS CATEGORY)

This wireless portable device has been shown to be hearing-aid compatible under the above rated category, specified in ANSI/IEEE Std. C63.19-2007 and had been tested in accordance with the specified measurement procedures. Hearing-Aid Compatibility is based on the assumption that all production units will be designed electrically identical to the device tested in this report.

I attest to the accuracy of data. All measurements reported herein were performed by me or were made under my supervision and are correct to the best of my knowledge and belief. I assume full responsibility for the completeness of these measurements and vouch for the qualifications of all persons taking them.

PCTEST certifies that no party to this application has been denied the FCC benefits pursuant to Section 5301 of the Anti-Drug Abuse Act of 1988, 21 U.S.C. 862.

Randy Ortanez
President







FCC ID: A3LSCHR550		HAC (RF EMISSIONS) TEST REPORT		Reviewed by: Quality Manager
HAC Filename: 0808061096.A3L	Test Dates: July 29 - August 5, 2008	EUT Type: Cellular/PCS/AWS CDMA Phone with Bluetooth and EVDO		Page 1 of 77

TABLE OF CONTENTS

1.	INTRODUCTION	3
2.	TEST SITE LOCATION	4
3.	EUT DESCRIPTION	5
4.	ANSI/IEEE C63.19 PERFORMANCE CATEGORIES	6
5.	SYSTEM SPECIFICATIONS	7
6.	TEST PROCEDURE	13
7.	SYSTEM CHECK	15
8.	MODULATION FACTOR	18
9.	FCC 3G MEASUREMENTS	20
10.	OVERALL MEASUREMENT SUMMARY	21
11.	EQUIPMENT LIST	24
12.	MEASUREMENT UNCERTAINTY	25
13.	TEST DATA	26
14.	CALIBRATION CERTIFICATES	39
15.	CONCLUSION	72
16.	REFERENCES	73
17.	TEST PHOTOGRAPHS	75

FCC ID: A3LSCHR550		HAC (RF EMISSIONS) TEST REPORT		Reviewed by: Quality Manager
HAC Filename: 0808061096.A3L	Test Dates: July 29 - August 5, 2008	EUT Type: Cellular/PCS/AWS CDMA Phone with Bluetooth and EVDO		Page 2 of 77

1. INTRODUCTION

On July 10, 2003, the Federal Communications Commission (FCC) adopted new rules requiring wireless manufacturers and service providers to provide digital wireless phones that are compatible with hearing aids. The FCC has modified the exemption for wireless phones under the Hearing Aid Compatibility Act of 1998 (HAC Act) in WT Docket 01-309 RM-8658¹ to extend the benefits of wireless telecommunications to individuals with hearing disabilities. These benefits encompass business, social and emergency communications, which increase the value of the wireless network for everyone. An estimated more than 10% of the population in the United States show signs of hearing impairment and of that fraction, almost 80% use hearing aids. Approximately 500 million people worldwide suffer from hearing loss.

Compatibility Tests Involved:

The standard calls for wireless communications devices to be measured for:

- RF Electric-field emissions
- RF Magnetic-field emissions
- T-coil mode, magnetic-signal strength in the audio band
- T-coil mode, magnetic-signal frequency response through the audio band
- T-coil mode, magnetic-signal and noise articulation index

The hearing aid must be measured for:



- RF immunity in microphone mode
- RF immunity in T-coil mode

In the following tests and results, this report includes the evaluation for a wireless communications device.



Figure 1-1 Hearing Aid *in-vitu*

¹ FCC Rule & Order, WT Docket 01-309 RM-8658

FCC ID: A3LSCHR550		HAC (RF EMISSIONS) TEST REPORT		Reviewed by: Quality Manager
HAC Filename: 0808061096.A3L	Test Dates: July 29 - August 5, 2008	EUT Type: Cellular/PCS/AWS CDMA Phone with Bluetooth and EVDO	Page 3 of 77	

2. TEST SITE LOCATION

2.1 INTRODUCTION

The map at the right shows the location of the PCTEST LABORATORY in Columbia, Maryland. It is in proximity to the FCC Laboratory, the Baltimore-Washington International (BWI) airport, the city of Baltimore and Washington, DC (See Figure 2).

These measurement tests were conducted at the PCTEST Engineering Laboratory, Inc. facility in New Concept Business Park, Guilford Industrial Park, Columbia, Maryland. The site address is 6660-B Dobbin Road, Columbia, MD 21045. The test site is one of the highest points in the Columbia area with an elevation of 390 feet above mean sea level. The site coordinates are 39° 11'15" N latitude and 76° 49' 38" W longitude. The facility is 1.5 miles North of the FCC laboratory, and the ambient signal and ambient signal strength are approximately equal to those of the FCC laboratory. There are no FM or TV transmitters within 15 miles of the site. The detailed description of the measurement facility was found to be in compliance with the requirements of § 2.948 according to ANSI C63.4 on January 27, 2006 and Industry Canada.



Figure 2-1
Map of the Greater Baltimore and Metropolitan Washington D.C. area

2.2 Test Facility / Accreditations:

Measurements were performed at an independent accredited PCTEST Engineering Lab located in Columbia, MD 21045, U.S.A.



- PCTEST Lab is accredited to ISO 17025-2005 by the American Association for Laboratory Accreditation (A2LA) in Specific Absorption Rate (SAR) testing, Hearing-Aid Compatibility (HAC), CTIA Test Plans, and wireless testing for FCC and Industry Canada Rules.
- PCTEST Lab is accredited to ISO 17025 by U.S. National Institute of Standards and Technology (NIST) under the National Voluntary Laboratory Accreditation Program (NVLAP Lab code: 100431-0) in EMC, FCC and Telecommunications.
- PCTEST facility is an FCC registered (PCTEST Reg. No. 90864) test facility with the site description report on file and has met all the requirements specified in Section 2.948 of the FCC Rules and Industry Canada (IC-2451).
- PCTEST Lab is a recognized U.S. Conformity Assessment Body (CAB) in EMC and R&TTE (n.b. 0982) under the U.S.-EU Mutual Recognition Agreement (MRA).
- PCTEST TCB is a Telecommunication Certification Body (TCB) accredited to ISO/IEC Guide 65 by the American National Standards Institute (ANSI) in all scopes of FCC Rules and all Industry Canada Standards (RSS).
- PCTEST facility is an IC registered (IC-2451) test laboratory with the site description on file at Industry Canada.
- PCTEST is a CTIA Authorized Test Laboratory (CATL) for AMPS and CDMA, and EvDO mobile phones.
- PCTEST is a CTIA Authorized Test Laboratory (CATL) for Over-the-Air (OTA) Antenna Performance testing for AMPS, CDMA, GSM, GPRS, EGPRS, UMTS (W-CDMA), CDMA 1xEVDO Data, CDMA 1xRTT Data.

FCC ID: A3LSCHR550		HAC (RF EMISSIONS) TEST REPORT	Reviewed by: Quality Manager
HAC Filename: 0808061096.A3L	Test Dates: July 29 - August 5, 2008	EUT Type: Cellular/PCS/AWS CDMA Phone with Bluetooth and EVDO	Page 4 of 77

3. EUT DESCRIPTION



FCC ID: A3LSCHR550
Manufacturer: Samsung Electronics, Co. Ltd.
 18600 Broadwick St.
 Rancho Dominguez, CA 90220
 United States
Trade Name: Samsung
Model(s): SCH-R550
Serial Number: HAC #16
Tx Frequencies: 824.70 - 848.31 MHz (Cellular CDMA)
 1711.25 - 1753.75 MHz (AWS CDMA)
 1851.25 - 1908.75 MHz (PCS CDMA)
Antenna Configurations: Internal Antenna
Maximum Conducted Power (EMC/SAR): 25 dBm (CDMA), 25 dBm (AWS), 25 dBm (PCS)
Maximum Conducted Power (HAC): 25 dBm (CDMA), 25 dBm (AWS), 25 dBm (PCS)
HAC Test Configurations: CDMA, 1013, 384, 777, BT Off
 PCS, 25, 600, 1175, BT Off
 AWS, 25, 450, 875, BT Off
FCC Classification: Licensed Transmitter Held to Ear (PCE)
EUT Type: Cellular/PCS/AWS CDMA Phone with Bluetooth and EVDO

See Key Features list for more detailed information.

FCC ID: A3LSCHR550	PCTEST ENGINEERING LABORATORY, INC.	HAC (RF EMISSIONS) TEST REPORT		Reviewed by: Quality Manager
HAC Filename: 0808061096.A3L	Test Dates: July 29 - August 5, 2008	EUT Type: Cellular/PCS/AWS CDMA Phone with Bluetooth and EVDO	Page 5 of 77	

4. ANSI/IEEE C63.19 PERFORMANCE CATEGORIES



I. RF EMISSIONS

The ANSI Standard presents performance requirements for acceptable interoperability of hearing aids with wireless communications devices. When these parameters are met, a hearing aid operates acceptably in close proximity to a wireless communications device.

Category	Telephone RF Parameters	
Near field Category	E-field emissions CW dB(V/m)	H-field emissions CW dB(A/m)
f < 960 MHz		
M1	56 to 61 + 0.5 x AWF	5.6 to 10.6 +0.5 x AWF
M2	51 to 56 + 0.5 x AWF	0.6 to 5.6 +0.5 x AWF
M3	46 to 51 + 0.5 x AWF	-4.4 to 0.6 +0.5 x AWF
M4	< 46 + 0.5 x AWF	< -4.4 + 0.5 x AWF
f > 960 MHz		
M1	46 to 51 + 0.5 x AWF	-4.4 to 0.6 +0.5 x AWF
M2	41 to 46 + 0.5 x AWF	-9.4 to -4.4 +0.5 x AWF
M3	36 to 41 + 0.5 x AWF	-14.4 to -9.4 +0.5 x AWF
M4	< 36 + 0.5 x AWF	< -14.4 + 0.5 x AWF
Table 4-1 Hearing aid and WD near-field categories as defined in ANSI C63.19-2007		

II. ARTICULATION WEIGHTING FACTOR (AWF)

Standard	Technology	Articulation Weighing Factor (AWF)
T1/T1P1/3GPP	UMTS (WCDMA)	0
TIA/EIA/IS-2000	CDMA	0
iDEN ^T	TDMA (22 and 11 Hz)	0
J-STD-007	GSM (217 Hz)	-5
Table 4-2 Articulation Weighing Factors		

FCC ID: A3LSCHR550	 PCTEST ENGINEERING LABORATORY, INC.	HAC (RF EMISSIONS) TEST REPORT	 Reviewed by: Quality Manager
HAC Filename: 0808061096.A3L	Test Dates: July 29 - August 5, 2008	EUT Type: Cellular/PCS/AWS CDMA Phone with Bluetooth and EVDO	Page 6 of 77

5. SYSTEM SPECIFICATIONS

ER3DV6 E-Field Probe Description

Construction:	One dipole parallel, two dipoles normal to probe axis Built-in shielding against static charges
Calibration:	In air from 100 MHz to 3.0 GHz (absolute accuracy $\pm 6.0\%$, $k=2$)
Frequency:	100 MHz to > 6 GHz; Linearity: ± 0.2 dB (100 MHz to 3 GHz)
Directivity	± 0.2 dB in air (rotation around probe axis) ± 0.4 dB in air (rotation normal to probe axis)
Dynamic Range	2 V/m to > 1000 V/m (M3 or better device readings fall well below diode compression point)
Linearity:	± 0.2 dB
Dimensions	Overall length: 330 mm (Tip: 16 mm) Tip diameter: 8 mm (Body: 12 mm) Distance from probe tip to dipole centers: 2.5 mm



Figure 5-1
E-field Free-space Probe

H3DV6 H-Field Probe Description

Construction:	Three concentric loop sensors with 3.8 mm loop diameters Resistively loaded detector diodes for linear response Built-in shielding against static charges
Frequency:	200 MHz to 3 GHz (absolute accuracy $\pm 6.0\%$, $k=2$); Output linearized
Directivity:	± 0.25 dB (spherical isotropy error)
Dynamic Range:	10 mA/m to 2 A/m at 1 GHz (M3 or better device readings fall well below diode compression point)
Dimensions:	Overall length: 330 mm (Tip: 40 mm) Tip diameter: 6 mm (Body: 12 mm) Distance from probe tip to dipole centers: 3 mm
E-Field Interference:	< 10% at 3 GHz (for plane wave)





Figure 5-2
H-Field Free-space Probe

Probe Tip Description

HAC field measurements take place in the close near field with high gradients. Increasing the measuring distance from the source will generally decrease the measured field values (in case of the validation dipole approx. 10% per mm).

Magnetic field sensors are measuring the integral of the H-field across their sensor area surrounded by the loop. They are calibrated in a precise, homogeneous field. When measuring a gradient field, the result will be very close to the field in the center of the loop which is equivalent to the value of a homogeneous field equivalent to the center value. But it will be different from the field at the border of the loop.

FCC ID: A3LSCHR550	 PCTEST ENGINEERING LABORATORY, INC.	HAC (RF EMISSIONS) TEST REPORT		Reviewed by: Quality Manager
HAC Filename: 0808061096.A3L	Test Dates: July 29 - August 5, 2008	EUT Type: Cellular/PCS/AWS CDMA Phone with Bluetooth and EVDO	Page 7 of 77	

Consequently, two sensors with different loop diameters - both calibrated ideally - would give different results when measuring from the edge of the probe sensor elements. The behavior for electrically small E-field sensors is equivalent.

The magnetic field loops of the H3D probes are concentric, with the center 3mm from the tip for H3DV6. Their radius is 1.9mm.

The electric field probes have a more irregular internal geometry because it is physically not possible to have the 3 orthogonal sensors situated with the same center. The effect of the different sensor centers is accounted for in the HAC uncertainty budget ("sensor displacement"). Their geometric center is at 2.5mm from the tip, and the element ends are 1.1mm closer to the tip.



The antistatic shielding inside the probe is connected to the probe connector case.

Instrumentation Chain

Equation 1

Conversion of Connector Voltage u_i to E-Field E_i

$$E_i = \sqrt{\frac{u_i + (u_i^2 \cdot CF) / (DCP)}{Norm_i \cdot ConvF}}$$

whereby

- E_i : electric field in V/m
- u_i : voltage of channel i at the connector in μV
- $Norm_i$: sensitivity of channel i in $\mu V / (V/m)^2$
- $ConvF$: enhancement factor in liquid (ConvF=1 for Air)
- DCP : diode compression point in μV
- CF : signal crest factor (peak power/average power)

Conditions of Calibration

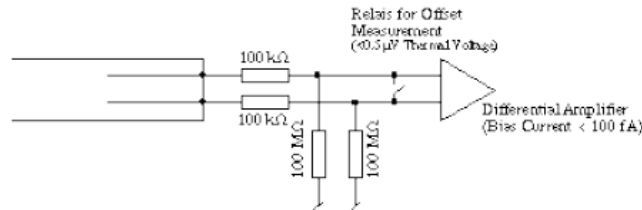

- Please note:
- a lower input impedance of the amplifier will result in different sensitivity factors $Norm_i$ and DCP
 - larger bias currents will cause higher offset

FCC ID: A3LSCHR550	PCTEST ENGINEERING LABORATORY, INC.	HAC (RF EMISSIONS) TEST REPORT	SAMSUNG	Reviewed by: Quality Manager
HAC Filename: 0808061096.A3L	Test Dates: July 29 - August 5, 2008	EUT Type: Cellular/PCS/AWS CDMA Phone with Bluetooth and EVDO		Page 8 of 77

Probe Response to Frequency

The E-field sensors have inherently a very flat frequency response. They are calibrated with a number of frequencies resulting in a common calibration factor, with the frequency behavior documented in the calibration certificate (See also below).

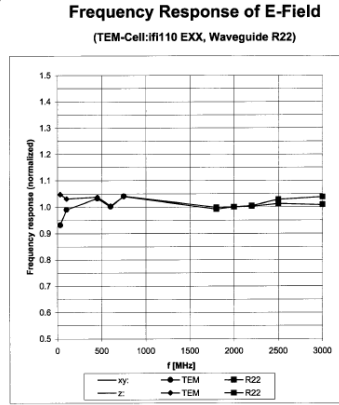

Uncertainty of Frequency Response of E-field: $\pm 6.3\%$ ($k=2$)

Figure 5-3 E-Field Probe Frequency Response

H-field sensors have a frequency dependent sensitivity which is evaluated for a series of frequencies also visible in the probe calibration certificate. The calibration factors result from a fitting algorithm. The proper conversion is calculated by the DASY4 software depending on the frequency setting in the procedure. See below for H-field frequency response:

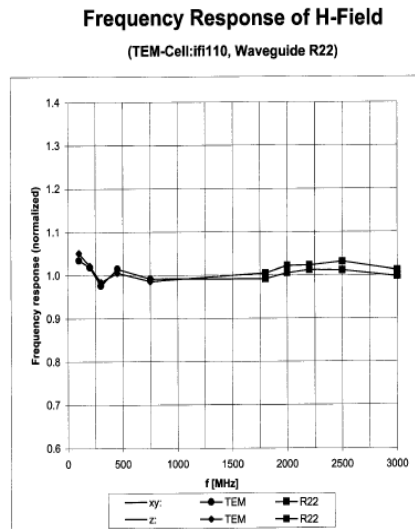

Uncertainty of Frequency Response of E-field: $\pm 6.3\%$ ($k=2$)

Figure 5-4 H-Field Probe Frequency Response

FCC ID: A3LSCHR550	PCTEST ENGINEERING LABORATORY, INC.	HAC (RF EMISSIONS) TEST REPORT	SAMSUNG	Reviewed by: Quality Manager
HAC Filename: 0808061096.A3L	Test Dates: July 29 - August 5, 2008	EUT Type: Cellular/PCS/AWS CDMA Phone with Bluetooth and EVDO		Page 9 of 77

Conversion to Peak

Peak is defined as Peak Envelope Power. All raw measurements from the HAC measurement system are RMS values. The DASY4 system incorporates the crest factor of the signal in the computation of the RMS values (See Equation 1). Although the software also has capability to estimate the peak field by applying a square root of crest factor value to the readings, the probe modulation factor was applied manually instead per C63.19 in the measurement tables in this report. The equation to convert the raw measurements in the data tables are:

$$\text{Peak Field} = 20 \cdot \log (\text{Raw} \cdot \text{PMF})$$

Where:

Peak Field = Peak field (in dBV/m or dBA/m)

Raw = Raw field measurement from the measurement system (in V/m or A/m).

PMF = Probe Modulation Factor (in linear units).

SPEAG Robotic System



E-field and H-field measurements are performed using the DASY4 automated dosimetric assessment system. The DASY4 is made by Schmid & Partner Engineering AG (SPEAG) in Zurich, Switzerland and consists of high precision robotics system (Staubli), robot controller, Pentium 4 computer, near-field probe, probe alignment sensor, and the HAC phantom. The robot is a six-axis industrial robot performing precise movements to position the probe to the location (points) of maximum electromagnetic field (EMF).



Figure 5-5
SPEAG Robotic System

System Hardware

A cell controller system contains the power supply, robot controller, teach pendant (Joystick), and a remote control used to drive the robot motors. The PC consists of the Gateway Pentium 4 2.53 GHz computer with Windows XP system and RF Measurement Software DASY4 v4.5 (with HAC Extension), A/D interface card, monitor, mouse, and keyboard. The Staubli Robot is connected to the cell controller to allow software manipulation of the robot. A data acquisition electronic (DAE) circuit that performs the signal amplification, signal multiplexing, AD-conversion, offset measurements, mechanical surface detection, collision detection, etc. is connected to the Electro-optical coupler (EOC). The EOC performs the conversion from the optical into digital electric signal of the DAE and transfers data to the PC plug-in card.

FCC ID: A3LSCHR550	 PCTEST ENGINEERING LABORATORY, INC.	HAC (RF EMISSIONS) TEST REPORT	 SAMSUNG	Reviewed by: Quality Manager
HAC Filename: 0808061096.A3L	Test Dates: July 29 - August 5, 2008	EUT Type: Cellular/PCS/AWS CDMA Phone with Bluetooth and EVDO	Page 10 of 77	

From the compensated input signals the primary field data for each channel can be evaluated:

$$\text{E - fieldprobes : } E_i = \sqrt{\frac{V_i}{Norm_i \cdot ConvF}}$$

$$\text{H - fieldprobes : } H_i = \sqrt{V_i} \cdot \frac{a_{i0} + a_{i1}f + a_{i2}f^2}{f}$$

with V_i = compensated signal of channel i (i = x, y, z)
 $Norm_i$ = sensor sensitivity of channel i (i = x, y, z)
 $\mu\text{V}/(\text{V/m})^2$ for E-field Probes
 $ConvF$ = sensitivity enhancement in solution
 a_{ij} = sensor sensitivity factors for H-field probes
 f = carrier frequency [GHz]
 E_i = electric field strength of channel i in V/m
 H_i = magnetic field strength of channel i in A/m

The RSS value of the field components gives the total field strength (Hermitian magnitude):



$$E_{tot} = \sqrt{E_x^2 + E_y^2 + E_z^2}$$

The primary field data are used to calculate the derived field units.

The measurement/integration time per point, as specified by the system manufacturer is >500 ms.

The signal response time is evaluated as the time required by the system to reach 90% of the expected final value after an on/off switch of the power source with an integration time of 500 ms and a probe response time of <5 ms. In the current implementation, DASY4 waits longer than 100 ms after having reached the grid point before starting a measurement, i.e., the response time uncertainty is negligible.

If the device under test does not emit a CW signal, the integration time applied to measure the electric field at a specific point may introduce additional uncertainties due to the discretization. The tolerances for the different systems had the worst-case of 2.6%.

FCC ID: A3LSCHR550		HAC (RF EMISSIONS) TEST REPORT		Reviewed by: Quality Manager
HAC Filename: 0808061096.A3L	Test Dates: July 29 - August 5, 2008	EUT Type: Cellular/PCS/AWS CDMA Phone with Bluetooth and EVDO		Page 12 of 77

6. TEST PROCEDURE

I. RF EMISSIONS



Figure 6-1
WD Near-Field Emissions Flow Chart

FCC ID: A3LSCHR550	PCTEST ENGINEERING LABORATORY, INC.	HAC (RF EMISSIONS) TEST REPORT	SAMSUNG	Reviewed by: Quality Manager
HAC Filename: 0808061096.A3L	Test Dates: July 29 - August 5, 2008	EUT Type: Cellular/PCS/AWS CDMA Phone with Bluetooth and EVDO		Page 13 of 77

Test Setup



Figure 6-2

E/H-Field Emissions Test Setup Diagram (See Test Photographs for actual WD scan grid overlay)

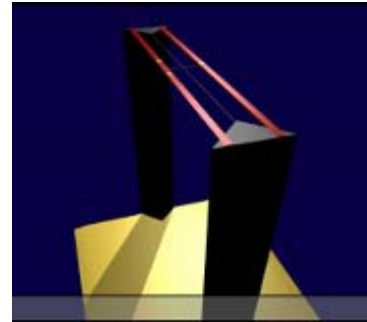



Figure 6-3
HAC Phantom

RF Emissions Test Procedure:

The following illustrate a typical RF emissions test scan over a wireless communications device:

1. Proper operation of the field probe, probe measurement system, other instrumentation, and the positioning system was confirmed.
2. WD is positioned in its intended test position, acoustic output point of the device perpendicular to the field probe.
3. The WD operation for maximum rated RF output power was configured and confirmed with the base station simulator, at the test channel and other normal operating parameters as intended for the test. The battery was ensured to be fully charged before each test.
4. The center sub-grid was centered over the center of the acoustic output (also audio band magnetic output, if applicable). The WD audio output was positioned tangent (as physically possible) to the measurement plane.
5. A surface calibration was performed before each setup change to ensure repeatable spacing and proper maintenance of the measurement plane using the HAC Phantom.
6. The measurement system measured the field strength at the reference location.
7. Measurements at 2mm or 5mm increments in the 5 x 5 cm region were performed at a distance 15 mm from the center point of the probe measurement element to the WD. A 360° rotation about the azimuth axis at the maximum interpolated position was measured. For the worst-case condition, the peak reading from this rotation was used in re-evaluating the HAC category.
8. The system performed a drift evaluation by measuring the field at the reference location.
9. Steps 1-8 were done for both the E and H-Field measurements.

FCC ID: A3LSCHR550		HAC (RF EMISSIONS) TEST REPORT		Reviewed by: Quality Manager
HAC Filename: 0808061096.A3L	Test Dates: July 29 - August 5, 2008	EUT Type: Cellular/PCS/AWS CDMA Phone with Bluetooth and EVDO		Page 14 of 77

7. SYSTEM CHECK

I. System Check Parameters

The input signal was an un-modulated continuous wave. The following points were taken into consideration in performing this check:

- Average Input Power $P = 100\text{mW RMS}$ (20dBm RMS) after adjustment for return loss
- The test fixture must meet the 2 wavelength separation criterion
- The proper measurement of the 1 cm probe to dipole separation, which is measured from top surface of the dipole to the calibration reference point of the sensor, defined by the probe manufacturer is shown in the following diagram:

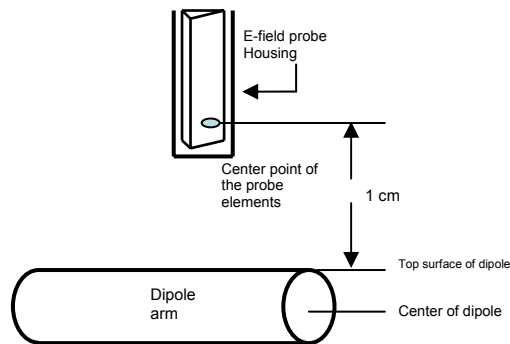

Figure 7-1
Separation Distance from Dipole to Field Probe

RF power was recorded using both an average reading meter and a peak reading meter. Readings of the probe are provided by the measurement system.

To assure proper operation of the near-field measurement probe the input power to the dipole shall be commensurate with the full rated output power of the wireless device (e.g. - for a cellular phone wireless device the average peak antenna input power will be on the order of 100mW (i.e. - 20dBm) RMS after adjustment for any mismatch.



II. Validation Procedure

A dipole antenna meeting the requirements given in C63.19 was placed in the position normally occupied by the WD.

The length of the dipole was scanned with both E-field and H-field probes and the maximum values for each were recorded.

Measurement of CW

Using the near-field measurement system, scan the antenna over the radiating dipole and record the greatest field reading observed. Due to the nature of E-fields about free-space dipoles, the two E-field peaks measured over the dipole are averaged to compensate for non-parallelity of the setup (

FCC ID: A3LSCHR550		HAC (RF EMISSIONS) TEST REPORT		Reviewed by: Quality Manager
HAC Filename: 0808061096.A3L	Test Dates: July 29 - August 5, 2008	EUT Type: Cellular/PCS/AWS CDMA Phone with Bluetooth and EVDO		Page 15 of 77

see manufacturer method on dipole calibration certificates, page 2). Field strength measurements shall be made only when the probe is stationary.

RF power was recorded using both an average and a peak power reading meter.

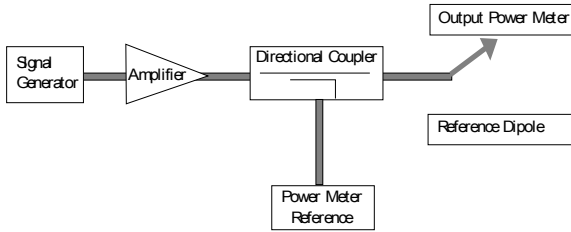

Figure 7-2
Setup for Desired Output Power to Dipole

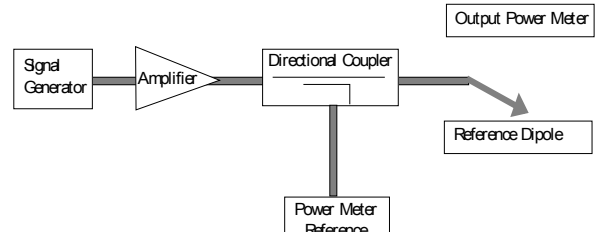

Figure 7-3
Setup to Dipole

Using this setup configuration, the signal generator was adjusted for the desired output power (100mW) at a specified frequency. The reference power from the coupled port of the directional coupler is recorded. Next, the output cable is connected to the reference dipole, as shown in Figure 7-3.

The input signal level was adjusted until the reference power from the coupled port of the directional coupler was the same as previously recorded, to compensate for the impedance mismatch between the output cable and the reference dipole. To assure proper operation of the near-field measurement probe the input power to the reference dipole was verified to the full rated output power of the wireless device. The dipole was secured in a holder in a manner to meet the 20 dB reflection. The near-field measurement probe was positioned over the dipole. The antenna was scanned over the appropriate sized area to cover the dipole from end to end. SPEAG uses 2D interpolation algorithms between the measured points. Please see below two dimensional plots showing that the interpolated values interpolate smoothly between 5mm steps for a free-space RF dipole:

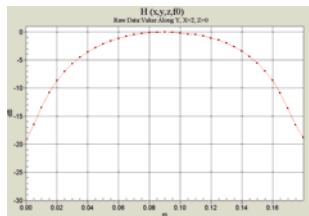

Figure 7-4
2-D Raw Data from scan along dipole axis

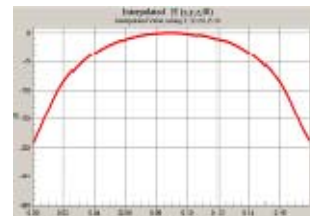

Figure 7-5
2-D Interpolated points from scan along dipole axis

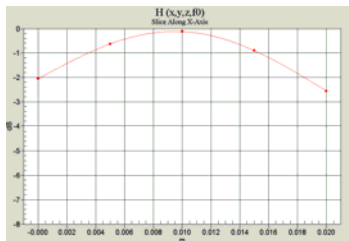

Figure 7-6
2-D Raw Data from scan along transverse axis

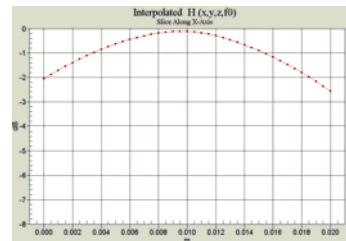

Figure 7-7
2-D Interpolated points from scan along transverse axis

FCC ID: A3LSCHR550		HAC (RF EMISSIONS) TEST REPORT		Reviewed by: Quality Manager
HAC Filename: 0808061096.A3L	Test Dates: July 29 - August 5, 2008	EUT Type: Cellular/PCS/AWS CDMA Phone with Bluetooth and EVDO		Page 16 of 77

III. System Check Results

Validation Results

Frequency (MHz)	Input Power (dBm)	E-field Result (V/m)	Target Field (V/m)	% Deviation
835	20.0	161.1	163.6	-1.5%
1730	20.0	147.0	146.4	0.4%
1880	20.0	131.0	136.3	-3.9%

Frequency (MHz)	Input Power (dBm)	H-field Result (A/m)	Target Field (A/m)	% Deviation
835	20.0	0.421	0.445	-5.4%
1730	20.0	0.474	0.487	-2.6%
1880	20.0	0.456	0.463	-1.5%

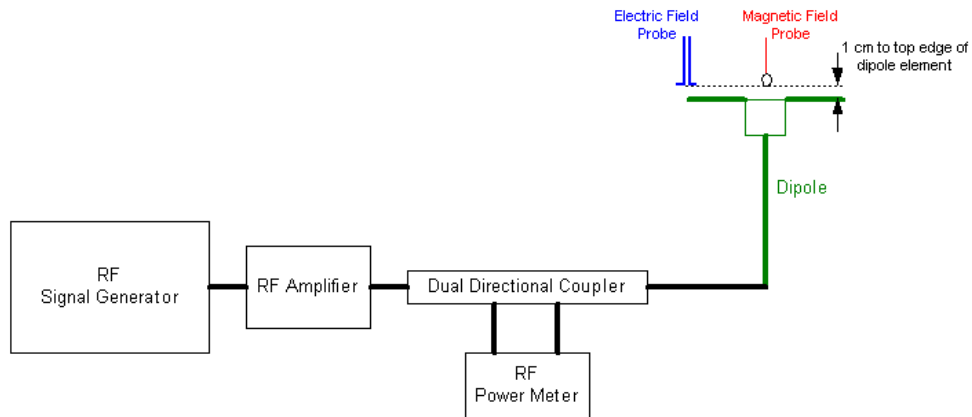

Figure 7-8
System Check Setup

FCC ID: A3LSCHR550	PCTEST ENGINEERING LABORATORY, INC.	HAC (RF EMISSIONS) TEST REPORT	SAMSUNG	Reviewed by: Quality Manager
HAC Filename: 0808061096.A3L	Test Dates: July 29 - August 5, 2008	EUT Type: Cellular/PCS/AWS CDMA Phone with Bluetooth and EVDO		Page 17 of 77

Modulation Factors:

f (MHz)	Peak Power (dBm)	Protocol	E-Field (V/m)	H-Field (A/m)	E-Field Modulation Factor	H-Field Modulation Factor
835	25.0	AM	204.50	0.5971	1.411	1.326
835	25.0	CDMA	311.00	0.9799	0.928	0.808
835	25.0	CW	288.60	0.7915		
1750	25.0	AM	163.50	0.5222	1.313	1.116
1750	25.0	CDMA*	220.70	0.8113	0.972	0.718
1750	25.0	CW	214.60	0.5826		
1880	25.0	AM	155.40	0.6561	1.445	1.501
1880	25.0	CDMA	226.80	1.2010	0.990	0.820
1880	25.0	CW	224.50	0.9846		

f (MHz)	Protocol	E-Field (V/m)	E-Field Modulation Factor
1750	CDMA / SO3	51.10	2.999
1750	CW	153.24	

Figure 8-3
Modulation Factors

FCC 3G Note: "CDMA*" represents worst-case mode, while "CDMA/SO3" represents RC1/SO3 mode.

CW and Modulated Signal Zero-Span plots:

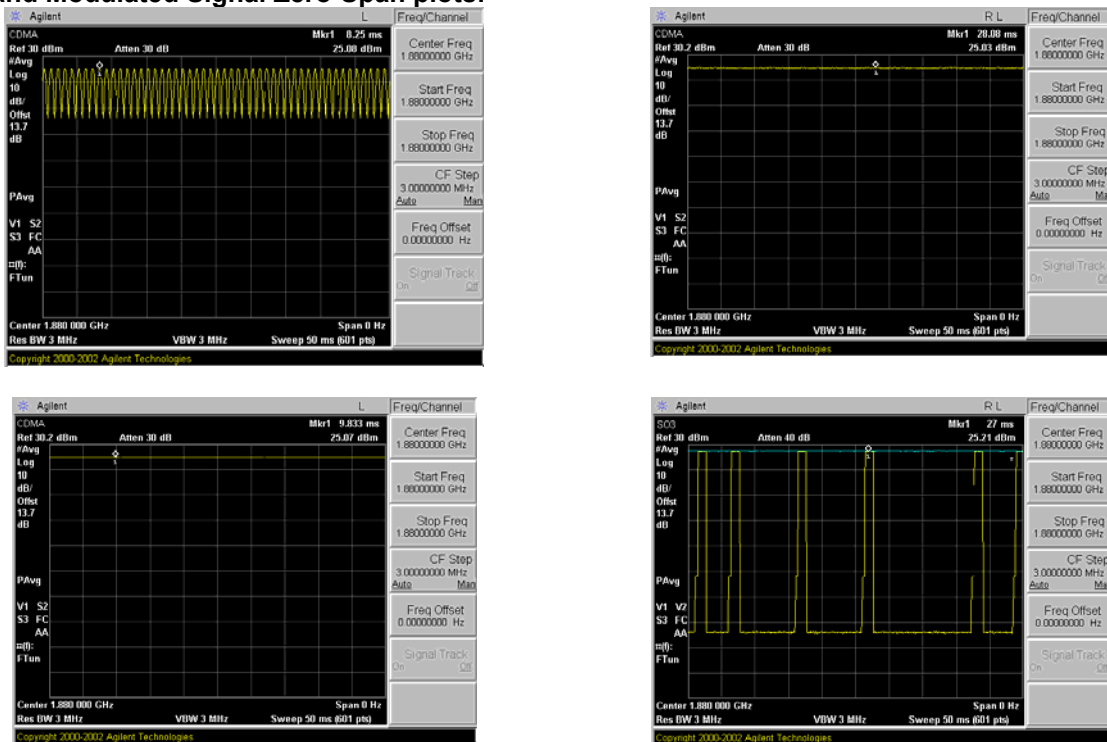

Figure 8-4 Zero-Span Plots

FCC ID: A3LSCHR550	PCTEST ENGINEERING LABORATORY, INC.	HAC (RF EMISSIONS) TEST REPORT	SAMSUNG	Reviewed by: Quality Manager
HAC Filename: 0808061096.A3L	Test Dates: July 29 - August 5, 2008	EUT Type: Cellular/PCS/AWS CDMA Phone with Bluetooth and EVDO		Page 19 of 77

9. FCC 3G MEASUREMENTS

Sample pre-testing of the various modes were performed at the worst case probe location as part of subset testing justification. See below for measured conducted power for applicable device modes:

I. Handset Capabilities*:

*See Device Capabilities attachment for applicable device modes and powers.



Figure 9-1
Power Measurement Setup

II. Worst-Case Probe Location Measurements

Below are RC/SO mode investigation results of the device at the worst-case (maximum) field point location. The worst-case RC/SO was used for HAC testing.

Table 9-1
Handset 3G mode variation on RF Emissions

Mode	Channel	Backlight	RC/SO	Scan Center	Battery	Antenna	Conducted Power at BS (dBm)	Time Avg. Field (V/m)	Peak Field (dBV/m)	FCC Limit (dBV/m)	FCC MARGIN (dB)	RESULT	Excl Blocks per 4.4
AWS	450	off	SO3/RC1	Acoustic	Standard	Internal	24.50	10.50	30.0	41.0	-11.04	M4	none
AWS	450	off	SO3/RC3	Acoustic	Standard	Internal	24.50	29.62	29.3	41.0	-11.66	M4	none
AWS	450	off	SO3/RC4	Acoustic	Standard	Internal	24.50	29.70	29.4	41.0	-11.63	M4	none
AWS	450	off	SO55/RC3	Acoustic	Standard	Internal	24.50	29.91	29.4	41.0	-11.57	M4	none
AWS	450	off	SO55/RC1	Acoustic	Standard	Internal	24.50	29.78	29.4	41.0	-11.61	M4	none
AWS	450	off	SO2/RC1	Acoustic	Standard	Internal	24.50	29.80	29.4	41.0	-11.60	M4	none
AWS	450	off	SO2/RC3	Acoustic	Standard	Internal	24.50	29.63	29.3	41.0	-11.65	M4	none
AWS	450	off	SO9/RC2	Acoustic	Standard	Internal	24.50	29.87	29.4	41.0	-11.58	M4	none
AWS	450	off	SO9/RC5	Acoustic	Standard	Internal	24.50	29.64	29.3	41.0	-11.65	M4	none

FCC ID: A3LSCHR550	PCTEST ENGINEERING LABORATORY, INC.	HAC (RF EMISSIONS) TEST REPORT	SAMSUNG	Reviewed by: Quality Manager
HAC Filename: 0808061096.A3L	Test Dates: July 29 - August 5, 2008	EUT Type: Cellular/PCS/AWS CDMA Phone with Bluetooth and EVDO		Page 20 of 77

10. OVERALL MEASUREMENT SUMMARY

FCC ID:	A3LSCHR550
Model:	SCH-R550
S/N:	HAC #16

I. E-FIELD EMISSIONS:

**Table 10-1
HAC Data Summary for E-field**

Band	Channel	Backlight	RC/SO	Scan Center	Battery	Antenna	Conducted Power at BS (dBm)	Time Avg. Field (V/m)	Peak Field (dBV/m)	FCC Limit (dBV/m)	FCC MARGIN (dB)	RESULT	Excl Blocks per 4.4
E-field Emissions													
CDMA	1013	off	SO55/RC3	Acoustic	Standard	Internal	25.06	56.16	34.3	51.0	-16.66	M4	none
CDMA	384	off	SO55/RC3	Acoustic	Standard	Internal	25.02	65.86	35.7	51.0	-15.28	M4	none
CDMA	777	off	SO55/RC3	Acoustic	Standard	Internal	24.77	72.21	36.5	51.0	-14.48	M4	none
<hr/>													
AWS	25	off	SO55/RC3	Acoustic	Standard	Internal	24.92	41.44	32.1	41.0	-8.90	M4	none
AWS	450	off	SO55/RC3	Acoustic	Standard	Internal	24.50	46.46	33.1	41.0	-7.90	M4	none
AWS	875	off	SO55/RC3	Acoustic	Standard	Internal	24.86	39.05	31.6	41.0	-9.41	M4	none
<hr/>													
PCS	25	off	SO55/RC3	Acoustic	Standard	Internal	24.42	40.77	32.1	41.0	-8.88	M4	none
PCS	600	off	SO55/RC3	Acoustic	Standard	Internal	24.68	41.90	32.4	41.0	-8.64	M4	none
PCS	1175	off	SO55/RC3	Acoustic	Standard	Internal	24.08	32.42	30.1	41.0	-10.87	M4	none

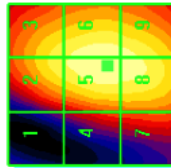



Figure 10-1
Sample E-field Scan Overlay
(See Test Setup Photographs for actual WD overlay)

Note: Worst-case measurement evaluated for worst-case 1/8 rate gating condition in RC1/SO3; Mute=Yes

FCC ID: A3LSCHR550	 PCTEST ENGINEERING LABORATORY, INC.	HAC (RF EMISSIONS) TEST REPORT		Reviewed by: Quality Manager
HAC Filename: 0808061096.A3L	Test Dates: July 29 - August 5, 2008	EUT Type: Cellular/PCS/AWS CDMA Phone with Bluetooth and EVDO	Page 21 of 77	

FCC ID:	A3LSCHR550
Model:	SCH-R550
S/N:	HAC #16

II. H-FIELD EMISSIONS:

**Table 10-2
HAC Data Summary for H-field**

Mode	Channel	Backlight	RC/SO	Scan Center	Battery	Antenna	Conducted Power at BS (dBm)	Time Avg. Field (A/m)	Peak Field (dBA/m)	FCC Limit (dBA/m)	FCC MARGIN (dB)	RESULT	Excl Blocks per 4.4
H-field Emissions													
CDMA	1013	off	SO55/RC3	Acoustic	Standard	Internal	25.06	0.1044	-21.5	0.6	-22.08	M4	none
CDMA	384	off	SO55/RC3	Acoustic	Standard	Internal	25.02	0.0962	-22.2	0.6	-22.80	M4	none
CDMA	777	off	SO55/RC3	Acoustic	Standard	Internal	24.77	0.1094	-21.1	0.6	-21.67	M4	none
<hr/>													
AWS	25	off	SO55/RC3	Acoustic	Standard	Internal	24.92	0.0971	-23.1	-9.4	-13.73	M4	none
AWS	450	off	SO55/RC3	Acoustic	Standard	Internal	24.50	0.1161	-21.6	-9.4	-12.18	M4	none
AWS	875	off	SO55/RC3	Acoustic	Standard	Internal	24.86	0.0858	-24.2	-9.4	-14.81	M4	none
<hr/>													
PCS	25	off	SO55/RC3	Acoustic	Standard	Internal	24.42	0.0651	-25.5	-9.4	-16.05	M4	none
PCS	600	off	SO55/RC3	Acoustic	Standard	Internal	24.68	0.0736	-24.4	-9.4	-14.99	M4	none
PCS	1175	off	SO55/RC3	Acoustic	Standard	Internal	24.08	0.0628	-25.8	-9.4	-16.36	M4	none

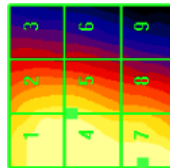



Figure 10-2
Sample H-field Scan Overlay
(See Test Setup Photographs for actual WD overlay)

FCC ID: A3LSCHR550	 ENGINEERING LABORATORY, INC.	HAC (RF EMISSIONS) TEST REPORT		Reviewed by: Quality Manager
HAC Filename: 0808061096.A3L	Test Dates: July 29 - August 5, 2008	EUT Type: Cellular/PCS/AWS CDMA Phone with Bluetooth and EVDO		Page 22 of 77

FCC ID:	A3LSCHR550
Model:	SCH-R550
S/N:	HAC #16

III. Worst-case Configuration Evaluation

Table 10-3
Peak Reading 360° Probe Rotation at Azimuth axis

Mode	Channel	Backlight	RC/SO	Scan Center	Battery	Antenna	Conducted Power at BS (dBm)	Time Avg. Field (V/m)	Peak Field (dBV/m)	FCC Limit (dBV/m)	FCC MARGIN (dB)	RESULT
Probe Rotation at Worst-case												
AWS	450	off	SO55/RC3	Acoustic	Standard	Internal	24.50	46.42	33.2	41.0	-7.75	M4

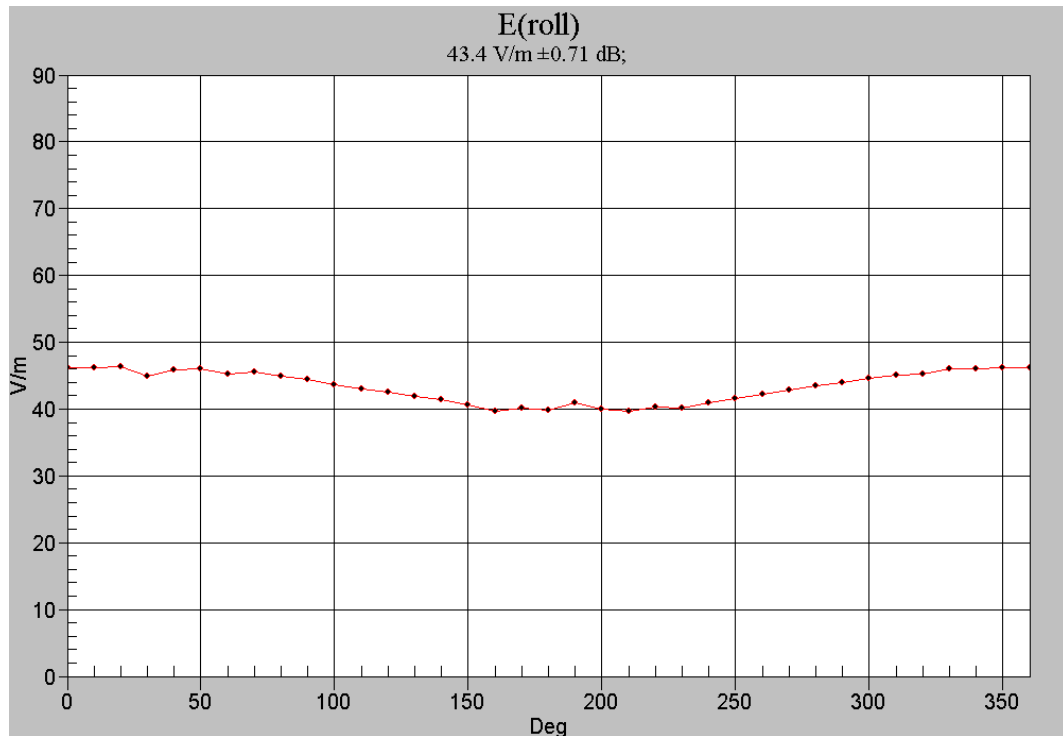

Figure 10-3
Worst-Case Probe Rotation about Azimuth axis

* Note: Location of probe rotation is shown in Figure 10-1 or Figure 10-2



FCC ID: A3LSCHR550	PCTEST ENGINEERING LABORATORY, INC.	HAC (RF EMISSIONS) TEST REPORT	SAMSUNG	Reviewed by: Quality Manager
HAC Filename: 0808061096.A3L	Test Dates: July 29 - August 5, 2008	EUT Type: Cellular/PCS/AWS CDMA Phone with Bluetooth and EVDO	Page 23 of 77	

11. EQUIPMENT LIST

Manufacturer	Model	Description	Calibration Date	Cal Interval	Calibration Due	Serial No.
Agilent	8648D	(9kHz-4GHz) Signal Generator	10/11/07	Biennial	10/10/09	3613A00315
Agilent	E4407B	ESA Spectrum Analyzer	3/13/08	Annual	3/13/09	US39210313
Agilent	E4432B	ESG-D Series Signal Generator	8/8/06	Biennial	8/8/08	US40053896
Agilent	E5515C	Wireless Communications Test Set	6/8/07	Biennial	6/8/09	GB46110872
Agilent	E5515C	Wireless Communications Test Set	6/8/07	Biennial	6/8/09	GB46310798
Agilent	E5515C	Wireless Communications Test Set	8/31/07	Biennial	8/31/09	GB41450275
Rohde & Schwarz	CMU200	Base Station Simulator	5/29/08	Annual	5/29/09	836371/0079
Rohde & Schwarz	CMU200	Base Station Simulator	9/7/07	Annual	9/6/08	833855/0010
Rohde & Schwarz	CMU200	Base Station Simulator	12/6/07	Annual	12/5/08	107826
Rohde & Schwarz	CMU200	Base Station Simulator	7/23/08	Annual	7/23/09	109892
Rohde & Schwarz	NRVD	Dual Channel Power Meter	12/12/06	Biennial	12/11/08	101695
Rohde & Schwarz	NRVS	Single Channel Power Meter	7/3/07	Biennial	7/2/09	835360/0079
Rohde & Schwarz	NRV-Z32	Peak Power Sensor (100uW-2W)	12/21/06	Biennial	12/20/08	100155
Rohde & Schwarz	NRV-Z33	Peak Power Sensor (1mW-20W)	11/28/06	Biennial	11/27/08	100004
Rohde & Schwarz	NRV-Z53	Power Sensor	7/3/07	Biennial	7/2/09	846076/0007
SPEAG	CD1880V3	Freospace 1880 MHz Dipole	1/16/07	Biennial	1/15/09	1002
SPEAG	CD1880V3	Freospace 1880 MHz Dipole	3/11/08	Biennial	3/11/10	1064
SPEAG	CD835V3	Freospace 835 MHz Dipole	1/16/07	Biennial	1/15/09	1003
SPEAG	DAE3	Dasy Data Acquisition Electronics	11/13/07	Annual	11/12/08	455
SPEAG	DAE4	Dasy Data Acquisition Electronics	8/29/07	Annual	8/28/08	665
SPEAG	DAE4	Dasy Data Acquisition Electronics	1/30/08	Annual	1/29/09	649
SPEAG	ER3DV6	Freospace E-field Probe	11/20/07	Annual	11/19/08	2335
SPEAG	ER3DV6	Freospace E-field Probe	1/28/08	Annual	1/27/09	2332
SPEAG	H3DV6	Freospace H-field Probe	11/20/07	Annual	11/19/08	6170
SPEAG	H3DV6	Freospace H-field Probe	1/28/08	Annual	1/27/09	6180

Table 11-1
Equipment List

*Calibration traceable to the National Institute of Standards and Technology (NIST).

FCC ID: A3LSCHR550		HAC (RF EMISSIONS) TEST REPORT		Reviewed by: Quality Manager
HAC Filename: 0808061096.A3L	Test Dates: July 29 - August 5, 2008	EUT Type: Cellular/PCS/AWS CDMA Phone with Bluetooth and EVDO	Page 24 of 77	

12. MEASUREMENT UNCERTAINTY



Wireless Communications Device Near-Field Measurement								
Uncertainty Estimation								
Uncertainty Component	Data (dB)	Data Type	Prob. Dist.	Divisor	Ci (E)	Ci (H)	Unc. (dB)	Notes/Comments
Measurement System								
RF System Reflections	0.50	Tolerance	N	1.00	1	1	0.50	Refl. < -20 dB
Field Probe Calibration	0.21	Tolerance	N	1.00	1	1	0.21	
Field Probe Isotropy	0.01	Tolerance	N	1.00	1	1	0.01	
Field Probe Frequency Response	0.135	Tolerance	N	1.00	1	1	0.14	
Field Probe Linearity	0.013	Tolerance	N	1.00	1	1	0.01	
Probe Modulation Factor	0.270	Accuracy	R	1.73	1	1	0.16	
Boundary Effects	0.105	Accuracy	R	1.73	1	1	0.06	*
Probe Positioning Accuracy	0.20	Accuracy	R	1.73	1	0.670	0.12	*
Probe Positioner	0.050	Accuracy	R	1.73	1	0.670	0.03	*
Extrapolation/Interpolation	0.045	Tolerance	R	1.73	1	1	0.03	*
Resolution to 2mm error	0.210	Tolerance	N	1.00	1	1	0.21	
System Detection Limit	0.05	Tolerance	R	1.73	1	1	0.03	*
Readout Electronics	0.015	Tolerance	N	1.00	1	1	0.02	*
Integration Time	0.11	Tolerance	R	1.73	1	1	0.06	*
Response Time	0.033	Tolerance	R	1.73	1	1	0.02	*
Phantom Thickness	0.10	Tolerance	R	1.73	1	1	0.06	*
System Repeatability (Field x 2=power)	0.17	Tolerance	N	1.00	1	1	0.17	
Test Sample Related								
Device Positioning Vertical	0.2	Tolerance	R	1.73	1	1	0.12	*
Device Positioning Lateral	0.045	Tolerance	R	1.73	1	1	0.03	*
Device Holder and Phantom	0.1	Tolerance	R	1.73	1	1	0.06	*
Power Drift	0.21	Tolerance	R	1.73	1	1	0.12	
<i>Combined Standard Uncertainty (k=1)</i>							0.66	16.5%
<i>Expanded Uncertainty [95% confidence] (k=2)</i>							1.33	32.3%
<i>Expanded Uncertainty [95% confidence] on Field</i>							0.66	16.2%

Table 12-1
Uncertainty Estimation Table

Notes:



1. Test equipments are calibrated according to techniques outlined in NIS81, NIS3003 and NIST Tech Note 1297. All equipments have traceability according to NIST. Measurement Uncertainties are defined in further detail in NIS 81 and NIST Tech Note 1297 and UKAS M3003.
2. * Uncertainty specifications from Schmidt & Partner Engineering AG (not site specific)

Measurement uncertainty reflects the quality and accuracy of a measured result as compared to the true value. Such statements are generally required when stating results of measurements so that it is clear to the intended audience that the results may differ when reproduced by different facilities. Measurement results vary due to the measurement uncertainty of the instrumentation, measurement technique, and test engineer. Most uncertainties are calculated using the tolerances of the instrumentation used in the measurement, the measurement setup variability, and the technique used in performing the test. While not generally included, the variability of the equipment under test also figures into the overall measurement uncertainty. Another component of the overall uncertainty is based on the variability of repeated measurements (so-called Type A uncertainty). This may mean that the Hearing Aid immunity tests may have to be repeated by taking down the test setup and resetting it up so that there are a statistically significant number of repeat measurements to identify the measurement uncertainty. By combining the repeat measurement results with that of the instrumentation chain using the technique contained in NIS 81 and NIS 3003, the overall measurement uncertainty was estimated.

FCC ID: A3LSCHR550	 ENGINEERING LABORATORY, INC.	HAC (RF EMISSIONS) TEST REPORT	
HAC Filename: 0808061096.A3L	Test Dates: July 29 - August 5, 2008	EUT Type: Cellular/PCS/AWS CDMA Phone with Bluetooth and EVDO	Reviewed by: Quality Manager Page 25 of 77

13. TEST DATA

See following Attached Pages for Test Data.

FCC ID: A3LSCHR550		HAC (RF EMISSIONS) TEST REPORT		Reviewed by: Quality Manager
HAC Filename: 0808061096.A3L	Test Dates: July 29 - August 5, 2008	EUT Type: Cellular/PCS/AWS CDMA Phone with Bluetooth and EVDO	Page 26 of 77	



PCTEST Hearing-Aid Compatibility Facility

DUT: CD835V3 - SN1003

Type: CD835V3
 Serial: 1003
 Duty Cycle: 1:1

Communication System: CW; Frequency: 835 MHz;

Measurement Standard: DASY4 (High Precision Assessment)

DASY4 Configuration:

- Probe: ER3DV6 - SN2335; Calibrated: 11/20/2007
- Sensor-Surface: 0mm (Fix Surface)
- Electronics: DAE4 Sn665; Calibrated: 8/29/2007
- Phantom: HAC; Type: SD HAC P01 BA;
- Measurement SW: DASY4, V4.7 Build 53;

835MHz, 100mW/20dBm

Hearing Aid Compatibility Test (41x361x1):

Measurement grid: dx=5mm, dy=5mm
 Probe Modulation Factor = 1.00
 Reference Value = 104.1 V/m; Power Drift = 0.081 dB
 Average value of Total (interpolated) = 161.1 V/m

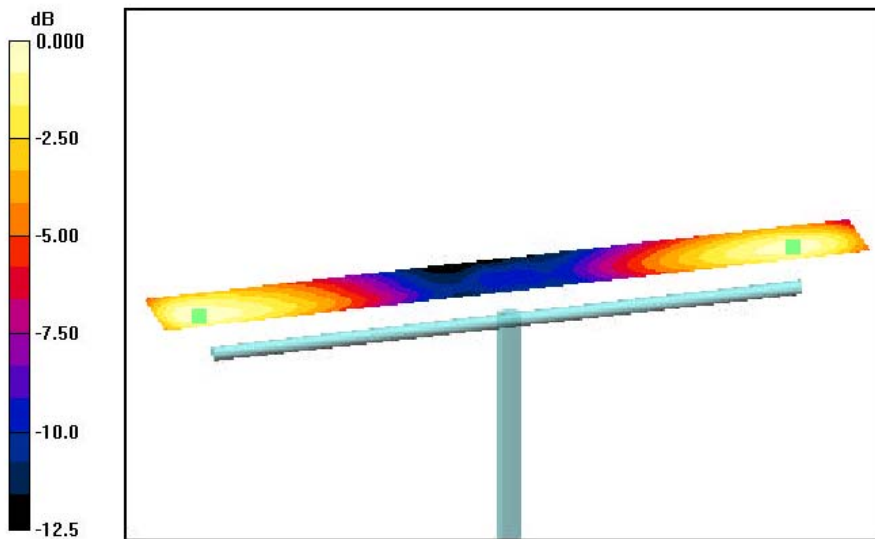

0 dB = 164.1V/m

© 2008 PCTEST

FCC ID: A3LSCHR550	PCTEST ENGINEERING LABORATORY, INC.	HAC (RF EMISSIONS) TEST REPORT	SAMSUNG	Reviewed by: Quality Manager
HAC Filename: 0808061096.A3L	Test Dates: July 29 - August 5, 2008	EUT Type: Cellular/PCS/AWS CDMA Phone with Bluetooth and EVDO		Page 27 of 77



PCTEST Hearing-Aid Compatibility Facility

DUT: CD1880V3 - SN1064

Type: CD1880V3
Serial: 1064

Communication System: CW; Frequency: 1730 MHz:

Measurement Standard: DASY4 (High Precision Assessment)

DASY4 Configuration:

- Probe: ER3DV6 - SN2335; Calibrated: 11/20/2007
- Sensor-Surface: 0mm (Fix Surface)
- Electronics: DAE4 Sn665; Calibrated: 8/29/2007
- Phantom: HAC; Type: SD HAC P01 BA;
- Measurement SW: DASY4, V4.7 Build 53;

1750MHz, 100mW/20dBm/Hearing Aid Compatibility Test (41x181x1):

Measurement grid: dx=5mm, dy=5mm
Probe Modulation Factor = 1.00
Reference Value = 165.6 V/m; Power Drift = -0.049 dB
Average value of Total (interpolated) = 140.85 V/m

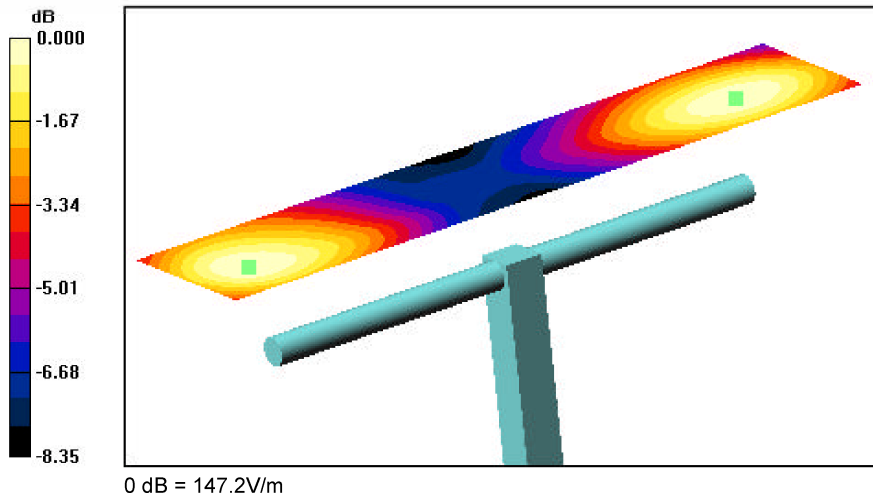

© 2008 PCTEST

FCC ID: A3LSCHR550	PCTEST ENGINEERING LABORATORY, INC.	HAC (RF EMISSIONS) TEST REPORT	SAMSUNG	Reviewed by: Quality Manager
HAC Filename: 0808061096.A3L	Test Dates: July 29 - August 5, 2008	EUT Type: Cellular/PCS/AWS CDMA Phone with Bluetooth and EVDO	Page 28 of 77	



PCTEST Hearing-Aid Compatibility Facility

DUT: CD1880V3 - SN1064

Type: CD1880V3
 Serial: 1064
 Duty Cycle: 1:1

Communication System: CW; Frequency: 1880 MHz;

Measurement Standard: DASY4 (High Precision Assessment)

DASY4 Configuration:

- Probe: ER3DV6 - SN2335; Calibrated: 11/20/2007
- Sensor-Surface: 0mm (Fix Surface)
- Electronics: DAE4 Sn665; Calibrated: 8/29/2007
- Phantom: HAC; Type: SD HAC P01 BA;
- Measurement SW: DASY4, V4.7 Build 53;

1880MHz, 100mW/20dBm

Hearing Aid Compatibility Test (41x181x1):

Measurement grid: dx=5mm, dy=5mm
 Probe Modulation Factor = 1.00
 Reference Value = 142.5 V/m; Power Drift = -0.196 dB
 Average value of Total (interpolated) = 126.6 V/m

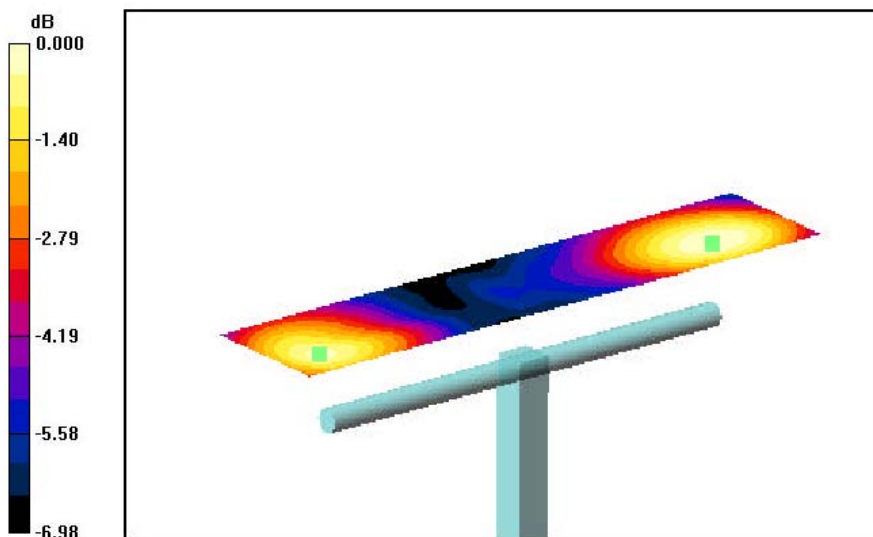

0 dB = 128.5V/m

© 2008 PCTEST

FCC ID: A3LSCHR550	PCTEST ENGINEERING LABORATORY, INC.	HAC (RF EMISSIONS) TEST REPORT	SAMSUNG	Reviewed by: Quality Manager
HAC Filename: 0808061096.A3L	Test Dates: July 29 - August 5, 2008	EUT Type: Cellular/PCS/AWS CDMA Phone with Bluetooth and EVDO		Page 29 of 77



PCTEST Hearing-Aid Compatibility Facility

DUT: CD835V3 - SN1003

Type: CD835V3
 Serial: 1003
 Duty Cycle: 1:1

Communication System: CW; Frequency: 835 MHz;

Measurement Standard: DASY4 (High Precision Assessment)

DASY4 Configuration:

- Probe: H3DV6 - SN6170; Calibrated: 11/20/2007
- Sensor-Surface: 0mm (Fix Surface)
- Electronics: DAE4 Sn665; Calibrated: 8/29/2007
- Phantom: HAC; Type: SD HAC P01 BA;
- Measurement SW: DASY4, V4.7 Build 53;

835MHz, 100mW/20dBm

Hearing Aid Compatibility Test (41x361x1):

Measurement grid: dx=5mm, dy=5mm
 Probe Modulation Factor = 1.00
 Reference Value = 0.443 A/m; Power Drift = -0.186 dB
 Maximum value of Total (interpolated) = 0.421 A/m

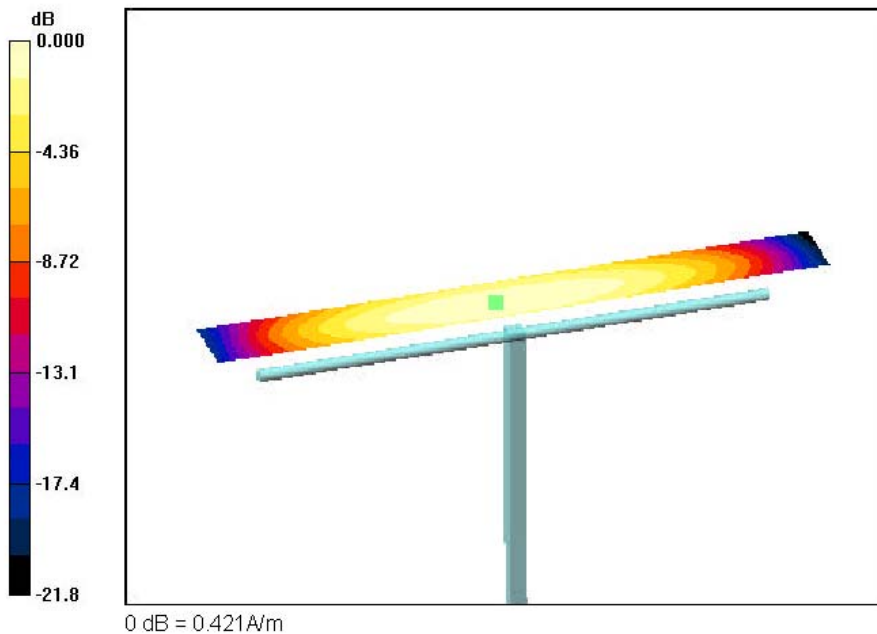

© 2008 PCTEST

FCC ID: A3LSCHR550	PCTEST ENGINEERING LABORATORY, INC.	HAC (RF EMISSIONS) TEST REPORT	SAMSUNG	Reviewed by: Quality Manager
HAC Filename: 0808061096.A3L	Test Dates: July 29 - August 5, 2008	EUT Type: Cellular/PCS/AWS CDMA Phone with Bluetooth and EVDO		Page 30 of 77



PCTEST Hearing-Aid Compatibility Facility

DUT: CD1880V3 - SN1064

Type: CD1880V3
Serial: 1064

Communication System: CW; Frequency: 1730 MHz;

Measurement Standard: DASY4 (High Precision Assessment)

DASY4 Configuration:

- Probe: H3DV6 - SN6170; Calibrated: 11/20/2007
- Sensor-Surface: 0mm (Fix Surface)
- Electronics: DAE4 Sn665; Calibrated: 8/29/2007
- Phantom: HAC; Type: SD HAC P01 BA;
- Measurement SW: DASY4, V4.7 Build 53;

1730MHz, 100mW/20dBm/Hearing Aid Compatibility Test (41x181x1):

Measurement grid: dx=5mm, dy=5mm
Probe Modulation Factor = 1.00
Reference Value = 0.509 A/m; Power Drift = -0.071 dB
Maximum value of Total (interpolated) = 0.474 A/m

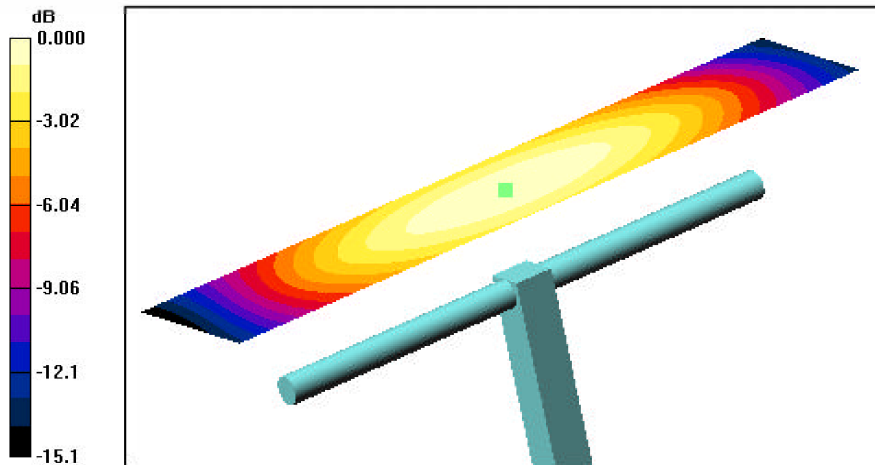

0 dB = 0.474A/m

© 2008 PCTEST

FCC ID: A3LSCHR550	PCTEST ENGINEERING LABORATORY, INC.	HAC (RF EMISSIONS) TEST REPORT	SAMSUNG	Reviewed by: Quality Manager
HAC Filename: 0808061096.A3L	Test Dates: July 29 - August 5, 2008	EUT Type: Cellular/PCS/AWS CDMA Phone with Bluetooth and EVDO		Page 31 of 77



PCTEST Hearing-Aid Compatibility Facility

DUT: CD1880V3 - SN1064

Type: CD1880V3
 Serial: 1064
 Duty Cycle: 1:1

Communication System: CW; Frequency: 1880 MHz;

Measurement Standard: DASy4 (High Precision Assessment)

DASy4 Configuration:

- Probe: H3DV6 - SN6170; Calibrated: 11/20/2007
- Sensor-Surface: 0mm (Fix Surface)
- Electronics: DAE4 Sn665; Calibrated: 8/29/2007
- Phantom: HAC; Type: SD HAC P01 BA;
- Measurement SW: DASy4, V4.7 Build 53;

1880MHz, 100mW/20dBm

Hearing Aid Compatibility Test (41x181x1):

Measurement grid: dx=5mm, dy=5mm
 Probe Modulation Factor = 1.00
 Reference Value = 0.484 A/m; Power Drift = -0.007 dB
 Maximum value of Total (interpolated) = 0.456 A/m

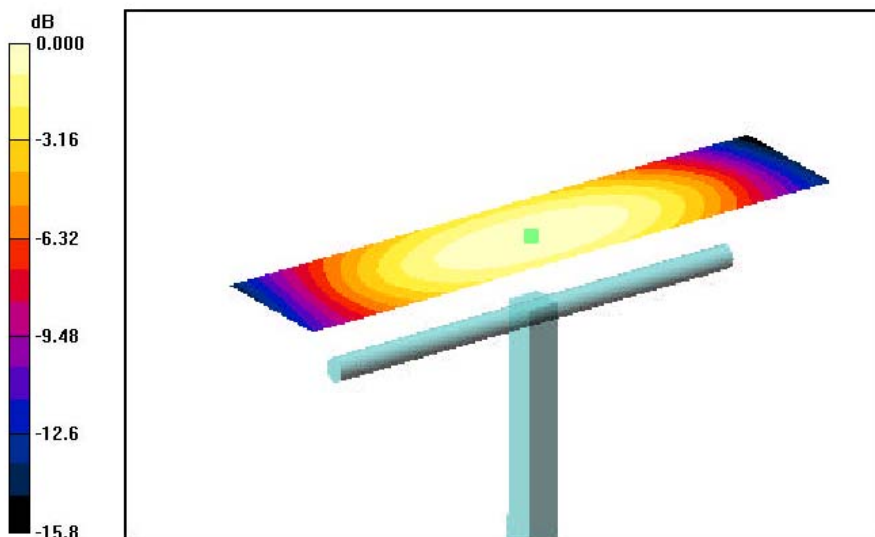

0 dB = 0.456A/m

© 2008 PCTEST

FCC ID: A3LSCHR550	PCTEST ENGINEERING LABORATORY, INC.	HAC (RF EMISSIONS) TEST REPORT	SAMSUNG	Reviewed by: Quality Manager
HAC Filename: 0808061096.A3L	Test Dates: July 29 - August 5, 2008	EUT Type: Cellular/PCS/AWS CDMA Phone with Bluetooth and EVDO		Page 32 of 77



PCTEST Hearing-Aid Compatibility Facility

DUT: SCH-R550

Type: Cellular/AWS/PCS CDMA Phone with BT
 Serial: 16
 Backlight off
 Duty Cycle: 1:1

Communication System: Cellular CDMA; Frequency: 848.31 MHz;

Measurement Standard: DAS4 (High Precision Assessment)

DASY4 Configuration:

- Probe: ER3DV6 - SN2335; Calibrated: 11/20/2007
- Sensor-Surface: (Fix Surface)
- Electronics: DAE4 Sn665; Calibrated: 8/29/2007
- Phantom: HAC; Type: SD HAC P01 BA;
- Measurement SW: DAS4, V4.7 Build 71;

High.ch CDMA/Hearing Aid Compatibility Test (101x101x1):

Measurement grid: dx=5mm, dy=5mm
 Maximum value of peak Total field = 67.0 V/m
 Probe Modulation Factor = 0.928
 Reference Value = 88.9 V/m; Power Drift = 0.016 dB
Hearing Aid Near-Field Category: M4 (AWF 0 dB)

Peak E-field in V/m

Grid 1	Grid 2	Grid 3
62.9 M4	66.8 M4	61.7 M4
Grid 4	Grid 5	Grid 6
63.2 M4	67.0 M4	62.1 M4
Grid 7	Grid 8	Grid 9
60.5 M4	64.2 M4	58.8 M4

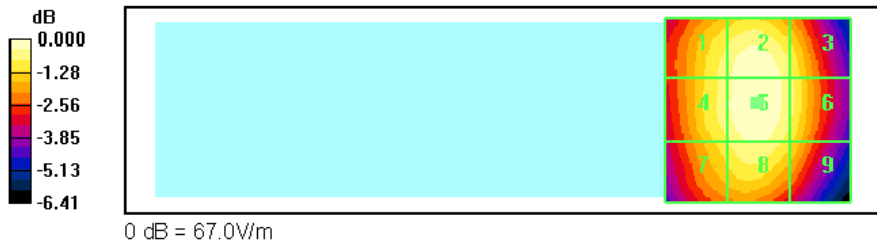

© 2008 PCTEST

FCC ID: A3LSCHR550	PCTEST ENGINEERING LABORATORY, INC.	HAC (RF EMISSIONS) TEST REPORT	SAMSUNG	Reviewed by: Quality Manager
HAC Filename: 0808061096.A3L	Test Dates: July 29 - August 5, 2008	EUT Type: Cellular/PCS/AWS CDMA Phone with Bluetooth and EVDO	Page 33 of 77	



PCTEST Hearing-Aid Compatibility Facility

DUT: SCH-R550

Type: Cellular/AWS/PCS CDMA Phone with BT
 Serial: 16
 Backlight off
 Duty Cycle: 1:1

Communication System: AWS CDMA; Frequency: 1732.5 MHz;

Measurement Standard: DAS4 (High Precision Assessment)

DAS4 Configuration:

- Probe: ER3DV6 - SN2335; Calibrated: 11/20/2007
- Sensor-Surface: (Fix Surface)
- Electronics: DAE4 Sn665; Calibrated: 8/29/2007
- Phantom: HAC; Type: SD HAC P01 BA;
- Measurement SW: DAS4, V4.7 Build 71;

Mid.ch AWS/Hearing Aid Compatibility Test (101x101x1):

Measurement grid: dx=5mm, dy=5mm
 Maximum value of peak Total field = 45.2 V/m
 Probe Modulation Factor = 0.972
 Reference Value = 54.4 V/m; Power Drift = 0.099 dB
Hearing Aid Near-Field Category: M4 (AWF 0 dB)

Peak E-field in V/m

Grid 1	Grid 2	Grid 3
25.3 M4	41.8 M4	41.4 M4
Grid 4	Grid 5	Grid 6
31.4 M4	45.2 M4	44.6 M4
Grid 7	Grid 8	Grid 9
32.4 M4	44.5 M4	43.8 M4

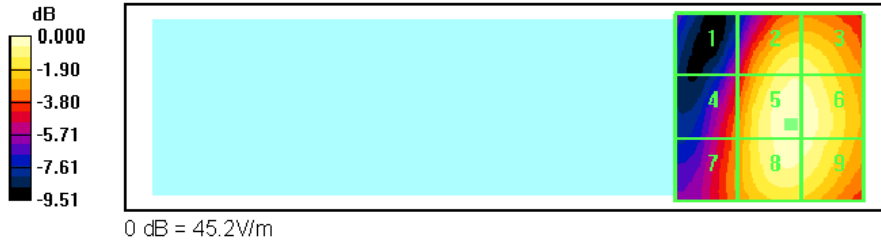

© 2008 PCTEST

FCC ID: A3LSCHR550	PCTEST ENGINEERING LABORATORY, INC.	HAC (RF EMISSIONS) TEST REPORT	SAMSUNG	Reviewed by: Quality Manager
HAC Filename: 0808061096.A3L	Test Dates: July 29 - August 5, 2008	EUT Type: Cellular/PCS/AWS CDMA Phone with Bluetooth and EVDO	Page 34 of 77	



DUT: SCH-R550

Type: Cellular/AWS/PCS CDMA Phone with BT
 Serial: 16
 Backlight off
 Duty Cycle: 1:1

Communication System: PCS CDMA; Frequency: 1880 MHz;

Measurement Standard: DAS4 (High Precision Assessment)

DAS4 Configuration:

- Probe: ER3DV6 - SN2335; Calibrated: 11/20/2007
- Sensor-Surface: (Fix Surface)
- Electronics: DAE4 Sn665; Calibrated: 8/29/2007
- Phantom: HAC; Type: SD HAC F01 BA;
- Measurement SW: DAS4, V4.7 Build 71;

Mid.ch/Hearing Aid Compatibility Test (101x101x1):

Measurement grid: dx=5mm, dy=5mm
 Maximum value of peak Total field = 41.5 V/m
 Probe Modulation Factor = 0.990
 Reference Value = 44.8 V/m; Power Drift = -0.189 dB
Hearing Aid Near-Field Category: M4 (AWF 0 dB)

Peak E-field in V/m

Grid 1	Grid 2	Grid 3
20.8 M4	32.5 M4	32.4 M4
Grid 4	Grid 5	Grid 6
30.4 M4	40.7 M4	40.6 M4
Grid 7	Grid 8	Grid 9
34.9 M4	41.5 M4	41.0 M4

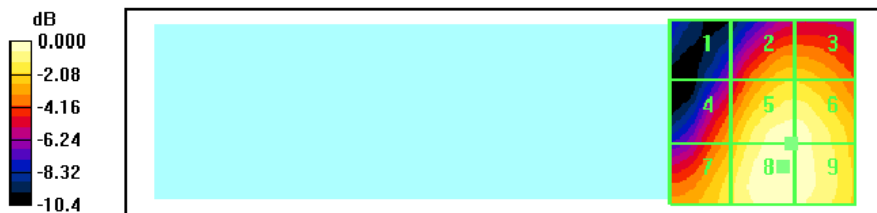

0 dB = 41.5V/m

FCC ID: A3LSCHR550	PCTEST ENGINEERING LABORATORY, INC.	HAC (RF EMISSIONS) TEST REPORT	SAMSUNG	Reviewed by: Quality Manager
HAC Filename: 0808061096.A3L	Test Dates: July 29 - August 5, 2008	EUT Type: Cellular/PCS/AWS CDMA Phone with Bluetooth and EVDO		Page 35 of 77



PCTEST Hearing-Aid Compatibility Facility

DUT: SCH-R550

Type: Cellular/AWS/PCS CDMA Phone with BT
 Serial: 16
 Backlight off
 Duty Cycle: 1:1

Communication System: Cellular CDMA; Frequency: 848.31 MHz;

Measurement Standard: DAS4 (High Precision Assessment)

DAS4 Configuration:

- Probe: H3DV6 - SN6170; Calibrated: 11/20/2007
- Sensor-Surface: (Fix Surface)
- Electronics: DAE4 Sn665; Calibrated: 8/29/2007
- Phantom: HAC; Type: SD HAC P01 BA;
- Measurement SW: DAS4, V4.7 Build 71;

High.ch CDMA/Hearing Aid Compatibility Test (101x101x1):

Measurement grid: dx=5mm, dy=5mm
 Maximum value of peak Total field = 0.108 A/m
 Probe Modulation Factor = 0.808
 Reference Value = 0.076 A/m; Power Drift = -0.065 dB
Hearing Aid Near-Field Category: M4 (AWF 0 dB)

Peak H-field in A/m

Grid 1 0.104 M4	Grid 2 0.074 M4	Grid 3 0.043 M4
Grid 4 0.108 M4	Grid 5 0.076 M4	Grid 6 0.044 M4
Grid 7 0.108 M4	Grid 8 0.076 M4	Grid 9 0.044 M4

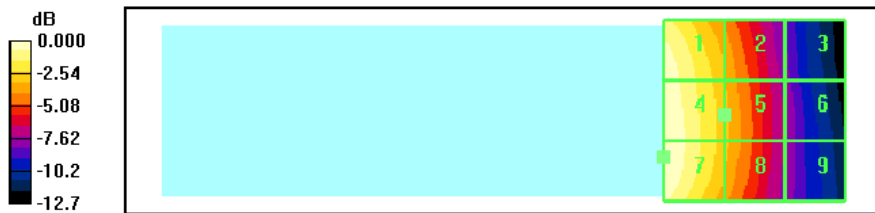

0 dB = 0.108A/m

FCC ID: A3LSCHR550	PCTEST ENGINEERING LABORATORY, INC.	HAC (RF EMISSIONS) TEST REPORT	SAMSUNG	Reviewed by: Quality Manager
HAC Filename: 0808061096.A3L	Test Dates: July 29 - August 5, 2008	EUT Type: Cellular/PCS/AWS CDMA Phone with Bluetooth and EVDO		Page 36 of 77



PCTEST Hearing-Aid Compatibility Facility

DUT: SCH-R550

Type: Cellular/AWS/PCS CDMA Phone with BT

Serial: 16

Backlight off

Duty Cycle: 1:1

Communication System: AWS CDMA; Frequency: 1732.5 MHz;

Measurement Standard: DAS4 (High Precision Assessment)

DAS4 Configuration:

- Probe: H3DV6 - SN6170; Calibrated: 11/20/2007
- Sensor-Surface: (Fix Surface)
- Electronics: DAE4 Sn665; Calibrated: 8/29/2007
- Phantom: HAC; Type: SD HAC P01 BA;
- Measurement SW: DAS4, V4.7 Build 71;

Mid.ch AWS/Hearing Aid Compatibility Test (101x101x1):

Measurement grid: dx=5mm, dy=5mm

Maximum value of peak Total field = 0.089 A/m

Probe Modulation Factor = 0.718

Reference Value = 0.107 A/m; Power Drift = 0.069 dB

Hearing Aid Near-Field Category: M4 (AWF 0 dB)

Peak H-field in A/m

Grid 1 0.089 M4	Grid 2 0.084 M4	Grid 3 0.064 M4
Grid 4 0.089 M4	Grid 5 0.084 M4	Grid 6 0.063 M4
Grid 7 0.089 M4	Grid 8 0.079 M4	Grid 9 0.060 M4

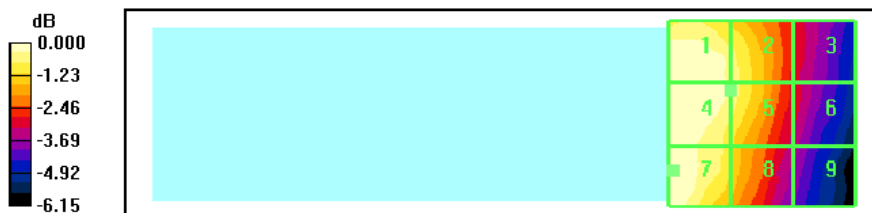

0 dB = 0.089A/m

© 2008 PCTEST

FCC ID: A3LSCHR550	PCTEST ENGINEERING LABORATORY, INC.	HAC (RF EMISSIONS) TEST REPORT	SAMSUNG	Reviewed by: Quality Manager
HAC Filename: 0808061096.A3L	Test Dates: July 29 - August 5, 2008	EUT Type: Cellular/PCS/AWS CDMA Phone with Bluetooth and EVDO		Page 37 of 77



PCTEST Hearing-Aid Compatibility Facility

DUT: SCH-R550

Type: Cellular/AWS/PCS CDMA Phone with BT

Serial: 16

Backlight off

Duty Cycle: 1:1

Communication System: PCS CDMA; Frequency: 1880 MHz;

Measurement Standard: DASY4 (High Precision Assessment)

DASY4 Configuration:

- Probe: H3DV6 - SN6170; Calibrated: 11/20/2007
- Sensor-Surface: (Fix Surface)
- Electronics: DAE4 Sn665; Calibrated: 8/29/2007
- Phantom: HAC; Type: SD HAC P01 BA;
- Measurement SW: DASY4, V4.7 Build 71;

Mid.ch/Hearing Aid Compatibility Test (101x101x1):

Measurement grid: dx=5mm, dy=5mm

Maximum value of peak Total field = 0.115 A/m

Probe Modulation Factor = 0.820

Reference Value = 0.107 A/m; Power Drift = 0.023 dB

Hearing Aid Near-Field Category: M4 (AWF 0 dB)

Peak H-field in A/m

Grid 1 0.099 M4	Grid 2 0.091 M4	Grid 3 0.063 M4
Grid 4 0.109 M4	Grid 5 0.096 M4	Grid 6 0.067 M4
Grid 7 0.115 M4	Grid 8 0.097 M4	Grid 9 0.067 M4

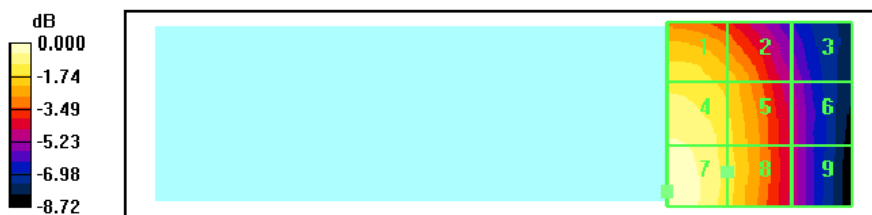



0 dB = 0.115A/m

© 2008 PCTEST

FCC ID: A3LSCHR550	PCTEST ENGINEERING LABORATORY, INC.	HAC (RF EMISSIONS) TEST REPORT	SAMSUNG	Reviewed by: Quality Manager
HAC Filename: 0808061096.A3L	Test Dates: July 29 - August 5, 2008	EUT Type: Cellular/PCS/AWS CDMA Phone with Bluetooth and EVDO		Page 38 of 77

14. CALIBRATION CERTIFICATES

The following pages include the probe calibration used to evaluate HAC for the DUT.

FCC ID: A3LSCHR550		HAC (RF EMISSIONS) TEST REPORT		Reviewed by: Quality Manager
HAC Filename: 0808061096.A3L	Test Dates: July 29 - August 5, 2008	EUT Type: Cellular/PCS/AWS CDMA Phone with Bluetooth and EVDO	Page 39 of 77	



Accredited by the Swiss Accreditation Service (SAS)
The Swiss Accreditation Service is one of the signatories to the EA
Multilateral Agreement for the recognition of calibration certificates

Accreditation No.: SCS 106

Client: **PC Test**

Certificate No: ER3-2335_Nov07

CALIBRATION CERTIFICATE

Object: **ER3DV6 - SN:2335**

Calibration procedure(s): **QA CAL-02.v5
Calibration procedure for E-field probes optimized for close near field
evaluations in air**

Calibration date: **November 20, 2007**

Condition of the calibrated item: **In Tolerance**

This calibration certificate documents the traceability to national standards, which realize the physical units of measurements (SI).
The measurements and the uncertainties with confidence probability are given on the following pages and are part of the certificate.

All calibrations have been conducted in the closed laboratory facility: environment temperature (22 ± 3)°C and humidity < 70%.

Calibration Equipment used (MSTE critical for calibration)

Primary Standards	ID #	Cal Date (Calibrated by, Certificate No.)	Scheduled Calibration
Power meter E4415B	6941280874	29-Mar-07 (METAS, No. 217-00670)	Mar-08
Power sensor E4412A	MY41495277	29-Mar-07 (METAS, No. 217-00670)	Mar-08
Power sensor E4412A	MY41493067	29-Mar-07 (METAS, No. 217-00670)	Mar-08
Reference 3 dB Attenuator	SN: 55051 (3c)	8-Aug-07 (METAS, No. 217-03719)	Aug-08
Reference 20 dB Attenuator	SN: 55086 (20b)	29-Mar-07 (METAS, No. 217-00671)	Mar-08
Reference 30 dB Attenuator	SN: 55126 (30b)	8-Aug-07 (METAS, No. 217-03720)	Aug-08
Reference Probe LR3DV5	SN: 2326	2-Oct-07 (SPEAG, No. ERS-2328_Oct07)	Oct-08
DAE4	SN: 654	20-Apr-07 (SPEAG, No. DAE4-654_Apr07)	Apr-08

Secondary Standards	ID #	Check Date (in house)	Scheduled Check
RF generator HP E648C	US0942001700	4-Aug-09 (SPEAG, in house check Oct-07)	in house check: Oct-09
Network Analyzer HP 8753E	US07350985	18-Oct-01 (SPEAG, in house check Oct-07)	in house check: Oct-06

Calibrated by:	Name	Function	Signature
	Katja Pokovic	Technical Manager	

Approved by:	Name	Function	Signature
	Nils Kusler	Quality Manager	

Issued: November 20, 2007

This calibration certificate shall not be reproduced except in full without written approval of the laboratory.

Certificate No: ER3-2335_Nov07

Page 1 of 9

FCC ID: A3LSCHR550	PCTEST ENGINEERING LABORATORY, INC.	HAC (RF EMISSIONS) TEST REPORT		Reviewed by: Quality Manager
HAC Filename: 0808061096.A3L	Test Dates: July 29 - August 5, 2008	EUT Type: Cellular/PCS/AWS CDMA Phone with Bluetooth and EVDO		Page 40 of 77

**Calibration Laboratory of
Schmid & Partner
Engineering AG**
Zeughausstrasse 43, 8004 Zurich, Switzerland



S Schweizerischer Kalibrierdienst
S Service suisse d'étalonnage
S Servizio svizzero di taratura
S Swiss Calibration Service

Accredited by the Swiss Accreditation Service (SAS)
The Swiss Accreditation Service is one of the signatories to the EA
Multilateral Agreement for the recognition of calibration certificates

Accreditation No.: **SCS 108**

Glossary:

NORM_{x,y,z} sensitivity in free space
DCP diode compression point
Polarization ϕ ϕ rotation around probe axis
Polarization θ θ rotation around an axis that is in the plane normal to probe axis (at measurement center), i.e., $\theta = 0$ is normal to probe axis
Connector Angle information used in DASY system to align probe sensor X to the robot coordinate system

Calibration is Performed According to the Following Standards:

- a) IEEE Std 1309-2005, "IEEE Standard for calibration of electromagnetic field sensors and probes, excluding antennas, from 9 kHz to 40 GHz", December 2005.

Methods Applied and Interpretation of Parameters:

- **NORM_{x,y,z}**: Assessed for E-field polarization $\theta = 0$ for XY sensors and $\theta = 90$ for Z sensor ($f \leq 800$ MHz in TEM-cell; $f > 1800$ MHz: R22 waveguide).
- **NORM_f(_{x,y,z}) = NORM_{x,y,z} * frequency_response** (see Frequency Response Chart).
- **DCP_{x,y,z}**: DCP are numerical linearization parameters assessed based on the data of power sweep (no uncertainty required). DCP does not depend on frequency.
- **Spherical isotropy (3D deviation from isotropy)**: in a locally homogeneous field realized using an open waveguide setup.
- **Sensor Offset**: The sensor offset corresponds to the offset of virtual measurement center from the probe tip (on probe axis). No tolerance required.
- **Connector Angle**: The angle is assessed using the information gained by determining the NORM_x (no uncertainty required).

FCC ID: A3LSCHR550	PCTEST ENGINEERING LABORATORY, INC.	HAC (RF EMISSIONS) TEST REPORT	SAMSUNG	Reviewed by: Quality Manager
HAC Filename: 0808061096.A3L	Test Dates: July 29 - August 5, 2008	EUT Type: Cellular/PCS/AWS CDMA Phone with Bluetooth and EVDO		Page 41 of 77



Probe ER3DV6

SN:2335

Manufactured: May 31, 2006
 Last calibrated: July 10, 2006
 Recalibrated: November 20, 2007

Calibrated for DASY Systems

(Note: non-compatible with DASY2 system!)

FCC ID: A3LSCHR550		HAC (RF EMISSIONS) TEST REPORT		Reviewed by: Quality Manager
HAC Filename: 0808061096.A3L	Test Dates: July 29 - August 5, 2008	EUT Type: Cellular/PCS/AWS CDMA Phone with Bluetooth and EVDO	Page 42 of 77	

DASY - Parameters of Probe: ER3DV6 SN:2335

Sensitivity in Free Space [$\mu\text{V}/(\text{V}/\text{m})^2$]		Diode Compression ^A	
NormX	1.64 ± 10.1 % (k=2)	DCP X	93 mV
NormY	1.67 ± 10.1 % (k=2)	DCP Y	93 mV
NormZ	1.92 ± 10.1 % (k=2)	DCP Z	96 mV

Frequency Correction

X	0.0
Y	0.0
Z	0.0



Sensor Offset (Probe Tip to Sensor Center)

X	2.5 mm
Y	2.5 mm
Z	2.5 mm

Connector Angle -285 °

The reported uncertainty of measurement is stated as the standard uncertainty of measurement multiplied by the coverage factor k=2, which for a normal distribution corresponds to a coverage probability of approximately 95%.

^A numerical linearization parameter, in case it is not required

FCC ID: A3LSCHR550		HAC (RF EMISSIONS) TEST REPORT		Reviewed by: Quality Manager
HAC Filename: 0808061096.A3L	Test Dates: July 29 - August 5, 2008	EUT Type: Cellular/PCS/AWS CDMA Phone with Bluetooth and EVDO		Page 43 of 77

Frequency Response of E-Field

(TEM-Cell: Hf110 EXX, Waveguide R22)

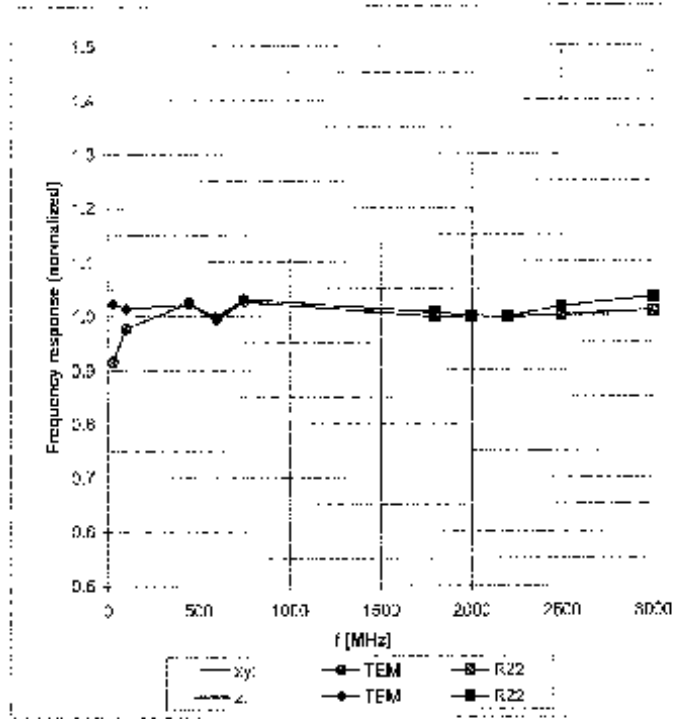

Uncertainty of Frequency Response of E-field: $\pm 5.3\%$ ($k=2$)

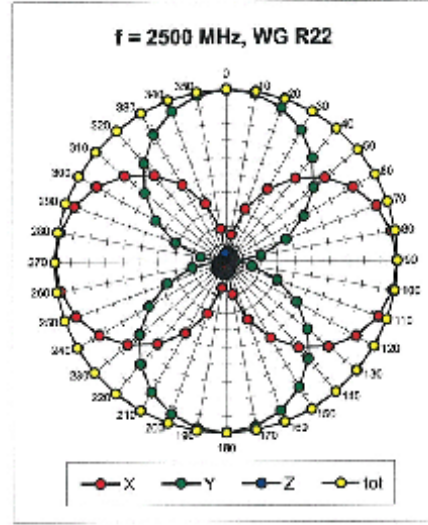
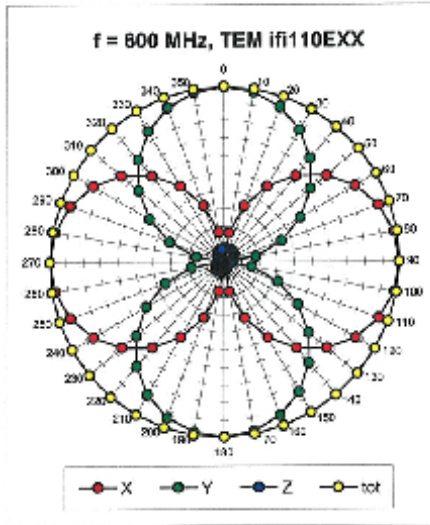

FCC ID: A3LSCHR550		HAC (RF EMISSIONS) TEST REPORT		Reviewed by: Quality Manager
HAC Filename: 0808061096.A3L	Test Dates: July 29 - August 5, 2008	EUT Type: Cellular/PCS/AWS CDMA Phone with Bluetooth and EVDO		Page 44 of 77

Receiving Pattern (ϕ), $\vartheta = 0^\circ$

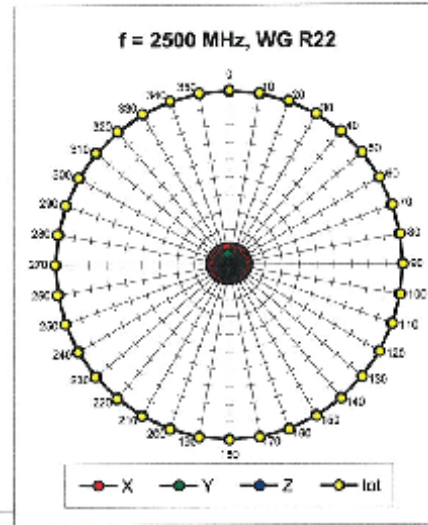
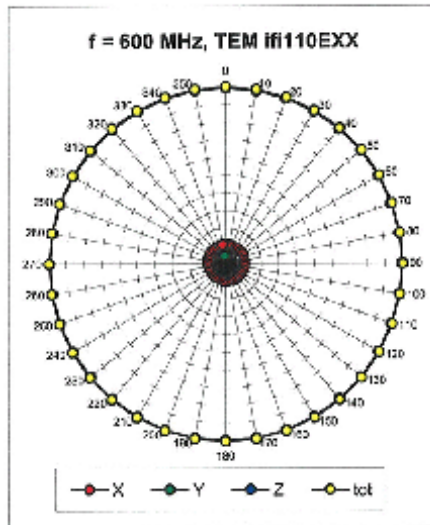

Receiving Pattern (ϕ), $\vartheta = 90^\circ$



<p>FCC ID: A3LSCHR550</p>		<p>HAC (RF EMISSIONS) TEST REPORT</p> 	<p>Reviewed by: Quality Manager</p>
<p>HAC Filename: 0808061096.A3L</p>	<p>Test Dates: July 29 - August 5, 2008</p>	<p>EUT Type: Cellular/PCS/AWS CDMA Phone with Bluetooth and EVDO</p>	<p>Page 45 of 77</p>

Receiving Pattern (ϕ), $\theta = 0^\circ$

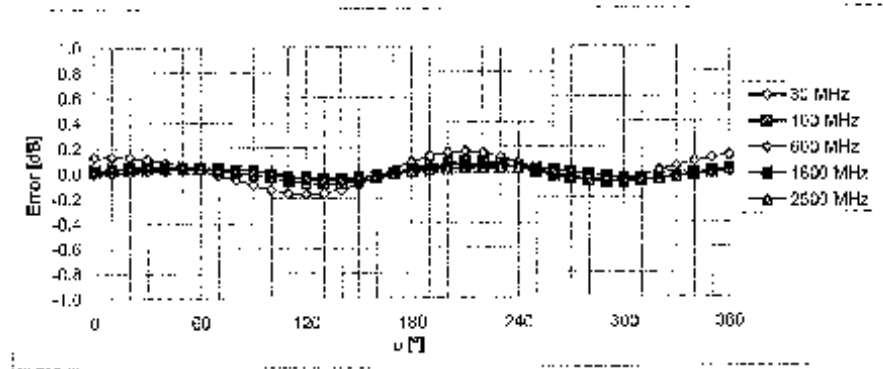

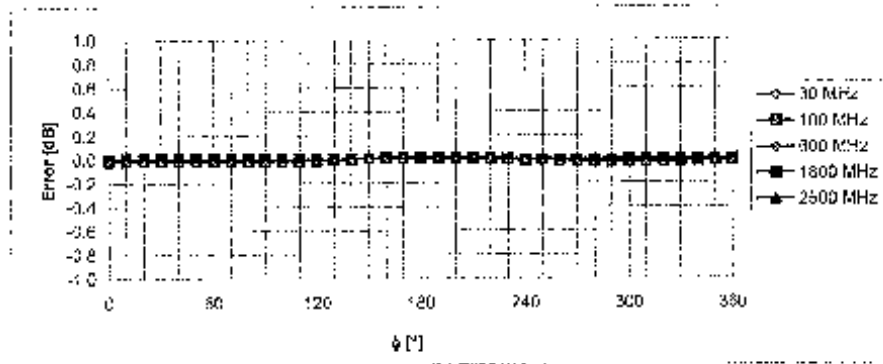

Uncertainty of Axial Isotropy Assessment: $\pm 0.5\%$ ($k=2$)

Receiving Pattern (ϕ), $\theta = 90^\circ$



Uncertainty of Axial Isotropy Assessment: $\pm 0.5\%$ ($k=2$)

FCC ID: A3LSCHR550		HAC (RF EMISSIONS) TEST REPORT		Reviewed by: Quality Manager
HAC Filename: 0808061096.A3L	Test Dates: July 29 - August 5, 2008	EUT Type: Cellular/PCS/AWS CDMA Phone with Bluetooth and EVDO		Page 46 of 77

Dynamic Range f(E-field) (Waveguide R22, f = 1800 MHz)

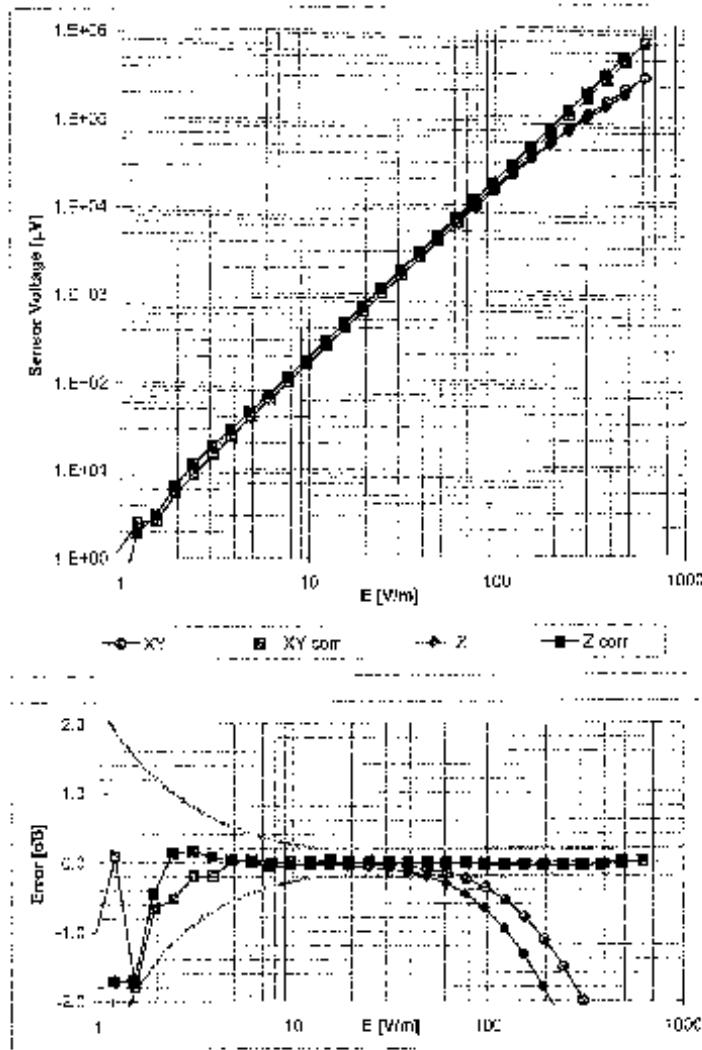

Uncertainty of Linearity Assessment: $\pm 0.6\%$ (k=2)

FCC ID: A3LSCHR550	PCTEST ENGINEERING LABORATORY, INC.	HAC (RF EMISSIONS) TEST REPORT	SAMSUNG	Reviewed by: Quality Manager
HAC Filename: 0808061096.A3L	Test Dates: July 29 - August 5, 2008	EUT Type: Cellular/PCS/AWS CDMA Phone with Bluetooth and EVDO		Page 47 of 77

Deviation from Isotropy in Air Error (ϕ , θ), $f = 900$ MHz

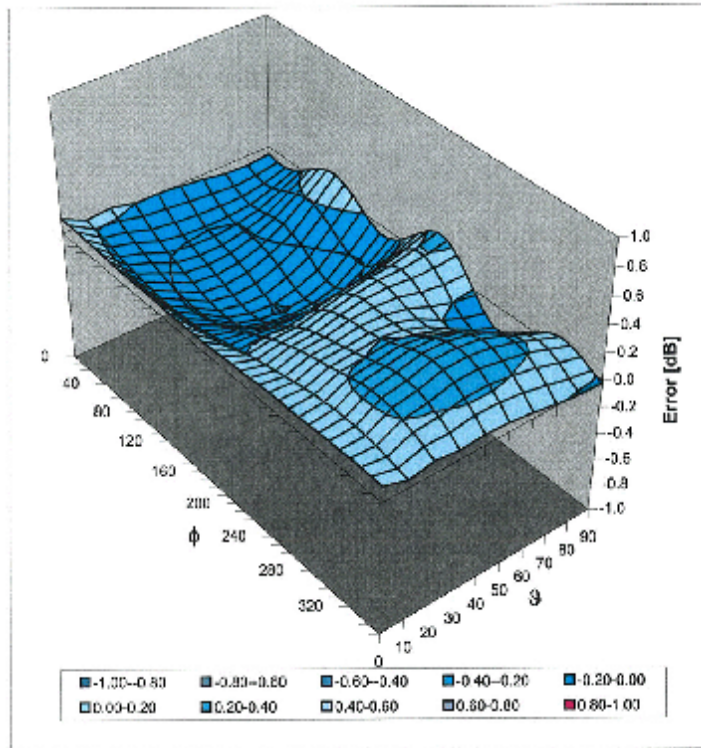

Uncertainty of Spherical Isotropy Assessment: $\pm 2.6\%$ (k=2)

FCC ID: A3LSCHR550	PCTEST ENGINEERING LABORATORY, INC.	HAC (RF EMISSIONS) TEST REPORT	SAMSUNG	Reviewed by: Quality Manager
HAC Filename: 0808061096.A3L	Test Dates: July 29 - August 5, 2008	EUT Type: Cellular/PCS/AWS CDMA Phone with Bluetooth and EVDO		Page 48 of 77



Accredited by the Swiss Accreditation Service (SAS)
The Swiss Accreditation Service is one of the signatories to the EA
Multilateral Agreement for the recognition of calibration certificates

Accreditation No.: **SCS 108**

Client **PC Test**

Certificate No: **H3-6170_Nov07**

CALIBRATION CERTIFICATE

Object: **H3DV6 - SN:6170**

Calibration procedure(s): **QA CAL-03.v5
Calibration procedure for H-field probes optimized for close near field
evaluations in air**

Calibration date: **November 20, 2007**

Condition of the calibrated item: **In Tolerance**

This calibration certificate documents the traceability to national standards, which realize the physical units of measurements (SI).
The measurements and the uncertainties with confidence probability are given on the following pages and are part of the certificate.

All calibrations have been conducted in the closed laboratory facility: environment temperature (22 ± 3)°C and humidity < 70%.

Calibration Equipment used (M&TE critical for calibration)

Primary Standards	ID #	Cal Date (Calibrated by, Certificate No.)	Scheduled Calibration
Power meter E4415B	GB41293874	29-Mar-07 (METAS, No. 217-00670)	Mar-08
Power sensor E4412A	MY41495277	29-Mar-07 (METAS, No. 217-00670)	Mar-08
Power sensor E4412A	MY41498087	29-Mar-07 (METAS, No. 217-00670)	Mar-08
Reference 3 dB Attenuator	SN: S5054 (3c)	8-Aug-07 (METAS, No. 217-00719)	Aug-08
Reference 20 dB Attenuator	SN: S5086 (20b)	29-Mar-07 (METAS, No. 217-00671)	Mar-08
Reference 30 dB Attenuator	SN: S5129 (30b)	8-Aug-07 (METAS, No. 217-00720)	Aug-08
Reference Probe H3DV6	SN: 6182	2-Oct-07 (SPEAG, No. H3-6182_Oct07)	Oct-08
DAE4	SN: 654	20-Apr-07 (SPEAG, No. DAE4-654_Apr07)	Apr-08

Secondary Standards	ID #	Check Date (in house)	Scheduled Check
RF generator HP 0646C	US3642U01700	4-Aug-09 (SPEAG, in house check Oct-07)	In house check: Oct-09
Network Analyzer HP 8753E	US37390585	16-Oct-01 (SPEAG, in house check Oct-07)	In house check: Oct-08

	Name	Function	Signature
Calibrated by:	Katja Pokovic	Technical Manager	
Approved by:	Nils Kuster	Quality Manager	

Issued: November 20, 2007

This calibration certificate shall not be reproduced except in full without written approval of the laboratory.

FCC ID: A3LSCHR550	PCTEST ENGINEERING LABORATORY, INC.	HAC (RF EMISSIONS) TEST REPORT		Reviewed by: Quality Manager
HAC Filename: 0808061096.A3L	Test Dates: July 29 - August 5, 2008	EUT Type: Cellular/PCS/AWS CDMA Phone with Bluetooth and EVDO		Page 49 of 77

**Calibration Laboratory of
Schmid & Partner
Engineering AG**
Zeughausstrasse 43, 8004 Zurich, Switzerland



S Schweizerischer Kalibrierdienst
C Service suisse d'étalonnage
S Servizio svizzero di taratura
S Swiss Calibration Service

Accredited by the Swiss Accreditation Service (SAS)
The Swiss Accreditation Service is one of the signatories to the EA
Multilateral Agreement for the recognition of calibration certificates

Accreditation No.: **SCS 108**

Glossary:

NORM_{x,y,z} sensitivity in free space
DCP diode compression point
Polarization φ φ rotation around probe axis
Polarization θ θ rotation around an axis that is in the plane normal to probe axis (at measurement center), i.e., $\theta = 0$ is normal to probe axis
Connector Angle information used in DASY system to align probe sensor X to the robot coordinate system

Calibration is Performed According to the Following Standards:

- a) IEEE Std 1309-2005, "IEEE Standard for calibration of electromagnetic field sensors and probes, excluding antennas, from 9 kHz to 40 GHz", December 2005.

Methods Applied and Interpretation of Parameters:

- **X,Y,Z_{a0a1a2}**: Assessed for E-field polarization $\theta = 90$ for XY sensors and $\theta = 0$ for Z sensor ($f \leq 900$ MHz in TEM-cell; $f > 1800$ MHz: R22 waveguide).
- **X,Y,Z(f)_{a0a1a2}**= X,Y,Z_{a0a1a2}* *frequency_response* (see Frequency Response Chart).
- **DCP_{x,y,z}**: DCP are numerical linearization parameters assessed based on the data of power sweep (no uncertainty required). DCP does not depend on frequency.
- **Spherical isotropy (3D deviation from isotropy)**: in a locally homogeneous field realized using an open waveguide setup.
- **Sensor Offset**: The sensor offset corresponds to the offset of virtual measurement center from the probe tip (on probe axis). No tolerance required.
- **Connector Angle**: The angle is assessed using the information gained by determining the X_{a0a1a2} (no uncertainty required).

FCC ID: A3LSCHR550	PCTEST ENGINEERING LABORATORY, INC.	HAC (RF EMISSIONS) TEST REPORT		Reviewed by: Quality Manager
HAC Filename: 0808061096.A3L	Test Dates: July 29 - August 5, 2008	EUT Type: Cellular/PCS/AWS CDMA Phone with Bluetooth and EVDO		Page 50 of 77



Probe H3DV6

SN:6170

Manufactured:	May 19, 2005
Last calibrated:	October 13, 2006
Recalibrated:	November 20, 2007

Calibrated for DASY Systems

(Ncte: non-compatible with DASY2 system!)

FCC ID: A3LSCHR550		HAC (RF EMISSIONS) TEST REPORT	 Reviewed by: Quality Manager
HAC Filename: 0808061096.A3L	Test Dates: July 29 - August 5, 2008	EUT Type: Cellular/PCS/AWS CDMA Phone with Bluetooth and EVDO	Page 51 of 77

DASY - Parameters of Probe: H3DV6 SN:6170

Sensitivity in Free Space [A/m / $\sqrt{(\mu V)}$]

	a0	a1	a2
X	2.494E-03	1.205E-4	1.608E-6 ± 5.1 % (k=2)
Y	2.631E-03	5.696E-6	-2.557E-5 ± 5.1 % (k=2)
Z	2.954E-03	-6.796E-5	2.893E-5 ± 5.1 % (k=2)

Diode Compression¹

DGP X	85 mV
DGP Y	85 mV
DGP Z	86 mV



Sensor Offset (Probe Tip to Sensor Center)

X	3.0 mm
Y	3.0 mm
Z	3.0 mm

Connector Angle -358 °

The reported uncertainty of measurement is stated as the standard uncertainty of measurement multiplied by the coverage factor k=2, which for a normal distribution corresponds to a coverage probability of approximately 95%.

¹ numerical linearization parameter uncertainty not required

FCC ID: A3LSCHR550		HAC (RF EMISSIONS) TEST REPORT		Reviewed by: Quality Manager
HAC Filename: 0808061096.A3L	Test Dates: July 29 - August 5, 2008	EUT Type: Cellular/PCS/AWS CDMA Phone with Bluetooth and EVDO	Page 52 of 77	

Frequency Response of H-Field (TEM-Cell:ifi110, Waveguide R22)

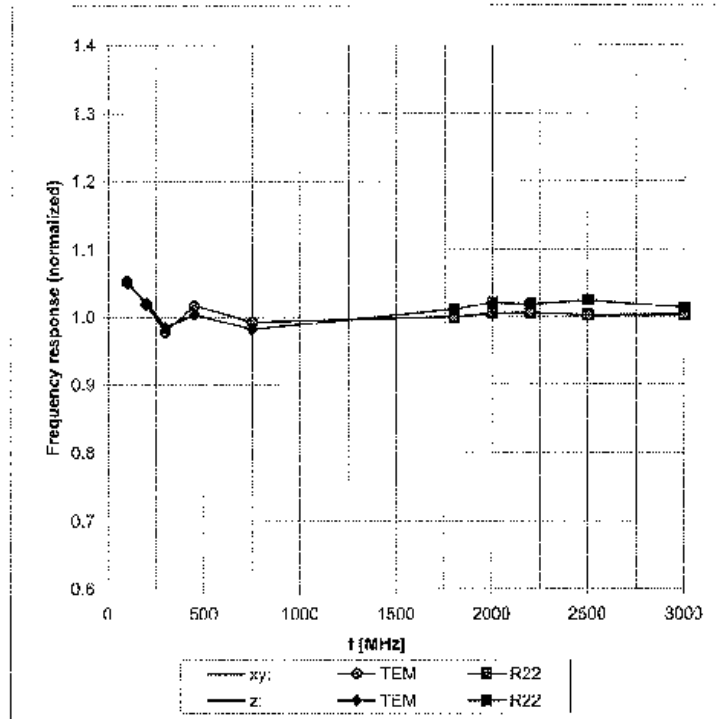

Uncertainty of Frequency Response of E-field: $\pm 6.3\%$ ($k=2$)

FCC ID: A3LSCHR550		HAC (RF EMISSIONS) TEST REPORT		Reviewed by: Quality Manager
HAC Filename: 0808061096.A3L	Test Dates: July 29 - August 5, 2008	EUT Type: Cellular/PCS/AWS CDMA Phone with Bluetooth and EVDO		Page 53 of 77

Receiving Pattern (ϕ), $\theta = 90^\circ$

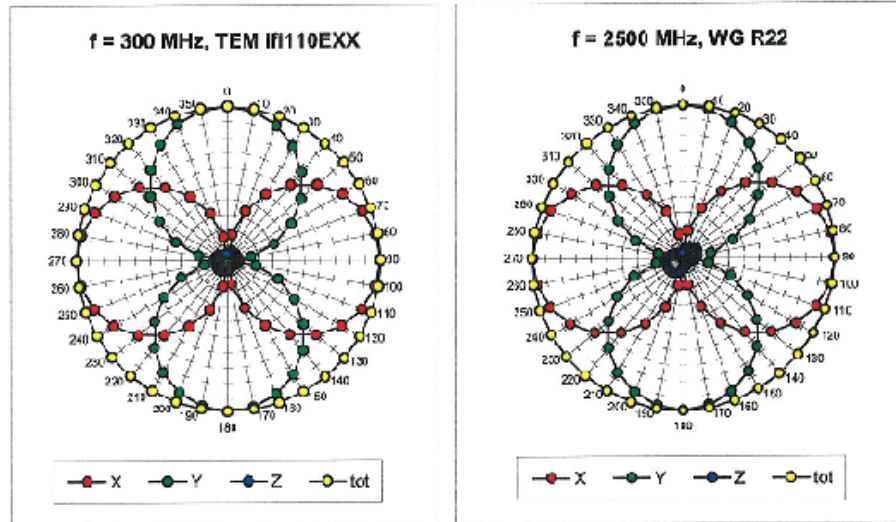

Receiving Pattern (ϕ), $\theta = 0^\circ$

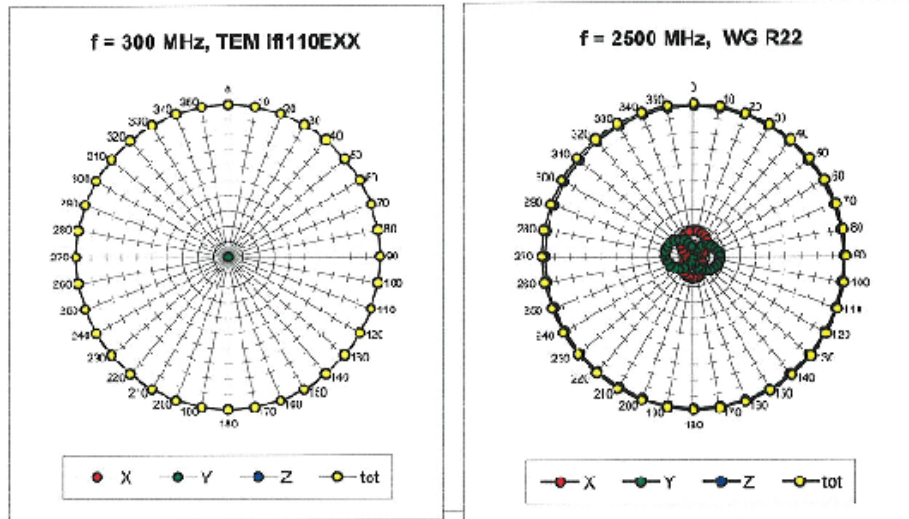

FCC ID: A3LSCHR550		HAC (RF EMISSIONS) TEST REPORT		Reviewed by: Quality Manager
HAC Filename: 0808061096.A3L	Test Dates: July 29 - August 5, 2008	EUT Type: Cellular/PCS/AWS CDMA Phone with Bluetooth and EVDO		Page 54 of 77

Receiving Pattern (ϕ), $\theta = 90^\circ$

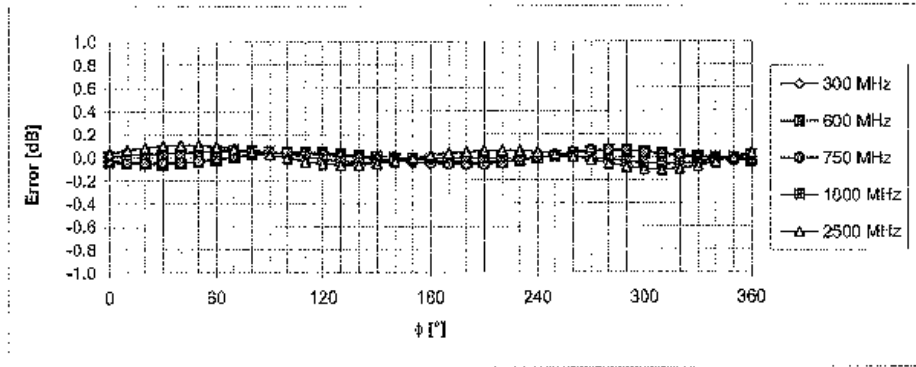

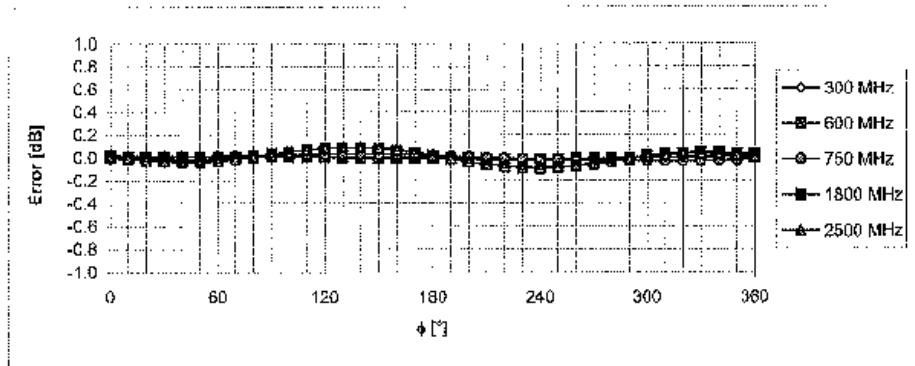

Uncertainty of Axial Isotropy Assessment: $\pm 0.5\%$ ($k=2$)

Receiving Pattern (ϕ), $\theta = 0^\circ$





Uncertainty of Axial Isotropy Assessment: $\pm 0.5\%$ ($k=2$)

FCC ID: A3LSCHR550		HAC (RF EMISSIONS) TEST REPORT		Reviewed by: Quality Manager
HAC Filename: 0808061096.A3L	Test Dates: July 29 - August 5, 2008	EUT Type: Cellular/PCS/AWS CDMA Phone with Bluetooth and EVDO		Page 55 of 77

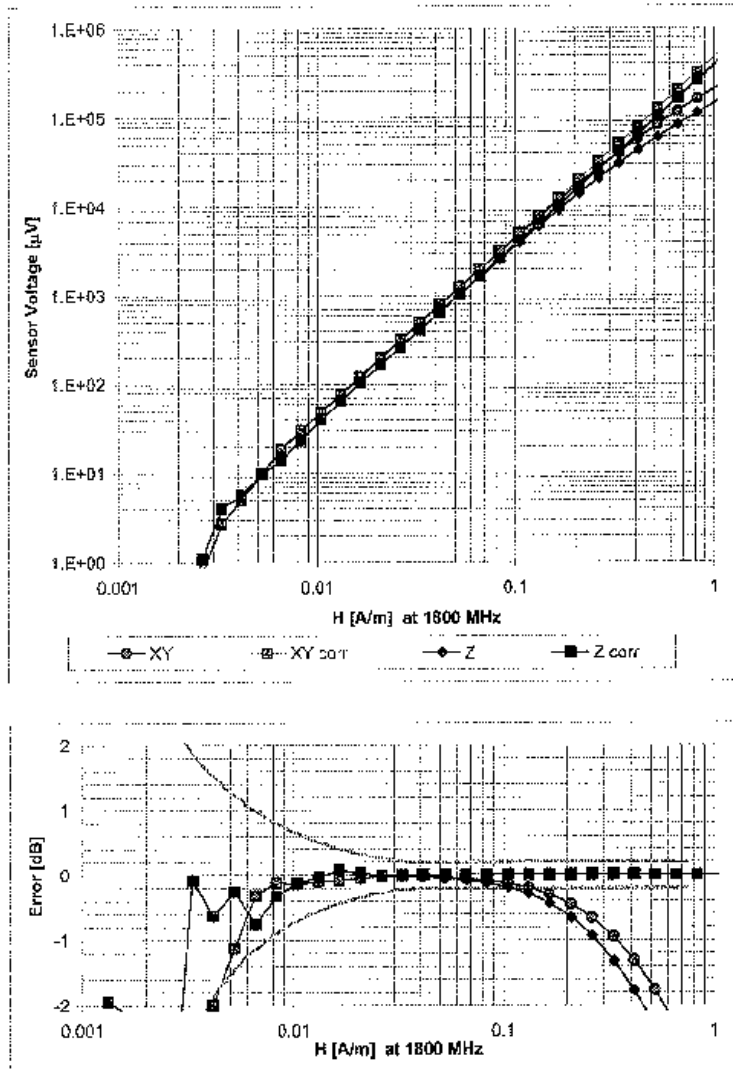
Dynamic Range f(H-field) (Waveguide R22, f = 1800 MHz)



Uncertainty of Linearity Assessment: $\pm 0.6\%$ ($k=2$)

FCC ID: A3LSCHR550		HAC (RF EMISSIONS) TEST REPORT		Reviewed by: Quality Manager
HAC Filename: 0808061096.A3L	Test Dates: July 29 - August 5, 2008	EUT Type: Cellular/PCS/AWS CDMA Phone with Bluetooth and EVDO		Page 56 of 77

**Calibration Laboratory of
Schmid & Partner
Engineering AG**
Zeughausstrasse 43, 8004 Zurich, Switzerland



S Schweizerischer Kalibrierdienst
S Service suisse d'étalonnage
C Servizio svizzero di taratura
S Swiss Calibration Service

Accredited by the Swiss Federal Office of Metrology and Accreditation
The Swiss Accreditation Service is one of the signatories to the EA
Multilateral Agreement for the recognition of calibration certificates

Accreditation No.: **SCS 108**

Client **PC Test**

Certificate No: **CD835V3-1003_Jan07**

CALIBRATION CERTIFICATE

Object **CD835V3 - SN: 1003**

Calibration procedure(s) **QA CAL-20.v4
Calibration procedure for dipoles in air**

Calibration date: **January 16, 2007**

Condition of the calibrated item **In Tolerance**

This calibration certificate documents the traceability to national standards, which realize the physical units of measurements (SI).
All calibrations have been conducted in the closed laboratory facility: environment temperature (22 ± 3)°C and humidity < 70%.

Calibration Equipment used (M&TE critical for calibration)

Primary Standards	ID #	Cal Date (Calibrated by, Certificate No.)	Scheduled Calibration
DAE4	SN: 660	1-Mar-06 (SPEAG, No. DAE4-660_Mar06)	Calibration, Mar-07
Probe ER3DV6	SN: 2336	20-Dec-05 (SPEAG, No. ER3-2336_Dec05)	Calibration, Dec-07
Probe H3DV6	SN: 6065	20-Dec-05 (SPEAG, No. H3-6065-Dec05)	Calibration, Dec-07
Secondary Standards	ID #	Check Date (in house)	Scheduled Check
Power meter EPM-4419B	GB43310788	12-Aug-03 (SPEAG, in house check Oct-06)	in house check: Oct-07
Power sensor HP 8481A	MY41063312	10-Aug-03 (SPEAG, in house check Oct-06)	in house check: Oct-06
Power sensor HP 8481A	MY41063315	10-Aug-03 (SPEAG, in house check Oct-06)	in house check: Oct-06
Network Analyzer HP 8753E	US37390565	18-Oct-01 (SPEAG, in house check Oct-06)	in house check: Oct-07
RF generator R&S SMT06	SN: 100035	26-Jul-04 (SPEAG, in house check Nov-05)	in house check: Nov-07

Calibrated by:	Name: Mike Meil	Function: Laboratory Technician	Signature: <i>M. Meil</i>
Approved by:	Name: Fin Bomholt	Function: Technical Director	Signature: <i>F. Bomholt</i>

Issued: March 8, 2007

This calibration certificate shall not be reproduced except in full without written approval of the laboratory.

Certificate No: CD835V3-1003_Jan07

Page 1 of 6

FCC ID: A3LSCHR550	PCTEST ENGINEERING LABORATORY, INC.	HAC (RF EMISSIONS) TEST REPORT		Reviewed by: Quality Manager
HAC Filename: 0808061096.A3L	Test Dates: July 29 - August 5, 2008	EUT Type: Cellular/PCS/AWS CDMA Phone with Bluetooth and EVDO		Page 57 of 77



Accredited by the Swiss Federal Office of Metrology and Accreditation
The Swiss Accreditation Service is one of the signatories to the EA
Multilateral Agreement for the recognition of calibration certificates

Accreditation No.: SCS 108

References

- [1] ANSI-PC83.19-2001 (Draft 3.x, 2005)
American National Standard for Methods of Measurement of Compatibility between Wireless Communications Devices and Hearing Aids.

Methods Applied and Interpretation of Parameters:

- **Coordinate System:** y-axis is in the direction of the dipole arms. z-axis is from the basis of the antenna (mounted on the table) towards its feed point between the two dipole arms. x-axis is normal to the other axes. In coincidence with standard [1], the measurement planes (probe sensor center) are selected to be at a distance of 10 mm above the top edge of the dipole arms.
- **Measurement Conditions:** Further details are available from the handbooks at the end of the cert. file. All figures stated in the certificate are valid at the frequency indicated. The forward power to the dipole connector is set with a calibrated power meter connected and monitored with an auxiliary power meter connected to a directional coupler. While the dipole under test is connected, the forward power is adjusted to the same level.
- **Antenna Positioning:** The dipole is mounted on a HAC Test Arch phantom using the matching dipole positioner with the arms horizontal and the feeding cable coming from the floor. The measurements are performed in a shielded room with absorbers around the setup to reduce the reflections. It is verified before the mounting of the dipole under the Test Arch phantom, that its arms are perfectly in a line. It is installed on the HAC dipole positioner with its arms parallel below the dielectric reference wire and able to move elastically in vertical direction without changing its relative position to the top center of the Test Arch phantom. The vertical distance to the probe is adjusted after dipole mounting with a DASY4 Surface Check job. Before the measurement, the distance between phantom surface and probe tip is verified. The proper measurement distance is selected by choosing the matching section of the HAC Test Arch phantom with the proper device reference point (upper surface of the dipole) and the matching grid reference point (tip of the probe) considering the probe sensor offset. The vertical distance to the probe is essential for the accuracy.
- **Feed Point Impedance and Return Loss:** These parameters are measured using a HP 8753E Vector Network Analyzer. The impedance is specified at the SMA connector of the dipole. The influence of reflections was eliminated by applying the averaging function while moving the cup in the air, at least 70cm away from any obstacles.
- **E-field distribution:** E-field is measured in the x-y-plane with an isotropic ER3D-field probe with 100 mW forward power to the antenna feed point. In accordance with [1], the scan area is 20mm wide, its length exceeds the dipole arm length (180 or 90mm). The sensor center is 10 mm (in Z) above the top of the dipole arms. Two 3D maxima are available near the end of the dipole arms. Assuming the dipole arms are perfectly in a line, the average of these two maxima (in subgrid 2 and subgrid 3) is determined to compensate for any non-perfectity to the measurement plane as well as the sensor displacement. The E-field value stated as calibration value represents the maximum of the irradiated 3D-E-field, 10mm above the dipole surface.
- **H-field distribution:** H-field is measured with an isotropic H-field probe with 100mW forward power to the antenna feed point, in the x-y-plane. The scan area and sensor distance is equivalent to the E-field scan. The maximum of the field is available at the center (subgrid 5) above the feed point. The H-field value stated as calibration value represents the maximum of the interpolated H-field, 10mm above the dipole surface at the feed point.

FCC ID: A3LSCHR550	PCTEST ENGINEERING LABORATORY, INC.	HAC (RF EMISSIONS) TEST REPORT	SAMSUNG	Reviewed by: Quality Manager
HAC Filename: 0808061096.A3L	Test Dates: July 29 - August 5, 2008	EUT Type: Cellular/PCS/AWS CDMA Phone with Bluetooth and EVDO		Page 58 of 77

1 Measurement Conditions

DASY system configuration, see far as not given on page 1.

DASY Version	DASY4	V4.7 B53
DASY PP Version	SEMCAD	V1.8 R172
Phantom	HAC Test Arch	SD-HAC P01 BA, #1002
Distance Dipole Top - Probe Center	10 mm	
Scan resolution	dx, dy = 5 mm	area = 20 x 180 mm ²
Frequency	835 MHz ± 1 MHz	
Forward power at dipole connector	20.0 dBm = 100mW	
Input power drift	< 0.05 dB	

2 Maximum Field values

H-field 10 mm above dipole surface	condition	interpolated maximum
Maximum measured	100 mW forward power	0.445 A/m

Uncertainty for H-field measurement: 8.2% (k=2)

E-field 10 mm above dipole surface	condition	interpolated maximum
Maximum measured above high end	100 mW forward power	164.9 V/m
Maximum measured above low end	100 mW forward power	162.3 V/m
Averaged maximum above arm	100 mW forward power	163.6 V/m

Uncertainty for E-field measurement: 12.8% (k=2)

3 Appendix

3.1 Antenna Parameters

Frequency	Return Loss	Impedance
800 MHz	18.2 dB	(44.5 - j10.4) Ohm
835 MHz	26.6 dB	(52.0 + j4.3) Ohm
900 MHz	15.8 dB	(57.5 - j15.9) Ohm
950 MHz	22.2 dB	(48.3 - j7.5) Ohm
960 MHz	16.9 dB	(57.4 - j15.7) Ohm



3.2 Antenna Design and Handling

The calibration dipole has a symmetric geometry with a built-in two stub matching network, which leads to the enhanced bandwidth.

The dipole is built of standard semirigid coaxial cable. The internal matching line is open ended. The antenna is therefore open for DC signals.

Do not apply force to dipole arms, as they are liable to bend. The soldered connections near the feedpoint may be damaged. After excessive mechanical stress or overheating, check the impedance characteristics to ensure that the internal matching network is not affected.

After long term use with 40W radiated power, only a slight warming of the dipole near the feedpoint can be measured.

FCC ID: A3LSCHR550		HAC (RF EMISSIONS) TEST REPORT		Reviewed by: Quality Manager
HAC Filename: 0808061096.A3L	Test Dates: July 29 - August 5, 2008	EUT Type: Cellular/PCS/AWS CDMA Phone with Bluetooth and EVDO		Page 59 of 77

3.3 Measurement Sheets

3.3.1 Return Loss and Smith Chart

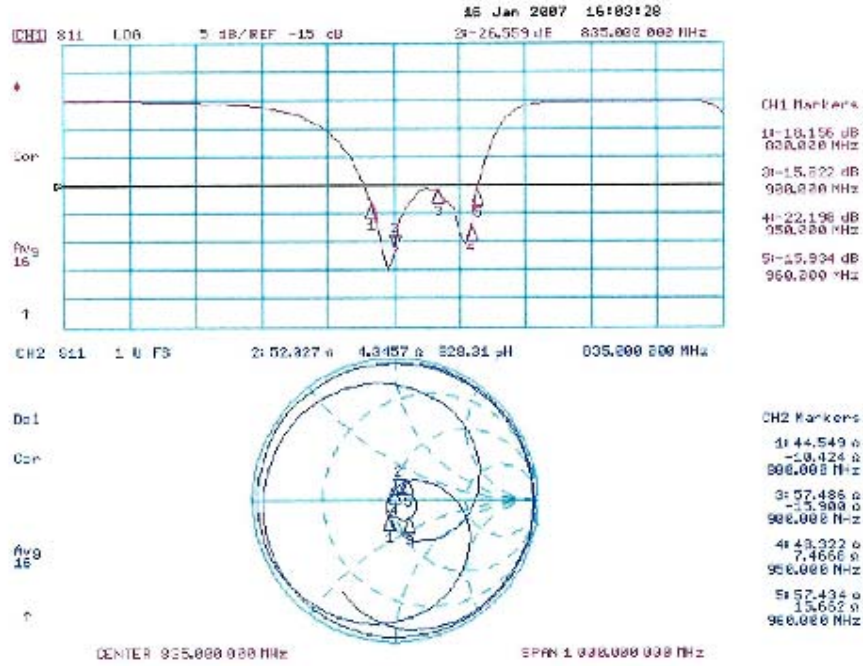

FCC ID: A3LSCHR550	PCTEST ENGINEERING LABORATORY, INC.	HAC (RF EMISSIONS) TEST REPORT	SAMSUNG	Reviewed by: Quality Manager
HAC Filename: 0808061096.A3L	Test Dates: July 29 - August 5, 2008	EUT Type: Cellular/PCS/AWS CDMA Phone with Bluetooth and EVDO		Page 60 of 77

3.3.2 DASY4 H-Field Result

Date/Time: 1/15/2007 10:56:23 AM

Test Laboratory: SPBAG, Zurich, Switzerland

DUT: HAC-Dipole 835 MHz; Type: CD835V3; Serial: 1003

Communication System: CW; Frequency: 835 MHz; Duty Cycle: 1:1

Medium: Air

Medium parameters used: $\sigma = 0 \text{ mho/m}$, $\epsilon_r = 1$; $\rho = 1 \text{ kg/m}^3$

Phantom section: H Dipole Section

DASY4 Configuration:

- Probe: H3DV6 - SN6065; Calibrated: 12/27/2006
- Sensor-Surface: (Fix Surface)
- Electronics: DAE4 Sn660; Calibrated: 3/1/2006
- Phantom: HAC Test Arch 4.6; Type: SD HAC P01 BA; Serial: 1002
- Measurement SW: DASY4, V4.7 Build 53; Postprocessing SW: SFMCAD, V1.8 Build 172

H Scan - Sensor Center 10mm above CD835 Dipole/Hearing Aid Compatibility Test (41x361x1):

Measurement grid: dx=5mm, dy=5mm

Maximum value of peak Total field = 0.445 A/m

Probe Modulation Factor = 1.00

Reference Value = 0.470 A/m; Power Drift = 0.005 dB



Hearing Aid Near-Field Category: M2 (AWF 0 dB)

Peak H-field in A/m

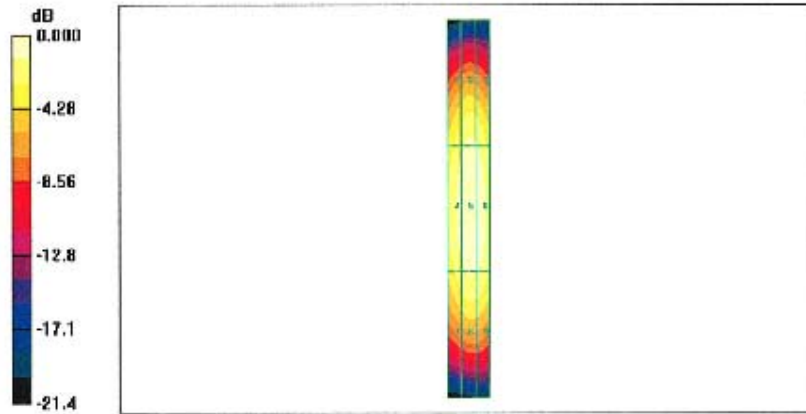
Grid 1	Grid 2	Grid 3
0.363	0.395	0.382
Grid 4	Grid 5	Grid 6
0.410	0.445	0.433
Grid 7	Grid 8	Grid 9
0.353	0.385	0.378



0 dB = 0.445A/m

FCC ID: A3LSCHR550	 PCTEST ENGINEERING LABORATORY, INC.	HAC (RF EMISSIONS) TEST REPORT		Reviewed by: Quality Manager
HAC Filename: 0808061096.A3L	Test Dates: July 29 - August 5, 2008	EUT Type: Cellular/PCS/AWS CDMA Phone with Bluetooth and EVDO		Page 61 of 77

3.3.3 DASY4 E-Field Result

Date/Time: 1/15/2007 6:33:37 PM

Test Laboratory: SPLAG, Zurich, Switzerland

DUT: HAC-Dipole 835 MHz; Type: D835V3; Serial: 1003

Communication System: CW; Frequency: 835 MHz; Duty Cycle: 1:1

Medium: Air

Medium parameters used: $\sigma = 0$ mho/m, $\epsilon_r = 1$; $\rho = 1000$ kg/m³

Phantom section: F Dipole Section

DASY4 Configuration:

- Probe: ER3DV6 - SN2336; Core#(1, 1, 1), Calibrated: 12/27/2006
- Sensor-Surface: (Fix Surface)
- Electronics: DAE4 Sn660; Calibrated: 3/1/2006
- Phantom: HAC Test Arch 4.6; Type: SD HAC P01 BA; Serial: 1002
- Measurement SW: DASY4, V4.7 Build 53; Postprocessing SW: SEMCAD, V1.8 Build 172

E Scan - Sensor Center 10mm above CD835 Dipole/Hearing Aid Compatibility Test (41x361x1):

Measurement grid: dx=5mm, dy=5mm

Maximum value of peak Total field = 164.9 V/m

Probe Modulation Factor = 1.00

Reference Value = 106.0 V/m; Power Drift = 0.017 dB



Hearing Aid Near-Field Category: M4 (AWF 0 dB)

Peak E-field in V/m

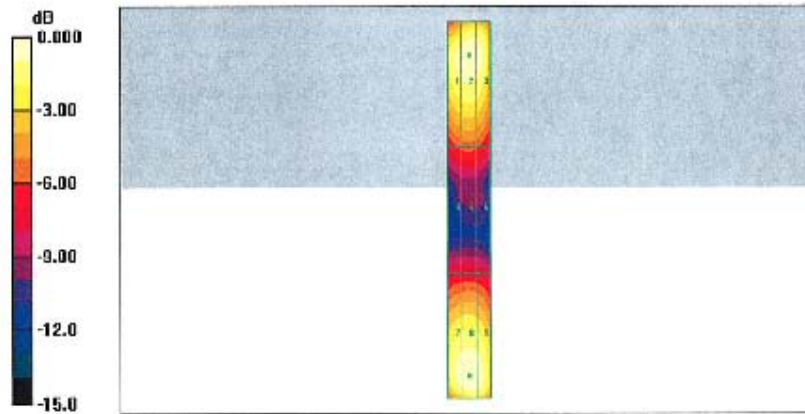
Grid 1	Grid 2	Grid 3
157.3	162.3	157.7
Grid 4	Grid 5	Grid 6
86.2	87.9	85.4
Grid 7	Grid 8	Grid 9
159.2	164.9	160.2



0 dB = 164.9V/m

FCC ID: A3LSCHR550	 PCTEST ENGINEERING LABORATORY, INC.	HAC (RF EMISSIONS) TEST REPORT		Reviewed by: Quality Manager
HAC Filename: 0808061096.A3L	Test Dates: July 29 - August 5, 2008	EUT Type: Cellular/PCS/AWS CDMA Phone with Bluetooth and EVDO		Page 62 of 77



Accredited by the Swiss Accreditation Service (SAS)
The Swiss Accreditation Service is one of the signatories to the EA
Multilateral Agreement for the recognition of calibration certificates

Accreditation No.: **SCS 108**

Client **PC Test**

Certificate No: **CD1880V3-1064_Mar08**

CALIBRATION CERTIFICATE

Object **CD1880V3 - SN: 1064**

Calibration procedure(s) **QA CAL-20.v4
Calibration procedure for dipoles in air**

Calibration date: **March 11, 2008**

Condition of the calibrated item **In Tolerance**

This calibration certificate documents the traceability to national standards, which realize the physical units of measurements (SI).
All calibrations have been conducted in the closed laboratory facility: environment temperature (22 ± 3)°C and humidity < 70%.

Calibration Equipment used (M&TE critical for calibration)

Primary Standards	ID #	Cal Date (Calibrated by, Certificate No.)	Scheduled Calibration
Power meter EPM-442A	GB3/480704	04-Oct-07 (METAS, No. 217-00736)	Oct-08
Power sensor HP 8481A	US37292783	04-Oct-07 (METAS, No. 217-00736)	Oct-08
Probe ER3DV6	SN: 2336	31-Dec-07 (SPEAG, No. ER3-2336_Dec07)	Dec-08
Probe H3DV6	SN: 6065	31-Dec-07 (SPEAG, No. H3-6065_Dec07)	Dec-08
DAE4	SN: 781	2-Oct-07 (SPEAG, No. DAE4-781_Oct07)	Oct-08

Secondary Standards	ID #	Check Date (in house)	Scheduled Check
Power meter EPM-4419B	GB42420191	11-May-05 (SPEAG, in house check Oct-07)	In house check: Nov-08
Power sensor HP 8482A	US37295597	11-May-05 (SPEAG, in house check Oct-07)	In house check: Nov-08
Power sensor HP 8482H	3318A09450	08-Jan-02 (SPEAG, in house check Oct-07)	In house check: Nov-08
Network Analyzer HP 8753E	US37390585	18-Oct-01 (SPEAG, in house check Oct-07)	In house check: Nov-09
RF generator E4433B	MY 41310391	22-Nov-04 (SPEAG, in house check Oct-07)	In house check: Nov-09

Calibrated by: **Name: Mike Melli, Function: Laboratory Technician, Signature: [Signature]**

Approved by: **Name: Fin Bornhot, Function: Technical Director, Signature: [Signature]**

Issued: March 12, 2008

This calibration certificate shall not be reproduced except in full without written approval of the laboratory.

Certificate No: CD1880V3-1064_Mar08

Page 1 of 9

FCC ID: A3LSCHR550	PCTEST ENGINEERING LABORATORY, INC.	HAC (RF EMISSIONS) TEST REPORT		Reviewed by: Quality Manager
HAC Filename: 0808061096.A3L	Test Dates: July 29 - August 5, 2008	EUT Type: Cellular/PCS/AWS CDMA Phone with Bluetooth and EVDO		Page 63 of 77



Accredited by the Swiss Accreditation Service (SAS)
The Swiss Accreditation Service is one of the signatories to the EA
Multilateral Agreement for the recognition of calibration certificates

Accreditation No.: **SCS 108**

References

- [1] ANSI-C63.19-2006
American National Standard for Methods of Measurement of Compatibility between Wireless
Communications Devices and Hearing Aids.

Methods Applied and Interpretation of Parameters:

- **Coordinate System:** y-axis is in the direction of the dipole arms, z-axis is from the basis of the antenna (mounted on the table) towards its feed point between the two dipole arms. x-axis is normal to the other axes. In coincidence with standard [1], the measurement planes (probe sensor center) are selected to be at a distance of 10 mm above the top edge of the dipole arms.
- **Measurement Conditions:** Further details are available from the hardcopies at the end of the certificate. All figures stated in the certificate are valid at the frequency indicated. The forward power to the dipole connector is set with a calibrated power meter connected and monitored with an auxiliary power meter connected to a directional coupler. While the dipole under test is connected, the forward power is adjusted to the same level.
- **Antenna Positioning:** The dipole is mounted on a HAC Test Arch phantom using the matching dipole positioner with the arms horizontal and the feeding cable coming from the floor. The measurements are performed in a shielded room with absorbers around the setup to reduce the reflections. It is verified before the mounting of the dipole under the Test Arch phantom, that its arms are perfectly in a line. It is installed on the HAC dipole positioner with its arms parallel below the dielectric reference wire and able to move elastically in vertical direction without changing its relative position to the top center of the Test Arch phantom. The vertical distance to the probe is adjusted after dipole mounting with a DAS4 Surfaces Check job. Before the measurement, the distance between phantom surface and probe tip is verified. The proper measurement distance is selected by choosing the matching section of the HAC Test Arch phantom with the proper device reference point (upper surface of the dipole) and the matching grid reference point (tip of the probe) considering the probe sensor offset. The vertical distance to the probe is essential for the accuracy.
- **Feed Point Impedance and Return Loss:** These parameters are measured using a HP 8753E Vector Network Analyzer. The impedance is specified at the SMA connector of the dipole. The influence of reflections was eliminated by applying the averaging function while moving the dipole in the air, at least 70cm away from any obstacles.
- **E-field distribution:** E field is measured in the x-y-plane with an isotropic ER3D-field probe with 100 mW forward power to the antenna feed point. In accordance with [1], the scan area is 20mm wide, its length exceeds the dipole arm length (180 or 90mm). The sensor center is 10 mm (in z) above the top of the dipole arms. Two 3D maxima are available near the end of the dipole arms. Assuming the dipole arms are perfectly in one line, the average of these two maxima (in subgrid 2 and subgrid 8) is determined to compensate for any non-parallelity to the measurement plane as well as the sensor displacement. The E-field value stated as calibration value represents the maximum of the interpolated 3D-E-field, 10mm above the dipole surface.
- **H-field distribution:** H-field is measured with an isotropic H-field probe with 100mW forward power to the antenna feed point, in the x-y-plane. The scan area and sensor distance is equivalent to the E-field scan. The maximum of the field is available at the center (subgrid 5) above the feed point. The H field value stated as calibration value represents the maximum of the interpolated H-field, 10mm above the dipole surface at the feed point.

FCC ID: A3LSCHR550	PCTEST ENGINEERING LABORATORY, INC.	HAC (RF EMISSIONS) TEST REPORT	SAMSUNG	Reviewed by: Quality Manager
HAC Filename: 0808061096.A3L	Test Dates: July 29 - August 5, 2008	EUT Type: Cellular/PCS/AWS CDMA Phone with Bluetooth and EVDO		Page 64 of 77

1. Measurement Conditions

DASY system configuration, as far as not given on page 1.

DASY Version	DASY4	V4.7 B61
DASY PP Version	SEMCAD	V1.8 B178
Phantom	HAC Test Arch	SC HAC P01 BA, #1070
Distance Dipole Top - Probe Center	10 mm	
Scan resolution	dx, dy = 5 mm	area = 20 x 90 mm
Frequency	1880 MHz ± 1 MHz	
Forward power at dipole connector	20.0 dBm = 100mW	
Input power drift	< 0.05 dB	

2. Maximum Field values

H-field 10 mm above dipole surface	condition	Interpolated maximum
Maximum measured	100 mW forward power	0.463 A/m

Uncertainty for H-field measurement: 8.2% (k=2)

E-field 10 mm above dipole surface	condition	Interpolated maximum
Maximum measured above high end	100 mW forward power	38.6 V/m
Maximum measured above low end	100 mW forward power	35.9 V/m
Averaged maximum above arm	100 mW forward power	136.3 V/m

Uncertainty for E-field measurement: 12.8% (k=2)

3. Appendix



3.1 Antenna Parameters

Frequency	Return Loss	Impedance
1710 MHz	21.5 dB	(47.5 + j7.6) Ohm
1880 MHz	20.9 dB	(49.4 + j8.9) Ohm
1900 MHz	21.1 dB	(51.8 + j8.8) Ohm
1950 MHz	26.0 dB	(54.8 - j2.1) Ohm
2000 MHz	25.1 dB	(44.9 + j1.1) Ohm

3.2 Antenna Design and Handling

The calibration dipole has a symmetric geometry with a built-in two stub matching network, which leads to the enhanced bandwidth. The dipole is built of standard semirigid coaxial cable. The internal matching line is open ended. The antenna is therefore open for DC signals. Do not apply force to dipole arms, as they are liable to bend. The soldered connections near the feedpoint may be damaged. After excessive mechanical stress or overheating, check the impedance characteristics to ensure that the internal matching network is not affected.

After long term use with 40W radiated power, only a slight warming of the dipole near the feedpoint can be measured.

FCC ID: A3LSCHR550		HAC (RF EMISSIONS) TEST REPORT		Reviewed by: Quality Manager
HAC Filename: 0808061096.A3L	Test Dates: July 29 - August 5, 2008	EUT Type: Cellular/PCS/AWS CDMA Phone with Bluetooth and EVDO	Page 65 of 77	

3.3 Measurement Sheets

3.3.1 Return Loss and Smith Chart

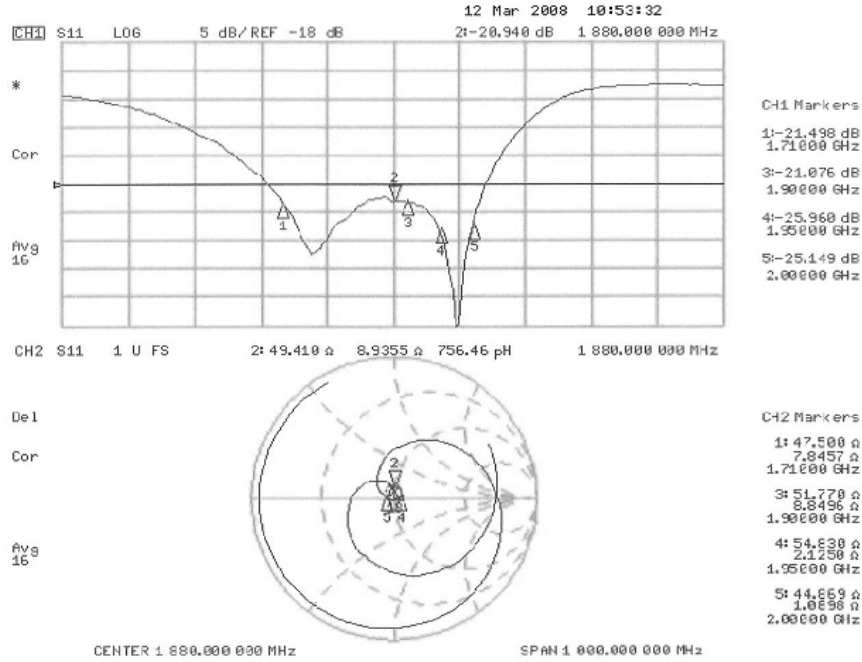

FCC ID: A3LSCHR550	PCTEST ENGINEERING LABORATORY, INC.	HAC (RF EMISSIONS) TEST REPORT	SAMSUNG	Reviewed by: Quality Manager
HAC Filename: 0808061096.A3L	Test Dates: July 29 - August 5, 2008	EUT Type: Cellular/PCS/AWS CDMA Phone with Bluetooth and EVDO		Page 66 of 77

3.3.2 DASY4 H-Field Result

Date/Time: 11.03.2008 15:03:42

Test Laboratory: SPEAG Lab 2

DUT: HAC Dipole 1880 MHz; Type: CD1880V3; Serial: 1064

Communication System: CW; Frequency: 1880 MHz; Duty Cycle: 1:1

Medium parameters used: $\sigma = 0$ mho/m, $\epsilon_r = 1$; $\rho = 1$ kg/m³

Phantom section: H Dipole Section

Measurement Standard: DASY4 (High Precision Assessment)

DASY4 Configuration:

- Probe: H3DV6 - SN6065; Calibrated: 31.12.2007
- Sensor-Surface: (Fix Surface)
- Electronics: DAE4 Sn781; Calibrated: 02.10.2007
- Phantom: HAC Test Arch with Coil; Type: SD HAC P01 BA; Serial: 1070
- Measurement SW: DASY4, V4.7 Build 61; Postprocessing SW: SEMCAD, V1.8 Build 176

E Scan - Sensor Center 10mm above CD1880V3 Dipole/Hearing Aid Compatibility Test (41x181x1):

Measurement grid: dx=5mm, dy=5mm

Maximum value of peak Total field = 0.463 A/m

Probe Modulation Factor = 1.00

Device Reference Point: 0.000, 0.000, 354.7 mm

Reference Value = 0.490 A/m; Power Drift = 0.001 dB



Hearing Aid Near-Field Category: M2 (AWF 0 dB)

Peak H-field in A/m

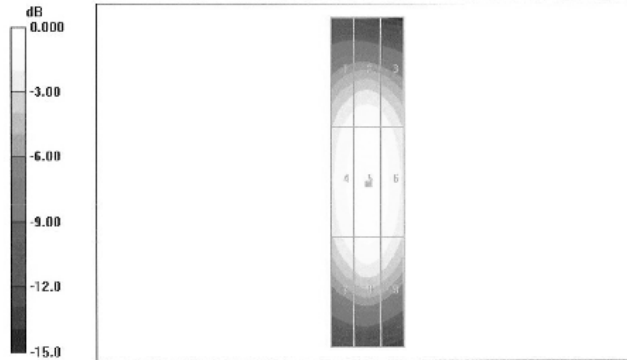
Grid 1 0.400 M2	Grid 2 0.421 M2	Grid 3 0.402 M2
Grid 4 0.440 M2	Grid 5 0.463 M2	Grid 6 0.443 M2
Grid 7 0.402 M2	Grid 8 0.427 M2	Grid 9 0.407 M2



0 dB = 0.463A/m

FCC ID: A3LSCHR550	 PCTEST ENGINEERING LABORATORY, INC.	HAC (RF EMISSIONS) TEST REPORT		Reviewed by: Quality Manager
HAC Filename: 0808061096.A3L	Test Dates: July 29 - August 5, 2008	EUT Type: Cellular/PCS/AWS CDMA Phone with Bluetooth and EVDO	Page 67 of 77	

3.3.2 DASY4 E-Field Result

Date/Time: 10.03.2008 16:23:45

Test Laboratory: SPEAG Lab 2

DUT: HAC Dipole 1880 MHz; Type: CD1880V3; Serial: 1064

Communication System: CW; Frequency: 1880 MHz; Duty Cycle: 1:1

Medium parameters used: $\sigma = 0$ mho/m, $\epsilon_r = 1$; $\rho = 1000$ kg/m³

Phantom section: E Dipole Section

Measurement Standard: DASY4 (High Precision Assessment)

DASY4 Configuration:

- Probe: ER3DV6 - SN2336; ConvF(1, 1, 1); Calibrated: 31.12.2007
- Sensor-Surface: (Fix Surface)
- Electronics: DAE4 Sn781; Calibrated: 02.10.2007
- Phantom: HAC Test Arch with Coil; Type: SD HAC P01 BA; Serial: 1070
- Measurement SW: DASY4, V4.7 Build 61; Postprocessing SW: SEMCAD, V1.8 Build 176

E Scan - Sensor Center 10mm above CD1880V3 Dipole/Hearing Aid Compatibility Test (41x181x1):

Measurement grid: dx=5mm, dy=5mm

Maximum value of peak Total field = 136.6 V/m

Probe Modulation Factor = 1.00

Device Reference Point: 0.000, 0.000, 354.7 mm

Reference Value = 151.7 V/m; Power Drift = 0.009 dB



Hearing Aid Near-Field Category: M2 (AWF 0 dB)

Peak E field in V/m

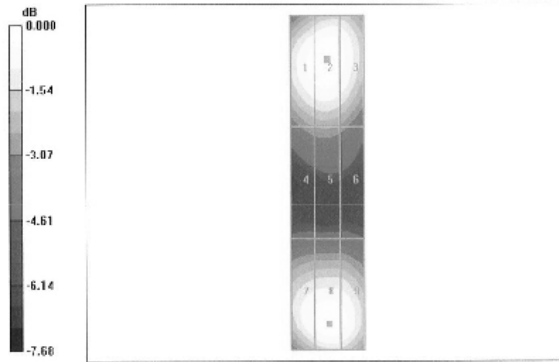
Grid 1 133.1 M2	Grid 2 136.6 M2	Grid 3 132.0 M2
Grid 4 88.2 M3	Grid 5 90.1 M3	Grid 6 86.1 M3
Grid 7 128.9 M2	Grid 8 135.9 M2	Grid 9 132.8 M2



0 dB = 136.6V/m

FCC ID: A3LSCHR550	 PCTEST ENGINEERING LABORATORY, INC.	HAC (RF EMISSIONS) TEST REPORT	 SAMSUNG	Reviewed by: Quality Manager
HAC Filename: 0808061096.A3L	Test Dates: July 29 - August 5, 2008	EUT Type: Cellular/PCS/AWS CDMA Phone with Bluetooth and EVDO	Page 68 of 77	

4 Additional Measurements

4.1 Measurement Conditions

DASY system configuration, as far as not given on page 1.

DASY Version	DASY4	V1.7 B61
DASY PP Version	SEMCAD	V1.8 B176
Phantom	HAC Test Arch	SD HAC P01 BA, #1070
Distance Dipole Top - Probe Center	10 mm	
Scan resolution	dx, dy = 5 mm	area = 20 x 90 mm
Frequency	1730 MHz ± 1 MHz	
Forward power at dipole connector	20.0 dBm – 100mW	
Input power drift	< 0.05 dB	



4.2 Maximum Field values

H-field 10 mm above dipole surface	condition	Interpolated maximum
Maximum measured	100 mW forward power	0.487 A/m

Uncertainty for H-field measurement: 8.2% (k=2)

E-field 10 mm above dipole surface	condition	Interpolated maximum
Maximum measured above high end	100 mW forward power	146.6 V/m
Maximum measured above low end	100 mW forward power	146.1 V/m
Averaged maximum above arm	100 mW forward power	146.4 V/m

Uncertainty for E-field measurement: 12.8% (k=2)

FCC ID: A3LSCHR550		HAC (RF EMISSIONS) TEST REPORT		Reviewed by: Quality Manager
HAC Filename: 0808061096.A3L	Test Dates: July 29 - August 5, 2008	EUT Type: Cellular/PCS/AWS CDMA Phone with Bluetooth and EVDO		Page 69 of 77

4.3.1 DAS4 H-Field Result

Date/Time: 11.03.2008 15:03:42

Test Laboratory: SPEAG Lab 2

DUT: HAC Dipole 1880 MHz; Type: CD1880V3; Serial: 1064

Communication System: CW; Frequency: 1730 MHz; Duty Cycle: 1:1

Medium parameters used: $\sigma = 0$ mho/m, $\epsilon_r = 1$; $\rho = 1$ kg/m³

Phantom section: H Dipole Section

Measurement Standard: DAS4 (High Precision Assessment)

DASY4 Configuration:

- Probe: H3DV6 - SN6065; Calibrated: 31.12.2007
- Sensor-Surface: (Fix Surface)
- Electronics: DAE4 Sn781; Calibrated: 02.10.2007
- Phantom: HAC Test Arch with Coil; Type: SD HAC P01 BA; Serial: 1070
- Measurement SW: DAS4, V4.7 Build 61; Postprocessing SW: SEMCAD, V1.8 Build 176

E Scan - Sensor Center 10mm above CD1880V3 Dipole @ 1730 MHz/Hearing Aid Compatibility Test (41x181x1):

Measurement grid: dx=5mm, dy=5mm

Maximum value of peak Total field = 0.487 A/m

Probe Modulation Factor = 1.00

Device Reference Point: 0.000, 0.000, 354.7 mm

Reference Value = 0.518 A/m; Power Drift = -0.005 dB



Hearing Aid Near-Field Category: M2 (AWF 0 dB)

Peak H-field in A/m

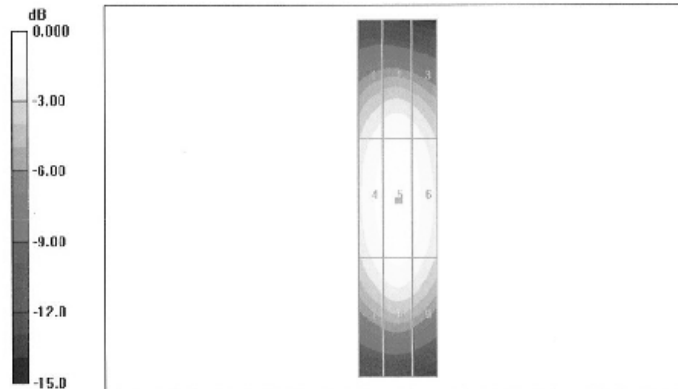
Grid 1 0.403 M2	Grid 2 0.424 M2	Grid 3 0.406 M2
Grid 4 0.458 M2	Grid 5 0.487 M2	Grid 6 0.466 M2
Grid 7 0.405 M2	Grid 8 0.433 M2	Grid 9 0.412 M2



0 dB = 0.463A/m

FCC ID: A3LSCHR550		HAC (RF EMISSIONS) TEST REPORT		Reviewed by: Quality Manager
HAC Filename: 0808061096.A3L	Test Dates: July 29 - August 5, 2008	EUT Type: Cellular/PCS/AWS CDMA Phone with Bluetooth and EVDO		Page 70 of 77

4.3.2 DAS4 E-Field Result

Date/Time: 10.03.2008 16:23:45

Test Laboratory: SPEAG Lab 2

DUT: HAC Dipole 1880 MHz; Type: CD1880V3; Serial: 1064

Communication System: CW; Frequency: 1880 MHz; Duty Cycle: 1:1

Medium parameters used: $\sigma = 0$ mho/m, $\epsilon_r = 1$; $\rho = 1000$ kg/m³

Phantom section: E Dipole Section

Measurement Standard: DAS4 (High Precision Assessment)

DAS4 Configuration:

- Probe: ER3DV6 - SN2336; ConvF(1, 1, 1); Calibrated: 31.12.2007
- Sensor-Surface: (Fix Surface)
- Electronics: DAE4 Sn781; Calibrated: 02.10.2007
- Phantom: HAC Test Arch with Coil; Type: SD HAC P01 BA; Serial: 1070
- Measurement SW: DAS4, V4.7 Build 61; Postprocessing SW: SEMCAD, V1.8 Build 176

E Scan - Sensor Center 10mm above CD1880V3 Dipole @ 1730 MHz/Hearing Aid Compatibility Test (41x181x1):

Measurement grid: dx=5mm, dy=5mm

Maximum value of peak Total field = 146.6 V/m

Probe Modulation Factor = 1.00

Device Reference Point: 0.000, 0.000, 354.7 mm

Reference Value = 162.5 V/m; Power Drift = 0.013 dB



Hearing Aid Near-Field Category: M2 (AWF 0 dB)

Peak E-field in V/m

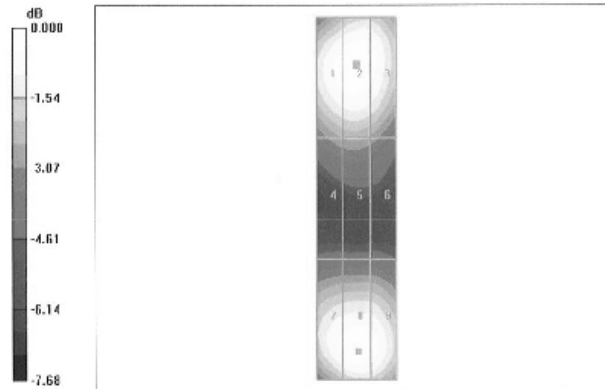
Grid 1 142.6 M2	Grid 2 146.6 M2	Grid 3 141.7 M2
Grid 4 99.8 M3	Grid 5 102.1 M3	Grid 6 97.7 M3
Grid 7 138.8 M2	Grid 8 146.1 M2	Grid 9 142.6 M2





0 dB = 136.6V/m

FCC ID: A3LSCHR550	 PCTEST ENGINEERING LABORATORY, INC.	HAC (RF EMISSIONS) TEST REPORT		Reviewed by: Quality Manager
HAC Filename: 0808061096.A3L	Test Dates: July 29 - August 5, 2008	EUT Type: Cellular/PCS/AWS CDMA Phone with Bluetooth and EVDO	Page 71 of 77	

15. CONCLUSION



The measurements indicate that the wireless communications device complies with the HAC limits specified in accordance with the ANSI C63.19 Standard and FCC WT Docket No. 01-309 RM-8658. Precise laboratory measures were taken to assure repeatability of the tests. The tested device complies with the requirements in respect to all parameters specific to the test. The test results and statements relate only to the item(s) tested.

Please note that the M-rating for this equipment only represents the field interference possible against a hypothetical and typical hearing aid. The measurement system and techniques presented in this evaluation are proposed in the ANSI standard as a means of best approximating wireless device compatibility with a hearing-aid. The literature is under continual re-construction.



FCC ID: A3LSCHR550		HAC (RF EMISSIONS) TEST REPORT		Reviewed by: Quality Manager
HAC Filename: 0808061096.A3L	Test Dates: July 29 - August 5, 2008	EUT Type: Cellular/PCS/AWS CDMA Phone with Bluetooth and EVDO	Page 72 of 77	

16. REFERENCES

1. ANSI/IEEE C63.19-2007, American National Standard for Methods of Measurement of Compatibility between Wireless Communication Devices and Hearing Aids.”, New York, NY, IEEE, June 2007
2. FCC Public Notice DA 06-1215, *Wireless Telecommunications Bureau and Office of Engineering and Technology Clarify Use of Revised Wireless Phone Hearing Aid Compatibility Standard*, June 6, 2006
3. Review Guidance for Reviewing Applications for Certification of 3G Devices, May/June 2006
4. Berger, H. S., “Compatibility Between Hearing Aids and Wireless Devices,” Electronic Industries Forum, Boston, MA, May, 1997
5. Berger, H. S., “Hearing Aid and Cellular Phone Compatibility: Working Toward Solutions,” *Wireless Telephones and Hearing Aids: New Challenges for Audiology*, Gallaudet University, Washington, D.C., May, 1997 (To be reprinted in the American Journal of Audiology).
6. Berger, H. S., “Hearing Aid Compatibility with Wireless Communications Devices,” IEEE International Symposium on Electromagnetic Compatibility, Austin, TX, August, 1997.
7. Bronaugh, E. L., “Simplifying EMI Immunity (Susceptibility) Tests in TEM Cells,” in the 1990 IEEE International Symposium on Electromagnetic Compatibility Symposium Record, Washington, D.C., August 1990, pp. 488-491
8. Byrne, D. and Dillon, H., The National Acoustics Laboratory (NAL) New Procedure for Selecting the Gain and Frequency Response of a Hearing Aid, Ear and Hearing 7:257-265, 1986.
9. Crawford, M. L., “Measurement of Electromagnetic Radiation from Electronic Equipment using TEM Transmission Cells,” U.S. Department of Commerce, National Bureau of Standards, NBSIR 73-306, Feb. 1973.
10. Crawford, M. L., and Workman, J. L., “Using a TEM Cell for EMC Measurements of Electronic Equipment,” U.S. Department of Commerce, National Bureau of Standards. Technical Note 1013, July 1981.
11. EHIMA GSM Project, Development phase, Project Report (1st part) Revision A. Technical-Audiological Laboratory and Telecom Denmark, October 1993.
12. EHIMA GSM Project, Development phase, Part II Project Report. Technical-Audiological Laboratory and Telecom Denmark, June 1994.
13. EHIMA GSM Project Final Report, Hearing Aids and GSM Mobile Telephones: Interference Problems, Methods of Measurement and Levels of Immunity. Technical-Audiological Laboratory and Telecom Denmark, 1995.
14. HAMPIS Report, Comparison of Mobile phone electromagnetic near field with an upscaled electromagnetic far field, using hearing aid as reference, 21 October 1999.

FCC ID: A3LSCHR550		HAC (RF EMISSIONS) TEST REPORT		Reviewed by: Quality Manager
HAC Filename: 0808061096.A3L	Test Dates: July 29 - August 5, 2008	EUT Type: Cellular/PCS/AWS CDMA Phone with Bluetooth and EVDO	Page 73 of 77	

15. Hearing Aids/GSM, Report from OTWIDAM, Technical-Audiological Laboratory and Telecom Denmark, April 1993.
16. IEEE 100, The Authoritative Dictionary of IEEE Standards Terms, Seventh Edition.
17. Joyner, K. H., et. al., Interference to Hearing Aids by the New Digital Mobile Telephone System, Global System for Mobile (GSM) Communication Standard, National Acoustic Laboratory, Australian Hearing Series, Sydney 1993.
18. Joyner, K. H., et. al., Interference to Hearing Aids by the Digital Mobile Telephone System, Global System for Mobile Communications (GSM), NAL Report #131, National Acoustic Laboratory, Australian Hearing Series, Sydney, 1995.
19. Kecker, W. T., Crawford, M. L., and Wilson, W. A., "Construction of a Transverse Electromagnetic Cell", U.S. Department of Commerce, National Bureau of Standards, Technical Note 1011, Nov. 1978.
20. Konigstein, D., and Hansen, D., "A New Family of TEM Cells with enlarged bandwidth and Optimized working Volume," in the Proceedings of the 7th International Symposium on EMC, Zurich, Switzerland, March 1987; 50:9, pp. 127-132.
21. Kuk, F., and Hjorstgaard, N. K., "Factors affecting interference from digital cellular telephones," Hearing Journal, 1997; 50:9, pp 32-34.
22. Ma, M. A., and Kanda, M., "Electromagnetic Compatibility and Interference Metrology," U.S. Department of Commerce, National Bureau of Standards, Technical Note 1099, July 1986, pp. 17-43.
23. Ma, M. A., Sreenivashiah, I. , and Chang, D. C., "A Method of Determining the Emission and Susceptibility Levels of Electrically Small Objects Using a TEM Cell," U.S. Department of Commerce, National Bureau of Standards, Technial Note 1040, July 1981.
24. McCandless, G. A., and Lyregaard, P. E., Prescription of Gain/Output (POGO) for Hearing Aids, Hearing Instruments 1:16-21, 1983
25. Skopec, M., "Hearing Aid Electromagnetic Interference from Digital Wireless Telephones, "IEEE Transactions on Rehabilitation Engineering, vol. 6, no. 2, pp. 235-239, June 1998.
26. Technical Report, GSM 05.90, GSM EMC Considerations, European Telecommunications Standards Institute, January 1993.
27. Victorian, T. A., "Digital Cellular Telephone Interference and Hearing Aid Compatibility—an Update," Hearing Journal 1998; 51:10, pp. 53-60
28. Wong, G. S. K., and Embleton, T. F. W., eds., AIP Handbook of Condenser Microphones: Theory, Calibration and Measurements, AIP Press.

FCC ID: A3LSCHR550	 PCTEST ENGINEERING LABORATORY, INC.	HAC (RF EMISSIONS) TEST REPORT		Reviewed by: Quality Manager
HAC Filename: 0808061096.A3L	Test Dates: July 29 - August 5, 2008	EUT Type: Cellular/PCS/AWS CDMA Phone with Bluetooth and EVDO		Page 74 of 77