



14. CALIBRATION CERTIFICATES

The following pages include the probe calibration used to evaluate HAC for the DUT.

FCC ID: A3LSCHR500	 PCTEST <small>engineering laboratory</small>	HAC (RF EMISSIONS) TEST REPORT		Reviewed by: Quality Manager
HAC Filename: 0703090180.A3L	Test Dates: March 15 - 16, 2007	EUT Type: Cellular/PCS CDMA Phone with Bluetooth and EvDO	Page 35 of 70	



Accredited by the Swiss Federal Office of Metrology and Accreditation
The Swiss Accreditation Service is one of the signatories to the EA
Multilateral Agreement for the recognition of calibration certificates

Accreditation No.: **SCS 108**

Client **PC Test**

Certificate No: **ER3-2353_Oct06**

CALIBRATION CERTIFICATE

Object **ER3DV6 - SN:2353**

Calibration procedure(s) **QA CAL-02.v4
Calibration procedure for E-field probes optimized for close near field
evaluations in air**

Calibration date: **October 13, 2006**

Condition of the calibrated item **In Tolerance**

This calibration certificate documents the traceability to national standards, which realize the physical units of measurements (SI).
The measurements and the uncertainties with confidence probability are given on the following pages and are part of the certificate.

All calibrations have been conducted in the closed laboratory facility: environment temperature (22 ± 3)*C and humidity < 70%.

Calibration Equipment used (M&TE critical for calibration)

Primary Standards	ID #	Cal Date (Calibrated by, Certificate No.)	Scheduled Calibration
Power meter E4419B	GB41293874	5-Apr-06 (METAS, No. 251-00557)	Apr-07
Power sensor E4412A	MY41495277	5-Apr-06 (METAS, No. 251-00557)	Apr-07
Power sensor E4412A	MY41498087	5-Apr-06 (METAS, No. 251-00557)	Apr-07
Reference 3 dB Attenuator	SN: S5054 (3c)	10-Aug-06 (METAS, No. 217-00592)	Aug-07
Reference 20 dB Attenuator	SN: S5086 (20b)	4-Apr-06 (METAS, No. 251-00558)	Apr-07
Reference 30 dB Attenuator	SN: S5129 (30b)	10-Aug-06 (METAS, No. 217-00593)	Aug-07
Reference Probe ER3DV6	SN: 2328	2-Oct-06 (SPEAG, No. ER3-2328_Oct06)	Oct-07
DAE4	SN: 654	21-Jun-06 (SPEAG, No. DAE4-654_Jun06)	Jun-07

Secondary Standards	ID #	Check Date (in house)	Scheduled Check
RF generator HP 8648C	US3642U01700	4-Aug-99 (SPEAG, in house check Nov-05)	In house check: Nov-07
Network Analyzer HP 8753E	US37390585	18-Oct-01 (SPEAG, in house check Nov-05)	In house check: Nov 06

	Name	Function	Signature
Calibrated by:	Katja Pokovic	Technical Manager	
Approved by:	Niels Kuster	Quality Manager	

Issued: October 13, 2006

This calibration certificate shall not be reproduced except in full without written approval of the laboratory.

FCC ID: A3LSCHR500	PCTEST Engineering Laboratory	HAC (RF EMISSIONS) TEST REPORT		Reviewed by: Quality Manager
HAC Filename: 0703090180.A3L	Test Dates: March 15 - 16, 2007	EUT Type: Cellular/PCS CDMA Phone with Bluetooth and EvDO		Page 36 of 70

**Calibration Laboratory of
Schmid & Partner
Engineering AG**
Zeughausstrasse 43, 8004 Zurich, Switzerland



S Schweizerischer Kalibrierdienst
C Service suisse d'étalonnage
S Servizio svizzero di taratura
S Swiss Calibration Service

Accredited by the Swiss Federal Office of Metrology and Accreditation
The Swiss Accreditation Service is one of the signatories to the EA
Multilateral Agreement for the recognition of calibration certificates

Accreditation No.: **SCS 108**

Glossary:

NORM_{x,y,z} sensitivity in free space
DCP diode compression point
Polarization ϕ ϕ rotation around probe axis
Polarization ϑ ϑ rotation around an axis that is in the plane normal to probe axis (at measurement center), i.e., $\vartheta = 0$ is normal to probe axis
Connector Angle information used in DASY system to align probe sensor X to the robot coordinate system

Calibration is Performed According to the Following Standards:

- a) IEEE Std 1309-1996, " IEEE Standard for calibration of electromagnetic field sensors and probes, excluding antennas, from 9 kHz to 40 GHz", 1996.

Methods Applied and Interpretation of Parameters:

- **NORM_{x,y,z}**: Assessed for E-field polarization $\vartheta = 0$ for XY sensors and $\vartheta = 90$ for Z sensor ($f \leq 900$ MHz in TEM-cell; $f > 1800$ MHz: R22 waveguide).
- **NORM(f)_{x,y,z}** = **NORM_{x,y,z}** * *frequency_response* (see Frequency Response Chart).
- **DCP_{x,y,z}**: DCP are numerical linearization parameters assessed based on the data of power sweep (no uncertainty required). DCP does not depend on frequency.
- **Spherical isotropy (3D deviation from isotropy)**: in a locally homogeneous field realized using an open waveguide setup.
- **Sensor Offset**: The sensor offset corresponds to the offset of virtual measurement center from the probe tip (on probe axis). No tolerance required.
- **Connector Angle**: The angle is assessed using the information gained by determining the **NORM_x** (no uncertainty required).

FCC ID: A3LSCHR500	PCTEST Engineering Laboratory, Inc.	HAC (RF EMISSIONS) TEST REPORT		Reviewed by: Quality Manager
HAC Filename: 0703090180.A3L	Test Dates: March 15 - 16, 2007	EUT Type: Cellular/PCS CDMA Phone with Bluetooth and EvDO	Page 37 of 70	



Probe ER3DV6

SN:2353

Manufactured:	March 8, 2005
Last calibrated:	August 2, 2005
Recalibrated:	October 13, 2006

Calibrated for DASY Systems

(Note: non-compatible with DASY2 system!)

FCC ID: A3LSCHR500		HAC (RF EMISSIONS) TEST REPORT		Reviewed by: Quality Manager
HAC Filename: 0703090180.A3L	Test Dates: March 15 - 16, 2007	EUT Type: Cellular/PCS CDMA Phone with Bluetooth and EvDO	Page 38 of 70	

DASY - Parameters of Probe: ER3DV6 SN:2353

Sensitivity in Free Space [$\mu\text{V}/(\text{V}/\text{m})^2$]		Diode Compression ^A	
NormX	1.53 \pm 10.1 % (k=2)	DCP X	95 mV
NormY	1.73 \pm 10.1 % (k=2)	DCP Y	95 mV
NormZ	1.86 \pm 10.1 % (k=2)	DCP Z	96 mV

Frequency Correction

X	0.0
Y	0.0
Z	0.0



Sensor Offset (Probe Tip to Sensor Center)

X	2.5 mm
Y	2.5 mm
Z	2.5 mm

Connector Angle **-29** °

The reported uncertainty of measurement is stated as the standard uncertainty of measurement multiplied by the coverage factor k=2, which for a normal distribution corresponds to a coverage probability of approximately 95%.

^A numerical linearization parameter: uncertainty not required

FCC ID: A3LSCHR500	 PCTEST Engineering Laboratory	HAC (RF EMISSIONS) TEST REPORT		Reviewed by: Quality Manager
HAC Filename: 0703090180.A3L	Test Dates: March 15 - 16, 2007	EUT Type: Cellular/PCS CDMA Phone with Bluetooth and EvDO	Page 39 of 70	

Frequency Response of E-Field

(TEM-Cell:ifi110 EXX, Waveguide R22)

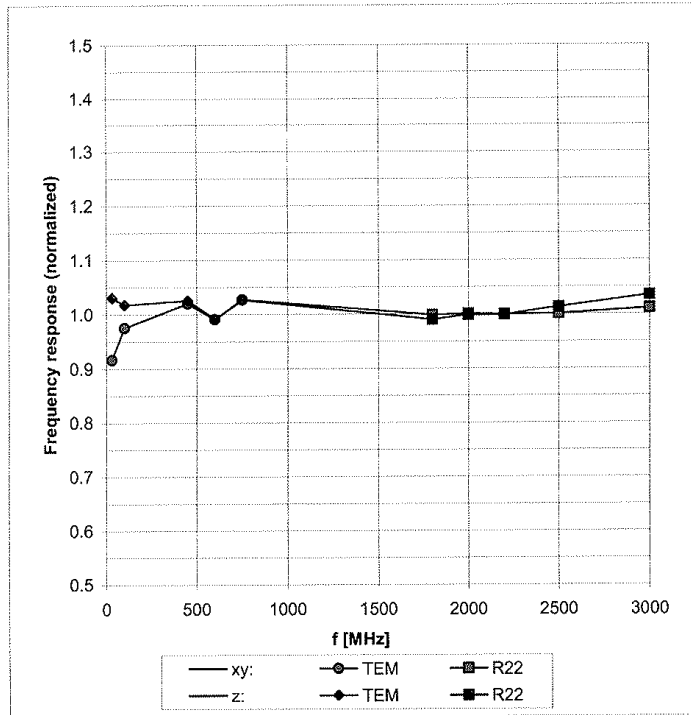

Uncertainty of Frequency Response of E-field: ± 6.3% (k=2)

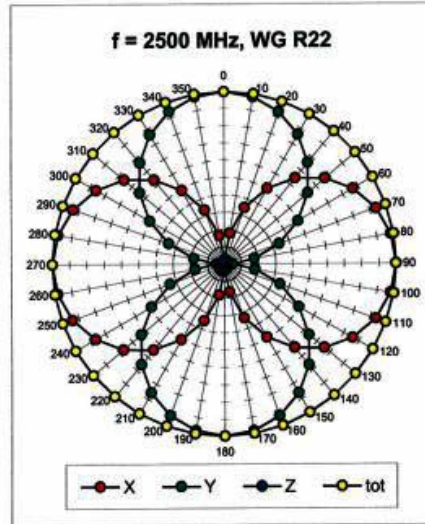
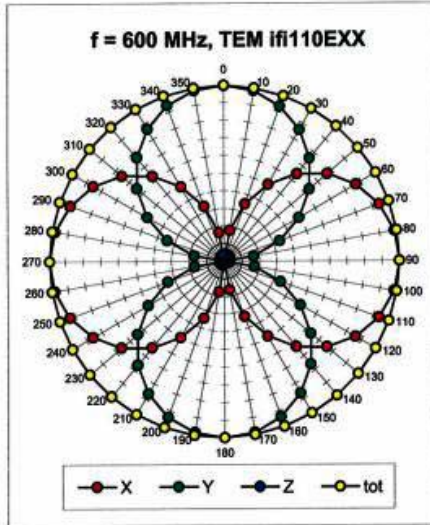

FCC ID: A3LSCHR500	PCTEST wireless	HAC (RF EMISSIONS) TEST REPORT	SAMSUNG	Reviewed by: Quality Manager
HAC Filename: 0703090180.A3L	Test Dates: March 15 - 16, 2007	EUT Type: Cellular/PCS CDMA Phone with Bluetooth and EvDO		Page 40 of 70

Receiving Pattern (ϕ), $\vartheta = 0^\circ$

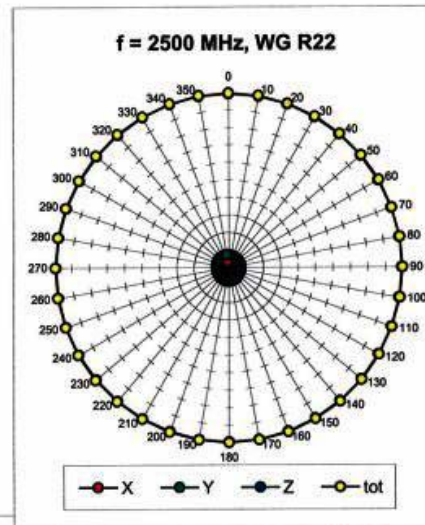
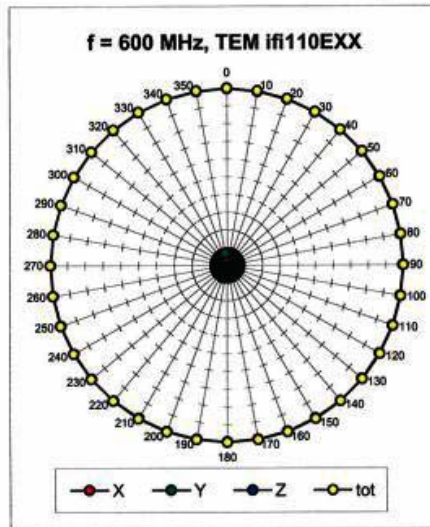

Receiving Pattern (ϕ), $\vartheta = 90^\circ$



FCC ID: A3LSCHR500	 PCTEST Engineering Laboratory, Inc.	HAC (RF EMISSIONS) TEST REPORT	 SAMSUNG	Reviewed by: Quality Manager
HAC Filename: 0703090180.A3L	Test Dates: March 15 - 16, 2007	EUT Type: Cellular/PCS CDMA Phone with Bluetooth and EvDO		Page 41 of 70

Receiving Pattern (ϕ), $\vartheta = 0^\circ$

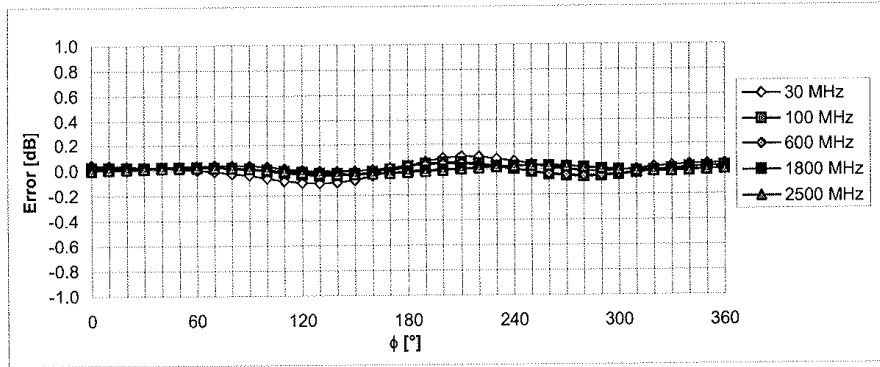

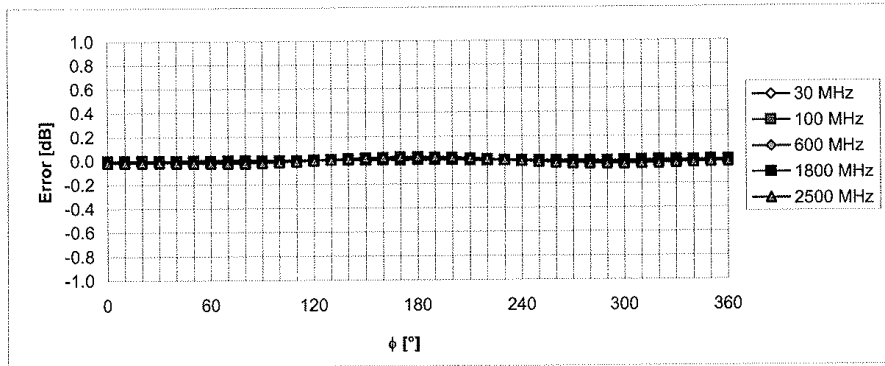

Uncertainty of Axial Isotropy Assessment: $\pm 0.5\%$ (k=2)

Receiving Pattern (ϕ), $\vartheta = 90^\circ$





Uncertainty of Axial Isotropy Assessment: $\pm 0.5\%$ (k=2)

<p>FCC ID: A3LSCHR500</p>		<p>HAC (RF EMISSIONS) TEST REPORT</p>	 <p>Reviewed by: Quality Manager</p>
<p>HAC Filename: 0703090180.A3L</p>	<p>Test Dates: March 15 - 16, 2007</p>	<p>EUT Type: Cellular/PCS CDMA Phone with Bluetooth and EvDO</p>	<p>Page 42 of 70</p>

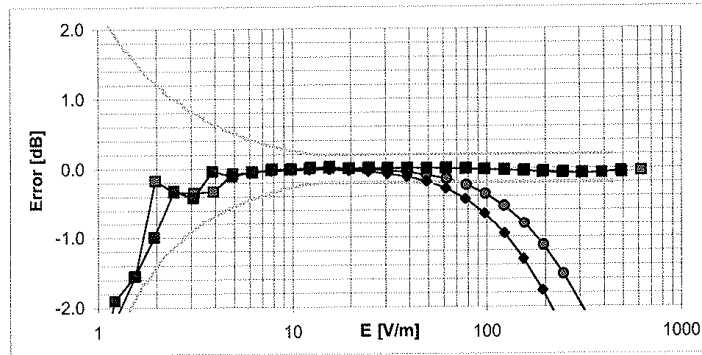
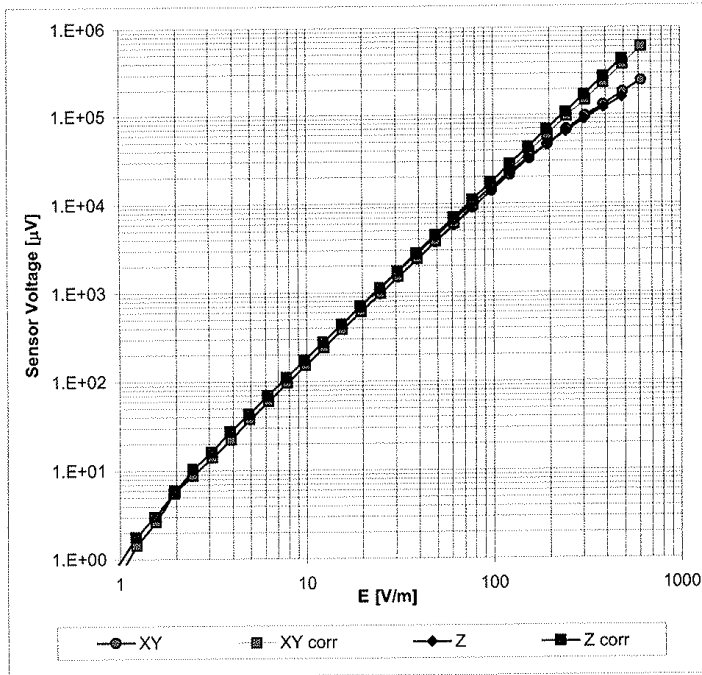
Dynamic Range f(E-field) (Waveguide R22, f = 1800 MHz)





Uncertainty of Linearity Assessment: ± 0.6% (k=2)

FCC ID: A3LSCHR500	 PCTEST	HAC (RF EMISSIONS) TEST REPORT	 SAMSUNG	Reviewed by: Quality Manager
HAC Filename: 0703090180.A3L	Test Dates: March 15 - 16, 2007	EUT Type: Cellular/PCS CDMA Phone with Bluetooth and EvDO		Page 43 of 70

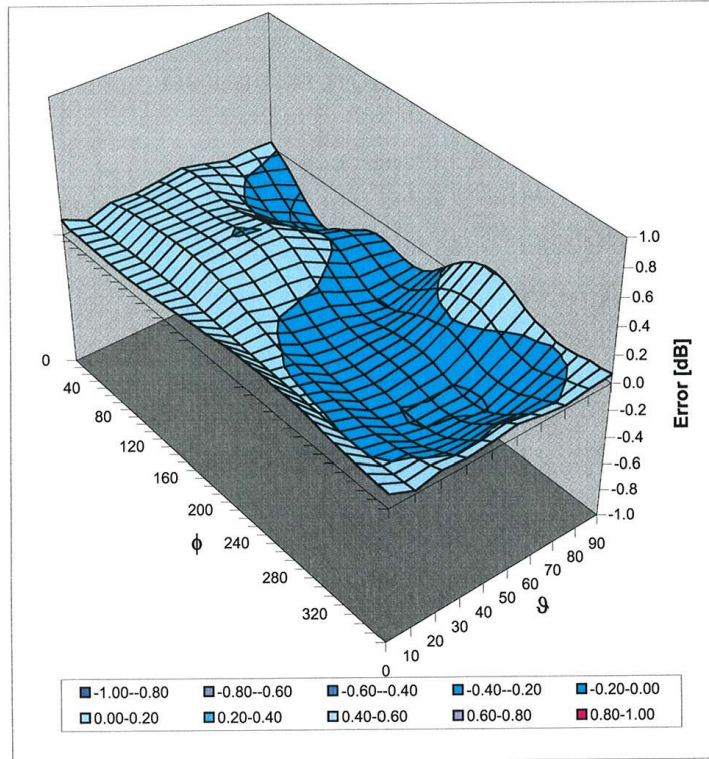
Deviation from Isotropy in Air Error (ϕ, θ), $f = 900$ MHz



Uncertainty of Spherical Isotropy Assessment: $\pm 2.6\%$ ($k=2$)

FCC ID: A3LSCHR500	 PCTEST	HAC (RF EMISSIONS) TEST REPORT	 SAMSUNG	Reviewed by: Quality Manager
HAC Filename: 0703090180.A3L	Test Dates: March 15 - 16, 2007	EUT Type: Cellular/PCS CDMA Phone with Bluetooth and EvDO		Page 44 of 70



Accredited by the Swiss Federal Office of Metrology and Accreditation
The Swiss Accreditation Service is one of the signatories to the EA
Multilateral Agreement for the recognition of calibration certificates

Accreditation No.: **SCS 108**

Client **PC Test**

Certificate No: **H3-6207_Jul06**

CALIBRATION CERTIFICATE

Object **H3DV6 - SN:6207**

Calibration procedure(s) **QA CAL-03.v4
Calibration procedure for H-field probes optimized for close near field
evaluations in air**

Calibration date: **July 10, 2006**

Condition of the calibrated item **In Tolerance**

This calibration certificate documents the traceability to national standards, which realize the physical units of measurements (SI).
The measurements and the uncertainties with confidence probability are given on the following pages and are part of the certificate.

All calibrations have been conducted in the closed laboratory facility: environment temperature (22 ± 3)°C and humidity < 70%.

Calibration Equipment used (M&TE critical for calibration)

Primary Standards	ID #	Cal Date (Calibrated by, Certificate No.)	Scheduled Calibration
Power meter E4419B	GB41293874	5-Apr-06 (METAS, No. 251-00557)	Apr-07
Power sensor E4412A	MY41495277	5-Apr-06 (METAS, No. 251-00557)	Apr-07
Power sensor E4412A	MY41498087	5-Apr-06 (METAS, No. 251-00557)	Apr-07
Reference 3 dB Attenuator	SN: S5054 (3c)	11-Aug-05 (METAS, No. 251-00499)	Aug-06
Reference 20 dB Attenuator	SN: S5086 (20b)	4-Apr-06 (METAS, No. 251-00558)	Apr-07
Reference 30 dB Attenuator	SN: S5129 (30b)	11-Aug-05 (METAS, No. 251-00500)	Aug-06
Reference Probe H3DV6	SN: 6182	3-Oct-05 (SPEAG, No. H3-6182_Oct05)	Oct-06
DAE4	SN: 654	21-Jun-06 (SPEAG, No. DAE4-654_Jun06)	Jun-07

Secondary Standards	ID #	Check Date (in house)	Scheduled Check
RF generator HP 8648C	US3642U01700	4-Aug-99 (SPEAG, in house check Nov-05)	In house check: Nov-07
Network Analyzer HP 8753E	US37390585	18-Oct-01 (SPEAG, in house check Nov-05)	In house check: Nov 06

Calibrated by:	Name	Function	Signature
	Katja Pokovic	Technical Manager	
Approved by:	Niels Kuster	Quality Manager	

Issued: July 10, 2006

This calibration certificate shall not be reproduced except in full without written approval of the laboratory.

Certificate No: H3-6207_Jul06

Page 1 of 8

FCC ID: A3LSCHR500	PCTEST	HAC (RF EMISSIONS) TEST REPORT	SAMSUNG	Reviewed by: Quality Manager
HAC Filename: 0703090180.A3L	Test Dates: March 15 - 16, 2007	EUT Type: Cellular/PCS CDMA Phone with Bluetooth and EvDO		Page 45 of 70

**Calibration Laboratory of
Schmid & Partner
Engineering AG**
Zeughausstrasse 43, 8004 Zurich, Switzerland



S Schweizerischer Kalibrierdienst
C Service suisse d'étalonnage
S Servizio svizzero di taratura
S Swiss Calibration Service

Accredited by the Swiss Federal Office of Metrology and Accreditation
The Swiss Accreditation Service is one of the signatories to the EA
Multilateral Agreement for the recognition of calibration certificates

Accreditation No.: **SCS 108**

Glossary:

NORM_{x,y,z} sensitivity in free space
DCP diode compression point
Polarization ϕ ϕ rotation around probe axis
Polarization ϑ ϑ rotation around an axis that is in the plane normal to probe axis (at measurement center), i.e., $\vartheta = 0$ is normal to probe axis
Connector Angle information used in DASY system to align probe sensor X to the robot coordinate system

Calibration is Performed According to the Following Standards:

- a) IEEE Std 1309-1996, " IEEE Standard for calibration of electromagnetic field sensors and probes, excluding antennas, from 9 kHz to 40 GHz", 1996.

Methods Applied and Interpretation of Parameters:

- **X,Y,Z_a0a1a2:** Assessed for E-field polarization $\vartheta = 90$ for XY sensors and $\vartheta = 0$ for Z sensor ($f \leq 900$ MHz in TEM-cell; $f > 1800$ MHz: R22 waveguide).
- **X,Y,Z(f)_a0a1a2= X,Y,Z_a0a1a2* frequency_response** (see Frequency Response Chart).
- **DCP_{x,y,z}:** DCP are numerical linearization parameters assessed based on the data of power sweep (no uncertainty required). DCP does not depend on frequency.
- **Spherical isotropy (3D deviation from isotropy):** in a locally homogeneous field realized using an open waveguide setup.
- **Sensor Offset:** The sensor offset corresponds to the offset of virtual measurement center from the probe tip (on probe axis). No tolerance required.
- **Connector Angle:** The angle is assessed using the information gained by determining the **X_a0a1a2** (no uncertainty required).

FCC ID: A3LSCHR500	PCTEST Engineering Laboratory, Inc.	HAC (RF EMISSIONS) TEST REPORT		Reviewed by: Quality Manager
HAC Filename: 0703090180.A3L	Test Dates: March 15 - 16, 2007	EUT Type: Cellular/PCS CDMA Phone with Bluetooth and EvDO	Page 46 of 70	



Probe H3DV6

SN:6207

Manufactured: June 12, 2006
Calibrated: July 10, 2006

Calibrated for DASY Systems

(Note: non-compatible with DASY2 system!)

FCC ID: A3LSCHR500	 PCTEST <small>Engineering Laboratory</small>	HAC (RF EMISSIONS) TEST REPORT	 Reviewed by: Quality Manager
HAC Filename: 0703090180.A3L	Test Dates: March 15 - 16, 2007	EUT Type: Cellular/PCS CDMA Phone with Bluetooth and EvDO	Page 47 of 70

DASY - Parameters of Probe: H3DV6 SN:6207

Sensitivity in Free Space [A/m / $\sqrt{(\mu V)}$]

	a0	a1	a2
X	2.444E-03	-1.213E-4	9.909E-5 ± 5.1 % (k=2)
Y	2.476E-03	4.181E-6	1.653E-4 ± 5.1 % (k=2)
Z	2.973E-03	-1.666E-4	9.651E-5 ± 5.1 % (k=2)

Diode Compression¹

DCP X	85 mV
DCP Y	85 mV
DCP Z	85 mV



Sensor Offset (Probe Tip to Sensor Center)

X	3.0 mm
Y	3.0 mm
Z	3.0 mm

Connector Angle -7 °

The reported uncertainty of measurement is stated as the standard uncertainty of measurement multiplied by the coverage factor k=2, which for a normal distribution corresponds to a coverage probability of approximately 95%.



¹ numerical linearization parameter: uncertainty not required

FCC ID: A3LSCHR500	 PCTEST Engineering Laboratory	HAC (RF EMISSIONS) TEST REPORT		Reviewed by: Quality Manager
HAC Filename: 0703090180.A3L	Test Dates: March 15 - 16, 2007	EUT Type: Cellular/PCS CDMA Phone with Bluetooth and EvDO	Page 48 of 70	

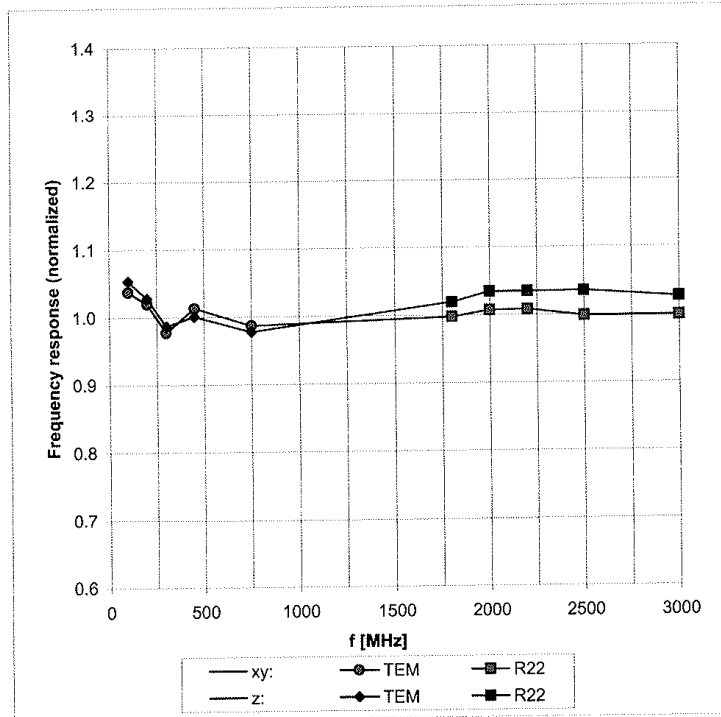
Frequency Response of H-Field (TEM-Cell:ifi110, Waveguide R22)



Uncertainty of Frequency Response of E-field: $\pm 6.3\%$ (k=2)

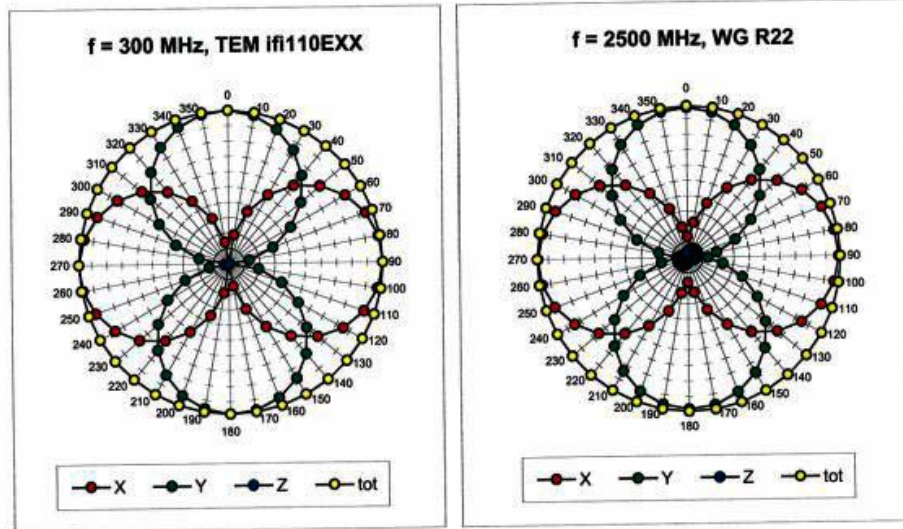

FCC ID: A3LSCHR500	 PCTEST wireless	HAC (RF EMISSIONS) TEST REPORT	 SAMSUNG	Reviewed by: Quality Manager
HAC Filename: 0703090180.A3L	Test Dates: March 15 - 16, 2007	EUT Type: Cellular/PCS CDMA Phone with Bluetooth and EvDO		Page 49 of 70

Receiving Pattern (ϕ), $\vartheta = 90^\circ$

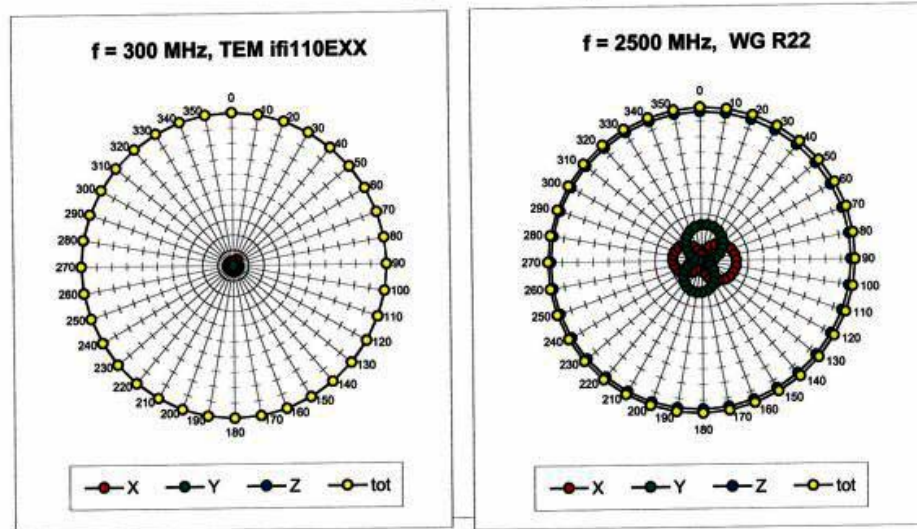

Receiving Pattern (ϕ), $\vartheta = 0^\circ$



<p>FCC ID: A3LSCHR500</p>		<p>HAC (RF EMISSIONS) TEST REPORT</p>	 <p>Reviewed by: Quality Manager</p>
<p>HAC Filename: 0703090180.A3L</p>	<p>Test Dates: March 15 - 16, 2007</p>	<p>EUT Type: Cellular/PCS CDMA Phone with Bluetooth and EvDO</p>	<p>Page 50 of 70</p>

Receiving Pattern (ϕ), $\vartheta = 90^\circ$

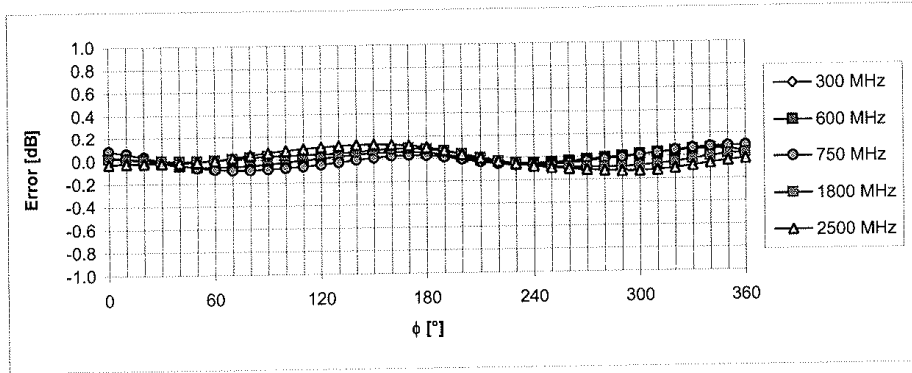

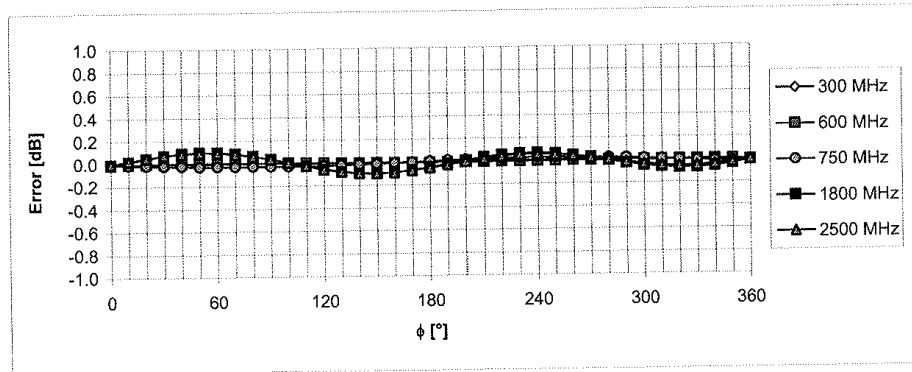

Uncertainty of Axial Isotropy Assessment: $\pm 0.5\%$ ($k=2$)

Receiving Pattern (ϕ), $\vartheta = 0^\circ$





Uncertainty of Axial Isotropy Assessment: $\pm 0.5\%$ ($k=2$)

<p>FCC ID: A3LSCHR500</p>		<p>HAC (RF EMISSIONS) TEST REPORT</p>	 <p>Reviewed by: Quality Manager</p>
<p>HAC Filename: 0703090180.A3L</p>	<p>Test Dates: March 15 - 16, 2007</p>	<p>EUT Type: Cellular/PCS CDMA Phone with Bluetooth and EvDO</p>	<p>Page 51 of 70</p>

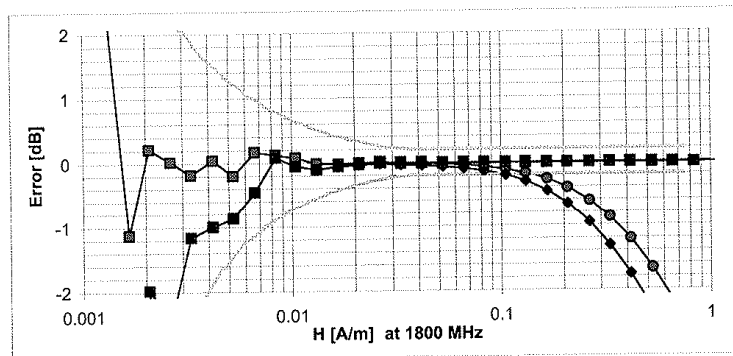
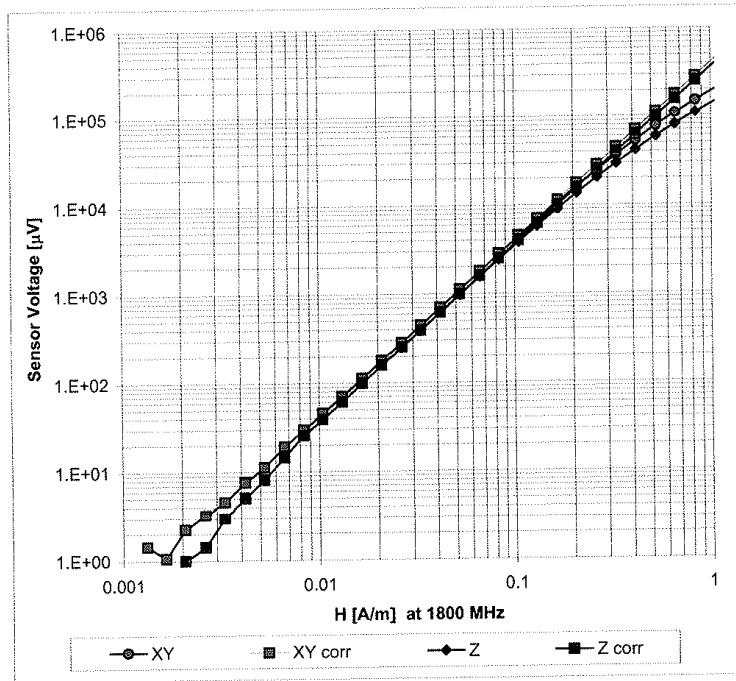
Dynamic Range f(H-field) (Waveguide R22, f = 1800 MHz)



Uncertainty of Linearity Assessment: $\pm 0.6\%$ (k=2)

FCC ID: A3LSCHR500		HAC (RF EMISSIONS) TEST REPORT		Reviewed by: Quality Manager
HAC Filename: 0703090180.A3L	Test Dates: March 15 - 16, 2007	EUT Type: Cellular/PCS CDMA Phone with Bluetooth and EvDO		Page 52 of 70



Accredited by the Swiss Federal Office of Metrology and Accreditation
**The Swiss Accreditation Service is one of the signatories to the EA
Multilateral Agreement for the recognition of calibration certificates**

Accreditation No.: SCS 108

Client **PC Test**

Certificate No: **CD835V3-1082_Jul06**

CALIBRATION CERTIFICATE

Object **CD835V3 - SN: 1082**

Calibration procedure(s) **QA CAL-20.v4
Calibration procedure for dipoles in air**

Calibration date: **July 17, 2006**

Condition of the calibrated item **In Tolerance**

This calibration certificate documents the traceability to national standards, which realize the physical units of measurements (SI).
All calibrations have been conducted in the closed laboratory facility: environment temperature (22 ± 3)°C and humidity < 70%.

Calibration Equipment used (M&TE critical for calibration)

Primary Standards	ID #	Cal Date (Calibrated by, Certificate No.)	Scheduled Calibration
Power meter EPM-442A	GB37480704	04-Oct-05 (METAS, No. 251-00516)	Oct-06
Power sensor HP 8481A	US37292783	04-Oct-05 (METAS, No. 251-00516)	Oct-06
Reference 20 dB Attenuator	SN: 5086 (20g)	11-Aug-05 (METAS, No 251-00498)	Aug-06
Reference 10 dB Attenuator	SN: 5047.2 (10r)	11-Aug-05 (METAS, No 251-00498)	Aug-06
DAE4	SN: 660	1-Mar-06 (SPEAG, No. DAE4-660_Mar06)	Calibration, Mar-07
Probe ER3DV6	SN: 2336	20-Dec-05 (SPEAG, No. ER3-2336_Dec05)	Calibration, Dec-06
Probe H3DV6	SN: 6065	20-Dec-05 (SPEAG, No. H3-6065-Dec05)	Calibration, Dec-06
Secondary Standards	ID #	Check Date (in house)	Scheduled Check
Power meter EPM-4419B	GB43310788	12-Aug-03 (SPEAG, in house check Oct-05)	In house check: Oct-06
Power sensor HP 8481A	MY41093312	10-Aug-03 (SPEAG, in house check Oct-05)	In house check: Oct-07
Power sensor HP 8481A	MY41093315	10-Aug-03 (SPEAG, in house check Oct-05)	In house check: Oct-06
Network Analyzer HP 8753E	US37390585	18-Oct-01 (SPEAG, in house check Nov-05)	In house check: Nov-06
RF generator R&S SMT06	SN: 100005	26-Jul-04 (SPEAG, in house check Nov-05)	In house check: Nov-07

Calibrated by:	Name Mike Meili	Function Laboratory Technician	Signature <i>M. Meili</i>
Approved by:	Name Fin Bomholt	Function Technical Director	Signature <i>F. Bomholt</i>

Issued: July 18, 2006

This calibration certificate shall not be reproduced except in full without written approval of the laboratory.

FCC ID: A3LSCHR500	PCTEST Engineering Laboratory	HAC (RF EMISSIONS) TEST REPORT		Reviewed by: Quality Manager
HAC Filename: 0703090180.A3L	Test Dates: March 15 - 16, 2007	EUT Type: Cellular/PCS CDMA Phone with Bluetooth and EvDO		Page 53 of 70



Accredited by the Swiss Federal Office of Metrology and Accreditation
**The Swiss Accreditation Service is one of the signatories to the EA
Multilateral Agreement for the recognition of calibration certificates**

Accreditation No.: SCS 108

References

- [1] ANSI-PC63.19-2001 (Draft 3.x, 2005)
American National Standard for Methods of Measurement of Compatibility between Wireless Communications Devices and Hearing Aids.

Methods Applied and Interpretation of Parameters:

- *Coordinate System:* y-axis is in the direction of the dipole arms. z-axis is from the basis of the antenna (mounted on the table) towards its feed point between the two dipole arms. x-axis is normal to the other axes. In coincidence with standard [1], the measurement planes (probe sensor center) are selected to be at a distance of 10 mm above the top edge of the dipole arms.
- *Measurement Conditions:* Further details are available from the hardcopies at the end of the certificate. All figures stated in the certificate are valid at the frequency indicated. The forward power to the dipole connector is set with a calibrated power meter connected and monitored with an auxiliary power meter connected to a directional coupler. While the dipole under test is connected, the forward power is adjusted to the same level.
- *Antenna Positioning:* The dipole is mounted on a HAC Test Arch phantom using the matching dipole positioner with the arms horizontal and the feeding cable coming from the floor. The measurements are performed in a shielded room with absorbers around the setup to reduce the reflections. It is verified before the mounting of the dipole under the Test Arch phantom, that its arms are perfectly in a line. It is installed on the HAC dipole positioner with its arms parallel below the dielectric reference wire and able to move elastically in vertical direction without changing its relative position to the top center of the Test Arch phantom. The vertical distance to the probe is adjusted after dipole mounting with a DAS4 Surface Check job. Before the measurement, the distance between phantom surface and probe tip is verified. The proper measurement distance is selected by choosing the matching section of the HAC Test Arch phantom with the proper device reference point (upper surface of the dipole) and the matching grid reference point (tip of the probe) considering the probe sensor offset. The vertical distance to the probe is essential for the accuracy.
- *Feed Point Impedance and Return Loss:* These parameters are measured using a HP 8753E Vector Network Analyzer. The impedance is specified at the SMA connector of the dipole. The influence of reflections was eliminated by applying the averaging function while moving the dipole in the air, at least 70cm away from any obstacles.
- *E-field distribution:* E field is measured in the x-y-plane with an isotropic ER3D-field probe with 100 mW forward power to the antenna feed point. In accordance with [1], the scan area is 20mm wide, its length exceeds the dipole arm length (180 or 90mm). The sensor center is 10 mm (in z) above the top of the dipole arms. Two 3D maxima are available near the end of the dipole arms. Assuming the dipole arms are perfectly in one line, the average of these two maxima (in subgrid 2 and subgrid 8) is determined to compensate for any non-parallelity to the measurement plane as well as the sensor displacement. The E-field value stated as calibration value represents the maximum of the interpolated 3D-E-field, 10mm above the dipole surface.
- *H-field distribution:* H-field is measured with an isotropic H-field probe with 100mW forward power to the antenna feed point, in the x-y-plane. The scan area and sensor distance is equivalent to the E-field scan. The maximum of the field is available at the center (subgrid 5) above the feed point. The H-field value stated as calibration value represents the maximum of the interpolated H-field, 10mm above the dipole surface at the feed point.

FCC ID: A3LSCHR500	PCTEST multiplex	HAC (RF EMISSIONS) TEST REPORT		Reviewed by: Quality Manager
HAC Filename: 0703090180.A3L	Test Dates: March 15 - 16, 2007	EUT Type: Cellular/PCS CDMA Phone with Bluetooth and EvDO	Page 54 of 70	

1 Measurement Conditions

DASY system configuration, as far as not given on page 1.

DASY Version	DASY4	V4.7 B44
DASY PP Version	SEMCAD	V1.8 B171
Phantom	HAC Test Arch	SD HAC P01 BA, #1002
Distance Dipole Top - Probe Center	10 mm	
Scan resolution	dx, dy = 5 mm	area = 20 x 180 mm
Frequency	835 MHz ± 1 MHz	
Forward power at dipole connector	20.0 dBm = 100mW	
Input power drift	< 0.05 dB	

2 Maximum Field values

H-field 10 mm above dipole surface	condition	interpolated maximum
Maximum measured	100 mW forward power	0.454 A/m

Uncertainty for H-field measurement: 8.2% (k=2)

E-field 10 mm above dipole surface	condition	Interpolated maximum
Maximum measured above high end	100 mW forward power	172.3 V/m
Maximum measured above low end	100 mW forward power	162.3 V/m
Averaged maximum above arm	100 mW forward power	167.3 V/m

Uncertainty for E-field measurement: 12.8% (k=2)

3 Appendix

3.1 Antenna Parameters

Frequency	Return Loss	Impedance
800 MHz	16.7 dB	(43.5 – j12.2) Ohm
835 MHz	27.6 dB	(51.3 + j4.0) Ohm
900 MHz	16.1 dB	(57.4 – j15.4) Ohm
950 MHz	21.1 dB	(44.3 + j6.0) Ohm
960 MHz	18.0 dB	(49.0 + j12.6) Ohm



3.2 Antenna Design and Handling

The calibration dipole has a symmetric geometry with a built-in two stub matching network, which leads to the enhanced bandwidth.

The dipole is built of standard semirigid coaxial cable. The internal matching line is open ended. The antenna is therefore open for DC signals.

Do not apply force to dipole arms, as they are liable to bend. The soldered connections near the feedpoint may be damaged. After excessive mechanical stress or overheating, check the impedance characteristics to ensure that the internal matching network is not affected.



After long term use with 40W radiated power, only a slight warming of the dipole near the feedpoint can be measured.

FCC ID: A3LSCHR500	 PCTEST Engineering Laboratory	HAC (RF EMISSIONS) TEST REPORT		Reviewed by: Quality Manager
HAC Filename: 0703090180.A3L	Test Dates: March 15 - 16, 2007	EUT Type: Cellular/PCS CDMA Phone with Bluetooth and EvDO		Page 55 of 70

3.3 Measurement Sheets

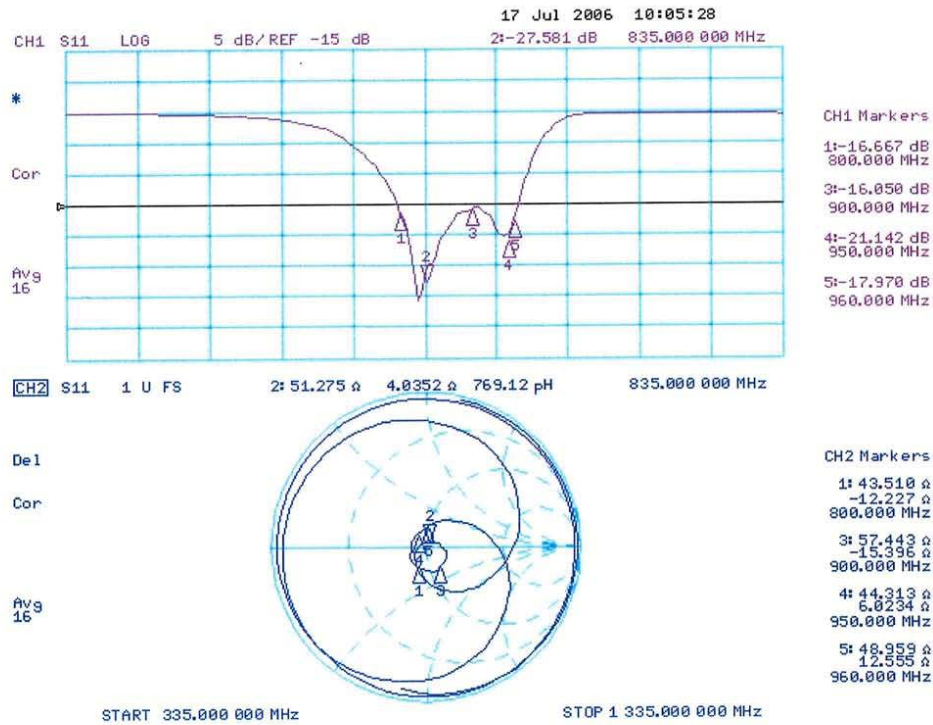
3.3.1 Return Loss and Smith Chart



FCC ID: A3LSCHR500	 PCTEST microtest	HAC (RF EMISSIONS) TEST REPORT	 SAMSUNG	Reviewed by: Quality Manager
HAC Filename: 0703090180.A3L	Test Dates: March 15 - 16, 2007	EUT Type: Cellular/PCS CDMA Phone with Bluetooth and EvDO		Page 56 of 70

3.3.2 DASY4 H-field result

Date/Time: 7/17/2006 2:56:42 PM

Test Laboratory: SPEAG, Zurich, Switzerland
 File Name: [H_CD835_1082_060717.da4](#)

DUT: HAC-Dipole 835 MHz; Type: D835V3; Serial: 1082
Program Name: HAC H Dipole

Communication System: CW; Frequency: 835 MHz; Duty Cycle: 1:1
 Medium: Air Medium parameters used: $\sigma = 0$ mho/m, $\epsilon_r = 1$; $\rho = 1$ kg/m³
 Phantom section: H Dipole Section

DASY4 Configuration:
 - Probe: H3DV6 - SN6065; ; Calibrated: 12/20/2005
 - Sensor-Surface: (Fix Surface)
 - Electronics: DAE4 Sn660; Calibrated: 3/1/2006
 - Phantom: HAC Test Arch 4.6; Type: SD HAC P01 BA; Serial: 1002
 - Measurement SW: DASY4, V4.7 Build 44; Postprocessing SW: SEMCAD, V1.8 Build 171

H Scan - Sensor Center 10mm above CD835 Dipole/Hearing Aid Compatibility Test (41x361x1): Measurement grid:
 dx=5mm, dy=5mm
 Maximum value of peak Total field = 0.454 A/m
 Probe Modulation Factor = 1.00
 Reference Value = 0.482 A/m; Power Drift = -0.014 dB
Hearing Aid Near-Field Category: M2 (AWF 0 dB)

Peak H-field in A/m

Grid 1	Grid 2	Grid 3
0.372	0.402	0.386
Grid 4	Grid 5	Grid 6
0.425	0.454	0.438
Grid 7	Grid 8	Grid 9
0.379	0.404	0.388

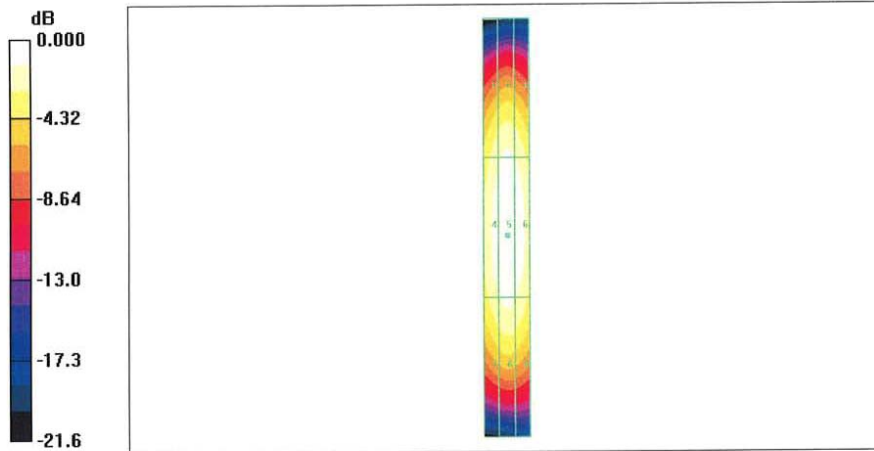

0 dB = 0.454A/m

FCC ID: A3LSCHR500	PCTEST	HAC (RF EMISSIONS) TEST REPORT	SAMSUNG	Reviewed by: Quality Manager
HAC Filename: 0703090180.A3L	Test Dates: March 15 - 16, 2007	EUT Type: Cellular/PCS CDMA Phone with Bluetooth and EvDO		Page 57 of 70

3.3.3 DASY4 E-Field result

Date/Time: 7/17/2006 11:50:47 AM

Test Laboratory: SPEAG, Zurich, Switzerland
 File Name: [E_CD835_1082_060717.da4](#)

DUT: HAC-Dipole 835 MHz; Type: D835V3; Serial: 1082
Program Name: HAC E Dipole

Communication System: CW; Frequency: 835 MHz; Duty Cycle: 1:1
 Medium: Air Medium parameters used: $\sigma = 0$ mho/m, $\epsilon_r = 1$; $\rho = 1000$ kg/m³
 Phantom section: E Dipole Section

DASY4 Configuration:
 - Probe: ER3DV6 - SN2336; ConvF(1, 1, 1); Calibrated: 12/20/2005
 - Sensor-Surface: (Fix Surface)
 - Electronics: DAE4 Sn660; Calibrated: 3/1/2006
 - Phantom: HAC Test Arch 4.6; Type: SD HAC P01 BA; Serial: 1002
 - Measurement SW: DASY4, V4.7 Build 44; Postprocessing SW: SEMCAD, V1.8 Build 171

E Scan - Sensor Center 10mm above CD835 Dipole/Hearing Aid Compatibility Test (41x361x1): Measurement grid:
 dx=5mm, dy=5mm
 Maximum value of peak Total field = 172.3 V/m
 Probe Modulation Factor = 1.00
 Reference Value = 122.7 V/m; Power Drift = -0.030 dB
Hearing Aid Near-Field Category: M2 (AWF 0 dB)

Peak E-field in V/m

Grid 1	Grid 2	Grid 3
166.8	172.3	165.8
Grid 4	Grid 5	Grid 6
84.7	88.9	87.9
Grid 7	Grid 8	Grid 9
154.6	162.3	160.4

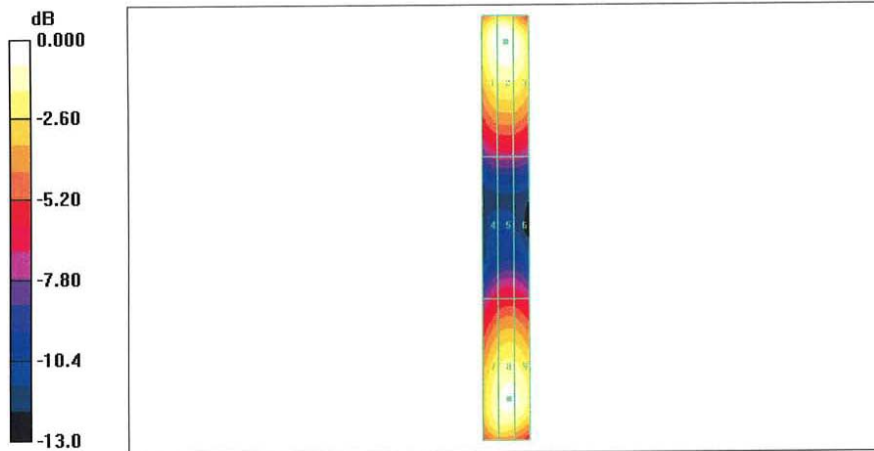

0 dB = 172.3V/m

FCC ID: A3LSCHR500	PCTEST	HAC (RF EMISSIONS) TEST REPORT	SAMSUNG	Reviewed by: Quality Manager
HAC Filename: 0703090180.A3L	Test Dates: March 15 - 16, 2007	EUT Type: Cellular/PCS CDMA Phone with Bluetooth and EvDO		Page 58 of 70



Accredited by the Swiss Federal Office of Metrology and Accreditation
The Swiss Accreditation Service is one of the signatories to the EA
Multilateral Agreement for the recognition of calibration certificates

Accreditation No.: **SCS 108**

Client **PC Test**

Certificate No: **CD1880V3-1064_Jul06**

CALIBRATION CERTIFICATE

Object **CD1880V3 - SN: 1064**

Calibration procedure(s) **QA CAL-20.v4
Calibration procedure for dipoles in air**

Calibration date: **July 18, 2006**

Condition of the calibrated item **In Tolerance**

This calibration certificate documents the traceability to national standards, which realize the physical units of measurements (SI).
All calibrations have been conducted in the closed laboratory facility: environment temperature (22 ± 3)°C and humidity < 70%.

Calibration Equipment used (M&TE critical for calibration)

Primary Standards	ID #	Cal Date (Calibrated by, Certificate No.)	Scheduled Calibration
Power meter EPM-442A	GB37480704	04-Oct-05 (METAS, No. 251-00516)	Oct-06
Power sensor HP 8481A	US37292783	04-Oct-05 (METAS, No. 251-00516)	Oct-06
Reference 20 dB Attenuator	SN: 5086 (20g)	11-Aug-05 (METAS, No 251-00498)	Aug-06
Reference 10 dB Attenuator DAE4	SN: 5047.2 (10r)	11-Aug-05 (METAS, No 251-00498)	Aug-06
Probe ER3DV6	SN: 660	1-Mar-06 (SPEAG, No. DAE4-660_Mar06)	Calibration, Mar-07
Probe H3DV6	SN: 2336	20-Dec-05 (SPEAG, No. ER3-2336_Dec05)	Calibration, Dec-06
	SN: 6065	20-Dec-05 (SPEAG, No. H3-6065-Dec05)	Calibration, Dec-06

Secondary Standards	ID #	Check Date (in house)	Scheduled Check
Power meter EPM-4419B	GB43310788	12-Aug-03 (SPEAG, in house check Oct-05)	In house check: Oct-06
Power sensor HP 8481A	MY41093312	10-Aug-03 (SPEAG, in house check Oct-05)	In house check: Oct-07
Power sensor HP 8481A	MY41093315	10-Aug-03 (SPEAG, in house check Oct-05)	In house check: Oct-06
Network Analyzer HP 8753E	US37390585	18-Oct-01 (SPEAG, in house check Nov-05)	In house check: Nov-06
RF generator R&S SMT06	SN: 100005	26-Jul-04 (SPEAG, in house check Nov-05)	In house check: Nov-07

Calibrated by:	Name Mike Meili	Function Laboratory Technician	Signature
Approved by:	Name Fin Bomholt	Function Technical Director	Signature

Issued: July 20, 2006

This calibration certificate shall not be reproduced except in full without written approval of the laboratory.

Certificate No: CD1880V3-1064_Jul06

Page 1 of 6

FCC ID: A3LSCHR500	PCTEST Engineering Laboratory	HAC (RF EMISSIONS) TEST REPORT		Reviewed by: Quality Manager
HAC Filename: 0703090180.A3L	Test Dates: March 15 - 16, 2007	EUT Type: Cellular/PCS CDMA Phone with Bluetooth and EvDO		Page 59 of 70



Accredited by the Swiss Federal Office of Metrology and Accreditation
The Swiss Accreditation Service is one of the signatories to the EA
Multilateral Agreement for the recognition of calibration certificates

Accreditation No.: **SCS 108**

References

- [1] ANSI-PC63.19-2001 (Draft 3.x, 2005)
American National Standard for Methods of Measurement of Compatibility between Wireless
Communications Devices and Hearing Aids.

Methods Applied and Interpretation of Parameters:

- *Coordinate System:* y-axis is in the direction of the dipole arms. z-axis is from the basis of the antenna (mounted on the table) towards its feed point between the two dipole arms. x-axis is normal to the other axes. In coincidence with standard [1], the measurement planes (probe sensor center) are selected to be at a distance of 10 mm above the top edge of the dipole arms.
- *Measurement Conditions:* Further details are available from the hardcopies at the end of the certificate. All figures stated in the certificate are valid at the frequency indicated. The forward power to the dipole connector is set with a calibrated power meter connected and monitored with an auxiliary power meter connected to a directional coupler. While the dipole under test is connected, the forward power is adjusted to the same level.
- *Antenna Positioning:* The dipole is mounted on a HAC Test Arch phantom using the matching dipole positioner with the arms horizontal and the feeding cable coming from the floor. The measurements are performed in a shielded room with absorbers around the setup to reduce the reflections. It is verified before the mounting of the dipole under the Test Arch phantom, that its arms are perfectly in a line. It is installed on the HAC dipole positioner with its arms parallel below the dielectric reference wire and able to move elastically in vertical direction without changing its relative position to the top center of the Test Arch phantom. The vertical distance to the probe is adjusted after dipole mounting with a DASY4 Surface Check job. Before the measurement, the distance between phantom surface and probe tip is verified. The proper measurement distance is selected by choosing the matching section of the HAC Test Arch phantom with the proper device reference point (upper surface of the dipole) and the matching grid reference point (tip of the probe) considering the probe sensor offset. The vertical distance to the probe is essential for the accuracy.
- *Feed Point Impedance and Return Loss:* These parameters are measured using a HP 8753E Vector Network Analyzer. The impedance is specified at the SMA connector of the dipole. The influence of reflections was eliminated by applying the averaging function while moving the dipole in the air, at least 70cm away from any obstacles.
- *E-field distribution:* E field is measured in the x-y-plane with an isotropic ER3D-field probe with 100 mW forward power to the antenna feed point. In accordance with [1], the scan area is 20mm wide, its length exceeds the dipole arm length (180 or 90mm). The sensor center is 10 mm (in z) above the top of the dipole arms. Two 3D maxima are available near the end of the dipole arms. Assuming the dipole arms are perfectly in one line, the average of these two maxima (in subgrid 2 and subgrid 8) is determined to compensate for any non-parallelity to the measurement plane as well as the sensor displacement. The E-field value stated as calibration value represents the maximum of the interpolated 3D-E-field, 10mm above the dipole surface.
- *H-field distribution:* H-field is measured with an isotropic H-field probe with 100mW forward power to the antenna feed point, in the x-y-plane. The scan area and sensor distance is equivalent to the E-field scan. The maximum of the field is available at the center (subgrid 5) above the feed point. The H-field value stated as calibration value represents the maximum of the interpolated H-field, 10mm above the dipole surface at the feed point.

FCC ID: A3LSCHR500	PCTEST	HAC (RF EMISSIONS) TEST REPORT	SARSONE	Reviewed by: Quality Manager
HAC Filename: 0703090180.A3L	Test Dates: March 15 - 16, 2007	EUT Type: Cellular/PCS CDMA Phone with Bluetooth and EvDO		Page 60 of 70

1 Measurement Conditions

DASY system configuration, as far as not given on page 1.

DASY Version	DASY4	V4.7B44
DASY PP Version	SEMCAD	V1.8 B171
Phantom	HAC Test Arch	SD HAC P01 BA, #1002
Distance Dipole Top - Probe Center	10 mm	
Scan resolution	dx, dy = 5 mm	area = 20 x 90 mm
Frequency	1880 MHz ± 1 MHz	
Forward power at dipole connector	20.0 dBm = 100mW	
Input power drift	< 0.05 dB	

2 Maximum Field values

H-field 10 mm above dipole surface	condition	Interpolated maximum
Maximum measured	100 mW forward power	0.451 A/m

Uncertainty for H-field measurement: 8.2% (k=2)

E-field 10 mm above dipole surface	condition	Interpolated maximum
Maximum measured above high end	100 mW forward power	137.9 V/m
Maximum measured above low end	100 mW forward power	131.3 V/m
Averaged maximum above arm	100 mW forward power	134.6 V/m

Uncertainty for E-field measurement: 12.8% (k=2)

3 Appendix

3.1 Antenna Parameters

Frequency	Return Loss	Impedance
1710 MHz	20.4 dB	(49.1 + j9.5) Ohm
1880 MHz	22.1 dB	(50.7 + j7.9) Ohm
1900 MHz	22.5 dB	(52.6 + j7.2) Ohm
1950 MHz	30.6 dB	(53.0 - j0.3) Ohm
2000 MHz	20.8 dB	(41.8 + j1.7) Ohm



3.2 Antenna Design and Handling

The calibration dipole has a symmetric geometry with a built-in two stub matching network, which leads to the enhanced bandwidth.

The dipole is built of standard semirigid coaxial cable. The internal matching line is open ended. The antenna is therefore open for DC signals.

Do not apply force to dipole arms, as they are liable to bend. The soldered connections near the feedpoint may be damaged. After excessive mechanical stress or overheating, check the impedance characteristics to ensure that the internal matching network is not affected.

After long term use with 40W radiated power, only a slight warming of the dipole near the feedpoint can be measured.

FCC ID: A3LSCHR500	 PCTEST Engineering Laboratory, Inc.	HAC (RF EMISSIONS) TEST REPORT		Reviewed by: Quality Manager
HAC Filename: 0703090180.A3L	Test Dates: March 15 - 16, 2007	EUT Type: Cellular/PCS CDMA Phone with Bluetooth and EvDO		Page 61 of 70

3.3 Measurement Sheets

3.3.1 Return Loss and Smith Chart

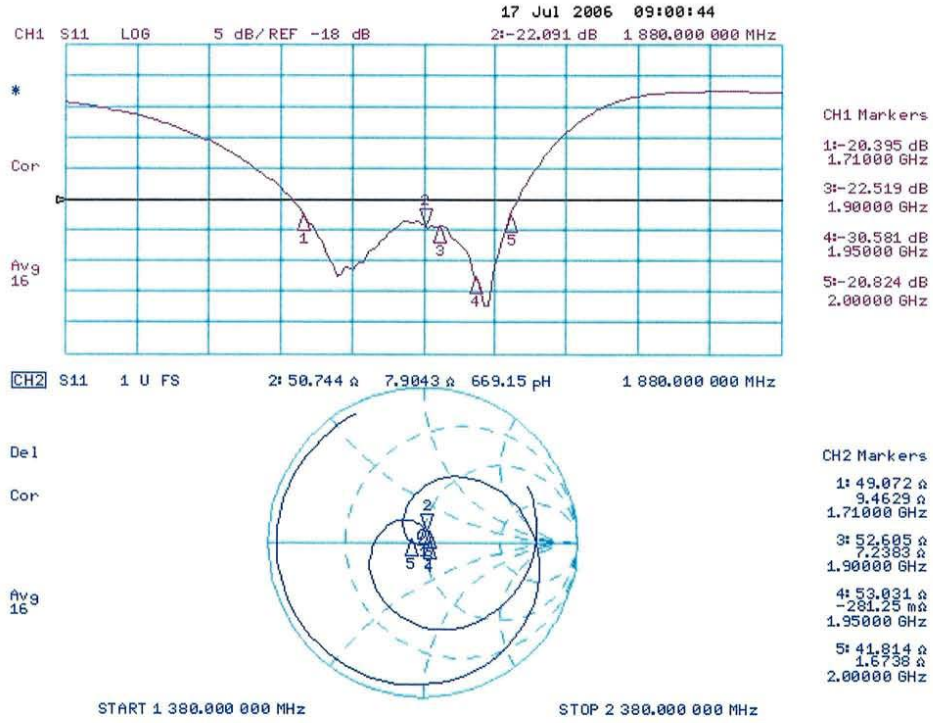

FCC ID: A3LSCHR500	PCTEST	HAC (RF EMISSIONS) TEST REPORT	SAMSUNG	Reviewed by: Quality Manager
HAC Filename: 0703090180.A3L	Test Dates: March 15 - 16, 2007	EUT Type: Cellular/PCS CDMA Phone with Bluetooth and EvDO		Page 62 of 70

3.3.2 DASY4 H-field result

Date/Time: 7/18/2006 10:16:29 AM

Test Laboratory: SPEAG, Zurich, Switzerland

DUT: HAC Dipole 1880 MHz; Type: CD1880V3; Serial: 1064

Communication System: CW; Frequency: 1880 MHz; Duty Cycle: 1:1

Medium: Air

Medium parameters used: $\sigma = 0$ mho/m, $\epsilon_r = 1$; $\rho = 1$ kg/m³

Phantom section: H Dipole Section

DASY4 Configuration:

- Probe: H3DV6 - SN6065; Calibrated: 12/20/2005
- Sensor-Surface: (Fix Surface)
- Electronics: DAE4 Sn660; Calibrated: 3/1/2006
- Phantom: HAC Test Arch 4.6; Type: SD HAC P01 BA; Serial: 1002
- Measurement SW: DASY4, V4.7 Build 44; Postprocessing SW: SEMCAD, V1.8 Build 171

H Scan - Sensor Center 10mm above CD1880V3 Dipole/Hearing Aid Compatibility Test (41x181x1):

Measurement grid: dx=5mm, dy=5mm

Maximum value of peak Total field = 0.451 A/m

Probe Modulation Factor = 1.00

Reference Value = 0.476 A/m; Power Drift = -0.002 dB



Hearing Aid Near-Field Category: M2 (AWF 0 dB)

Peak H-field in A/m

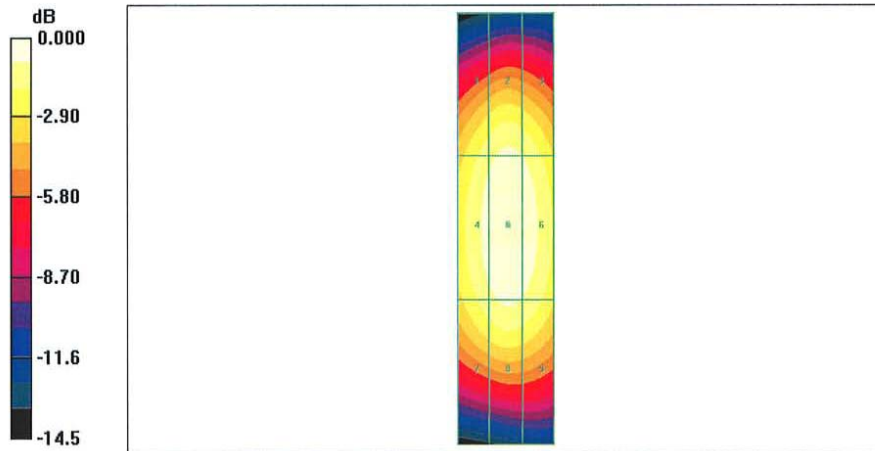
Grid 1	Grid 2	Grid 3
0.389	0.417	0.402
Grid 4	Grid 5	Grid 6
0.425	0.451	0.437
Grid 7	Grid 8	Grid 9
0.387	0.412	0.398



0 dB = 0.451A/m

FCC ID: A3LSCHR500	 PCTEST Engineering Laboratory	HAC (RF EMISSIONS) TEST REPORT		Reviewed by: Quality Manager
HAC Filename: 0703090180.A3L	Test Dates: March 15 - 16, 2007	EUT Type: Cellular/PCS CDMA Phone with Bluetooth and EvDO	Page 63 of 70	

3.3.3 DASY4 E-Field result

Date/Time: 7/18/2006 11:51:17 AM

Test Laboratory: SPEAG, Zurich, Switzerland

DUT: HAC Dipole 1880 MHz; Type: CD1880V3; Serial: 1064

Communication System: CW; Frequency: 1880 MHz; Duty Cycle: 1:1

Medium: Air

Medium parameters used: $\sigma = 0$ mho/m, $\epsilon_r = 1$; $\rho = 1000$ kg/m³

Phantom section: E Dipole Section

DASY4 Configuration:

- Probe: ER3DV6 - SN2336; ConvF(1, 1, 1); Calibrated: 12/20/2005
- Sensor-Surface: (Fix Surface)
- Electronics: DAE4 Sn660; Calibrated: 3/1/2006
- Phantom: HAC Test Arch 4.6; Type: SD HAC P01 BA; Serial: 1002
- Measurement SW: DASY4, V4.7 Build 44; Postprocessing SW: SEMCAD, V1.8 Build 171

E Scan - Sensor Center 10mm above CD1880V3 Dipole/Hearing Aid Compatibility Test (41x181x1):

Measurement grid: dx=5mm, dy=5mm

Maximum value of peak Total field = 137.9 V/m

Probe Modulation Factor = 1.00

Reference Value = 132.3 V/m; Power Drift = 0.013 dB



Hearing Aid Near-Field Category: M2 (AWF 0 dB)

Peak E-field in V/m

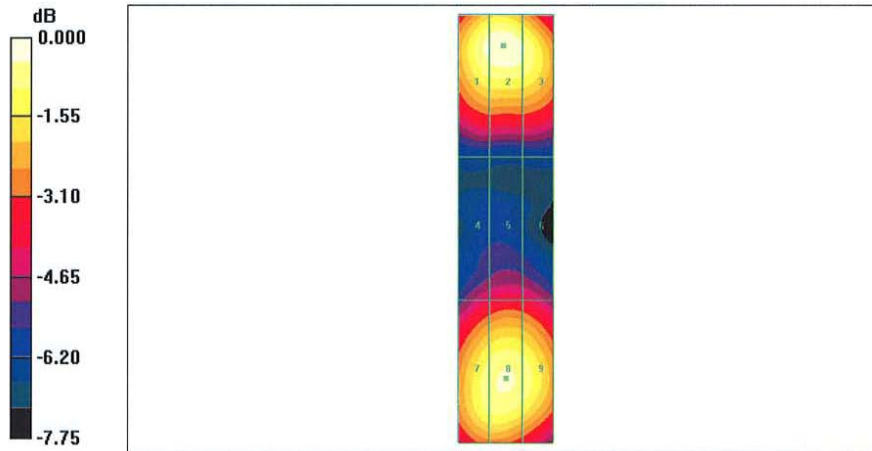
Grid 1	Grid 2	Grid 3
134.7	137.9	131.1
Grid 4	Grid 5	Grid 6
86.8	90.4	88.7
Grid 7	Grid 8	Grid 9
128.1	131.3	127.7





0 dB = 137.9V/m

FCC ID: A3LSCHR500	 PCTEST microtest	HAC (RF EMISSIONS) TEST REPORT		Reviewed by: Quality Manager
HAC Filename: 0703090180.A3L	Test Dates: March 15 - 16, 2007	EUT Type: Cellular/PCS CDMA Phone with Bluetooth and EvDO	Page 64 of 70	

15. CONCLUSION



The measurements indicate that the wireless communications device complies with the HAC limits specified in accordance with the ANSI C63.19 Standard and FCC WT Docket No. 01-309 RM-8658. Precise laboratory measures were taken to assure repeatability of the tests. The tested device complies with the requirements in respect to all parameters specific to the test. The test results and statements relate only to the item(s) tested.

Please note that the M-rating for this equipment only represents the field interference possible against a hypothetical and typical hearing aid. The measurement system and techniques presented in this evaluation are proposed in the ANSI standard as a means of best approximating wireless device compatibility with a hearing-aid. The literature is under continual re-construction.



FCC ID: A3LSCHR500	 PCTEST wired wireless	HAC (RF EMISSIONS) TEST REPORT		Reviewed by: Quality Manager
HAC Filename: 0703090180.A3L	Test Dates: March 15 - 16, 2007	EUT Type: Cellular/PCS CDMA Phone with Bluetooth and EvDO		Page 65 of 70

16. REFERENCES

1. ANSI C63.19-2006 v3.12, American National Standard for Methods of Measurement of Compatibility between Wireless communication devices and Hearing Aids.", New York, NY, IEEE, January 2006
2. FCC Public Notice DA 06-1215, *Wireless Telecommunications Bureau and Office of Engineering and Technology Clarify Use of Revised Wireless Phone Hearing Aid Compatibility Standard*, June 6, 2006
3. Review Guidance for Reviewing Applications for Certification of 3G Devices, May/June 2006
4. Berger, H. S., "Compatibility Between Hearing Aids and Wireless Devices," Electronic Industries Forum, Boston, MA, May, 1997
5. Berger, H. S., "Hearing Aid and Cellular Phone Compatibility: Working Toward Solutions," Wireless Telephones and Hearing Aids: New Challenges for Audiology, Gallaudet University, Washington, D.C., May, 1997 (To be reprinted in the American Journal of Audiology).
6. Berger, H. S., "Hearing Aid Compatibility with Wireless Communications Devices," IEEE International Symposium on Electromagnetic Compatibility, Austin, TX, August, 1997.
7. Bronaugh, E. L., "Simplifying EMI Immunity (Susceptibility) Tests in TEM Cells," in the 1990 IEEE International Symposium on Electromagnetic Compatibility Symposium Record, Washington, D.C., August 1990, pp. 488-491
8. Byrne, D. and Dillon, H., The National Acoustics Laboratory (NAL) New Procedure for Selecting the Gain and Frequency Response of a Hearing Aid, Ear and Hearing 7:257-265, 1986.
9. Crawford, M. L., "Measurement of Electromagnetic Radiation from Electronic Equipment using TEM Transmission Cells," U.S. Department of Commerce, National Bureau of Standards, NBSIR 73-306, Feb. 1973.
10. Crawford, M. L., and Workman, J. L., "Using a TEM Cell for EMC Measurements of Electronic Equipment," U.S. Department of Commerce, National Bureau of Standards. Technical Note 1013, July 1981.
11. EHIMA GSM Project, Development phase, Project Report (1st part) Revision A. Technical-Audiological Laboratory and Telecom Denmark, October 1993.
12. EHIMA GSM Project, Development phase, Part II Project Report. Technical-Audiological Laboratory and Telecom Denmark, June 1994.
13. EHIMA GSM Project Final Report, Hearing Aids and GSM Mobile Telephones: Interference Problems, Methods of Measurement and Levels of Immunity. Technical-Audiological Laboratory and Telecom Denmark, 1995.
14. HAMPIS Report, Comparison of Mobile phone electromagnetic near field with an upscaled electromagnetic far field, using hearing aid as reference, 21 October 1999.

FCC ID: A3LSCHR500	 PCTEST Engineering Laboratory, Inc.	HAC (RF EMISSIONS) TEST REPORT		Reviewed by: Quality Manager
HAC Filename: 0703090180.A3L	Test Dates: March 15 - 16, 2007	EUT Type: Cellular/PCS CDMA Phone with Bluetooth and EvDO	Page 66 of 70	

15. Hearing Aids/GSM, Report from OTWIDAM, Technical-Audiological Laboratory and Telecom Denmark, April 1993.
16. IEEE 100, The Authoritative Dictionary of IEEE Standards Terms, Seventh Edition.
17. Joyner, K. H., et. al., Interference to Hearing Aids by the New Digital Mobile Telephone System, Global System for Mobile (GSM) Communication Standard, National Acoustic Laboratory, Australian Hearing Series, Sydney 1993.
18. Joyner, K. H., et. al., Interference to Hearing Aids by the Digital Mobile Telephone System, Global System for Mobile Communications (GSM), NAL Report #131, National Acoustic Laboratory, Australian Hearing Series, Sydney, 1995.
19. Kecker, W. T., Crawford, M. L., and Wilson, W. A., "Construction of a Transverse Electromagnetic Cell", U.S. Department of Commerce, National Bureau of Standards, Technical Note 1011, Nov. 1978.
20. Konigstein, D., and Hansen, D., "A New Family of TEM Cells with enlarged bandwidth and Optimized working Volume," in the Proceedings of the 7th International Symposium on EMC, Zurich, Switzerland, March 1987; 50:9, pp. 127-132.
21. Kuk, F., and Hjorstgaard, N. K., "Factors affecting interference from digital cellular telephones," Hearing Journal, 1997; 50:9, pp 32-34.
22. Ma, M. A., and Kanda, M., "Electromagnetic Compatibility and Interference Metrology," U.S. Department of Commerce, National Bureau of Standards, Technical Note 1099, July 1986, pp. 17-43.
23. Ma, M. A., Sreenivashiah, I. , and Chang, D. C., "A Method of Determining the Emission and Susceptibility Levels of Electrically Small Objects Using a TEM Cell," U.S. Department of Commerce, National Bureau of Standards, Technial Note 1040, July 1981.
24. McCandless, G. A., and Lyregaard, P. E., Prescription of Gain/Output (POGO) for Hearing Aids, Hearing Instruments 1:16-21, 1983
25. Skopec, M., "Hearing Aid Electromagnetic Interference from Digital Wireless Telephones, "IEEE Transactions on Rehabilitation Engineering, vol. 6, no. 2, pp. 235-239, June 1998.
26. Technical Report, GSM 05.90, GSM EMC Considerations, European Telecommunications Standards Institute, January 1993.
27. Victorian, T. A., "Digital Cellular Telephone Interference and Hearing Aid Compatibility—an Update," Hearing Journal 1998; 51:10, pp. 53-60
28. Wong, G. S. K., and Embleton, T. F. W., eds., AIP Handbook of Condenser Microphones: Theory, Calibration and Measurements, AIP Press.

FCC ID: A3LSCHR500	 PCTEST Engineering Laboratory	HAC (RF EMISSIONS) TEST REPORT		Reviewed by: Quality Manager
HAC Filename: 0703090180.A3L	Test Dates: March 15 - 16, 2007	EUT Type: Cellular/PCS CDMA Phone with Bluetooth and EvDO		Page 67 of 70