

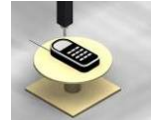

PCTEST ENGINEERING LABORATORY, INC.

6660-B Dobbin Road, Columbia, MD 21045 USA
Tel. 410.290.6652 / Fax 410.290.6554
http://www.pctestlab.com



HEARING AID COMPATIBILITY CERTIFICATE

Applicant Name:
Samsung Electronics, Co. Ltd.
18600 Broadwick St.
Rancho Dominguez, CA 90220 USA

Date of Testing:
Feb. 22 - 23, 2006
Test Site/Location:
PCTEST Lab, Columbia, MD, USA
Test Report Serial No.:
HAC.0602170094.A3L

FCC ID: A3LSCHA645

APPLICANT: SAMSUNG ELECTRONICS, CO. LTD.

Application Type: Certification
FCC Rule Part(s): § 20.19(b), §6.3(v), §7.3(v)
HAC Standard: ANSI PC63.19-2005 D3.6
FCC Classification: Licensed Transmitter Held to Ear (PCE)
EUT Type: Dual-Band CDMA Phone
Model(s): SCH-A645
Tx Frequency: 824.04 - 848.97 MHz (AMPS)
824.70 - 848.31 MHz (CDMA)
1851.25 - 1908.75 MHz (PCS)
Test Device Serial No.: Pre-Production Sample [S/N: 12]

PC63.19 HAC Rated Category: M3 (RF EMISSIONS)

This wireless portable device has been shown to be hearing-aid compatible under the above rated category, specified in ANSI/IEEE Std. PC63.19 and had been tested in accordance with the specified measurement procedures. Hearing-Aid Compatibility is based on the assumption that all production units will be designed electrically identical to the device tested in this report.

I attest to the accuracy of data. All measurements reported herein were performed by me or were made under my supervision and are correct to the best of my knowledge and belief. I assume full responsibility for the completeness of these measurements and vouch for the qualifications of all persons taking them.

PCTEST certifies that no party to this application has been denied the FCC benefits pursuant to Section 5301 of the Anti-Drug Abuse Act of 1988, 21 U.S.C. 862.

Randy Ortanez
President







PCTEST™ HAC REPORT		FCC MEASUREMENT REPORT		Reviewed by: Quality Manager
HAC Filename: HAC.0602170094.A3L	Test Dates: Feb. 22 - 23, 2006	EUT Type: Dual-Band CDMA Phone	FCC ID: A3LSCHA645	Page 1 of 69

TABLE OF CONTENTS

1.	INTRODUCTION	3
2.	TEST SITE LOCATION	4
3.	EUT DESCRIPTION	5
4.	ANSI/IEEE PC63.19 PERFORMANCE CATEGORIES	6
5.	SYSTEM SPECIFICATIONS	7
6.	TEST PROCEDURE	14
7.	SYSTEM CHECK	16
8.	MODULATION FACTOR	19
9.	OVERALL MEASUREMENT SUMMARY	21
10.	EQUIPMENT LIST	24
11.	MEASUREMENT UNCERTAINTY	25
12.	TEST DATA	26
13.	CALIBRATION CERTIFICATES	35
14.	CONCLUSION	65
15.	REFERENCES	66
	APPENDIX A. SETUP PHOTOGRAPHS	68

PCTEST™ HAC REPORT		FCC MEASUREMENT REPORT		Reviewed by: Quality Manager
HAC Filename: HAC.0602170094.A3L	Test Dates: Feb. 22 - 23, 2006	EUT Type: Dual-Band CDMA Phone	FCC ID: A3LSCHA645	Page 2 of 69

1. INTRODUCTION

On July 10, 2003, the Federal Communications Commission (FCC) adopted new rules requiring wireless manufacturers and service providers to provide digital wireless phones that are compatible with hearing aids. The FCC has modified the exemption for wireless phones under the Hearing Aid Compatibility Act of 1998 (HAC Act) in WT Docket 01-309 RM-8658¹ to extend the benefits of wireless telecommunications to individuals with hearing disabilities. These benefits encompass business, social and emergency communications, which increase the value of the wireless network for everyone. An estimated more than 10% of the population in the United States show signs of hearing impairment and of that fraction, almost 80% use hearing aids. Approximately 500 million people worldwide suffer from hearing loss.

Compatibility Tests Involved:

The standard calls for wireless communications devices to be measured for:

- RF Electric-field emissions
- RF Magnetic-field emissions
- T-coil mode, magnetic-signal strength in the audio band
- T-coil mode, magnetic-signal frequency response through the audio band
- T-coil mode, magnetic-signal and noise articulation index

The hearing aid must be measured for:



- RF immunity in microphone mode
- RF immunity in T-coil mode

In the following tests and results, this report includes the evaluation for a wireless communications device.



Figure 1 Hearing Aid *in-vitu*

¹ FCC Rule & Order, WT Docket 01-309 RM-8658

PCTEST™ HAC REPORT		FCC MEASUREMENT REPORT		Reviewed by: Quality Manager
HAC Filename: HAC.0602170094.A3L	Test Dates: Feb. 22 - 23, 2006	EUT Type: Dual-Band CDMA Phone	FCC ID: A3LSCHA645	Page 3 of 69

2. TEST SITE LOCATION

2.1 INTRODUCTION

The map at the right shows the location of the PCTEST LABORATORY in Columbia, Maryland. It is in proximity to the FCC Laboratory, the Baltimore-Washington International (BWI) airport, the city of Baltimore and Washington, DC (See Figure 2).

These measurement tests were conducted at the PCTEST Engineering Laboratory, Inc. facility in New Concept Business Park, Guilford Industrial Park, Columbia, Maryland. The site address is 6660-B Dobbin Road, Columbia, MD 21045. The test site is one of the highest points in the Columbia area with an elevation of 390 feet above mean sea level. The site coordinates are 39° 11'15" N latitude and 76° 49' 38" W longitude. The facility is 1.5 miles North of the FCC laboratory, and the ambient signal and ambient signal strength are approximately equal to those of the FCC laboratory. There are no FM or TV transmitters within 15 miles of the site. The detailed description of the measurement facility was found to be in compliance with the requirements of § 2.948 according to ANSI C63.4 on October 19, 2002.

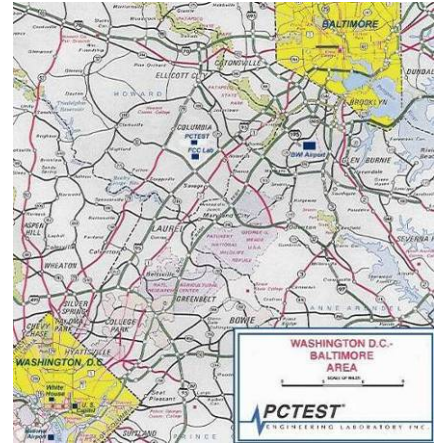
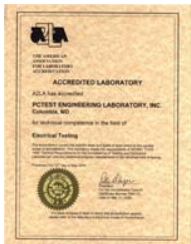

Figure 2



Map of the Greater Baltimore and Metropolitan Washington, D.C. area

2.2 Test Facility / NVLAP Accreditation:

Measurements were performed at an independent accredited PCTEST Engineering Lab located in Columbia, MD 21045, U.S.A.



- PCTEST facility is an FCC registered (PCTEST Reg. No. 90864) test facility with the site description report on file and has met all the requirements specified in Section 2.948 of the FCC Rules and Industry Canada (IC 2451).
- PCTEST Lab is accredited to ISO 17025 by U.S. National Institute of Standards and Technology (NIST) under the National Voluntary Laboratory Accreditation Program (NVLAP Lab code: 100431-0) in EMC, FCC and Telecommunications.
- PCTEST Lab is accredited to ISO 17025 by the American Association for Laboratory Accreditation (A2LA) in Specific Absorption Rate (SAR) testing, CTIA Test Plans, and wireless testing for FCC, HAC, CTIA OTA and Industry Canada Rules.
- PCTEST Lab is a recognized U.S. Conformity Assessment Body (CAB) in EMC and R&TTE (n.b. 0982) under the U.S.-EU Mutual Recognition Agreement (MRA).
- PCTEST TCB is a Telecommunication Certification Body (TCB) accredited to ISO/IEC Guide 65 by the American National Standards Institute (ANSI) in all scopes of FCC Rules.
- PCTEST facility is an IC registered (IC-2451) test laboratory with the site description on file at Industry Canada.
- PCTEST is a CTIA Authorized Test Laboratory (CATL) in AMPS and CDMA mobile phones.

PCTEST™ HAC REPORT		FCC MEASUREMENT REPORT		Reviewed by: Quality Manager
HAC Filename: HAC.0602170094.A3L	Test Dates: Feb. 22 - 23, 2006	EUT Type: Dual-Band CDMA Phone	FCC ID: A3LSCHA645	Page 4 of 69

3. EUT DESCRIPTION



FCC ID: A3LSCHA645
 Manufacturer: Samsung Electronics, Co. Ltd.
 18600 Broadwick St.
 Rancho Dominguez, CA 90220 USA



Trade Name: Samsung
 Model(s): SCH-A645
 Serial Number: 12
 Tx Frequencies: 824.04 - 848.97 MHz (AMPS)
 824.70 - 848.31 MHz (CDMA)
 1851.25 - 1908.75 MHz (PCS)

Antenna Configurations: Fixed Antenna
 Maximum Conducted Power (EMC/SAR): 25.0 dBm (CDMA), 25.0 dBm (PCS)
 Maximum Conducted Power (HAC): 25.0 dBm (CDMA), 25.0 dBm (PCS)
 HAC Test Configurations: CDMA, Channels 1013, 384, 777
 PCS, Channels 25, 600, 1175

FCC Classification: Licensed Transmitter Held to Ear (PCE)
 EUT Type: Dual-Band CDMA Phone



Figure 3
Device Under Test

PCTEST™ HAC REPORT		FCC MEASUREMENT REPORT		Reviewed by: Quality Manager
HAC Filename: HAC.0602170094.A3L	Test Dates: Feb. 22 - 23, 2006	EUT Type: Dual-Band CDMA Phone	FCC ID: A3LSCHA645	Page 5 of 69

4. ANSI/IEEE PC63.19 PERFORMANCE CATEGORIES

I. RF EMISSIONS

The ANSI Standard presents performance requirements for acceptable interoperability of hearing aids with wireless communications devices. When these parameters are met, a hearing aid operates acceptably in close proximity to a wireless communications device.

Category	Hearing aid RF Parameters		Telephone RF Parameters	
	E-field immunity CW dB(V/m)	H-field immunity CW dB(A/m)	E-field emissions CW dB(V/m)	H-field emissions CW dB(A/m)
M1	30.0 to 35.0	-23.0 to -18.0	46 to 51 + 0.5 x AWF	-4.4 to 0.6 +0.5 x AWF
M2	35.0 to 40.0	-18.0 to -13.0	41 to 46 + 0.5 x AWF	-9.4 to -4.4 +0.5 x AWF
M3	40.0 to 45.0	-13.0 to -8.0	36 to 41 + 0.5 x AWF	-14.4 to -9.4 +0.5 x AWF
M4	> 45.0	> -8.0	< 36 + 0.5 x AWF	< -14.4 + 0.5 x AWF

Table 6.1



Hearing aid and WD near-field categories as defined in draft ANSI PC63.19. During testing, the hearing aid must maintain an input-referenced interference level of less than 55 dB and a gain compression of less than 6 dB.

II. ARTICULATION WEIGHTING FACTOR (AWF)

Standard	Technology	Articulation Weighing Factor (AWF)
T1/T1P1/3GPP	UMTS (WCDMA)	0
IS-95	CDMA	0
iDEN™	TDMA (22 and 11 Hz)	0
J-STD-007	GSM (217 Hz)	-5

Table 6.2

AWF has been developed from information presented to the committee regarding the interference potential of the various modulation types according to ANSI PC63.19

PCTEST™ HAC REPORT		FCC MEASUREMENT REPORT		Reviewed by: Quality Manager
HAC Filename: HAC.0602170094.A3L	Test Dates: Feb. 22 - 23, 2006	EUT Type: Dual-Band CDMA Phone	FCC ID: A3LSCHA645	Page 6 of 69

5. SYSTEM SPECIFICATIONS

ER3DV6 E-Field Probe Description

Construction:	One dipole parallel, two dipoles normal to probe axis Built-in shielding against static charges
Calibration:	In air from 100 MHz to 3.0 GHz (absolute accuracy $\pm 6.0\%$, $k=2$)
Frequency:	100 MHz to > 6 GHz; Linearity: ± 0.2 dB (100 MHz to 3 GHz)
Directivity	± 0.2 dB in air (rotation around probe axis) ± 0.4 dB in air (rotation normal to probe axis)
Dynamic Range	2 V/m to > 1000 V/m (M3 or better device readings fall well below diode compression point)
Linearity:	± 0.2 dB
Dimensions	Overall length: 330 mm (Tip: 16 mm) Tip diameter: 8 mm (Body: 12 mm) Distance from probe tip to dipole centers: 2.5 mm

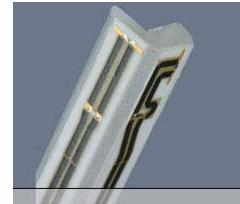

Figure 4
E-field Free-space
Probe

H3DV6 H-Field Probe Description

Construction:	Three concentric loop sensors with 3.8 mm loop diameters Resistively loaded detector diodes for linear response Built-in shielding against static charges
Frequency:	200 MHz to 3 GHz (absolute accuracy $\pm 6.0\%$, $k=2$); Output linearized
Directivity:	± 0.25 dB (spherical isotropy error)
Dynamic Range:	10 mA/m to 2 A/m at 1 GHz (M3 or better device readings fall well below diode compression point)
Dimensions:	Overall length: 330 mm (Tip: 40 mm) Tip diameter: 6 mm (Body: 12 mm) Distance from probe tip to dipole centers: 3 mm
E-Field Interference:	< 10% at 3 GHz (for plane wave)





Figure 5
H-Field Free-space
Probe

Probe Tip Description

HAC field measurements take place in the close near field with high gradients. Increasing the measuring distance from the source will generally decrease the measured field values (in case of the validation dipole approx. 10% per mm).

Magnetic field sensors are measuring the integral of the H-field across their sensor area surrounded by the loop. They are calibrated in a precise, homogeneous field. When measuring a gradient field, the result will be very close to the field in the center of the loop which is equivalent to the value of a homogeneous field equivalent to the center value. But it will be different from the field at the border of the loop.

PCTEST™ HAC REPORT		FCC MEASUREMENT REPORT		Reviewed by: Quality Manager
HAC Filename: HAC.0602170094.A3L	Test Dates: Feb. 22 - 23, 2006	EUT Type: Dual-Band CDMA Phone	FCC ID: A3LSCHA645	Page 7 of 69

Consequently, two sensors with different loop diameters - both calibrated ideally - would give different results when measuring from the edge of the probe sensor elements. The behavior for electrically small E-field sensors is equivalent. See below for distance plots from a WD which show the conservative nature of field readings at the probe element center vs. measurements at the sensor end:

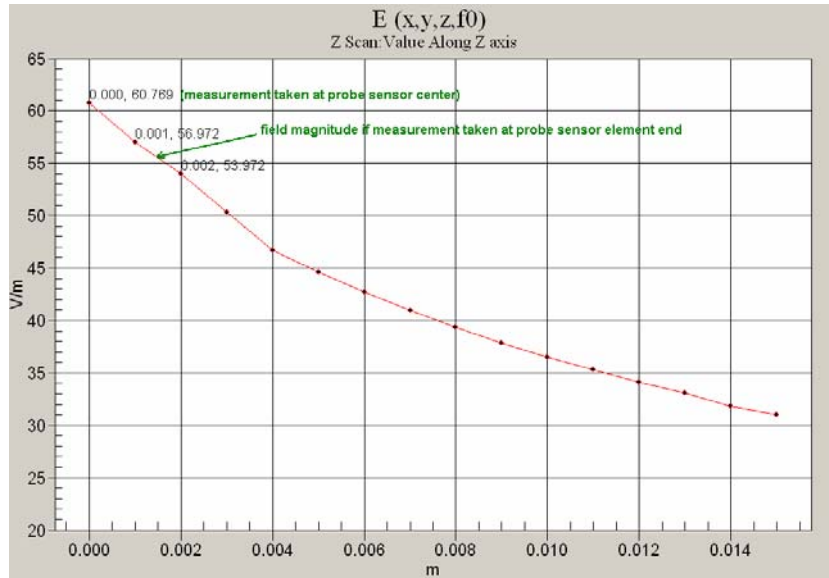

Figure 6 Z-axis scan at maximum point above wireless device for E-field

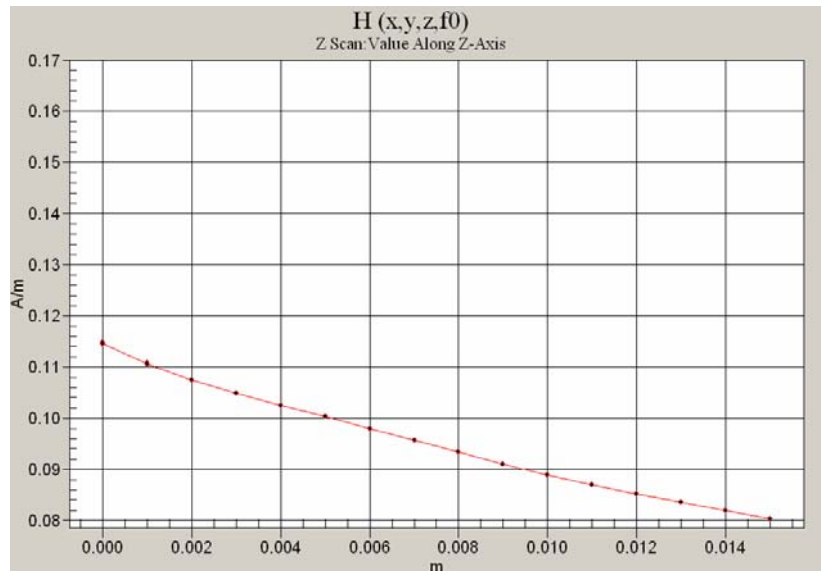



Figure 7 Z-Axis Scan at maximum point above wireless device for H-field

The magnetic field loops of the H3D probes are concentric, with the center 3mm from the tip for H3DV6. Their radius is 1.9mm.

The electric field probes have a more irregular internal geometry because it is physically not possible to have the 3 orthogonal sensors situated with the same center. The effect of the different sensor centers is accounted for in the HAC uncertainty budget ("sensor displacement"). Their geometric center is at 2.5mm from the tip, and the element ends are 1.1mm closer to the tip.

PCTEST™ HAC REPORT		FCC MEASUREMENT REPORT		Reviewed by: Quality Manager
HAC Filename: HAC.0602170094.A3L	Test Dates: Feb. 22 - 23, 2006	EUT Type: Dual-Band CDMA Phone	FCC ID: A3LSCHA645	Page 8 of 69

Connector Plan

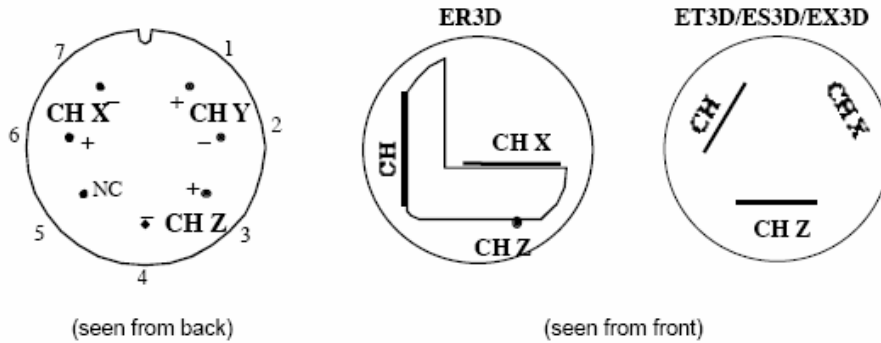

The antistatic shielding inside the probe is connected to the probe connector case.

It is recommended to connect the probes with the amplifier using a short and well shielded cable and to connect the cable shielding with the connector case.

Instrumentation Chain

Equation 1

Conversion of Connector Voltage u_i to E-Field E_i

$$E_i = \sqrt{\frac{u_i + (u_i^2 \cdot CF) / (DCP)}{Norm_i \cdot ConvF}}$$

whereby

- E_i : electric field in V/m
- u_i : voltage of channel i at the connector in μV
- $Norm_i$: sensitivity of channel i in $\mu V / (V/m)^2$
- $ConvF$: enhancement factor in liquid ($ConvF=1$ for Air)
- DCP : diode compression point in μV
- CF : signal crest factor (peak power/average power)

Conditions of Calibration

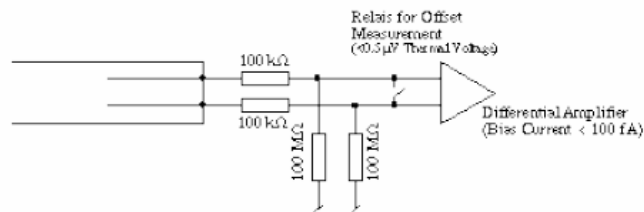

Please note:

- a lower input impedance of the amplifier will result in different sensitivity factors $Norm_i$ and DCP
- larger bias currents will cause higher offset

PCTEST™ HAC REPORT	PCTEST	FCC MEASUREMENT REPORT	SAMSUNG	Reviewed by: Quality Manager
HAC Filename: HAC.0602170094.A3L	Test Dates: Feb. 22 - 23, 2006	EUT Type: Dual-Band CDMA Phone	FCC ID: A3LSCHA645	Page 9 of 69

Probe Response to Frequency

The E-field sensors have inherently a very flat frequency response. They are calibrated with a number of frequencies resulting in a common calibration factor, with the frequency behavior documented in the calibration certificate (See also below).

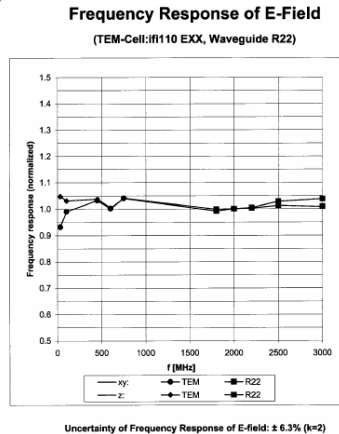

Figure 8 E-Field Probe Frequency Response

H-field sensors have a frequency dependent sensitivity which is evaluated for a series of frequencies also visible in the probe calibration certificate. The calibration factors result from a fitting algorithm. The proper conversion is calculated by the DASY4 software depending on the frequency setting in the procedure. See below for H-field frequency response:

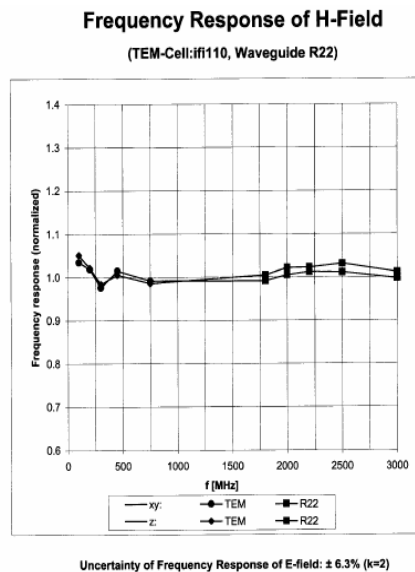



Figure 9 H-Field Probe Frequency Response

PCTEST™ HAC REPORT		FCC MEASUREMENT REPORT		Reviewed by: Quality Manager
HAC Filename: HAC.0602170094.A3L	Test Dates: Feb. 22 - 23, 2006	EUT Type: Dual-Band CDMA Phone	FCC ID: A3LSCHA645	Page 10 of 69

Conversion to Peak

Peak is defined as Peak Envelope Power. All raw measurements from the HAC measurement system are RMS values. The DASY4 system incorporates the crest factor of the signal in the computation of the RMS values (See Equation 1). Although the software also has capability to estimate the peak field by applying a square root of crest factor value to the readings, the probe modulation factor was applied manually instead per PC63.19 in the measurement tables in this report. The equation to convert the raw measurements in the data tables are:

$$\text{Peak Field} = 20 \cdot \log(\text{Raw} \cdot \text{PMF})$$

Where:

Peak Field = Peak field (in dBV/m or dBA/m)

Raw = Raw field measurement from the measurement system (in V/m or A/m).

PMF = Probe Modulation Factor (in linear units).

SPEAG Robotic System

E-field and H-field measurements are performed using the DASY4 automated dosimetric assessment system. The DASY4 is made by Schmid & Partner Engineering AG (SPEAG) in Zurich, Switzerland and consists of high precision robotics system (Staubli), robot controller, Pentium 4 computer, near-field probe, probe alignment sensor, and the HAC phantom. The robot is a six-axis industrial robot performing precise movements to position the probe to the location (points) of maximum electromagnetic field (EMF).





Figure 10
SPEAG Robotic System



Figure 11
PCTEST Lab Acoustics Facility

System Hardware

A cell controller system contains the power supply, robot controller, teach pendant (Joystick), and a remote control used to drive the robot motors. The PC consists of the Gateway Pentium 4 2.53 GHz computer with Windows XP system and RF Measurement Software DASY4 v4.5 (with HAC Extension), A/D interface card, monitor, mouse, and keyboard. The Staubli Robot is connected to the cell controller to allow software manipulation of the robot. A data acquisition electronic (DAE) circuit that performs the signal amplification, signal multiplexing, AD-conversion, offset measurements, mechanical surface detection, collision detection, etc. is connected to the Electro-optical coupler

PCTEST™ HAC REPORT		FCC MEASUREMENT REPORT		Reviewed by: Quality Manager
HAC Filename: HAC.0602170094.A3L	Test Dates: Feb. 22 - 23, 2006	EUT Type: Dual-Band CDMA Phone	FCC ID: A3LSCHA645	Page 11 of 69

(EOC). The EOC performs the conversion from the optical into digital electric signal of the DAE and transfers data to the PC plug-in card.

System Electronics

The DAE consists of a highly sensitive electrometer-grade preamplifier with auto-zeroing, a channel and gain-switching multiplexer, a fast 16 bit AD-converter and a command decoder and control logic unit. Transmission to the PC-card is accomplished through an optical downlink for data and status information and an optical uplink for commands and clock lines. The mechanical probe mounting device includes two different sensor systems for frontal and sidewise probe contacts. They are also used for mechanical surface detection and probe collision detection. The robot uses its own controller with a built in VME-bus computer.

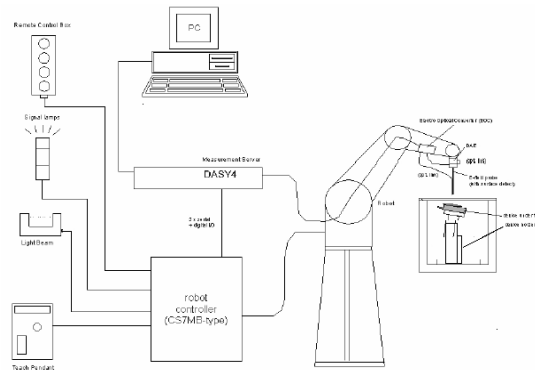



Figure 12
SPEAG Robotic System Diagram

DASY4 Instrumentation Chain

The first step of the evaluation is a linearization of the filtered input signal to account for the compression characteristics of the detector diode. The compensation depends on the input signal, the diode type and the DC-transmission factor from the diode to the evaluation electronics. If the exciting field is pulsed, the crest factor of the signal must be known to correctly compensate for peak power. The formula for each channel can be given as:

$$V_i = U_i + U_i^2 \cdot \frac{cf}{dcp_i}$$

with V_i = compensated signal of channel i (i = x, y, z)
 U_i = input signal of channel i (i = x, y, z)
 cf = crest factor of exciting field (DASY parameter)
 dcp_i = diode compression point (DASY parameter)

PCTEST™ HAC REPORT		FCC MEASUREMENT REPORT		Reviewed by: Quality Manager
HAC Filename: HAC.0602170094.A3L	Test Dates: Feb. 22 - 23, 2006	EUT Type: Dual-Band CDMA Phone	FCC ID: A3LSCHA645	Page 12 of 69

From the compensated input signals the primary field data for each channel can be evaluated:

$$\text{E - fieldprobes : } E_i = \sqrt{\frac{V_i}{Norm_i \cdot ConvF}}$$

$$\text{H - fieldprobes : } H_i = \sqrt{V_i} \cdot \frac{a_{i0} + a_{i1}f + a_{i2}f^2}{f}$$

with V_i = compensated signal of channel i (i = x, y, z)
 $Norm_i$ = sensor sensitivity of channel i (i = x, y, z)
 $\mu\text{V}/(\text{V/m})^2$ for E-field Probes
 $ConvF$ = sensitivity enhancement in solution
 a_{ij} = sensor sensitivity factors for H-field probes
 f = carrier frequency [GHz]
 E_i = electric field strength of channel i in V/m
 H_i = magnetic field strength of channel i in A/m

The RSS value of the field components gives the total field strength (Hermitian magnitude):



$$E_{tot} = \sqrt{E_x^2 + E_y^2 + E_z^2}$$

The primary field data are used to calculate the derived field units.

The measurement/integration time per point, as specified by the system manufacturer is >500 ms.

The signal response time is evaluated as the time required by the system to reach 90% of the expected final value after an on/off switch of the power source with an integration time of 500 ms and a probe response time of <5 ms. In the current implementation, DASY4 waits longer than 100 ms after having reached the grid point before starting a measurement, i.e., the response time uncertainty is negligible.



If the device under test does not emit a CW signal, the integration time applied to measure the electric field at a specific point may introduce additional uncertainties due to the discretization. The tolerances for the different systems had the worst-case of 2.6%.

PCTEST™ HAC REPORT		FCC MEASUREMENT REPORT		Reviewed by: Quality Manager
HAC Filename: HAC.0602170094.A3L	Test Dates: Feb. 22 - 23, 2006	EUT Type: Dual-Band CDMA Phone	FCC ID: A3LSCHA645	Page 13 of 69

6. TEST PROCEDURE

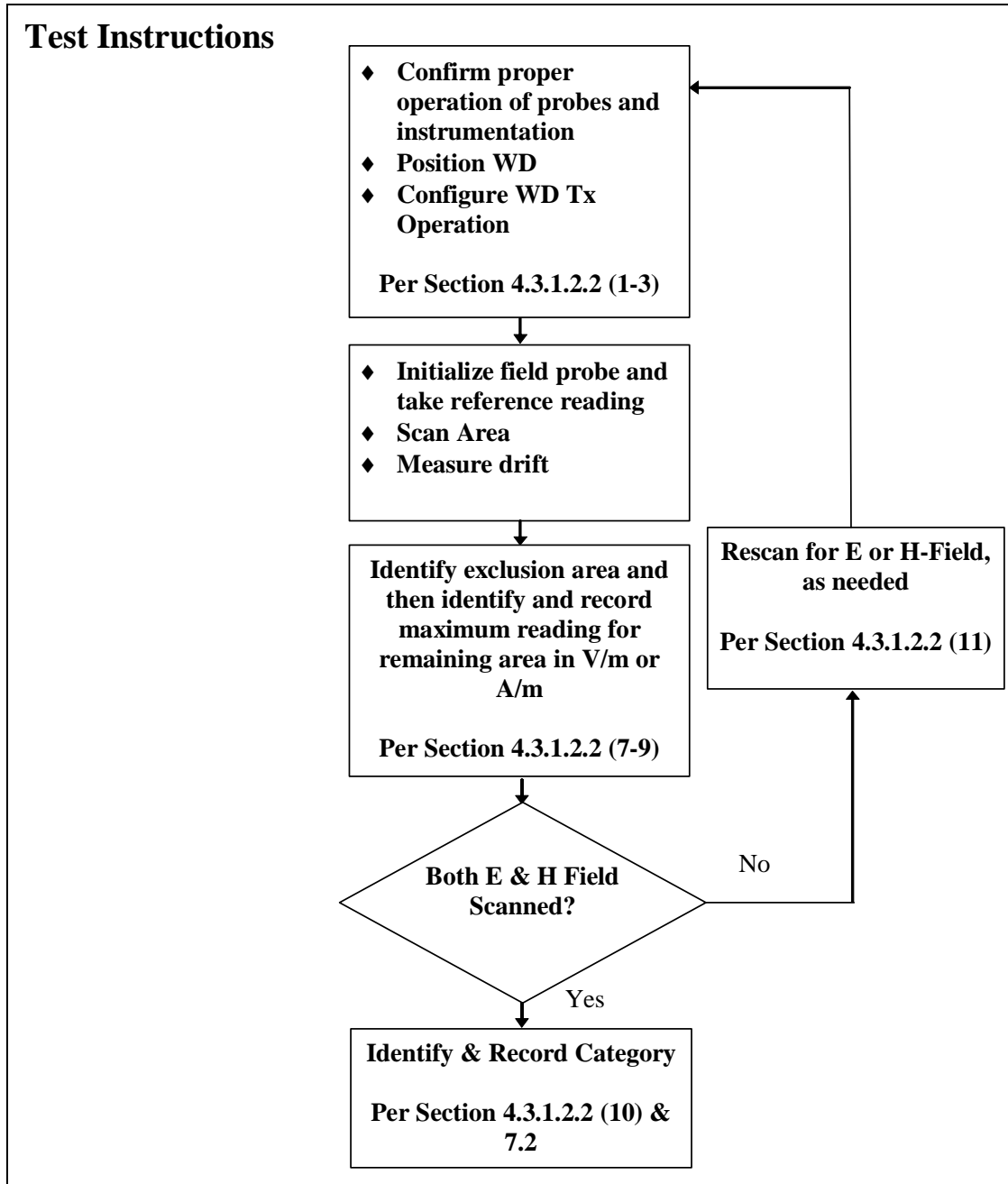
I. RF EMISSIONS



PCTEST™ HAC REPORT		FCC MEASUREMENT REPORT		Reviewed by: Quality Manager
HAC Filename: HAC.0602170094.A3L	Test Dates: Feb. 22 - 23, 2006	EUT Type: Dual-Band CDMA Phone	FCC ID: A3LSCHA645	Page 14 of 69

Test Setup

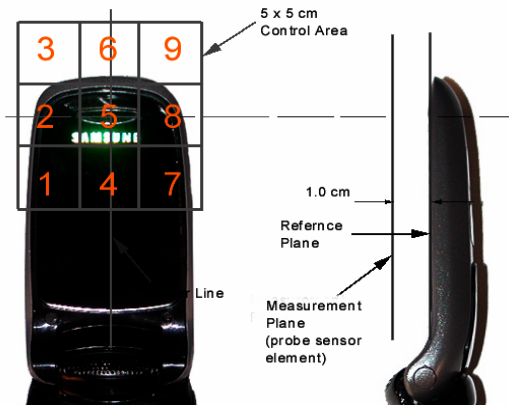

Figure 13
E/H-Field Emissions Test Setup Diagram

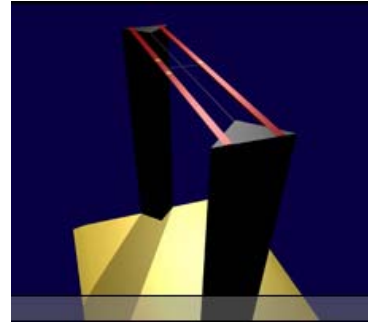



Figure 14
HAC Phantom

RF Emissions Test Procedure:

The following illustrate a typical RF emissions test scan over a wireless communications device:

1. Proper operation of the field probe, probe measurement system, other instrumentation, and the positioning system was confirmed.
2. WD is positioned in its intended test position, acoustic output point of the device perpendicular to the field probe.
3. The WD operation for maximum rated RF output power was configured and confirmed with the base station simulator, at the test channel and other normal operating parameters as intended for the test. The battery was ensured to be fully charged before each test.
4. The center sub-grid was centered over the center of the acoustic output (also audio band magnetic output, if applicable). The WD audio output was positioned tangent (as physically possible) to the measurement plane.
5. A surface calibration was performed before each setup change to ensure repeatable spacing and proper maintenance of the measurement plane using the HAC Phantom.
6. The measurement system measured the field strength at the reference location.
7. Measurements at 2mm increments in the 5 x 5 cm region were performed and recorded. A 360° rotation about the azimuth axis at the maximum interpolated position was measured. For the worst-case condition, the peak reading from this rotation was used in re-evaluating the HAC category.
8. The system performed a drift evaluation by measuring the field at the reference location.
9. Steps 1-8 were done for both the E and H-Field measurements.

PCTEST™ HAC REPORT		FCC MEASUREMENT REPORT		Reviewed by: Quality Manager
HAC Filename: HAC.0602170094.A3L	Test Dates: Feb. 22 - 23, 2006	EUT Type: Dual-Band CDMA Phone	FCC ID: A3LSCHA645	Page 15 of 69

7. SYSTEM CHECK

I. System Check Parameters

The input signal was an un-modulated continuous wave. The following points were taken into consideration in performing this check:

- Average Input Power $P = 100\text{mW RMS}$ (20dBm RMS) after adjustment for return loss
- The test fixture must meet the 2 wavelength separation criterion
- The proper measurement of the 1 cm probe to dipole separation, which is measured from top surface of the dipole to the calibration reference point of the sensor, defined by the probe manufacturer is shown in the following diagram:

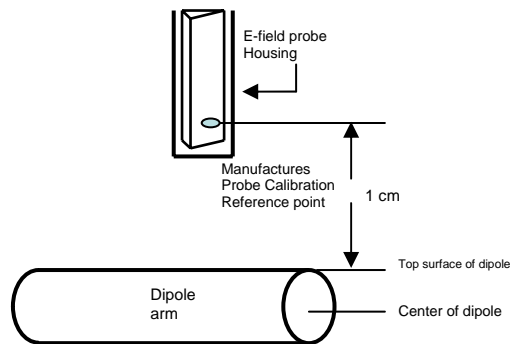

Figure 15
Separation Distance from Dipole to Field Probe

RF power was recorded using both an average reading meter and a peak reading meter. Readings of the probe are provided by the measurement system.

To assure proper operation of the near-field measurement probe the input power to the dipole shall be commensurate with the full rated output power of the wireless device (e.g. - for a cellular phone wireless device the average peak antenna input power will be on the order of 100mW (i.e. - 20dBm) RMS after adjustment for any mismatch.



II. Validation Procedure

A dipole antenna meeting the requirements given in PC63.19 was placed in the position normally occupied by the WD.

The length of the dipole was scanned with both E-field and H-field probes and the maximum values for each were recorded.

Measurement of CW

Using the near-field measurement system, scan the antenna over the radiating dipole and record the greatest field reading observed. Due to the nature of E-fields about free-space dipoles, the two E-field peaks measured over the dipole are averaged to compensate for non-parallelity of the setup (

PCTEST™ HAC REPORT		FCC MEASUREMENT REPORT		Reviewed by: Quality Manager
HAC Filename: HAC.0602170094.A3L	Test Dates: Feb. 22 - 23, 2006	EUT Type: Dual-Band CDMA Phone	FCC ID: A3LSCHA645	Page 16 of 69

see manufacturer method on dipole calibration certificates, page 2). Field strength measurements shall be made only when the probe is stationary.

RF power was recorded using both an average and a peak power reading meter.

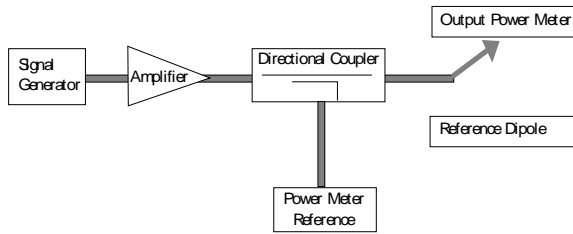

Figure 16
Setup for Desired Output Power to Dipole

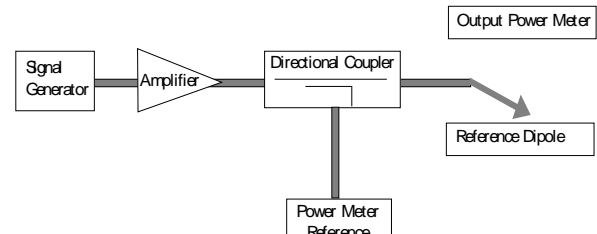

Figure 17
Setup to Dipole

Using this setup configuration, the signal generator was adjusted for the desired output power (100mW) at a specified frequency. The reference power from the coupled port of the directional coupler is recorded. Next, the output cable is connected to the reference dipole, as shown in Figure 17.

The input signal level was adjusted until the reference power from the coupled port of the directional coupler was the same as previously recorded, to compensate for the impedance mismatch between the output cable and the reference dipole. To assure proper operation of the near-field measurement probe the input power to the reference dipole was verified to the full rated output power of the wireless device. The dipole was secured in a holder in a manner to meet the 20 dB reflection. The near-field measurement probe was positioned over the dipole. The antenna was scanned over the appropriate sized area to cover the dipole from end to end. SPEAG uses 2D interpolation algorithms between the measured points. Please see below two dimensional plots showing that the interpolated values interpolate smoothly between 5mm steps for a free-space RF dipole:

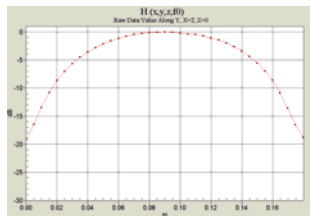

Figure 18

2-D Raw Data from scan along dipole axis

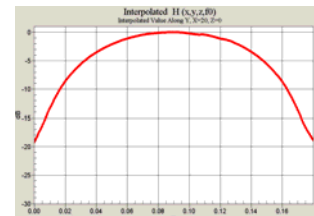

Figure 19

2-D Interpolated points from scan along dipole axis

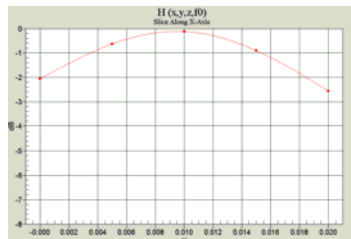

Figure 20

2-D Raw Data from scan along transverse axis

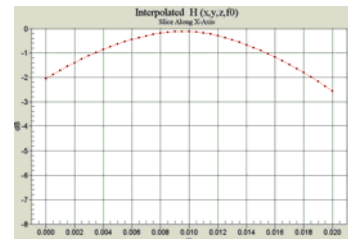



Figure 21

2-D Interpolated points from scan along transverse axis

PCTEST™ HAC REPORT		FCC MEASUREMENT REPORT		Reviewed by: Quality Manager
HAC Filename: HAC.0602170094.A3L	Test Dates: Feb. 22 - 23, 2006	EUT Type: Dual-Band CDMA Phone	FCC ID: A3LSCHA645	Page 17 of 69

III. System Check Results

Validation Results

Frequency (MHz)	Input Power (dBm)	E-field Result (V/m)	Target Field (V/m)	% Deviation
835	20.0	169.8	185.1	-8.3%
1880	20.0	144.8	145.8	-0.7%
Frequency (MHz)	Input Power (dBm)	H-field Result (A/m)	Target Field (A/m)	% Deviation
835	20.0	0.474	0.470	0.9%
1880	20.0	0.425	0.450	-5.6%

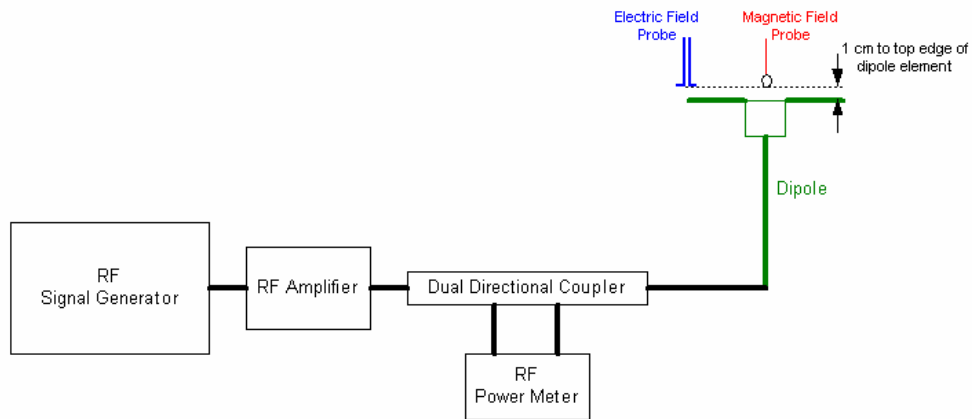

Figure 22
System Check Setup

PCTEST™ HAC REPORT	PCTEST	FCC MEASUREMENT REPORT	SAMSUNG	Reviewed by: Quality Manager
HAC Filename: HAC.0602170094.A3L	Test Dates: Feb. 22 - 23, 2006	EUT Type: Dual-Band CDMA Phone	FCC ID: A3LSCHA645	Page 18 of 69

8. MODULATION FACTOR

A calibration was made of the modulation response of the probe and its instrumentation chain. This calibration was performed with the field probe, attached to its instrumentation. The response of the probe system to a CW field at the frequency of interest is compared to its response to a modulated signal with equal peak amplitude to that of a CW signal. The field level of the test signals are ensured to be more than 10 dB above the ambient level and the noise floor of the instrumentation being used. The ratio of the CW reading to that taken with a modulated reading was applied to the DUT measurements.

This was done using the following procedure:

1. The probe was illuminated with a CW signal at the intended measurement frequency.
2. The probe was positioned at the field maxima over the dipole antenna (determined after an area scan over the dipole).
3. The reading of the probe measurement system of the CW signal at the maximum point was recorded.
4. Using a Spectrum Analyzer, the modulated signal adjusted with the same peak level of the CW signal was determined.
5. The probe measurement system reading was recorded with the modulated signal. The appropriate system crest factors for the modulation type were configured in the software to the system measurements.
6. The ratio of the CW reading to modulated signal reading is the probe modulation factor (PMF) for the modulation and field probe combination.
7. Steps 1-6 were repeated at all frequency bands and for both E and H field probes.

The modulation factors obtained were applied to readings taken of the actual wireless device, in order to obtain an accurate peak field reading using the formula:

$$\text{Peak} = 20 \cdot \log (\text{Raw} \cdot \text{PMF})$$

This method correlates well with the modulation using the DUT in the alternative substitution method. See below for correlation of signal:

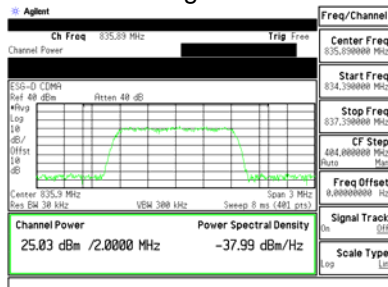

Figure 23
Signal Generator Modulated Signal

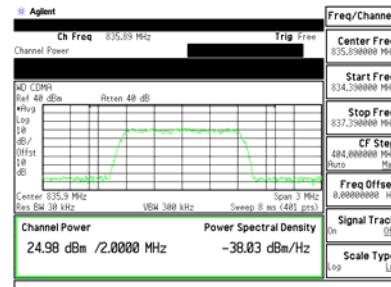



Figure 24
Wireless Device Modulated Signal

PCTEST™ HAC REPORT		FCC MEASUREMENT REPORT		Reviewed by: Quality Manager
HAC Filename: HAC.0602170094.A3L	Test Dates: Feb. 22 - 23, 2006	EUT Type: Dual-Band CDMA Phone	FCC ID: A3LSCHA645	Page 19 of 69

Modulation Factors:

f (MHz)	Protocol	E-Field (V/m)	H-Field (A/m)	E-Field Modulation Factor	H-Field Modulation Factor
835	AM	204.5	0.5971	1.411	1.326
835	CDMA	311	0.9799	0.928	0.808
835	CW	288.6	0.7915		
1880	AM	155.4	0.6561	1.445	1.187
1880	CDMA	226.8	1.201	0.990	0.649
1880	CW	224.5	0.7789		

f (MHz)	Protocol	E-Field (V/m)	E-Field Modulation Factor
1880	CDMA / SO3	60.53	2.794
1880	CW	169.1	

Figure 25
Modulation Factors

CW and Modulated Signal Zero-Span plots:

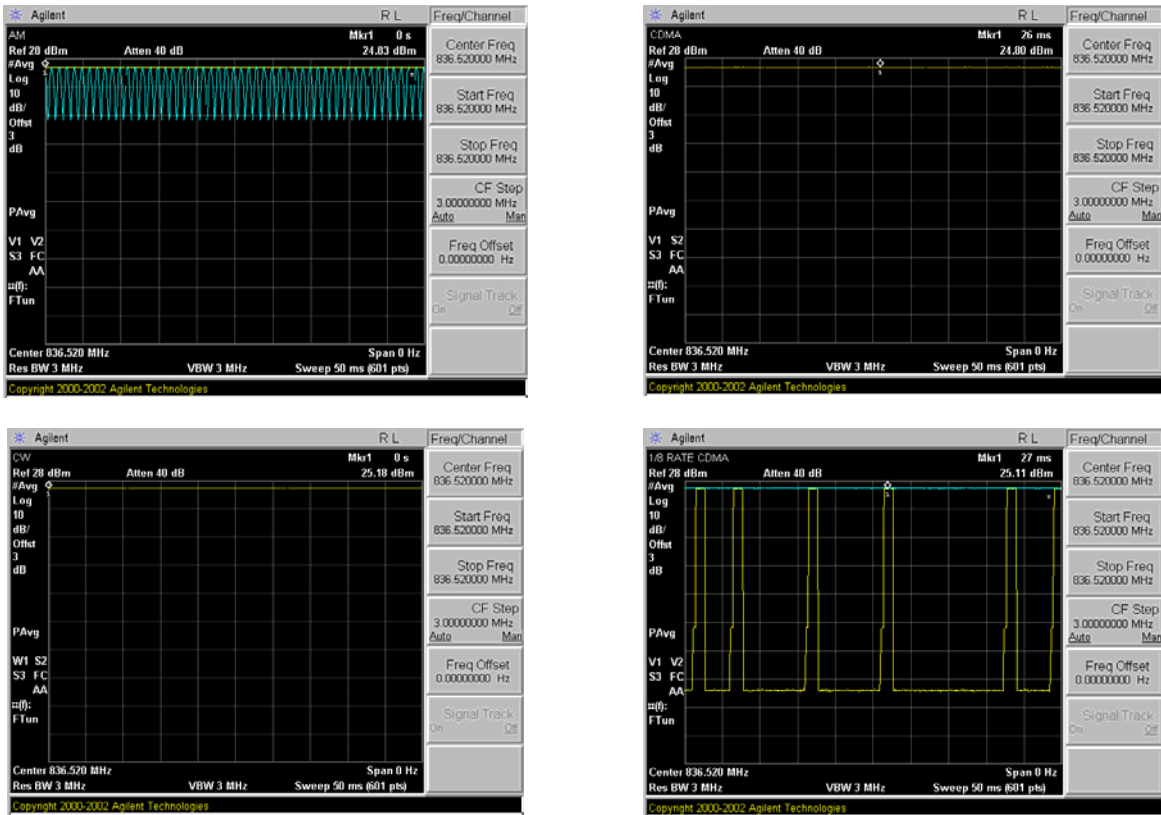



Figure 26 Zero-Span Plots

PCTEST™ HAC REPORT		FCC MEASUREMENT REPORT		Reviewed by: Quality Manager
HAC Filename: HAC.0602170094.A3L	Test Dates: Feb. 22 - 23, 2006	EUT Type: Dual-Band CDMA Phone	FCC ID: A3LSCHA645	Page 20 of 69

9. OVERALL MEASUREMENT SUMMARY

FCC ID:	A3LSCHA645
Model:	SCH-A645
S/N:	12

I. E-FIELD EMISSIONS:



**Table 1
HAC Data Summary for E-field**

Mode	Channel	Backlight	SO	Battery	Antenna	Conducted Power at BS (dBm)	Time Avg. Field (V/m)	Peak Field (dBV/m)	FCC Limit (dBV/m)	FCC MARGIN (dB)	RESULT	Excl Blocks per 4.3.1.2.2
E-field Emissions												
CDMA	1013	off	SO2	Standard	Fixed	24.91	81.0	37.5	41.0	-3.48	M3	none
CDMA	384	off	SO2	Standard	Fixed	24.41	51.7	33.6	41.0	-7.38	M4	none
CDMA	777	off	SO2	Standard	Fixed	24.81	81.3	37.6	41.0	-3.45	M3	none
PCS	25	off	SO2	Standard	Fixed	25.11	91.6	39.2	41.0	-1.85	M3	none
PCS	600	off	SO2	Standard	Fixed	25.21	90.3	39.0	41.0	-1.97	M3	none
PCS	1175	off	SO2	Standard	Fixed	25.01	90.7	39.1	41.0	-1.93	M3	none
PCS	25	on	SO2	Standard	Fixed	25.11	100.0	39.4	41.0	-1.65	M3	none
PCS	25	on	SO3	Standard	Fixed	25.11	39.2	40.5	41.0	-0.45	M3	none



Figure 27
Sample E-field Scan Overlay

Note: Worst-case measurement evaluated for worst-case 1/8 rate gating condition in RC1/SO3; Backlight=off, Mute=Yes

PCTEST™ HAC REPORT		FCC MEASUREMENT REPORT		Reviewed by: Quality Manager
HAC Filename: HAC.0602170094.A3L	Test Dates: Feb. 22 - 23, 2006	EUT Type: Dual-Band CDMA Phone	FCC ID: A3LSCHA645	Page 21 of 69

FCC ID:	A3LSCHA645
Model:	SCH-A645
S/N:	12



II. H-FIELD EMISSIONS:

Table 2
HAC Data Summary for H-field

Mode	Channel	Backlight	SO	Battery	Antenna	Conducted Power at BS (dBm)	Time Avg. Field (A/m)	Peak Field (dBA/m)	FCC Limit (dBA/m)	FCC MARGIN (dB)	RESULT	Excl Blocks per 4.3.1.2.2
H-field Emissions												
CDMA	1013	off	SO2	Standard	Fixed	24.91	0.124	-20.0	-9.4	-10.56	M4	none
CDMA	384	off	SO2	Standard	Fixed	24.41	0.100	-21.9	-9.4	-12.49	M4	none
CDMA	777	off	SO2	Standard	Fixed	24.81	0.122	-20.1	-9.4	-10.70	M4	none
PCS	25	off	SO2	Standard	Fixed	25.11	0.319	-13.7	-9.4	-4.30	M3	none
PCS	600	off	SO2	Standard	Fixed	25.21	0.314	-13.8	-9.4	-4.42	M3	none
PCS	1175	off	SO2	Standard	Fixed	25.01	0.269	-15.2	-9.4	-5.78	M4	none



Figure 28
Sample H-field Scan Overlay

PCTEST™ HAC REPORT		FCC MEASUREMENT REPORT		Reviewed by: Quality Manager
HAC Filename: HAC.0602170094.A3L	Test Dates: Feb. 22 - 23, 2006	EUT Type: Dual-Band CDMA Phone	FCC ID: A3LSCHA645	Page 22 of 69

FCC ID:	A3LSCHA645
Model:	SCH-A645
S/N:	12

III. Worst-case Configuration Evaluation

Table 3
Peak Reading 360° Probe Rotation at Azimuth axis

Mode	Channel	Backlight	SO	Battery	Antenna	Conducted Power at BS (dBm)	Time Avg. Field (V/m)	Peak Field (dBV/m)	FCC Limit (dBV/m)	FCC MARGIN (dB)	RESULT
Probe Rotation at Worst-case											
PCS	25	on	SO2	Standard	Fixed	25.11	101.4	39.5	41.0	-1.53	M3

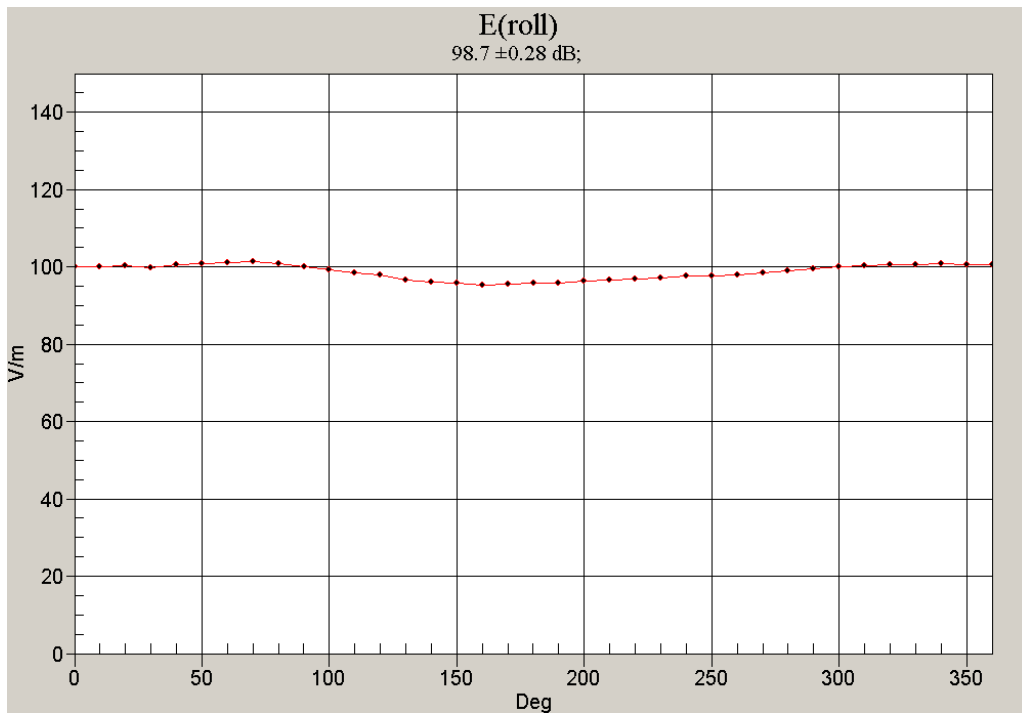



Figure 29
Worst-Case Probe Rotation about Azimuth axis

* Note: Location of probe rotation is shown in Figure 27 or Figure 28



PCTEST™ HAC REPORT		FCC MEASUREMENT REPORT		Reviewed by: Quality Manager
HAC Filename: HAC.0602170094.A3L	Test Dates: Feb. 22 - 23, 2006	EUT Type: Dual-Band CDMA Phone	FCC ID: A3LSCHA645	Page 23 of 69

10. EQUIPMENT LIST

Manufacturer	Make / Equipment	Calibration Due	Asset No.
HP	437B Power Meter	May 2006	3125U24437
Amplifier Research	5S1G4 (5W, 800MHz-4.2GHz)	January 2007	22322
Gigatronics	80701A (0.05-18GHz) Power Sensor	April 2006	1833460
HP	8482H (30mW-3W) Power Sensor	February 2007	2237A02084
HP	8594A Spectrum Analyzer	February 2007	3051A00187
Gigatronics	8657A Universal Power Meter	April 2006	1835256
HP	8753E (30kHz-6GHz) Network Analyzer	February 2007	JP38020182
Agilent	8960 Base Station Simulator	January 2007	PCT080
Agilent	Base Station Simulator	May 2006	661
Rohde & Schwarz	CMD80 Base Station Simulator	June 2006	830805/005
Rohde & Schwarz	CMU200 Base Station Simulator	October 2006	650378
Agilent	ESG-D Signal Generator	October 2006	PCT800
Optix	Fiber-Optic Line	N/A	
SPEAG	Freespace 1880 MHz Dipole	February 2007	1002
SPEAG	Freespace 1900 MHz Dipole	February 2007	1002
SPEAG	Freespace 2450 MHz Dipole	February 2007	1004
SPEAG	Freespace H-field Probe	August 2006	6170
SPEAG	Freespace E-field Probe	August 2006	2353
Bruel & Kjaer	HATS System	January 2007	687
Hosa	High Precision TRS Cable	N/A	
EMCO	Model 3115 (1-18GHz) Horn Antenna	October 2006	9203-2178
EMCO	Model 3115 (1-18GHz) Horn Antenna	October 2006	9704-5182
Rohde & Schwarz	NRVS Power Meter	June 2006	
RF Lindgren Model 26-2/2-0	Shielded Screen Room	N/A	6710 (PCT270)
MicroCoax	(1.0-26.5GHz) Microwave Cables	N/A	N/A
HP	8648D (9kHz-4GHz) Signal Generator	October 2006	3613A00315
Rohde & Schwarz	(0.1-1000MHz) Signal Generator	September 2006	894215/012
Ray Proof Model S81	Shielded Semi-Anechoic Chamber	N/A	R2437 (PCT278)
Narda	3020A (50-1000MHz) Bi-Directional Coax Coupler	January 2007	
HP	8901A Modulation Analyzer	January 2007	2432A03467
HP	8903B Audio Analyzer	January 2007	3011A09025

Table 4
Equipment List

*Calibration traceable to the National Institute of Standards and Technology (NIST).

PCTEST™ HAC REPORT		FCC MEASUREMENT REPORT		Reviewed by: Quality Manager
HAC Filename: HAC.0602170094.A3L	Test Dates: Feb. 22 - 23, 2006	EUT Type: Dual-Band CDMA Phone	FCC ID: A3LSCHA645	Page 24 of 69

11. MEASUREMENT UNCERTAINTY



Wireless Communications Device Near-Field Measurement						
Uncertainty Estimation						
Uncertainty Component	Data (dB)	Data Type	Prob. Dist.	Divisor	Unc. (dB)	Notes/Comments
Measurement System						
RF System Reflections	0.50	Tolerance	R	1.73	0.30	* Refl. < -20 dB
RF Ambient Conditions	0.20	Tolerance	R	1.73	0.12	
Field Probe Conversion Factor	0.42	Tolerance	R	1.73	0.25	
Field Probe Isotropy	0.11	Tolerance	R	1.73	0.06	
Field Probe Frequency Response	0.135	Tolerance	R	1.73	0.08	
Field Probe Linearity	0.025	Tolerance	R	1.73	0.01	
Boundary Effects	0.105	Accuracy	R	1.73	0.06	
Sensor Displacement	0.66	Accuracy	R	1.73	0.39	*
Probe Positioning Accuracy	0.20	Accuracy	R	1.73	0.12	*
Probe Positioner	0.050	Accuracy	R	1.73	0.03	*
Extrapolation/Interpolation	0.045	Tolerance	R	1.73	0.03	*
System Detection Limit	0.05	Tolerance	R	1.73	0.03	*
Readout Electronics	0.015	Tolerance	N	1.00	0.02	*
Integration Time	0.11	Tolerance	R	1.73	0.06	*
Response Time	0.033	Tolerance	R	1.73	0.02	*
Phantom Thickness	0.10	Tolerance	R	1.73	0.06	*
Test Sample Related						
Device Positioning Vertical	0.4	Tolerance	R	1.73	0.24	*
Device Positioning Lateral	0.045	Tolerance	N	1	0.05	*
Device Holder and Phantom	0.1	Tolerance	R	1.73	0.06	*
Power Drift	0.21	Tolerance	N	1	0.21	
<i>Combined Standard Uncertainty (k=1)</i>					0.65	16.1%
<i>Expanded Uncertainty (k=2) [95% confidence]</i>					1.30	32.3%

Table 5
Uncertainty Estimation Table

Notes:



1. Test equipments are calibrated according to techniques outlined in NIS81, NIS3003 and NIST Tech Note 1297. All equipments have traceability according to NIST. Measurement Uncertainties are defined in further detail in NIS 81 and NIST Tech Note 1297 and UKAS M3003.
2. * Uncertainty specifications from Schmidt & Partner Engineering AG (not site specific)

Measurement uncertainty reflects the quality and accuracy of a measured result as compared to the true value. Such statements are generally required when stating results of measurements so that it is clear to the intended audience that the results may differ when reproduced by different facilities. Measurement results vary due to the measurement uncertainty of the instrumentation, measurement technique, and test engineer. Most uncertainties are calculated using the tolerances of the instrumentation used in the measurement, the measurement setup variability, and the technique used in performing the test. While not generally included, the variability of the equipment under test also figures into the overall measurement uncertainty. Another component of the overall uncertainty is based on the variability of repeated measurements (so-called Type A uncertainty). This may mean that the Hearing Aid immunity tests may have to be repeated by taking down the test setup and resetting it up so that there are a statistically significant number of repeat measurements to identify the measurement uncertainty. By combining the repeat measurement results with that of the instrumentation chain using the technique contained in NIS 81 and NIS 3003, the overall measurement uncertainty was estimated.

PCTEST™ HAC REPORT		FCC MEASUREMENT REPORT		Reviewed by: Quality Manager
HAC Filename: HAC.0602170094.A3L	Test Dates: Feb. 22 - 23, 2006	EUT Type: Dual-Band CDMA Phone	FCC ID: A3LSCHA645	Page 25 of 69

12. TEST DATA

See following Attached Pages for Test Data.

PCTEST™ HAC REPORT		FCC MEASUREMENT REPORT		Reviewed by: Quality Manager
HAC Filename: HAC.0602170094.A3L	Test Dates: Feb. 22 - 23, 2006	EUT Type: Dual-Band CDMA Phone	FCC ID: A3LSCHA645	Page 26 of 69

Date: 2/20/2006



PCTEST Hearing-Aid Compatibility Facility

DUT: HAC Dipole 835 MHz

Type: CD835V3
Serial: 1003

Communication System: CW; Frequency: 835 MHz;

Measurement Standard: DASY4 (High Precision Assessment)

DASY4 Configuration:

- Probe: ER3DV6 - SN2353; Calibrated: 8/2/2005
- Sensor-Surface: 0mm (Fix Surface)
- Electronics: DAE4 Sn665; Calibrated: 8/8/2005
- Phantom: HAC; Type: SD HAC P01 BA;
- Measurement SW: DASY4, V4.6 Build 23;

835MHz, 100mW/20dBm/Hearing Aid Compatibility Test (41x361x1): Measurement

grid: dx=5mm, dy=5mm

Probe Modulation Factor = 1.00

Reference Value = 110.4 V/m; Power Drift = -0.336 dB

Average value of Total (interpolated) = 169.8 V/m

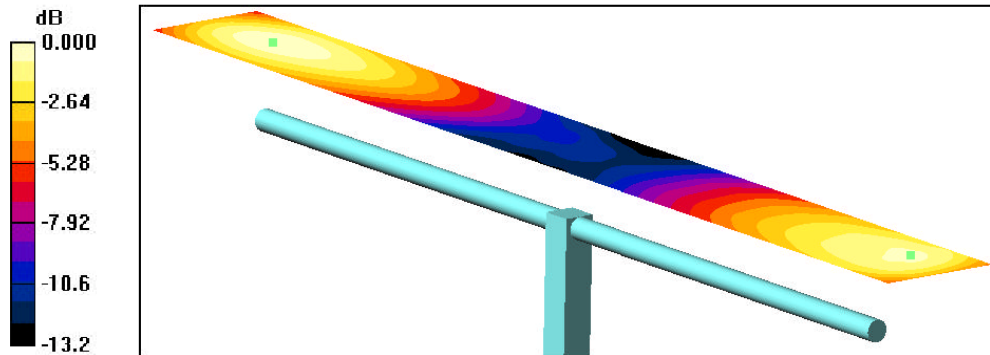

0 dB = 176.0V/m

© 2006 PCTEST

PCTEST™ HAC REPORT		FCC MEASUREMENT REPORT		Reviewed by: Quality Manager
HAC Filename: HAC.0602170094.A3L	Test Dates: Feb. 22 - 23, 2006	EUT Type: Dual-Band CDMA Phone	FCC ID: A3LSCHA645	Page 27 of 69



PCTEST Hearing-Aid Compatibility Facility

DUT: HAC Dipole 835 MHz

Type: CD835V3
Serial: 1003

Communication System: CW; Frequency: 835 MHz;

Measurement Standard: DASy4 (High Precision Assessment)

DASy4 Configuration:

- Probe: H3DV6 - SN6170; Calibrated: 8/8/2005
- Sensor-Surface: 0mm (Fix Surface)
- Electronics: DAE4 Sn665; Calibrated: 8/8/2005
- Phantom: HAC; Type: SD HAC P01 BA;
- Measurement SW: DASy4, V4.6 Build 23;

835MHz, 100mW/20dBm/Hearing Aid Compatibility Test (41x361x1): Measurement

grid: dx=5mm, dy=5mm

Probe Modulation Factor = 1.00

Reference Value = 0.519 A/m; Power Drift = -0.369 dB

Maximum value of Total (interpolated) = 0.474 A/m

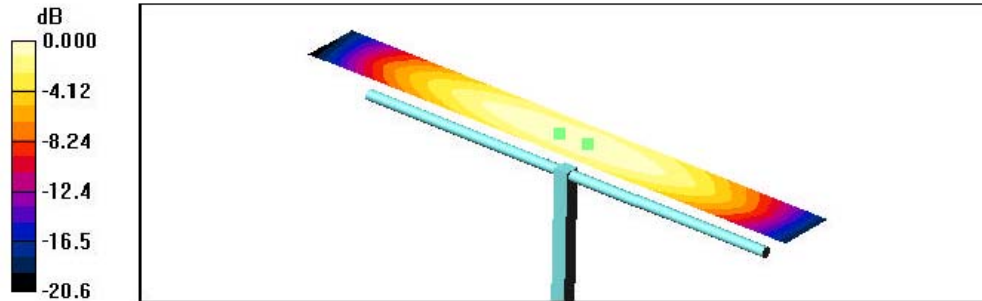

0 dB = 0.474A/m

PCTEST™ HAC REPORT		FCC MEASUREMENT REPORT		Reviewed by: Quality Manager
HAC Filename: HAC.0602170094.A3L	Test Dates: Feb. 22 - 23, 2006	EUT Type: Dual-Band CDMA Phone	FCC ID: A3LSCHA645	Page 28 of 69

Date: 2/20/2006



PCTEST Hearing-Aid Compatibility Facility

DUT: HAC Dipole 1900 MHz

Type: CD1880V3
Serial: 1002

Communication System: CW; Frequency: 1880 MHz;

Measurement Standard: DAS4 (High Precision Assessment)

DASY4 Configuration:

- Probe: ER3DV6 - SN2353; Calibrated: 8/2/2005
- Sensor-Surface: 0mm (Fix Surface)
- Electronics: DAE4 Sn665; Calibrated: 8/8/2005
- Phantom: HAC; Type: SD HAC P01 BA;
- Measurement SW: DAS4, V4.6 Build 23;

1880MHz, 100mW/20dBm/Hearing Aid Compatibility Test (41x181x1): Measurement

grid: dx=5mm, dy=5mm

Probe Modulation Factor = 1.00

Reference Value = 140.7 V/m; Power Drift = 0.198 dB

Maximum value of Total (interpolated) = 148.6 V/m

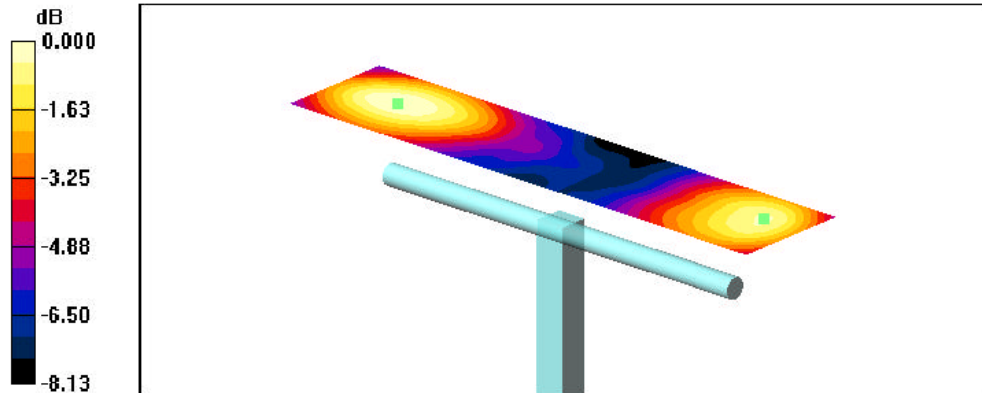

0 dB = 148.6V/m

© 2006 PCTEST

PCTEST™ HAC REPORT		FCC MEASUREMENT REPORT		Reviewed by: Quality Manager
HAC Filename: HAC.0602170094.A3L	Test Dates: Feb. 22 - 23, 2006	EUT Type: Dual-Band CDMA Phone	FCC ID: A3LSCHA645	Page 29 of 69

Date: 2/20/2006



PCTEST Hearing-Aid Compatibility Facility

DUT: HAC Dipole 1900 MHz

Type: CD1880V3
Serial: 1002

Communication System: CW; Frequency: 1880 MHz;

Measurement Standard: DAS4 (High Precision Assessment)

DASY4 Configuration:

- Probe: H3DV6 - SN6170; Calibrated: 8/8/2005
- Sensor-Surface: 0mm (Fix Surface)
- Electronics: DAE4 Sn665; Calibrated: 8/8/2005
- Phantom: HAC; Type: SD HAC P01 BA;
- Measurement SW: DAS4, V4.6 Build 23;

1880MHz, 100mW/20dBm/Hearing Aid Compatibility Test (41x181x1): Measurement

grid: dx=5mm, dy=5mm

Probe Modulation Factor = 1.00

Reference Value = 0.455 A/m; Power Drift = -0.050 dB

Maximum value of Total (interpolated) = 0.425 A/m

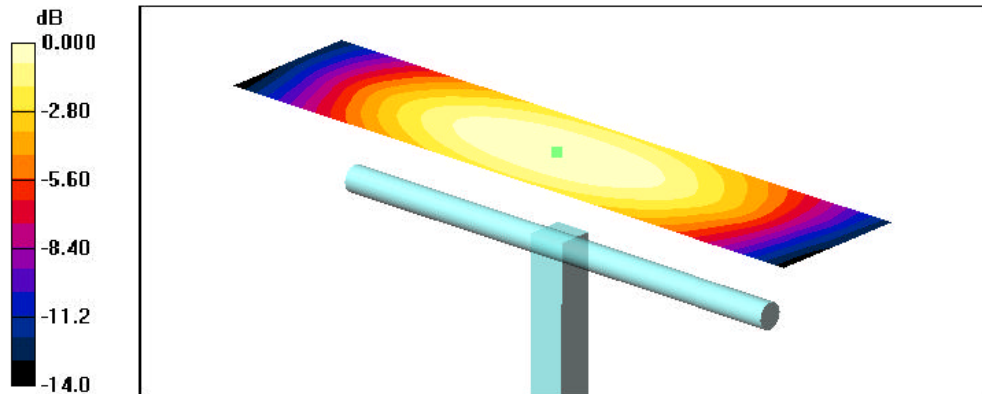

0 dB = 0.425A/m

© 2006 PCTEST

PCTEST™ HAC REPORT		FCC MEASUREMENT REPORT		Reviewed by: Quality Manager
HAC Filename: HAC.0602170094.A3L	Test Dates: Feb. 22 - 23, 2006	EUT Type: Dual-Band CDMA Phone	FCC ID: A3LSCHA645	Page 30 of 69



PCTEST Hearing-Aid Compatibility Facility

DUT: SCH-A645

Type: Dual-Band CDMA Phone
 Serial: 12
 Backlight off
 Duty Cycle: 1:1

Communication System: Cellular CDMA; Frequency: 848.31 MHz;

Measurement Standard: DASy4 (High Precision Assessment)

DASy4 Configuration:

- Probe: ER3DV6 - SN2353; Calibrated: 8/2/2005
- Sensor-Surface: (Fix Surface)
- Electronics: DAE4 Sn665; Calibrated: 8/8/2005
- Phantom: HAC; Type: SD HAC P01 BA;
- Measurement SW: DASy4, V4.6 Build 23;

High.ch/Hearing Aid Compatibility Test (251x251x1): Measurement grid: dx=2mm, dy=2mm

Maximum value of peak Total field = 75.5 V/m

Probe Modulation Factor = 0.928

Reference Value = 76.0 V/m; Power Drift = -0.177 dB

Hearing Aid Near-Field Category: M3 (AWF 0 dB)

Peak E-field in V/m

Grid 1	Grid 2	Grid 3
64.3	66.1	60.5
Grid 4	Grid 5	Grid 6
73.6	75.5	68.9
Grid 7	Grid 8	Grid 9
67.7	68.0	62.2

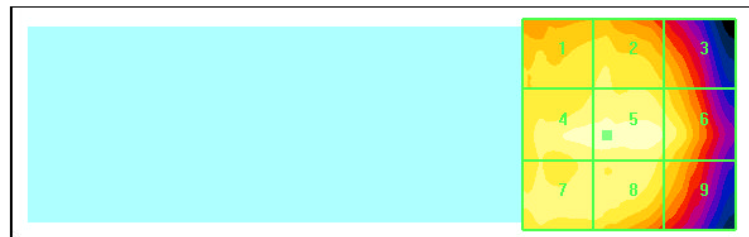
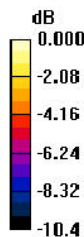

0 dB = 75.5V/m

PCTEST™ HAC REPORT		FCC MEASUREMENT REPORT		Reviewed by: Quality Manager
HAC Filename: HAC.0602170094.A3L	Test Dates: Feb. 22 - 23, 2006	EUT Type: Dual-Band CDMA Phone	FCC ID: A3LSCHA645	Page 31 of 69



PCTEST Hearing-Aid Compatibility Facility

DUT: SCH-A645

Type: Dual-Band CDMA Phone

Serial: 12

Backlight off

Duty Cycle: 1:1

Communication System: Cellular CDMA; Frequency: 824.7 MHz;

Measurement Standard: DAS4 (High Precision Assessment)

DAS4 Configuration:

- Probe: H3DV6 - SN6170; Calibrated: 8/8/2005
- Sensor-Surface: (Fix Surface)
- Electronics: DAE4 Sn665; Calibrated: 8/8/2005
- Phantom: HAC; Type: SD HAC P01 BA;
- Measurement SW: DAS4, V4.6 Build 23;

Low.ch/Hearing Aid Compatibility Test (251x251x1): Measurement grid: dx=2mm, dy=2mm

Maximum value of peak Total field = 0.100 A/m

Probe Modulation Factor = 0.808

Reference Value = 0.073 A/m; Power Drift = -0.46 dB

Hearing Aid Near-Field Category: M4 (AWF 0 dB)

Peak H-field in A/m

Grid 1	Grid 2	Grid 3
0.094	0.060	0.038
Grid 4	Grid 5	Grid 6
0.096	0.062	0.037
Grid 7	Grid 8	Grid 9
0.100	0.063	0.036

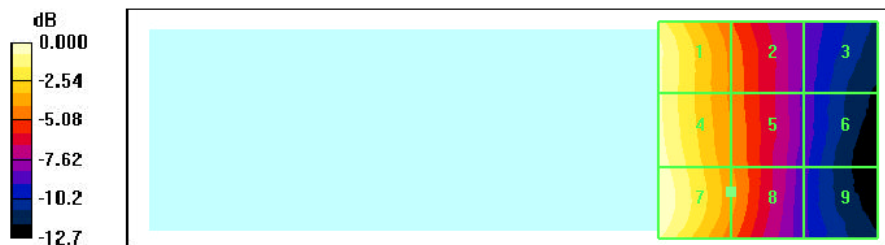

0 dB = 0.100A/m

PCTEST™ HAC REPORT		FCC MEASUREMENT REPORT		Reviewed by: Quality Manager
HAC Filename: HAC.0602170094.A3L	Test Dates: Feb. 22 - 23, 2006	EUT Type: Dual-Band CDMA Phone	FCC ID: A3LSCHA645	Page 32 of 69



PCTEST Hearing-Aid Compatibility Facility

DUT: SCH-A645

Type: Dual-Band CDMA Phone
 Serial: 12
 Backlight off
 Duty Cycle: 1:1

Communication System: PCS CDMA; Frequency: 1851.25 MHz;

Measurement Standard: DAS4 (High Precision Assessment)

DASY4 Configuration:

- Probe: ER3DV6 - SN2353; Calibrated: 8/2/2005
- Sensor-Surface: (Fix Surface)
- Electronics: DAE4 Sn665; Calibrated: 8/8/2005
- Phantom: HAC; Type: 3D HAC P01 BA;
- Measurement SW: DAS4, V4.6 Build 23;

Low.ch Backlight On/Hearing Aid Compatibility Test (251x251x1): Measurement grid:

dx=2mm, dy=2mm

Maximum value of peak Total field = 100.0 V/m

Probe Modulation Factor = 1.00

Reference Value = 103.7 V/m; Power Drift = -0.462 dB

Hearing Aid Near-Field Category: M3 (AWF 0 dB)

Peak E-field in V/m

Grid 1	Grid 2	Grid 3
72.4	97.8	96.9
Grid 4	Grid 5	Grid 6
71.9	100.0	99.4
Grid 7	Grid 8	Grid 9
62.5	86.9	86.2

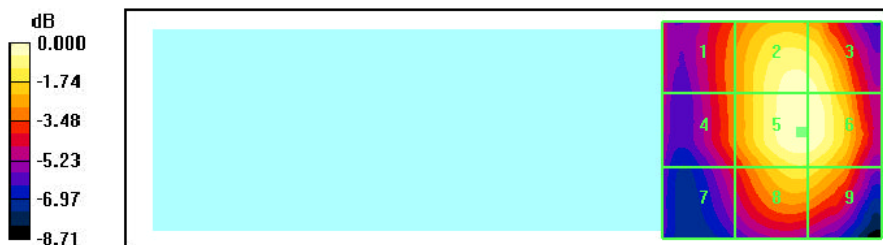

0 dB = 100.0V/m

PCTEST™ HAC REPORT		FCC MEASUREMENT REPORT		Reviewed by: Quality Manager
HAC Filename: HAC.0602170094.A3L	Test Dates: Feb. 22 - 23, 2006	EUT Type: Dual-Band CDMA Phone	FCC ID: A3LSCHA645	Page 33 of 69



PCTEST Hearing-Aid Compatibility Facility

DUT: SCH-A645

Type: Dual-Band CDMA Phone
 Serial: 12
 Backlight off
 Duty Cycle: 1:1

Communication System: PCS CDMA; Frequency: 1851.25 MHz;

Measurement Standard: DAS4 (High Precision Assessment)

DASY4 Configuration:

- Probe: H3DV6 - SN6170; Calibrated: 8/8/2005
- Sensor-Surface: (Fix Surface)
- Electronics: DAE4 Sn665; Calibrated: 8/8/2005
- Phantom: HAC; Type: 3D HAC P01 BA;
- Measurement SW: DAS4, V4.6 Build 23;

Low.ch/Hearing Aid Compatibility Test (251x251x1): Measurement grid: dx=2mm, dy=2mm

Maximum value of peak Total field = 0.207 A/m
 Probe Modulation Factor = 0.649
 Reference Value = 0.193 A/m; Power Drift = -0.51 dB
Hearing Aid Near-Field Category: M3 (AWF 0 dB)

Peak H-field in A/m

Grid 1	Grid 2	Grid 3
0.207	0.164	0.091
Grid 4	Grid 5	Grid 6
0.192	0.154	0.085
Grid 7	Grid 8	Grid 9
0.174	0.130	0.069

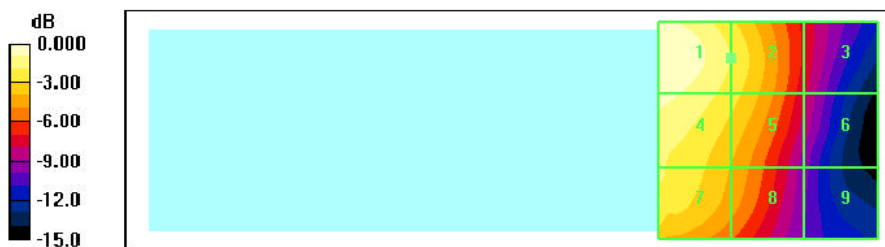



0 dB = 0.207A/m

PCTEST™ HAC REPORT		FCC MEASUREMENT REPORT		Reviewed by: Quality Manager
HAC Filename: HAC.0602170094.A3L	Test Dates: Feb. 22 - 23, 2006	EUT Type: Dual-Band CDMA Phone	FCC ID: A3LSCHA645	Page 34 of 69

13. CALIBRATION CERTIFICATES

The following pages include the probe calibration used to evaluate HAC for the DUT.

PCTEST™ HAC REPORT		FCC MEASUREMENT REPORT		Reviewed by: Quality Manager
HAC Filename: HAC.0602170094.A3L	Test Dates: Feb. 22 - 23, 2006	EUT Type: Dual-Band CDMA Phone	FCC ID: A3LSCHA645	Page 35 of 69

**Calibration Laboratory of
Schmid & Partner
Engineering AG**
Zeughausstrasse 43, 8004 Zurich, Switzerland



S Schweizerischer Kalibrierdienst
C Service suisse d'étalonnage
S Servizio svizzero di taratura
S Swiss Calibration Service

Accredited by the Swiss Federal Office of Metrology and Accreditation
The Swiss Accreditation Service is one of the signatories to the EA
Multilateral Agreement for the recognition of calibration certificates

Accreditation No.: **SCS 108**

Client **PC Test**

Certificate No: **ER3-2353_Aug05**

CALIBRATION CERTIFICATE

Object: **ER3DV6 - SN:2353**

Calibration procedure(s): **QA CAL-02.v4
Calibration procedure for E-field probes optimized for close near field
evaluations in air**

Calibration date: **August 2, 2005**

Condition of the calibrated item: **In Tolerance**

This calibration certificate documents the traceability to national standards, which realize the physical units of measurements (SI).
The measurements and the uncertainties with confidence probability are given on the following pages and are part of the certificate.

All calibrations have been conducted in the closed laboratory facility: environment temperature (22 ± 3)°C and humidity < 70%.

Calibration Equipment used (M&TE critical for calibration)

Primary Standards	ID #	Cal Date (Calibrated by, Certificate No.)	Scheduled Calibration
Power meter E4419B	GB41293874	3-May-05 (METAS, No. 251-00466)	May-06
Power sensor E4412A	MY41495277	3-May-05 (METAS, No. 251-00466)	May-06
Power sensor E4412A	MY41498087	3-May-05 (METAS, No. 251-00466)	May-06
Reference 3 dB Attenuator	SN: S5054 (3c)	10-Aug-04 (METAS, No. 251-00403)	Aug-05
Reference 20 dB Attenuator	SN: S5086 (20b)	3-May-05 (METAS, No. 251-00467)	May-06
Reference 30 dB Attenuator	SN: S5129 (30b)	10-Aug-04 (METAS, No. 251-00404)	Aug-05
Reference Probe ER3DV6	SN: 2328	6-Oct-04 (SPEAG, No. ER3-2328_Oct04)	Oct-05
DAE4	SN: 617	7-Jul-05 (SPEAG, No. DAE4-617_Jul05)	Jul-06
Secondary Standards	ID #	Check Date (in house)	Scheduled Check
RF generator HP 8648C	US3642U01700	4-Aug-99 (SPEAG, in house check Dec-03)	In house check: Dec-05
Network Analyzer HP 8753E	US37390585	18-Oct-01 (SPEAG, in house check Nov-04)	In house check: Nov 05

Calibrated by: **Katja Pokovic** (Name), **Technical Manager** (Function), *[Signature]* (Signature)

Approved by: **Fin Bomholt** (Name), **R&D Director** (Function), *[Signature]* (Signature)

Issued: August 8, 2005

This calibration certificate shall not be reproduced except in full without written approval of the laboratory.

PCTEST™ HAC REPORT		FCC MEASUREMENT REPORT		Reviewed by: Quality Manager
HAC Filename: HAC.0602170094.A3L	Test Dates: Feb. 22 - 23, 2006	EUT Type: Dual-Band CDMA Phone	FCC ID: A3LSCHA645	Page 36 of 69

**Calibration Laboratory of
Schmid & Partner
Engineering AG**
Zeughausstrasse 43, 8004 Zurich, Switzerland



S Schweizerischer Kalibrierdienst
C Service suisse d'étalonnage
S Servizio svizzero di taratura
S Swiss Calibration Service

Accredited by the Swiss Federal Office of Metrology and Accreditation
The Swiss Accreditation Service is one of the signatories to the EA
Multilateral Agreement for the recognition of calibration certificates

Accreditation No.: **SCS 108**

Glossary:



NORM_{x,y,z} sensitivity in free space
DCP diode compression point
Polarization ϕ ϕ rotation around probe axis
Polarization ϑ ϑ rotation around an axis that is in the plane normal to probe axis (at measurement center), i.e., $\vartheta = 0$ is normal to probe axis
Connector Angle information used in DASY system to align probe sensor X to the robot coordinate system

Calibration is Performed According to the Following Standards:

- a) IEEE Std 1309-1996, "IEEE Standard for calibration of electromagnetic field sensors and probes, excluding antennas, from 9 kHz to 40 GHz", 1996.

Methods Applied and Interpretation of Parameters:

- **NORM_{x,y,z}**: Assessed for E-field polarization $\vartheta = 0$ for XY sensors and $\vartheta = 90$ for Z sensor ($f \leq 900$ MHz in TEM-cell; $f > 1800$ MHz: R22 waveguide).
- **NORM(f)_{x,y,z}** = **NORM_{x,y,z}** * *frequency_response* (see Frequency Response Chart).
- **DCP_{x,y,z}**: DCP are numerical linearization parameters assessed based on the data of power sweep (no uncertainty required). DCP does not depend on frequency.
- **Spherical isotropy (3D deviation from isotropy)**: in a locally homogeneous field realized using an open waveguide setup.
- **Sensor Offset**: The sensor offset corresponds to the offset of virtual measurement center from the probe tip (on probe axis). No tolerance required.
- **Connector Angle**: The angle is assessed using the information gained by determining the **NORM_x** (no uncertainty required).

PCTEST™ HAC REPORT		FCC MEASUREMENT REPORT		Reviewed by: Quality Manager
HAC Filename: HAC.0602170094.A3L	Test Dates: Feb. 22 - 23, 2006	EUT Type: Dual-Band CDMA Phone	FCC ID: A3LSCHA645	Page 37 of 69



Probe ER3DV6

SN:2353

Manufactured: March 8, 2005
Calibrated: August 2, 2005

Calibrated for DASY Systems

(Note: non-compatible with DASY2 system!)

PCTEST™ HAC REPORT		FCC MEASUREMENT REPORT		Reviewed by: Quality Manager
HAC Filename: HAC.0602170094.A3L	Test Dates: Feb. 22 - 23, 2006	EUT Type: Dual-Band CDMA Phone	FCC ID: A3LSCHA645	Page 38 of 69

DASY - Parameters of Probe: ER3DV6 SN:2353

Sensitivity in Free Space [$\mu\text{V}/(\text{V}/\text{m})^2$]		Diode Compression ^A	
NormX	1.55 \pm 10.1 % (k=2)	DCP X	95 mV
NormY	1.73 \pm 10.1 % (k=2)	DCP Y	95 mV
NormZ	1.86 \pm 10.1 % (k=2)	DCP Z	96 mV

Frequency Correction

X	0.0
Y	0.0
Z	0.0



Sensor Offset (Probe Tip to Sensor Center)

X	2.5 mm
Y	2.5 mm
Z	2.5 mm

Connector Angle 29 °

The reported uncertainty of measurement is stated as the standard uncertainty of measurement multiplied by the coverage factor k=2, which for a normal distribution corresponds to a coverage probability of approximately 95%.



^A numerical linearization parameter: uncertainty not required

PCTEST™ HAC REPORT		FCC MEASUREMENT REPORT		Reviewed by: Quality Manager
HAC Filename: HAC.0602170094.A3L	Test Dates: Feb. 22 - 23, 2006	EUT Type: Dual-Band CDMA Phone	FCC ID: A3LSCHA645	Page 39 of 69

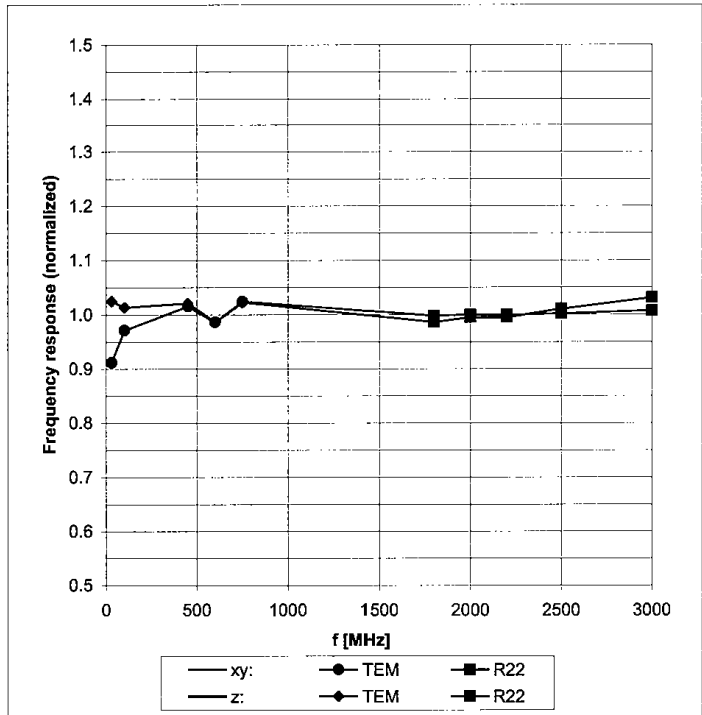
Frequency Response of E-Field (TEM-Cell:ifi110 EXX, Waveguide R22)



Uncertainty of Frequency Response of E-field: $\pm 6.3\%$ (k=2)

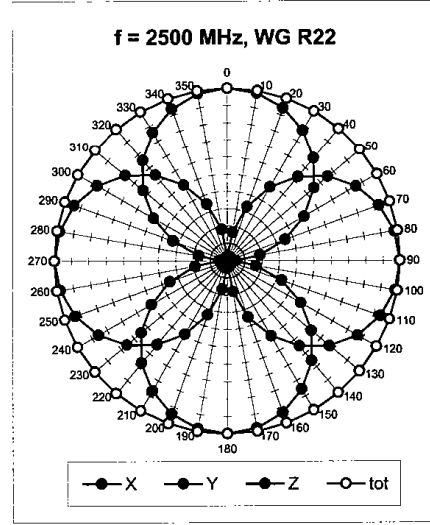
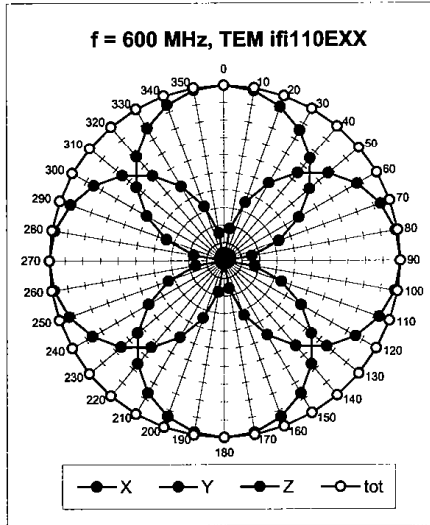

PCTEST™ HAC REPORT		FCC MEASUREMENT REPORT		Reviewed by: Quality Manager
HAC Filename: HAC.0602170094.A3L	Test Dates: Feb. 22 - 23, 2006	EUT Type: Dual-Band CDMA Phone	FCC ID: A3LSCHA645	Page 40 of 69

Receiving Pattern (ϕ), $\vartheta = 0^\circ$

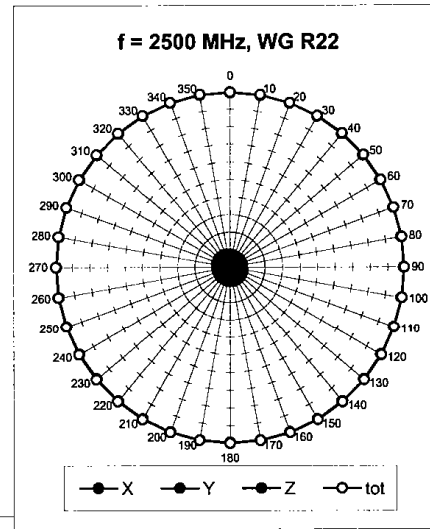
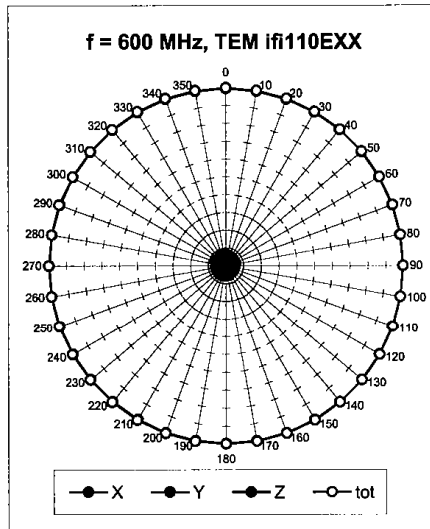

Receiving Pattern (ϕ), $\vartheta = 90^\circ$



PCTEST™ HAC REPORT		FCC MEASUREMENT REPORT		Reviewed by: Quality Manager
HAC Filename: HAC.0602170094.A3L	Test Dates: Feb. 22 - 23, 2006	EUT Type: Dual-Band CDMA Phone	FCC ID: A3LSCHA645	Page 41 of 69

Receiving Pattern (ϕ), $\theta = 0^\circ$

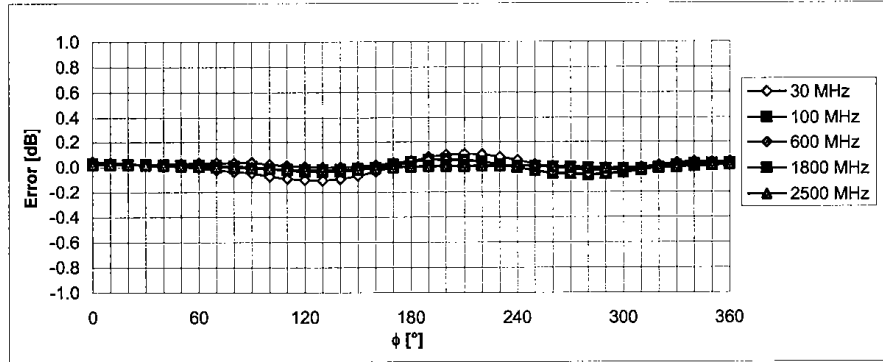

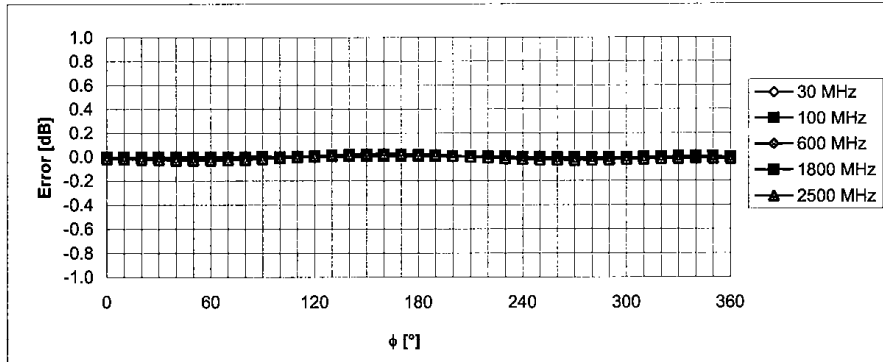

Uncertainty of Axial Isotropy Assessment: $\pm 0.5\%$ (k=2)

Receiving Pattern (ϕ), $\theta = 90^\circ$





Uncertainty of Axial Isotropy Assessment: $\pm 0.5\%$ (k=2)

PCTEST™ HAC REPORT		FCC MEASUREMENT REPORT		Reviewed by: Quality Manager
HAC Filename: HAC.0602170094.A3L	Test Dates: Feb. 22 - 23, 2006	EUT Type: Dual-Band CDMA Phone	FCC ID: A3LSCHA645	Page 42 of 69

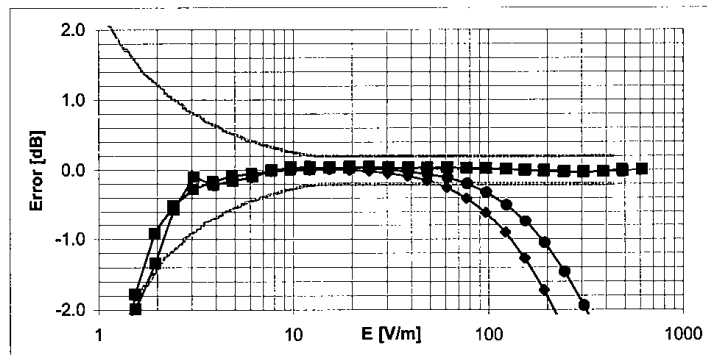
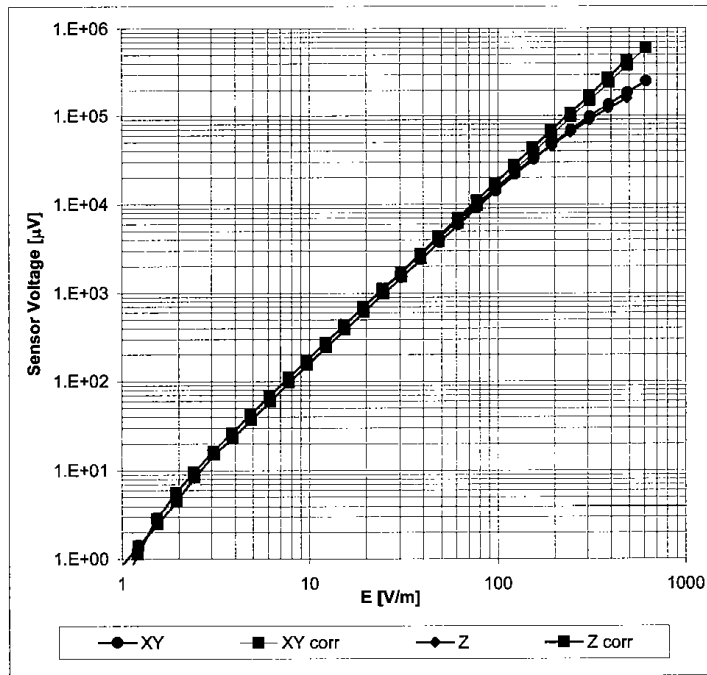
Dynamic Range f(E-field) (Waveguide R22, f = 1800 MHz)





Uncertainty of Linearity Assessment: $\pm 0.6\%$ (k=2)

PCTEST™ HAC REPORT		FCC MEASUREMENT REPORT		Reviewed by: Quality Manager
HAC Filename: HAC.0602170094.A3L	Test Dates: Feb. 22 - 23, 2006	EUT Type: Dual-Band CDMA Phone	FCC ID: A3LSCHA645	Page 43 of 69

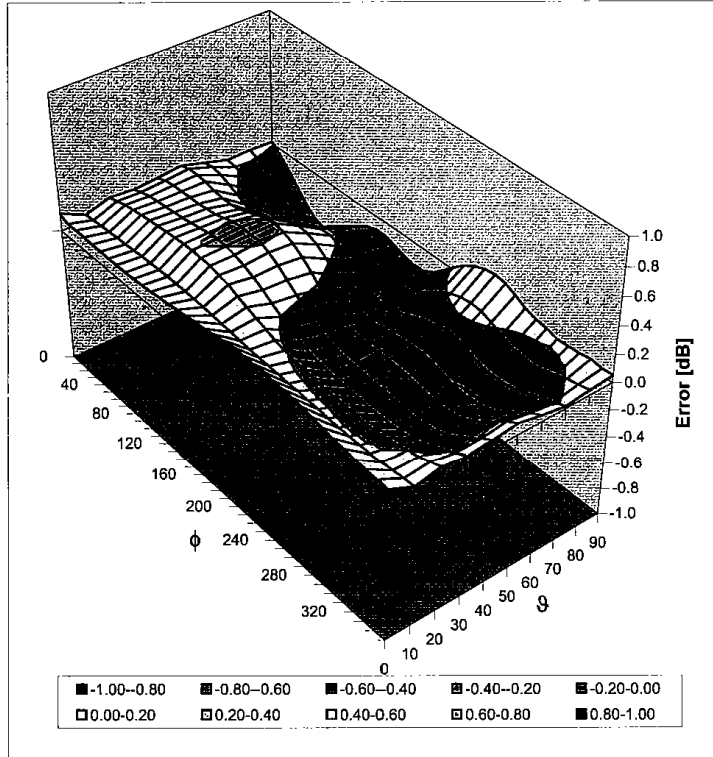
Deviation from Isotropy in Air Error (ϕ, ϑ), $f = 900$ MHz



Uncertainty of Spherical Isotropy Assessment: $\pm 2.6\%$ ($k=2$)

PCTEST™ HAC REPORT		FCC MEASUREMENT REPORT		Reviewed by: Quality Manager
HAC Filename: HAC.0602170094.A3L	Test Dates: Feb. 22 - 23, 2006	EUT Type: Dual-Band CDMA Phone	FCC ID: A3LSCHA645	Page 44 of 69

**Calibration Laboratory of
Schmid & Partner
Engineering AG**
Zeughausstrasse 43, 8004 Zurich, Switzerland



S Schweizerischer Kalibrierdienst
C Service suisse d'étalonnage
S Servizio svizzero di taratura
S Swiss Calibration Service

Accredited by the Swiss Federal Office of Metrology and Accreditation
The Swiss Accreditation Service is one of the signatories to the EA
Multilateral Agreement for the recognition of calibration certificates

Accreditation No.: **SCS 108**

Client **PC Test**

Certificate No: **H3-6170_Aug05**

CALIBRATION CERTIFICATE

Object: **H3DV6 - SN:6170**

Calibration procedure(s): **QA CAL-03.v4
Calibration procedure for H-field probes optimized for close near field
evaluations in air**

Calibration date: **August 8, 2005**

Condition of the calibrated item: **In Tolerance**

This calibration certificate documents the traceability to national standards, which realize the physical units of measurements (SI).
The measurements and the uncertainties with confidence probability are given on the following pages and are part of the certificate.

All calibrations have been conducted in the closed laboratory facility: environment temperature (22 ± 3)°C and humidity < 70%.

Calibration Equipment used (M&TE critical for calibration)

Primary Standards	ID #	Cal Date (Calibrated by, Certificate No.)	Scheduled Calibration
Power meter E4419B	GB41293874	3-May-05 (METAS, No. 251-00466)	May-06
Power sensor E4412A	MY41495277	3-May-05 (METAS, No. 251-00466)	May-06
Power sensor E4412A	MY41498087	3-May-05 (METAS, No. 251-00466)	May-06
Reference 3 dB Attenuator	SN: S5054 (3c)	10-Aug-04 (METAS, No. 251-00403)	Aug-05
Reference 20 dB Attenuator	SN: S5086 (20b)	3-May-05 (METAS, No. 251-00467)	May-06
Reference 30 dB Attenuator	SN: S5129 (30b)	10-Aug-04 (METAS, No. 251-00404)	Aug-05
Reference Probe H3DV6	SN: 6182	6-Oct-04 (SPEAG, No. H3-6182_Oct04)	Oct-05
DAE4	SN: 617	7-Jul-05 (SPEAG, No. DAE4-617_Jul05)	Jul-06

Secondary Standards	ID #	Check Date (in house)	Scheduled Check
RF generator HP 8648C	US3642U01700	4-Aug-99 (SPEAG, in house check Dec-03)	In house check: Dec-05
Network Analyzer HP 8753E	US37390585	18-Oct-01 (SPEAG, in house check Nov-04)	In house check: Nov 05

Calibrated by:	Name Katja Pokovic	Function Technical Manager	Signature
Approved by:	Name Flin Bomholt	Function R&D Director	Signature

Issued: August 8, 2005

This calibration certificate shall not be reproduced except in full without written approval of the laboratory.

Certificate No: H3-6170_Aug05

Page 1 of 8

PCTEST™ HAC REPORT		FCC MEASUREMENT REPORT		Reviewed by: Quality Manager
HAC Filename: HAC.0602170094.A3L	Test Dates: Feb. 22 - 23, 2006	EUT Type: Dual-Band CDMA Phone	FCC ID: A3LSCHA645	Page 45 of 69

**Calibration Laboratory of
Schmid & Partner
Engineering AG**
Zeughausstrasse 43, 8004 Zurich, Switzerland



S Schweizerischer Kallbrierdienst
C Service suisse d'étalonnage
S Servizio svizzero di taratura
S Swiss Calibration Service

Accredited by the Swiss Federal Office of Metrology and Accreditation
The Swiss Accreditation Service is one of the signatories to the EA
Multilateral Agreement for the recognition of calibration certificates

Accreditation No.: **SCS 108**

Glossary:



NORM_{x,y,z} sensitivity in free space
DCP diode compression point
Polarization φ φ rotation around probe axis
Polarization ϑ ϑ rotation around an axis that is in the plane normal to probe axis (at measurement center), i.e., $\vartheta = 0$ is normal to probe axis
Connector Angle information used in DASY system to align probe sensor X to the robot coordinate system

Calibration is Performed According to the Following Standards:

- a) IEEE Std 1309-1996, " IEEE Standard for calibration of electromagnetic field sensors and probes, excluding antennas, from 9 kHz to 40 GHz", 1996.

Methods Applied and Interpretation of Parameters:

- **X,Y,Z_a0a1a2:** Assessed for E-field polarization $\vartheta = 90$ for XY sensors and $\vartheta = 0$ for Z sensor ($f \leq 900$ MHz in TEM-cell; $f > 1800$ MHz: R22 waveguide).
- **X,Y,Z(f)_a0a1a2= X,Y,Z_a0a1a2* frequency_response** (see Frequency Response Chart).
- **DCP_{x,y,z}:** DCP are numerical linearization parameters assessed based on the data of power sweep (no uncertainty required). DCP does not depend on frequency.
- **Spherical isotropy (3D deviation from isotropy):** in a locally homogeneous field realized using an open waveguide setup.
- **Sensor Offset:** The sensor offset corresponds to the offset of virtual measurement center from the probe tip (on probe axis). No tolerance required.
- **Connector Angle:** The angle is assessed using the information gained by determining the **X_a0a1a2** (no uncertainty required).

PCTEST™ HAC REPORT		FCC MEASUREMENT REPORT		Reviewed by: Quality Manager
HAC Filename: HAC.0602170094.A3L	Test Dates: Feb. 22 - 23, 2006	EUT Type: Dual-Band CDMA Phone	FCC ID: A3LSCHA645	Page 46 of 69

H3DV6 SN:6170

August 8, 2005

Probe H3DV6

SN:6170



Manufactured: May 19, 2005
Calibrated: August 8, 2005

Calibrated for DASY Systems

(Note: non-compatible with DASY2 system!)

Certificate No: H3-6170_Aug05

Page 3 of 8

PCTEST™ HAC REPORT		FCC MEASUREMENT REPORT		Reviewed by: Quality Manager
HAC Filename: HAC.0602170094.A3L	Test Dates: Feb. 22 - 23, 2006	EUT Type: Dual-Band CDMA Phone	FCC ID: A3LSCHA645	Page 47 of 69

DASY - Parameters of Probe: H3DV6 SN:6170

Sensitivity in Free Space [A/m / $\sqrt{(\mu V)}$]

	a0	a1	a2
X	2.502E-03	1.072E-4	-3.021E-6 ± 5.1 % (k=2)
Y	2.645E-03	2.739E-6	-2.811E-5 ± 5.1 % (k=2)
Z	2.960E-03	-6.594E-5	2.809E-5 ± 5.1 % (k=2)

Diode Compression¹

DCP X	85 mV
DCP Y	85 mV
DCP Z	86 mV



Sensor Offset (Probe Tip to Sensor Center)

X	3.0 mm
Y	3.0 mm
Z	3.0 mm

Connector Angle 29 °

The reported uncertainty of measurement is stated as the standard uncertainty of measurement multiplied by the coverage factor k=2, which for a normal distribution corresponds to a coverage probability of approximately 95%.

¹ numerical linearization parameter: uncertainty not required



PCTEST™ HAC REPORT		FCC MEASUREMENT REPORT		Reviewed by: Quality Manager
HAC Filename: HAC.0602170094.A3L	Test Dates: Feb. 22 - 23, 2006	EUT Type: Dual-Band CDMA Phone	FCC ID: A3LSCHA645	Page 48 of 69

Frequency Response of H-Field

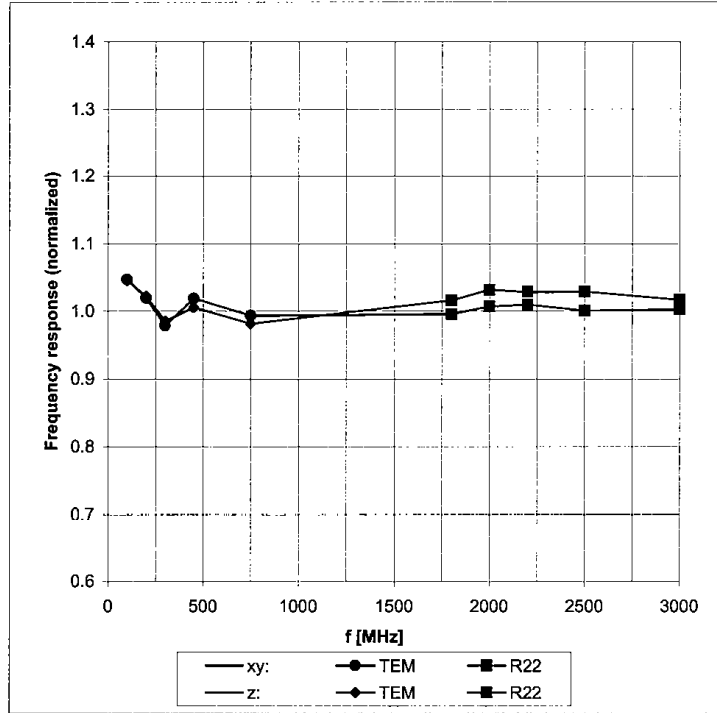
(TEM-Cell:ifi110, Waveguide R22)



Uncertainty of Frequency Response of E-field: ± 6.3% (k=2)

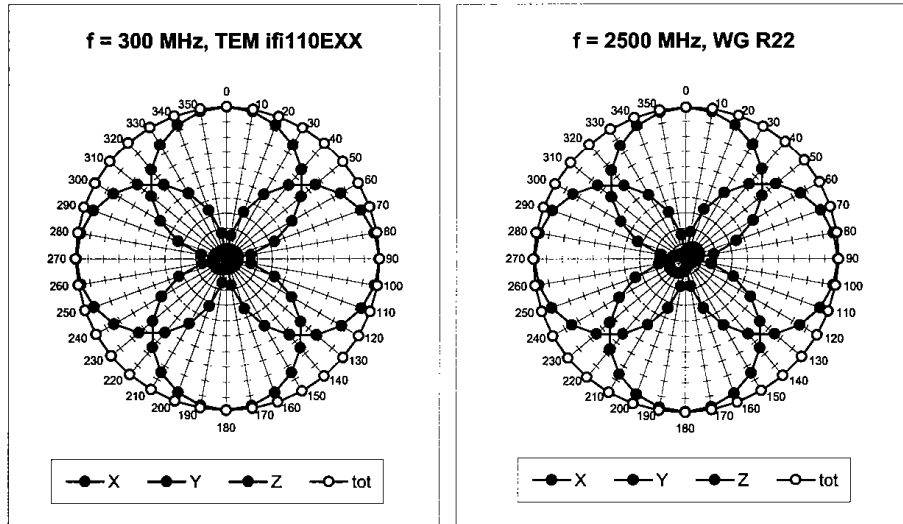

PCTEST™ HAC REPORT		FCC MEASUREMENT REPORT		Reviewed by: Quality Manager
HAC Filename: HAC.0602170094.A3L	Test Dates: Feb. 22 - 23, 2006	EUT Type: Dual-Band CDMA Phone	FCC ID: A3LSCHA645	Page 49 of 69

Receiving Pattern (ϕ), $\vartheta = 90^\circ$

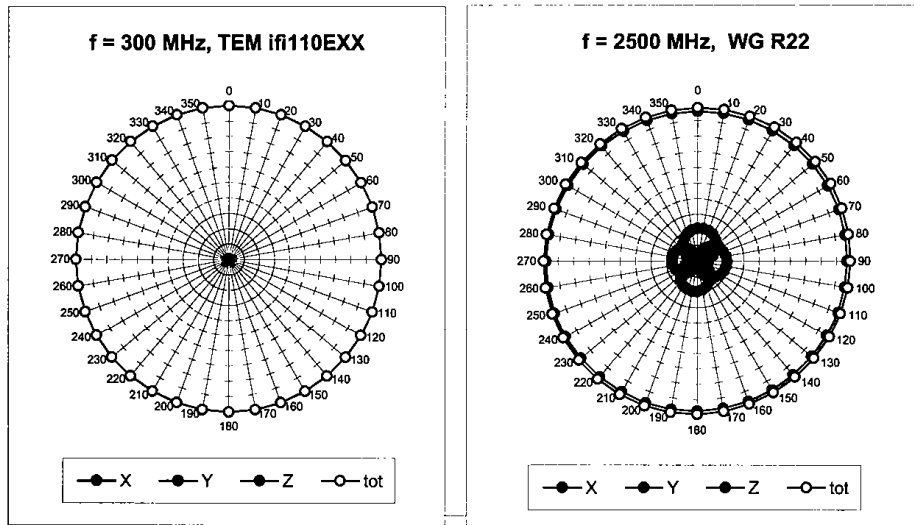

Receiving Pattern (ϕ), $\vartheta = 0^\circ$



<p>PCTEST™ HAC REPORT</p>		<p>FCC MEASUREMENT REPORT</p>		<p>Reviewed by: Quality Manager</p>
<p>HAC Filename: HAC.0602170094.A3L</p>	<p>Test Dates: Feb. 22 - 23, 2006</p>	<p>EUT Type: Dual-Band CDMA Phone</p>	<p>FCC ID: A3LSCHA645</p>	<p>Page 50 of 69</p>

Receiving Pattern (ϕ), $\vartheta = 90^\circ$

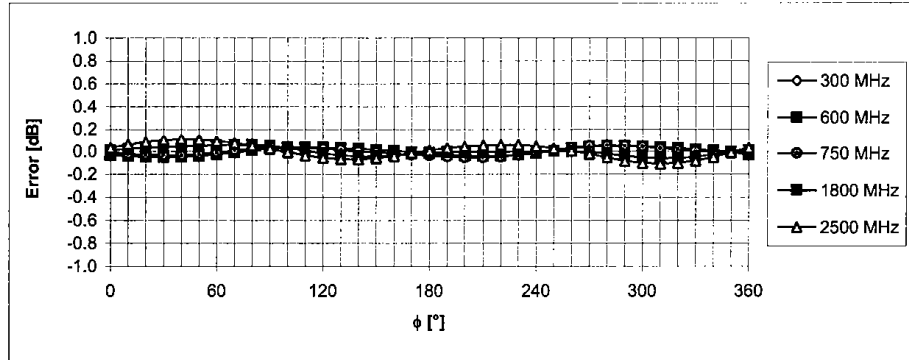

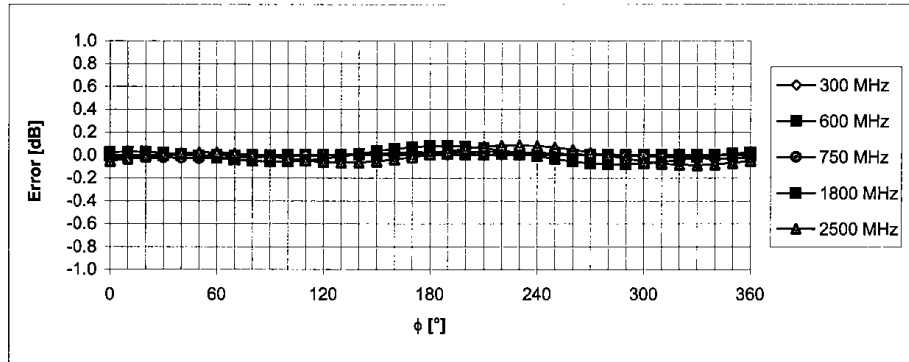

Uncertainty of Axial Isotropy Assessment: $\pm 0.5\%$ ($k=2$)

Receiving Pattern (ϕ), $\vartheta = 0^\circ$





Uncertainty of Axial Isotropy Assessment: $\pm 0.5\%$ ($k=2$)

PCTEST™ HAC REPORT		FCC MEASUREMENT REPORT		Reviewed by: Quality Manager
HAC Filename: HAC.0602170094.A3L	Test Dates: Feb. 22 - 23, 2006	EUT Type: Dual-Band CDMA Phone	FCC ID: A3LSCHA645	Page 51 of 69

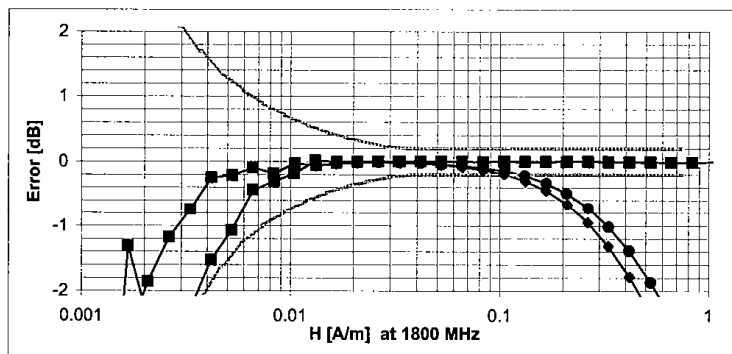
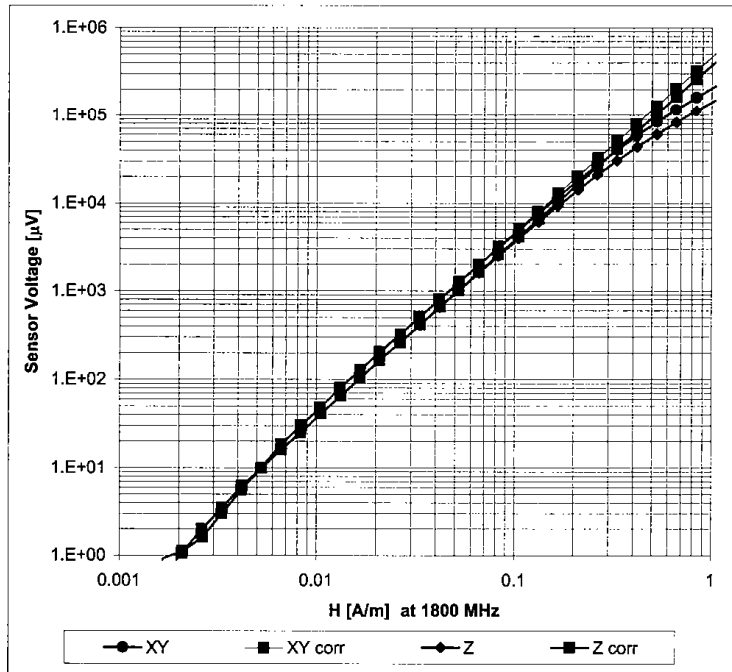
Dynamic Range f(H-field) (Waveguide R22, f = 1800 MHz)



Uncertainty of Linearity Assessment: $\pm 0.6\%$ (k=2)

PCTEST™ HAC REPORT		FCC MEASUREMENT REPORT		Reviewed by: Quality Manager
HAC Filename: HAC.0602170094.A3L	Test Dates: Feb. 22 - 23, 2006	EUT Type: Dual-Band CDMA Phone	FCC ID: A3LSCHA645	Page 52 of 69

Client

PC TEST

Certificate No: CD1880V3-1002_Feb05

CALIBRATION CERTIFICATE

Object **CD1880V3 - SN: 1002**

Calibration procedure(s) **QA CAL-20.v2
Calibration procedure for dipoles in air**

Calibration date: **February, 23, 2005**

Condition of the calibrated item **In Tolerance**

This calibration certificate documents the traceability to national standards, which realize the physical units of measurements (SI).
All calibrations have been conducted in the closed laboratory facility: environment temperature (22 ± 3)°C and humidity < 70%.

Calibration Equipment used (M&TE critical for calibration)

Primary Standards	ID #	Cal Date (Calibrated by, Certificate No.)	Scheduled Calibration
Power meter EPM E442	GB37480704	12-Oct-04 (METAS, No. 251-00412)	Oct-05
Power sensor HP 8481A	US37292783	12-Oct-04 (METAS, No. 251-00412)	Oct-05
Reference 20 dB Attenuator	SN: 5086 (20g)	10-Aug-04 (METAS, No 251-00402)	Aug-05
Reference 10 dB Attenuator	SN: 5047.2 (10r)	10-Aug-04 (METAS, No 251-00402)	Aug-05
Reference Probe ER3DV6	SN 2328	06-Oct-04 (SPEAG, No. ER3-2328_Oct04)	Oct-05
DAE4	SN 601	07-Jan-05 (SPEAG, No. DAE4-601_Jan05)	Jan-06

Secondary Standards	ID #	Check Date (in house)	Scheduled Check
Power sensor HP 8481A	MY41092312	10-Aug-03 (SPEAG, in house check Jan-04)	In house check: Oct-05
Power sensor HP 8481A	MY41093315	10-Aug-03 (SPEAG, in house check Jan-04)	In house check: Oct-05
RF generator Agilent E8251A	US41140111	4-Aug-03 (Agilent)	In house check: Aug-05
Network Analyzer HP 8753E	US37390585 S4206	18-Oct-01 (SPEAG, in house check Nov-04)	In house check: Nov-05
Probe H3DV6	SN: 6065	10-Oct-04 (SPEAG, No. H3-6065-Oct04)	Calibration, Oct-05

Calibrated by: **Mike Meili** Function: **Laboratory Technician** Signature: *M. Meili*



Approved by: **Fin Bomholt** Technical Director: *F. Bomholt*

Issued: February 27, 2005

This calibration certificate is issued as an intermediate solution until the specific calibration procedure is submitted and accepted in the frame of the accreditation of the Calibration Laboratory of Schmid & Partner Engineering AG (based on ISO/IEC 17025 International Standard)

Certificate No: CD1880V3-1002_Feb05

Page 1 of 6



PCTEST™ HAC REPORT		FCC MEASUREMENT REPORT		Reviewed by: Quality Manager
HAC Filename: HAC.0602170094.A3L	Test Dates: Feb. 22 - 23, 2006	EUT Type: Dual-Band CDMA Phone	FCC ID: A3LSCHA645	Page 53 of 69

References

- [1] ANSI-PC63.19-2003 (Draft)
American National Standard for Methods of Measurement of Compatibility between Wireless Communications Devices and Hearing Aids.

Methods Applied and Interpretation of Parameters:

- *Coordinate System:* y-axis is in the direction of the dipole arms. z-axis is from the basis of the antenna (mounted on the table) towards its feed point between the two dipole arms. x-axis is normal to the other axes. In coincidence with standard [1], the measurement planes (probe sensor center) are selected to be at a distance of 10 mm above the the top edge of the dipole arms.
- *Measurement Conditions:* Further details are available from the hardcopies at the end of the certificate. All figures stated in the certificate are valid at the frequency indicated. The forward power to the dipole connector is set with a calibrated power meter connected and monitored with an auxiliary power meter connected to a directional coupler. While the dipole under test is connected, the forward power is adjusted to the same level.
- *Antenna Positioning:* The dipole is mounted on a HAC Test Arch phantom using the matching dipole positioner with the arms horizontal and the feeding cable coming from the floor. The measurements are performed in a shielded room with absorbers around the setup to reduce the reflections. It is verified before the mounting of the dipole under the Test Arch phantom, that its arms are perfectly in a line. It is installed on the HAC dipole positioner with its arms parallel below the dielectric reference wire and able to move elastically in vertical direction without changing its relative position to the top center of the Test Arch phantom. The vertical distance to the probe is adjusted after dipole mounting with a DASY4 Surface Check job. Before the measurement, the distance between phantom surface and probe tip is verified. The proper measurement distance is selected by choosing the matching section of the HAC Test Arch phantom with the proper device reference point (upper surface of the dipole) and the matching grid reference point (tip of the probe) considering the probe sensor offset. The vertical distance to the probe is essential for the accuracy.
- *Feed Point Impedance and Return Loss:* These parameters are measured using a HP 8753E Vector Network Analyzer. The impedance is specified at the SMA connector of the dipole. The influence of reflections was eliminating by applying the averaging function while moving the dipole in the air, at least 70cm away from any obstacles.
- *E-field distribution:* E field is measured in the x-y-plane with an isotropic ER3D-field probe with 100 mW forward power to the antenna feed point. In accordance with [1], the scan area is 20mm wide, its length exceeds the dipole arm length (180 or 90mm). The sensor center is 10 mm (in z) above the top of the dipole arms. Two 3D maxima are available near the end of the dipole arms. Assuming the dipole arms are perfectly in one line, the average of these two maxima (in subgrid 2 and subgrid 8) is determined to compensate for any non-parallelity to the measurement plane as well as the sensor displacement. The E-field value stated as calibration value represents the maximum of the interpolated 3D-E-field, 10mm above the dipole surface.
- *H-field distribution:* H-field is measured with an isotropic H-field probe with 100mW forward power to the antenna feed point, in the x-y-plane. The scan area and sensor distance is equivalent to the E-field scan. The maximum of the field is available at the center (subgrid 5) above the feed point. The H-field value stated as calibration value represents the maximum of the interpolated H-field, 10mm above the dipole surface at the feed point.

PCTEST™ HAC REPORT		FCC MEASUREMENT REPORT		Reviewed by: Quality Manager
HAC Filename: HAC.0602170094.A3L	Test Dates: Feb. 22 - 23, 2006	EUT Type: Dual-Band CDMA Phone	FCC ID: A3LSCHA645	Page 54 of 69

1 Measurement Conditions

DASY system configuration, as far as not given on page 1.

DASY Version	DASY4	V4.5 B13
DASY PP Version	SEMCAD	V1.8 B144
Phantom	HAC Test Arch	SD HAC P01 BA, #1002
Distance Dipole Top - Probe Center	10 mm	
Scan resolution	dx, dy = 5 mm	area = 20 x 90 mm
Frequency	1880 MHz ± 1 MHz	
Forward power at dipole connector	20.0 dBm = 100mW	
Input power drift	< 0.05 dB	

2 Maximum Field values

H-field 10 mm above dipole surface	condition	interpolated maximum
Maximum measured	100 mW forward power	0.450 A/m

Uncertainty for H-field measurement: 19.5% (k=2)

E-field 10 mm above dipole surface	condition	interpolated maximum
Maximum measured above high end	100 mW forward power	146.0 V/m
Maximum measured above low end	100 mW forward power	145.6 V/m
Averaged maximum above arm	100 mW forward power	145.8 V/m

Uncertainty for E-field measurement: 21.7% (k=2)

3 Appendix

3.1 Antenna Parameters

Frequency	Return Loss	Impedance
1710 MHz	23.4 dB	(55.2 + j6.1) Ohm
1880 MHz	21.4 dB	(53.9 + j7.4) Ohm
1900 MHz	20.9 dB	(55.8 + j6.7) Ohm
1950 MHz	28.0 dB	(54.1 + j1.9) Ohm
2000 MHz	18.9 dB	(51.2 + j11.9) Ohm



3.2 Antenna Design and Handling

The calibration dipole has a symmetric geometry with a built-in two stub matching network, which leads to the enhanced bandwidth.

The dipole is built of standard semirigid coaxial cable. The internal matching line is open ended. The antenna is therefore open for DC signals.

Do not apply force to dipole arms, as they are liable to bend. The soldered connections near the feedpoint may be damaged. After excessive mechanical stress or overheating, check the impedance characteristics to ensure that the internal matching network is not affected.

After long term use with 40W radiated power, only a slight warming of the dipole near the feedpoint can be measured.

PCTEST™ HAC REPORT		FCC MEASUREMENT REPORT		Reviewed by: Quality Manager
HAC Filename: HAC.0602170094.A3L	Test Dates: Feb. 22 - 23, 2006	EUT Type: Dual-Band CDMA Phone	FCC ID: A3LSCHA645	Page 55 of 69

3.3 Measurement Sheets

3.3.1 Return Loss and Smith Chart

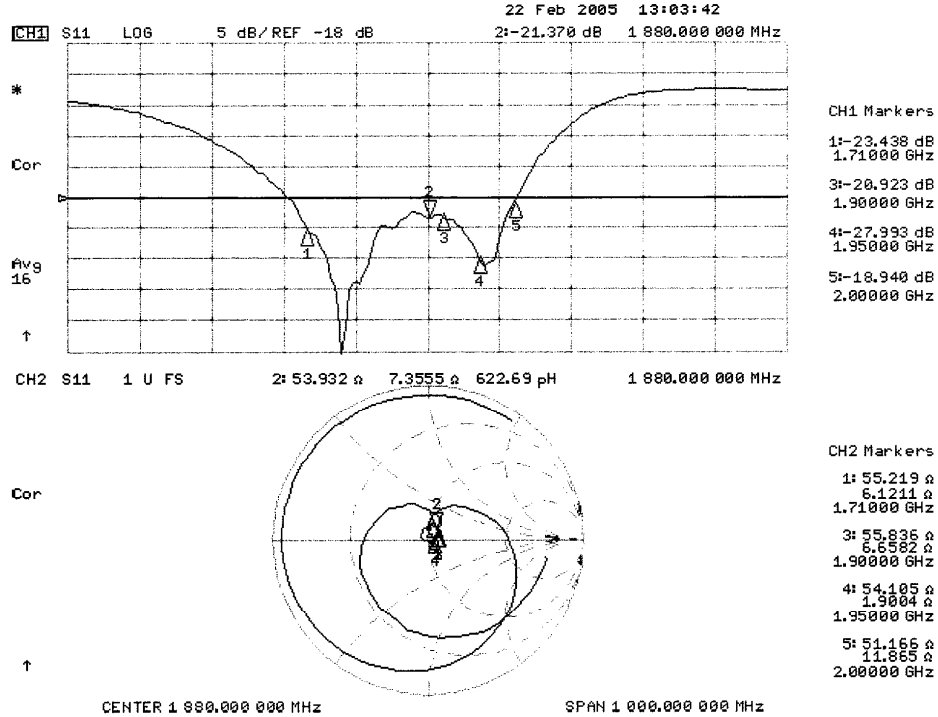



3.3.2 DASY4 H-field result

See page 5

3.3.3 DASY4 E-Field result

See page 6

PCTEST™ HAC REPORT		FCC MEASUREMENT REPORT		Reviewed by: Quality Manager
HAC Filename: HAC.0602170094.A3L	Test Dates: Feb. 22 - 23, 2006	EUT Type: Dual-Band CDMA Phone	FCC ID: A3LSCHA645	Page 56 of 69

Test Laboratory: SPEAG, Zurich, Switzerland
 File Name: H_CD1880_1002_050223.da4

DUT: HAC Dipole 1880 MHz; Type: CD1880V3; Serial: 1002
Program Name: HAC H Dipole



Communication System: CW; Frequency: 1880 MHz; Duty Cycle: 1:1
 Medium parameters used: $\sigma = 0$; mho/m, $\epsilon_r = 1$; $\rho = 1 \text{ kg/m}^3$
 Phantom section: H Dipole Section

DASY4 Configuration:
 - Probe: H3DV6 - SN6065; ; Calibrated: 10.12.2004
 - Sensor-Surface: (Fix Surface)
 - Electronics: DAE4 Sn901; Calibrated: 29.06.2004
 - Phantom: HAC Phantom; Type: SD HAC P01 BA;
 - Measurement SW: DASY4, V4.5 Build 13; Postprocessing SW: SEMCAD, V1.8 Build 144

H Scan 10mm above CD 1880 MHz/Hearing Aid Compatibility Test (41x181x1): Measurement grid: dx=5mm, dy=5mm, dz=5.555mm
 Maximum value of Total field (slot averaged) = 0.450 A/m
Hearing Aid Near-Field Category: M2 (AWF 0 dB)

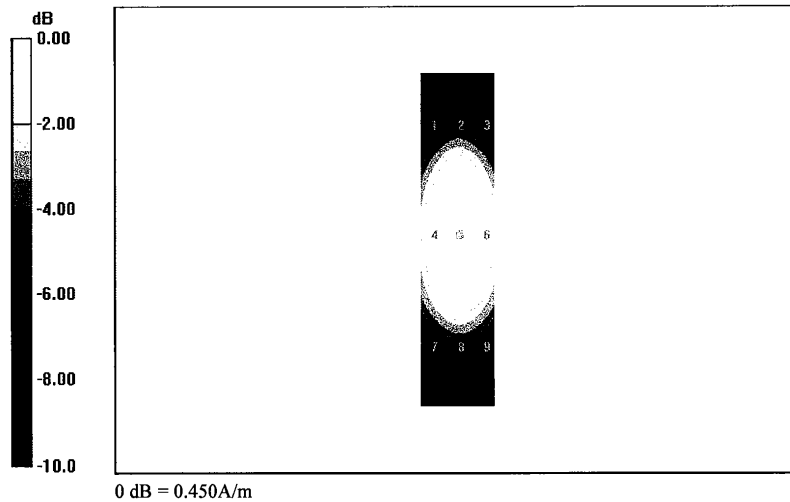
H in A/m (Time averaged)			H in A/m (Slot averaged)		
Grid 1	Grid 2	Grid 3	Grid 1	Grid 2	Grid 3
0.385	0.413	0.395	0.385	0.413	0.395
Grid 4	Grid 5	Grid 6	Grid 4	Grid 5	Grid 6
0.421	0.450	0.432	0.421	0.450	0.432
Grid 7	Grid 8	Grid 9	Grid 7	Grid 8	Grid 9
0.376	0.401	0.386	0.376	0.401	0.386



PCTEST™ HAC REPORT		FCC MEASUREMENT REPORT		Reviewed by: Quality Manager
HAC Filename: HAC.0602170094.A3L	Test Dates: Feb. 22 - 23, 2006	EUT Type: Dual-Band CDMA Phone	FCC ID: A3LSCHA645	Page 57 of 69

Test Laboratory: SPEAG, Zurich, Switzerland
 File Name: E_CD1880_1002_050223.da4

DUT: HAC Dipole 1880 MHz; Type: CD1880V3; Serial: 1002
Program Name: HAC E Dipole

Communication System: CW; Frequency: 1880 MHz; Duty Cycle: 1:1
 Medium parameters used: $\sigma = 0$; mho/m , $\epsilon_r = 1$; $\rho = 1000 \text{ kg/m}^3$
 Phantom section: E Dipole Section

DASY4 Configuration:
 - Probe: ER3DV6 - SN2328; ConvF(1, 1, 1); Calibrated: 06.10.2004
 - Sensor-Surface: (Fix Surface)
 - Electronics: DAE4 Sn901; Calibrated: 29.06.2004
 - Phantom: HAC Phantom; Type: SD HAC P01 BA;
 - Measurement SW: DASY4, V4.5 Build 13; Postprocessing SW: SEMCAD, V1.8 Build 144

E Scan 10mm above CD 1880 MHz/Hearing Aid Compatibility Test (41x181x1): Measurement grid: dx=5mm, dy=5mm, dz=5.5555mm
 Maximum value of Total field (slot averaged) = 146.0 V/m
Hearing Aid Near-Field Category: M2 (AWF 0 dB)

E in V/m (Time averaged) E in V/m (Slot averaged)

Grid 1	Grid 2	Grid 3	Grid 1	Grid 2	Grid 3
128.7	145.6	130.5	128.7	145.6	130.5
Grid 4	Grid 5	Grid 6	Grid 4	Grid 5	Grid 6
90.1	92.4	88.8	90.1	92.4	88.8
Grid 7	Grid 8	Grid 9	Grid 7	Grid 8	Grid 9
126.7	146.0	131.8	126.7	146.0	131.8

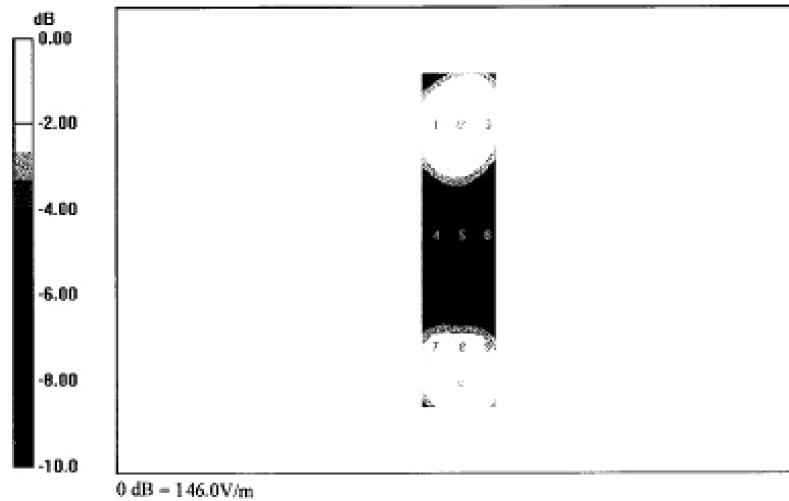



PCTEST™ HAC REPORT	PCTEST	FCC MEASUREMENT REPORT	SAMSUNG	Reviewed by: Quality Manager
HAC Filename: HAC.0602170094.A3L	Test Dates: Feb. 22 - 23, 2006	EUT Type: Dual-Band CDMA Phone	FCC ID: A3LSCHA645	Page 58 of 69

Client **PC TEST**

Certificate No: **CD835V3-1003_Feb05**

CALIBRATION CERTIFICATE																																																							
Object	CD835V3 - SN: 1003																																																						
Calibration procedure(s)	QA CAL-20 v2 Calibration procedure for dipoles in air																																																						
Calibration date:	February 23, 2005																																																						
Condition of the calibrated item	In Tolerance																																																						
<p>This calibration certificate documents the traceability to national standards, which realize the physical units of measurements (SI). All calibrations have been conducted in the closed laboratory facility: environment temperature (22 ± 3)°C and humidity < 70%.</p> <p>Calibration Equipment used (M&TE critical for calibration)</p> <table border="1"> <thead> <tr> <th>Primary Standards</th> <th>ID #</th> <th>Cal Date (Calibrated by, Certificate No.)</th> <th>Scheduled Calibration</th> </tr> </thead> <tbody> <tr> <td>Power meter EPM E442</td> <td>GB37480704</td> <td>12-Oct-04 (METAS, No. 251-00412)</td> <td>Oct-05</td> </tr> <tr> <td>Power sensor HP 8481A</td> <td>US37292783</td> <td>12-Oct-04 (METAS, No. 251-00412)</td> <td>Oct-05</td> </tr> <tr> <td>Reference 20 dB Attenuator</td> <td>SN: 5086 (20g)</td> <td>10-Aug-04 (METAS, No 251-00402)</td> <td>Aug-05</td> </tr> <tr> <td>Reference 10 dB Attenuator</td> <td>SN: 5047.2 (10r)</td> <td>10-Aug-04 (METAS, No 251-00402)</td> <td>Aug-05</td> </tr> <tr> <td>Reference Probe ER3DV6</td> <td>SN 2328</td> <td>06-Oct-04 (SPEAG, No. ER3-2328_Oct04)</td> <td>Oct-05</td> </tr> <tr> <td>DAE4</td> <td>SN 601</td> <td>07-Jan-05 (SPEAG, No. DAE4-601_Jan05)</td> <td>Jan-06</td> </tr> </tbody> </table> <table border="1"> <thead> <tr> <th>Secondary Standards</th> <th>ID #</th> <th>Check Date (in house)</th> <th>Scheduled Check</th> </tr> </thead> <tbody> <tr> <td>Power sensor HP 8481A</td> <td>MY41092312</td> <td>10-Aug-03 (SPEAG, in house check Jan-04)</td> <td>In house check: Oct-05</td> </tr> <tr> <td>Power sensor HP 8481A</td> <td>MY41093315</td> <td>10-Aug-03 (SPEAG, in house check Jan-04)</td> <td>In house check: Oct-05</td> </tr> <tr> <td>RF generator Agilent E8251A</td> <td>US41140111</td> <td>4-Aug-03 (Agilent)</td> <td>In house check: Aug-05</td> </tr> <tr> <td>Network Analyzer HP 8753E</td> <td>US37390585 S4206</td> <td>18-Oct-01 (SPEAG, in house check Nov-04)</td> <td>In house check: Nov-05</td> </tr> <tr> <td>Probe H3DV6</td> <td>SN: 6065</td> <td>10-Oct-04 (SPEAG, No. H3-6065-Oct04)</td> <td>Calibration, Oct-05</td> </tr> </tbody> </table>				Primary Standards	ID #	Cal Date (Calibrated by, Certificate No.)	Scheduled Calibration	Power meter EPM E442	GB37480704	12-Oct-04 (METAS, No. 251-00412)	Oct-05	Power sensor HP 8481A	US37292783	12-Oct-04 (METAS, No. 251-00412)	Oct-05	Reference 20 dB Attenuator	SN: 5086 (20g)	10-Aug-04 (METAS, No 251-00402)	Aug-05	Reference 10 dB Attenuator	SN: 5047.2 (10r)	10-Aug-04 (METAS, No 251-00402)	Aug-05	Reference Probe ER3DV6	SN 2328	06-Oct-04 (SPEAG, No. ER3-2328_Oct04)	Oct-05	DAE4	SN 601	07-Jan-05 (SPEAG, No. DAE4-601_Jan05)	Jan-06	Secondary Standards	ID #	Check Date (in house)	Scheduled Check	Power sensor HP 8481A	MY41092312	10-Aug-03 (SPEAG, in house check Jan-04)	In house check: Oct-05	Power sensor HP 8481A	MY41093315	10-Aug-03 (SPEAG, in house check Jan-04)	In house check: Oct-05	RF generator Agilent E8251A	US41140111	4-Aug-03 (Agilent)	In house check: Aug-05	Network Analyzer HP 8753E	US37390585 S4206	18-Oct-01 (SPEAG, in house check Nov-04)	In house check: Nov-05	Probe H3DV6	SN: 6065	10-Oct-04 (SPEAG, No. H3-6065-Oct04)	Calibration, Oct-05
Primary Standards	ID #	Cal Date (Calibrated by, Certificate No.)	Scheduled Calibration																																																				
Power meter EPM E442	GB37480704	12-Oct-04 (METAS, No. 251-00412)	Oct-05																																																				
Power sensor HP 8481A	US37292783	12-Oct-04 (METAS, No. 251-00412)	Oct-05																																																				
Reference 20 dB Attenuator	SN: 5086 (20g)	10-Aug-04 (METAS, No 251-00402)	Aug-05																																																				
Reference 10 dB Attenuator	SN: 5047.2 (10r)	10-Aug-04 (METAS, No 251-00402)	Aug-05																																																				
Reference Probe ER3DV6	SN 2328	06-Oct-04 (SPEAG, No. ER3-2328_Oct04)	Oct-05																																																				
DAE4	SN 601	07-Jan-05 (SPEAG, No. DAE4-601_Jan05)	Jan-06																																																				
Secondary Standards	ID #	Check Date (in house)	Scheduled Check																																																				
Power sensor HP 8481A	MY41092312	10-Aug-03 (SPEAG, in house check Jan-04)	In house check: Oct-05																																																				
Power sensor HP 8481A	MY41093315	10-Aug-03 (SPEAG, in house check Jan-04)	In house check: Oct-05																																																				
RF generator Agilent E8251A	US41140111	4-Aug-03 (Agilent)	In house check: Aug-05																																																				
Network Analyzer HP 8753E	US37390585 S4206	18-Oct-01 (SPEAG, in house check Nov-04)	In house check: Nov-05																																																				
Probe H3DV6	SN: 6065	10-Oct-04 (SPEAG, No. H3-6065-Oct04)	Calibration, Oct-05																																																				
Calibrated by:	Name Mike Meili	Function Laboratory Technician	Signature <i>M. Meili</i>																																																				
Approved by:	Name Fin Bomholt	Function Technical Director	Signature <i>F. Bomholt</i>																																																				
Issued: February 27, 2005																																																							
<p>This calibration certificate is issued as an intermediate solution until the specific calibration procedure is submitted and accepted in the frame of the accreditation of the Calibration Laboratory of Schmid & Partner Engineering AG (based on ISO/IEC 17025 International Standard)</p>																																																							



PCTEST™ HAC REPORT		FCC MEASUREMENT REPORT		Reviewed by: Quality Manager
HAC Filename: HAC.0602170094.A3L	Test Dates: Feb. 22 - 23, 2006	EUT Type: Dual-Band CDMA Phone	FCC ID: A3LSCHA645	Page 59 of 69

References

- [1] ANSI-PC63.19-2003 (Draft)
American National Standard for Methods of Measurement of Compatibility between Wireless Communications Devices and Hearing Aids.

Methods Applied and Interpretation of Parameters:

- *Coordinate System:* y-axis is in the direction of the dipole arms. z-axis is from the basis of the antenna (mounted on the table) towards its feed point between the two dipole arms. x-axis is normal to the other axes. In coincidence with standard [1], the measurement planes (probe sensor center) are selected to be at a distance of 10 mm above the the top edge of the dipole arms.
- *Measurement Conditions:* Further details are available from the hardcopies at the end of the certificate. All figures stated in the certificate are valid at the frequency indicated. The forward power to the dipole connector is set with a calibrated power meter connected and monitored with an auxiliary power meter connected to a directional coupler. While the dipole under test is connected, the forward power is adjusted to the same level.
- *Antenna Positioning:* The dipole is mounted on a HAC Test Arch phantom using the matching dipole positioner with the arms horizontal and the feeding cable coming from the floor. The measurements are performed in a shielded room with absorbers around the setup to reduce the reflections. It is verified before the mounting of the dipole under the Test Arch phantom, that its arms are perfectly in a line. It is installed on the HAC dipole positioner with its arms parallel below the dielectric reference wire and able to move elastically in vertical direction without changing its relative position to the top center of the Test Arch phantom. The vertical distance to the probe is adjusted after dipole mounting with a DASY4 Surface Check job. Before the measurement, the distance between phantom surface and probe tip is verified. The proper measurement distance is selected by choosing the matching section of the HAC Test Arch phantom with the proper device reference point (upper surface of the dipole) and the matching grid reference point (tip of the probe) considering the probe sensor offset. The vertical distance to the probe is essential for the accuracy.
- *Feed Point Impedance and Return Loss:* These parameters are measured using a HP 8753E Vector Network Analyzer. The impedance is specified at the SMA connector of the dipole. The influence of reflections was eliminating by applying the averaging function while moving the dipole in the air, at least 70cm away from any obstacles.
- *E- field distribution:* E field is measured in the x-y-plane with an isotropic ER3D-field probe with 100 mW forward power to the antenna feed point. In accordance with [1], the scan area is 20mm wide, its length exceeds the dipole arm length (180 or 90mm). The sensor center is 10 mm (in z) above the top of the dipole arms. Two 3D maxima are available near the end of the dipole arms. Assuming the dipole arms are perfectly in one line, the average of these two maxima (in subgrid 2 and subgrid 8) is determined to compensate for any non-parallelity to the measurement plane as well as the sensor displacement. The E-field value stated as calibration value represents the maximum of the interpolated 3D-E-field, 10mm above the dipole surface.
- *H-field distribution:* H-field is measured with an isotropic H-field probe with 100mW forward power to the antenna feed point, in the x-y-plane. The scan area and sensor distance is equivalent to the E-field scan. The maximum of the field is available at the center (subgrid 5) above the feed point. The H-field value stated as calibration value represents the maximum of the interpolated H-field, 10mm above the dipole surface at the feed point.

PCTEST™ HAC REPORT		FCC MEASUREMENT REPORT		Reviewed by: Quality Manager
HAC Filename: HAC.0602170094.A3L	Test Dates: Feb. 22 - 23, 2006	EUT Type: Dual-Band CDMA Phone	FCC ID: A3LSCHA645	Page 60 of 69

1 Measurement Conditions

DASY system configuration, as far as not given on page 1.

DASY Version	DASY4	V4.5 B13
DASY PP Version	SEMCAD	V1.8 B144
Phantom	HAC Test Arch	SD HAC P01 BA, #1002
Distance Dipole Top - Probe Center	10 mm	
Scan resolution	dx, dy = 5 mm	area = 20 x 180 mm
Frequency	835 MHz \pm 1 MHz	
Forward power at dipole connector	20.0 dBm = 100mW	
Input power drift	< 0.05 dB	

2 Maximum Field values

H-field 10 mm above dipole surface	condition	interpolated maximum
Maximum measured	100 mW forward power	0.470 A/m

Uncertainty for H-field measurement: 19.5% (k=2)

E-field 10 mm above dipole surface	condition	interpolated maximum
Maximum measured above high end	100 mW forward power	187.0 V/m
Maximum measured above low end	100 mW forward power	183.2 V/m
Averaged maximum above arm	100 mW forward power	185.1 V/m

Uncertainty for E-field measurement: 21.7% (k=2)

3 Appendix

3.1 Antenna Parameters

Frequency	Return Loss	Impedance
800 MHz	16.6 dB	(40.5 - j9.6) Ohm
835 MHz	25.2 dB	(55.3 + j2.4) Ohm
900 MHz	16.6 dB	(52.7 - j15.2) Ohm
950 MHz	25.1 dB	(50.9 + j5.5) Ohm
960 MHz	17.2 dB	(61.0 + j10.9) Ohm



3.2 Antenna Design and Handling

The calibration dipole has a symmetric geometry with a built-in two stub matching network, which leads to the enhanced bandwidth.

The dipole is built of standard semirigid coaxial cable. The internal matching line is open ended. The antenna is therefore open for DC signals.

Do not apply force to dipole arms, as they are liable to bend. The soldered connections near the feedpoint may be damaged. After excessive mechanical stress or overheating, check the impedance characteristics to ensure that the internal matching network is not affected.

After long term use with 40W radiated power, only a slight warming of the dipole near the feedpoint can be measured.

PCTEST™ HAC REPORT		FCC MEASUREMENT REPORT		Reviewed by: Quality Manager
HAC Filename: HAC.0602170094.A3L	Test Dates: Feb. 22 - 23, 2006	EUT Type: Dual-Band CDMA Phone	FCC ID: A3LSCHA645	Page 61 of 69

3.3 Measurement Sheets

3.3.1 Return Loss and Smith Chart

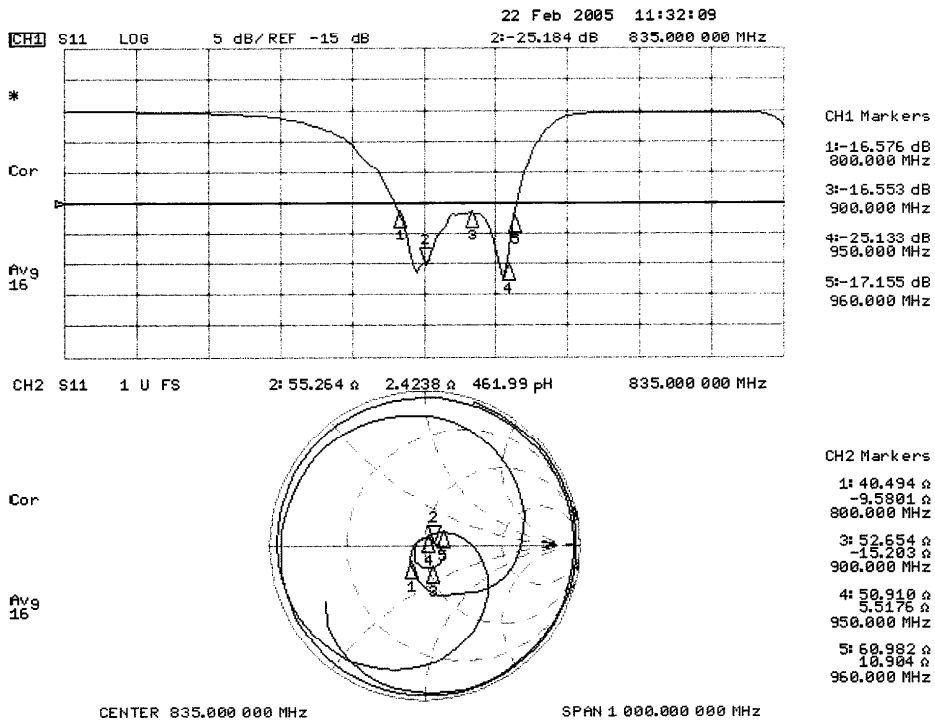



3.3.2 DASY4 H-field result

See page 5

3.3.3 DASY4 E-Field result

See page 6

PCTEST™ HAC REPORT		FCC MEASUREMENT REPORT		Reviewed by: Quality Manager
HAC Filename: HAC.0602170094.A3L	Test Dates: Feb. 22 - 23, 2006	EUT Type: Dual-Band CDMA Phone	FCC ID: A3LSCHA645	Page 62 of 69

Test Laboratory: SPEAG, Zurich, Switzerland
 File Name: H_CD835_1003_050222.da4

DUT: HAC-Dipole 835 MHz; Type: D835V3; Serial: 1003
Program Name: HAC H Dipole

Communication System: CW; Frequency: 835 MHz; Duty Cycle: 1:1
 Medium parameters used: $\sigma = 0$; mho/m, $\epsilon_r = 1$; $\rho = 1 \text{ kg/m}^3$
 Phantom section: H Dipole Section



DASY4 Configuration:
 - Probe: H3DV6 - SN6065; ; Calibrated: 10.12.2004
 - Sensor-Surface: (Fix Surface)
 - Electronics: DAE4 Sn901; Calibrated: 29.06.2004
 - Phantom: HAC Phantom; Type: SD HAC P01 BA; Serial: 1002
 - Measurement SW: DASY4, V4.5 Build 13; Postprocessing SW: SEMCAD, V1.8 Build 144

H Scan 10mm above CD 835 MHz/Hearing Aid Compatibility Test (41x361x1): Measurement grid: dx=5mm, dy=5mm, dz=5.5555mm
 Maximum value of Total field (slot averaged) = 0.470 A/m
Hearing Aid Near-Field Category: M2 (AWF 0 dB)

H in A/m (Time averaged) H in A/m (Slot averaged)

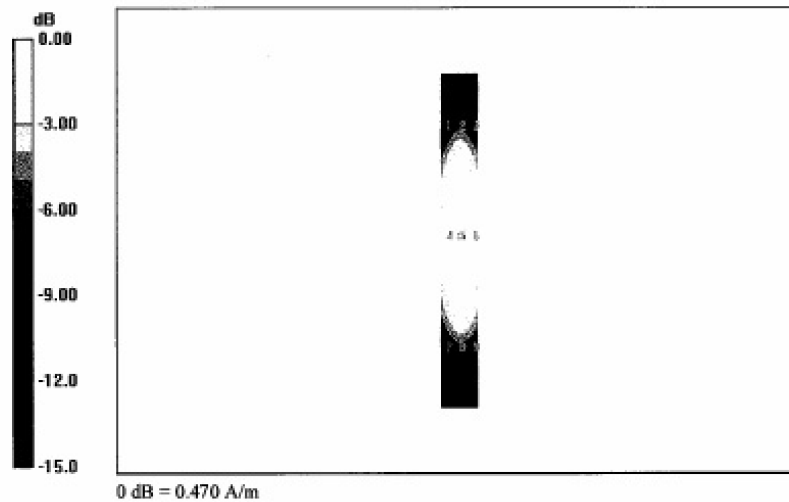
Grid 1	Grid 2	Grid 3	Grid 1	Grid 2	Grid 3
0.365	0.397	0.380	0.365	0.397	0.380
Grid 4	Grid 5	Grid 6	Grid 4	Grid 5	Grid 6
0.408	0.470	0.425	0.408	0.470	0.425
Grid 7	Grid 8	Grid 9	Grid 7	Grid 8	Grid 9
0.350	0.380	0.368	0.350	0.380	0.368



PCTEST™ HAC REPORT		FCC MEASUREMENT REPORT		Reviewed by: Quality Manager
HAC Filename: HAC.0602170094.A3L	Test Dates: Feb. 22 - 23, 2006	EUT Type: Dual-Band CDMA Phone	FCC ID: A3LSCHA645	Page 63 of 69

Test Laboratory: SPEAG, Zurich, Switzerland
 File Name: E_CD835_1003_050223.da4

DUT: HAC-Dipole 835 MHz; Type: D835V3; Serial: 1003
Program Name: HAC E Dipole



Communication System: CW; Frequency: 835 MHz; Duty Cycle: 1:1
 Medium parameters used: $\sigma = 0$; $\rho = 1000 \text{ kg/m}^3$
 Phantom section: E Dipole Section

DASY4 Configuration:
 - Probe: ER3DV6 - SN2328; ConvF(1, 1, 1); Calibrated: 06.10.2004
 - Sensor-Surface: (Fix Surface)
 - Electronics: DAE4 Sn901; Calibrated: 29.06.2004
 - Phantom: HAC Phantom; Type: SD HAC P01 BA; Serial: 1002
 - Measurement SW: DASY4, V4.5 Build 13; Postprocessing SW: SEMCAD, V1.8 Build 144

E Scan 10mm above CD 835 MHz/Hearing Aid Compatibility Test (41x361x1): Measurement grid: dx=5mm, dy=5mm, dz=5.555mm
 Maximum value of Total field (slot averaged) = 187.0 V/m
Hearing Aid Near-Field Category: M2 (AWF 0 dB)

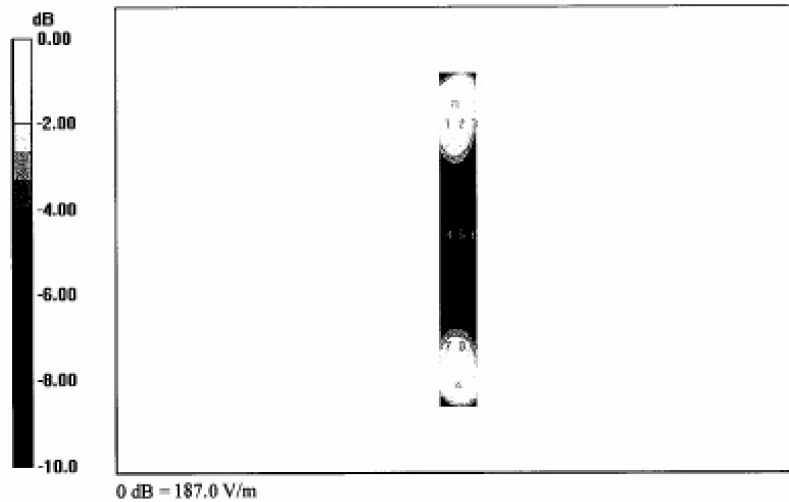
E in V/m (Time averaged)			E in V/m (Slot averaged)		
Grid 1	Grid 2	Grid 3	Grid 1	Grid 2	Grid 3
156.0	187.0	150.1	156.0	187.0	150.1
Grid 4	Grid 5	Grid 6	Grid 4	Grid 5	Grid 6
83.6	84.8	80.4	83.6	84.8	80.4
Grid 7	Grid 8	Grid 9	Grid 7	Grid 8	Grid 9
148.0	183.2	149.5	148.0	183.2	149.5





PCTEST™ HAC REPORT		FCC MEASUREMENT REPORT		Reviewed by: Quality Manager
HAC Filename: HAC.0602170094.A3L	Test Dates: Feb. 22 - 23, 2006	EUT Type: Dual-Band CDMA Phone	FCC ID: A3LSCHA645	Page 64 of 69

14. CONCLUSION



The measurements indicate that the wireless communications device complies with the HAC limits specified in accordance with the ANSI PC63.19 Standard and FCC WT Docket No. 01-309 RM-8658. Precise laboratory measures were taken to assure repeatability of the tests. The tested device complies with the requirements in respect to all parameters specific to the test. The test results and statements relate only to the item(s) tested.

Please note that the M-rating for this equipment only represents the field interference possible against a hypothetical and typical hearing aid. The measurement system and techniques presented in this evaluation are proposed in the ANSI standard as a means of best approximating wireless device compatibility with a hearing-aid. The literature is under continual re-construction.



PCTEST™ HAC REPORT		FCC MEASUREMENT REPORT		Reviewed by: Quality Manager
HAC Filename: HAC.0602170094.A3L	Test Dates: Feb. 22 - 23, 2006	EUT Type: Dual-Band CDMA Phone	FCC ID: A3LSCHA645	Page 65 of 69

15. REFERENCES

1. ANSI PC63.19-2005 D3.6, American National Standard for Methods of Measurement of Compatibility between Wireless communication devices and Hearing Aids.", New York, NY, IEEE, April 2005.
2. Berger, H. S., "Compatibility Between Hearing Aids and Wireless Devices," Electronic Industries Forum, Boston, MA, May, 1997
3. Berger, H. S., "Hearing Aid and Cellular Phone Compatibility: Working Toward Solutions," Wireless Telephones and Hearing Aids: New Challenges for Audiology, Gallaudet University, Washington, D.C., May, 1997 (To be reprinted in the American Journal of Audiology).
4. Berger, H. S., "Hearing Aid Compatibility with Wireless Communications Devices," IEEE International Symposium on Electromagnetic Compatibility, Austin, TX, August, 1997.
5. Bronaugh, E. L., "Simplifying EMI Immunity (Susceptibility) Tests in TEM Cells," in the 1990 IEEE International Symposium on Electromagnetic Compatibility Symposium Record, Washington, D.C., August 1990, pp. 488-491
6. Byrne, D. and Dillon, H., The National Acoustics Laboratory (NAL) New Procedure for Selecting the Gain and Frequency Response of a Hearing Aid, Ear and Hearing 7:257-265, 1986.
7. Crawford, M. L., "Measurement of Electromagnetic Radiation from Electronic Equipment using TEM Transmission Cells," U.S. Department of Commerce, National Bureau of Standards, NBSIR 73-306, Feb. 1973.
8. Crawford, M. L., and Workman, J. L., "Using a TEM Cell for EMC Measurements of Electronic Equipment," U.S. Department of Commerce, National Bureau of Standards. Technical Note 1013, July 1981.
9. EHIMA GSM Project, Development phase, Project Report (1st part) Revision A. Technical-Audiological Laboratory and Telecom Denmark, October 1993.
10. EHIMA GSM Project, Development phase, Part II Project Report. Technical-Audiological Laboratory and Telecom Denmark, June 1994.
11. EHIMA GSM Project Final Report, Hearing Aids and GSM Mobile Telephones: Interference Problems, Methods of Measurement and Levels of Immunity. Technical-Audiological Laboratory and Telecom Denmark, 1995.
12. HAMPIS Report, Comparison of Mobile phone electromagnetic near field with an upscaled electromagnetic far field, using hearing aid as reference, 21 October 1999.
13. Hearing Aids/GSM, Report from OTWIDAM, Technical-Audiological Laboratory and Telecom Denmark, April 1993.
14. IEEE 100, The Authoritative Dictionary of IEEE Standards Terms, Seventh Edition.

PCTEST™ HAC REPORT		FCC MEASUREMENT REPORT		Reviewed by: Quality Manager
HAC Filename: HAC.0602170094.A3L	Test Dates: Feb. 22 - 23, 2006	EUT Type: Dual-Band CDMA Phone	FCC ID: A3LSCHA645	Page 66 of 69

15. Joyner, K. H., et. al., Interference to Hearing Aids by the New Digital Mobile Telephone System, Global System for Mobile (GSM) Communication Standard, National Acoustic Laboratory, Australian Hearing Series, Sydney 1993.
16. Joyner, K. H., et. al., Interference to Hearing Aids by the Digital Mobile Telephone System, Global System for Mobile Communications (GSM), NAL Report #131, National Acoustic Laboratory, Australian Hearing Series, Sydney, 1995.
17. Kecker, W. T., Crawford, M. L., and Wilson, W. A., "Construction of a Transverse Electromagnetic Cell", U.S. Department of Commerce, National Bureau of Standards, Technical Note 1011, Nov. 1978.
18. Konigstein, D., and Hansen, D., "A New Family of TEM Cells with enlarged bandwidth and Optimized working Volume," in the Proceedings of the 7th International Symposium on EMC, Zurich, Switzerland, March 1987; 50:9, pp. 127-132.
19. Kuk, F., and Hjorstgaard, N. K., "Factors affecting interference from digital cellular telephones," Hearing Journal, 1997; 50:9, pp 32-34.
20. Ma, M. A., and Kanda, M., "Electromagnetic Compatibility and Interference Metrology," U.S. Department of Commerce, National Bureau of Standards, Technical Note 1099, July 1986, pp. 17-43.
21. Ma, M. A., Sreenivashiah, I. , and Chang, D. C., "A Method of Determining the Emission and Susceptibility Levels of Electrically Small Objects Using a TEM Cell," U.S. Department of Commerce, National Bureau of Standards, Technial Note 1040, July 1981.
22. McCandless, G. A., and Lyregaard, P. E., Prescription of Gain/Output (POGO) for Hearing Aids, Hearing Instruments 1:16-21, 1983
23. Skopec, M., "Hearing Aid Electromagnetic Interference from Digital Wireless Telephones, "IEEE Transactions on Rehabilitation Engineering, vol. 6, no. 2, pp. 235-239, June 1998.
24. Technical Report, GSM 05.90, GSM EMC Considerations, European Telecommunications Standards Institute, January 1993.
25. Victorian, T. A., "Digital Cellular Telephone Interference and Hearing Aid Compatibility—an Update," Hearing Journal 1998; 51:10, pp. 53-60
26. Wong, G. S. K., and Embleton, T. F. W., eds., AIP Handbook of Condenser Microphones: Theory, Calibration and Measurements, AIP Press.

PCTEST™ HAC REPORT		FCC MEASUREMENT REPORT		Reviewed by: Quality Manager
HAC Filename: HAC.0602170094.A3L	Test Dates: Feb. 22 - 23, 2006	EUT Type: Dual-Band CDMA Phone	FCC ID: A3LSCHA645	Page 67 of 69