

# TEST REPORT

FCC Test for RT4423-48B  
Certification

**APPLICANT**  
SAMSUNG Electronics Co., Ltd.

**REPORT NO.**  
HCT-RF-2209-FC004-R1

**DATE OF ISSUE**  
September 30, 2022

**Tested by**  
Kyung Soo Kang



---

**Technical Manager**  
Jong Seok Lee



**HCT CO., LTD.**  
*Bongjai Huh*  
BongJai Huh / CEO



**HCT Co., Ltd.**

74, Seoicheon-ro 578beon-gil, Majang-myeon, Icheon-si, Gyeonggi-do, 17383 KOREA  
Tel. +82 31 634 6300 Fax. +82 31 645 6401

**TEST  
REPORT**  
FCC Test for  
RT4423-48B

**REPORT NO.**  
HCT-RF-2209-FC004-R1

**DATE OF ISSUE**  
September 30, 2022

**Additional Model**  
-

<b>Applicant</b>	<b>SAMSUNG Electronics Co., Ltd.</b> 129, Samsung-ro, Yeongtong-gu, Suwon-si, Gyeonggi-do, 16677, Rep. of Korea
<b>EUT Type</b>	RRU(RT4423)
<b>Model Name</b>	RT4423-48B
<b>FCC ID</b>	A3LRT4423-48B
<b>Date of Test</b>	July 29, 2022 ~ September 22, 2022
<b>FCC Rule Parts:</b>	CFR 47 Part 2, Part 96

The result shown in this test report refer only to the sample(s) tested unless otherwise stated.  
This test results were applied only to the test methods required by the standard.

## REVISION HISTORY

The revision history for this test report is shown in table.

Revision No.	Date of Issue	Description
0	September 29, 2022	Initial Release
1	September 30, 2022	<ul style="list-style-type: none"><li>- Added note on page 10.</li><li>- Revised voltage information on page 5, 1140.</li><li>- Added the ac power supply in section 4.</li></ul>

The measurements shown in this report were made in accordance with the procedures indicated, and the emissions from this equipment were found to be within the limits applicable. I assume full responsibility for the accuracy and completeness of these measurements, and for the qualifications of all persons taking them. It is further stated that upon the basis of the measurements made, the equipment tested is capable of operation in accordance with the requirements of the FCC Rules under normal use and maintenance.

If this report is required to confirmation of authenticity, please contact to [www.hct.co.kr](http://www.hct.co.kr)

## CONTENTS

1. GENERAL INFORMATION	5
1.1. APPLICANT INFORMATION	5
1.2. PRODUCT INFORMATION	5
1.3. TEST INFORMATION	8
2. FACILITIES AND ACCREDITATIONS	9
2.1. FACILITIES	9
2.2. EQUIPMENT	9
3. TEST SPECIFICATIONS	10
3.1. STANDARDS	10
3.2. ADDITIONAL DESCRIPTIONS ABOUT TEST	11
3.3. MAXIMUM MEASUREMENT UNCERTAINTY	16
3.4. STANDARDS ENVIRONMENTAL TEST CONDITIONS	16
3.5. TEST DIAGRAMS	17
4. TEST EQUIPMENTS	19
5. TEST RESULT	20
5.1. RF OUTPUT POWER and PSD	20
5.2. PAPR	298
5.3. OCCUPIED BANDWIDTH	412
5.4. OUT-OF-BAND UNWANTED EMISSIONS	527
5.5. SPURIOUS UNWANTED EMISSIONS	805
5.6. RADIATED EMISSIONS	1131
5.7. FREQUENCY STABILITY	1137
6. Annex B_EUT AND TEST SETUP PHOTO	1141

## 1. GENERAL INFORMATION

### 1.1. APPLICANT INFORMATION

Company Name	Samsung Electronics Co., Ltd.
Company Address	129, Samsung-ro, Yeongtong-gu, Suwon-si, Gyeonggi-do, 16677, Rep. of Korea

### 1.2. PRODUCT INFORMATION

EUT Type	RRU(RT4423)			
EUT Serial Number	S618627624			
Power Supply	110 Vac / 230 Vac			
Output Power	Band	Carrier	Bandwidth	Power
	CBRS NR	1	10 MHz	1.00 W/path, Total: 4.00 W
	CBRS NR	1	20 MHz	1.98 W/path, Total: 7.90 W
	CBRS NR	1	30 MHz	2.38 W/path, Total: 9.50 W
	CBRS NR	1	40 MHz	3.15 W/path, Total: 12.60 W
	CBRS NR	1	60 MHz	4.78 W/path, Total: 19.10 W
	CBRS NR	1	80 MHz	5.00 W/path, Total: 20.00 W
	CBRS NR	1	100 MHz	5.00 W/path, Total: 20.00 W
	CBRS LTE	1	5 MHz	0.50 W/path, Total: 2.00 W
	CBRS LTE	1	10 MHz	1.00 W/path, Total: 4.00 W
	CBRS LTE	1	15 MHz	1.50 W/path, Total: 6.00 W
	CBRS LTE	1	20 MHz	1.98 W/path, Total: 7.90 W
	CBRS (NR + NR)	2	60 MHz + 30 MHz	5.00 W/path, Total: 20.00 W
	CBRS (LTE + LTE)	2	15 MHz + 15 MHz	2.40 W/path, Total: 9.60 W
	CBRS (LTE + NR)	2	5 MHz + 10 MHz	1.18 W/path, Total: 4.70 W
	CBRS (NR + NR + NR)	3	20 MHz + 20 MHz + 10 MHz	3.95 W/path, Total: 15.80 W
	CBRS (NR + NR + NR)	3	30 MHz + 30 MHz + 10 MHz	4.43 W/path, Total: 17.70 W
	CBRS (LTE + LTE + LTE)	3	15 MHz + 15 MHz + 10 MHz	3.18 W/path, Total: 12.73 W
	CBRS (LTE + LTE + LTE)	3	20 MHz + 15 MHz + 15 MHz	3.97 W/path, Total: 15.88 W
	CBRS (LTE + LTE + LTE)	3	20 MHz + 20 MHz + 20 MHz	4.73 W/path, Total: 18.93 W
CBRS (LTE + LTE + LTE + LTE)	4	20 MHz + 20 MHz + 20 MHz + 20 MHz	4.99 W/path, Total: 19.95 W	
CBRS (LTE + LTE + LTE + LTE + LTE)	5	15 MHz + 15 MHz + 15 MHz + 15 MHz + 10 MHz	4.43 W/path, Total: 17.72 W	
CBRS (LTE + LTE + LTE + LTE + LTE)	5	20 MHz + 20 MHz + 20 MHz + 20 MHz + 10 MHz	4.99 W/path, Total: 19.95 W	
CBRS (LTE + LTE + LTE + LTE + LTE)	5	20 MHz + 20 MHz + 20 MHz + 20 MHz + 20 MHz	4.99 W/path, Total: 19.95 W	
CBRS (NR + NR + LTE + LTE + LTE)	5	40 MHz + 10 MHz + 20 MHz + 5 MHz + 5 MHz	5.00 W/path, Total: 20.00 W	
CBRS (NR + NR + NR + LTE + LTE)	5	40 MHz + 20 MHz + 20 MHz + 10 MHz + 10 MHz	5.00 W/path, Total: 20.00 W	
Carrier	1CC, 2CC, 3CC, 4CC, 5CC			
Frequency Range	3 550 MHz ~ 3 700 MHz			

	Mode	Bandwidth	Emission Designator			
			QPSK (G7D)	Total E.I.R.P. (dBm)	QAM (W7D)	Total E.I.R.P. (dBm)
	CBRS NR	10 MHz	8M69G7D	46.93	8M69W7D	46.94
	CBRS NR	20 MHz	18M3G7D	46.97	18M4W7D	47.00
	CBRS NR	30 MHz	28M0G7D	46.97	28M0W7D	47.00
	CBRS NR	40 MHz	38M0G7D	46.95	38M0W7D	46.96
	CBRS NR	60 MHz	58M0G7D	46.92	58M1W7D	46.97
	CBRS NR	80 MHz	77M7G7D	46.93	77M8W7D	46.96
	CBRS NR	100 MHz	97M8G7D	45.86	97M8W7D	45.94
	CBRS LTE	5 MHz	4M50G7D	46.99	4M52W7D	46.99
	CBRS LTE	10 MHz	9M00G7D	46.85	9M04W7D	46.87
	CBRS LTE	15 MHz	13M5G7D	46.94	13M5W7D	46.94
	CBRS LTE	20 MHz	18M0G7D	46.56	18M0W7D	46.86
	CBRS (NR + NR) (Contiguous)	60 MHz + 30 MHz	87M8G7D	46.37	87M8W7D	46.41
	CBRS (LTE + LTE) (Contiguous)	15 MHz + 15 MHz	28M5G7D	46.67	28M5W7D	46.82
	CBRS (LTE + NR) (Contiguous)	5 MHz + 10 MHz	14M1G7D	45.66	14M1W7D	45.79
	CBRS (NR + NR + NR) (Contiguous)	20 MHz + 20 MHz + 10 MHz	48M3G7D	46.46	48M4W7D	46.53
	CBRS (NR + NR + NR) (Contiguous)	30 MHz + 30 MHz + 10 MHz	68M1G7D	46.44	68M2W7D	46.53
	CBRS (LTE + LTE + LTE) (Contiguous)	15 MHz + 15 MHz + 10 MHz	38M7G7D	46.28	38M7W7D	46.71
	CBRS (LTE + LTE + LTE) (Contiguous)	20 MHz + 15 MHz + 15 MHz	48M1G7D	46.39	48M1W7D	46.62
	CBRS (LTE + LTE + LTE) (Contiguous)	20 MHz + 20 MHz + 20 MHz	57M8G7D	46.61	58M0W7D	46.76
	CBRS (LTE + LTE + LTE + LTE) (Contiguous)	20 MHz + 20 MHz + 20 MHz + 20 MHz	77M1G7D	46.31	77M8W7D	46.64
	CBRS (LTE + LTE + LTE + LTE) (Contiguous)	15 MHz + 15 MHz + 15 MHz + 15 MHz + 10 MHz	68M5G7D	46.35	68M6W7D	46.60
	CBRS (LTE + LTE + LTE + LTE) (Contiguous)	20 MHz + 20 MHz + 20 MHz + 20 MHz + 10 MHz	88M3G7D	46.37	88M2W7D	46.39
	CBRS (LTE + LTE + LTE + LTE) (Contiguous)	20 MHz + 20 MHz + 20 MHz + 20 MHz + 20 MHz	97M6G7D	45.71	97M7W7D	45.79
	CBRS (NR + NR + LTE + LTE + LTE) (Contiguous)	40 MHz + 10 MHz + 20 MHz + 5 MHz + 5 MHz	78M5G7D	46.51	78M5W7D	46.43
	CBRS (NR + NR + NR + LTE + LTE) (Contiguous)	40 MHz + 20 MHz + 20 MHz + 10 MHz + 10 MHz	98M2G7D	45.97	98M2W7D	46.48
	CBRS (NR + NR) (Non-Contiguous)	60 MHz + 30 MHz	85M8G7D	46.37	86M0W7D	46.43
	CBRS (LTE + LTE) (Non-Contiguous)	15 MHz + 15 MHz	27M0G7D	46.62	27M0W7D	46.70

Emission Designator

CBRS (LTE + NR) (Non-Contiguous)	5 MHz + 10 MHz	13M2G7D	45.45	13M2W7D	45.82
CBRS (NR + NR + NR) (Non-Contiguous)(1C+2C)	20 MHz + 20 MHz + 10 MHz	46M7G7D	46.53	46M8W7D	46.56
CBRS (NR + NR + NR) (Non-Contiguous)(2C+1C)	20 MHz + 20 MHz + 10 MHz	46M9G7D	46.61	46M9W7D	46.65
CBRS (NR + NR + NR) (Non-Contiguous)(1C+2C)	30 MHz + 30 MHz + 10 MHz	66M1G7D	46.82	66M2W7D	46.99
CBRS (NR + NR + NR) (Non-Contiguous)(2C+1C)	30 MHz + 30 MHz + 10 MHz	66M4G7D	45.01	66M6W7D	44.98
CBRS (LTE + LTE + LTE) (Non-Contiguous)(1C+2C)	15 MHz + 15 MHz + 10 MHz	37M2G7D	46.63	37M2W7D	46.86
CBRS (LTE + LTE + LTE) (Non-Contiguous)(2C+1C)	15 MHz + 15 MHz + 10 MHz	37M4G7D	46.46	37M5W7D	46.89
CBRS (LTE + LTE + LTE) (Non-Contiguous)(1C+2C)	20 MHz + 15 MHz + 15 MHz	46M3G7D	46.61	46M4W7D	46.70
CBRS (LTE + LTE + LTE) (Non-Contiguous)(2C+1C)	20 MHz + 15 MHz + 15 MHz	46M6G7D	46.46	46M6W7D	46.69
CBRS (LTE + LTE + LTE) (Non-Contiguous)(1C+2C)	20 MHz + 20 MHz + 20 MHz	55M8G7D	46.65	55M8W7D	46.80
CBRS (LTE + LTE + LTE) (Non-Contiguous)(2C+1C)	20 MHz + 20 MHz + 20 MHz	55M8G7D	46.44	55M9W7D	46.51
CBRS (LTE + LTE + LTE + LTE) (Non-Contiguous)(1C+3C)	20 MHz + 20 MHz + 20 MHz + 20 MHz	75M7G7D	46.86	75M8W7D	46.89
CBRS (LTE + LTE + LTE + LTE) (Non-Contiguous)(3C+1C)	20 MHz + 20 MHz + 20 MHz + 20 MHz	75M7G7D	46.21	75M7W7D	46.58
CBRS (LTE + LTE + LTE + LTE + LTE) (Non-Contiguous)(1C+4C)	15 MHz + 15 MHz + 15 MHz + 15 MHz + 10 MHz	67M0G7D	46.54	67M0W7D	46.74
CBRS (LTE + LTE + LTE + LTE + LTE) (Non-Contiguous)(4C+1C)	15 MHz + 15 MHz + 15 MHz + 15 MHz + 10 MHz	67M3G7D	46.28	67M3W7D	46.59
CBRS (LTE + LTE + LTE + LTE + LTE) (Non-Contiguous)(1C+4C)	20 MHz + 20 MHz + 20 MHz + 20 MHz + 10 MHz	86M3G7D	46.41	86M3W7D	46.38
CBRS (LTE + LTE + LTE + LTE + LTE) (Non-Contiguous)(4C+1C)	20 MHz + 20 MHz + 20 MHz + 20 MHz + 10 MHz	86M6G7D	46.40	86M7W7D	46.40
CBRS (LTE + LTE + LTE + LTE + LTE) (Non-Contiguous)(1C+4C)	20 MHz + 20 MHz + 20 MHz + 20 MHz + 20 MHz	95M6G7D	45.75	95M7W7D	45.87
CBRS (LTE + LTE + LTE + LTE + LTE) (Non-Contiguous)(4C+1C)	20 MHz + 20 MHz + 20 MHz + 20 MHz + 20 MHz	95M5G7D	45.26	95M7W7D	45.64
CBRS (NR + NR + LTE + LTE + LTE) (Non-Contiguous)(1C+4C)	40 MHz + 10 MHz + 20 MHz + 5 MHz + 5 MHz	77M0G7D	46.81	77M0W7D	46.67
CBRS (NR + NR + LTE + LTE + LTE) (Non-Contiguous)(4C+1C)	40 MHz + 10 MHz + 20 MHz + 5 MHz + 5 MHz	78M0G7D	46.26	78M0W7D	46.43
CBRS (NR + NR + NR + LTE + LTE) (Non-Contiguous)(1C+4C)	40 MHz + 20 MHz + 20 MHz + 10 MHz + 10 MHz	96M5G7D	45.99	96M5W7D	46.29

	CBRS (NR + NR + NR + LTE + LTE) (Non-Contiguous)(4C+1C)	40 MHz + 20 MHz + 20 MHz + 10 MHz + 10 MHz	97M2G7D	46.28	97M2W7D	45.99
Modulation Type	LTE: QPSK, 16QAM, 64QAM, 256QAM NR: QPSK, 16QAM, 64QAM, 256QAM					
CBSD Category	Category B CBSD					
Antenna Specification	Min. 5 dBi ~ Max. 17.7 dBi					

### 1.3. TEST INFORMATION

FCC Rule Parts	CFR 47 Part 2, Part 96
Measurement standards	ANSI C63.26-2015, KDB 662911 D01 v02r01, KDB 971168 D01 v03r01, KDB 940660 D01 v03
Place of Test	HCT CO., LTD. 74, Seoicheon-ro 578beon-gil, Majang-myeon, Icheon-si, Gyeonggi-do, 17383, Rep. of KOREA



## 2. FACILITIES AND ACCREDITATIONS

### 2.1. FACILITIES

The SAC(Semi-Anechoic Chamber) and conducted measurement facility used to collect the radiated data are located at the 74, Seoicheon-ro 578beon-gil, Majang-myeon, Icheon-si, Gyeonggi-do, 17383, Rep. of KOREA.

The site is constructed in conformance with the requirements of ANSI C63.4. (Version :2014) and CISPR Publication 22.

Detailed description of test facility was submitted to the Commission and accepted dated April 02, 2018 (Registration Number: KR0032).

### 2.2. EQUIPMENT

Radiated emissions are measured with one or more of the following types of Linearly polarized antennas: tuned dipole, bi-conical, log periodic, bi-log, and/or ridged waveguide, horn. Spectrum analyzers with pre-selectors and quasi-peak detectors are used to perform radiated measurements.

Calibrated wideband preamplifiers, coaxial cables, and coaxial attenuators are also used for making measurements.

All receiving equipment conforms to CISPR Publication 16-1, "Radio Interference Measuring Apparatus and Measurement Methods."

### 3. TEST SPECIFICATIONS

#### 3.1. STANDARDS

The following tests were conducted on a sample of the equipment for the purpose of demonstrating compliance with FCC Part 2, Part 96

Description	Reference	Results
RF Output Power and PSD	§ 2.1046, § 96.41 (b)	Compliant
PAPR	§ 2.1046, § 96.41 (g)	Compliant
Occupied Bandwidth	§ 2.1049	Compliant
Out-of-band Unwanted Emissions	§ 96.41 (e)	Compliant
Spurious Unwanted Emissions	§ 96.41 (e)	Compliant
Radiated Emissions	§ 96.41 (e)	Compliant
Frequency Stability	§ 2.1055	Compliant

**Note:**

1. This device is reusing the test data of conducted test from the test report (HCT-RF-2209-FC003) since this devices has same HW and SW capabilities with the device referenced except AC power supply. And all radiated test has performed in this device.

### 3.2. ADDITIONAL DESCRIPTIONS ABOUT TEST

- The EUT was operated in a manner representative of the typical usage of the equipment.
- During all testing, system components were manipulated within the confines of typical usage to maximize each emission.
- CC means component carriers and EUT support 1CC ~ 5CC.
- Test was performed the carrier case having maximum output power and maximum PSD(it means the worst case.).
- All LTE and NR modulation types (LTE: QPSK, 16QAM, 64QAM, 256QAM; NR: QPSK, 16QAM, 64QAM, 256QAM) supported by the EUT have been tested.
- All mode of operation, supporting bandwidth and frequencies were investigated. The test plots shown in the following sections represent the worst case emissions.
- The measurement has been performed for LTE and NR carriers in the mode of full resource block size as worst case to transmit maximum output power.
- The dummy loads were connected to the RF output ports for radiated spurious emission testing.
- Because of the EUT using TDD technology, it cannot be configured to transmit continuously and measurement instrument cannot be configured to measure only during active transmissions. So, we performed the measurement using duty cycle method.

Measurement Result of RT4423-48B Transmit On/Off Timing

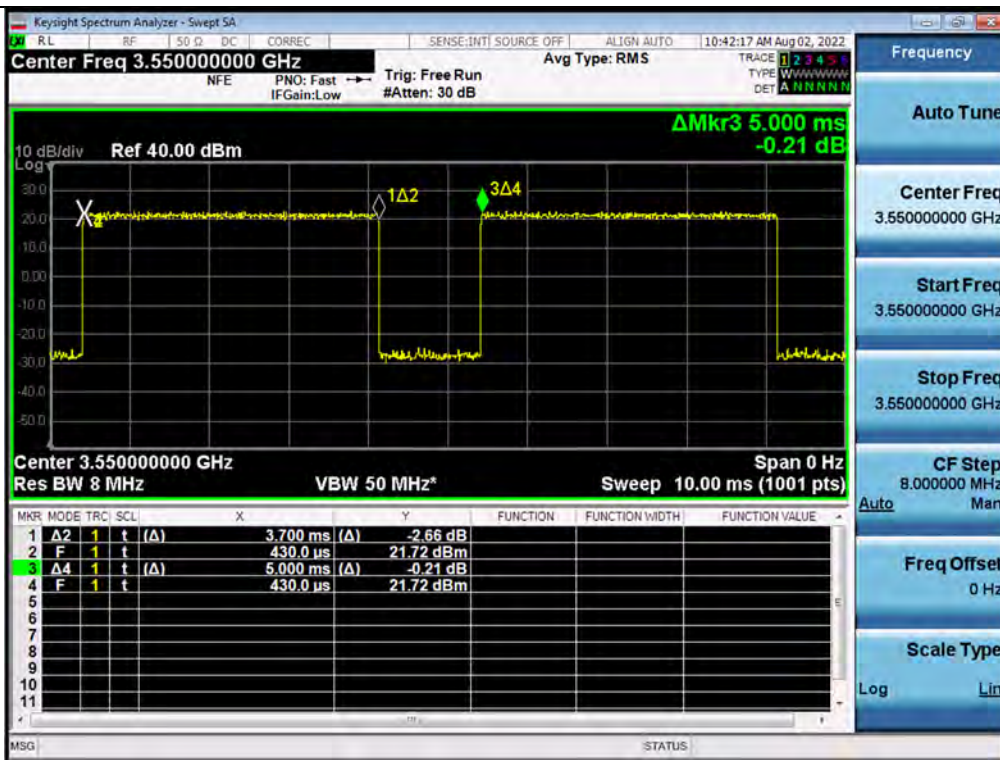

- The EUT duty cycle is calculated according to ANSI C63.26 - 5.2.4.3.4.

$$\text{Duty Cycle} = \text{On-time} / \text{Transmitter period} = 3.7 \text{ ms} / 5.0 \text{ ms} = 0.74$$

$$\text{Duty Correction} = 10 \log (1/\text{duty cycle}) = 10 \log (1/0.74) = 1.307 \text{ dB}$$

-Ant 0-

Correction factor table

Frequency (MHz)	Factor (dB)	Frequency (MHz)	Factor (dB)
500	32.910	20 000	28.243
600	33.051	21 000	28.558
700	33.210	22 000	28.485
800	33.241	23 000	28.338
900	33.385	24 000	28.722
1 000	33.461	25 000	29.074
2 000	34.334	26 000	29.580
3 000	34.944	27 000	29.178
4 000	35.226	28 000	29.303
5 000	35.823	29 000	29.753
6 000	35.749	30 000	29.548
7 000	36.169	31 000	31.461
8 000	36.229	32 000	31.146
9 000	36.041	33 000	30.648
10 000	36.851	34 000	29.663
11 000	37.914	35 000	29.915
12 000	38.068	36 000	30.390
13 000	38.807	37 000	30.138
14 000	38.674	38 000	30.427
15 000	39.919	39 000	30.740
16 000	40.774	39 500	30.198
17 000	41.133	-	-
18 000	25.208	-	-
19 000	27.822	-	-

-Ant 1-

Correction factor table

Frequency (MHz)	Factor (dB)	Frequency (MHz)	Factor (dB)
500	32.503	20 000	28.243
600	32.640	21 000	28.558
700	32.825	22 000	28.485
800	32.861	23 000	28.338
900	33.007	24 000	28.722
1 000	33.109	25 000	29.074
2 000	34.099	26 000	29.580
3 000	34.728	27 000	29.178
4 000	35.203	28 000	29.303
5 000	36.213	29 000	29.753
6 000	36.029	30 000	29.548
7 000	36.680	31 000	31.461
8 000	36.883	32 000	31.146
9 000	37.051	33 000	30.648
10 000	37.719	34 000	29.663
11 000	38.476	35 000	29.915
12 000	39.292	36 000	30.390
13 000	39.490	37 000	30.138
14 000	39.845	38 000	30.427
15 000	41.379	39 000	30.740
16 000	40.406	39 500	30.198
17 000	40.501	-	-
18 000	33.896	-	-
19 000	27.822	-	-

-Ant 2-

Correction factor table

Frequency (MHz)	Factor (dB)	Frequency (MHz)	Factor (dB)
500	30.141	20 000	28.243
600	30.316	21 000	28.558
700	30.469	22 000	28.485
800	30.521	23 000	28.338
900	30.638	24 000	28.722
1 000	30.744	25 000	29.074
2 000	31.665	26 000	29.580
3 000	32.452	27 000	29.178
4 000	33.042	28 000	29.303
5 000	34.406	29 000	29.753
6 000	34.442	30 000	29.548
7 000	35.253	31 000	31.461
8 000	35.931	32 000	31.146
9 000	36.408	33 000	30.648
10 000	37.687	34 000	29.663
11 000	39.249	35 000	29.915
12 000	40.151	36 000	30.390
13 000	40.813	37 000	30.138
14 000	41.062	38 000	30.427
15 000	42.629	39 000	30.740
16 000	46.210	39 500	30.198
17 000	45.622	-	-
18 000	34.979	-	-
19 000	27.822	-	-

-Ant 3-

Correction factor table

Frequency (MHz)	Factor (dB)	Frequency (MHz)	Factor (dB)
500	30.282	20 000	28.243
600	30.452	21 000	28.558
700	30.618	22 000	28.485
800	30.673	23 000	28.338
900	30.794	24 000	28.722
1 000	30.903	25 000	29.074
2 000	31.855	26 000	29.580
3 000	32.684	27 000	29.178
4 000	33.361	28 000	29.303
5 000	34.519	29 000	29.753
6 000	34.733	30 000	29.548
7 000	35.634	31 000	31.461
8 000	38.263	32 000	31.146
9 000	36.947	33 000	30.648
10 000	38.476	34 000	29.663
11 000	39.928	35 000	29.915
12 000	40.669	36 000	30.390
13 000	41.390	37 000	30.138
14 000	41.725	38 000	30.427
15 000	43.160	39 000	30.740
16 000	46.604	39 500	30.198
17 000	47.398	-	-
18 000	27.628	-	-
19 000	27.822	-	-

**3.3. MAXIMUM MEASUREMENT UNCERTAINTY**

Description	Condition	Uncertainty
Radiated Disturbance	9 kHz ~ 30 MHz	4.40 dB
	30 MHz ~ 1 GHz	5.74 dB
	1 GHz ~ 18 GHz	5.51 dB
	18 GHz ~ 40 GHz	5.92 dB

Coverage factor  $k=2$ , Confidence levels of 95 %

**3.4. STANDARDS ENVIRONMENTAL TEST CONDITIONS**

Temperature :	+15 °C to +35 °C
Relative humidity:	30 % to 60 %
Air pressure	860 mbar to 1 060 mbar



## 3.5. TEST DIAGRAMS

## Conducted Test

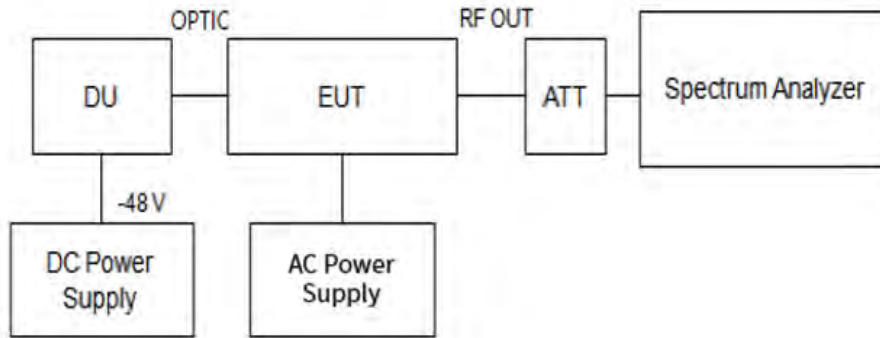

## Radiated Test

30 MHz ~ 1 GHz

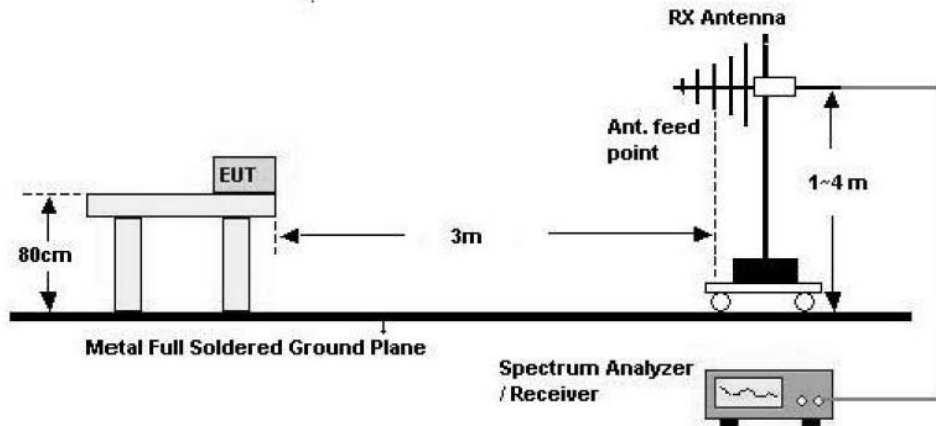

Above 1 GHz

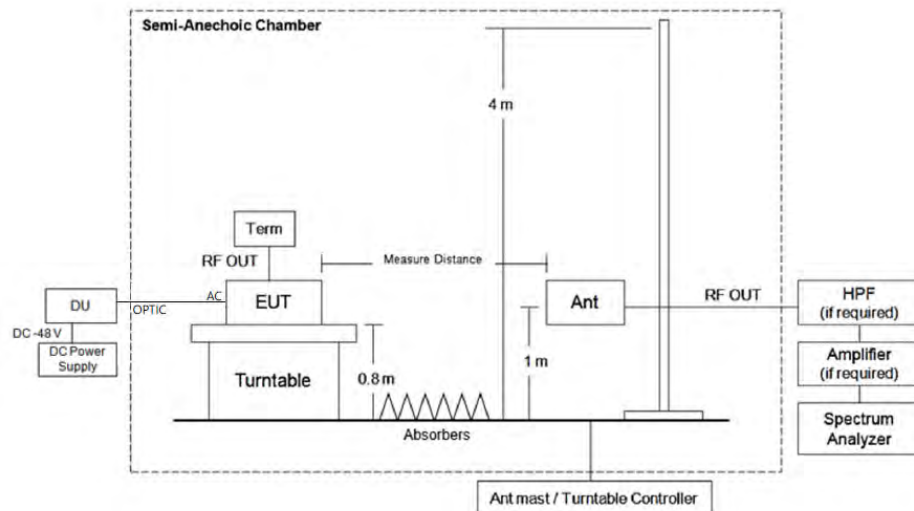

※ EUT position is adopted by placement of floor-standing refer to section 5.5.2.3.2 of ANSI C63.26-2015

Frequency Stability

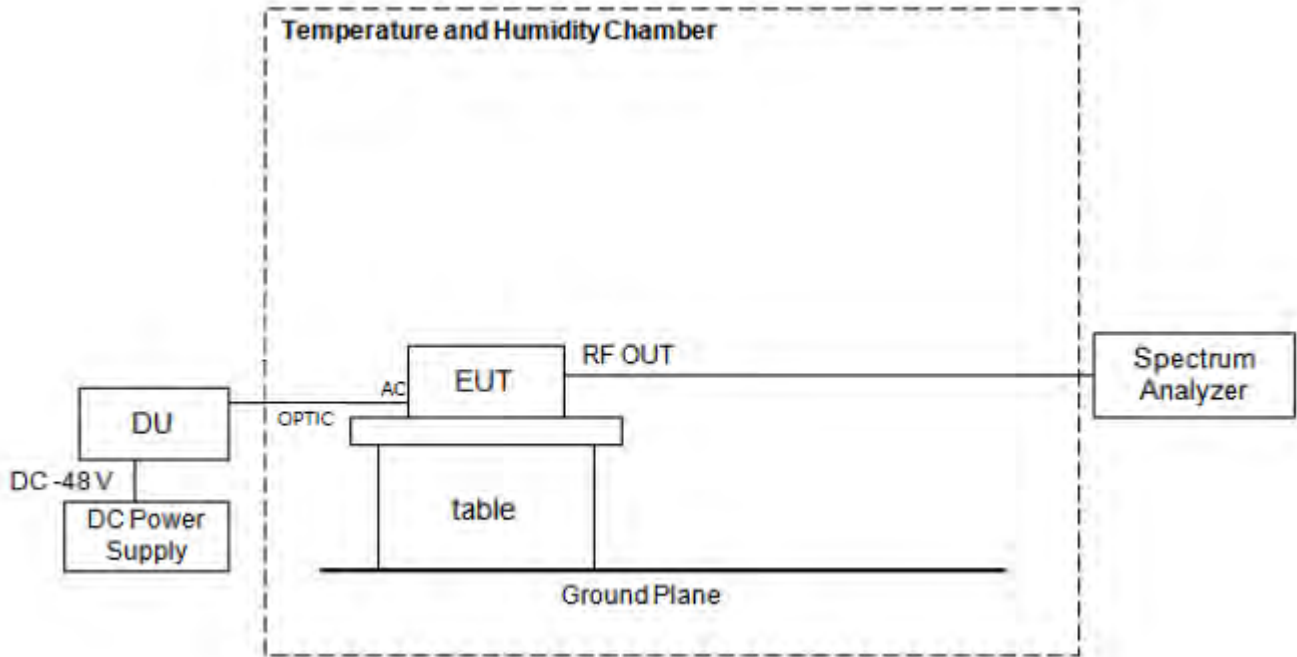

**Note:** All modulations(LTE: QPSK, 16QAM, 64QAM, 256QAM; NR: QPSK, 16QAM, 64QAM, 256QAM) were investigated and the worst case configuration channel results are reported.

#### 4. TEST EQUIPMENTS

Equipment	Model	Manufacturer	Serial No.	Due to Calibration	Calibration Interval
MXA Signal Analyzer	N9020A	Agilent	MY46471250	2023-07-22	Annual
PXA Signal Analyzer	N9030A	Keysight	MY49431434	2023-01-05	Annual
PXA Signal Analyzer	N9030B	Keysight	MY60070602	2022-10-22	Annual
*30 dB Attenuator	67-30-33	API Weinschel, Inc.	CL4337	2023-05-03	Annual
*20 dB Attenuator	FAS-23-20	MCLI	103756	2023-01-03	Annual
DC Power Supply	6674A	Agilent	MY41003340	2023-07-06	Annual
DC Power Supply	PWR800L	KIKUSUI	RK000880	2023-07-27	Annual
AC Power Supply	PCR2000MA	KIKUSUI	ZL002530	2023-01-03	Annual
Temperature and Humidity Chamber	SU-642	ESPEC	93008124	2023-03-04	Annual
Amp & Filter Bank Switch Controller	FBSM-01B	TNM system	TM19050002	N/A	N/A
Controller(Antenna mast & Turn Table)	CO3000	Innco systems	CO3000-4p	N/A	N/A
Antenna Position Tower	MA4640/800-XP-ET	Innco systems	N/A	N/A	N/A
Turn Table	N/A	Audix	N/A	N/A	N/A
Controller	EM1000	Audix	060520	N/A	N/A
Loop Antenna	FMZB 1513	Schwarzbeck	1513-333	2024-03-17	Biennial
Hybrid Antenna	VULB 9168	Schwarzbeck	9168-0895	2024-08-16	Biennial
Horn Antenna	BBHA 9120D	Schwarzbeck	02296	2023-05-19	Biennial
Horn Antenna(15 GHz ~ 40 GHz)	BBHA9170	Schwarzbeck	BBHA9170124	2023-04-12	Biennial
Spectrum Analyzer	FSV	Rohde & Schwarz	101055	2023-05-16	Annual
HPF(7 ~ 18 GHz) + LNA2(6 ~ 18 GHz)	FBSR-05B	TNM system	28550	2023-01-19	Annual
Low Noise Amplifier	LLAU1183540Q	LTC Microwave	100	2023-08-23	Annual
Power Amplifier	CBL18265035	CERNEX	22966	2022-12-02	Annual
Power Amplifier	CBL26405040	CERNEX	25956	2023-03-11	Annual

\*This equipment has been used to each port, but we only listed one equipment for simplicity.

**Note:**

1. Equipment listed above that calibrated during the testing period was set for test after the calibration.
2. Equipment listed above that has a calibration due date during the testing period, the testing is completed before equipment expiration date, or will be tested after the calibration is completed.

## 5. TEST RESULT

### 5.1. RF OUTPUT POWER and PSD

#### Test Requirements:

#### § 2.1046 Measurements required: RF power output.

- (a) For transmitters other than single sideband, independent sideband and controlled carrier radiotelephone, power output shall be measured at the RF output terminals when the transmitter is adjusted in accordance with the tune-up procedure to give the values of current and voltage on the circuit elements specified in § 2.1033(c)(8). The electrical characteristics of the radio frequency load attached to the output terminals when this test is made shall be stated.
- (b) For single sideband, independent sideband, and single channel, controlled carrier radiotelephone transmitters the procedure specified in paragraph (a) of this section shall be employed and, in addition, the transmitter shall be modulated during the test as specified and applicable in § 2.1046 (b) (1-5). In all tests, the input level of the modulating signal shall be such as to develop rated peak envelope power or carrier power, as appropriate, for the transmitter.
- (c) For measurements conducted pursuant to paragraphs (a) and (b) of this section, all calculations and methods used by the applicant for determining carrier power or peak envelope power, as appropriate, on the basis of measured power in the radio frequency load attached to the transmitter output terminals shall be shown. Under the test conditions specified, no components of the emission spectrum shall exceed the limits specified in the applicable rule parts as necessary for meeting occupied bandwidth or emission limitations.

#### § 96.41 General radio requirements.

- (b) **Power limits.** Unless otherwise specified in this section, the maximum effective isotropic radiated power (EIRP) and maximum Power Spectral Density (PSD) of any CBSD and End User Device must comply with the limits shown in the table in this paragraph (b):

Device	Maximum EIRP (dBm/10megahertz)	Maximum PSD (dBm/MHz)
End User Device	23	n/a
Category A CBSD	30	20
Category B CBSD <sup>1</sup>	47	37

<sup>1</sup>Category B CBSDs will only be authorized for use after an ESC is approved and commercially deployed consistent with § § 96.15 and 96.67.

#### Test Procedures:

The measurement is performed in accordance with Section 5.2.4.4.1 of ANSI C63.26.

The EUT is considered to transmit continuously if it can be configured to transmit at a burst duty cycle of greater than or equal to 98% throughout the duration of the measurement. If this condition can be achieved, then the following procedure can be used to measure the average output power of the EUT.

- a) Set span to 2 × to 3 × the OBW.
- b) Set RBW = 1 % to 5 % of the OBW.

- c) Set  $VBW \geq 3 \times RBW$ .
- d) Set number of measurement points in sweep  $\geq 2 \times \text{span} / RBW$ .
- e) Sweep time:
  - 1) Set = auto-couple, or
  - 2) Set  $\geq [10 \times (\text{number of points in sweep}) \times (\text{transmission period})]$  for single sweep (automation-compatible) measurement. Transmission period is the on and off time of the transmitter.
- f) Detector = power averaging (rms).
- g) If the EUT can be configured to transmit continuously, then set the trigger to free run.
- h) If the EUT cannot be configured to transmit continuously, then use a sweep trigger with the level set to enable triggering only on full power bursts and configure the EUT to transmit at full power for the entire duration of each sweep. Verify that the sweep time is less than or equal to the transmission burst duration. Time gating can also be used under similar constraints (i.e., configured such that measurement data is collected only during active full-power transmissions).
- i) Trace average at least 100 traces in power averaging (rms) mode if sweep is set to auto-couple. To accurately determine the average power over multiple symbols, it can be necessary to increase the number of traces to be averaged above 100 or, if using a manually configured sweep time, increase the sweep time.
- j) Compute the power by integrating the spectrum across the OBW of the signal using the instrument's band or channel power measurement function, with the band/channel limits set equal to the OBW band edges. If the instrument does not have a band or channel power function, then sum the spectrum levels (in linear power units) at intervals equal to the RBW extending across the entire OBW of the spectrum.

The measurement is performed in accordance with Section 5.2.4.5 of ANSI C63.26.

Some regulatory requirements specify the RF output power limits in terms of maximum or average PSD, (i.e., the output power or unwanted emissions power limits are defined within a specified reference bandwidth).

When average PSD limits are specified, the same fundamental measurement condition applies as previously discussed (i.e., averaging is to be performed only over durations of active transmissions at maximum output power level). Thus, when performing this measurement, the EUT must either be configured to transmit continuously at full power while the compliance measurement is performed, or else the measurement instrumentation must be configured to acquire data only over durations when the EUT is actively transmitting at full power. In circumstances where neither of these conditions can be realized, then alternative procedures are provided for both constant duty cycle and non-constant duty cycle transmissions.

The PSD is measured following the same procedures described in 5.2.4.4 for measuring the total average power, but with the RBW set to the reference bandwidth specified by the applicable regulatory requirement, and by using the marker function to identify the maximum PSD instead of summing the power across the OBW. If the fundamental measurement condition cannot be realized, then one of the alternative procedures in 5.2.4.4.2 or 5.2.4.4.3 should be selected, based on whether the transmitter duty cycle is constant (variations  $\leq \pm 2\%$ ) or non-constant (variations  $> \pm 2\%$ ), respectively.

**Note:**

1. The EUT have multiple antennas transmitting correlated signals with the equal antenna gains and two outputs driving a cross-polarized antennas with  $N_{ant}=2$ .

Directional gain is to be computed as follows: Directional gain =  $G_{ant} + 10 \times \log(N_{ant})$  dBi

2. Worst E.I.R.P. Case Scenario gain antenna was selected to perform all RF testing that can get maximum power setting. And high gain antenna power setting will be reduced according to difference value of antenna gain declared by applicant.
3. Applied antenna gain and cable loss as below:

E.I.R.P (dBm/10 MHz)	Antenna gain (dBi)	Directional gain (dBi)	External Loss (dBi)	Applied Antenna gain (dBi)
35	8.1	11.1	0.1	11.0
34	9.6	12.6	0.6	12.0
33	10.2	13.2	0.2	13.0

4. The results of the Conducted output power and PSD test shown below the frequency measured values are very small and similar trend for each port, so we are attached only the worst case plot.

**Test Results:**  
**Tabular Data of RF output power**
**CBRS NR 10 MHz 1 Carrier**

Ant	Modulation	Channel	Frequency (MHz)	Measured Value (dBm)	Directional Gain (dBi)	E.I.R.P. (dBm)	Calculated (W)
0	QPSK	LOW	3 555.00	29.46	11.00	40.46	11.12
		MIDDLE	3 625.00	29.15	11.00	40.15	10.36
		HIGH	3 695.00	29.40	11.00	40.40	10.95
	16QAM	LOW	3 555.00	29.77	11.00	40.77	11.93
		MIDDLE	3 625.00	29.55	11.00	40.55	11.34
		HIGH	3 695.00	29.16	11.00	40.16	10.38
	64QAM	LOW	3 555.00	29.61	11.00	40.61	11.51
		MIDDLE	3 625.00	29.29	11.00	40.29	10.70
		HIGH	3 695.00	29.45	11.00	40.45	11.09
	256QAM	LOW	3 555.00	29.46	11.00	40.46	11.13
		MIDDLE	3 625.00	29.63	11.00	40.63	11.56
		HIGH	3 695.00	29.47	11.00	40.47	11.13
1	QPSK	LOW	3 555.00	29.53	11.00	40.53	11.30
		MIDDLE	3 625.00	29.13	11.00	40.13	10.29
		HIGH	3 695.00	29.43	11.00	40.43	11.03
	16QAM	LOW	3 555.00	29.86	11.00	40.86	12.19
		MIDDLE	3 625.00	29.55	11.00	40.55	11.34
		HIGH	3 695.00	29.05	11.00	40.05	10.13
	64QAM	LOW	3 555.00	29.62	11.00	40.62	11.54
		MIDDLE	3 625.00	29.11	11.00	40.11	10.27
		HIGH	3 695.00	29.44	11.00	40.44	11.06
	256QAM	LOW	3 555.00	29.42	11.00	40.42	11.02
		MIDDLE	3 625.00	29.58	11.00	40.58	11.43
		HIGH	3 695.00	29.36	11.00	40.36	10.87

Ant	Modulation	Channel	Frequency (MHz)	Measured Value (dBm)	Directional Gain (dBi)	E.I.R.P. (dBm)	Calculated (W)
2	QPSK	LOW	3 555.00	29.65	11.00	40.65	11.61
		MIDDLE	3 625.00	29.24	11.00	40.24	10.58
		HIGH	3 695.00	29.11	11.00	40.11	10.26
	16QAM	LOW	3 555.00	29.95	11.00	40.95	12.43
		MIDDLE	3 625.00	29.76	11.00	40.76	11.90
		HIGH	3 695.00	29.36	11.00	40.36	10.85
	64QAM	LOW	3 555.00	29.80	11.00	40.80	12.03
		MIDDLE	3 625.00	29.47	11.00	40.47	11.15
		HIGH	3 695.00	29.07	11.00	40.07	10.16
	256QAM	LOW	3 555.00	29.45	11.00	40.45	11.09
		MIDDLE	3 625.00	29.78	11.00	40.78	11.98
		HIGH	3 695.00	29.66	11.00	40.66	11.64
3	QPSK	LOW	3 555.00	29.38	11.00	40.38	10.91
		MIDDLE	3 625.00	29.08	11.00	40.08	10.19
		HIGH	3 695.00	29.42	11.00	40.42	11.01
	16QAM	LOW	3 555.00	29.62	11.00	40.62	11.54
		MIDDLE	3 625.00	29.48	11.00	40.48	11.18
		HIGH	3 695.00	29.08	11.00	40.08	10.19
	64QAM	LOW	3 555.00	29.44	11.00	40.44	11.07
		MIDDLE	3 625.00	29.12	11.00	40.12	10.29
		HIGH	3 695.00	29.40	11.00	40.40	10.98
	256QAM	LOW	3 555.00	29.89	11.00	40.89	12.28
		MIDDLE	3 625.00	29.50	11.00	40.50	11.23
		HIGH	3 695.00	29.37	11.00	40.37	10.88



**Sum Data of Port 0, Port 1, Port 2 and Port 3**

Frequency (MHz)	Total E.I.R.P.			
	QPSK	16QAM	64QAM	256QAM
	(W)			
3 555.00	44.94	48.09	46.14	45.52
3 625.00	41.42	45.75	42.40	46.20
3 695.00	43.26	41.54	43.29	44.52

Frequency (MHz)	E.I.R.P.				Limit
	QPSK	16QAM	64QAM	256QAM	
	(dBm/10 MHz)				
3 555.00	46.53	46.82	46.64	46.58	47.00
3 625.00	46.17	46.60	46.27	46.65	
3 695.00	46.36	46.18	46.36	46.49	

**CBRS NR 20 MHz 1 Carrier**

Ant	Modulation	Channel	Frequency (MHz)	Measured Value (dBm)	Directional Gain (dBi)	E.I.R.P. (dBm)	Calculated (W)
0	QPSK	LOW	3 560.00	32.79	11.00	43.79	23.93
		MIDDLE	3 625.00	32.52	11.00	43.52	22.50
		HIGH	3 690.00	32.29	11.00	43.29	21.33
	16QAM	LOW	3 560.00	32.32	11.00	43.32	21.49
		MIDDLE	3 625.00	32.05	11.00	43.05	20.17
		HIGH	3 690.00	32.86	11.00	43.86	24.33
	64QAM	LOW	3 560.00	32.70	11.00	43.70	23.42
		MIDDLE	3 625.00	32.42	11.00	43.42	21.96
		HIGH	3 690.00	32.12	11.00	43.12	20.49
	256QAM	LOW	3 560.00	32.33	11.00	43.33	21.55
		MIDDLE	3 625.00	32.12	11.00	43.12	20.49
		HIGH	3 690.00	32.86	11.00	43.86	24.30
1	QPSK	LOW	3 560.00	32.78	11.00	43.78	23.90
		MIDDLE	3 625.00	32.50	11.00	43.50	22.37
		HIGH	3 690.00	32.25	11.00	43.25	21.12
	16QAM	LOW	3 560.00	32.38	11.00	43.38	21.80
		MIDDLE	3 625.00	32.97	11.00	43.97	24.94
		HIGH	3 690.00	32.82	11.00	43.82	24.09
	64QAM	LOW	3 560.00	32.77	11.00	43.77	23.85
		MIDDLE	3 625.00	32.31	11.00	43.31	21.44
		HIGH	3 690.00	32.16	11.00	43.16	20.70
	256QAM	LOW	3 560.00	32.40	11.00	43.40	21.86
		MIDDLE	3 625.00	32.03	11.00	43.03	20.07
		HIGH	3 690.00	32.91	11.00	43.91	24.62

Ant	Modulation	Channel	Frequency (MHz)	Measured Value (dBm)	Directional Gain (dBi)	E.I.R.P. (dBm)	Calculated (W)
2	QPSK	LOW	3 560.00	32.84	11.00	43.84	24.22
		MIDDLE	3 625.00	32.69	11.00	43.69	23.41
		HIGH	3 690.00	32.49	11.00	43.49	22.31
	16QAM	LOW	3 560.00	32.45	11.00	43.45	22.13
		MIDDLE	3 625.00	32.26	11.00	43.26	21.16
		HIGH	3 690.00	32.04	11.00	43.04	20.14
	64QAM	LOW	3 560.00	32.80	11.00	43.80	24.01
		MIDDLE	3 625.00	32.60	11.00	43.60	22.90
		HIGH	3 690.00	32.37	11.00	43.37	21.73
	256QAM	LOW	3 560.00	32.47	11.00	43.47	22.22
		MIDDLE	3 625.00	32.23	11.00	43.23	21.02
		HIGH	3 690.00	32.03	11.00	43.03	20.09
3	QPSK	LOW	3 560.00	32.59	11.00	43.59	22.88
		MIDDLE	3 625.00	32.47	11.00	43.47	22.24
		HIGH	3 690.00	32.22	11.00	43.22	20.98
	16QAM	LOW	3 560.00	32.14	11.00	43.14	20.59
		MIDDLE	3 625.00	32.05	11.00	43.05	20.16
		HIGH	3 690.00	32.81	11.00	43.81	24.05
	64QAM	LOW	3 560.00	32.53	11.00	43.53	22.55
		MIDDLE	3 625.00	32.42	11.00	43.42	21.98
		HIGH	3 690.00	32.17	11.00	43.17	20.76
	256QAM	LOW	3 560.00	32.19	11.00	43.19	20.85
		MIDDLE	3 625.00	32.13	11.00	43.13	20.54
		HIGH	3 690.00	32.90	11.00	43.90	24.52

**Sum Data of Port 0, Port 1, Port 2 and Port 3**

Frequency (MHz)	Total E.I.R.P.			
	QPSK	16QAM	64QAM	256QAM
	(W)			
3 560.00	94.93	86.01	93.82	86.49
3 625.00	90.52	86.43	88.29	82.11
3 690.00	85.74	92.61	83.68	93.52

Frequency (MHz)	E.I.R.P.				Limit
	QPSK	16QAM	64QAM	256QAM	
	(dBm/10 MHz)				
3 560.00	46.76	46.34	46.71	46.36	47
3 625.00	46.56	46.36	46.45	46.13	
3 690.00	46.32	46.66	46.22	46.70	

**CBRS NR 30 MHz 1 Carrier**

Ant	Modulation	Channel	Frequency (MHz)	Measured Value (dBm)	Directional Gain (dBi)	E.I.R.P. (dBm)	Calculated (W)
0	QPSK	LOW	3 565.00	33.57	12.00	45.57	36.02
		MIDDLE	3 625.00	33.22	12.00	45.22	33.28
		HIGH	3 685.00	32.92	12.00	44.92	31.07
	16QAM	LOW	3 565.00	33.61	12.00	45.61	36.43
		MIDDLE	3 625.00	33.29	12.00	45.29	33.78
		HIGH	3 685.00	33.01	12.00	45.01	31.69
	64QAM	LOW	3 565.00	33.54	12.00	45.54	35.81
		MIDDLE	3 625.00	33.19	12.00	45.19	33.04
		HIGH	3 685.00	32.85	12.00	44.85	30.56
	256QAM	LOW	3 565.00	33.62	12.00	45.62	36.49
		MIDDLE	3 625.00	33.24	12.00	45.24	33.38
		HIGH	3 685.00	32.98	12.00	44.98	31.46
1	QPSK	LOW	3 565.00	33.39	12.00	45.39	34.63
		MIDDLE	3 625.00	33.13	12.00	45.13	32.55
		HIGH	3 685.00	32.86	12.00	44.86	30.61
	16QAM	LOW	3 565.00	33.56	12.00	45.56	35.99
		MIDDLE	3 625.00	33.15	12.00	45.15	32.76
		HIGH	3 685.00	32.91	12.00	44.91	31.00
	64QAM	LOW	3 565.00	33.42	12.00	45.42	34.87
		MIDDLE	3 625.00	33.08	12.00	45.08	32.20
		HIGH	3 685.00	32.88	12.00	44.88	30.76
	256QAM	LOW	3 565.00	33.56	12.00	45.56	36.02
		MIDDLE	3 625.00	33.11	12.00	45.11	32.45
		HIGH	3 685.00	32.94	12.00	44.94	31.18

Ant	Modulation	Channel	Frequency (MHz)	Measured Value (dBm)	Directional Gain (dBi)	E.I.R.P. (dBm)	Calculated (W)
2	QPSK	LOW	3 565.00	33.51	12.00	45.51	35.56
		MIDDLE	3 625.00	33.35	12.00	45.35	34.27
		HIGH	3 685.00	33.01	12.00	45.01	31.66
	16QAM	LOW	3 565.00	33.65	12.00	45.65	36.70
		MIDDLE	3 625.00	33.35	12.00	45.35	34.30
		HIGH	3 685.00	33.16	12.00	45.16	32.78
	64QAM	LOW	3 565.00	33.53	12.00	45.53	35.71
		MIDDLE	3 625.00	33.27	12.00	45.27	33.61
		HIGH	3 685.00	33.03	12.00	45.03	31.81
	256QAM	LOW	3 565.00	33.65	12.00	45.65	36.70
		MIDDLE	3 625.00	33.40	12.00	45.40	34.67
		HIGH	3 685.00	33.10	12.00	45.10	32.33
3	QPSK	LOW	3 565.00	33.25	12.00	45.25	33.47
		MIDDLE	3 625.00	33.12	12.00	45.12	32.55
		HIGH	3 685.00	32.81	12.00	44.81	30.30
	16QAM	LOW	3 565.00	33.34	12.00	45.34	34.18
		MIDDLE	3 625.00	33.18	12.00	45.18	32.95
		HIGH	3 685.00	32.88	12.00	44.88	30.79
	64QAM	LOW	3 565.00	33.22	12.00	45.22	33.27
		MIDDLE	3 625.00	33.10	12.00	45.10	32.38
		HIGH	3 685.00	32.85	12.00	44.85	30.56
	256QAM	LOW	3 565.00	33.34	12.00	45.34	34.21
		MIDDLE	3 625.00	33.14	12.00	45.14	32.67
		HIGH	3 685.00	32.82	12.00	44.82	30.31

**Sum Data of Port 0, Port 1, Port 2 and Port 3**

Frequency (MHz)	Total E.I.R.P.			
	QPSK	16QAM	64QAM	256QAM
	(W)			
3 565.00	139.69	143.30	139.66	143.43
3 625.00	132.65	133.79	131.24	133.17
3 685.00	123.64	126.25	123.68	125.29

Frequency (MHz)	E.I.R.P.				Limit
	QPSK	16QAM	64QAM	256QAM	
	(dBm/10 MHz)				
3 565.00	46.68	46.79	46.68	46.80	47
3 625.00	46.46	46.49	46.41	46.47	
3 685.00	46.15	46.24	46.15	46.21	

**CBRS NR 40 MHz 1 Carrier**

Ant	Modulation	Channel	Frequency (MHz)	Measured Value (dBm)	Directional Gain (dBi)	E.I.R.P. (dBm)	Calculated (W)
0	QPSK	LOW	3 570.00	34.25	12.00	46.25	42.19
		MIDDLE	3 625.00	34.21	12.00	46.21	41.77
		HIGH	3 680.00	34.13	12.00	46.13	40.99
	16QAM	LOW	3 570.00	34.71	12.00	46.71	46.89
		MIDDLE	3 625.00	34.62	12.00	46.62	45.94
		HIGH	3 680.00	34.57	12.00	46.57	45.38
	64QAM	LOW	3 570.00	34.70	12.00	46.70	46.82
		MIDDLE	3 625.00	34.46	12.00	46.46	44.28
		HIGH	3 680.00	34.20	12.00	46.20	41.73
	256QAM	LOW	3 570.00	34.65	12.00	46.65	46.18
		MIDDLE	3 625.00	34.64	12.00	46.64	46.17
		HIGH	3 680.00	34.39	12.00	46.39	43.52
1	QPSK	LOW	3 570.00	34.15	12.00	46.15	41.20
		MIDDLE	3 625.00	34.05	12.00	46.05	40.24
		HIGH	3 680.00	34.04	12.00	46.04	40.16
	16QAM	LOW	3 570.00	34.58	12.00	46.58	45.51
		MIDDLE	3 625.00	34.51	12.00	46.51	44.72
		HIGH	3 680.00	34.48	12.00	46.48	44.43
	64QAM	LOW	3 570.00	34.64	12.00	46.64	46.17
		MIDDLE	3 625.00	34.28	12.00	46.28	42.41
		HIGH	3 680.00	34.09	12.00	46.09	40.63
	256QAM	LOW	3 570.00	34.48	12.00	46.48	44.46
		MIDDLE	3 625.00	34.57	12.00	46.57	45.39
		HIGH	3 680.00	34.30	12.00	46.30	42.68



Ant	Modulation	Channel	Frequency (MHz)	Measured Value (dBm)	Directional Gain (dBi)	E.I.R.P. (dBm)	Calculated (W)
2	QPSK	LOW	3 570.00	34.39	12.00	46.39	43.50
		MIDDLE	3 625.00	34.33	12.00	46.33	42.95
		HIGH	3 680.00	34.24	12.00	46.24	42.08
	16QAM	LOW	3 570.00	34.72	12.00	46.72	47.02
		MIDDLE	3 625.00	34.75	12.00	46.75	47.34
		HIGH	3 680.00	34.55	12.00	46.55	45.15
	64QAM	LOW	3 570.00	34.75	12.00	46.75	47.28
		MIDDLE	3 625.00	34.61	12.00	46.61	45.80
		HIGH	3 680.00	34.24	12.00	46.24	42.10
	256QAM	LOW	3 570.00	34.54	12.00	46.54	45.09
		MIDDLE	3 625.00	34.75	12.00	46.75	47.33
		HIGH	3 680.00	34.45	12.00	46.45	44.20
3	QPSK	LOW	3 570.00	34.53	12.00	46.53	44.95
		MIDDLE	3 625.00	34.07	12.00	46.07	40.44
		HIGH	3 680.00	34.01	12.00	46.01	39.86
	16QAM	LOW	3 570.00	34.97	12.00	46.97	49.73
		MIDDLE	3 625.00	34.55	12.00	46.55	45.16
		HIGH	3 680.00	34.26	12.00	46.26	42.30
	64QAM	LOW	3 570.00	34.42	12.00	46.42	43.90
		MIDDLE	3 625.00	34.47	12.00	46.47	44.35
		HIGH	3 680.00	34.17	12.00	46.17	41.39
	256QAM	LOW	3 570.00	34.30	12.00	46.30	42.68
		MIDDLE	3 625.00	34.53	12.00	46.53	45.00
		HIGH	3 680.00	34.20	12.00	46.20	41.73

**Sum Data of Port 0, Port 1, Port 2 and Port 3**

Frequency (MHz)	Total E.I.R.P.			
	QPSK	16QAM	64QAM	256QAM
	(W)			
3 570.00	171.84	189.15	184.18	178.42
3 625.00	165.41	183.16	176.85	183.89
3 680.00	163.09	177.27	165.86	172.13

Frequency (MHz)	E.I.R.P.				Limit
	QPSK	16QAM	64QAM	256QAM	
	(dBm/10 MHz)				
3 570.00	46.33	46.75	46.63	46.49	47
3 625.00	46.17	46.61	46.46	46.63	
3 680.00	46.10	46.47	46.18	46.34	

**CBRS NR 60 MHz 1 Carrier**

Ant	Modulation	Channel	Frequency (MHz)	Measured Value (dBm)	Directional Gain (dBi)	E.I.R.P. (dBm)	Calculated (W)
0	QPSK	LOW	3 580.00	36.21	12.00	48.21	66.25
		MIDDLE	3 625.00	36.06	12.00	48.06	63.91
		HIGH	3 670.00	36.05	12.00	48.05	63.86
	16QAM	LOW	3 580.00	35.92	12.00	47.92	61.93
		MIDDLE	3 625.00	35.82	12.00	47.82	60.52
		HIGH	3 670.00	35.81	12.00	47.81	60.41
	64QAM	LOW	3 580.00	36.15	12.00	48.15	65.34
		MIDDLE	3 625.00	36.22	12.00	48.22	66.36
		HIGH	3 670.00	35.98	12.00	47.98	62.81
	256QAM	LOW	3 580.00	36.06	12.00	48.06	64.02
		MIDDLE	3 625.00	36.21	12.00	48.21	66.22
		HIGH	3 670.00	35.99	12.00	47.99	62.99
1	QPSK	LOW	3 580.00	36.25	12.00	48.25	66.90
		MIDDLE	3 625.00	35.94	12.00	47.94	62.20
		HIGH	3 670.00	36.03	12.00	48.03	63.50
	16QAM	LOW	3 580.00	35.88	12.00	47.88	61.42
		MIDDLE	3 625.00	35.80	12.00	47.80	60.30
		HIGH	3 670.00	35.85	12.00	47.85	60.98
	64QAM	LOW	3 580.00	36.19	12.00	48.19	65.98
		MIDDLE	3 625.00	36.13	12.00	48.13	65.07
		HIGH	3 670.00	35.89	12.00	47.89	61.53
	256QAM	LOW	3 580.00	35.98	12.00	47.98	62.79
		MIDDLE	3 625.00	36.12	12.00	48.12	64.80
		HIGH	3 670.00	35.92	12.00	47.92	61.90

Ant	Modulation	Channel	Frequency (MHz)	Measured Value (dBm)	Directional Gain (dBi)	E.I.R.P. (dBm)	Calculated (W)
2	QPSK	LOW	3 580.00	35.91	12.00	47.91	61.76
		MIDDLE	3 625.00	36.25	12.00	48.25	66.79
		HIGH	3 670.00	36.16	12.00	48.16	65.46
	16QAM	LOW	3 580.00	35.87	12.00	47.87	61.26
		MIDDLE	3 625.00	36.04	12.00	48.04	63.71
		HIGH	3 670.00	35.85	12.00	47.85	60.88
	64QAM	LOW	3 580.00	36.45	12.00	48.45	70.03
		MIDDLE	3 625.00	36.40	12.00	48.40	69.18
		HIGH	3 670.00	36.10	12.00	48.10	64.60
	256QAM	LOW	3 580.00	36.12	12.00	48.12	64.88
		MIDDLE	3 625.00	36.37	12.00	48.37	68.69
		HIGH	3 670.00	36.07	12.00	48.07	64.05
3	QPSK	LOW	3 580.00	35.92	12.00	47.92	61.93
		MIDDLE	3 625.00	36.14	12.00	48.14	65.10
		HIGH	3 670.00	36.03	12.00	48.03	63.46
	16QAM	LOW	3 580.00	36.02	12.00	48.02	63.34
		MIDDLE	3 625.00	35.90	12.00	47.90	61.63
		HIGH	3 670.00	35.91	12.00	47.91	61.80
	64QAM	LOW	3 580.00	36.36	12.00	48.36	68.56
		MIDDLE	3 625.00	36.26	12.00	48.26	66.96
		HIGH	3 670.00	36.19	12.00	48.19	65.96
	256QAM	LOW	3 580.00	36.13	12.00	48.13	64.98
		MIDDLE	3 625.00	36.22	12.00	48.22	66.44
		HIGH	3 670.00	36.19	12.00	48.19	65.96

**Sum Data of Port 0, Port 1, Port 2 and Port 3**

Frequency (MHz)	Total E.I.R.P.			
	QPSK	16QAM	64QAM	256QAM
	(W)			
3 580.00	256.84	247.95	269.92	256.67
3 625.00	258.01	246.16	267.57	266.15
3 670.00	256.28	244.08	254.90	254.91

Frequency (MHz)	E.I.R.P.				Limit
	QPSK	16QAM	64QAM	256QAM	
	(dBm/10 MHz)				
3 580.00	46.32	46.16	46.53	46.31	47
3 625.00	46.33	46.13	46.49	46.47	
3 670.00	46.31	46.09	46.28	46.28	

**CBRS NR 80 MHz 1 Carrier**

Ant	Modulation	Channel	Frequency (MHz)	Measured Value (dBm)	Directional Gain (dBi)	E.I.R.P. (dBm)	Calculated (W)
0	QPSK	LOW	3 590.00	36.31	13.00	49.31	85.29
		MIDDLE	3 625.00	36.35	13.00	49.35	86.16
		HIGH	3 660.00	36.28	13.00	49.28	84.78
	16QAM	LOW	3 590.00	36.36	13.00	49.36	86.22
		MIDDLE	3 625.00	36.31	13.00	49.31	85.33
		HIGH	3 660.00	36.32	13.00	49.32	85.55
	64QAM	LOW	3 590.00	36.42	13.00	49.42	87.54
		MIDDLE	3 625.00	36.32	13.00	49.32	85.57
		HIGH	3 660.00	36.25	13.00	49.25	84.04
	256QAM	LOW	3 590.00	36.45	13.00	49.45	88.04
		MIDDLE	3 625.00	36.35	13.00	49.35	86.20
		HIGH	3 660.00	36.25	13.00	49.25	84.14
1	QPSK	LOW	3 590.00	36.36	13.00	49.36	86.30
		MIDDLE	3 625.00	36.53	13.00	49.53	89.66
		HIGH	3 660.00	36.48	13.00	49.48	88.78
	16QAM	LOW	3 590.00	36.41	13.00	49.41	87.20
		MIDDLE	3 625.00	36.53	13.00	49.53	89.68
		HIGH	3 660.00	36.45	13.00	49.45	88.08
	64QAM	LOW	3 590.00	36.48	13.00	49.48	88.78
		MIDDLE	3 625.00	36.55	13.00	49.55	90.14
		HIGH	3 660.00	36.49	13.00	49.49	88.92
	256QAM	LOW	3 590.00	36.57	13.00	49.57	90.59
		MIDDLE	3 625.00	36.47	13.00	49.47	88.57
		HIGH	3 660.00	36.46	13.00	49.46	88.21

Ant	Modulation	Channel	Frequency (MHz)	Measured Value (dBm)	Directional Gain (dBi)	E.I.R.P. (dBm)	Calculated (W)
2	QPSK	LOW	3 590.00	36.43	13.00	49.43	87.70
		MIDDLE	3 625.00	36.31	13.00	49.31	85.33
		HIGH	3 660.00	36.14	13.00	49.14	82.00
	16QAM	LOW	3 590.00	36.44	13.00	49.44	87.88
		MIDDLE	3 625.00	36.29	13.00	49.29	84.86
		HIGH	3 660.00	36.15	13.00	49.15	82.21
	64QAM	LOW	3 590.00	36.52	13.00	49.52	89.56
		MIDDLE	3 625.00	36.25	13.00	49.25	84.16
		HIGH	3 660.00	36.47	13.00	49.47	88.57
	256QAM	LOW	3 590.00	36.51	13.00	49.51	89.27
		MIDDLE	3 625.00	36.21	13.00	49.21	83.35
		HIGH	3 660.00	36.17	13.00	49.17	82.55
3	QPSK	LOW	3 590.00	36.14	13.00	49.14	82.13
		MIDDLE	3 625.00	36.27	13.00	49.27	84.57
		HIGH	3 660.00	36.16	13.00	49.16	82.38
	16QAM	LOW	3 590.00	36.16	13.00	49.16	82.34
		MIDDLE	3 625.00	36.29	13.00	49.29	84.86
		HIGH	3 660.00	36.15	13.00	49.15	82.22
	64QAM	LOW	3 590.00	36.20	13.00	49.20	83.18
		MIDDLE	3 625.00	36.29	13.00	49.29	84.98
		HIGH	3 660.00	36.28	13.00	49.28	84.68
	256QAM	LOW	3 590.00	36.27	13.00	49.27	84.51
		MIDDLE	3 625.00	36.56	13.00	49.56	90.43
		HIGH	3 660.00	36.15	13.00	49.15	82.26

**Sum Data of Port 0, Port 1, Port 2 and Port 3**

Frequency (MHz)	Total E.I.R.P.			
	QPSK	16QAM	64QAM	256QAM
	(W)			
3 590.00	341.42	343.64	349.05	352.42
3 625.00	345.72	344.73	344.84	348.55
3 660.00	337.93	338.06	346.22	337.15

Frequency (MHz)	E.I.R.P.				Limit
	QPSK	16QAM	64QAM	256QAM	
	(dBm/10 MHz)				
3 590.00	46.30	46.33	46.40	46.44	47
3 625.00	46.36	46.34	46.35	46.39	
3 660.00	46.26	46.26	46.36	46.25	



**CBRS NR 100 MHz 1 Carrier**

Ant	Modulation	Channel	Frequency (MHz)	Measured Value (dBm)	Directional Gain (dBi)	E.I.R.P. (dBm)	Calculated (W)
0	QPSK	LOW	3 600.00	36.13	13.00	49.13	81.92
		MIDDLE	3 625.00	36.06	13.00	49.06	80.54
		HIGH	3 650.00	36.04	13.00	49.04	80.19
	16QAM	LOW	3 600.00	36.21	13.00	49.21	83.31
		MIDDLE	3 625.00	36.15	13.00	49.15	82.22
		HIGH	3 650.00	36.07	13.00	49.07	80.74
	64QAM	LOW	3 600.00	36.15	13.00	49.15	82.28
		MIDDLE	3 625.00	36.16	13.00	49.16	82.49
		HIGH	3 650.00	36.23	13.00	49.23	83.70
	256QAM	LOW	3 600.00	36.12	13.00	49.12	81.73
		MIDDLE	3 625.00	36.02	13.00	49.02	79.85
		HIGH	3 650.00	36.27	13.00	49.27	84.45
1	QPSK	LOW	3 600.00	36.21	13.00	49.21	83.43
		MIDDLE	3 625.00	36.20	13.00	49.20	83.25
		HIGH	3 650.00	36.04	13.00	49.04	80.15
	16QAM	LOW	3 600.00	36.30	13.00	49.30	85.15
		MIDDLE	3 625.00	36.25	13.00	49.25	84.18
		HIGH	3 650.00	36.08	13.00	49.08	80.85
	64QAM	LOW	3 600.00	36.29	13.00	49.29	84.90
		MIDDLE	3 625.00	36.25	13.00	49.25	84.06
		HIGH	3 650.00	36.26	13.00	49.26	84.39
	256QAM	LOW	3 600.00	36.26	13.00	49.26	84.33
		MIDDLE	3 625.00	36.06	13.00	49.06	80.56
		HIGH	3 650.00	36.32	13.00	49.32	85.43

Ant	Modulation	Channel	Frequency (MHz)	Measured Value (dBm)	Directional Gain (dBi)	E.I.R.P. (dBm)	Calculated (W)
2	QPSK	LOW	3 600.00	36.72	13.00	49.72	93.76
		MIDDLE	3 625.00	36.70	13.00	49.70	93.30
		HIGH	3 650.00	36.58	13.00	49.58	90.74
	16QAM	LOW	3 600.00	36.82	13.00	49.82	95.83
		MIDDLE	3 625.00	36.75	13.00	49.75	94.34
		HIGH	3 650.00	36.77	13.00	49.77	94.89
	64QAM	LOW	3 600.00	36.80	13.00	49.80	95.59
		MIDDLE	3 625.00	36.58	13.00	49.58	90.78
		HIGH	3 650.00	36.84	13.00	49.84	96.32
	256QAM	LOW	3 600.00	36.83	13.00	49.83	96.12
		MIDDLE	3 625.00	36.63	13.00	49.63	91.81
		HIGH	3 650.00	36.82	13.00	49.82	95.98
3	QPSK	LOW	3 600.00	36.58	13.00	49.58	90.76
		MIDDLE	3 625.00	36.64	13.00	49.64	92.04
		HIGH	3 650.00	36.36	13.00	49.36	86.38
	16QAM	LOW	3 600.00	36.72	13.00	49.72	93.67
		MIDDLE	3 625.00	36.66	13.00	49.66	92.38
		HIGH	3 650.00	36.63	13.00	49.63	91.88
	64QAM	LOW	3 600.00	36.74	13.00	49.74	94.19
		MIDDLE	3 625.00	36.55	13.00	49.55	90.20
		HIGH	3 650.00	36.65	13.00	49.65	92.21
	256QAM	LOW	3 600.00	36.71	13.00	49.71	93.48
		MIDDLE	3 625.00	36.54	13.00	49.54	89.93
		HIGH	3 650.00	36.69	13.00	49.69	93.09

**Sum Data of Port 0, Port 1, Port 2 and Port 3**

Frequency (MHz)	Total E.I.R.P.			
	QPSK	16QAM	64QAM	256QAM
	(W)			
3 600.00	349.86	357.96	356.96	355.66
3 625.00	349.14	353.13	347.53	342.15
3 650.00	337.45	348.36	356.62	358.95

Frequency (MHz)	E.I.R.P.				Limit
	QPSK	16QAM	64QAM	256QAM	
	(dBm/10 MHz)				
3 600.00	45.44	45.54	45.53	45.51	47
3 625.00	45.43	45.48	45.41	45.34	
3 650.00	45.28	45.42	45.52	45.55	

**CBRS LTE 5 MHz 1 Carrier**

Ant	Modulation	Channel	Frequency (MHz)	Measured Value (dBm)	Directional Gain (dBi)	E.I.R.P. (dBm)	Calculated (W)
0	QPSK	LOW	3 552.50	26.81	11.00	37.81	6.04
		MIDDLE	3 625.00	26.57	11.00	37.57	5.72
		HIGH	3 697.50	26.67	11.00	37.67	5.85
	16QAM	LOW	3 552.50	26.37	11.00	37.37	5.46
		MIDDLE	3 625.00	26.22	11.00	37.22	5.27
		HIGH	3 697.50	26.10	11.00	37.10	5.12
	64QAM	LOW	3 552.50	26.06	11.00	37.06	5.08
		MIDDLE	3 625.00	26.02	11.00	37.02	5.04
		HIGH	3 697.50	26.07	11.00	37.07	5.09
	256QAM	LOW	3 552.50	26.48	11.00	37.48	5.59
		MIDDLE	3 625.00	26.36	11.00	37.36	5.44
		HIGH	3 697.50	26.10	11.00	37.10	5.13
1	QPSK	LOW	3 552.50	26.90	11.00	37.90	6.17
		MIDDLE	3 625.00	26.54	11.00	37.54	5.68
		HIGH	3 697.50	26.44	11.00	37.44	5.55
	16QAM	LOW	3 552.50	26.58	11.00	37.58	5.73
		MIDDLE	3 625.00	26.28	11.00	37.28	5.34
		HIGH	3 697.50	26.03	11.00	37.03	5.05
	64QAM	LOW	3 552.50	26.16	11.00	37.16	5.20
		MIDDLE	3 625.00	26.06	11.00	37.06	5.08
		HIGH	3 697.50	26.07	11.00	37.07	5.09
	256QAM	LOW	3 552.50	26.63	11.00	37.63	5.79
		MIDDLE	3 625.00	26.29	11.00	37.29	5.36
		HIGH	3 697.50	26.10	11.00	37.10	5.12

Ant	Modulation	Channel	Frequency (MHz)	Measured Value (dBm)	Directional Gain (dBi)	E.I.R.P. (dBm)	Calculated (W)
2	QPSK	LOW	3 552.50	26.98	11.00	37.98	6.28
		MIDDLE	3 625.00	26.75	11.00	37.75	5.96
		HIGH	3 697.50	26.61	11.00	37.61	5.77
	16QAM	LOW	3 552.50	26.74	11.00	37.74	5.95
		MIDDLE	3 625.00	26.42	11.00	37.42	5.52
		HIGH	3 697.50	26.26	11.00	37.26	5.32
	64QAM	LOW	3 552.50	26.27	11.00	37.27	5.33
		MIDDLE	3 625.00	26.03	11.00	37.03	5.04
		HIGH	3 697.50	26.06	11.00	37.06	5.08
	256QAM	LOW	3 552.50	26.73	11.00	37.73	5.93
		MIDDLE	3 625.00	26.45	11.00	37.45	5.56
		HIGH	3 697.50	26.09	11.00	37.09	5.12
3	QPSK	LOW	3 552.50	26.86	11.00	37.86	6.12
		MIDDLE	3 625.00	26.61	11.00	37.61	5.77
		HIGH	3 697.50	26.53	11.00	37.53	5.67
	16QAM	LOW	3 552.50	26.48	11.00	37.48	5.60
		MIDDLE	3 625.00	26.34	11.00	37.34	5.42
		HIGH	3 697.50	26.03	11.00	37.03	5.05
	64QAM	LOW	3 552.50	26.06	11.00	37.06	5.08
		MIDDLE	3 625.00	26.08	11.00	37.08	5.11
		HIGH	3 697.50	26.09	11.00	37.09	5.12
	256QAM	LOW	3 552.50	26.50	11.00	37.50	5.63
		MIDDLE	3 625.00	26.44	11.00	37.44	5.55
		HIGH	3 697.50	26.04	11.00	37.04	5.06

**Sum Data of Port 0, Port 1, Port 2 and Port 3**

Frequency (MHz)	Total E.I.R.P.			
	QPSK	16QAM	64QAM	256QAM
	(W)			
3 552.50	24.61	22.74	20.69	22.95
3 625.00	23.13	21.56	20.27	21.91
3 697.50	22.84	20.54	20.38	20.44

Frequency (MHz)	E.I.R.P.				Limit
	QPSK	16QAM	64QAM	256QAM	
	(dBm/10 MHz)				
3 552.50	46.92	46.58	46.17	46.62	47
3 625.00	46.65	46.35	46.08	46.42	
3 697.50	46.60	46.14	46.10	46.11	

**CBRS LTE 10 MHz 1 Carrier**

Ant	Modulation	Channel	Frequency (MHz)	Measured Value (dBm)	Directional Gain (dBi)	E.I.R.P. (dBm)	Calculated (W)
0	QPSK	LOW	3 555.00	29.56	11.00	40.56	11.38
		MIDDLE	3 625.00	29.35	11.00	40.35	10.83
		HIGH	3 695.00	29.13	11.00	40.13	10.31
	16QAM	LOW	3 555.00	29.47	11.00	40.47	11.15
		MIDDLE	3 625.00	29.33	11.00	40.33	10.79
		HIGH	3 695.00	29.11	11.00	40.11	10.24
	64QAM	LOW	3 555.00	29.65	11.00	40.65	11.61
		MIDDLE	3 625.00	29.69	11.00	40.69	11.72
		HIGH	3 695.00	29.47	11.00	40.47	11.15
	256QAM	LOW	3 555.00	29.64	11.00	40.64	11.60
		MIDDLE	3 625.00	29.01	11.00	40.01	10.03
		HIGH	3 695.00	29.38	11.00	40.38	10.92
1	QPSK	LOW	3 555.00	29.43	11.00	40.43	11.04
		MIDDLE	3 625.00	29.18	11.00	40.18	10.42
		HIGH	3 695.00	29.17	11.00	40.17	10.40
	16QAM	LOW	3 555.00	29.66	11.00	40.66	11.65
		MIDDLE	3 625.00	29.32	11.00	40.32	10.77
		HIGH	3 695.00	29.06	11.00	40.06	10.15
	64QAM	LOW	3 555.00	29.69	11.00	40.69	11.72
		MIDDLE	3 625.00	29.56	11.00	40.56	11.37
		HIGH	3 695.00	29.60	11.00	40.60	11.48
	256QAM	LOW	3 555.00	29.49	11.00	40.49	11.20
		MIDDLE	3 625.00	29.12	11.00	40.12	10.29
		HIGH	3 695.00	29.32	11.00	40.32	10.75

Ant	Modulation	Channel	Frequency (MHz)	Measured Value (dBm)	Directional Gain (dBi)	E.I.R.P. (dBm)	Calculated (W)
2	QPSK	LOW	3 555.00	29.52	11.00	40.52	11.26
		MIDDLE	3 625.00	29.29	11.00	40.29	10.70
		HIGH	3 695.00	29.12	11.00	40.12	10.27
	16QAM	LOW	3 555.00	29.71	11.00	40.71	11.77
		MIDDLE	3 625.00	29.31	11.00	40.31	10.74
		HIGH	3 695.00	29.14	11.00	40.14	10.32
	64QAM	LOW	3 555.00	29.66	11.00	40.66	11.63
		MIDDLE	3 625.00	29.91	11.00	40.91	12.35
		HIGH	3 695.00	29.81	11.00	40.81	12.06
	256QAM	LOW	3 555.00	29.56	11.00	40.56	11.38
		MIDDLE	3 625.00	29.20	11.00	40.20	10.48
		HIGH	3 695.00	29.13	11.00	40.13	10.29
3	QPSK	LOW	3 555.00	29.37	11.00	40.37	10.89
		MIDDLE	3 625.00	29.11	11.00	40.11	10.25
		HIGH	3 695.00	29.14	11.00	40.14	10.34
	16QAM	LOW	3 555.00	29.40	11.00	40.40	10.97
		MIDDLE	3 625.00	29.23	11.00	40.23	10.55
		HIGH	3 695.00	29.07	11.00	40.07	10.16
	64QAM	LOW	3 555.00	29.89	11.00	40.89	12.29
		MIDDLE	3 625.00	29.68	11.00	40.68	11.69
		HIGH	3 695.00	29.79	11.00	40.79	12.01
	256QAM	LOW	3 555.00	29.18	11.00	40.18	10.43
		MIDDLE	3 625.00	29.19	11.00	40.19	10.44
		HIGH	3 695.00	29.08	11.00	40.08	10.19



**Sum Data of Port 0, Port 1, Port 2 and Port 3**

Frequency (MHz)	Total E.I.R.P.			
	QPSK	16QAM	64QAM	256QAM
	(W)			
3 555.00	44.58	45.55	47.25	44.62
3 625.00	42.19	42.86	47.13	41.25
3 695.00	41.32	40.87	46.70	42.16

Frequency (MHz)	E.I.R.P.				Limit
	QPSK	16QAM	64QAM	256QAM	
	(dBm/10 MHz)				
3 555.00	46.49	46.58	46.74	46.49	47
3 625.00	46.25	46.32	46.73	46.15	
3 695.00	46.16	46.11	46.69	46.25	

**CBRS LTE 15 MHz 1 Carrier**

Ant	Modulation	Channel	Frequency (MHz)	Measured Value (dBm)	Directional Gain (dBi)	E.I.R.P. (dBm)	Calculated (W)
0	QPSK	LOW	3 557.50	31.06	11.00	42.06	16.06
		MIDDLE	3 625.00	30.96	11.00	41.96	15.69
		HIGH	3 692.50	30.84	11.00	41.84	15.28
	16QAM	LOW	3 557.50	31.34	11.00	42.34	17.13
		MIDDLE	3 625.00	31.12	11.00	42.12	16.31
		HIGH	3 692.50	30.94	11.00	41.94	15.63
	64QAM	LOW	3 557.50	31.21	11.00	42.21	16.64
		MIDDLE	3 625.00	31.12	11.00	42.12	16.31
		HIGH	3 692.50	31.00	11.00	42.00	15.86
	256QAM	LOW	3 557.50	31.49	11.00	42.49	17.74
		MIDDLE	3 625.00	31.55	11.00	42.55	17.99
		HIGH	3 692.50	31.37	11.00	42.37	17.27
1	QPSK	LOW	3 557.50	31.13	11.00	42.13	16.34
		MIDDLE	3 625.00	30.93	11.00	41.93	15.60
		HIGH	3 692.50	31.05	11.00	42.05	16.04
	16QAM	LOW	3 557.50	31.40	11.00	42.40	17.37
		MIDDLE	3 625.00	31.17	11.00	42.17	16.50
		HIGH	3 692.50	30.85	11.00	41.85	15.31
	64QAM	LOW	3 557.50	31.28	11.00	42.28	16.90
		MIDDLE	3 625.00	31.07	11.00	42.07	16.10
		HIGH	3 692.50	30.83	11.00	41.83	15.22
	256QAM	LOW	3 557.50	31.56	11.00	42.56	18.05
		MIDDLE	3 625.00	31.43	11.00	42.43	17.49
		HIGH	3 692.50	31.15	11.00	42.15	16.41

Ant	Modulation	Channel	Frequency (MHz)	Measured Value (dBm)	Directional Gain (dBi)	E.I.R.P. (dBm)	Calculated (W)
2	QPSK	LOW	3 557.50	31.22	11.00	42.22	16.68
		MIDDLE	3 625.00	31.10	11.00	42.10	16.23
		HIGH	3 692.50	30.86	11.00	41.86	15.33
	16QAM	LOW	3 557.50	31.50	11.00	42.50	17.79
		MIDDLE	3 625.00	31.23	11.00	42.23	16.70
		HIGH	3 692.50	31.07	11.00	42.07	16.12
	64QAM	LOW	3 557.50	31.51	11.00	42.51	17.82
		MIDDLE	3 625.00	31.27	11.00	42.27	16.88
		HIGH	3 692.50	31.12	11.00	42.12	16.28
	256QAM	LOW	3 557.50	31.51	11.00	42.51	17.81
		MIDDLE	3 625.00	31.57	11.00	42.57	18.08
		HIGH	3 692.50	31.30	11.00	42.30	16.98
3	QPSK	LOW	3 557.50	31.24	11.00	42.24	16.74
		MIDDLE	3 625.00	31.14	11.00	42.14	16.38
		HIGH	3 692.50	30.85	11.00	41.85	15.30
	16QAM	LOW	3 557.50	31.25	11.00	42.25	16.78
		MIDDLE	3 625.00	31.10	11.00	42.10	16.21
		HIGH	3 692.50	31.02	11.00	42.02	15.93
	64QAM	LOW	3 557.50	31.43	11.00	42.43	17.49
		MIDDLE	3 625.00	31.37	11.00	42.37	17.24
		HIGH	3 692.50	31.00	11.00	42.00	15.85
	256QAM	LOW	3 557.50	31.75	11.00	42.75	18.83
		MIDDLE	3 625.00	31.67	11.00	42.67	18.49
		HIGH	3 692.50	31.22	11.00	42.22	16.68

**Sum Data of Port 0, Port 1, Port 2 and Port 3**

Frequency (MHz)	Total E.I.R.P.			
	QPSK	16QAM	64QAM	256QAM
	(W)			
3 557.50	65.82	69.07	68.85	72.44
3 625.00	63.89	65.72	66.53	72.06
3 692.50	61.96	62.99	63.21	67.35

Frequency (MHz)	E.I.R.P.				Limit
	QPSK	16QAM	64QAM	256QAM	
	(dBm/10 MHz)				
3 557.50	46.42	46.63	46.62	46.84	47
3 625.00	46.29	46.42	46.47	46.82	
3 692.50	46.16	46.23	46.25	46.52	

**CBRS LTE 20 MHz 1 Carrier**

Ant	Modulation	Channel	Frequency (MHz)	Measured Value (dBm)	Directional Gain (dBi)	E.I.R.P. (dBm)	Calculated (W)
0	QPSK	LOW	3 560.00	32.90	11.00	43.90	24.55
		MIDDLE	3 625.00	32.60	11.00	43.60	22.88
		HIGH	3 690.00	32.40	11.00	43.40	21.87
	16QAM	LOW	3 560.00	32.39	11.00	43.39	21.82
		MIDDLE	3 625.00	32.17	11.00	43.17	20.77
		HIGH	3 690.00	32.44	11.00	43.44	22.09
	64QAM	LOW	3 560.00	32.26	11.00	43.26	21.21
		MIDDLE	3 625.00	32.47	11.00	43.47	22.21
		HIGH	3 690.00	32.47	11.00	43.47	22.24
	256QAM	LOW	3 560.00	32.75	11.00	43.75	23.71
		MIDDLE	3 625.00	32.43	11.00	43.43	22.03
		HIGH	3 690.00	32.25	11.00	43.25	21.14
1	QPSK	LOW	3 560.00	32.86	11.00	43.86	24.33
		MIDDLE	3 625.00	32.53	11.00	43.53	22.56
		HIGH	3 690.00	32.28	11.00	43.28	21.30
	16QAM	LOW	3 560.00	32.54	11.00	43.54	22.58
		MIDDLE	3 625.00	32.16	11.00	43.16	20.71
		HIGH	3 690.00	32.04	11.00	43.04	20.15
	64QAM	LOW	3 560.00	32.24	11.00	43.24	21.09
		MIDDLE	3 625.00	32.42	11.00	43.42	21.99
		HIGH	3 690.00	32.40	11.00	43.40	21.86
	256QAM	LOW	3 560.00	32.71	11.00	43.71	23.48
		MIDDLE	3 625.00	32.35	11.00	43.35	21.61
		HIGH	3 690.00	32.04	11.00	43.04	20.12

Ant	Modulation	Channel	Frequency (MHz)	Measured Value (dBm)	Directional Gain (dBi)	E.I.R.P. (dBm)	Calculated (W)
2	QPSK	LOW	3 560.00	32.98	11.00	43.98	24.99
		MIDDLE	3 625.00	32.70	11.00	43.70	23.43
		HIGH	3 690.00	32.44	11.00	43.44	22.09
	16QAM	LOW	3 560.00	32.57	11.00	43.57	22.74
		MIDDLE	3 625.00	32.31	11.00	43.31	21.45
		HIGH	3 690.00	32.07	11.00	43.07	20.29
	64QAM	LOW	3 560.00	32.34	11.00	43.34	21.56
		MIDDLE	3 625.00	32.03	11.00	43.03	20.11
		HIGH	3 690.00	32.43	11.00	43.43	22.02
	256QAM	LOW	3 560.00	32.79	11.00	43.79	23.91
		MIDDLE	3 625.00	32.50	11.00	43.50	22.38
		HIGH	3 690.00	32.34	11.00	43.34	21.55
3	QPSK	LOW	3 560.00	32.93	11.00	43.93	24.70
		MIDDLE	3 625.00	32.71	11.00	43.71	23.50
		HIGH	3 690.00	32.39	11.00	43.39	21.81
	16QAM	LOW	3 560.00	32.38	11.00	43.38	21.78
		MIDDLE	3 625.00	32.22	11.00	43.22	21.00
		HIGH	3 690.00	32.46	11.00	43.46	22.20
	64QAM	LOW	3 560.00	32.31	11.00	43.31	21.45
		MIDDLE	3 625.00	32.04	11.00	43.04	20.13
		HIGH	3 690.00	32.46	11.00	43.46	22.20
	256QAM	LOW	3 560.00	32.81	11.00	43.81	24.02
		MIDDLE	3 625.00	32.50	11.00	43.50	22.40
		HIGH	3 690.00	32.33	11.00	43.33	21.51

**Sum Data of Port 0, Port 1, Port 2 and Port 3**

Frequency (MHz)	Total E.I.R.P.			
	QPSK	16QAM	64QAM	256QAM
	(W)			
3 560.00	98.57	88.91	85.31	95.12
3 625.00	92.37	83.92	84.45	88.43
3 690.00	87.07	84.72	88.33	84.33

Frequency (MHz)	E.I.R.P.				Limit
	QPSK	16QAM	64QAM	256QAM	
	(dBm/10 MHz)				
3 560.00	46.93	46.48	46.30	46.77	47
3 625.00	46.65	46.23	46.26	46.46	
3 690.00	46.39	46.27	46.45	46.25	

**Tabular Data of RF Contiguous output power**
**CBRS NR(60 MHz 1C + 30 MHz 1C)[2C]**

Ant	Modulation	Channel	Frequency (MHz)	Measured Value (dBm)	Directional Gain (dBi)	E.I.R.P. (dBm)	Calculated (W)
0	QPSK	LOW	3 595.00	36.07	13.00	49.07	80.76
		MIDDLE	3 625.00	36.00	13.00	49.00	79.47
		HIGH	3 655.00	36.06	13.00	49.06	80.59
	16QAM	LOW	3 595.00	36.08	13.00	49.08	80.85
		MIDDLE	3 625.00	36.02	13.00	49.02	79.74
		HIGH	3 655.00	36.00	13.00	49.00	79.45
	64QAM	LOW	3 595.00	36.06	13.00	49.06	80.50
		MIDDLE	3 625.00	36.14	13.00	49.14	82.00
		HIGH	3 655.00	36.06	13.00	49.06	80.57
	256QAM	LOW	3 595.00	36.09	13.00	49.09	81.08
		MIDDLE	3 625.00	36.02	13.00	49.02	79.80
		HIGH	3 655.00	36.01	13.00	49.01	79.65
1	QPSK	LOW	3 595.00	36.03	13.00	49.03	79.93
		MIDDLE	3 625.00	36.06	13.00	49.06	80.48
		HIGH	3 655.00	36.16	13.00	49.16	82.47
	16QAM	LOW	3 595.00	36.00	13.00	49.00	79.52
		MIDDLE	3 625.00	36.08	13.00	49.08	80.91
		HIGH	3 655.00	36.03	13.00	49.03	79.91
	64QAM	LOW	3 595.00	36.09	13.00	49.09	81.06
		MIDDLE	3 625.00	36.31	13.00	49.31	85.31
		HIGH	3 655.00	36.14	13.00	49.14	82.02
	256QAM	LOW	3 595.00	36.02	13.00	49.02	79.74
		MIDDLE	3 625.00	36.11	13.00	49.11	81.56
		HIGH	3 655.00	36.07	13.00	49.07	80.80



Ant	Modulation	Channel	Frequency (MHz)	Measured Value (dBm)	Directional Gain (dBi)	E.I.R.P. (dBm)	Calculated (W)
2	QPSK	LOW	3 595.00	36.07	13.00	49.07	80.76
		MIDDLE	3 625.00	36.08	13.00	49.08	80.98
		HIGH	3 655.00	36.00	13.00	49.00	79.49
	16QAM	LOW	3 595.00	36.05	13.00	49.05	80.32
		MIDDLE	3 625.00	36.08	13.00	49.08	80.87
		HIGH	3 655.00	36.08	13.00	49.08	81.00
	64QAM	LOW	3 595.00	36.05	13.00	49.05	80.39
		MIDDLE	3 625.00	36.15	13.00	49.15	82.13
		HIGH	3 655.00	36.02	13.00	49.02	79.84
	256QAM	LOW	3 595.00	36.02	13.00	49.02	79.82
		MIDDLE	3 625.00	36.09	13.00	49.09	81.15
		HIGH	3 655.00	36.01	13.00	49.01	79.62
3	QPSK	LOW	3 595.00	36.02	13.00	49.02	79.84
		MIDDLE	3 625.00	36.02	13.00	49.02	79.87
		HIGH	3 655.00	36.23	13.00	49.23	83.73
	16QAM	LOW	3 595.00	36.05	13.00	49.05	80.43
		MIDDLE	3 625.00	36.13	13.00	49.13	81.87
		HIGH	3 655.00	36.14	13.00	49.14	82.05
	64QAM	LOW	3 595.00	36.15	13.00	49.15	82.19
		MIDDLE	3 625.00	36.43	13.00	49.43	87.62
		HIGH	3 655.00	36.29	13.00	49.29	84.96
	256QAM	LOW	3 595.00	36.08	13.00	49.08	80.95
		MIDDLE	3 625.00	36.30	13.00	49.30	85.07
		HIGH	3 655.00	36.18	13.00	49.18	82.76

Note: 1C: 1 Carrier, 2C: 2 Carrier

**Sum Data of Port 0, Port 1, Port 2 and Port 3**

Frequency (MHz)	Total E.I.R.P.			
	QPSK	16QAM	64QAM	256QAM
	(W)			
3 595.00	321.29	321.12	324.14	321.59
3 625.00	320.81	323.39	337.06	327.59
3 655.00	326.29	322.42	327.38	322.82

Frequency (MHz)	E.I.R.P.				Limit
	QPSK	16QAM	64QAM	256QAM	
	(dBm/10 MHz)				
3 595.00	45.53	45.52	45.56	45.53	47
3 625.00	45.52	45.55	45.73	45.61	
3 655.00	45.59	45.54	45.61	45.55	

## CBRS LTE(15 MHz 1C + 15 MHz 1C)[2C]

Ant	Modulation	Channel	Frequency (MHz)	Measured Value (dBm)	Directional Gain (dBi)	E.I.R.P. (dBm)	Calculated (W)
0	QPSK	LOW	3 565.00	33.18	12.00	45.18	32.94
		MIDDLE	3 625.00	32.90	12.00	44.90	30.90
		HIGH	3 685.00	32.80	12.00	44.80	30.21
	16QAM	LOW	3 565.00	33.06	12.00	45.06	32.07
		MIDDLE	3 625.00	32.92	12.00	44.92	31.05
		HIGH	3 685.00	33.03	12.00	45.03	31.87
	64QAM	LOW	3 565.00	33.15	12.00	45.15	32.70
		MIDDLE	3 625.00	32.98	12.00	44.98	31.46
		HIGH	3 685.00	33.42	12.00	45.42	34.83
	256QAM	LOW	3 565.00	33.38	12.00	45.38	34.49
		MIDDLE	3 625.00	32.80	12.00	44.80	30.22
		HIGH	3 685.00	33.51	12.00	45.51	35.54
1	QPSK	LOW	3 565.00	32.90	12.00	44.90	30.87
		MIDDLE	3 625.00	32.98	12.00	44.98	31.51
		HIGH	3 685.00	32.91	12.00	44.91	30.94
	16QAM	LOW	3 565.00	33.13	12.00	45.13	32.55
		MIDDLE	3 625.00	32.91	12.00	44.91	30.95
		HIGH	3 685.00	32.83	12.00	44.83	30.41
	64QAM	LOW	3 565.00	32.98	12.00	44.98	31.49
		MIDDLE	3 625.00	32.80	12.00	44.80	30.22
		HIGH	3 685.00	33.43	12.00	45.43	34.93
	256QAM	LOW	3 565.00	33.29	12.00	45.29	33.80
		MIDDLE	3 625.00	32.94	12.00	44.94	31.22
		HIGH	3 685.00	33.48	12.00	45.48	35.32

Ant	Modulation	Channel	Frequency (MHz)	Measured Value (dBm)	Directional Gain (dBi)	E.I.R.P. (dBm)	Calculated (W)
2	QPSK	LOW	3 565.00	33.02	12.00	45.02	31.74
		MIDDLE	3 625.00	32.99	12.00	44.99	31.52
		HIGH	3 685.00	33.14	12.00	45.14	32.64
	16QAM	LOW	3 565.00	33.13	12.00	45.13	32.58
		MIDDLE	3 625.00	32.90	12.00	44.90	30.88
		HIGH	3 685.00	32.81	12.00	44.81	30.28
	64QAM	LOW	3 565.00	33.13	12.00	45.13	32.61
		MIDDLE	3 625.00	33.11	12.00	45.11	32.46
		HIGH	3 685.00	33.60	12.00	45.60	36.29
	256QAM	LOW	3 565.00	33.41	12.00	45.41	34.74
		MIDDLE	3 625.00	33.40	12.00	45.40	34.70
		HIGH	3 685.00	33.73	12.00	45.73	37.39
3	QPSK	LOW	3 565.00	33.02	12.00	45.02	31.78
		MIDDLE	3 625.00	32.81	12.00	44.81	30.26
		HIGH	3 685.00	33.07	12.00	45.07	32.17
	16QAM	LOW	3 565.00	32.99	12.00	44.99	31.57
		MIDDLE	3 625.00	32.89	12.00	44.89	30.85
		HIGH	3 685.00	33.02	12.00	45.02	31.73
	64QAM	LOW	3 565.00	33.16	12.00	45.16	32.84
		MIDDLE	3 625.00	32.83	12.00	44.83	30.40
		HIGH	3 685.00	33.19	12.00	45.19	33.02
	256QAM	LOW	3 565.00	33.44	12.00	45.44	35.00
		MIDDLE	3 625.00	33.03	12.00	45.03	31.83
		HIGH	3 685.00	33.35	12.00	45.35	34.26

Note: 1C: 1 Carrier, 2C: 2 Carrier

**Sum Data of Port 0, Port 1, Port 2 and Port 3**

Frequency (MHz)	Total E.I.R.P.			
	QPSK	16QAM	64QAM	256QAM
	(W)			
3 565.00	127.33	128.76	129.65	138.03
3 625.00	124.19	123.72	124.54	127.96
3 685.00	125.97	124.30	139.07	142.50

Frequency (MHz)	E.I.R.P.				Limit
	QPSK	16QAM	64QAM	256QAM	
	(dBm/10 MHz)				
3 565.00	46.28	46.33	46.36	46.63	47
3 625.00	46.17	46.15	46.18	46.30	
3 685.00	46.23	46.17	46.66	46.77	

**CBRS LTE 5 MHz 1C + NR 10 MHz 1C[2C]**

Ant	Modulation	Channel	Frequency (MHz)	Measured Value (dBm)	Directional Gain (dBi)	E.I.R.P. (dBm)	Calculated (W)
0	QPSK	LOW	3 557.50	30.41	11.00	41.41	13.82
		MIDDLE	3 625.00	30.26	11.00	41.26	13.37
		HIGH	3 692.50	30.24	11.00	41.24	13.32
	16QAM	LOW	3 557.50	30.26	11.00	41.26	13.38
		MIDDLE	3 625.00	30.13	11.00	41.13	12.96
		HIGH	3 692.50	30.05	11.00	41.05	12.73
	64QAM	LOW	3 557.50	30.16	11.00	41.16	13.05
		MIDDLE	3 625.00	30.13	11.00	41.13	12.97
		HIGH	3 692.50	29.89	11.00	40.89	12.28
	256QAM	LOW	3 557.50	30.28	11.00	41.28	13.44
		MIDDLE	3 625.00	30.18	11.00	41.18	13.11
		HIGH	3 692.50	30.09	11.00	41.09	12.87
1	QPSK	LOW	3 557.50	30.68	11.00	41.68	14.73
		MIDDLE	3 625.00	30.23	11.00	41.23	13.26
		HIGH	3 692.50	30.42	11.00	41.42	13.87
	16QAM	LOW	3 557.50	30.54	11.00	41.54	14.24
		MIDDLE	3 625.00	30.08	11.00	41.08	12.82
		HIGH	3 692.50	30.32	11.00	41.32	13.54
	64QAM	LOW	3 557.50	30.48	11.00	41.48	14.07
		MIDDLE	3 625.00	29.98	11.00	40.98	12.53
		HIGH	3 692.50	30.00	11.00	41.00	12.58
	256QAM	LOW	3 557.50	30.71	11.00	41.71	14.81
		MIDDLE	3 625.00	30.13	11.00	41.13	12.97
		HIGH	3 692.50	30.21	11.00	41.21	13.20

Ant	Modulation	Channel	Frequency (MHz)	Measured Value (dBm)	Directional Gain (dBi)	E.I.R.P. (dBm)	Calculated (W)
2	QPSK	LOW	3 557.50	30.51	11.00	41.51	14.15
		MIDDLE	3 625.00	30.04	11.00	41.04	12.70
		HIGH	3 692.50	30.28	11.00	41.28	13.43
	16QAM	LOW	3 557.50	30.29	11.00	41.29	13.45
		MIDDLE	3 625.00	29.88	11.00	40.88	12.24
		HIGH	3 692.50	30.10	11.00	41.10	12.89
	64QAM	LOW	3 557.50	30.25	11.00	41.25	13.35
		MIDDLE	3 625.00	29.93	11.00	40.93	12.40
		HIGH	3 692.50	29.92	11.00	40.92	12.37
	256QAM	LOW	3 557.50	30.42	11.00	41.42	13.86
		MIDDLE	3 625.00	29.86	11.00	40.86	12.19
		HIGH	3 692.50	30.10	11.00	41.10	12.89
3	QPSK	LOW	3 557.50	30.82	11.00	41.82	15.21
		MIDDLE	3 625.00	30.45	11.00	41.45	13.96
		HIGH	3 692.50	30.62	11.00	41.62	14.52
	16QAM	LOW	3 557.50	30.62	11.00	41.62	14.51
		MIDDLE	3 625.00	30.33	11.00	41.33	13.59
		HIGH	3 692.50	30.48	11.00	41.48	14.07
	64QAM	LOW	3 557.50	30.57	11.00	41.57	14.35
		MIDDLE	3 625.00	30.29	11.00	41.29	13.45
		HIGH	3 692.50	30.21	11.00	41.21	13.20
	256QAM	LOW	3 557.50	30.64	11.00	41.64	14.59
		MIDDLE	3 625.00	30.40	11.00	41.40	13.79
		HIGH	3 692.50	30.39	11.00	41.39	13.78

Note: 1C: 1 Carrier, 2C: 2 Carrier

**Sum Data of Port 0, Port 1, Port 2 and Port 3**

Frequency (MHz)	Total E.I.R.P.			
	QPSK	16QAM	64QAM	256QAM
	(W)			
3 557.50	57.92	55.58	54.82	56.70
3 625.00	53.29	51.61	51.34	52.07
3 692.50	55.14	53.23	50.44	52.74

Frequency (MHz)	E.I.R.P.				Limit
	QPSK	16QAM	64QAM	256QAM	
	(dBm/10 MHz)				
3 557.50	45.87	45.69	45.63	45.77	47
3 625.00	45.51	45.37	45.34	45.40	
3 692.50	45.65	45.50	45.27	45.46	



**CBRS NR(20 MHz 1C + 20 MHz 1C + 10 MHz 1C)[3C]**

Ant	Modulation	Channel	Frequency (MHz)	Measured Value (dBm)	Directional Gain (dBi)	E.I.R.P. (dBm)	Calculated (W)
0	QPSK	LOW	3 575.00	35.20	12.00	47.20	52.44
		MIDDLE	3 625.00	35.29	12.00	47.29	53.59
		HIGH	3 675.00	35.17	12.00	47.17	52.14
	16QAM	LOW	3 575.00	35.32	12.00	47.32	53.90
		MIDDLE	3 625.00	35.35	12.00	47.35	54.30
		HIGH	3 675.00	35.30	12.00	47.30	53.72
	64QAM	LOW	3 575.00	35.19	12.00	47.19	52.42
		MIDDLE	3 625.00	35.18	12.00	47.18	52.25
		HIGH	3 675.00	35.09	12.00	47.09	51.12
	256QAM	LOW	3 575.00	35.20	12.00	47.20	52.43
		MIDDLE	3 625.00	35.20	12.00	47.20	52.42
		HIGH	3 675.00	35.10	12.00	47.10	51.27
1	QPSK	LOW	3 575.00	35.43	12.00	47.43	55.34
		MIDDLE	3 625.00	35.32	12.00	47.32	53.90
		HIGH	3 675.00	35.33	12.00	47.33	54.04
	16QAM	LOW	3 575.00	35.51	12.00	47.51	56.39
		MIDDLE	3 625.00	35.30	12.00	47.30	53.69
		HIGH	3 675.00	35.43	12.00	47.43	55.30
	64QAM	LOW	3 575.00	35.32	12.00	47.32	54.01
		MIDDLE	3 625.00	35.23	12.00	47.23	52.82
		HIGH	3 675.00	35.26	12.00	47.26	53.17
	256QAM	LOW	3 575.00	35.34	12.00	47.34	54.23
		MIDDLE	3 625.00	35.24	12.00	47.24	52.94
		HIGH	3 675.00	35.26	12.00	47.26	53.17

Ant	Modulation	Channel	Frequency (MHz)	Measured Value (dBm)	Directional Gain (dBi)	E.I.R.P. (dBm)	Calculated (W)
2	QPSK	LOW	3 575.00	35.31	12.00	47.31	53.86
		MIDDLE	3 625.00	35.18	12.00	47.18	52.23
		HIGH	3 675.00	35.19	12.00	47.19	52.36
	16QAM	LOW	3 575.00	35.36	12.00	47.36	54.43
		MIDDLE	3 625.00	35.11	12.00	47.11	51.40
		HIGH	3 675.00	35.33	12.00	47.33	54.04
	64QAM	LOW	3 575.00	35.23	12.00	47.23	52.89
		MIDDLE	3 625.00	35.11	12.00	47.11	51.36
		HIGH	3 675.00	35.19	12.00	47.19	52.36
	256QAM	LOW	3 575.00	35.25	12.00	47.25	53.06
		MIDDLE	3 625.00	35.08	12.00	47.08	50.99
		HIGH	3 675.00	35.17	12.00	47.17	52.07
3	QPSK	LOW	3 575.00	35.55	12.00	47.55	56.94
		MIDDLE	3 625.00	35.54	12.00	47.54	56.77
		HIGH	3 675.00	35.44	12.00	47.44	55.50
	16QAM	LOW	3 575.00	35.70	12.00	47.70	58.88
		MIDDLE	3 625.00	35.43	12.00	47.43	55.39
		HIGH	3 675.00	35.63	12.00	47.63	58.00
	64QAM	LOW	3 575.00	35.57	12.00	47.57	57.08
		MIDDLE	3 625.00	35.40	12.00	47.40	54.89
		HIGH	3 675.00	35.43	12.00	47.43	55.28
	256QAM	LOW	3 575.00	35.50	12.00	47.50	56.30
		MIDDLE	3 625.00	35.39	12.00	47.39	54.80
		HIGH	3 675.00	35.42	12.00	47.42	55.26

Note: 1C: 1 Carrier, 3C: 3 Carrier

**Sum Data of Port 0, Port 1, Port 2 and Port 3**

Frequency (MHz)	Total E.I.R.P.			
	QPSK	16QAM	64QAM	256QAM
	(W)			
3 575.00	218.58	223.60	216.41	216.02
3 625.00	216.49	214.78	211.32	211.16
3 675.00	214.04	221.05	211.94	211.78

Frequency (MHz)	E.I.R.P.				Limit
	QPSK	16QAM	64QAM	256QAM	
	(dBm/10 MHz)				
3 575.00	46.41	46.51	46.36	46.36	47
3 625.00	46.36	46.33	46.26	46.26	
3 675.00	46.32	46.46	46.27	46.27	

**CBRS NR(30 MHz 1C + 30 MHz 1C + 10 MHz 1C)[3C]**

Ant	Modulation	Channel	Frequency (MHz)	Measured Value (dBm)	Directional Gain (dBi)	E.I.R.P. (dBm)	Calculated (W)
0	QPSK	LOW	3 585.00	35.68	13.00	48.68	73.77
		MIDDLE	3 625.00	35.58	13.00	48.58	72.16
		HIGH	3 665.00	35.61	13.00	48.61	72.63
	16QAM	LOW	3 585.00	35.62	13.00	48.62	72.71
		MIDDLE	3 625.00	35.61	13.00	48.61	72.59
		HIGH	3 665.00	35.67	13.00	48.67	73.69
	64QAM	LOW	3 585.00	35.64	13.00	48.64	73.13
		MIDDLE	3 625.00	35.70	13.00	48.70	74.11
		HIGH	3 665.00	35.71	13.00	48.71	74.32
	256QAM	LOW	3 585.00	35.57	13.00	48.57	71.90
		MIDDLE	3 625.00	35.63	13.00	48.63	72.93
		HIGH	3 665.00	35.60	13.00	48.60	72.39
1	QPSK	LOW	3 585.00	35.77	13.00	48.77	75.28
		MIDDLE	3 625.00	35.72	13.00	48.72	74.54
		HIGH	3 665.00	35.78	13.00	48.78	75.58
	16QAM	LOW	3 585.00	35.80	13.00	48.80	75.79
		MIDDLE	3 625.00	35.71	13.00	48.71	74.25
		HIGH	3 665.00	35.77	13.00	48.77	75.37
	64QAM	LOW	3 585.00	35.88	13.00	48.88	77.32
		MIDDLE	3 625.00	35.83	13.00	48.83	76.35
		HIGH	3 665.00	35.79	13.00	48.79	75.67
	256QAM	LOW	3 585.00	35.73	13.00	48.73	74.63
		MIDDLE	3 625.00	35.78	13.00	48.78	75.46
		HIGH	3 665.00	35.72	13.00	48.72	74.52

Ant	Modulation	Channel	Frequency (MHz)	Measured Value (dBm)	Directional Gain (dBi)	E.I.R.P. (dBm)	Calculated (W)
2	QPSK	LOW	3 585.00	35.68	13.00	48.68	73.74
		MIDDLE	3 625.00	35.55	13.00	48.55	71.66
		HIGH	3 665.00	35.67	13.00	48.67	73.67
	16QAM	LOW	3 585.00	35.59	13.00	48.59	72.28
		MIDDLE	3 625.00	35.58	13.00	48.58	72.11
		HIGH	3 665.00	35.65	13.00	48.65	73.28
	64QAM	LOW	3 585.00	35.68	13.00	48.68	73.88
		MIDDLE	3 625.00	35.62	13.00	48.62	72.73
		HIGH	3 665.00	35.71	13.00	48.71	74.35
	256QAM	LOW	3 585.00	35.57	13.00	48.57	71.99
		MIDDLE	3 625.00	35.56	13.00	48.56	71.73
		HIGH	3 665.00	35.60	13.00	48.60	72.44
3	QPSK	LOW	3 585.00	35.87	13.00	48.87	77.07
		MIDDLE	3 625.00	35.76	13.00	48.76	75.25
		HIGH	3 665.00	35.86	13.00	48.86	76.90
	16QAM	LOW	3 585.00	35.91	13.00	48.91	77.82
		MIDDLE	3 625.00	35.77	13.00	48.77	75.39
		HIGH	3 665.00	35.83	13.00	48.83	76.30
	64QAM	LOW	3 585.00	35.89	13.00	48.89	77.36
		MIDDLE	3 625.00	35.84	13.00	48.84	76.54
		HIGH	3 665.00	35.88	13.00	48.88	77.25
	256QAM	LOW	3 585.00	35.81	13.00	48.81	75.98
		MIDDLE	3 625.00	35.79	13.00	48.79	75.63
		HIGH	3 665.00	35.80	13.00	48.80	75.77

Note: 1C: 1 Carrier, 3C: 3 Carrier

**Sum Data of Port 0, Port 1, Port 2 and Port 3**

Frequency (MHz)	Total E.I.R.P.			
	QPSK	16QAM	64QAM	256QAM
	(W)			
3 585.00	299.87	298.60	301.68	294.50
3 625.00	293.62	294.34	299.73	295.75
3 665.00	298.77	298.64	301.59	295.13

Frequency (MHz)	E.I.R.P.				Limit
	QPSK	16QAM	64QAM	256QAM	
	(dBm/10 MHz)				
3 585.00	46.32	46.30	46.34	46.24	47
3 625.00	46.23	46.24	46.32	46.26	
3 665.00	46.30	46.30	46.34	46.25	

**CBRS LTE(15 MHz 1C + 15 MHz 1C + 10 MHz 1C)[3C]**

Ant	Modulation	Channel	Frequency (MHz)	Measured Value (dBm)	Directional Gain (dBi)	E.I.R.P. (dBm)	Calculated (W)
0	QPSK	LOW	3 570.00	34.25	12.00	46.25	42.16
		MIDDLE	3 625.00	34.24	12.00	46.24	42.08
		HIGH	3 680.00	34.28	12.00	46.28	42.50
	16QAM	LOW	3 570.00	34.30	12.00	46.30	42.62
		MIDDLE	3 625.00	34.07	12.00	46.07	40.46
		HIGH	3 680.00	34.27	12.00	46.27	42.37
	64QAM	LOW	3 570.00	34.21	12.00	46.21	41.74
		MIDDLE	3 625.00	34.28	12.00	46.28	42.48
		HIGH	3 680.00	34.33	12.00	46.33	42.94
	256QAM	LOW	3 570.00	34.13	12.00	46.13	41.02
		MIDDLE	3 625.00	34.23	12.00	46.23	41.97
		HIGH	3 680.00	34.23	12.00	46.23	42.02
1	QPSK	LOW	3 570.00	34.34	12.00	46.34	43.06
		MIDDLE	3 625.00	34.22	12.00	46.22	41.88
		HIGH	3 680.00	34.42	12.00	46.42	43.82
	16QAM	LOW	3 570.00	34.39	12.00	46.39	43.53
		MIDDLE	3 625.00	34.30	12.00	46.30	42.67
		HIGH	3 680.00	34.52	12.00	46.52	44.84
	64QAM	LOW	3 570.00	34.35	12.00	46.35	43.11
		MIDDLE	3 625.00	34.25	12.00	46.25	42.13
		HIGH	3 680.00	34.47	12.00	46.47	44.38
	256QAM	LOW	3 570.00	34.28	12.00	46.28	42.48
		MIDDLE	3 625.00	34.19	12.00	46.19	41.54
		HIGH	3 680.00	34.40	12.00	46.40	43.66

Ant	Modulation	Channel	Frequency (MHz)	Measured Value (dBm)	Directional Gain (dBi)	E.I.R.P. (dBm)	Calculated (W)
2	QPSK	LOW	3 570.00	34.30	12.00	46.30	42.68
		MIDDLE	3 625.00	34.13	12.00	46.13	41.06
		HIGH	3 680.00	34.32	12.00	46.32	42.81
	16QAM	LOW	3 570.00	34.23	12.00	46.23	42.00
		MIDDLE	3 625.00	34.08	12.00	46.08	40.52
		HIGH	3 680.00	34.32	12.00	46.32	42.87
	64QAM	LOW	3 570.00	34.30	12.00	46.30	42.68
		MIDDLE	3 625.00	34.11	12.00	46.11	40.84
		HIGH	3 680.00	34.34	12.00	46.34	43.07
	256QAM	LOW	3 570.00	34.19	12.00	46.19	41.61
		MIDDLE	3 625.00	34.10	12.00	46.10	40.77
		HIGH	3 680.00	34.31	12.00	46.31	42.75
3	QPSK	LOW	3 570.00	34.56	12.00	46.56	45.25
		MIDDLE	3 625.00	34.38	12.00	46.38	43.48
		HIGH	3 680.00	34.52	12.00	46.52	44.84
	16QAM	LOW	3 570.00	34.48	12.00	46.48	44.43
		MIDDLE	3 625.00	34.34	12.00	46.34	43.03
		HIGH	3 680.00	34.55	12.00	46.55	45.20
	64QAM	LOW	3 570.00	34.47	12.00	46.47	44.39
		MIDDLE	3 625.00	34.41	12.00	46.41	43.74
		HIGH	3 680.00	34.56	12.00	46.56	45.25
	256QAM	LOW	3 570.00	34.47	12.00	46.47	44.34
		MIDDLE	3 625.00	34.50	12.00	46.50	44.72
		HIGH	3 680.00	34.49	12.00	46.49	44.51

Note: 1C: 1 Carrier, 3C: 3 Carrier



**Sum Data of Port 0, Port 1, Port 2 and Port 3**

Frequency (MHz)	Total E.I.R.P.			
	QPSK	16QAM	64QAM	256QAM
	(W)			
3 570.00	173.15	172.59	171.93	169.45
3 625.00	168.50	166.68	169.20	169.00
3 680.00	173.97	175.29	175.65	172.95

Frequency (MHz)	E.I.R.P.				Limit
	QPSK	16QAM	64QAM	256QAM	
	(dBm/10 MHz)				
3 570.00	46.36	46.35	46.33	46.27	47
3 625.00	46.25	46.20	46.26	46.26	
3 680.00	46.38	46.42	46.43	46.36	

**CBRS LTE(20 MHz 1C + 15 MHz 1C + 15 MHz 1C)[3C]**

Ant	Modulation	Channel	Frequency (MHz)	Measured Value (dBm)	Directional Gain (dBi)	E.I.R.P. (dBm)	Calculated (W)
0	QPSK	LOW	3 575.00	35.05	12.00	47.05	50.72
		MIDDLE	3 625.00	35.07	12.00	47.07	50.98
		HIGH	3 675.00	35.07	12.00	47.07	50.97
	16QAM	LOW	3 575.00	35.08	12.00	47.08	51.03
		MIDDLE	3 625.00	35.07	12.00	47.07	50.89
		HIGH	3 675.00	35.07	12.00	47.07	50.99
	64QAM	LOW	3 575.00	35.01	12.00	47.01	50.28
		MIDDLE	3 625.00	35.12	12.00	47.12	51.51
		HIGH	3 675.00	35.17	12.00	47.17	52.08
	256QAM	LOW	3 575.00	35.00	12.00	47.00	50.15
		MIDDLE	3 625.00	35.18	12.00	47.18	52.24
		HIGH	3 675.00	35.25	12.00	47.25	53.13
1	QPSK	LOW	3 575.00	35.13	12.00	47.13	51.65
		MIDDLE	3 625.00	35.00	12.00	47.00	50.12
		HIGH	3 675.00	35.21	12.00	47.21	52.58
	16QAM	LOW	3 575.00	35.32	12.00	47.32	53.94
		MIDDLE	3 625.00	35.16	12.00	47.16	52.01
		HIGH	3 675.00	35.33	12.00	47.33	54.13
	64QAM	LOW	3 575.00	35.06	12.00	47.06	50.87
		MIDDLE	3 625.00	35.12	12.00	47.12	51.46
		HIGH	3 675.00	35.26	12.00	47.26	53.20
	256QAM	LOW	3 575.00	35.17	12.00	47.17	52.11
		MIDDLE	3 625.00	35.12	12.00	47.12	51.55
		HIGH	3 675.00	35.36	12.00	47.36	54.48

Ant	Modulation	Channel	Frequency (MHz)	Measured Value (dBm)	Directional Gain (dBi)	E.I.R.P. (dBm)	Calculated (W)
2	QPSK	LOW	3 575.00	35.04	12.00	47.04	50.57
		MIDDLE	3 625.00	35.09	12.00	47.09	51.16
		HIGH	3 675.00	35.03	12.00	47.03	50.44
	16QAM	LOW	3 575.00	35.12	12.00	47.12	51.46
		MIDDLE	3 625.00	35.09	12.00	47.09	51.23
		HIGH	3 675.00	35.02	12.00	47.02	50.40
	64QAM	LOW	3 575.00	35.26	12.00	47.26	53.19
		MIDDLE	3 625.00	35.07	12.00	47.07	50.91
		HIGH	3 675.00	35.11	12.00	47.11	51.42
	256QAM	LOW	3 575.00	35.19	12.00	47.19	52.30
		MIDDLE	3 625.00	35.05	12.00	47.05	50.65
		HIGH	3 675.00	35.26	12.00	47.26	53.17
3	QPSK	LOW	3 575.00	35.34	12.00	47.34	54.16
		MIDDLE	3 625.00	35.33	12.00	47.33	54.06
		HIGH	3 675.00	35.25	12.00	47.25	53.13
	16QAM	LOW	3 575.00	35.45	12.00	47.45	55.64
		MIDDLE	3 625.00	35.42	12.00	47.42	55.22
		HIGH	3 675.00	35.30	12.00	47.30	53.68
	64QAM	LOW	3 575.00	35.50	12.00	47.50	56.27
		MIDDLE	3 625.00	35.22	12.00	47.22	52.71
		HIGH	3 675.00	35.35	12.00	47.35	54.30
	256QAM	LOW	3 575.00	35.43	12.00	47.43	55.37
		MIDDLE	3 625.00	35.28	12.00	47.28	53.48
		HIGH	3 675.00	35.47	12.00	47.47	55.91

Note: 1C: 1 Carrier, 3C: 3 Carrier

**Sum Data of Port 0, Port 1, Port 2 and Port 3**

Frequency (MHz)	Total E.I.R.P.			
	QPSK	16QAM	64QAM	256QAM
	(W)			
3 575.00	207.11	212.07	210.61	209.93
3 625.00	206.32	209.35	206.60	207.92
3 675.00	207.11	209.19	211.00	216.69

Frequency (MHz)	E.I.R.P.				Limit
	QPSK	16QAM	64QAM	256QAM	
	(dBm/10 MHz)				
3 575.00	46.17	46.28	46.25	46.23	47
3 625.00	46.16	46.22	46.16	46.19	
3 675.00	46.17	46.22	46.25	46.37	

**CBRS LTE(20 MHz 1C + 20 MHz 1C + 20 MHz 1C)[3C]**

Ant	Modulation	Channel	Frequency (MHz)	Measured Value (dBm)	Directional Gain (dBi)	E.I.R.P. (dBm)	Calculated (W)
0	QPSK	LOW	3 580.00	35.99	12.00	47.99	63.02
		MIDDLE	3 625.00	35.87	12.00	47.87	61.26
		HIGH	3 670.00	35.84	12.00	47.84	60.86
	16QAM	LOW	3 580.00	36.01	12.00	48.01	63.20
		MIDDLE	3 625.00	35.89	12.00	47.89	61.50
		HIGH	3 670.00	35.88	12.00	47.88	61.33
	64QAM	LOW	3 580.00	35.86	12.00	47.86	61.14
		MIDDLE	3 625.00	35.80	12.00	47.80	60.28
		HIGH	3 670.00	35.83	12.00	47.83	60.69
	256QAM	LOW	3 580.00	35.89	12.00	47.89	61.52
		MIDDLE	3 625.00	35.89	12.00	47.89	61.49
		HIGH	3 670.00	35.82	12.00	47.82	60.60
1	QPSK	LOW	3 580.00	36.12	12.00	48.12	64.94
		MIDDLE	3 625.00	35.82	12.00	47.82	60.59
		HIGH	3 670.00	35.89	12.00	47.89	61.49
	16QAM	LOW	3 580.00	35.84	12.00	47.84	60.79
		MIDDLE	3 625.00	35.97	12.00	47.97	62.65
		HIGH	3 670.00	35.94	12.00	47.94	62.24
	64QAM	LOW	3 580.00	35.99	12.00	47.99	63.02
		MIDDLE	3 625.00	35.83	12.00	47.83	60.69
		HIGH	3 670.00	35.81	12.00	47.81	60.44
	256QAM	LOW	3 580.00	35.88	12.00	47.88	61.32
		MIDDLE	3 625.00	35.87	12.00	47.87	61.21
		HIGH	3 670.00	35.91	12.00	47.91	61.76

Ant	Modulation	Channel	Frequency (MHz)	Measured Value (dBm)	Directional Gain (dBi)	E.I.R.P. (dBm)	Calculated (W)
2	QPSK	LOW	3 580.00	36.25	12.00	48.25	66.82
		MIDDLE	3 625.00	35.91	12.00	47.91	61.82
		HIGH	3 670.00	35.89	12.00	47.89	61.49
	16QAM	LOW	3 580.00	35.91	12.00	47.91	61.79
		MIDDLE	3 625.00	35.84	12.00	47.84	60.80
		HIGH	3 670.00	35.89	12.00	47.89	61.48
	64QAM	LOW	3 580.00	36.03	12.00	48.03	63.53
		MIDDLE	3 625.00	35.80	12.00	47.80	60.30
		HIGH	3 670.00	35.83	12.00	47.83	60.73
	256QAM	LOW	3 580.00	35.96	12.00	47.96	62.47
		MIDDLE	3 625.00	35.87	12.00	47.87	61.26
		HIGH	3 670.00	35.96	12.00	47.96	62.52
3	QPSK	LOW	3 580.00	36.48	12.00	48.48	70.45
		MIDDLE	3 625.00	36.21	12.00	48.21	66.25
		HIGH	3 670.00	36.18	12.00	48.18	65.74
	16QAM	LOW	3 580.00	36.04	12.00	48.04	63.66
		MIDDLE	3 625.00	36.12	12.00	48.12	64.88
		HIGH	3 670.00	36.09	12.00	48.09	64.49
	64QAM	LOW	3 580.00	36.28	12.00	48.28	67.22
		MIDDLE	3 625.00	36.13	12.00	48.13	65.01
		HIGH	3 670.00	36.12	12.00	48.12	64.80
	256QAM	LOW	3 580.00	36.27	12.00	48.27	67.17
		MIDDLE	3 625.00	36.22	12.00	48.22	66.34
		HIGH	3 670.00	36.26	12.00	48.26	66.96

Note: 1C: 1 Carrier, 3C: 3 Carrier

**Sum Data of Port 0, Port 1, Port 2 and Port 3**

Frequency (MHz)	Total E.I.R.P.			
	QPSK	16QAM	64QAM	256QAM
	(W)			
3 580.00	265.23	249.44	254.91	252.49
3 625.00	249.92	249.83	246.28	250.30
3 670.00	249.57	249.54	246.66	251.84

Frequency (MHz)	E.I.R.P.				Limit
	QPSK	16QAM	64QAM	256QAM	
	(dBm/10 MHz)				
3 580.00	46.45	46.19	46.28	46.24	47
3 625.00	46.20	46.19	46.13	46.20	
3 670.00	46.19	46.19	46.14	46.23	

**CBRS LTE(20 MHz 1C + 20 MHz 1C + 20 MHz 1C + 20 MHz 1C)[4C]**

Ant	Modulation	Channel	Frequency (MHz)	Measured Value (dBm)	Directional Gain (dBi)	E.I.R.P. (dBm)	Calculated (W)
0	QPSK	LOW	3 590.00	36.26	13.00	49.26	84.28
		MIDDLE	3 625.00	36.25	13.00	49.25	84.10
		HIGH	3 660.00	36.28	13.00	49.28	84.76
	16QAM	LOW	3 590.00	36.23	13.00	49.23	83.79
		MIDDLE	3 625.00	36.14	13.00	49.14	82.11
		HIGH	3 660.00	36.14	13.00	49.14	82.05
	64QAM	LOW	3 590.00	36.28	13.00	49.28	84.72
		MIDDLE	3 625.00	36.34	13.00	49.34	85.92
		HIGH	3 660.00	36.30	13.00	49.30	85.11
	256QAM	LOW	3 590.00	36.23	13.00	49.23	83.70
		MIDDLE	3 625.00	36.20	13.00	49.20	83.25
		HIGH	3 660.00	36.19	13.00	49.19	82.91
1	QPSK	LOW	3 590.00	36.28	13.00	49.28	84.80
		MIDDLE	3 625.00	36.25	13.00	49.25	84.18
		HIGH	3 660.00	36.30	13.00	49.30	85.04
	16QAM	LOW	3 590.00	36.45	13.00	49.45	88.15
		MIDDLE	3 625.00	36.41	13.00	49.41	87.34
		HIGH	3 660.00	36.43	13.00	49.43	87.70
	64QAM	LOW	3 590.00	36.44	13.00	49.44	87.96
		MIDDLE	3 625.00	36.27	13.00	49.27	84.55
		HIGH	3 660.00	36.39	13.00	49.39	86.82
	256QAM	LOW	3 590.00	36.31	13.00	49.31	85.25
		MIDDLE	3 625.00	36.22	13.00	49.22	83.58
		HIGH	3 660.00	36.28	13.00	49.28	84.68



Ant	Modulation	Channel	Frequency (MHz)	Measured Value (dBm)	Directional Gain (dBi)	E.I.R.P. (dBm)	Calculated (W)
2	QPSK	LOW	3 590.00	36.14	13.00	49.14	81.94
		MIDDLE	3 625.00	36.07	13.00	49.07	80.67
		HIGH	3 660.00	36.21	13.00	49.21	83.31
	16QAM	LOW	3 590.00	36.39	13.00	49.39	86.90
		MIDDLE	3 625.00	36.13	13.00	49.13	81.79
		HIGH	3 660.00	36.08	13.00	49.08	80.98
	64QAM	LOW	3 590.00	36.18	13.00	49.18	82.72
		MIDDLE	3 625.00	36.14	13.00	49.14	81.96
		HIGH	3 660.00	36.19	13.00	49.19	82.95
	256QAM	LOW	3 590.00	36.25	13.00	49.25	84.06
		MIDDLE	3 625.00	36.17	13.00	49.17	82.68
		HIGH	3 660.00	36.15	13.00	49.15	82.24
3	QPSK	LOW	3 590.00	36.48	13.00	49.48	88.70
		MIDDLE	3 625.00	36.38	13.00	49.38	86.70
		HIGH	3 660.00	36.47	13.00	49.47	88.57
	16QAM	LOW	3 590.00	36.68	13.00	49.68	92.94
		MIDDLE	3 625.00	36.42	13.00	49.42	87.54
		HIGH	3 660.00	36.54	13.00	49.54	89.89
	64QAM	LOW	3 590.00	36.37	13.00	49.37	86.48
		MIDDLE	3 625.00	36.46	13.00	49.46	88.37
		HIGH	3 660.00	36.47	13.00	49.47	88.57
	256QAM	LOW	3 590.00	36.41	13.00	49.41	87.22
		MIDDLE	3 625.00	36.38	13.00	49.38	86.78
		HIGH	3 660.00	36.40	13.00	49.40	87.20

Note: 1C: 1 Carrier, 4C: 4 Carrier

**Sum Data of Port 0, Port 1, Port 2 and Port 3**

Frequency (MHz)	Total E.I.R.P.			
	QPSK	16QAM	64QAM	256QAM
	(W)			
3 590.00	339.71	351.77	341.88	340.23
3 625.00	335.64	338.78	340.80	336.29
3 660.00	341.68	340.63	343.45	337.03

Frequency (MHz)	E.I.R.P.				Limit
	QPSK	16QAM	64QAM	256QAM	
	(dBm/10 MHz)				
3 590.00	46.28	46.43	46.31	46.29	47
3 625.00	46.23	46.27	46.29	46.24	
3 660.00	46.31	46.29	46.33	46.25	

**CBRS LTE(15 MHz 1C + 15 MHz 1C + 15 MHz 1C + 15 MHz 1C + 10 MHz 1C)[5C]**

Ant	Modulation	Channel	Frequency (MHz)	Measured Value (dBm)	Directional Gain (dBi)	E.I.R.P. (dBm)	Calculated (W)
0	QPSK	LOW	3 585.00	35.68	13.00	48.68	73.71
		MIDDLE	3 625.00	35.61	13.00	48.61	72.56
		HIGH	3 665.00	35.56	13.00	48.56	71.73
	16QAM	LOW	3 585.00	35.59	13.00	48.59	72.28
		MIDDLE	3 625.00	35.55	13.00	48.55	71.60
		HIGH	3 665.00	35.54	13.00	48.54	71.50
	64QAM	LOW	3 585.00	35.66	13.00	48.66	73.54
		MIDDLE	3 625.00	35.61	13.00	48.61	72.61
		HIGH	3 665.00	35.60	13.00	48.60	72.39
	256QAM	LOW	3 585.00	35.55	13.00	48.55	71.65
		MIDDLE	3 625.00	35.66	13.00	48.66	73.54
		HIGH	3 665.00	35.67	13.00	48.67	73.59
1	QPSK	LOW	3 585.00	35.81	13.00	48.81	76.00
		MIDDLE	3 625.00	35.62	13.00	48.62	72.71
		HIGH	3 665.00	35.64	13.00	48.64	73.05
	16QAM	LOW	3 585.00	35.84	13.00	48.84	76.51
		MIDDLE	3 625.00	35.75	13.00	48.75	75.02
		HIGH	3 665.00	35.70	13.00	48.70	74.10
	64QAM	LOW	3 585.00	35.83	13.00	48.83	76.35
		MIDDLE	3 625.00	35.61	13.00	48.61	72.63
		HIGH	3 665.00	35.68	13.00	48.68	73.71
	256QAM	LOW	3 585.00	35.73	13.00	48.73	74.70
		MIDDLE	3 625.00	35.72	13.00	48.72	74.52
		HIGH	3 665.00	35.71	13.00	48.71	74.25

Ant	Modulation	Channel	Frequency (MHz)	Measured Value (dBm)	Directional Gain (dBi)	E.I.R.P. (dBm)	Calculated (W)
2	QPSK	LOW	3 585.00	35.63	13.00	48.63	72.96
		MIDDLE	3 625.00	35.54	13.00	48.54	71.50
		HIGH	3 665.00	35.51	13.00	48.51	70.96
	16QAM	LOW	3 585.00	35.67	13.00	48.67	73.57
		MIDDLE	3 625.00	35.52	13.00	48.52	71.12
		HIGH	3 665.00	35.55	13.00	48.55	71.61
	64QAM	LOW	3 585.00	35.65	13.00	48.65	73.23
		MIDDLE	3 625.00	35.54	13.00	48.54	71.42
		HIGH	3 665.00	35.54	13.00	48.54	71.52
	256QAM	LOW	3 585.00	35.71	13.00	48.71	74.27
		MIDDLE	3 625.00	35.53	13.00	48.53	71.22
		HIGH	3 665.00	35.57	13.00	48.57	72.01
3	QPSK	LOW	3 585.00	35.91	13.00	48.91	77.88
		MIDDLE	3 625.00	35.74	13.00	48.74	74.73
		HIGH	3 665.00	35.74	13.00	48.74	74.78
	16QAM	LOW	3 585.00	35.90	13.00	48.90	77.59
		MIDDLE	3 625.00	35.77	13.00	48.77	75.35
		HIGH	3 665.00	35.87	13.00	48.87	77.07
	64QAM	LOW	3 585.00	35.85	13.00	48.85	76.68
		MIDDLE	3 625.00	35.76	13.00	48.76	75.21
		HIGH	3 665.00	35.79	13.00	48.79	75.65
	256QAM	LOW	3 585.00	36.05	13.00	49.05	80.33
		MIDDLE	3 625.00	35.85	13.00	48.85	76.67
		HIGH	3 665.00	35.84	13.00	48.84	76.59

Note: 1C: 1 Carrier, 5C: 5 Carrier

**Sum Data of Port 0, Port 1, Port 2 and Port 3**

Frequency (MHz)	Total E.I.R.P.			
	QPSK	16QAM	64QAM	256QAM
	(W)			
3 585.00	300.54	299.94	299.80	300.95
3 625.00	291.50	293.10	291.87	295.95
3 665.00	290.52	294.28	293.26	296.44

Frequency (MHz)	E.I.R.P.				Limit
	QPSK	16QAM	64QAM	256QAM	
	(dBm/10 MHz)				
3 585.00	46.33	46.32	46.32	46.33	47
3 625.00	46.20	46.22	46.20	46.26	
3 665.00	46.18	46.24	46.22	46.27	

**CBRS LTE(20 MHz 1C + 20 MHz 1C + 20 MHz 1C + 20 MHz 1C + 10 MHz 1C)[5C]**

Ant	Modulation	Channel	Frequency (MHz)	Measured Value (dBm)	Directional Gain (dBi)	E.I.R.P. (dBm)	Calculated (W)
0	QPSK	LOW	3 595.00	36.06	13.00	49.06	80.50
		MIDDLE	3 625.00	36.19	13.00	49.19	83.02
		HIGH	3 655.00	36.29	13.00	49.29	84.98
	16QAM	LOW	3 595.00	36.14	13.00	49.14	82.09
		MIDDLE	3 625.00	36.03	13.00	49.03	80.08
		HIGH	3 655.00	36.09	13.00	49.09	81.13
	64QAM	LOW	3 595.00	36.30	13.00	49.30	85.13
		MIDDLE	3 625.00	36.31	13.00	49.31	85.37
		HIGH	3 655.00	36.31	13.00	49.31	85.31
	256QAM	LOW	3 595.00	36.32	13.00	49.32	85.51
		MIDDLE	3 625.00	36.26	13.00	49.26	84.41
		HIGH	3 655.00	36.27	13.00	49.27	84.61
1	QPSK	LOW	3 595.00	36.06	13.00	49.06	80.48
		MIDDLE	3 625.00	36.27	13.00	49.27	84.57
		HIGH	3 655.00	36.30	13.00	49.30	85.09
	16QAM	LOW	3 595.00	36.36	13.00	49.36	86.22
		MIDDLE	3 625.00	36.29	13.00	49.29	84.94
		HIGH	3 655.00	36.36	13.00	49.36	86.22
	64QAM	LOW	3 595.00	36.37	13.00	49.37	86.52
		MIDDLE	3 625.00	36.34	13.00	49.34	85.88
		HIGH	3 655.00	36.36	13.00	49.36	86.20
	256QAM	LOW	3 595.00	36.64	13.00	49.64	92.11
		MIDDLE	3 625.00	36.29	13.00	49.29	84.88
		HIGH	3 655.00	36.30	13.00	49.30	85.07

Ant	Modulation	Channel	Frequency (MHz)	Measured Value (dBm)	Directional Gain (dBi)	E.I.R.P. (dBm)	Calculated (W)
2	QPSK	LOW	3 595.00	36.00	13.00	49.00	79.49
		MIDDLE	3 625.00	36.09	13.00	49.09	81.04
		HIGH	3 655.00	36.13	13.00	49.13	81.85
	16QAM	LOW	3 595.00	36.15	13.00	49.15	82.21
		MIDDLE	3 625.00	36.02	13.00	49.02	79.78
		HIGH	3 655.00	36.14	13.00	49.14	82.11
	64QAM	LOW	3 595.00	36.20	13.00	49.20	83.20
		MIDDLE	3 625.00	36.18	13.00	49.18	82.70
		HIGH	3 655.00	36.19	13.00	49.19	82.95
	256QAM	LOW	3 595.00	36.51	13.00	49.51	89.27
		MIDDLE	3 625.00	36.11	13.00	49.11	81.45
		HIGH	3 655.00	36.15	13.00	49.15	82.28
3	QPSK	LOW	3 595.00	36.02	13.00	49.02	79.78
		MIDDLE	3 625.00	36.41	13.00	49.41	87.28
		HIGH	3 655.00	36.44	13.00	49.44	87.94
	16QAM	LOW	3 595.00	36.44	13.00	49.44	87.90
		MIDDLE	3 625.00	36.40	13.00	49.40	87.08
		HIGH	3 655.00	36.45	13.00	49.45	88.06
	64QAM	LOW	3 595.00	36.42	13.00	49.42	87.50
		MIDDLE	3 625.00	36.47	13.00	49.47	88.43
		HIGH	3 655.00	36.50	13.00	49.50	89.08
	256QAM	LOW	3 595.00	36.74	13.00	49.74	94.25
		MIDDLE	3 625.00	36.69	13.00	49.69	93.18
		HIGH	3 655.00	36.45	13.00	49.45	88.08

Note: 1C: 1 Carrier, 5C: 5 Carrier

**Sum Data of Port 0, Port 1, Port 2 and Port 3**

Frequency (MHz)	Total E.I.R.P.			
	QPSK	16QAM	64QAM	256QAM
	(W)			
3 595.00	320.25	338.42	342.34	361.14
3 625.00	335.91	331.87	342.38	343.92
3 655.00	339.86	337.53	343.54	340.05

Frequency (MHz)	E.I.R.P.				Limit
	QPSK	16QAM	64QAM	256QAM	
	(dBm/10 MHz)				
3 595.00	45.51	45.75	45.80	46.03	47
3 625.00	45.72	45.67	45.80	45.82	
3 655.00	45.77	45.74	45.82	45.77	



**CBRS LTE(20 MHz 1C + 20 MHz 1C + 20 MHz 1C + 20 MHz 1C + 20 MHz 1C)[5C]**

Ant	Modulation	Channel	Frequency (MHz)	Measured Value (dBm)	Directional Gain (dBi)	E.I.R.P. (dBm)	Calculated (W)
0	QPSK	LOW	3 600.00	36.64	13.00	49.64	92.02
		MIDDLE	3 625.00	36.39	13.00	49.39	86.96
		HIGH	3 650.00	36.16	13.00	49.16	82.43
	16QAM	LOW	3 600.00	36.08	13.00	49.08	81.00
		MIDDLE	3 625.00	36.13	13.00	49.13	81.77
		HIGH	3 650.00	36.02	13.00	49.02	79.78
	64QAM	LOW	3 600.00	36.43	13.00	49.43	87.66
		MIDDLE	3 625.00	36.22	13.00	49.22	83.50
		HIGH	3 650.00	36.36	13.00	49.36	86.20
	256QAM	LOW	3 600.00	36.47	13.00	49.47	88.45
		MIDDLE	3 625.00	36.28	13.00	49.28	84.74
		HIGH	3 650.00	36.40	13.00	49.40	87.20
1	QPSK	LOW	3 600.00	36.78	13.00	49.78	95.06
		MIDDLE	3 625.00	36.39	13.00	49.39	86.96
		HIGH	3 650.00	36.22	13.00	49.22	83.46
	16QAM	LOW	3 600.00	36.27	13.00	49.27	84.53
		MIDDLE	3 625.00	36.29	13.00	49.29	84.98
		HIGH	3 650.00	36.27	13.00	49.27	84.47
	64QAM	LOW	3 600.00	36.44	13.00	49.44	87.80
		MIDDLE	3 625.00	36.21	13.00	49.21	83.41
		HIGH	3 650.00	36.36	13.00	49.36	86.22
	256QAM	LOW	3 600.00	36.50	13.00	49.50	89.08
		MIDDLE	3 625.00	36.26	13.00	49.26	84.26
		HIGH	3 650.00	36.45	13.00	49.45	88.21

Ant	Modulation	Channel	Frequency (MHz)	Measured Value (dBm)	Directional Gain (dBi)	E.I.R.P. (dBm)	Calculated (W)
2	QPSK	LOW	3 600.00	36.10	13.00	49.10	81.38
		MIDDLE	3 625.00	36.18	13.00	49.18	82.87
		HIGH	3 650.00	36.09	13.00	49.09	81.11
	16QAM	LOW	3 600.00	36.28	13.00	49.28	84.76
		MIDDLE	3 625.00	36.10	13.00	49.10	81.38
		HIGH	3 650.00	36.10	13.00	49.10	81.30
	64QAM	LOW	3 600.00	36.26	13.00	49.26	84.31
		MIDDLE	3 625.00	36.08	13.00	49.08	80.87
		HIGH	3 650.00	36.22	13.00	49.22	83.52
	256QAM	LOW	3 600.00	36.35	13.00	49.35	86.16
		MIDDLE	3 625.00	36.16	13.00	49.16	82.39
		HIGH	3 650.00	36.26	13.00	49.26	84.43
3	QPSK	LOW	3 600.00	36.35	13.00	49.35	86.06
		MIDDLE	3 625.00	36.45	13.00	49.45	88.15
		HIGH	3 650.00	36.28	13.00	49.28	84.70
	16QAM	LOW	3 600.00	36.00	13.00	49.00	79.47
		MIDDLE	3 625.00	36.37	13.00	49.37	86.52
		HIGH	3 650.00	36.37	13.00	49.37	86.52
	64QAM	LOW	3 600.00	36.52	13.00	49.52	89.43
		MIDDLE	3 625.00	36.30	13.00	49.30	85.13
		HIGH	3 650.00	36.45	13.00	49.45	88.06
	256QAM	LOW	3 600.00	36.63	13.00	49.63	91.90
		MIDDLE	3 625.00	36.36	13.00	49.36	86.30
		HIGH	3 650.00	36.50	13.00	49.50	89.17

Note: 1C: 1 Carrier, 5C: 5 Carrier

**Sum Data of Port 0, Port 1, Port 2 and Port 3**

Frequency (MHz)	Total E.I.R.P.			
	QPSK	16QAM	64QAM	256QAM
	(W)			
3 600.00	354.52	329.76	349.21	355.59
3 625.00	344.93	334.64	332.91	337.69
3 650.00	331.71	332.07	344.00	349.00

Frequency (MHz)	E.I.R.P.				Limit
	QPSK	16QAM	64QAM	256QAM	
	(dBm/10 MHz)				
3 600.00	45.50	45.18	45.43	45.51	47
3 625.00	45.38	45.25	45.22	45.29	
3 650.00	45.21	45.21	45.37	45.43	

**CBRS NR 40 MHz 1C + NR 20 MHz 1C + NR 20 MHz 1C + LTE 10 MHz 1C + LTE 10 MHz 1C[5C]**

Ant	Modulation	Channel	Frequency (MHz)	Measured Value (dBm)	Directional Gain (dBi)	E.I.R.P. (dBm)	Calculated (W)
0	QPSK	LOW	3 600.00	36.18	13.00	49.18	82.74
		MIDDLE	3 625.00	36.29	13.00	49.29	84.94
		HIGH	3 650.00	36.08	13.00	49.08	80.87
	16QAM	LOW	3 600.00	36.17	13.00	49.17	82.58
		MIDDLE	3 625.00	36.15	13.00	49.15	82.17
		HIGH	3 650.00	36.11	13.00	49.11	81.38
	64QAM	LOW	3 600.00	36.05	13.00	49.05	80.33
		MIDDLE	3 625.00	36.33	13.00	49.33	85.68
		HIGH	3 650.00	36.39	13.00	49.39	86.82
	256QAM	LOW	3 600.00	36.32	13.00	49.32	85.49
		MIDDLE	3 625.00	36.26	13.00	49.26	84.31
		HIGH	3 650.00	36.33	13.00	49.33	85.66
1	QPSK	LOW	3 600.00	36.12	13.00	49.12	81.73
		MIDDLE	3 625.00	36.25	13.00	49.25	84.08
		HIGH	3 650.00	36.10	13.00	49.10	81.32
	16QAM	LOW	3 600.00	36.08	13.00	49.08	80.89
		MIDDLE	3 625.00	36.30	13.00	49.30	85.04
		HIGH	3 650.00	36.40	13.00	49.40	87.18
	64QAM	LOW	3 600.00	36.22	13.00	49.22	83.60
		MIDDLE	3 625.00	36.26	13.00	49.26	84.33
		HIGH	3 650.00	36.40	13.00	49.40	87.14
	256QAM	LOW	3 600.00	36.26	13.00	49.26	84.33
		MIDDLE	3 625.00	36.28	13.00	49.28	84.76
		HIGH	3 650.00	36.35	13.00	49.35	86.02

Ant	Modulation	Channel	Frequency (MHz)	Measured Value (dBm)	Directional Gain (dBi)	E.I.R.P. (dBm)	Calculated (W)
2	QPSK	LOW	3 600.00	36.11	13.00	49.11	81.47
		MIDDLE	3 625.00	36.05	13.00	49.05	80.26
		HIGH	3 650.00	36.42	13.00	49.42	87.42
	16QAM	LOW	3 600.00	36.13	13.00	49.13	81.88
		MIDDLE	3 625.00	36.10	13.00	49.10	81.30
		HIGH	3 650.00	36.17	13.00	49.17	82.62
	64QAM	LOW	3 600.00	36.18	13.00	49.18	82.76
		MIDDLE	3 625.00	36.12	13.00	49.12	81.75
		HIGH	3 650.00	36.24	13.00	49.24	84.00
	256QAM	LOW	3 600.00	36.16	13.00	49.16	82.38
		MIDDLE	3 625.00	36.07	13.00	49.07	80.80
		HIGH	3 650.00	36.15	13.00	49.15	82.15
3	QPSK	LOW	3 600.00	36.13	13.00	49.13	81.88
		MIDDLE	3 625.00	36.36	13.00	49.36	86.36
		HIGH	3 650.00	36.03	13.00	49.03	80.04
	16QAM	LOW	3 600.00	36.15	13.00	49.15	82.32
		MIDDLE	3 625.00	36.43	13.00	49.43	87.72
		HIGH	3 650.00	36.46	13.00	49.46	88.23
	64QAM	LOW	3 600.00	36.48	13.00	49.48	88.70
		MIDDLE	3 625.00	36.44	13.00	49.44	87.84
		HIGH	3 650.00	36.52	13.00	49.52	89.50
	256QAM	LOW	3 600.00	36.41	13.00	49.41	87.36
		MIDDLE	3 625.00	36.40	13.00	49.40	87.18
		HIGH	3 650.00	36.45	13.00	49.45	88.02

Note: 1C: 1 Carrier, 5C: 5 Carrier

**Sum Data of Port 0, Port 1, Port 2 and Port 3**

Frequency (MHz)	Total E.I.R.P.			
	QPSK	16QAM	64QAM	256QAM
	(W)			
3 600.00	327.83	327.68	335.38	339.55
3 625.00	335.64	336.22	339.61	337.05
3 650.00	329.65	339.40	347.45	341.86

Frequency (MHz)	E.I.R.P.				Limit
	QPSK	16QAM	64QAM	256QAM	
	(dBm/10 MHz)				
3 600.00	45.16	45.15	45.26	45.31	47
3 625.00	45.26	45.27	45.31	45.28	
3 650.00	45.18	45.31	45.41	45.34	

**CBRS NR 40 MHz 1C + NR 10 MHz 1C + LTE 20 MHz 1C + LTE 5 MHz 1C + LTE 5 MHz 1C[5C]**

Ant	Modulation	Channel	Frequency (MHz)	Measured Value (dBm)	Directional Gain (dBi)	E.I.R.P. (dBm)	Calculated (W)
0	QPSK	LOW	3 590.00	36.21	13.00	49.21	83.37
		MIDDLE	3 625.00	36.30	13.00	49.30	85.06
		HIGH	3 660.00	36.21	13.00	49.21	83.29
	16QAM	LOW	3 590.00	36.33	13.00	49.33	85.64
		MIDDLE	3 625.00	36.25	13.00	49.25	84.12
		HIGH	3 660.00	36.23	13.00	49.23	83.71
	64QAM	LOW	3 590.00	36.33	13.00	49.33	85.62
		MIDDLE	3 625.00	36.33	13.00	49.33	85.80
		HIGH	3 660.00	36.24	13.00	49.24	84.02
	256QAM	LOW	3 590.00	36.20	13.00	49.20	83.12
		MIDDLE	3 625.00	36.28	13.00	49.28	84.63
		HIGH	3 660.00	36.19	13.00	49.19	82.89
1	QPSK	LOW	3 590.00	36.25	13.00	49.25	84.14
		MIDDLE	3 625.00	36.20	13.00	49.20	83.16
		HIGH	3 660.00	36.19	13.00	49.19	82.97
	16QAM	LOW	3 590.00	36.45	13.00	49.45	88.19
		MIDDLE	3 625.00	36.47	13.00	49.47	88.53
		HIGH	3 660.00	36.42	13.00	49.42	87.48
	64QAM	LOW	3 590.00	36.30	13.00	49.30	85.09
		MIDDLE	3 625.00	36.32	13.00	49.32	85.53
		HIGH	3 660.00	36.28	13.00	49.28	84.74
	256QAM	LOW	3 590.00	36.21	13.00	49.21	83.41
		MIDDLE	3 625.00	36.27	13.00	49.27	84.51
		HIGH	3 660.00	36.22	13.00	49.22	83.54

Ant	Modulation	Channel	Frequency (MHz)	Measured Value (dBm)	Directional Gain (dBi)	E.I.R.P. (dBm)	Calculated (W)
2	QPSK	LOW	3 590.00	36.06	13.00	49.06	80.46
		MIDDLE	3 625.00	36.27	13.00	49.27	84.57
		HIGH	3 660.00	36.08	13.00	49.08	80.91
	16QAM	LOW	3 590.00	36.22	13.00	49.22	83.64
		MIDDLE	3 625.00	36.26	13.00	49.26	84.26
		HIGH	3 660.00	36.24	13.00	49.24	84.04
	64QAM	LOW	3 590.00	36.11	13.00	49.11	81.49
		MIDDLE	3 625.00	36.17	13.00	49.17	82.57
		HIGH	3 660.00	36.06	13.00	49.06	80.54
	256QAM	LOW	3 590.00	36.04	13.00	49.04	80.11
		MIDDLE	3 625.00	36.26	13.00	49.26	84.29
		HIGH	3 660.00	36.03	13.00	49.03	79.98
3	QPSK	LOW	3 590.00	36.31	13.00	49.31	85.29
		MIDDLE	3 625.00	36.31	13.00	49.31	85.23
		HIGH	3 660.00	36.28	13.00	49.28	84.76
	16QAM	LOW	3 590.00	36.53	13.00	49.53	89.78
		MIDDLE	3 625.00	36.50	13.00	49.50	89.04
		HIGH	3 660.00	36.49	13.00	49.49	88.92
	64QAM	LOW	3 590.00	36.41	13.00	49.41	87.24
		MIDDLE	3 625.00	36.40	13.00	49.40	87.18
		HIGH	3 660.00	36.31	13.00	49.31	85.27
	256QAM	LOW	3 590.00	36.31	13.00	49.31	85.21
		MIDDLE	3 625.00	36.26	13.00	49.26	84.29
		HIGH	3 660.00	36.22	13.00	49.22	83.60

Note: 1C: 1 Carrier, 5C: 5 Carrier



**Sum Data of Port 0, Port 1, Port 2 and Port 3**

Frequency (MHz)	Total E.I.R.P.			
	QPSK	16QAM	64QAM	256QAM
	(W)			
3 590.00	333.26	347.25	339.45	331.85
3 625.00	338.01	345.95	341.07	337.72
3 660.00	331.93	344.16	334.57	330.01

Frequency (MHz)	E.I.R.P.				Limit
	QPSK	16QAM	64QAM	256QAM	
	(dBm/10 MHz)				
3 590.00	45.23	45.41	45.31	45.21	47
3 625.00	45.29	45.39	45.33	45.29	
3 660.00	45.21	45.37	45.24	45.19	

**Tabular Data of RF Non-Contiguous output power**
**CBRS NR(60 MHz 1C + 30 MHz 1C)[2C]**

Ant.	Mod	NR 60 MHz		NR 30 MHz		Summation Value (dBm)	Directional Gain (dBi)	E.I.R.P. (dBm)	Calculated (W)
		Frequency (MHz)	Measured Value (dBm)	Frequency (MHz)	Measured Value (dBm)				
0	QPSK	3 580.00	34.65	3 685.00	31.73	36.44	13.00	49.44	87.92
	16QAM	3 580.00	34.30	3 685.00	31.26	36.05	13.00	49.05	80.35
	64QAM	3 580.00	34.63	3 685.00	31.23	36.26	13.00	49.26	84.41
	256QAM	3 685.00	34.33	3 685.00	31.53	36.16	13.00	49.16	82.49
1	QPSK	3 580.00	34.40	3 685.00	31.60	36.23	13.00	49.23	83.83
	16QAM	3 580.00	34.48	3 685.00	31.48	36.24	13.00	49.24	84.02
	64QAM	3 580.00	34.34	3 685.00	31.38	36.11	13.00	49.11	81.55
	256QAM	3 685.00	34.50	3 685.00	31.81	36.37	13.00	49.37	86.52
2	QPSK	3 580.00	34.53	3 685.00	31.80	36.39	13.00	49.39	86.82
	16QAM	3 580.00	34.26	3 685.00	31.22	36.01	13.00	49.01	79.67
	64QAM	3 715.00	34.32	3 715.00	31.28	36.07	13.00	49.07	80.74
	256QAM	3 685.00	34.35	3 685.00	31.61	36.20	13.00	49.20	83.21
3	QPSK	3 580.00	34.88	3 685.00	32.07	36.71	13.00	49.71	93.45
	16QAM	3 580.00	34.63	3 685.00	31.64	36.40	13.00	49.40	87.02
	64QAM	3 715.00	34.54	3 715.00	31.52	36.29	13.00	49.29	85.02
	256QAM	3 685.00	34.61	3 685.00	31.90	36.47	13.00	49.47	88.59

Note: 1C: 1 Carrier, 2C: 2 Carrier

**Sum Data of Port 0, Port 1, Port 2 and Port 3**

Frequency (MHz)	Total E.I.R.P.			
	QPSK	16QAM	64QAM	256QAM
	(W)			
3 580.00 + 3 685.00	352.02	331.06	331.71	340.81

Frequency (MHz)	E.I.R.P.				Limit
	QPSK	16QAM	64QAM	256QAM	
	(dBm/10 MHz)				
3 580.00 + 3 685.00	45.92	45.66	45.67	45.78	47

**CBRS LTE(15 MHz 1C + 15 MHz 1C)[2C]**

Ant.	Mod	LTE 15 MHz		LTE 15 MHz		Summation Value (dBm)	Directional Gain (dBi)	E.I.R.P. (dBm)	Calculated (W)
		Frequency (MHz)	Measured Value (dBm)	Frequency (MHz)	Measured Value (dBm)				
0	QPSK	3 557.50	29.98	3 692.50	30.52	33.27	12.00	45.27	33.64
	16QAM	3 557.50	30.04	3 692.50	29.86	32.96	12.00	44.96	31.36
	64QAM	3 557.50	30.19	3 692.50	30.24	33.22	12.00	45.22	33.30
	256QAM	3 557.50	30.46	3 692.50	29.82	33.16	12.00	45.16	32.83
1	QPSK	3 557.50	30.01	3 692.50	30.52	33.28	12.00	45.28	33.75
	16QAM	3 557.50	30.20	3 692.50	29.91	33.07	12.00	45.07	32.14
	64QAM	3 557.50	30.16	3 692.50	30.26	33.22	12.00	45.22	33.27
	256QAM	3 557.50	30.59	3 692.50	29.87	33.26	12.00	45.26	33.54
2	QPSK	3 557.50	30.48	3 692.50	30.72	33.61	12.00	45.61	36.40
	16QAM	3 557.50	30.41	3 692.50	29.78	33.11	12.00	45.11	32.46
	64QAM	3 557.50	30.80	3 692.50	30.62	33.72	12.00	45.72	37.31
	256QAM	3 557.50	30.40	3 692.50	29.88	33.16	12.00	45.16	32.79
3	QPSK	3 557.50	30.19	3 692.50	30.27	33.24	12.00	45.24	33.40
	16QAM	3 557.50	30.39	3 692.50	29.89	33.16	12.00	45.16	32.79
	64QAM	3 557.50	30.43	3 692.50	30.11	33.28	12.00	45.28	33.74
	256QAM	3 557.50	30.59	3 692.50	29.82	33.23	12.00	45.23	33.38

Note: 1C: 1 Carrier, 2C: 2 Carrier

**Sum Data of Port 0, Port 1, Port 2 and Port 3**

Frequency (MHz)	Total E.I.R.P.			
	QPSK	16QAM	64QAM	256QAM
	(W)			
3 557.50 + 3 692.50	137.20	128.76	137.61	132.54

Frequency (MHz)	E.I.R.P.				Limit
	QPSK	16QAM	64QAM	256QAM	
	(dBm/10 MHz)				
3 557.50 + 3 692.50	46.60	46.33	46.62	46.45	47

**CBRS LTE 5 MHz 1C + NR 10 MHz 1C[2C]**

Ant.	Mod	LTE 5 MHz		NR 10 MHz		Summation Value (dBm)	Directional Gain (dBi)	E.I.R.P. (dBm)	Calculated (W)
		Frequency (MHz)	Measured Value (dBm)	Frequency (MHz)	Measured Value (dBm)				
0	QPSK	3 552.50	25.53	3 695.00	28.17	30.06	11.00	41.06	12.77
	16QAM	3 552.50	25.58	3 695.00	28.16	30.07	11.00	41.07	12.79
	64QAM	3 552.50	25.42	3 695.00	28.41	30.18	11.00	41.18	13.12
	256QAM	3 552.50	25.04	3 695.00	28.32	29.99	11.00	40.99	12.57
1	QPSK	3 552.50	25.77	3 695.00	28.08	30.09	11.00	41.09	12.85
	16QAM	3 552.50	25.65	3 695.00	28.75	30.48	11.00	41.48	14.07
	64QAM	3 552.50	25.82	3 695.00	28.81	30.58	11.00	41.58	14.39
	256QAM	3 552.50	25.35	3 695.00	28.50	30.22	11.00	41.22	13.23
2	QPSK	3 552.50	25.62	3 695.00	28.01	29.99	11.00	40.99	12.56
	16QAM	3 552.50	25.47	3 695.00	28.55	30.29	11.00	41.29	13.45
	64QAM	3 552.50	25.54	3 695.00	28.56	30.32	11.00	41.32	13.54
	256QAM	3 552.50	25.15	3 695.00	28.37	30.06	11.00	41.06	12.76
3	QPSK	3 552.50	25.92	3 695.00	28.42	30.35	11.00	41.35	13.66
	16QAM	3 552.50	26.08	3 695.00	29.25	30.96	11.00	41.96	15.70
	64QAM	3 552.50	25.88	3 695.00	28.95	30.69	11.00	41.69	14.76
	256QAM	3 552.50	25.55	3 695.00	28.80	30.48	11.00	41.48	14.07

Note: 1C: 1 Carrier, 2C: 2 Carrier

**Sum Data of Port 0, Port 1, Port 2 and Port 3**

Frequency (MHz)	Total E.I.R.P.			
	QPSK	16QAM	64QAM	256QAM
	(W)			
3 552.50 + 3 695.00	51.83	56.01	55.80	52.63

Frequency (MHz)	E.I.R.P.				Limit
	QPSK	16QAM	64QAM	256QAM	
	(dBm/10 MHz)				
3 552.50 + 3 695.00	45.39	45.72	45.71	45.45	47

**CBRS NR[20 MHz 1C + (20 MHz 1C + 10 MHz 1C)][3C(1C+2C)]**

Ant.	Mod	NR 20 MHz		NR 20 MHz + NR 10 MHz		Summation Value (dBm)	Directional Gain (dBi)	E.I.R.P. (dBm)	Calculated (W)
		Frequency (MHz)	Measured Value (dBm)	Frequency (MHz)	Measured Value (dBm)				
0	QPSK	3 560.00	31.50	3 685.00	32.89	35.26	12.00	47.26	53.25
	16QAM	3 560.00	31.76	3 685.00	33.09	35.48	12.00	47.48	56.00
	64QAM	3 560.00	31.44	3 685.00	32.87	35.22	12.00	47.22	52.77
	256QAM	3 560.00	31.54	3 685.00	32.86	35.26	12.00	47.26	53.25
1	QPSK	3 560.00	31.82	3 685.00	33.14	35.54	12.00	47.54	56.78
	16QAM	3 560.00	32.04	3 685.00	33.31	35.73	12.00	47.73	59.32
	64QAM	3 560.00	31.75	3 685.00	33.04	35.45	12.00	47.45	55.62
	256QAM	3 560.00	31.87	3 685.00	33.02	35.49	12.00	47.49	56.16
2	QPSK	3 560.00	31.66	3 685.00	33.01	35.40	12.00	47.40	54.92
	16QAM	3 560.00	31.76	3 685.00	33.11	35.50	12.00	47.50	56.22
	64QAM	3 560.00	31.61	3 685.00	32.90	35.31	12.00	47.31	53.83
	256QAM	3 560.00	31.70	3 685.00	32.91	35.36	12.00	47.36	54.40
3	QPSK	3 560.00	31.96	3 685.00	33.27	35.67	12.00	47.67	58.55
	16QAM	3 560.00	32.02	3 685.00	33.36	35.75	12.00	47.75	59.58
	64QAM	3 560.00	31.80	3 685.00	33.13	35.53	12.00	47.53	56.58
	256QAM	3 560.00	31.97	3 685.00	33.18	35.63	12.00	47.63	57.92

Note: 1C: 1 Carrier, 2C: 2 Carrier, 3C: 3 Carrier

**Sum Data of Port 0, Port 1, Port 2 and Port 3**

Frequency (MHz)	Total E.I.R.P.			
	QPSK	16QAM	64QAM	256QAM
	(W)			
3 560.00 + 3 685.00	223.49	231.12	218.80	221.72

Frequency (MHz)	E.I.R.P.				Limit
	QPSK	16QAM	64QAM	256QAM	
	(dBm/10 MHz)				
3 560.00 + 3 685.00	46.50	46.65	46.41	46.47	47

**CBRS NR[(20 MHz 1C + 20 MHz 1C) + 10 MHz 1C][3C(2C+1C)]**

Ant.	Mod	NR 20 MHz + NR 20 MHz		NR 10 MHz		Summation Value (dBm)	Directional Gain (dBi)	E.I.R.P. (dBm)	Calculated (W)
		Frequency (MHz)	Measured Value (dBm)	Frequency (MHz)	Measured Value (dBm)				
0	QPSK	3 570.00	34.19	3 695.00	28.26	35.17	12.00	47.17	52.17
	16QAM	3 570.00	34.18	3 695.00	28.07	35.13	12.00	47.13	51.70
	64QAM	3 570.00	34.03	3 695.00	28.11	35.02	12.00	47.02	50.38
	256QAM	3 570.00	34.15	3 695.00	28.07	35.11	12.00	47.11	51.38
1	QPSK	3 570.00	34.36	3 695.00	28.36	35.33	12.00	47.33	54.14
	16QAM	3 570.00	34.40	3 695.00	28.26	35.34	12.00	47.34	54.25
	64QAM	3 570.00	34.19	3 695.00	28.32	35.19	12.00	47.19	52.35
	256QAM	3 570.00	34.35	3 695.00	28.23	35.30	12.00	47.30	53.73
2	QPSK	3 570.00	34.25	3 695.00	28.38	35.25	12.00	47.25	53.10
	16QAM	3 570.00	34.24	3 695.00	28.16	35.19	12.00	47.19	52.40
	64QAM	3 570.00	34.08	3 695.00	28.21	35.08	12.00	47.08	51.07
	256QAM	3 570.00	34.30	3 695.00	28.39	35.29	12.00	47.29	53.55
3	QPSK	3 570.00	34.52	3 695.00	28.64	35.52	12.00	47.52	56.43
	16QAM	3 570.00	34.47	3 695.00	28.38	35.43	12.00	47.43	55.34
	64QAM	3 570.00	34.36	3 695.00	28.53	35.37	12.00	47.37	54.58
	256QAM	3 570.00	34.67	3 695.00	28.90	35.69	12.00	47.69	58.74

Note: 1C: 1 Carrier, 2C: 2 Carrier, 3C: 3 Carrier

**Sum Data of Port 0, Port 1, Port 2 and Port 3**

Frequency (MHz)	Total E.I.R.P.			
	QPSK	16QAM	64QAM	256QAM
	(W)			
3 570.00 + 3 695.00	215.83	213.68	208.38	217.40

Frequency (MHz)	E.I.R.P.				Limit
	QPSK	16QAM	64QAM	256QAM	
	(dBm/10 MHz)				
3 570.00 + 3 695.00	46.35	46.31	46.20	46.38	47

**CBRS NR[30 MHz 1C + (30 MHz 1C + 10 MHz 1C)][3C(1C+2C)]**

Ant.	Mod	NR 30 MHz		NR 30 MHz + NR 10 MHz		Summation Value (dBm)	Directional Gain (dBi)	E.I.R.P. (dBm)	Calculated (W)
		Frequency (MHz)	Measured Value (dBm)	Frequency (MHz)	Measured Value (dBm)				
0	QPSK	3 565.00	34.93	3 680.00	27.29	35.62	13.00	49.00	79.34
	16QAM	3 565.00	34.85	3 680.00	27.19	35.54	13.00	48.72	74.44
	64QAM	3 565.00	34.90	3 680.00	27.27	35.59	13.00	48.80	75.91
	256QAM	3 565.00	34.90	3 680.00	26.99	35.55	13.00	48.84	76.61
1	QPSK	3 565.00	35.16	3 680.00	27.50	35.84	13.00	49.24	84.00
	16QAM	3 565.00	35.09	3 680.00	27.44	35.78	13.00	48.98	79.05
	64QAM	3 565.00	35.12	3 680.00	27.50	35.82	13.00	49.07	80.69
	256QAM	3 565.00	35.11	3 680.00	27.21	35.76	13.00	49.03	80.00
2	QPSK	3 565.00	35.11	3 680.00	27.45	35.80	13.00	49.10	81.32
	16QAM	3 565.00	34.98	3 680.00	27.37	35.67	13.00	48.77	75.40
	64QAM	3 565.00	35.02	3 680.00	27.46	35.72	13.00	48.97	78.89
	256QAM	3 565.00	34.98	3 680.00	27.12	35.64	13.00	48.91	77.84
3	QPSK	3 565.00	35.25	3 680.00	27.63	35.94	13.00	49.34	85.96
	16QAM	3 565.00	35.13	3 680.00	27.56	35.83	13.00	49.08	80.89
	64QAM	3 565.00	35.17	3 680.00	27.63	35.87	13.00	49.19	82.93
	256QAM	3 565.00	35.18	3 680.00	27.41	35.85	13.00	49.13	81.77

Note: 1C: 1 Carrier, 2C: 2 Carrier, 3C: 3 Carrier

**Sum Data of Port 0, Port 1, Port 2 and Port 3**

Frequency (MHz)	Total E.I.R.P.			
	QPSK	16QAM	64QAM	256QAM
	(W)			
3 565.00 + 3 680.00	330.63	309.78	318.41	316.23

Frequency (MHz)	E.I.R.P.				Limit
	QPSK	16QAM	64QAM	256QAM	
	(dBm/10 MHz)				
3 565.00 + 3 680.00	46.74	46.46	46.58	46.55	47

**CBRS NR[(30 MHz 1C + 30 MHz 1C) + 10 MHz 1C][3C(2C+1C)]**

Ant.	Mod	NR 30 MHz + NR 30 MHz		NR 10 MHz		Summation Value (dBm)	Directional Gain (dBi)	E.I.R.P. (dBm)	Calculated (W)
		Frequency (MHz)	Measured Value (dBm)	Frequency (MHz)	Measured Value (dBm)				
0	QPSK	3 580.00	34.93	3 695.00	27.29	35.62	13.00	48.62	72.86
	16QAM	3 580.00	34.85	3 695.00	27.19	35.54	13.00	48.54	71.42
	64QAM	3 580.00	34.90	3 695.00	27.27	35.59	13.00	48.59	72.24
	256QAM	3 580.00	34.90	3 695.00	26.99	35.55	13.00	48.55	71.66
1	QPSK	3 580.00	35.16	3 695.00	27.50	35.84	13.00	48.84	76.63
	16QAM	3 580.00	35.09	3 695.00	27.44	35.78	13.00	48.78	75.44
	64QAM	3 580.00	35.12	3 695.00	27.50	35.82	13.00	48.82	76.14
	256QAM	3 580.00	35.11	3 695.00	27.21	35.76	13.00	48.76	75.21
2	QPSK	3 580.00	35.11	3 695.00	27.45	35.80	13.00	48.80	75.86
	16QAM	3 580.00	34.98	3 695.00	27.37	35.67	13.00	48.67	73.71
	64QAM	3 580.00	35.02	3 695.00	27.46	35.72	13.00	48.72	74.56
	256QAM	3 580.00	34.98	3 695.00	27.12	35.64	13.00	48.64	73.11
3	QPSK	3 580.00	35.25	3 695.00	27.63	35.94	13.00	48.94	78.32
	16QAM	3 580.00	35.13	3 695.00	27.56	35.83	13.00	48.83	76.33
	64QAM	3 580.00	35.17	3 695.00	27.63	35.87	13.00	48.87	77.09
	256QAM	3 580.00	35.18	3 695.00	27.41	35.85	13.00	48.85	76.81

Note: 1C: 1 Carrier, 2C: 2 Carrier, 3C: 3 Carrier

**Sum Data of Port 0, Port 1, Port 2 and Port 3**

Frequency (MHz)	Total E.I.R.P.			
	QPSK	16QAM	64QAM	256QAM
	(W)			
3 580.00 + 3 695.00	303.67	296.89	300.03	296.80

Frequency (MHz)	E.I.R.P.				Limit
	QPSK	16QAM	64QAM	256QAM	
	(dBm/10 MHz)				
3 580.00 + 3 695.00	46.37	46.27	46.32	46.27	47



**CBRS LTE[15 MHz 1C + (15 MHz 1C + 10 MHz 1C)][3C(1C+2C)]**

Ant.	Mod	LTE 15 MHz		LTE 15 MHz + LTE 10 MHz		Summation Value (dBm)	Directional Gain (dBi)	E.I.R.P. (dBm)	Calculated (W)
		Frequency (MHz)	Measured Value (dBm)	Frequency (MHz)	Measured Value (dBm)				
0	QPSK	3 557.50	30.34	3 687.50	31.98	34.25	12.00	46.25	42.14
	16QAM	3 557.50	30.29	3 687.50	32.15	34.33	12.00	46.33	42.99
	64QAM	3 557.50	30.06	3 687.50	32.13	34.23	12.00	46.23	41.95
	256QAM	3 557.50	30.38	3 687.50	32.02	34.29	12.00	46.29	42.55
1	QPSK	3 557.50	30.52	3 687.50	32.19	34.44	12.00	46.44	44.11
	16QAM	3 557.50	30.49	3 687.50	32.44	34.59	12.00	46.59	45.55
	64QAM	3 557.50	30.30	3 687.50	32.33	34.44	12.00	46.44	44.07
	256QAM	3 557.50	30.63	3 687.50	32.30	34.56	12.00	46.56	45.24
2	QPSK	3 557.50	30.51	3 687.50	32.16	34.42	12.00	46.42	43.88
	16QAM	3 557.50	30.32	3 687.50	32.21	34.38	12.00	46.38	43.43
	64QAM	3 557.50	30.19	3 687.50	32.25	34.35	12.00	46.35	43.17
	256QAM	3 557.50	30.59	3 687.50	32.28	34.52	12.00	46.52	44.93
3	QPSK	3 557.50	30.74	3 687.50	32.41	34.66	12.00	46.66	46.38
	16QAM	3 557.50	30.57	3 687.50	32.47	34.63	12.00	46.63	46.02
	64QAM	3 557.50	30.43	3 687.50	32.53	34.61	12.00	46.61	45.86
	256QAM	3 557.50	30.79	3 687.50	32.50	34.74	12.00	46.74	47.16

Note: 1C: 1 Carrier, 2C: 2 Carrier, 3C: 3 Carrier

**Sum Data of Port 0, Port 1, Port 2 and Port 3**

Frequency (MHz)	Total E.I.R.P.			
	QPSK	16QAM	64QAM	256QAM
	(W)			
3 557.50 + 3 687.50	176.51	177.99	175.04	179.88

Frequency (MHz)	E.I.R.P.				Limit
	QPSK	16QAM	64QAM	256QAM	
	(dBm/10 MHz)				
3 557.50 + 3 687.50	46.45	46.48	46.41	46.53	47

**CBRS LTE[(15 MHz 1C + 15 MHz 1C) + 10 MHz 1C][3C(2C+1C)]**

Ant.	Mod	LTE 15 MHz + LTE 15 MHz		LTE 10 MHz		Summation Value (dBm)	Directional Gain (dBi)	E.I.R.P. (dBm)	Calculated (W)
		Frequency (MHz)	Measured Value (dBm)	Frequency (MHz)	Measured Value (dBm)				
0	QPSK	3 565.00	33.05	3 695.00	28.24	34.29	12.00	46.29	42.54
	16QAM	3 565.00	33.31	3 695.00	28.30	34.50	12.00	46.50	44.69
	64QAM	3 565.00	33.18	3 695.00	28.09	34.36	12.00	46.36	43.20
	256QAM	3 565.00	33.16	3 695.00	28.29	34.38	12.00	46.38	43.47
1	QPSK	3 565.00	33.16	3 695.00	28.38	34.41	12.00	46.41	43.72
	16QAM	3 565.00	33.45	3 695.00	28.45	34.64	12.00	46.64	46.17
	64QAM	3 565.00	33.28	3 695.00	28.14	34.44	12.00	46.44	44.03
	256QAM	3 565.00	33.29	3 695.00	28.40	34.51	12.00	46.51	44.78
2	QPSK	3 565.00	33.11	3 695.00	28.35	34.36	12.00	46.36	43.27
	16QAM	3 565.00	33.27	3 695.00	28.24	34.46	12.00	46.46	44.24
	64QAM	3 565.00	33.25	3 695.00	28.17	34.42	12.00	46.42	43.88
	256QAM	3 565.00	33.26	3 695.00	28.44	34.50	12.00	46.50	44.66
3	QPSK	3 565.00	33.35	3 695.00	28.62	34.61	12.00	46.61	45.79
	16QAM	3 565.00	33.54	3 695.00	28.58	34.74	12.00	46.74	47.26
	64QAM	3 565.00	33.51	3 695.00	28.43	34.69	12.00	46.69	46.61
	256QAM	3 565.00	33.41	3 695.00	28.63	34.66	12.00	46.66	46.33

Note: 1C: 1 Carrier, 2C: 2 Carrier, 3C: 3 Carrier

**Sum Data of Port 0, Port 1, Port 2 and Port 3**

Frequency (MHz)	Total E.I.R.P.			
	QPSK	16QAM	64QAM	256QAM
	(W)			
3 565.00 + 3 695.00	175.33	182.36	177.72	179.24

Frequency (MHz)	E.I.R.P.				Limit
	QPSK	16QAM	64QAM	256QAM	
	(dBm/10 MHz)				
3 565.00 + 3 695.00	46.42	46.59	46.48	46.51	47

**CBRS LTE[20 MHz 1C + (15 MHz 1C + 15 MHz 1C)][3C(1C+2C)]**

Ant.	Mod	LTE 20 MHz		LTE 15 MHz + LTE 15 MHz		Summation Value (dBm)	Directional Gain (dBi)	E.I.R.P. (dBm)	Calculated (W)
		Frequency (MHz)	Measured Value (dBm)	Frequency (MHz)	Measured Value (dBm)				
0	QPSK	3 560.00	31.27	3 685.00	32.92	35.19	12.00	47.19	52.31
	16QAM	3 560.00	31.31	3 685.00	32.93	35.20	12.00	47.20	52.50
	64QAM	3 560.00	31.28	3 685.00	32.83	35.13	12.00	47.13	51.67
	256QAM	3 560.00	31.42	3 685.00	32.81	35.18	12.00	47.18	52.24
1	QPSK	3 560.00	31.57	3 685.00	33.23	35.49	12.00	47.49	56.13
	16QAM	3 560.00	31.60	3 685.00	33.22	35.50	12.00	47.50	56.18
	64QAM	3 560.00	31.54	3 685.00	33.06	35.37	12.00	47.37	54.61
	256QAM	3 560.00	31.75	3 685.00	33.06	35.47	12.00	47.47	55.80
2	QPSK	3 560.00	31.52	3 685.00	33.22	35.46	12.00	47.46	55.73
	16QAM	3 560.00	31.45	3 685.00	33.04	35.32	12.00	47.32	54.00
	64QAM	3 560.00	31.46	3 685.00	32.99	35.31	12.00	47.31	53.78
	256QAM	3 560.00	31.70	3 685.00	33.00	35.41	12.00	47.41	55.07
3	QPSK	3 560.00	31.66	3 685.00	33.34	35.59	12.00	47.59	57.40
	16QAM	3 560.00	31.69	3 685.00	33.23	35.54	12.00	47.54	56.74
	64QAM	3 560.00	31.71	3 685.00	33.26	35.57	12.00	47.57	57.12
	256QAM	3 560.00	31.95	3 685.00	33.29	35.68	12.00	47.68	58.65

Note: 1C: 1 Carrier, 2C: 2 Carrier, 3C: 3 Carrier

**Sum Data of Port 0, Port 1, Port 2 and Port 3**

Frequency (MHz)	Total E.I.R.P.			
	QPSK	16QAM	64QAM	256QAM
	(W)			
3 560.00 + 3 685.00	221.57	219.43	217.18	221.76

Frequency (MHz)	E.I.R.P.				Limit
	QPSK	16QAM	64QAM	256QAM	
	(dBm/10 MHz)				
3 560.00 + 3 685.00	46.47	46.42	46.38	46.47	47

**CBRS LTE[(20 MHz 1C + 15 MHz 1C) + 15 MHz 1C][3C(2C+1C)]**

Ant.	Mod	LTE 20 MHz + LTE 15 MHz		LTE 15 MHz		Summation Value (dBm)	Directional Gain (dBi)	E.I.R.P. (dBm)	Calculated (W)
		Frequency (MHz)	Measured Value (dBm)	Frequency (MHz)	Measured Value (dBm)				
0	QPSK	3 567.50	33.46	3 692.50	29.86	35.03	12.00	47.03	50.49
	16QAM	3 567.50	33.54	3 692.50	30.06	35.15	12.00	47.15	51.86
	64QAM	3 567.50	33.53	3 692.50	29.99	35.12	12.00	47.12	51.52
	256QAM	3 567.50	33.54	3 692.50	29.85	35.09	12.00	47.09	51.12
1	QPSK	3 567.50	33.61	3 692.50	30.10	35.21	12.00	47.21	52.59
	16QAM	3 567.50	33.93	3 692.50	30.37	35.51	12.00	47.51	56.42
	64QAM	3 567.50	33.78	3 692.50	30.24	35.37	12.00	47.37	54.61
	256QAM	3 567.50	33.79	3 692.50	30.19	35.36	12.00	47.36	54.48
2	QPSK	3 567.50	33.71	3 692.50	30.22	35.32	12.00	47.32	53.96
	16QAM	3 567.50	33.79	3 692.50	30.26	35.39	12.00	47.39	54.79
	64QAM	3 567.50	33.74	3 692.50	30.25	35.35	12.00	47.35	54.34
	256QAM	3 567.50	33.74	3 692.50	30.19	35.33	12.00	47.33	54.10
3	QPSK	3 567.50	33.95	3 692.50	30.45	35.56	12.00	47.56	56.95
	16QAM	3 567.50	33.92	3 692.50	30.45	35.53	12.00	47.53	56.68
	64QAM	3 567.50	33.86	3 692.50	30.37	35.47	12.00	47.47	55.83
	256QAM	3 567.50	33.97	3 692.50	30.37	35.55	12.00	47.55	56.82

Note: 1C: 1 Carrier, 2C: 2 Carrier, 3C: 3 Carrier

**Sum Data of Port 0, Port 1, Port 2 and Port 3**

Frequency (MHz)	Total E.I.R.P.			
	QPSK	16QAM	64QAM	256QAM
	(W)			
3 567.50 + 3 692.50	213.99	219.74	216.31	216.52

Frequency (MHz)	E.I.R.P.				Limit
	QPSK	16QAM	64QAM	256QAM	
	(dBm/10 MHz)				
3 567.50 + 3 692.50	46.31	46.43	46.36	46.37	47

**CBRS LTE[20 MHz 1C + (20 MHz 1C + 20 MHz 1C)][3C(1C+2C)]**

Ant.	Mod	LTE 20 MHz		LTE 20 MHz + LTE 20 MHz		Summation Value (dBm)	Directional Gain (dBi)	E.I.R.P. (dBm)	Calculated (W)
		Frequency (MHz)	Measured Value (dBm)	Frequency (MHz)	Measured Value (dBm)				
0	QPSK	3 560.00	31.30	3 680.00	34.12	35.95	12.00	47.95	62.30
	16QAM	3 560.00	31.40	3 680.00	34.05	35.94	12.00	47.94	62.16
	64QAM	3 560.00	31.35	3 680.00	33.98	35.87	12.00	47.87	61.26
	256QAM	3 560.00	31.49	3 680.00	33.81	35.81	12.00	47.81	60.45
1	QPSK	3 560.00	31.64	3 680.00	34.41	36.25	12.00	48.25	66.90
	16QAM	3 560.00	31.69	3 680.00	34.32	36.21	12.00	48.21	66.27
	64QAM	3 560.00	31.62	3 680.00	34.25	36.14	12.00	48.14	65.12
	256QAM	3 560.00	31.84	3 680.00	34.08	36.11	12.00	48.11	64.77
2	QPSK	3 560.00	31.57	3 680.00	34.34	36.18	12.00	48.18	65.81
	16QAM	3 560.00	31.54	3 680.00	34.17	36.06	12.00	48.06	64.03
	64QAM	3 560.00	31.55	3 680.00	34.21	36.09	12.00	48.09	64.46
	256QAM	3 560.00	31.82	3 680.00	34.06	36.10	12.00	48.10	64.51
3	QPSK	3 560.00	31.78	3 680.00	34.59	36.42	12.00	48.42	69.44
	16QAM	3 560.00	31.77	3 680.00	34.40	36.29	12.00	48.29	67.45
	64QAM	3 560.00	31.74	3 680.00	34.41	36.29	12.00	48.29	67.42
	256QAM	3 560.00	32.08	3 680.00	34.34	36.36	12.00	48.36	68.63

Note: 1C: 1 Carrier, 2C: 2 Carrier, 3C: 3 Carrier

**Sum Data of Port 0, Port 1, Port 2 and Port 3**

Frequency (MHz)	Total E.I.R.P.			
	QPSK	16QAM	64QAM	256QAM
	(W)			
3 560.00 + 3 680.00	264.45	259.91	258.26	258.36

Frequency (MHz)	E.I.R.P.				Limit
	QPSK	16QAM	64QAM	256QAM	
	(dBm/10 MHz)				
3 560.00 + 3 680.00	46.44	46.37	46.34	46.34	47

**CBRS LTE[(20 MHz 1C + 20 MHz 1C) + 20 MHz 1C][3C(2C+1C)]**

Ant.	Mod	LTE 20 MHz + LTE 20 MHz		LTE 20 MHz		Summation Value (dBm)	Directional Gain (dBi)	E.I.R.P. (dBm)	Calculated (W)
		Frequency (MHz)	Measured Value (dBm)	Frequency (MHz)	Measured Value (dBm)				
0	QPSK	3 570.00	33.97	3 690.00	31.19	35.81	12.00	47.81	60.41
	16QAM	3 570.00	34.25	3 690.00	31.15	35.98	12.00	47.98	62.88
	64QAM	3 570.00	33.97	3 690.00	31.20	35.81	12.00	47.81	60.44
	256QAM	3 570.00	34.00	3 690.00	31.18	35.82	12.00	47.82	60.60
1	QPSK	3 570.00	34.26	3 690.00	31.44	36.09	12.00	48.09	64.34
	16QAM	3 570.00	34.21	3 690.00	31.19	35.97	12.00	47.97	62.60
	64QAM	3 570.00	34.09	3 690.00	31.20	35.89	12.00	47.89	61.55
	256QAM	3 570.00	34.25	3 690.00	31.15	35.98	12.00	47.98	62.86
2	QPSK	3 570.00	34.44	3 690.00	31.49	36.22	12.00	48.22	66.36
	16QAM	3 570.00	34.34	3 690.00	31.12	36.03	12.00	48.03	63.55
	64QAM	3 570.00	34.13	3 690.00	31.28	35.94	12.00	47.94	62.26
	256QAM	3 570.00	34.25	3 690.00	31.16	35.99	12.00	47.99	62.88
3	QPSK	3 570.00	34.66	3 690.00	31.72	36.44	12.00	48.44	69.90
	16QAM	3 570.00	34.55	3 690.00	31.54	36.31	12.00	48.31	67.72
	64QAM	3 570.00	34.39	3 690.00	31.53	36.20	12.00	48.20	66.05
	256QAM	3 570.00	34.38	3 690.00	31.32	36.12	12.00	48.12	64.91

Note: 1C: 1 Carrier, 2C: 2 Carrier, 3C: 3 Carrier

**Sum Data of Port 0, Port 1, Port 2 and Port 3**

Frequency (MHz)	Total E.I.R.P.			
	QPSK	16QAM	64QAM	256QAM
	(W)			
3 570.00 + 3 690.00	261.01	256.75	250.30	251.25

Frequency (MHz)	E.I.R.P.				Limit
	QPSK	16QAM	64QAM	256QAM	
	(dBm/10 MHz)				
3 570.00 + 3 690.00	46.39	46.31	46.20	46.22	47

**CBRS LTE[20 MHz 1C + (20 MHz 1C + 20 MHz 1C + 20 MHz 1C)][4C(1C+3C)]**

Ant.	Mod	LTE 20 MHz		LTE 20 MHz + LTE 20 MHz + LTE 20 MHz		Summation Value (dBm)	Directional Gain (dBi)	E.I.R.P. (dBm)	Calculated (W)
		Frequency (MHz)	Measured Value (dBm)	Frequency (MHz)	Measured Value (dBm)				
0	QPSK	3 560.00	30.89	3 670.00	35.39	36.71	13.00	49.71	93.52
	16QAM	3 560.00	30.65	3 670.00	34.95	36.33	13.00	49.33	85.62
	64QAM	3 560.00	30.40	3 670.00	35.12	36.39	13.00	49.39	86.82
	256QAM	3 560.00	30.60	3 670.00	34.97	36.32	13.00	49.32	85.53
1	QPSK	3 560.00	31.10	3 670.00	35.48	36.83	13.00	49.83	96.12
	16QAM	3 560.00	30.84	3 670.00	35.18	36.54	13.00	49.54	89.93
	64QAM	3 560.00	30.72	3 670.00	35.22	36.54	13.00	49.54	89.89
	256QAM	3 560.00	30.81	3 670.00	35.04	36.43	13.00	49.43	87.76
2	QPSK	3 560.00	30.89	3 670.00	35.27	36.62	13.00	49.62	91.69
	16QAM	3 560.00	30.57	3 670.00	35.00	36.34	13.00	49.34	85.86
	64QAM	3 560.00	30.55	3 670.00	35.04	36.36	13.00	49.36	86.24
	256QAM	3 560.00	30.62	3 670.00	34.87	36.25	13.00	49.25	84.22
3	QPSK	3 560.00	31.15	3 670.00	35.57	36.91	13.00	49.91	97.86
	16QAM	3 560.00	30.85	3 670.00	35.26	36.60	13.00	49.60	91.16
	64QAM	3 560.00	30.81	3 670.00	35.33	36.65	13.00	49.65	92.15
	256QAM	3 560.00	30.88	3 670.00	35.17	36.54	13.00	49.54	90.01

Note: 1C: 1 Carrier, 3C: 3 Carrier, 4C: 4 Carrier

**Sum Data of Port 0, Port 1, Port 2 and Port 3**

Frequency (MHz)	Total E.I.R.P.			
	QPSK	16QAM	64QAM	256QAM
	(W)			
3 560.00 + 3 670.00	379.18	352.57	355.09	347.52

Frequency (MHz)	E.I.R.P.				Limit
	QPSK	16QAM	64QAM	256QAM	
	(dBm/10 MHz)				
3 560.00 + 3 670.00	46.76	46.44	46.47	46.38	47

**CBRS LTE[(20 MHz 1C + 20 MHz 1C + 20 MHz 1C) + 20 MHz 1C][4C(3C+1C)]**

Ant.	Mod	LTE 20 MHz +		LTE 20 MHz		Summation Value (dBm)	Directional Gain (dBi)	E.I.R.P. (dBm)	Calculated (W)
		LTE 20 MHz + LTE 20 MHz		LTE 20 MHz					
		Frequency (MHz)	Measured Value (dBm)	Frequency (MHz)	Measured Value (dBm)				
0	QPSK	3 580.00	35.13	3 690.00	30.31	36.37	13.00	49.37	86.46
	16QAM	3 580.00	34.91	3 690.00	30.30	36.20	13.00	49.20	83.25
	64QAM	3 580.00	34.91	3 690.00	30.00	36.13	13.00	49.13	81.83
	256QAM	3 580.00	34.93	3 690.00	30.02	36.14	13.00	49.14	82.13
1	QPSK	3 580.00	35.30	3 690.00	30.57	36.56	13.00	49.56	90.39
	16QAM	3 580.00	35.24	3 690.00	30.61	36.52	13.00	49.52	89.60
	64QAM	3 580.00	35.04	3 690.00	30.10	36.24	13.00	49.24	84.04
	256QAM	3 580.00	34.99	3 690.00	30.13	36.21	13.00	49.21	83.44
2	QPSK	3 580.00	35.07	3 690.00	30.36	36.34	13.00	49.34	85.86
	16QAM	3 580.00	34.99	3 690.00	30.17	36.22	13.00	49.22	83.66
	64QAM	3 580.00	34.88	3 690.00	30.06	36.11	13.00	49.11	81.55
	256QAM	3 580.00	34.89	3 690.00	30.04	36.12	13.00	49.12	81.66
3	QPSK	3 580.00	35.27	3 690.00	30.57	36.54	13.00	49.54	89.85
	16QAM	3 580.00	35.34	3 690.00	30.62	36.60	13.00	49.60	91.20
	64QAM	3 580.00	35.21	3 690.00	30.31	36.43	13.00	49.43	87.70
	256QAM	3 580.00	34.97	3 690.00	30.16	36.21	13.00	49.21	83.31

Note: 1C: 1 Carrier, 3C: 3 Carrier, 4C: 4 Carrier

**Sum Data of Port 0, Port 1, Port 2 and Port 3**

Frequency (MHz)	Total E.I.R.P.			
	QPSK	16QAM	64QAM	256QAM
	(W)			
3 580.00 + 3 690.00	352.55	347.71	335.12	330.54

Frequency (MHz)	E.I.R.P.				Limit
	QPSK	16QAM	64QAM	256QAM	
	(dBm/10 MHz)				
3 580.00 + 3 690.00	46.44	46.38	46.22	46.16	47



**CBRS LTE[15 MHz 1C + (15 MHz 1C + 15 MHz 1C + 15 MHz 1C + 10 MHz 1C)][5C(1C+4C)]**

Ant.	Mod	LTE 15 MHz		LTE 15 MHz + LTE 15 MHz + LTE 15 MHz + LTE 10 MHz		Summation Value (dBm)	Directional Gain (dBi)	E.I.R.P. (dBm)	Calculated (W)
		Frequency (MHz)	Measured Value (dBm)	Frequency (MHz)	Measured Value (dBm)				
0	QPSK	3 557.50	29.71	3 672.50	34.54	35.78	13.00	48.78	75.49
	16QAM	3 557.50	29.30	3 672.50	34.56	35.69	13.00	48.69	74.03
	64QAM	3 557.50	29.32	3 672.50	34.59	35.72	13.00	48.72	74.51
	256QAM	3 557.50	29.44	3 672.50	34.86	35.96	13.00	48.96	78.63
1	QPSK	3 557.50	29.92	3 672.50	34.58	35.86	13.00	48.86	76.93
	16QAM	3 557.50	29.52	3 672.50	34.71	35.86	13.00	48.86	76.88
	64QAM	3 557.50	29.61	3 672.50	34.78	35.93	13.00	48.93	78.20
	256QAM	3 557.50	29.67	3 672.50	34.98	36.10	13.00	49.10	81.36
2	QPSK	3 557.50	29.83	3 672.50	34.48	35.76	13.00	48.76	75.08
	16QAM	3 557.50	29.38	3 672.50	34.76	35.86	13.00	48.86	77.00
	64QAM	3 557.50	29.37	3 672.50	34.56	35.71	13.00	48.71	74.23
	256QAM	3 557.50	29.53	3 672.50	34.78	35.92	13.00	48.92	77.91
3	QPSK	3 557.50	30.04	3 672.50	34.72	35.99	13.00	48.99	79.21
	16QAM	3 557.50	29.86	3 672.50	35.24	36.35	13.00	49.35	86.08
	64QAM	3 557.50	29.64	3 672.50	34.87	36.01	13.00	49.01	79.63
	256QAM	3 557.50	29.74	3 672.50	35.04	36.16	13.00	49.16	82.39

Note: 1C: 1 Carrier, 4C: 4 Carrier, 5C: 5 Carrier

**Sum Data of Port 0, Port 1, Port 2 and Port 3**

Frequency (MHz)	Total E.I.R.P.			
	QPSK	16QAM	64QAM	256QAM
	(W)			
3 557.50 + 3 672.50	306.71	313.99	306.57	320.30

Frequency (MHz)	E.I.R.P.				Limit
	QPSK	16QAM	64QAM	256QAM	
	(dBm/10 MHz)				
3 557.50 + 3 672.50	46.42	46.52	46.41	46.60	47

**CBRS LTE[(15 MHz 1C + 15 MHz 1C + 15 MHz 1C + 15 MHz 1C) + 10 MHz 1C][5C(4C+1C)]**

Ant.	Mod	LTE 15 MHz + LTE 15 MHz + LTE 15 MHz + LTE 15 MHz		LTE 10 MHz		Summation Value (dBm)	Directional Gain (dBi)	E.I.R.P. (dBm)	Calculated (W)
		Frequency (MHz)	Measured Value (dBm)	Frequency (MHz)	Measured Value (dBm)				
0	QPSK	3 580.00	34.94	3 695.00	27.25	35.62	13.00	48.62	72.79
	16QAM	3 580.00	34.92	3 695.00	27.40	35.63	13.00	48.63	72.91
	64QAM	3 580.00	35.00	3 695.00	27.42	35.70	13.00	48.70	74.18
	256QAM	3 580.00	35.02	3 695.00	27.26	35.69	13.00	48.69	73.96
1	QPSK	3 580.00	35.05	3 695.00	27.26	35.72	13.00	48.72	74.44
	16QAM	3 580.00	35.10	3 695.00	27.49	35.79	13.00	48.79	75.70
	64QAM	3 580.00	35.10	3 695.00	27.52	35.80	13.00	48.80	75.89
	256QAM	3 580.00	35.19	3 695.00	27.42	35.86	13.00	48.86	76.97
2	QPSK	3 580.00	35.08	3 695.00	27.32	35.76	13.00	48.76	75.08
	16QAM	3 580.00	35.07	3 695.00	27.48	35.77	13.00	48.77	75.28
	64QAM	3 580.00	35.00	3 695.00	27.48	35.71	13.00	48.71	74.32
	256QAM	3 580.00	35.07	3 695.00	27.37	35.75	13.00	48.75	74.95
3	QPSK	3 580.00	35.14	3 695.00	27.52	35.84	13.00	48.84	76.51
	16QAM	3 580.00	35.26	3 695.00	27.68	35.96	13.00	48.96	78.76
	64QAM	3 580.00	35.29	3 695.00	27.79	36.00	13.00	49.00	79.40
	256QAM	3 580.00	35.26	3 695.00	27.59	35.95	13.00	48.95	78.47

Note: 1C: 1 Carrier, 4C: 4 Carrier, 5C: 5 Carrier

**Sum Data of Port 0, Port 1, Port 2 and Port 3**

Frequency (MHz)	Total E.I.R.P.			
	QPSK	16QAM	64QAM	256QAM
	(W)			
3 580.00 + 3 695.00	298.82	302.66	303.79	304.35

Frequency (MHz)	E.I.R.P.				Limit
	QPSK	16QAM	64QAM	256QAM	
	(dBm/10 MHz)				
3 580.00 + 3 695.00	46.30	46.36	46.37	46.38	47

**CBRS LTE[20 MHz 1C + (20 MHz 1C + 20 MHz 1C + 20 MHz 1C + 10 MHz 1C)][5C(1C+4C)]**

Ant.	Mod	LTE 20 MHz		LTE 20 MHz + LTE 20 MHz + LTE 20 MHz + LTE 10 MHz		Summation Value (dBm)	Directional Gain (dBi)	E.I.R.P. (dBm)	Calculated (W)
		Frequency (MHz)	Measured Value (dBm)	Frequency (MHz)	Measured Value (dBm)				
0	QPSK	3 560.00	29.92	3 665.00	35.22	36.34	13.00	49.34	85.90
	16QAM	3 560.00	30.07	3 665.00	34.93	36.16	13.00	49.16	82.36
	64QAM	3 560.00	29.95	3 665.00	35.19	36.33	13.00	49.33	85.66
	256QAM	3 560.00	30.04	3 665.00	35.11	36.28	13.00	49.28	84.78
1	QPSK	3 560.00	30.21	3 665.00	35.26	36.45	13.00	49.45	88.00
	16QAM	3 560.00	30.30	3 665.00	35.20	36.42	13.00	49.42	87.48
	64QAM	3 560.00	30.19	3 665.00	35.23	36.41	13.00	49.41	87.40
	256QAM	3 560.00	30.36	3 665.00	35.10	36.36	13.00	49.36	86.30
2	QPSK	3 560.00	30.10	3 665.00	35.14	36.32	13.00	49.32	85.55
	16QAM	3 560.00	30.06	3 665.00	35.02	36.22	13.00	49.22	83.58
	64QAM	3 560.00	30.02	3 665.00	35.07	36.25	13.00	49.25	84.14
	256QAM	3 560.00	30.28	3 665.00	35.14	36.36	13.00	49.36	86.40
3	QPSK	3 560.00	30.33	3 665.00	35.39	36.57	13.00	49.57	90.51
	16QAM	3 560.00	30.34	3 665.00	35.25	36.46	13.00	49.46	88.39
	64QAM	3 560.00	30.28	3 665.00	35.35	36.53	13.00	49.53	89.66
	256QAM	3 560.00	30.54	3 665.00	35.33	36.58	13.00	49.58	90.70

Note: 1C: 1 Carrier, 4C: 4 Carrier, 5C: 5 Carrier

**Sum Data of Port 0, Port 1, Port 2 and Port 3**

Frequency (MHz)	Total E.I.R.P.			
	QPSK	16QAM	64QAM	256QAM
	(W)			
3 560.00 + 3 665.00	349.96	341.80	346.86	348.17

Frequency (MHz)	E.I.R.P.				Limit
	QPSK	16QAM	64QAM	256QAM	
	(dBm/10 MHz)				
3 560.00 + 3 665.00	45.90	45.80	45.86	45.88	47

**CBRS LTE[(20 MHz 1C + 20 MHz 1C + 20 MHz 1C + 20 MHz 1C) + 10 MHz 1C][5C(4C+1C)]**

Ant.	Mod	LTE 20 MHz + LTE 20 MHz + LTE 20 MHz + LTE 20 MHz		LTE 10 MHz		Summation Value (dBm)	Directional Gain (dBi)	E.I.R.P. (dBm)	Calculated (W)
		Frequency (MHz)	Measured Value (dBm)	Frequency (MHz)	Measured Value (dBm)				
0	QPSK	3 590.00	35.61	3 695.00	26.62	36.12	13.00	49.12	81.73
	16QAM	3 590.00	35.56	3 695.00	26.85	36.11	13.00	49.11	81.45
	64QAM	3 590.00	35.76	3 695.00	26.90	36.29	13.00	49.29	84.92
	256QAM	3 590.00	35.57	3 695.00	26.75	36.11	13.00	49.11	81.41
1	QPSK	3 590.00	35.69	3 695.00	26.86	36.23	13.00	49.23	83.68
	16QAM	3 590.00	35.82	3 695.00	26.94	36.35	13.00	49.35	86.00
	64QAM	3 590.00	35.83	3 695.00	27.03	36.37	13.00	49.37	86.52
	256QAM	3 590.00	35.71	3 695.00	26.93	36.25	13.00	49.25	84.22
2	QPSK	3 590.00	35.61	3 695.00	26.72	36.14	13.00	49.14	82.00
	16QAM	3 590.00	35.63	3 695.00	26.77	36.16	13.00	49.16	82.39
	64QAM	3 590.00	35.70	3 695.00	26.98	36.25	13.00	49.25	84.08
	256QAM	3 590.00	35.49	3 695.00	26.79	36.04	13.00	49.04	80.22
3	QPSK	3 590.00	35.86	3 695.00	26.97	36.39	13.00	49.39	86.92
	16QAM	3 590.00	35.97	3 695.00	27.23	36.52	13.00	49.52	89.45
	64QAM	3 590.00	35.98	3 695.00	27.27	36.53	13.00	49.53	89.72
	256QAM	3 590.00	35.80	3 695.00	27.12	36.35	13.00	49.35	86.16

Note: 1C: 1 Carrier, 4C: 4 Carrier, 5C: 5 Carrier

**Sum Data of Port 0, Port 1, Port 2 and Port 3**

Frequency (MHz)	Total E.I.R.P.			
	QPSK	16QAM	64QAM	256QAM
	(W)			
3 590.00 + 3 695.00	334.32	339.30	345.24	332.01

Frequency (MHz)	E.I.R.P.				Limit
	QPSK	16QAM	64QAM	256QAM	
	(dBm/10 MHz)				
3 590.00 + 3 695.00	45.70	45.76	45.84	45.67	47

**CBRS LTE[20 MHz 1C + (20 MHz 1C + 20 MHz 1C + 20 MHz 1C + 20 MHz 1C)][5C(1C+4C)]**

Ant.	Mod	LTE 20 MHz		LTE 20 MHz + LTE 20 MHz + LTE 20 MHz + LTE 20 MHz		Summation Value (dBm)	Directional Gain (dBi)	E.I.R.P. (dBm)	Calculated (W)
		Frequency (MHz)	Measured Value (dBm)	Frequency (MHz)	Measured Value (dBm)				
0	QPSK	3 560.00	29.42	3 660.00	35.21	36.22	13.00	49.22	83.64
	16QAM	3 560.00	29.35	3 660.00	35.19	36.20	13.00	49.20	83.10
	64QAM	3 560.00	29.04	3 660.00	35.15	36.10	13.00	49.10	81.34
	256QAM	3 560.00	29.23	3 660.00	35.18	36.17	13.00	49.17	82.53
1	QPSK	3 560.00	29.61	3 660.00	35.14	36.21	13.00	49.21	83.43
	16QAM	3 560.00	29.50	3 660.00	34.93	36.02	13.00	49.02	79.80
	64QAM	3 560.00	29.19	3 660.00	35.17	36.15	13.00	49.15	82.24
	256QAM	3 560.00	29.39	3 660.00	35.16	36.18	13.00	49.18	82.76
2	QPSK	3 560.00	29.40	3 660.00	35.10	36.14	13.00	49.14	81.94
	16QAM	3 560.00	29.16	3 660.00	35.12	36.10	13.00	49.10	81.34
	64QAM	3 560.00	29.07	3 660.00	35.13	36.09	13.00	49.09	81.15
	256QAM	3 560.00	29.33	3 660.00	35.17	36.18	13.00	49.18	82.72
3	QPSK	3 560.00	29.50	3 660.00	35.01	36.09	13.00	49.09	81.08
	16QAM	3 560.00	29.31	3 660.00	35.19	36.19	13.00	49.19	82.93
	64QAM	3 560.00	29.27	3 660.00	35.17	36.16	13.00	49.16	82.45
	256QAM	3 560.00	29.48	3 660.00	35.18	36.21	13.00	49.21	83.41

Note: 1C: 1 Carrier, 4C: 4 Carrier, 5C: 5 Carrier

**Sum Data of Port 0, Port 1, Port 2 and Port 3**

Frequency (MHz)	Total E.I.R.P.			
	QPSK	16QAM	64QAM	256QAM
	(W)			
3 560.00 + 3 660.00	330.08	327.17	327.19	331.41

Frequency (MHz)	E.I.R.P.				Limit
	QPSK	16QAM	64QAM	256QAM	
	(dBm/10 MHz)				
3 560.00 + 3 660.00	45.19	45.15	45.15	45.20	47

**CBRS LTE[(20 MHz 1C + 20 MHz 1C + 20 MHz 1C + 20 MHz 1C) + 20 MHz 1C][5C(4C+1C)]**

Ant.	Mod	LTE 20 MHz + LTE 20 MHz + LTE 20 MHz + LTE 20 MHz		LTE 20 MHz		Summation Value (dBm)	Directional Gain (dBi)	E.I.R.P. (dBm)	Calculated (W)
		Frequency (MHz)	Measured Value (dBm)	Frequency (MHz)	Measured Value (dBm)				
0	QPSK	3 590.00	35.22	3 690.00	29.24	36.19	13.00	49.19	83.06
	16QAM	3 590.00	35.08	3 690.00	29.33	36.11	13.00	49.11	81.41
	64QAM	3 590.00	35.20	3 690.00	29.17	36.17	13.00	49.17	82.58
	256QAM	3 590.00	35.03	3 690.00	29.19	36.04	13.00	49.04	80.13
1	QPSK	3 590.00	35.34	3 690.00	29.37	36.32	13.00	49.32	85.55
	16QAM	3 590.00	35.28	3 690.00	29.39	36.27	13.00	49.27	84.57
	64QAM	3 590.00	35.27	3 690.00	29.29	36.25	13.00	49.25	84.10
	256QAM	3 590.00	35.06	3 690.00	29.33	36.09	13.00	49.09	81.04
2	QPSK	3 590.00	35.21	3 690.00	29.27	36.20	13.00	49.20	83.10
	16QAM	3 590.00	35.14	3 690.00	29.19	36.12	13.00	49.12	81.71
	64QAM	3 590.00	35.12	3 690.00	29.17	36.10	13.00	49.10	81.30
	256QAM	3 590.00	35.10	3 690.00	29.19	36.09	13.00	49.09	81.15
3	QPSK	3 590.00	35.25	3 690.00	29.33	36.24	13.00	49.24	83.98
	16QAM	3 590.00	35.32	3 690.00	29.33	36.30	13.00	49.30	85.07
	64QAM	3 590.00	35.29	3 690.00	29.34	36.28	13.00	49.28	84.63
	256QAM	3 590.00	35.12	3 690.00	29.42	36.16	13.00	49.16	82.38

Note: 1C: 1 Carrier, 4C: 4 Carrier, 5C: 5 Carrier

**Sum Data of Port 0, Port 1, Port 2 and Port 3**

Frequency (MHz)	Total E.I.R.P.			
	QPSK	16QAM	64QAM	256QAM
	(W)			
3 590.00 + 3 690.00	335.69	332.77	332.61	324.70

Frequency (MHz)	E.I.R.P.				Limit
	QPSK	16QAM	64QAM	256QAM	
	(dBm/10 MHz)				
3 590.00 + 3 690.00	45.26	45.22	45.22	45.11	47

**CBRS NR 40 MHz 1C + (NR 20 MHz 1C + NR 20 MHz 1C + LTE 10 MHz 1C + LTE 10 MHz 1C)[5C(1C+4C)]**

Ant.	Mod	NR 40 MHz		NR 20 MHz + NR 20 MHz + LTE 10 MHz + LTE 10 MHz		Summation Value (dBm)	Directional Gain (dBi)	E.I.R.P. (dBm)	Calculated (W)
		Frequency (MHz)	Measured Value (dBm)	Frequency (MHz)	Measured Value (dBm)				
0	QPSK	3 570.00	32.44	3 670.00	34.08	36.35	13.00	49.35	86.10
	16QAM	3 570.00	32.20	3 670.00	33.70	36.03	13.00	49.03	79.95
	64QAM	3 570.00	32.27	3 670.00	34.10	36.29	13.00	49.29	84.98
	256QAM	3 570.00	32.26	3 670.00	33.96	36.20	13.00	49.20	83.21
1	QPSK	3 570.00	32.38	3 670.00	33.97	36.26	13.00	49.26	84.29
	16QAM	3 570.00	32.40	3 670.00	33.91	36.23	13.00	49.23	83.75
	64QAM	3 570.00	32.37	3 670.00	34.09	36.32	13.00	49.32	85.57
	256QAM	3 570.00	32.36	3 670.00	34.00	36.27	13.00	49.27	84.57
2	QPSK	3 570.00	32.34	3 670.00	33.91	36.21	13.00	49.21	83.27
	16QAM	3 570.00	32.35	3 670.00	33.89	36.20	13.00	49.20	83.14
	64QAM	3 570.00	32.23	3 670.00	33.93	36.17	13.00	49.17	82.62
	256QAM	3 570.00	32.20	3 670.00	33.82	36.10	13.00	49.10	81.21
3	QPSK	3 570.00	32.64	3 670.00	34.26	36.53	13.00	49.53	89.80
	16QAM	3 570.00	32.73	3 670.00	34.29	36.59	13.00	49.59	91.01
	64QAM	3 570.00	32.51	3 670.00	34.23	36.46	13.00	49.46	88.35
	256QAM	3 570.00	32.42	3 670.00	34.06	36.33	13.00	49.33	85.66

Note: 1C: 1 Carrier, 4C: 4 Carrier, 5C: 5 Carrier

**Sum Data of Port 0, Port 1, Port 2 and Port 3**

Frequency (MHz)	Total E.I.R.P.			
	QPSK	16QAM	64QAM	256QAM
	(W)			
3 570.00 + 3 670.00	343.47	337.85	341.51	334.65

Frequency (MHz)	E.I.R.P.				Limit
	QPSK	16QAM	64QAM	256QAM	
	(dBm/10 MHz)				
3 570.00 + 3 670.00	45.36	45.29	45.33	45.25	47

**CBRS (NR 40 MHz 1C + NR 20 MHz 1C + NR 20 MHz 1C + LTE 10 MHz 1C) + LTE 10 MHz 1C [5C(4C+1C)]**

Ant.	Mod	NR 40 MHz + NR 20 MHz + NR 20 MHz + LTE 10 MHz		LTE 10 MHz		Summation Value (dBm)	Directional Gain (dBi)	E.I.R.P. (dBm)	Calculated (W)
		Frequency (MHz)	Measured Value (dBm)	Frequency (MHz)	Measured Value (dBm)				
0	QPSK	3 595.00	35.90	3 695.00	26.92	36.42	13.00	49.42	87.52
	16QAM	3 595.00	35.78	3 695.00	26.99	36.32	13.00	49.32	85.47
	64QAM	3 595.00	35.67	3 695.00	26.24	36.14	13.00	49.14	81.98
	256QAM	3 595.00	35.55	3 695.00	26.37	36.04	13.00	49.04	80.22
1	QPSK	3 595.00	35.99	3 695.00	27.04	36.51	13.00	49.51	89.35
	16QAM	3 595.00	35.88	3 695.00	27.00	36.41	13.00	49.41	87.30
	64QAM	3 595.00	35.59	3 695.00	26.08	36.05	13.00	49.05	80.35
	256QAM	3 595.00	35.64	3 695.00	26.45	36.13	13.00	49.13	81.85
2	QPSK	3 595.00	35.61	3 695.00	26.82	36.15	13.00	49.15	82.26
	16QAM	3 595.00	35.66	3 695.00	26.99	36.21	13.00	49.21	83.35
	64QAM	3 595.00	35.63	3 695.00	26.01	36.08	13.00	49.08	80.91
	256QAM	3 595.00	35.44	3 695.00	26.35	35.95	13.00	48.95	78.51
3	QPSK	3 595.00	35.92	3 695.00	27.07	36.45	13.00	49.45	88.08
	16QAM	3 595.00	36.28	3 695.00	27.53	36.82	13.00	49.82	96.01
	64QAM	3 595.00	35.63	3 695.00	26.22	36.10	13.00	49.10	81.28
	256QAM	3 595.00	35.84	3 695.00	26.84	36.36	13.00	49.36	86.26

Note: 1C: 1 Carrier, 4C: 4 Carrier, 5C: 5 Carrier

**Sum Data of Port 0, Port 1, Port 2 and Port 3**

Frequency (MHz)	Total E.I.R.P.			
	QPSK	16QAM	64QAM	256QAM
	(W)			
3 595.00 + 3 695.00	347.22	352.12	324.52	326.83

Frequency (MHz)	E.I.R.P.				Limit
	QPSK	16QAM	64QAM	256QAM	
	(dBm/10 MHz)				
3 595.00 + 3 695.00	45.41	45.47	45.11	45.14	47



**CBRS NR 40 MHz 1C + (NR 10 MHz 1C + LTE 20 MHz 1C + LTE 5 MHz 1C + LTE 5 MHz 1C)[5C(1C+4C)]**

Ant.	Mod	NR 30 MHz		NR 30 MHz + NR 10 MHz		Summation Value (dBm)	Directional Gain (dBi)	E.I.R.P. (dBm)	Calculated (W)
		Frequency (MHz)	Measured Value (dBm)	Frequency (MHz)	Measured Value (dBm)				
0	QPSK	3 570.00	33.29	3 680.00	33.29	36.30	13.00	49.30	85.17
	16QAM	3 570.00	33.49	3 680.00	33.13	36.32	13.00	49.32	85.59
	64QAM	3 570.00	33.39	3 680.00	33.53	36.47	13.00	49.47	88.43
	256QAM	3 570.00	33.26	3 680.00	33.36	36.32	13.00	49.32	85.49
1	QPSK	3 570.00	33.35	3 680.00	33.33	36.35	13.00	49.35	86.08
	16QAM	3 570.00	33.66	3 680.00	33.33	36.51	13.00	49.51	89.29
	64QAM	3 570.00	33.54	3 680.00	33.64	36.60	13.00	49.60	91.26
	256QAM	3 570.00	33.39	3 680.00	33.45	36.43	13.00	49.43	87.72
2	QPSK	3 570.00	33.32	3 680.00	33.29	36.32	13.00	49.32	85.41
	16QAM	3 570.00	33.33	3 680.00	33.00	36.18	13.00	49.18	82.72
	64QAM	3 570.00	33.35	3 680.00	33.41	36.39	13.00	49.39	86.98
	256QAM	3 570.00	33.23	3 680.00	33.25	36.25	13.00	49.25	84.16
3	QPSK	3 570.00	33.59	3 680.00	33.59	36.60	13.00	49.60	91.24
	16QAM	3 570.00	33.79	3 680.00	33.44	36.63	13.00	49.63	91.88
	64QAM	3 570.00	33.55	3 680.00	33.64	36.60	13.00	49.60	91.29
	256QAM	3 570.00	33.45	3 680.00	33.50	36.49	13.00	49.49	88.84

Note: 1C: 1 Carrier, 4C: 4 Carrier, 5C: 5 Carrier

**Sum Data of Port 0, Port 1, Port 2 and Port 3**

Frequency (MHz)	Total E.I.R.P.			
	QPSK	16QAM	64QAM	256QAM
	(W)			
3 570.00 + 3 680.00	347.90	349.47	357.96	346.20

Frequency (MHz)	E.I.R.P.				Limit
	QPSK	16QAM	64QAM	256QAM	
	(dBm/10 MHz)				
3 570.00 + 3 680.00	45.41	45.43	45.54	45.39	3 570.00 + 3 680.00

**CBRS (NR 40 MHz 1C + NR 10 MHz 1C + LTE 20 MHz 1C + LTE 5 MHz 1C) + LTE 5 MHz 1C[5C(4C+1C)]**

Ant.	Mod	NR 30 MHz		NR 30 MHz + NR 10 MHz		Summation Value (dBm)	Directional Gain (dBi)	E.I.R.P. (dBm)	Calculated (W)
		Frequency (MHz)	Measured Value (dBm)	Frequency (MHz)	Measured Value (dBm)				
0	QPSK	3 587.50	36.03	3 697.50	24.72	36.34	13.00	49.34	85.86
	16QAM	3 587.50	36.00	3 697.50	24.18	36.28	13.00	49.28	84.70
	64QAM	3 587.50	36.08	3 697.50	24.52	36.38	13.00	49.38	86.64
	256QAM	3 587.50	36.08	3 697.50	24.97	36.41	13.00	49.41	87.22
1	QPSK	3 587.50	36.11	3 697.50	24.83	36.42	13.00	49.42	87.56
	16QAM	3 587.50	36.18	3 697.50	24.32	36.46	13.00	49.46	88.25
	64QAM	3 587.50	36.12	3 697.50	24.60	36.41	13.00	49.41	87.38
	256QAM	3 587.50	36.16	3 697.50	25.05	36.48	13.00	49.48	88.76
2	QPSK	3 587.50	35.93	3 697.50	24.76	36.25	13.00	49.25	84.22
	16QAM	3 587.50	35.98	3 697.50	24.22	36.26	13.00	49.26	84.29
	64QAM	3 587.50	35.96	3 697.50	24.52	36.26	13.00	49.26	84.37
	256QAM	3 587.50	35.93	3 697.50	24.89	36.26	13.00	49.26	84.29
3	QPSK	3 587.50	36.23	3 697.50	25.11	36.55	13.00	49.55	90.26
	16QAM	3 587.50	36.19	3 697.50	24.47	36.47	13.00	49.47	88.61
	64QAM	3 587.50	36.22	3 697.50	24.83	36.52	13.00	49.52	89.62
	256QAM	3 587.50	36.17	3 697.50	25.19	36.51	13.00	49.51	89.25

Note: 1C: 1 Carrier, 4C: 4 Carrier, 5C: 5 Carrier

**Sum Data of Port 0, Port 1, Port 2 and Port 3**

Frequency (MHz)	Total E.I.R.P.			
	QPSK	16QAM	64QAM	256QAM
	(W)			
3 587.50 + 3 697.50	347.90	345.86	348.01	349.52

Frequency (MHz)	E.I.R.P.				Limit
	QPSK	16QAM	64QAM	256QAM	
	(dBm/10 MHz)				
3 587.50 + 3 697.50	45.41	45.39	45.42	45.43	47

## Plot Data of RF Output Power

## Antenna 2 / CBRS NR 10 MHz 1 Carrier / 16QAM / Low

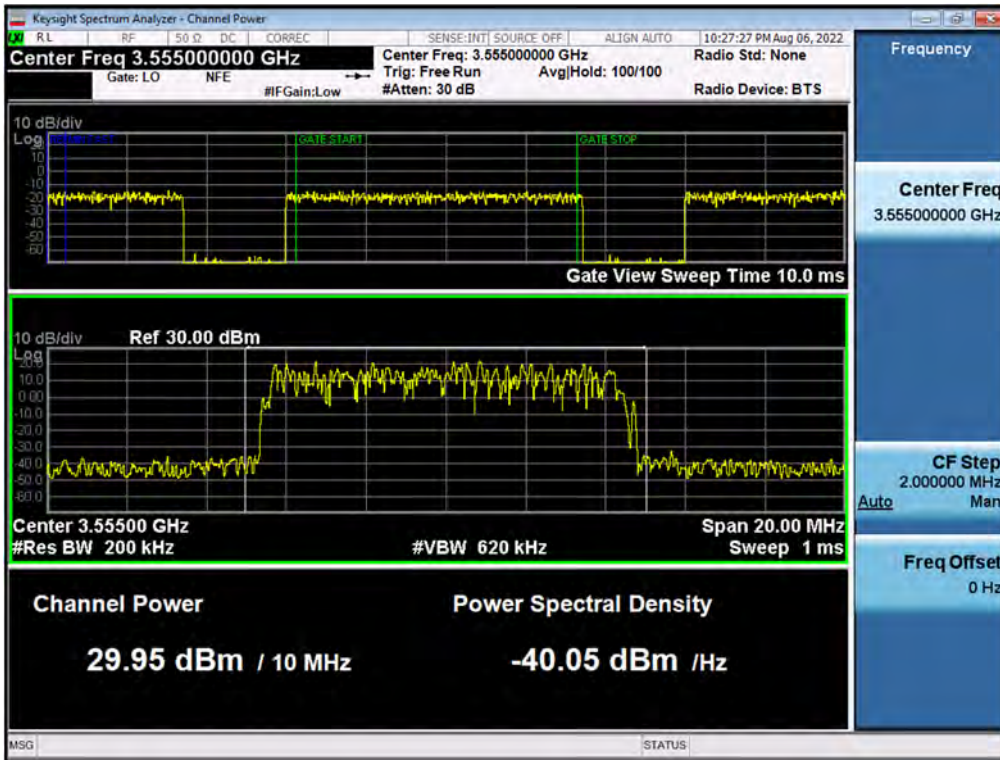

## Antenna 1 / CBRS NR 20 MHz 1 Carrier / 16QAM / Middle

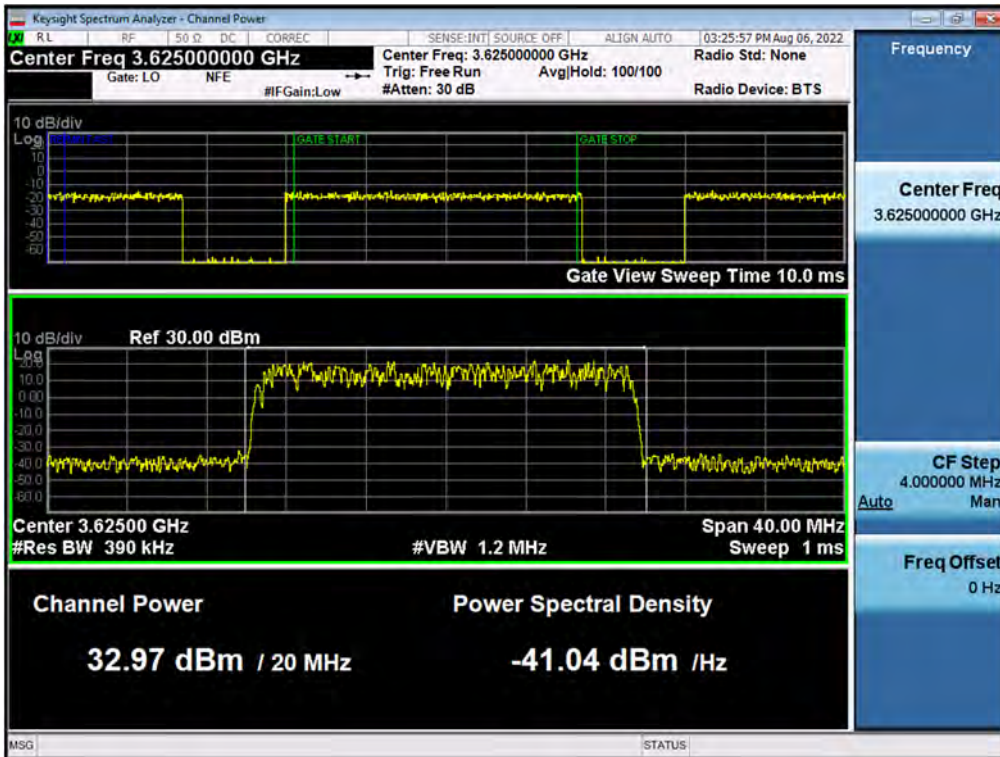

## Antenna 2 / CBRS NR 30 MHz 1 Carrier / 256QAM / Low

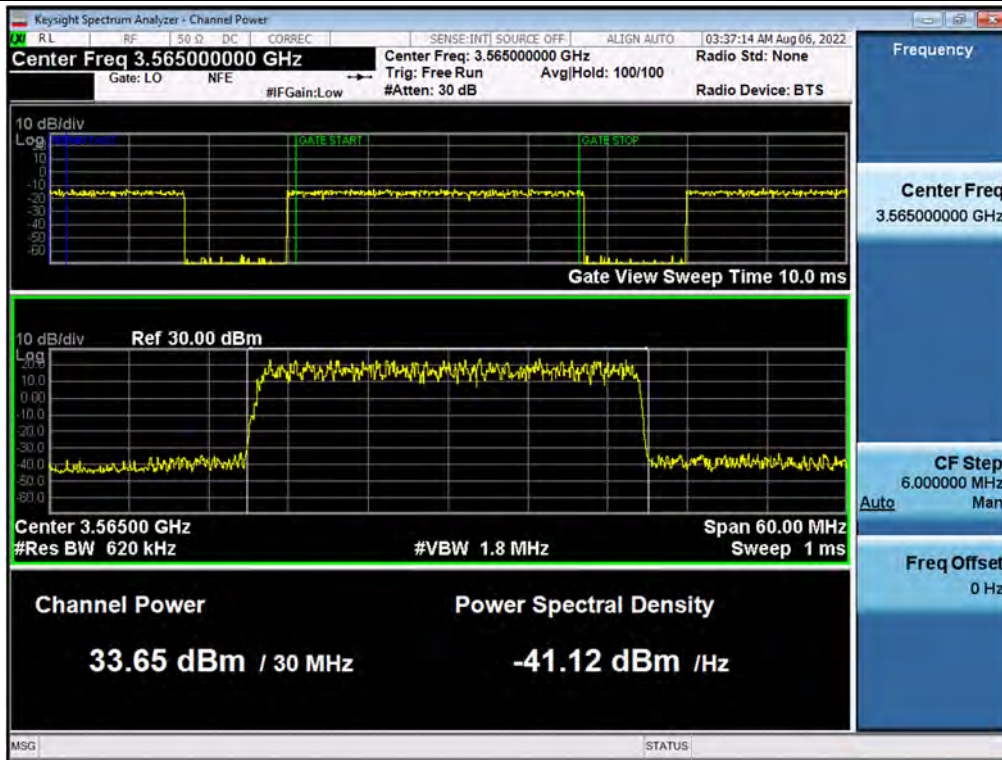

## Antenna 3 / CBRS NR 40 MHz 1 Carrier / 16QAM / Low

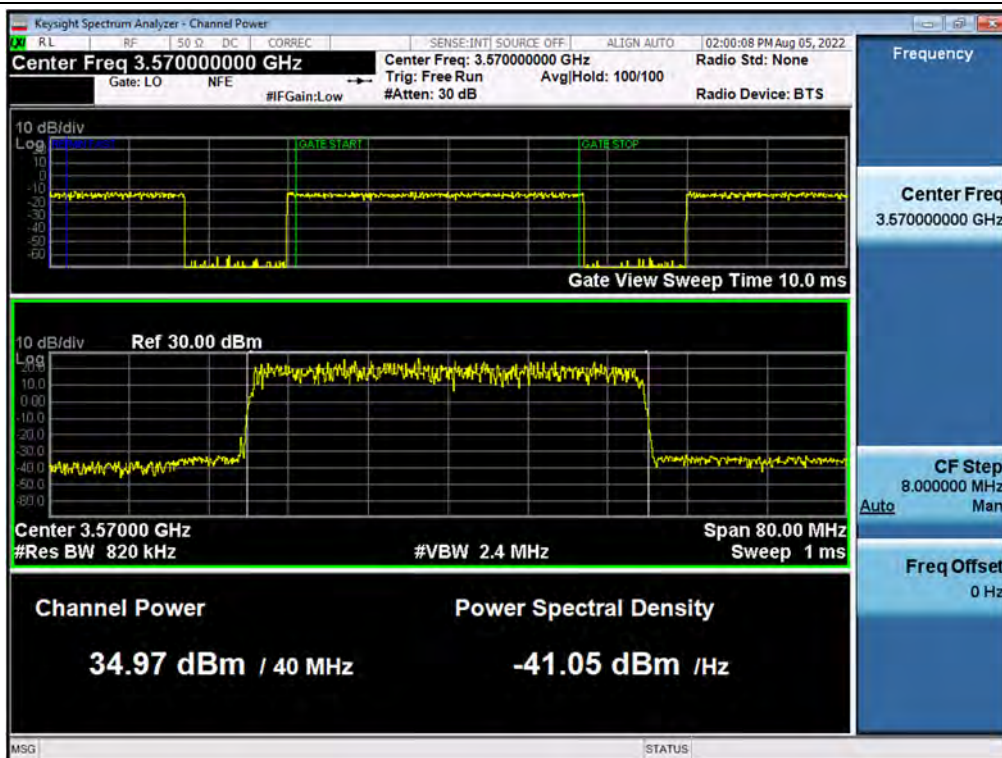

## Antenna 2 / CBRS NR 60 MHz 1 Carrier / 64QAM / Low

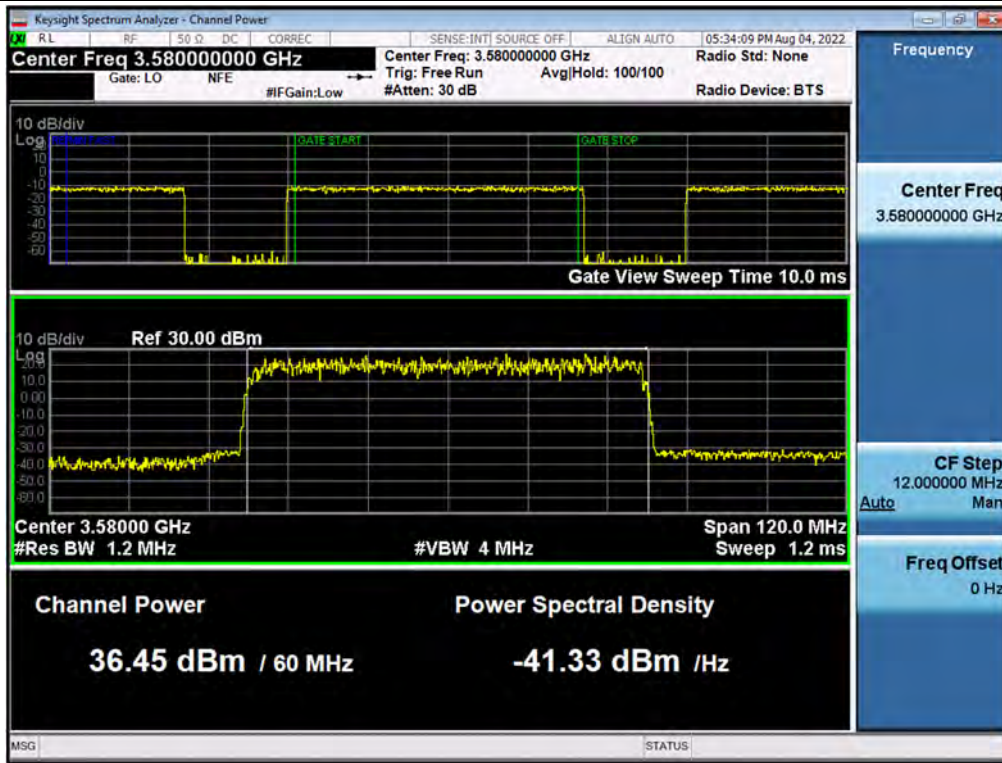

## Antenna 1 / CBRS NR 80 MHz 1 Carrier / 256QAM / Low

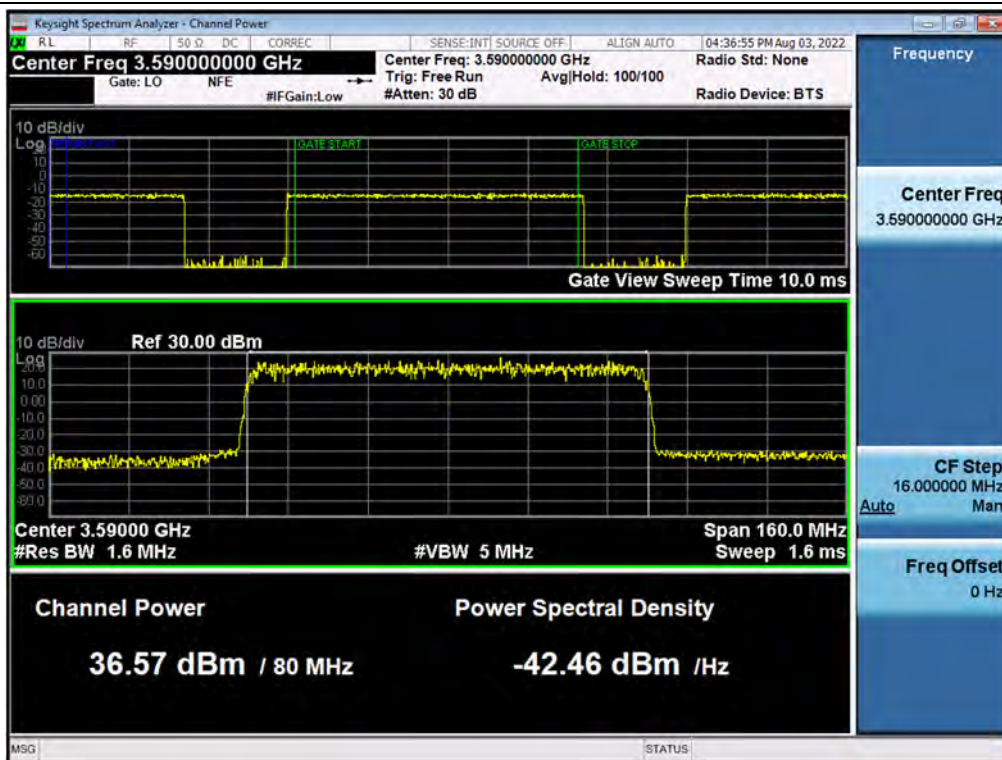

## Antenna 2 / CBRS NR 100 MHz 1 Carrier / 64QAM / High

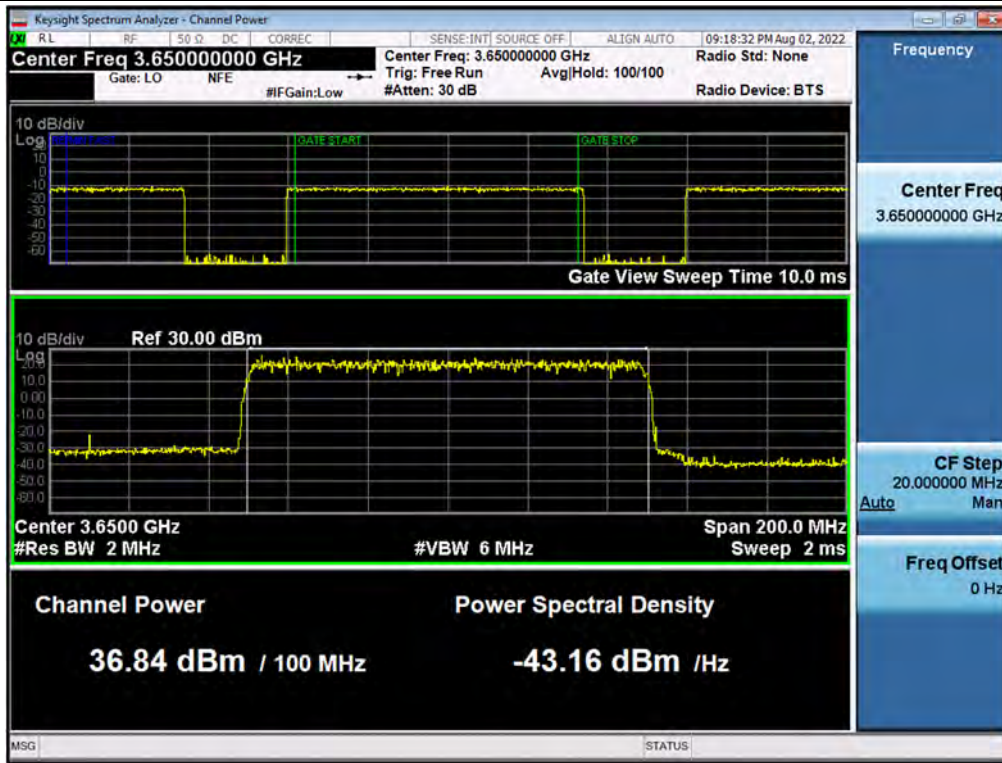

## Antenna 2 / CBRS LTE 5 MHz 1 Carrier / QPSK / Low

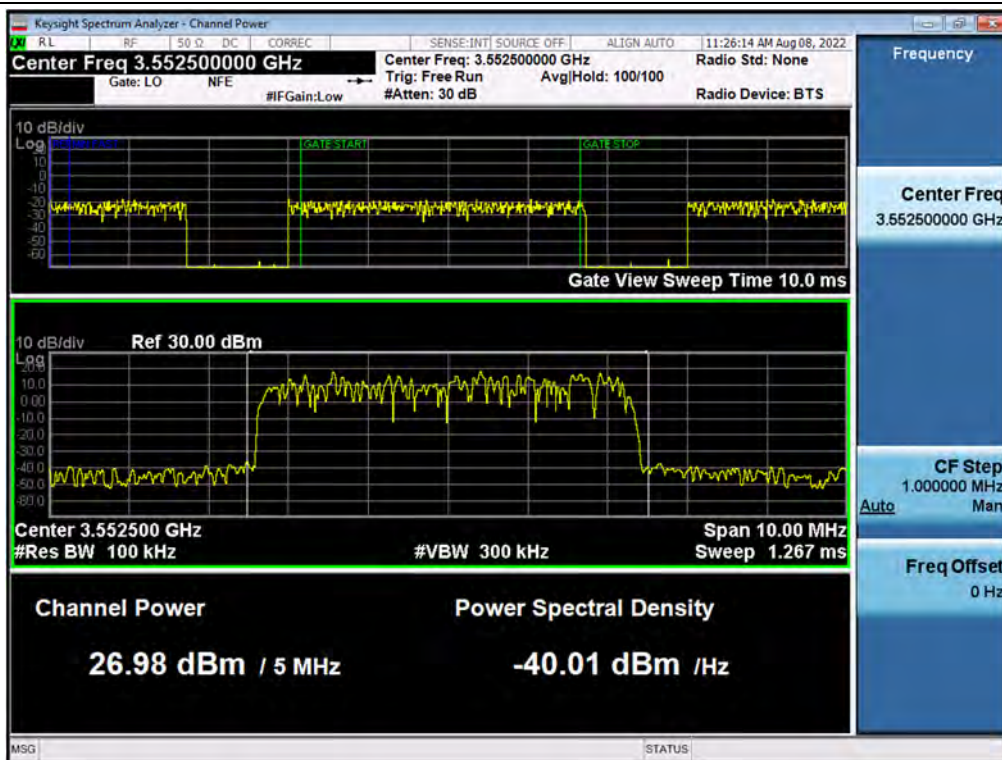

## Antenna 2 / CBRS LTE 10 MHz 1 Carrier / 64QAM / Middle

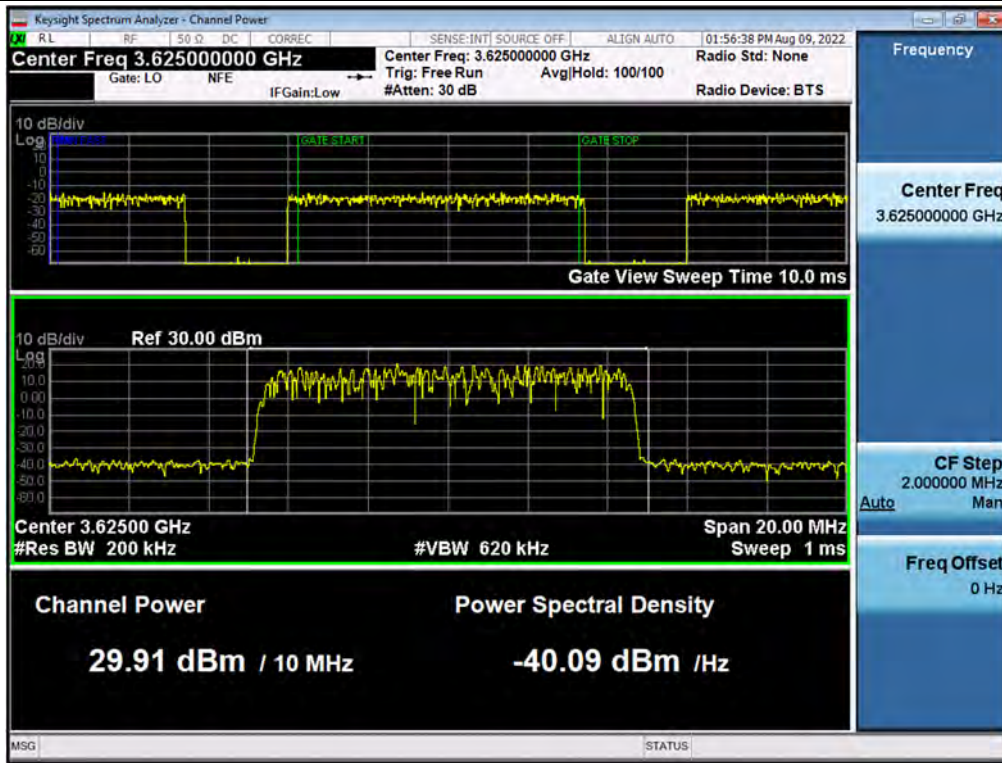

## Antenna 3 / CBRS LTE 15 MHz 1 Carrier / 256QAM / Low

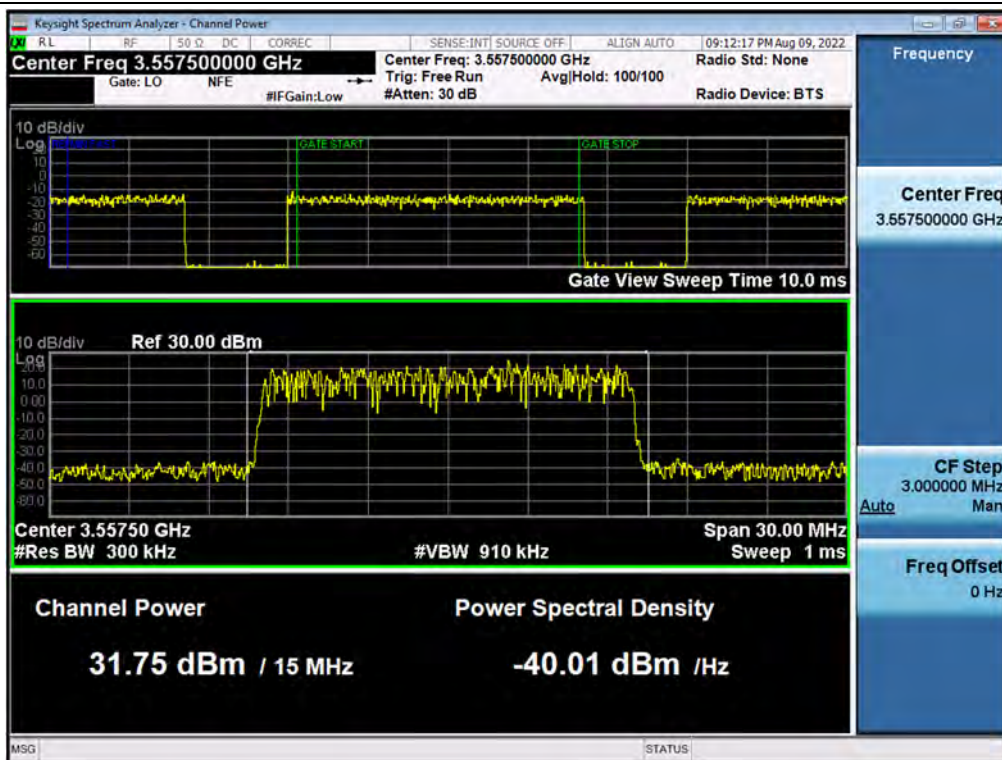

## Antenna 2 / CBRs LTE 20 MHz 1 Carrier / QPSK / Low

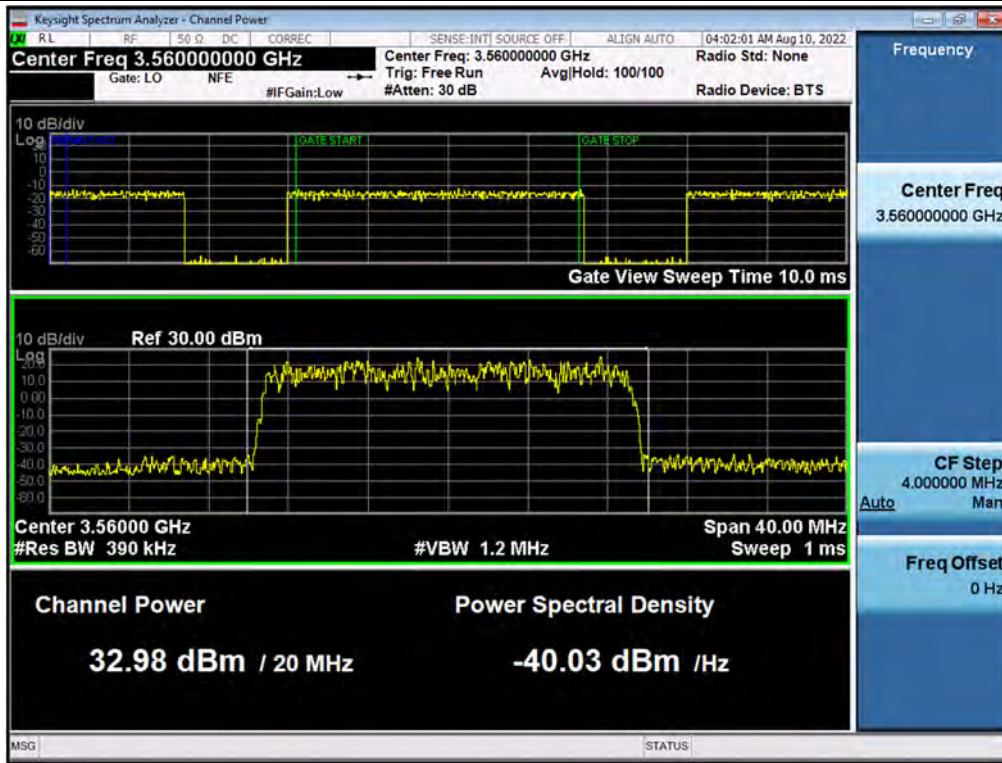

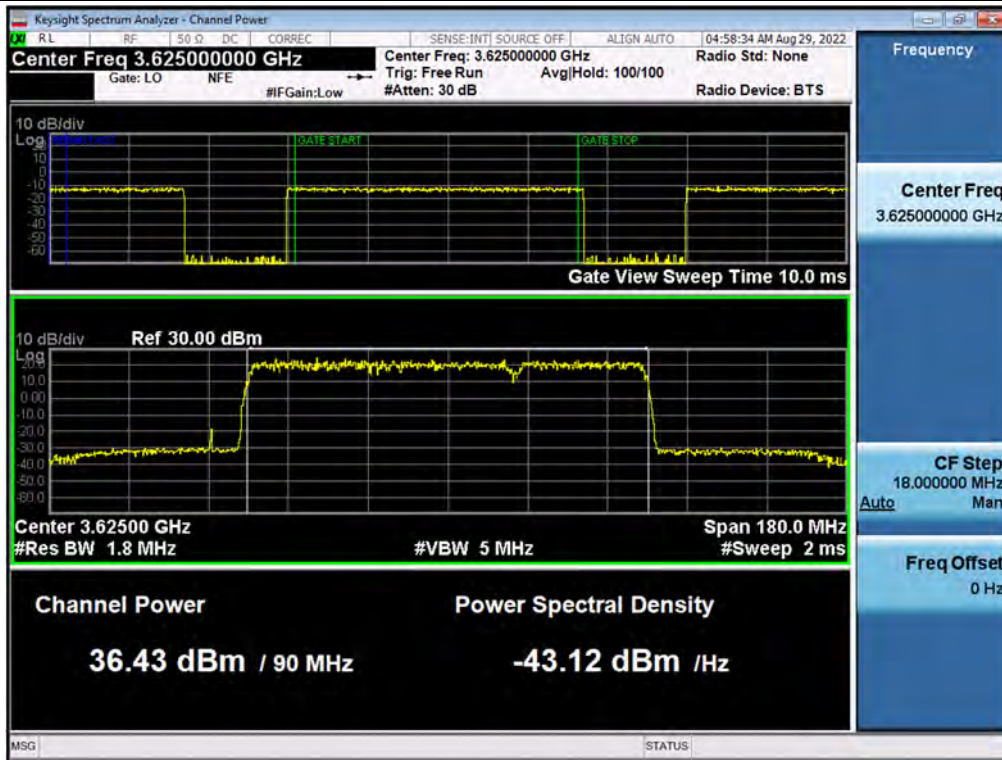
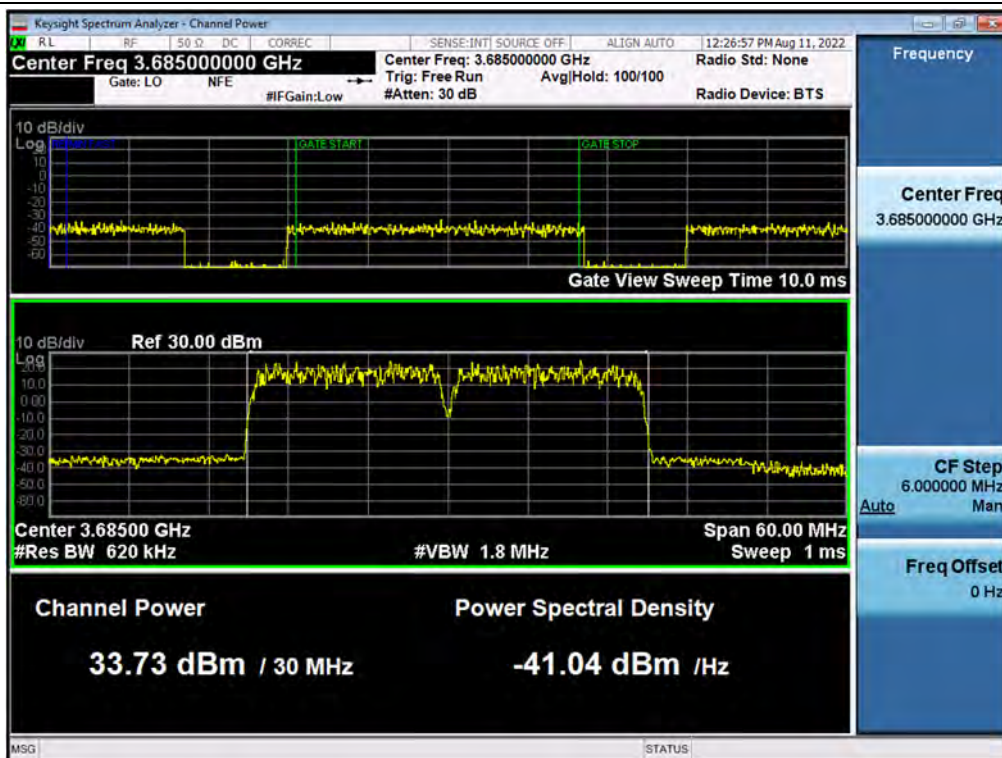

**Antenna 3 / CBRS NR(60 MHz 1C + 30 MHz 1C)[2C] / Contiguous / 64QAM / Middle**

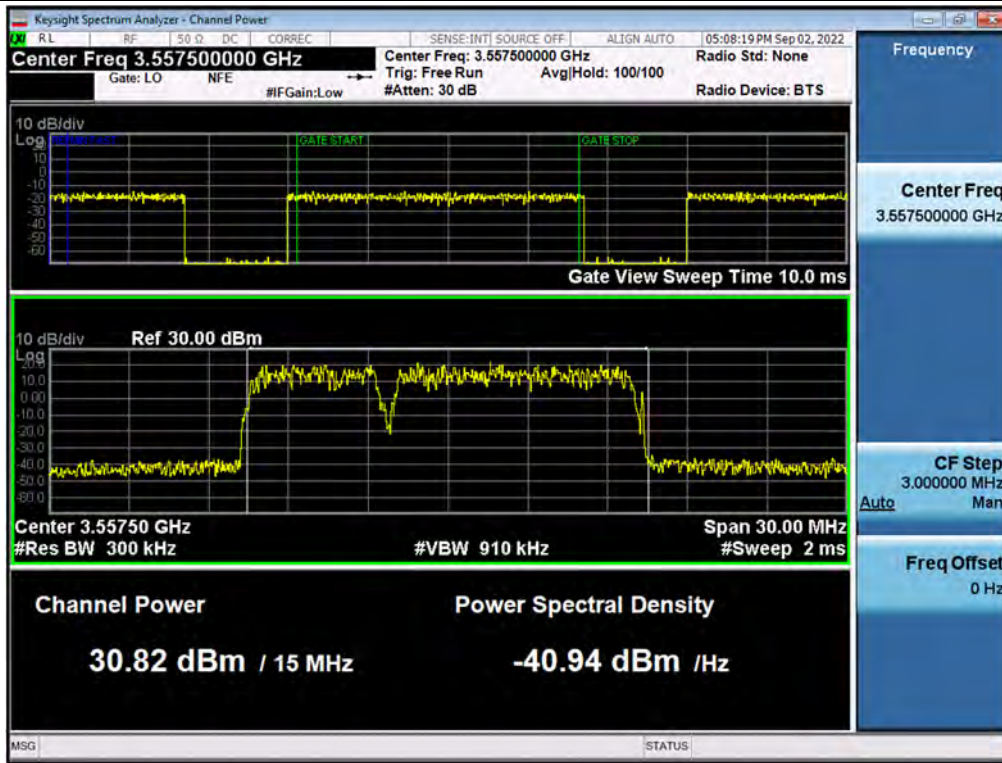
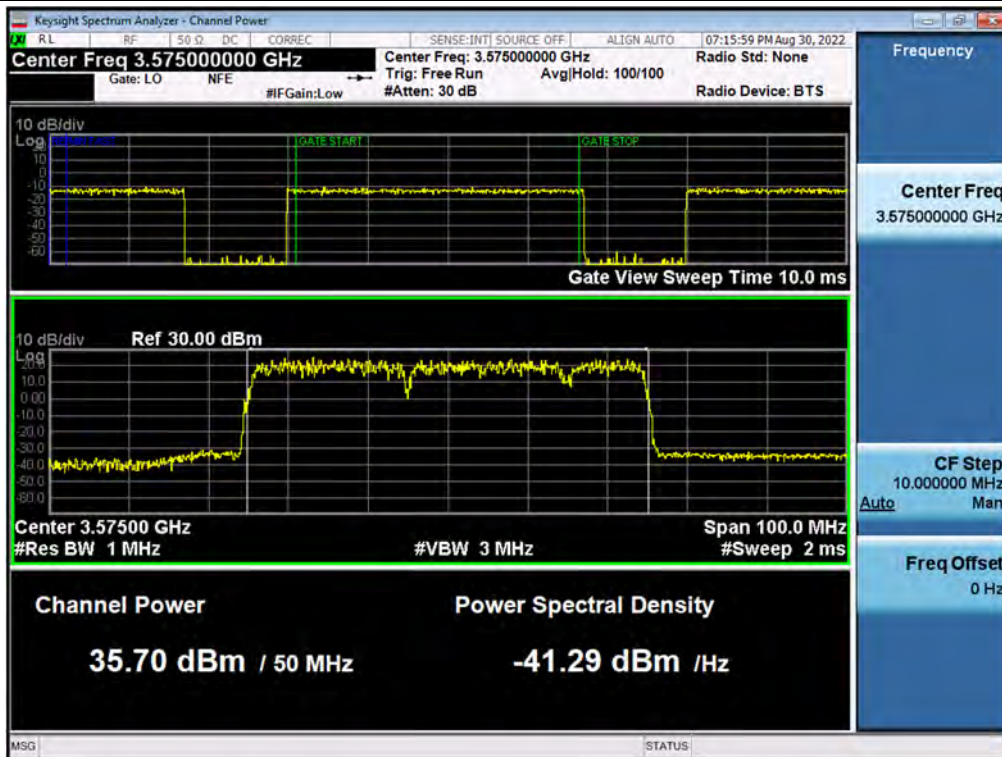
**Antenna 2 / CBRS LTE(15 MHz 1C + 15 MHz 1C)[2C] / Contiguous / 256QAM / High**

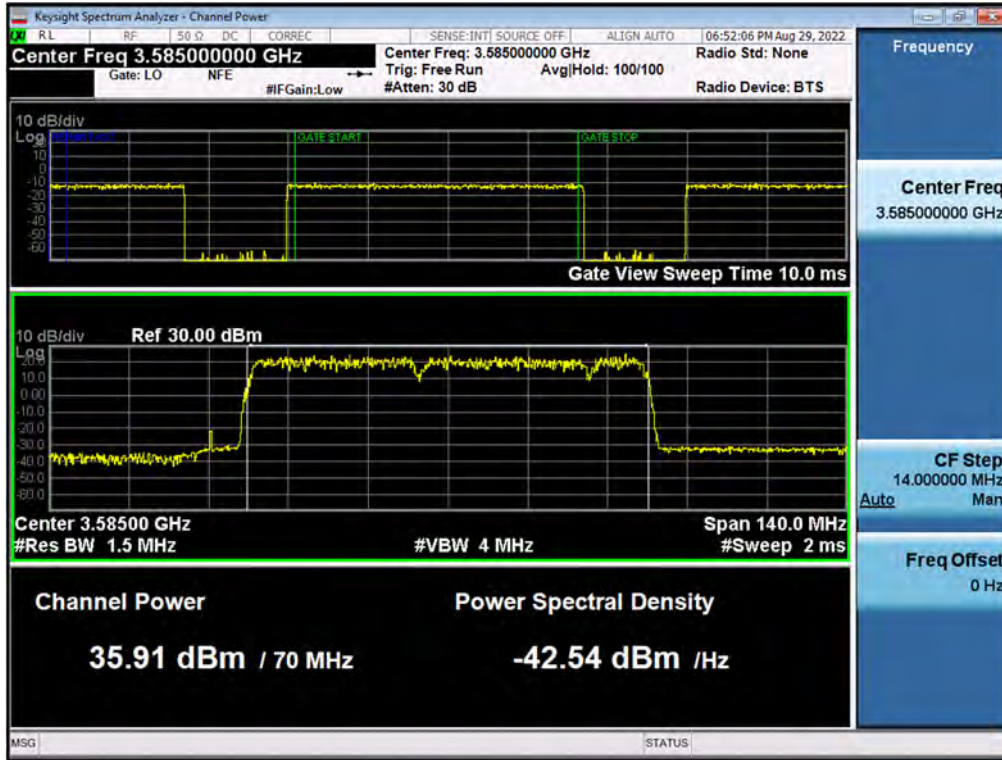
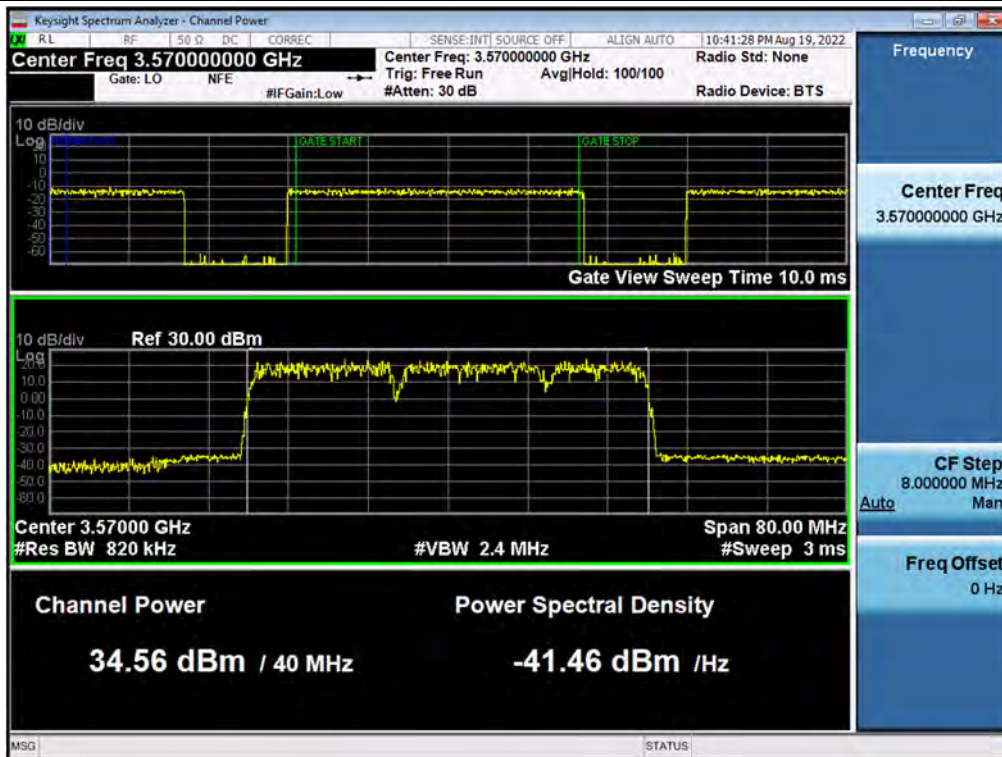
**Antenna 3 / CBRS LTE 5 MHz 1C + NR 10 MHz 1C[2C] / Contiguous / QPSK / Low**

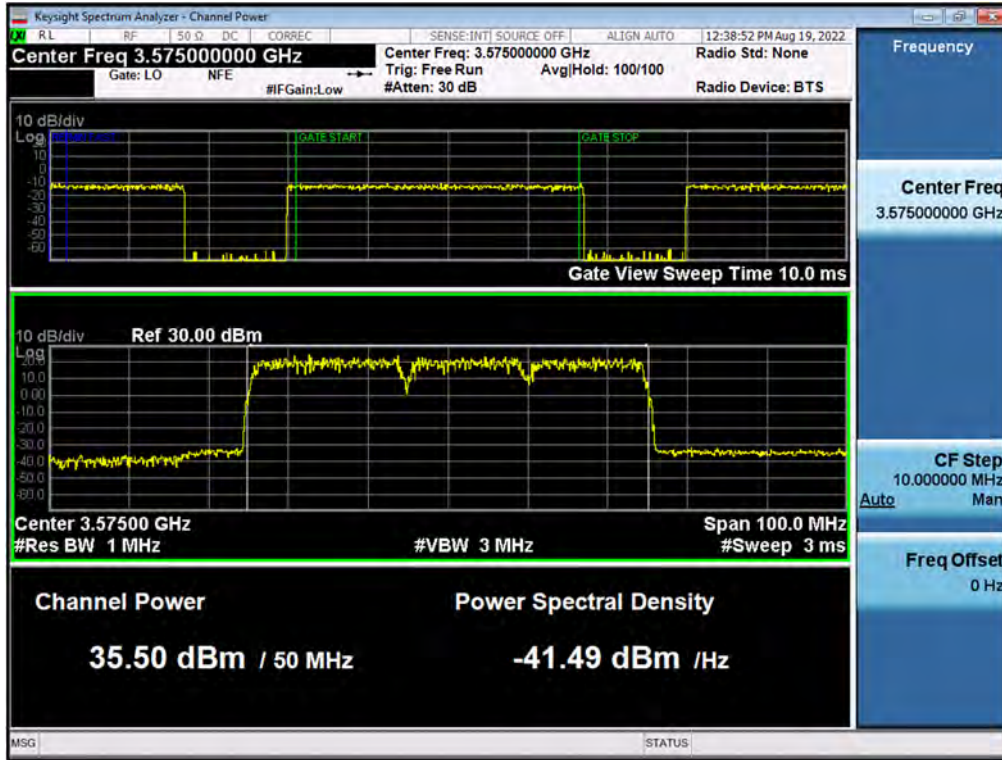
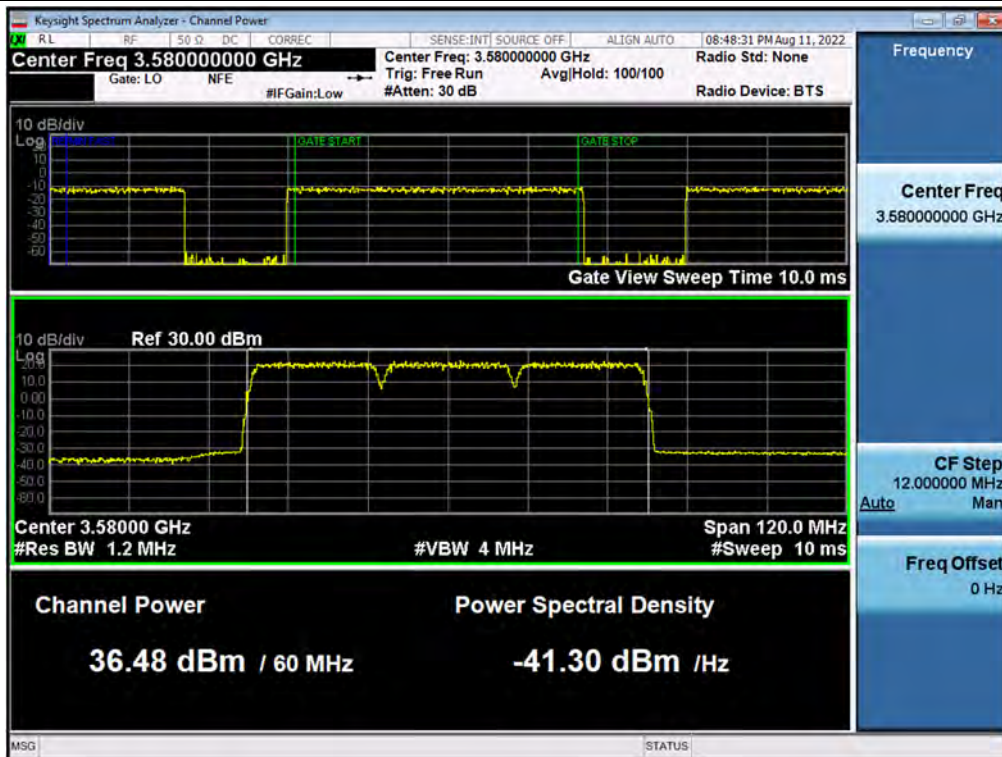
**Antenna 3 / CBRS NR(20 MHz 1C + 20 MHz 1C + 10 MHz 1C)[3C] / Contiguous / 16QAM / Low**

**Antenna 3 / CBRs NR(30 MHz 1C + 30 MHz 1C + 10 MHz 1C)[3C] / Contiguous / 16QAM / Low**

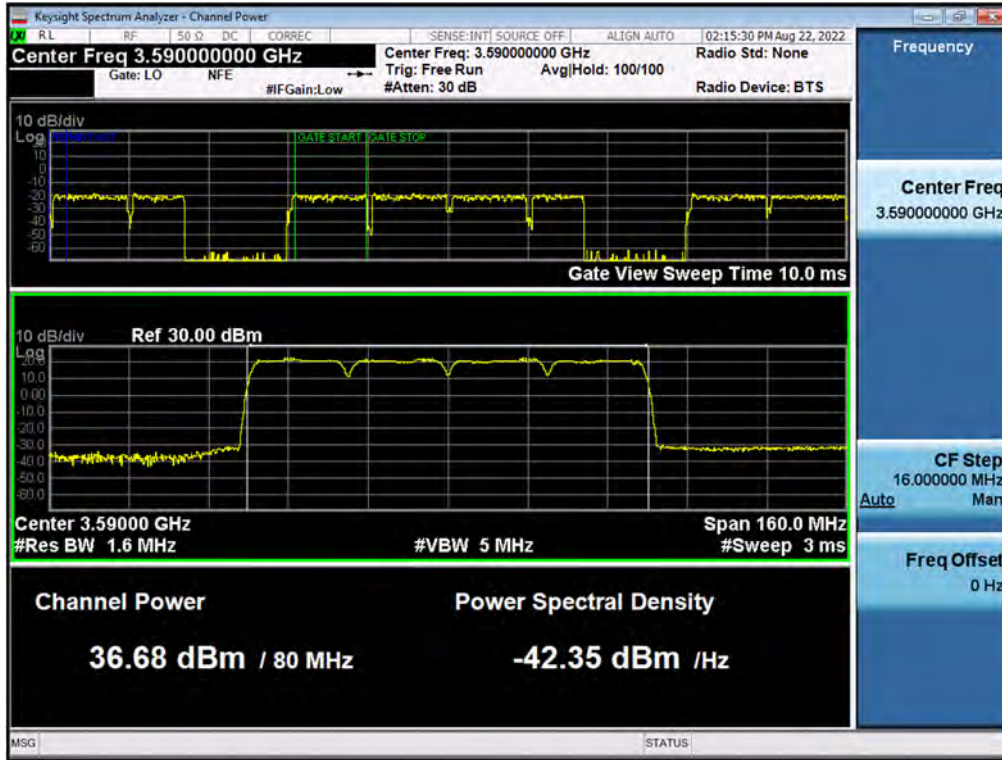
**Antenna 3 / CBRs LTE(15 MHz 1C + 15 MHz 1C + 10 MHz 1C)[3C] / Contiguous / QPSK / Low**

**Antenna 3 / CBRS LTE(20 MHz 1C + 15 MHz 1C + 15 MHz 1C)[3C] / Contiguous / 64QAM / Low**

**Antenna 3 / CBRS LTE(20 MHz 1C + 20 MHz 1C + 20 MHz 1C)[3C] / Contiguous / QPSK / Low**

Antenna 3 / CBRS LTE(20 MHz 1C + 20 MHz 1C + 20 MHz 1C + 20 MHz 1C)[4C] / Contiguous / 16QAM / Low

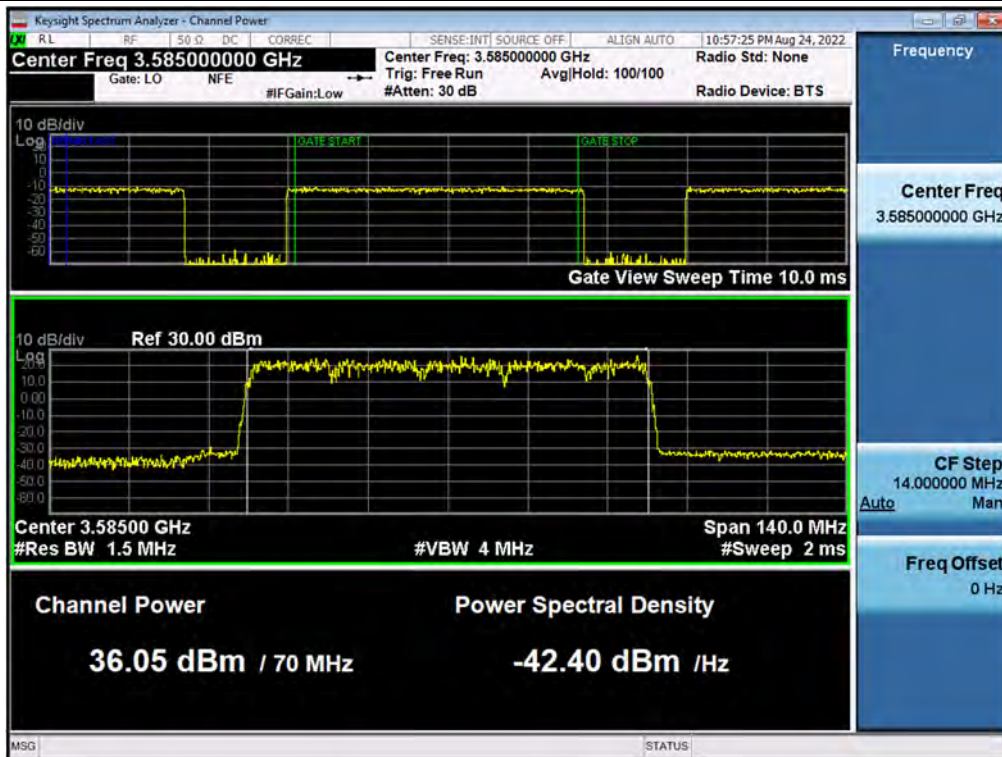

Antenna 3 / CBRS LTE(15 MHz 1C + 15 MHz 1C + 15 MHz 1C + 15 MHz 1C + 10 MHz 1C)[5C] / Contiguous / 256QAM / Low

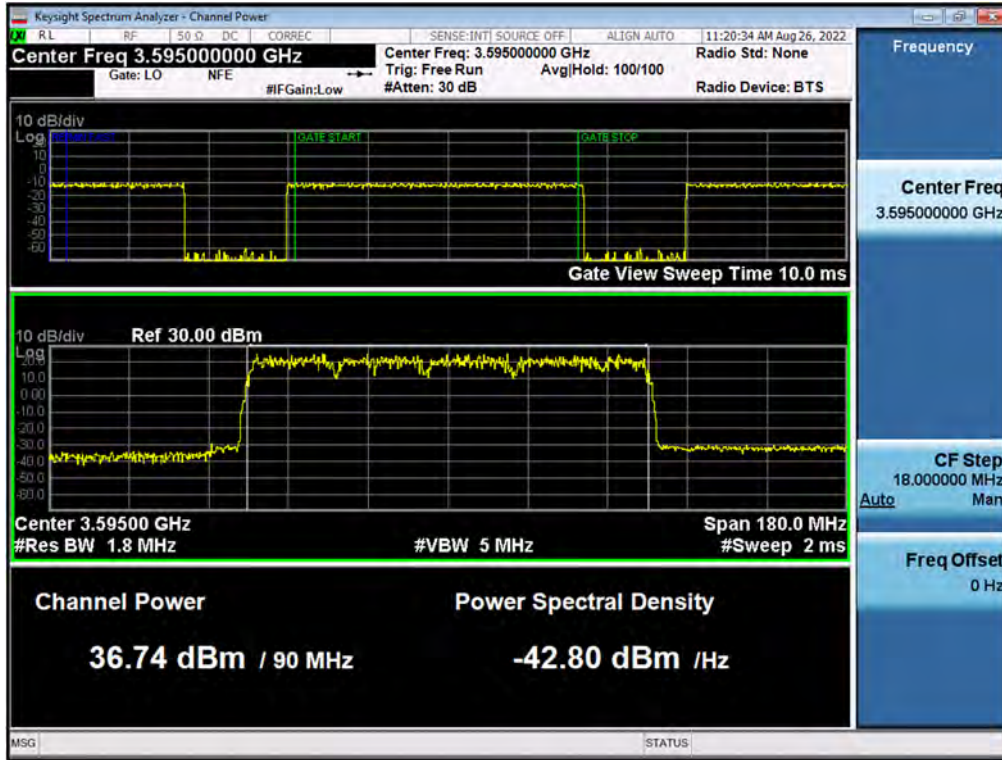
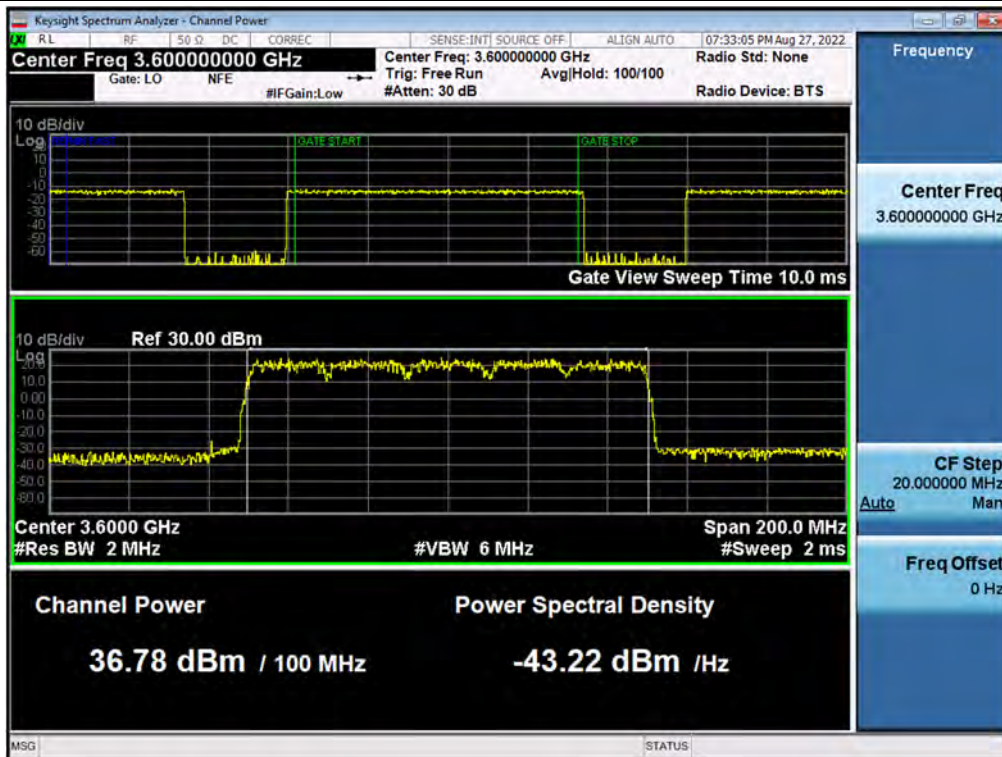

**Antenna 3 / CBRs LTE(20 MHz 1C + 20 MHz 1C + 20 MHz 1C + 20 MHz 1C + 10 MHz 1C)[5C] / Contiguous / 256QAM / Low**

**Antenna 1 / CBRs LTE(20 MHz 1C + 20 MHz 1C + 20 MHz 1C + 20 MHz 1C + 20 MHz 1C)[5C] / Contiguous / QPSK / Low**

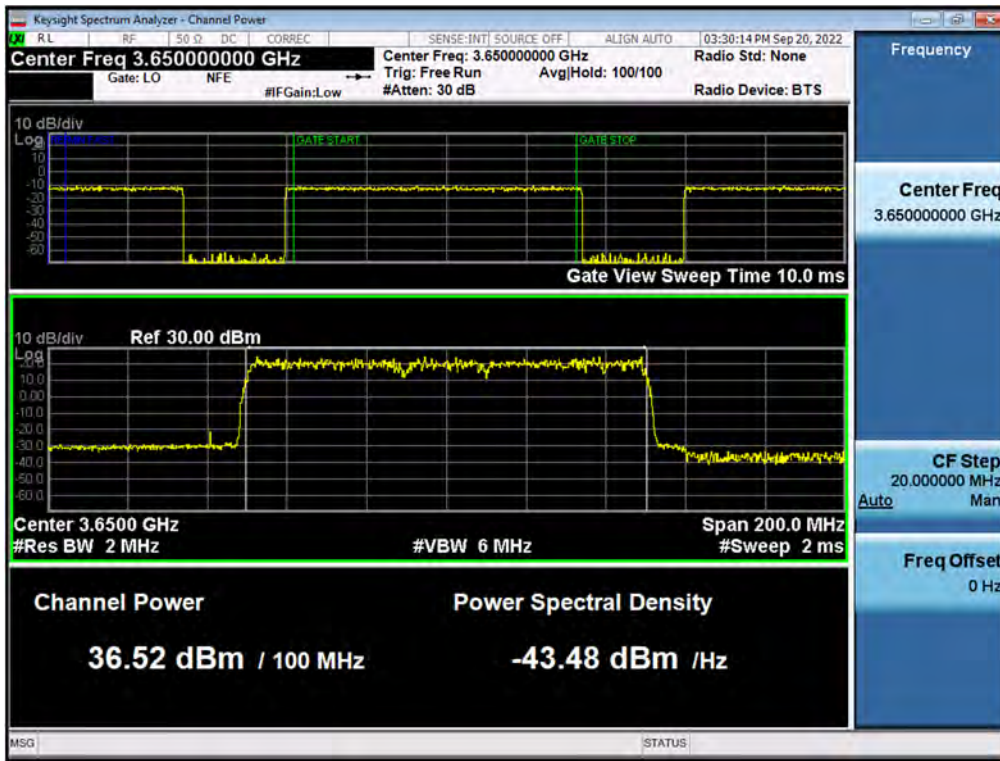
Antenna 3 / CBRS NR 40 MHz 1C + NR 20 MHz 1C + NR 20 MHz 1C + LTE 10 MHz 1C + LTE 10 MHz 1C [5C] / Contiguous / 64QAM / High

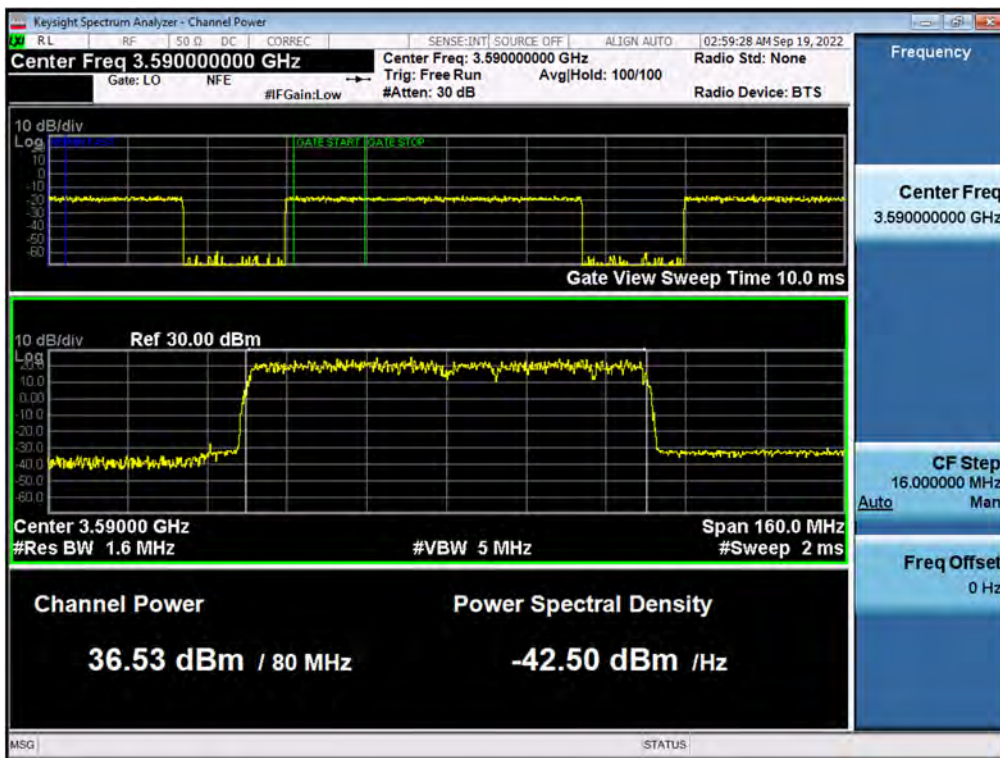

Antenna 3 / CBRS NR 40 MHz 1C + NR 10 MHz 1C + LTE 20 MHz 1C + LTE 5 MHz 1C + LTE 5 MHz 1C[5C] / Contiguous / 16QAM / Low

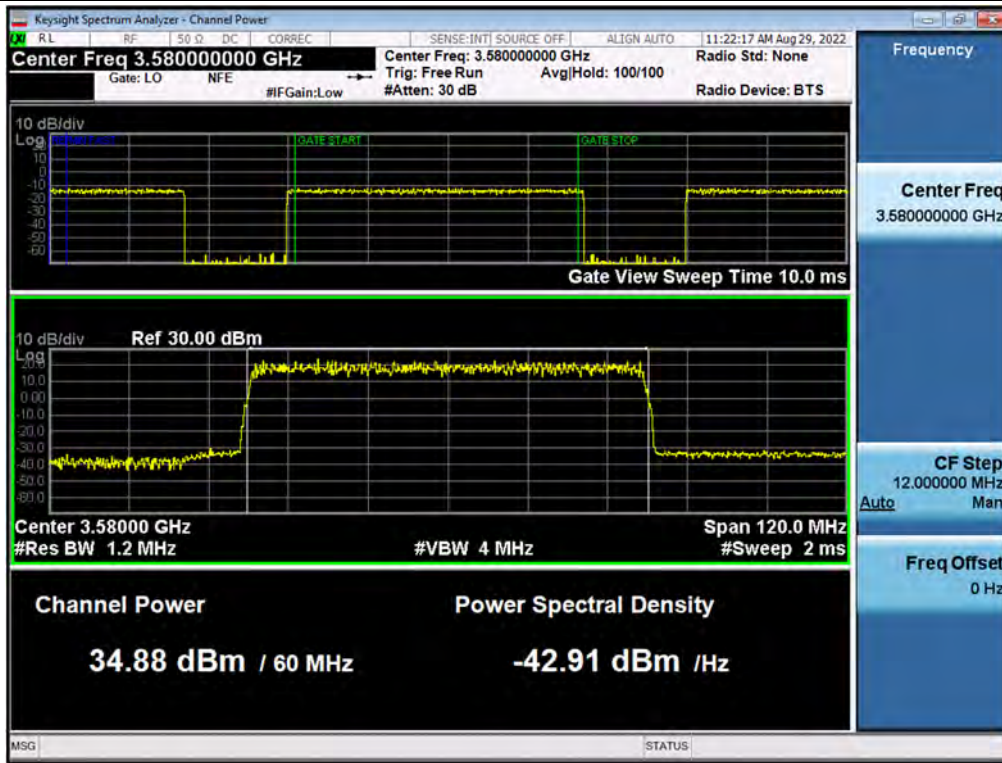
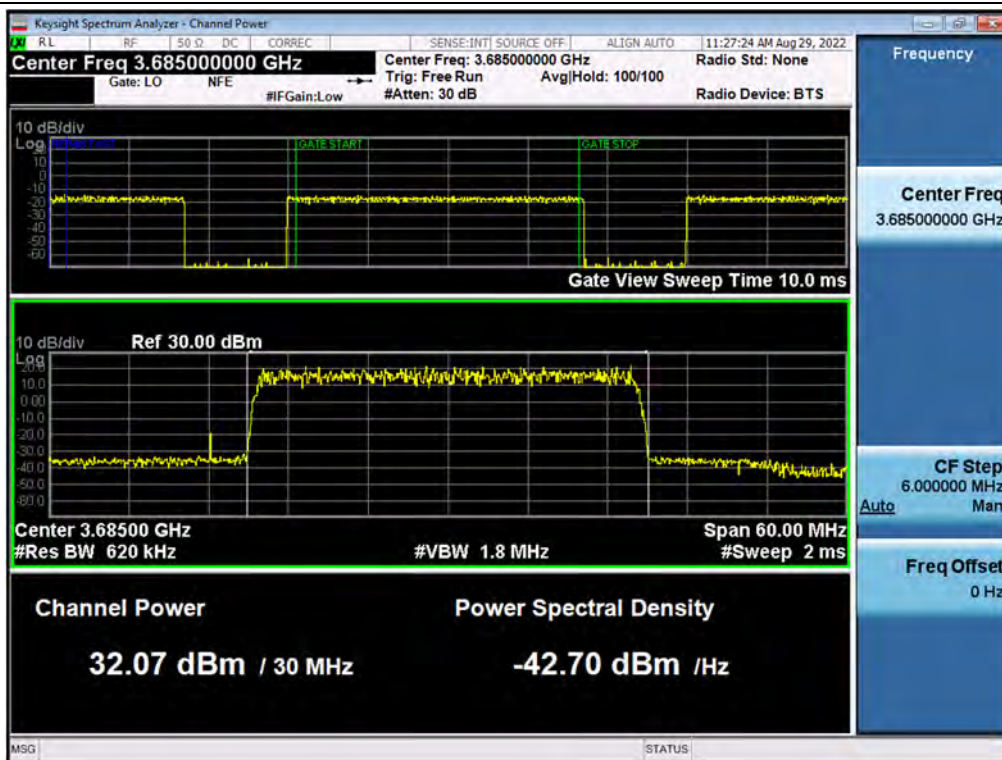

**Antenna 3 / CBRS NR(60 MHz 1C + 30 MHz 1C)[2C] / NR 60 MHz 1C / Non-Contiguous / QPSK / Low**

**Antenna 3 / CBRS NR(60 MHz 1C + 30 MHz 1C)[2C] / NR 30 MHz 1C / Non-Contiguous / QPSK / High**

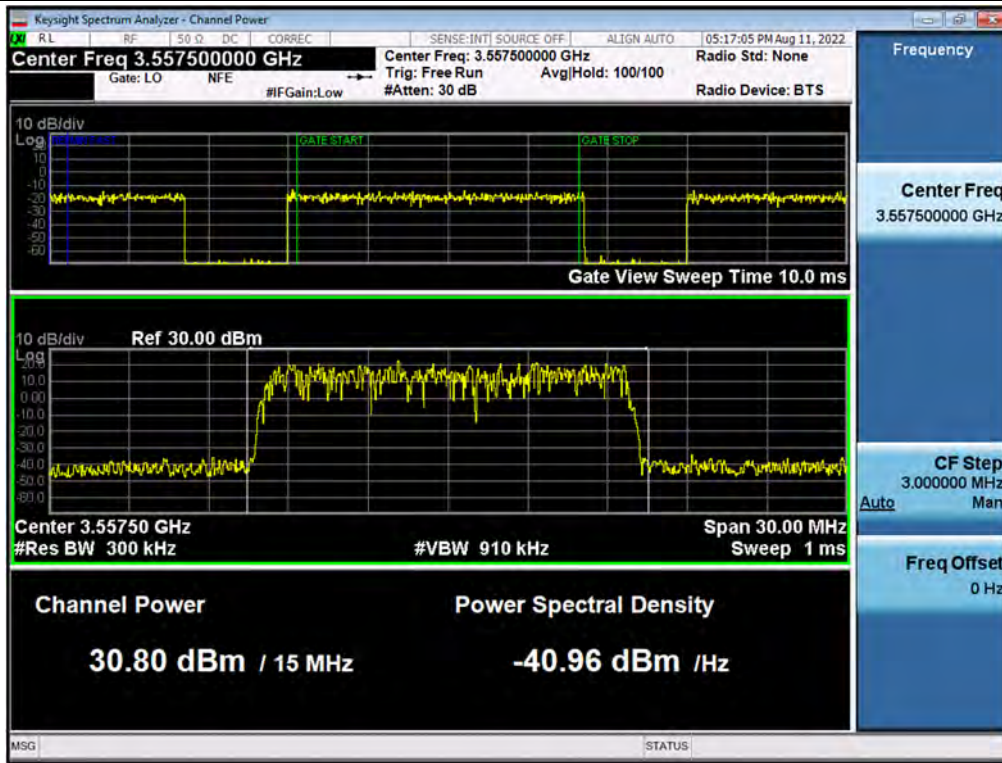
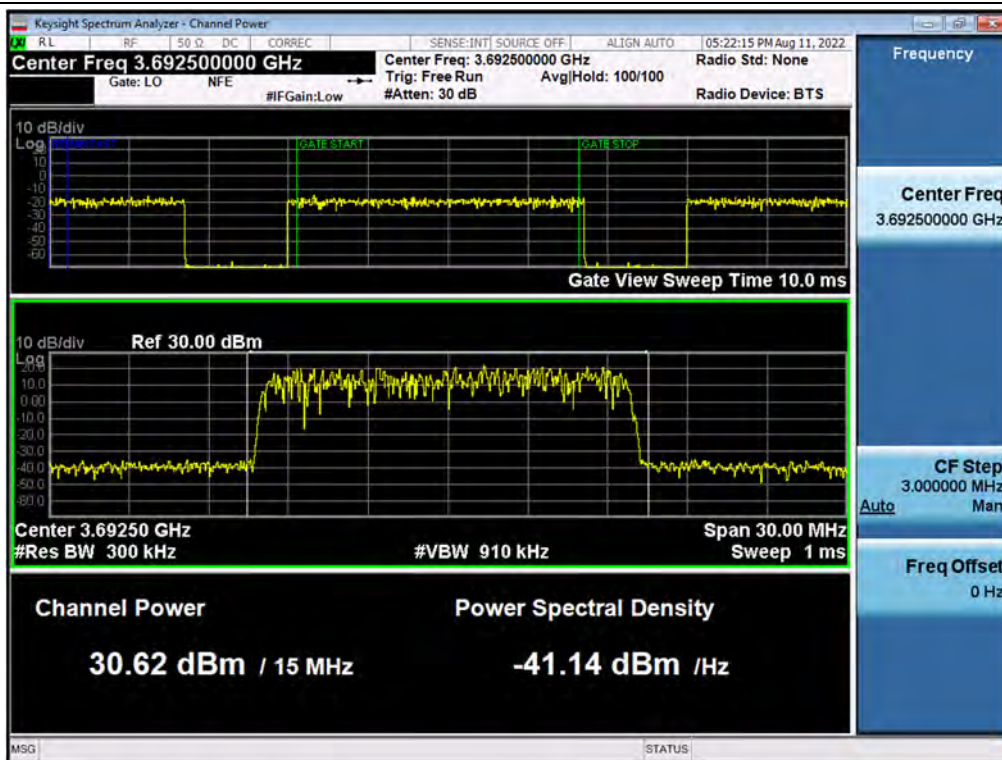

**Antenna 2 / CBRS LTE(15 MHz 1C + 15 MHz 1C)[2C] / LTE 15 MHz 1C / Non-Contiguous / 64QAM / Low**

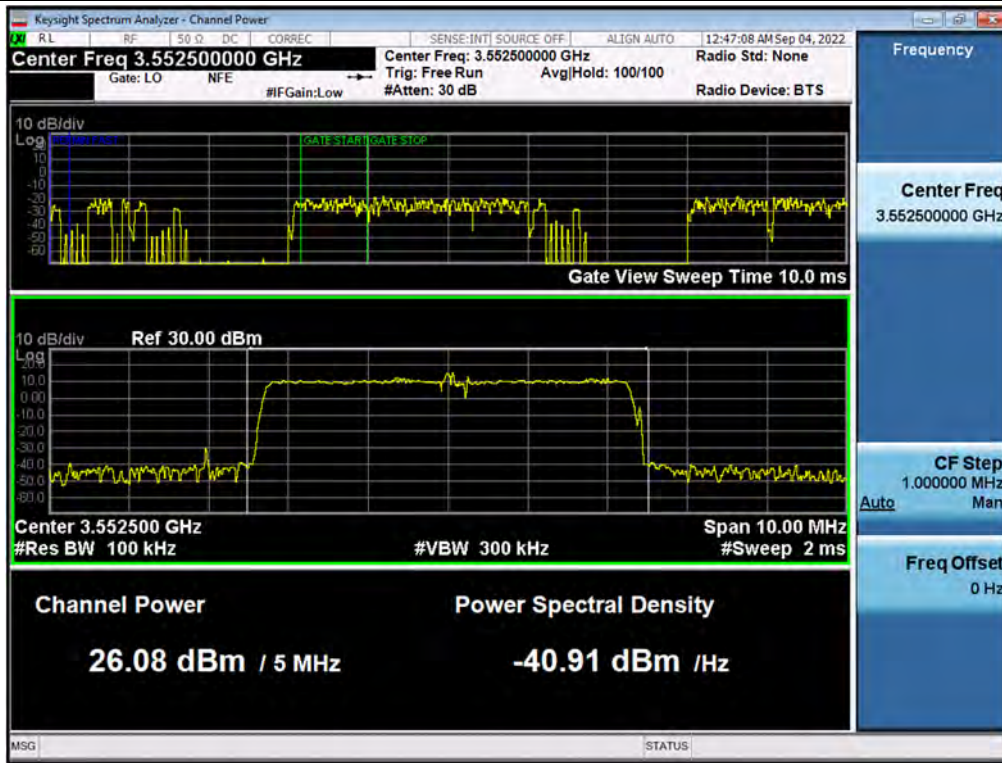
**Antenna 2 / CBRS LTE(15 MHz 1C + 15 MHz 1C)[2C] / LTE 15 MHz 1C / Non-Contiguous / 64QAM / High**

Antenna 3 / CBRS LTE 5 MHz 1C + NR 10 MHz 1C[2C] / LTE 5 MHz 1C / Non-Contiguous / 16QAM / Low

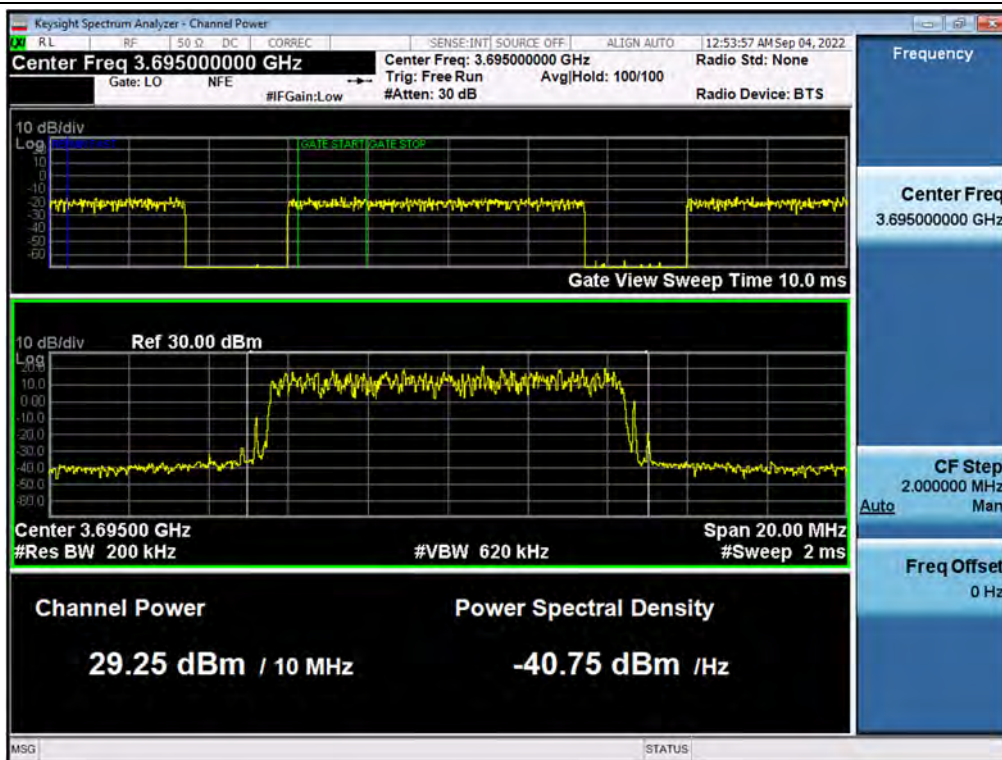

Antenna 3 / CBRS LTE 5 MHz 1C + NR 10 MHz 1C[2C] / NR 10 MHz 1C / Non-Contiguous / 16QAM / High



Antenna 3 / CBRS NR[20 MHz 1C + (20 MHz 1C + 10 MHz 1C)][3C(1C+2C)] / NR 20 MHz 1C / Non-Contiguous / 16QAM / Low

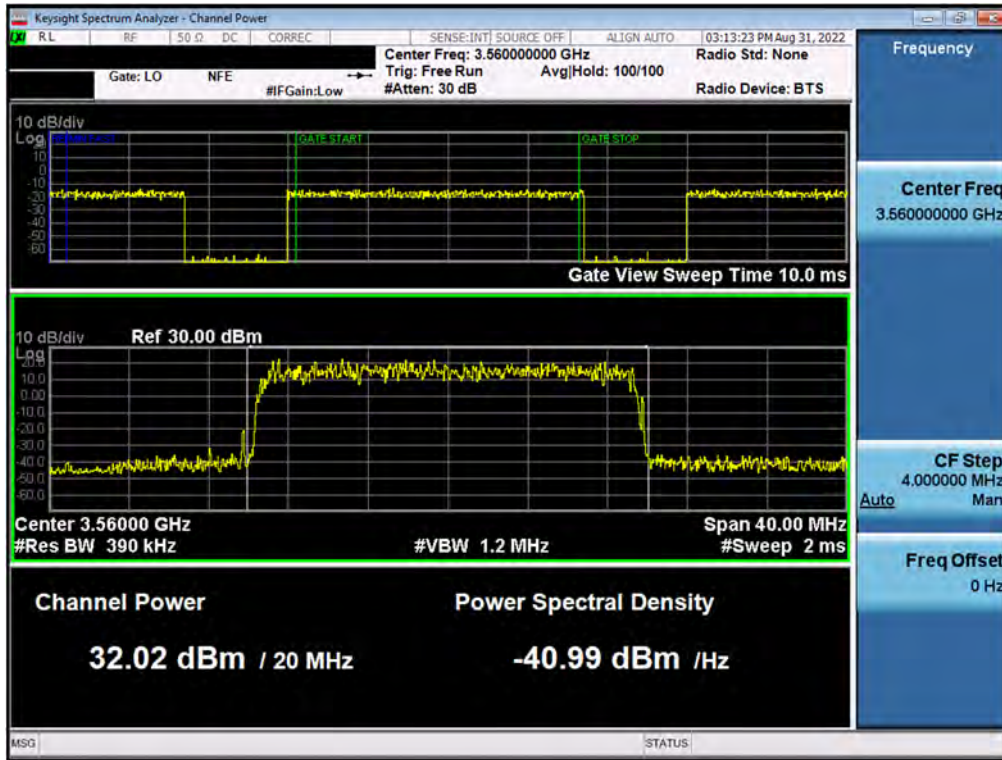

Antenna 3 / CBRS NR[20 MHz 1C + (20 MHz 1C + 10 MHz 1C)][3C(1C+2C)] / NR 20 MHz 1C + NR 10 MHz 1C / Non-Contiguous / 16QAM / High

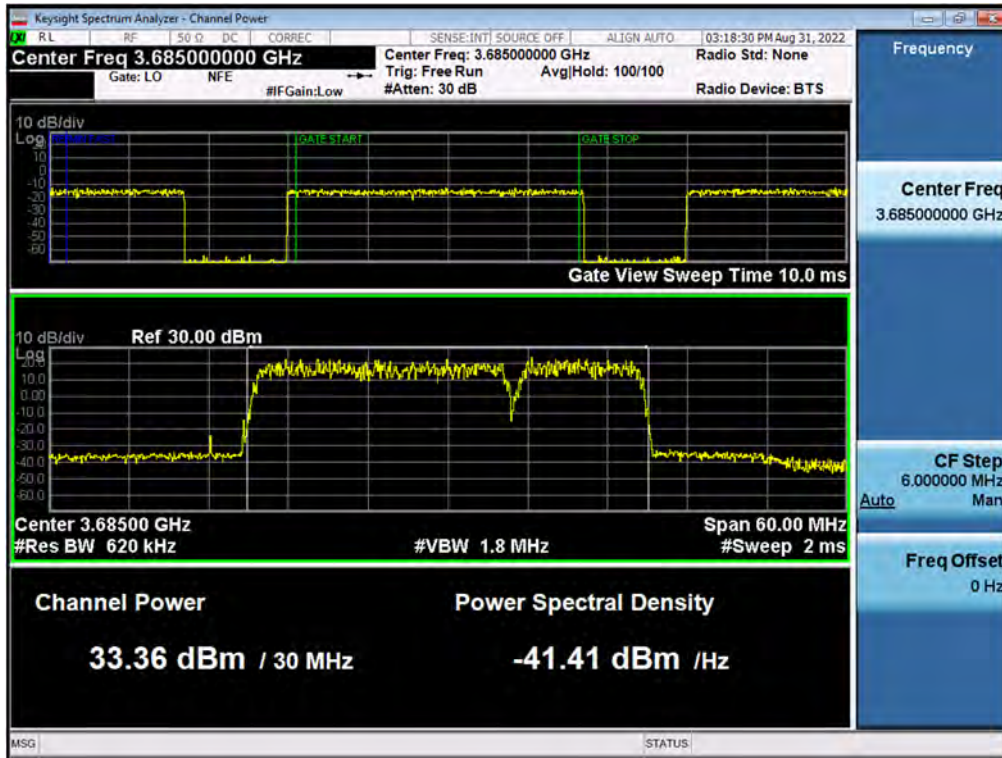

Antenna 3 / CBRS NR[(20 MHz 1C + 20 MHz 1C) + 10 MHz 1C][3C(2C+1C)] / NR 20 MHz 1C + NR 20 MHz 1C / Non-Contiguous / 256QAM / Low

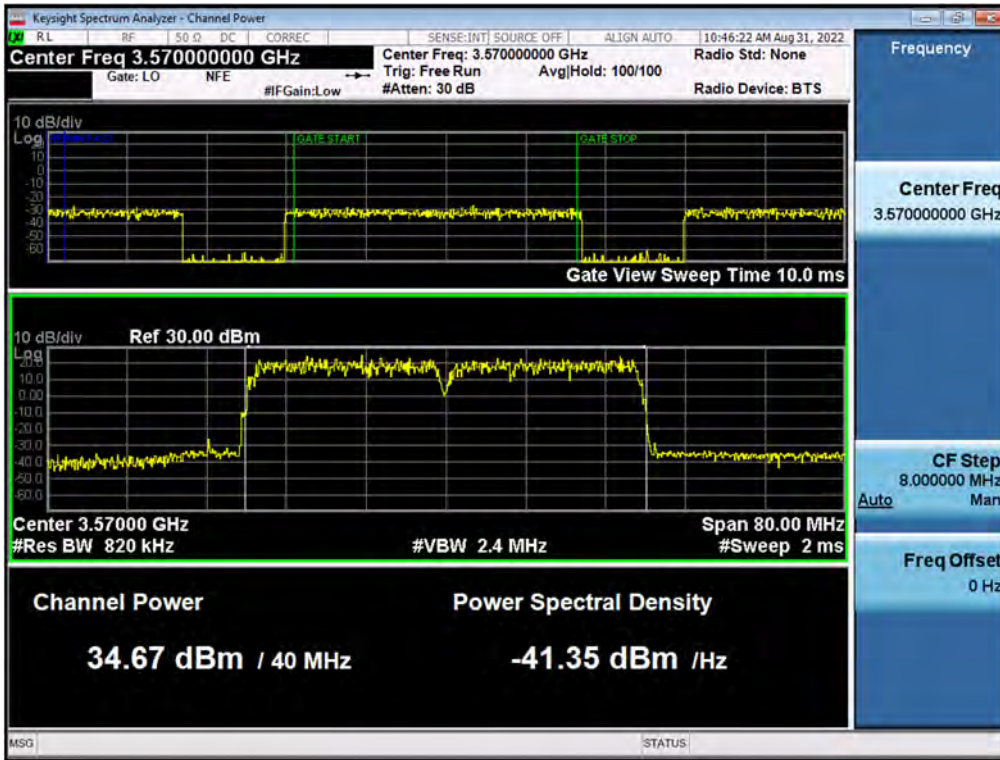

Antenna 3 / CBRS NR[(20 MHz 1C + 20 MHz 1C) + 10 MHz 1C][3C(2C+1C)] / NR 10 MHz 1C / Non-Contiguous / 256QAM / High

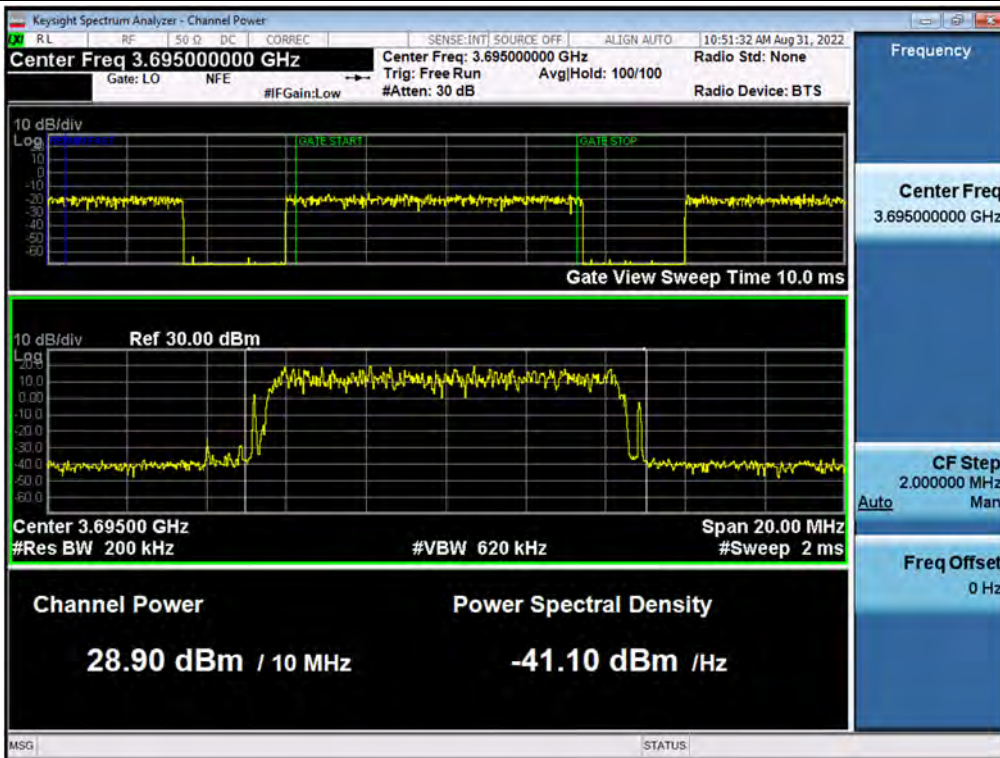

Antenna 3 / CBRS NR[30 MHz 1C + (30 MHz 1C + 10 MHz 1C)][3C(1C+2C)] / NR 30 MHz 1C / Non-Contiguous / QPSK / Low

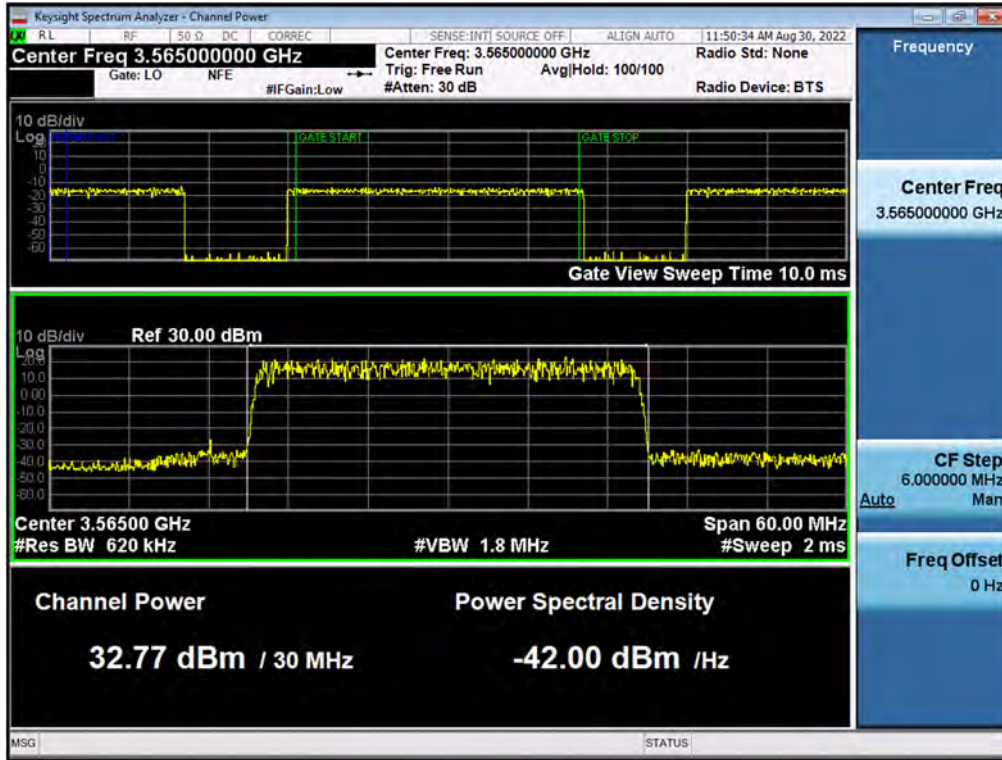

Antenna 3 / CBRS NR[30 MHz 1C + (30 MHz 1C + 10 MHz 1C)][3C(1C+2C)] / NR 30 MHz 1C + NR 10 MHz 1C / Non-Contiguous / QPSK / High

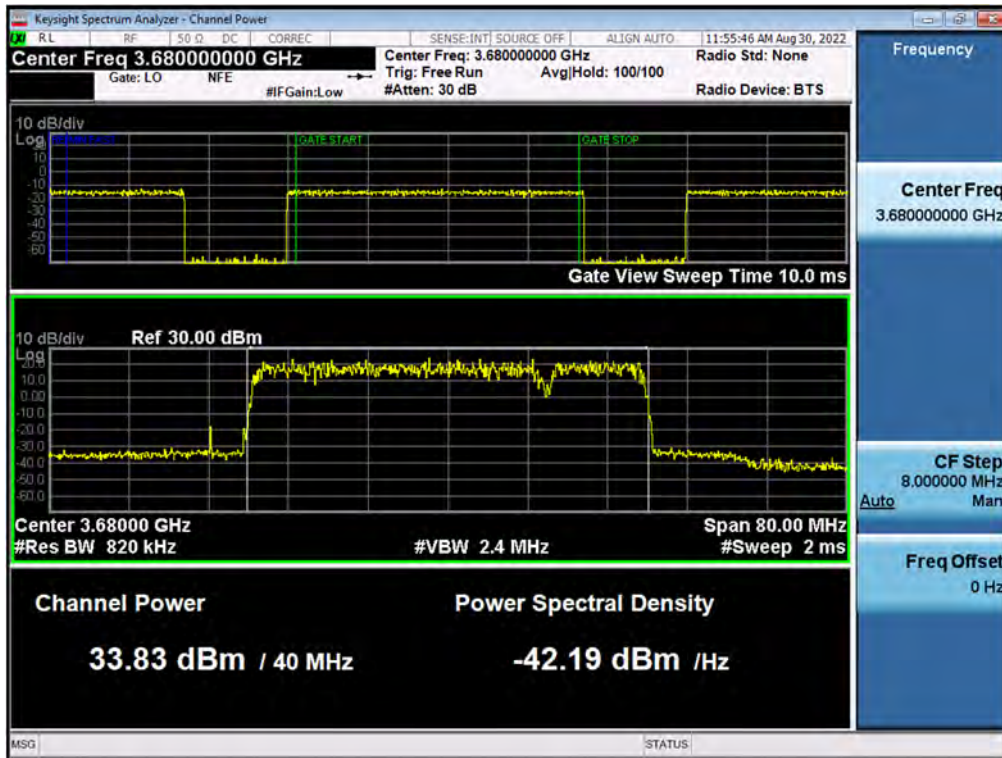

Antenna 3 / CBRS NR[(30 MHz 1C + 30 MHz 1C) + 10 MHz 1C][3C(2C+1C)] / NR 30 MHz 1C + NR 30 MHz 1C / Non-Contiguous / QPSK / Low

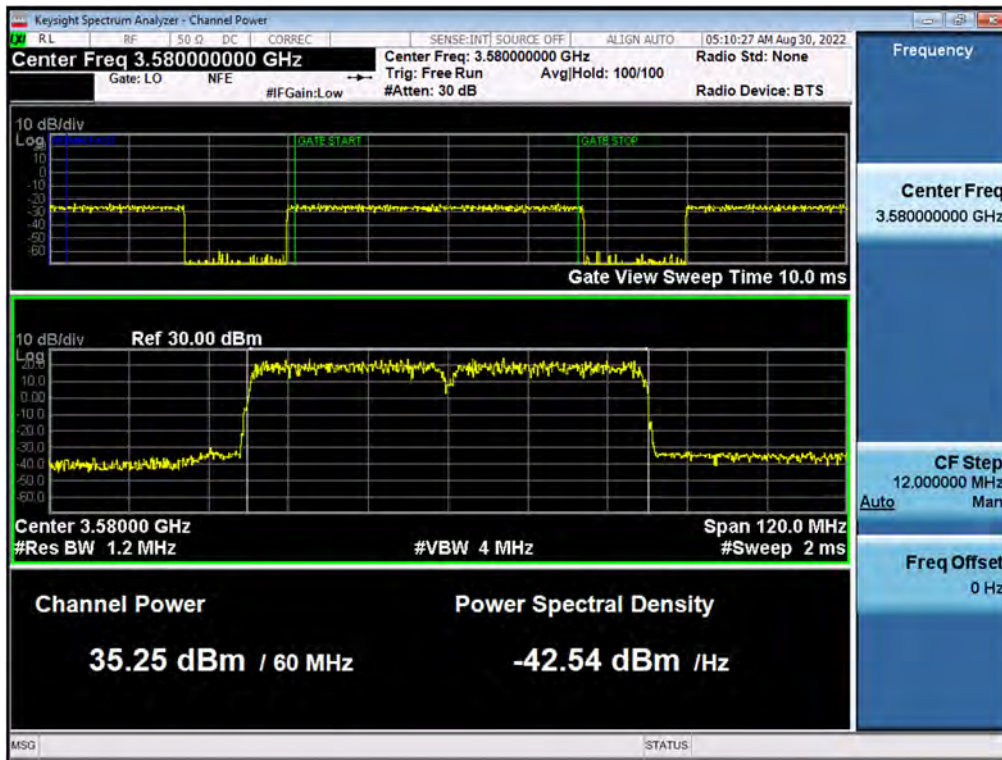

Antenna 3 / CBRS NR[(30 MHz 1C + 30 MHz 1C) + 10 MHz 1C][3C(2C+1C)] / NR 10 MHz 1C / Non-Contiguous / QPSK / High

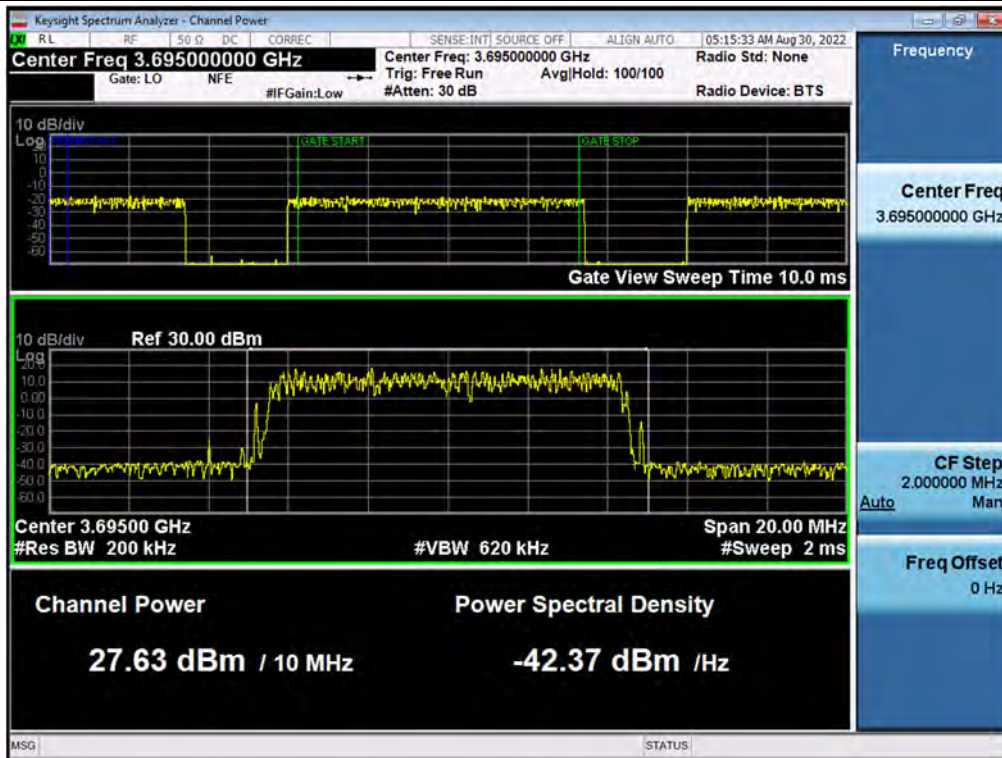

Antenna 3 / CBRS LTE[15 MHz 1C + (15 MHz 1C + 10 MHz 1C)][3C(1C+2C)] / LTE 15 MHz 1C / Non-Contiguous / 256QAM / Low

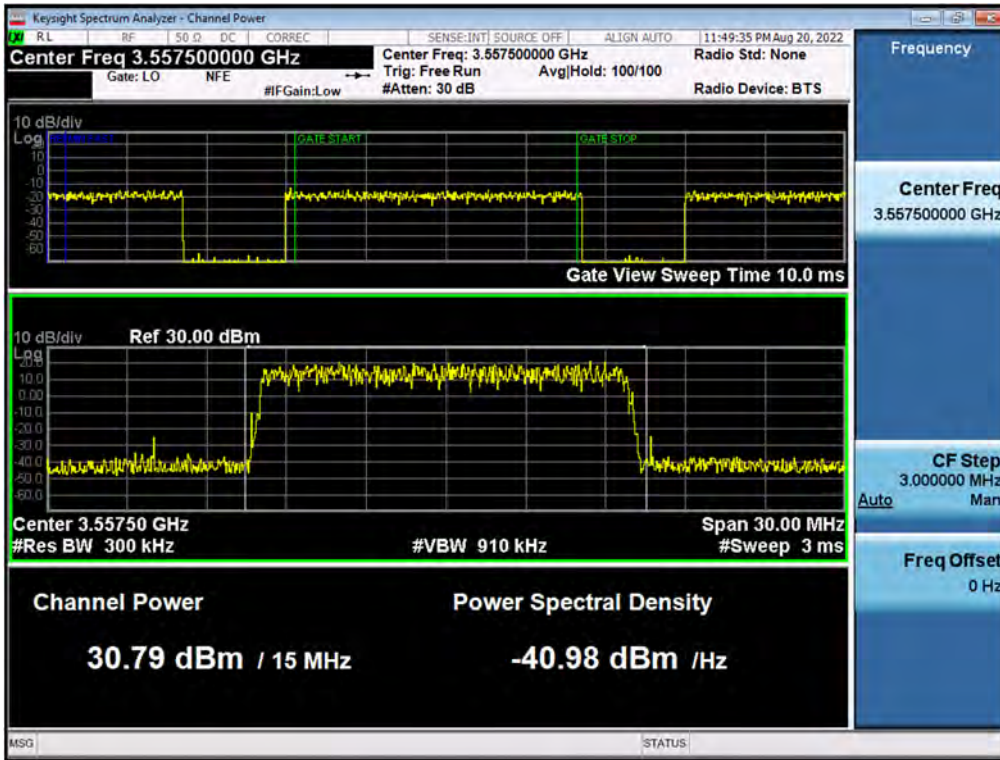

Antenna 3 / CBRS LTE[15 MHz 1C + (15 MHz 1C + 10 MHz 1C)][3C(1C+2C)] / LTE 15 MHz 1C + LTE 10 MHz 1C / Non-Contiguous / 256QAM / High

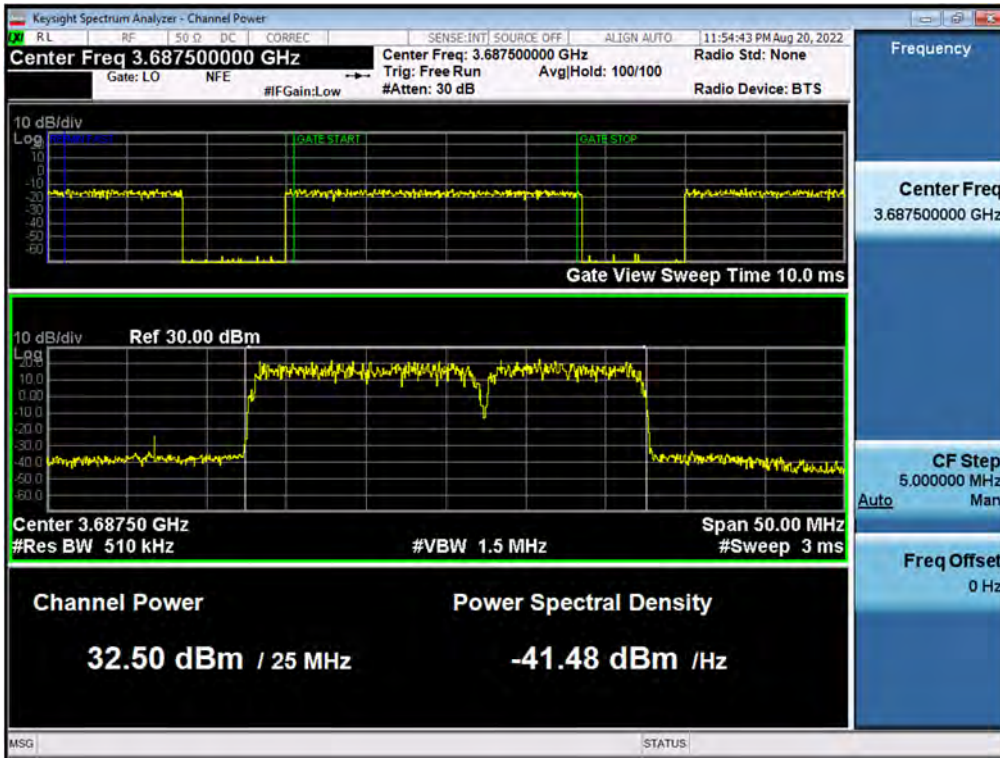

Antenna 3 / CBRS LTE[(15 MHz 1C + 15 MHz 1C) + 10 MHz 1C][3C(2C+1C)] / LTE 15 MHz 1C + LTE 15 MHz 1C / Non-Contiguous / 16QAM / Low

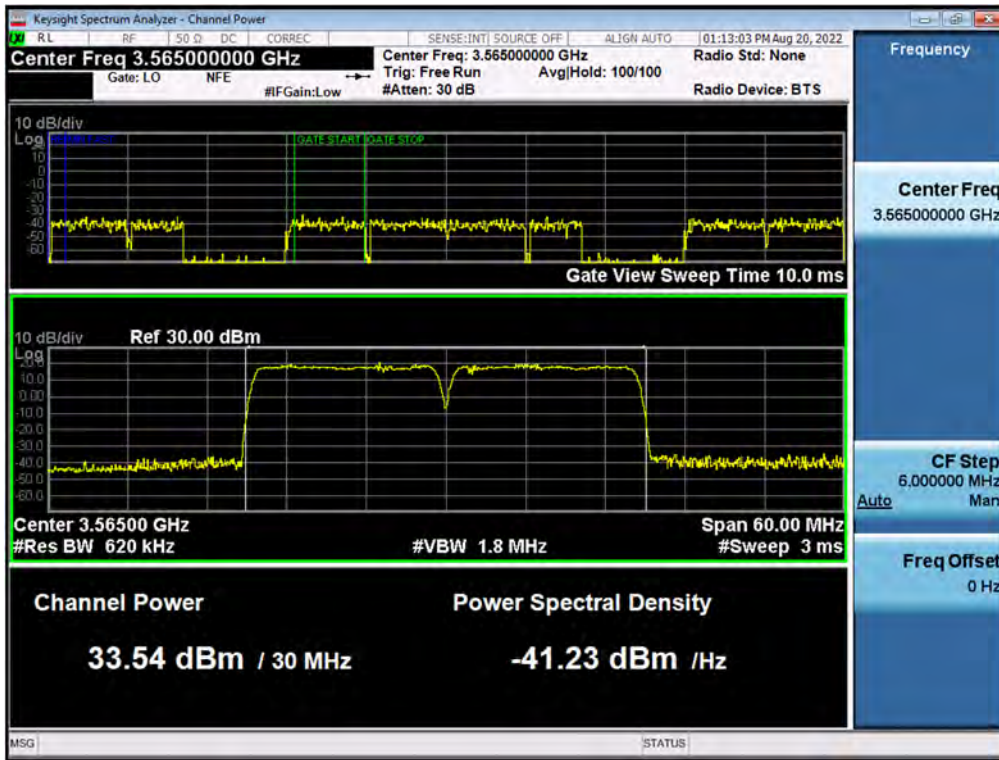

Antenna 3 / CBRS LTE[(15 MHz 1C + 15 MHz 1C) + 10 MHz 1C][3C(2C+1C)] / LTE 10 MHz 1C / Non-Contiguous / 16QAM / High

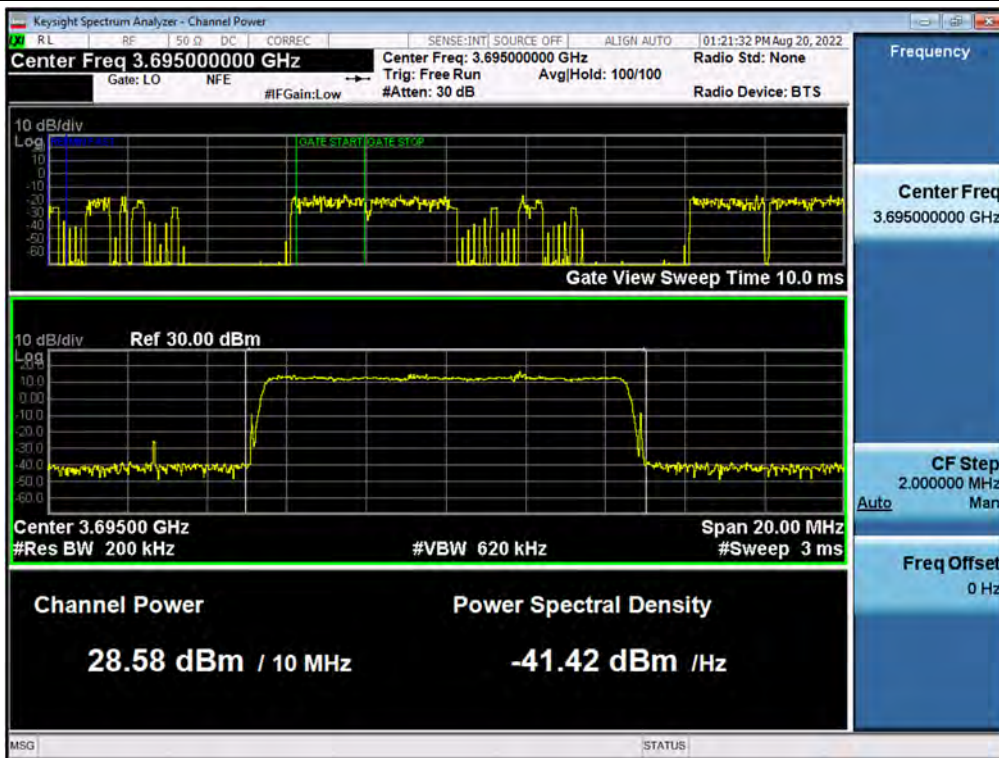



Antenna 3 / CBRS LTE[20 MHz 1C + (15 MHz 1C + 15 MHz 1C)][3C(1C+2C)] / LTE 20 MHz 1C / Non-Contiguous / 256QAM / Low

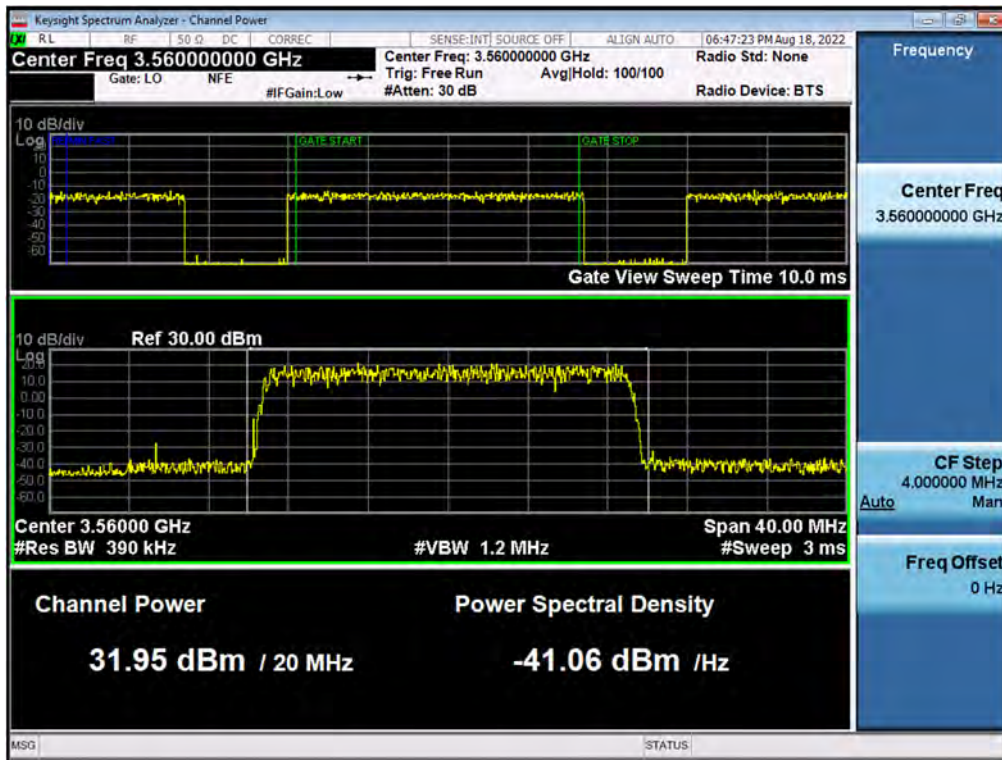

Antenna 3 / CBRS LTE[20 MHz 1C + (15 MHz 1C + 15 MHz 1C)][3C(1C+2C)] / LTE 15 MHz 1C + LTE 15 MHz 1C / Non-Contiguous / 256QAM / High

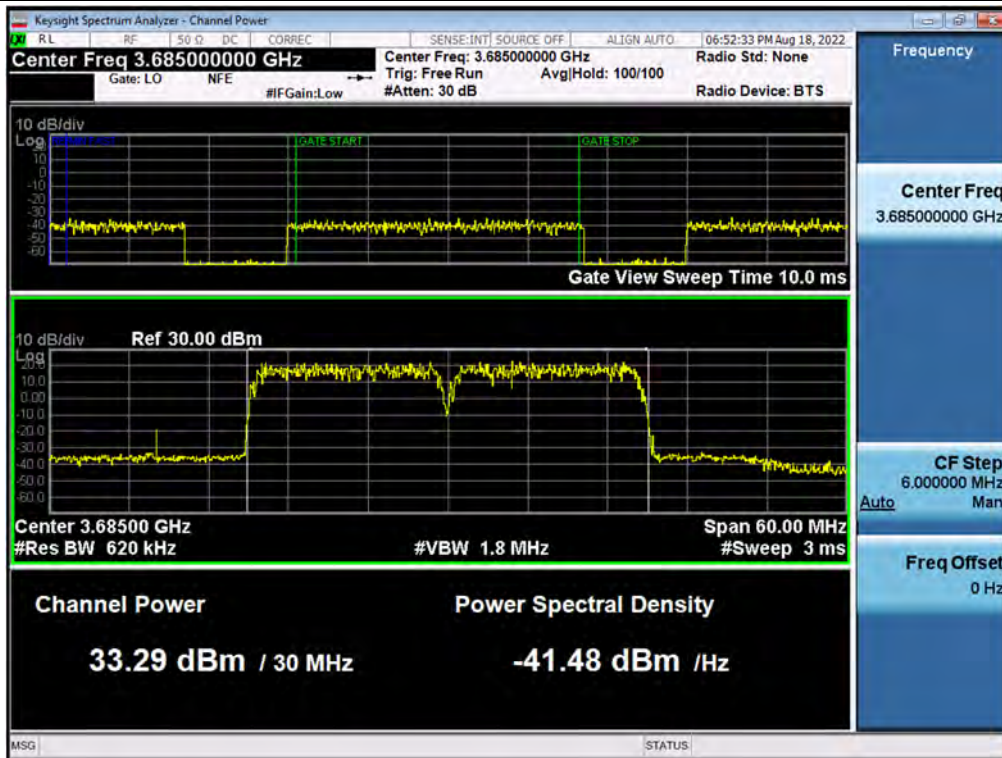

Antenna 3 / CBRS LTE[(20 MHz 1C + 15 MHz 1C) + 15 MHz 1C][3C(2C+1C)] / LTE 20 MHz 1C + LTE 15 MHz 1C / Non-Contiguous / QPSK / Low

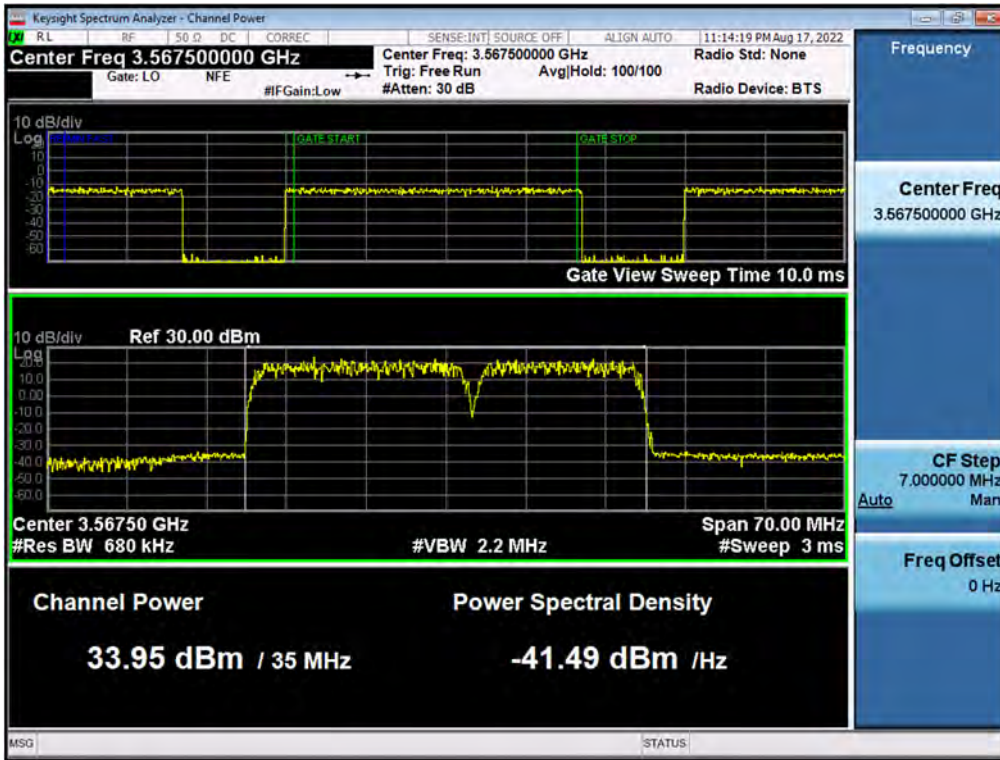

Antenna 3 / CBRS LTE[(20 MHz 1C + 15 MHz 1C) + 15 MHz 1C][3C(2C+1C)] / LTE 15 MHz 1C / Non-Contiguous / QPSK / High

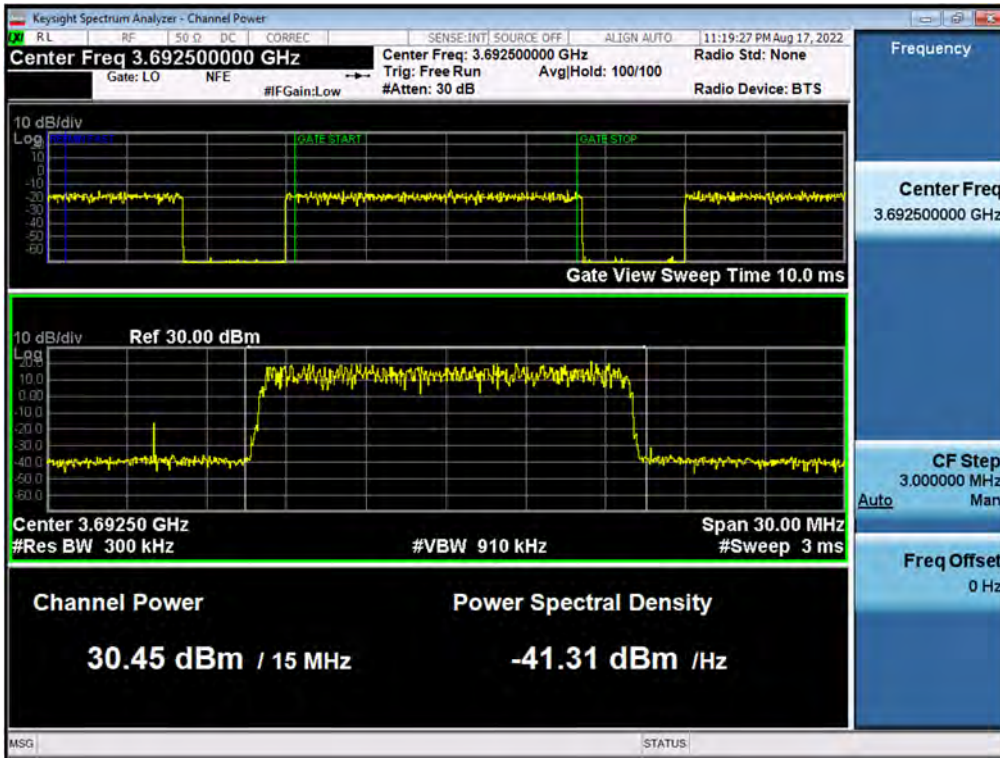

Antenna 3 / CBRS LTE[20 MHz 1C + (20 MHz 1C + 20 MHz 1C)][3C(1C+2C)] / LTE 20 MHz 1C / Non-Contiguous / QPSK / Low

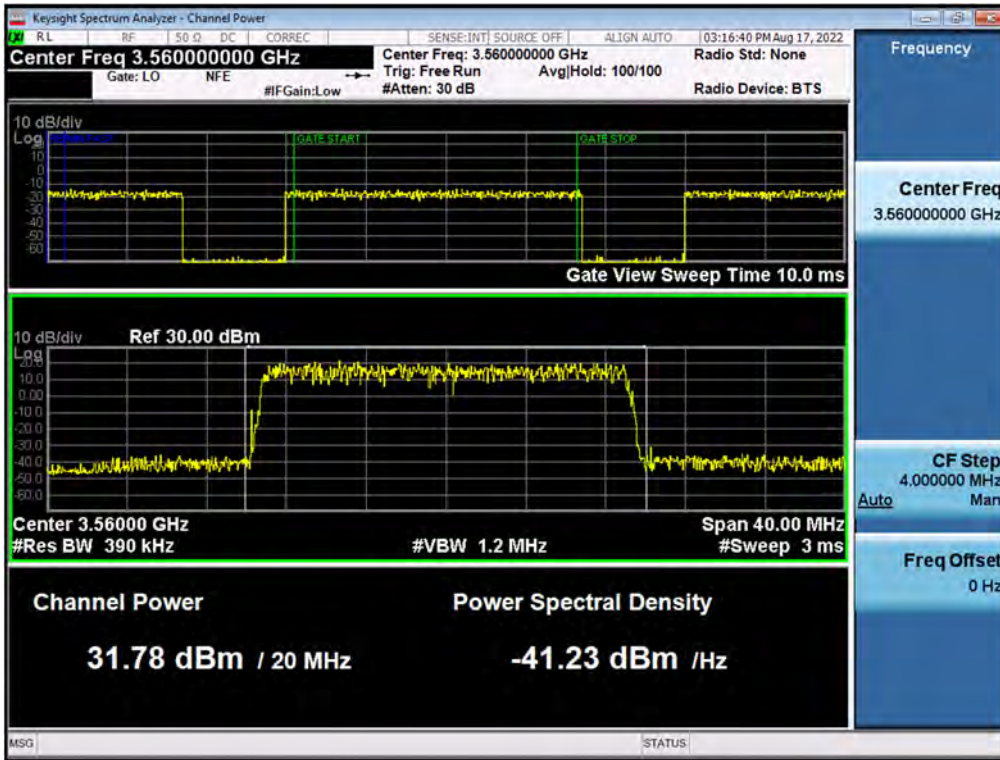

Antenna 3 / CBRS LTE[20 MHz 1C + (20 MHz 1C + 20 MHz 1C)][3C(1C+2C)] / LTE 20 MHz 1C + LTE 20 MHz 1C / Non-Contiguous / QPSK / High

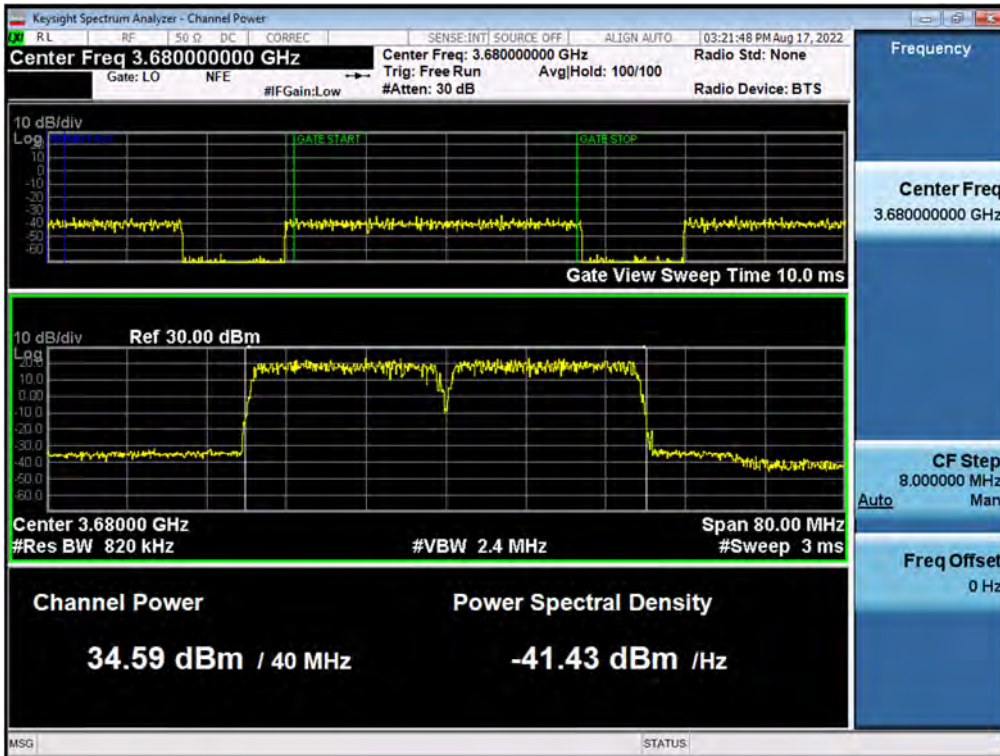

Antenna 3 / CBRS LTE[(20 MHz 1C + 20 MHz 1C) + 20 MHz 1C][3C(2C+1C)] / LTE 20 MHz 1C + LTE 20 MHz 1C / Non-Contiguous / QPSK / Low

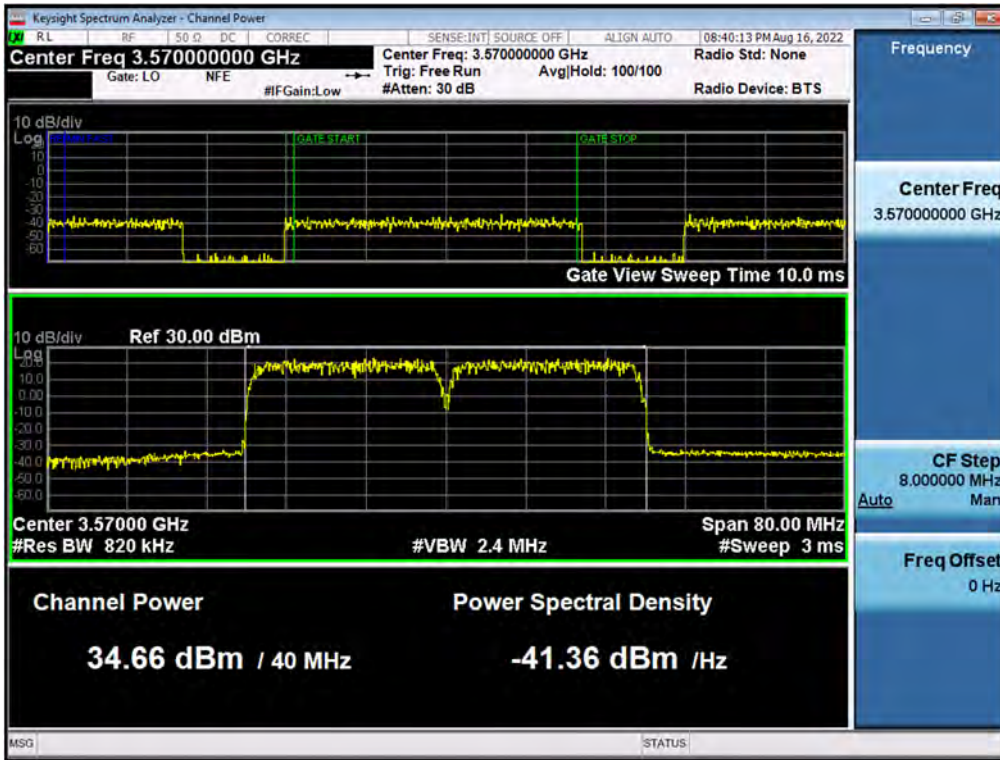

Antenna 3 / CBRS LTE[(20 MHz 1C + 20 MHz 1C) + 20 MHz 1C][3C(2C+1C)] / LTE 20 MHz 1C / Non-Contiguous / QPSK / High

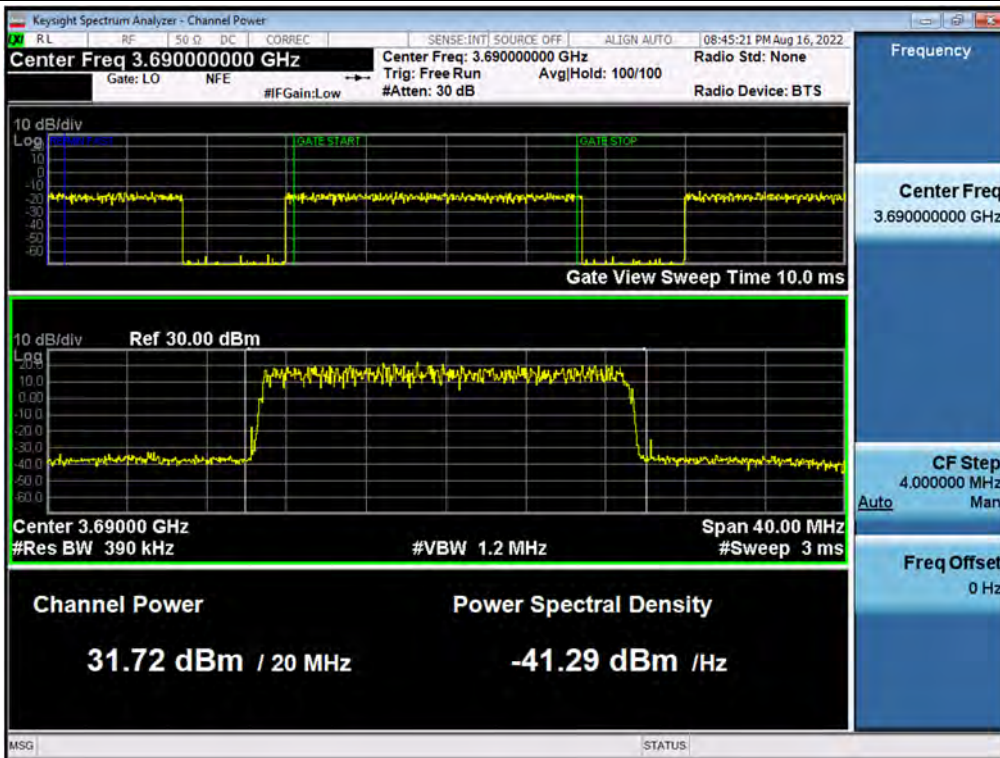

Antenna 3 / CBRS LTE[20 MHz 1C + (20 MHz 1C + 20 MHz 1C + 20 MHz 1C)][4C(1C+3C)] / LTE 20 MHz 1C / Non-Contiguous / QPSK / Low

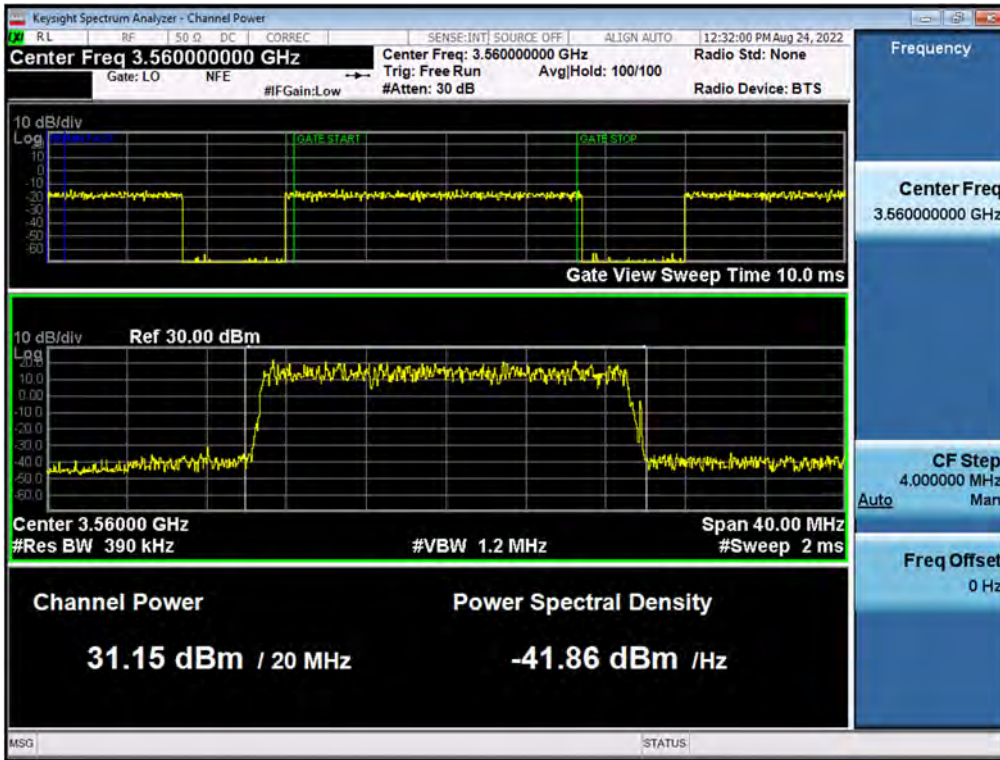

Antenna 3 / CBRS LTE[20 MHz 1C + (20 MHz 1C + 20 MHz 1C + 20 MHz 1C)][4C(1C+3C)] / LTE 20 MHz 1C + LTE 20 MHz 1C + LTE 20 MHz 1C / Non-Contiguous / QPSK / High

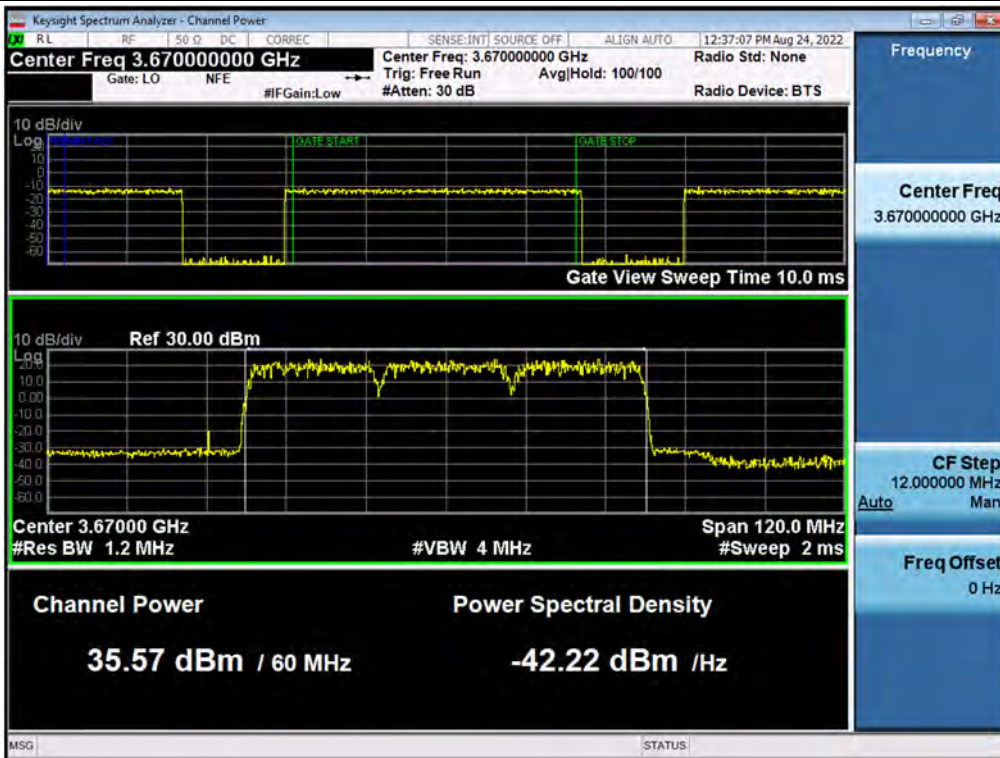

Antenna 3 / CBRS LTE[(20 MHz 1C + 20 MHz 1C + 20 MHz 1C) + 20 MHz 1C][4C(3C+1C)] / LTE 20 MHz 1C + LTE 20 MHz 1C + LTE 20 MHz 1C / Non-Contiguous / 16QAM / Low

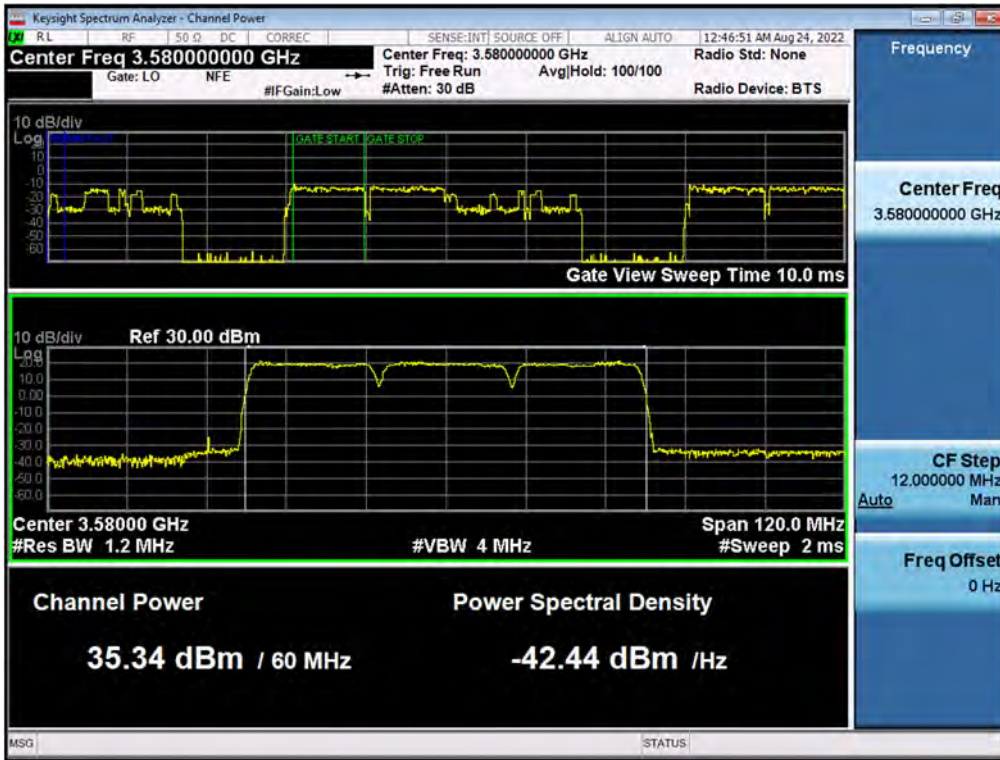

Antenna 3 / CBRS LTE[(20 MHz 1C + 20 MHz 1C + 20 MHz 1C) + 20 MHz 1C][4C(3C+1C)] / LTE 20 MHz 1C / Non-Contiguous / 16QAM / High

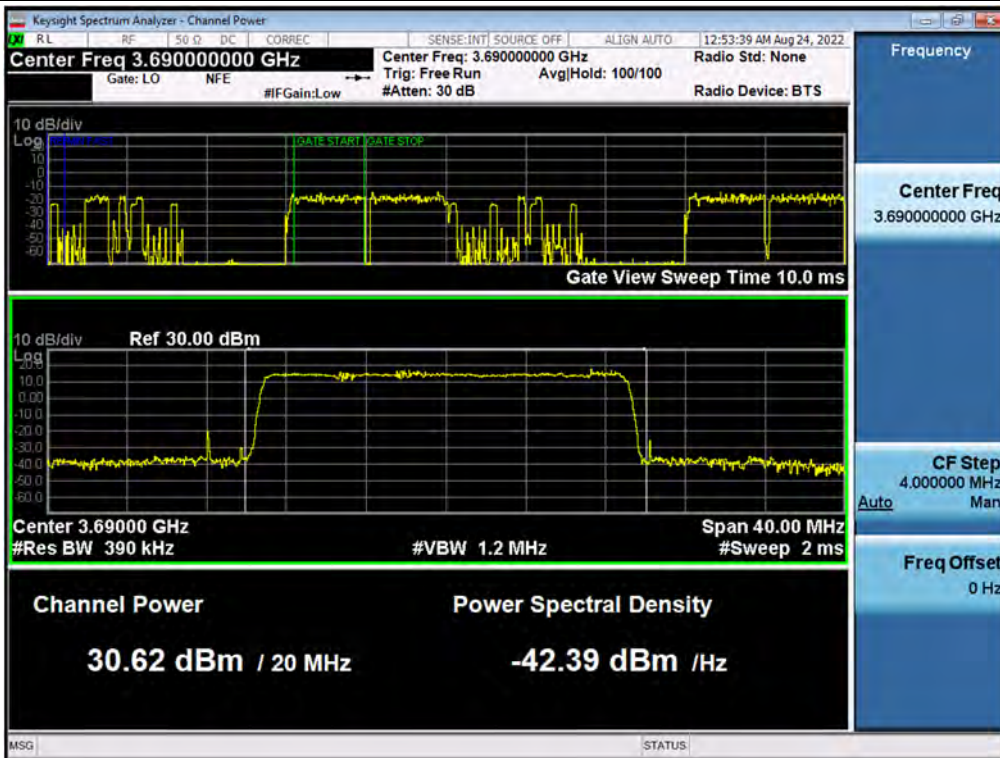

Antenna 3 / CBRS LTE[15 MHz 1C + (15 MHz 1C + 15 MHz 1C + 15 MHz 1C + 10 MHz 1C)][5C(1C+4C)] / LTE 15 MHz 1C / Non-Contiguous / 16QAM / Low

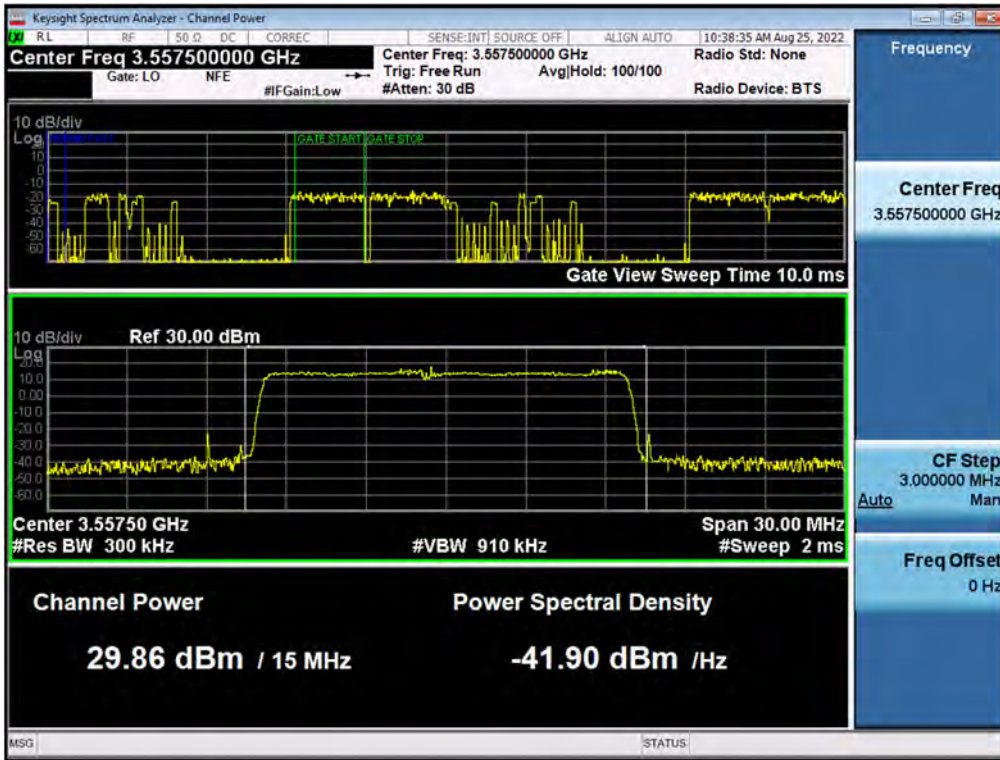

Antenna 3 / CBRS LTE[15 MHz 1C + (15 MHz 1C + 15 MHz 1C + 15 MHz 1C + 10 MHz 1C)][5C(1C+4C)] / LTE 15 MHz 1C + LTE 15 MHz 1C + LTE 15 MHz 1C + LTE 10 MHz 1C / Non-Contiguous / 16QAM / High

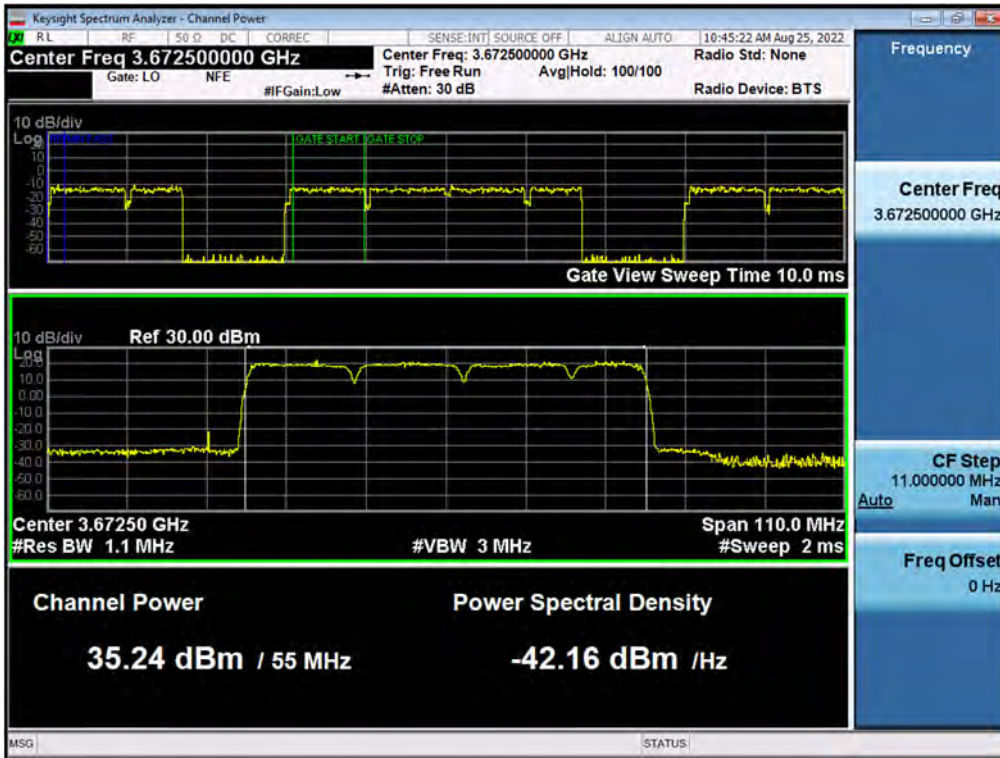

Antenna 3 / CBRS LTE[(15 MHz 1C + 15 MHz 1C + 15 MHz 1C + 15 MHz 1C) + 10 MHz 1C][5C(4C+1C)] / LTE 15 MHz 1C + LTE 15 MHz 1C + LTE 15 MHz 1C + LTE 15 MHz 1C / Non-Contiguous / 64QAM / Low

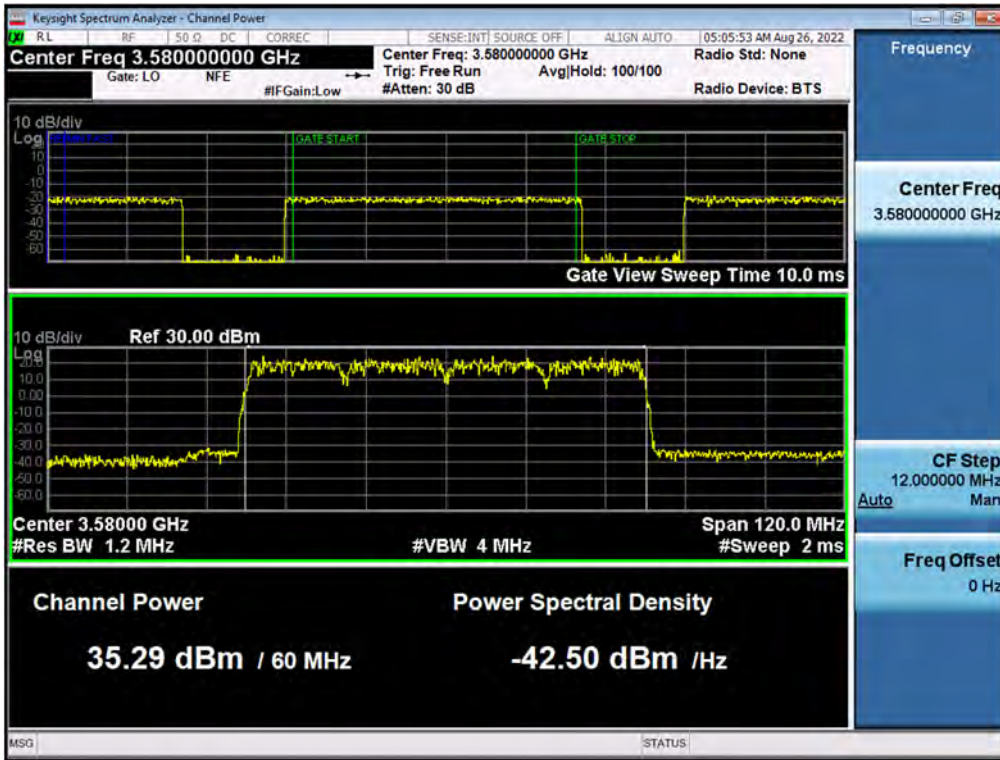

Antenna 3 / CBRS LTE[(15 MHz 1C + 15 MHz 1C + 15 MHz 1C + 15 MHz 1C) + 10 MHz 1C][5C(4C+1C)] / LTE 10 MHz 1C / Non-Contiguous / 64QAM / High

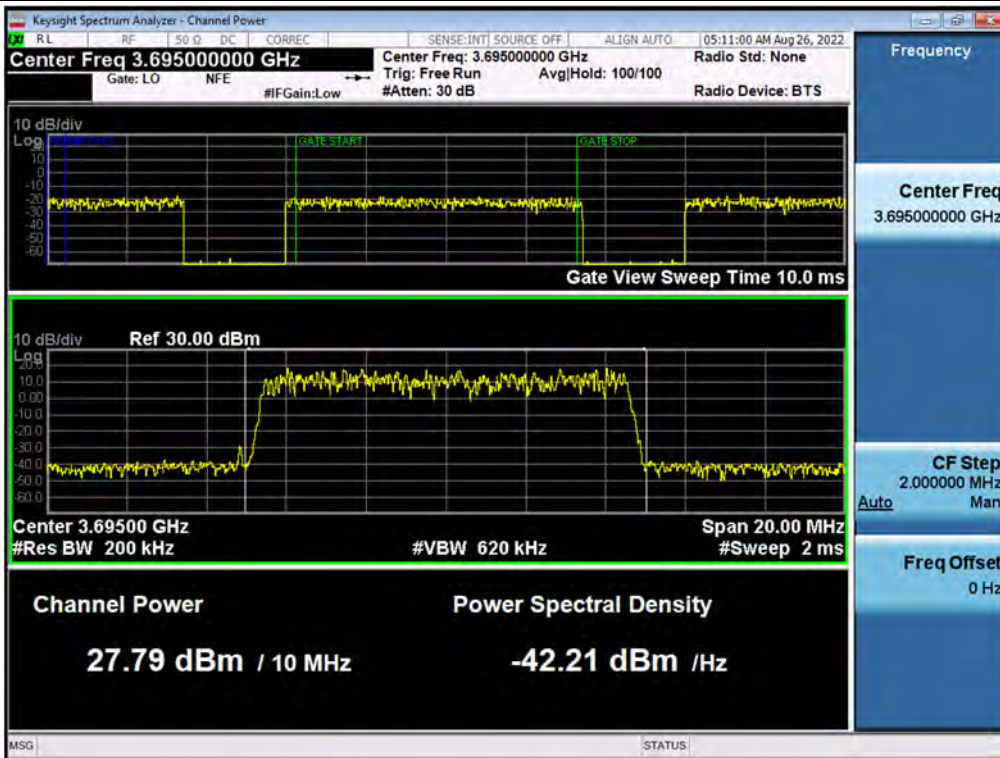



Antenna 3 / CBRS LTE[20 MHz 1C + (20 MHz 1C + 20 MHz 1C + 20 MHz 1C + 10 MHz 1C)][5C(1C+4C)] / LTE 20 MHz 1C / Non-Contiguous / 256QAM / Low

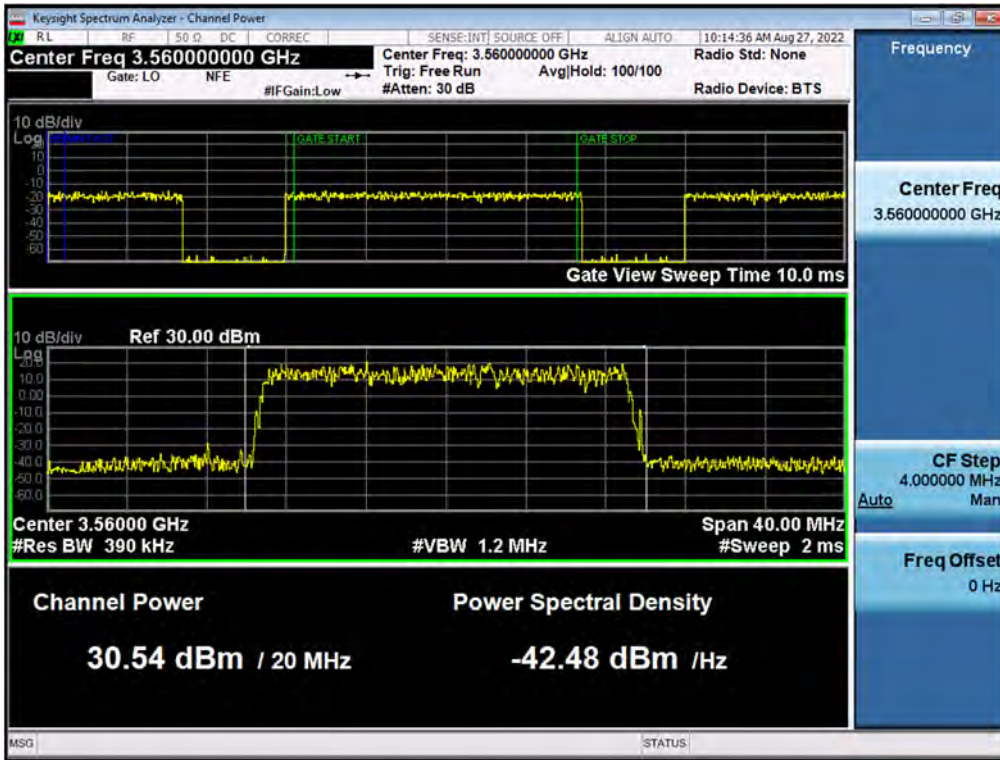

Antenna 3 / CBRS LTE[20 MHz 1C + (20 MHz 1C + 20 MHz 1C + 20 MHz 1C + 10 MHz 1C)][5C(1C+4C)] / LTE 20 MHz 1C + LTE 20 MHz 1C + LTE 20 MHz 1C + LTE 10 MHz 1C / Non-Contiguous / 256QAM / High

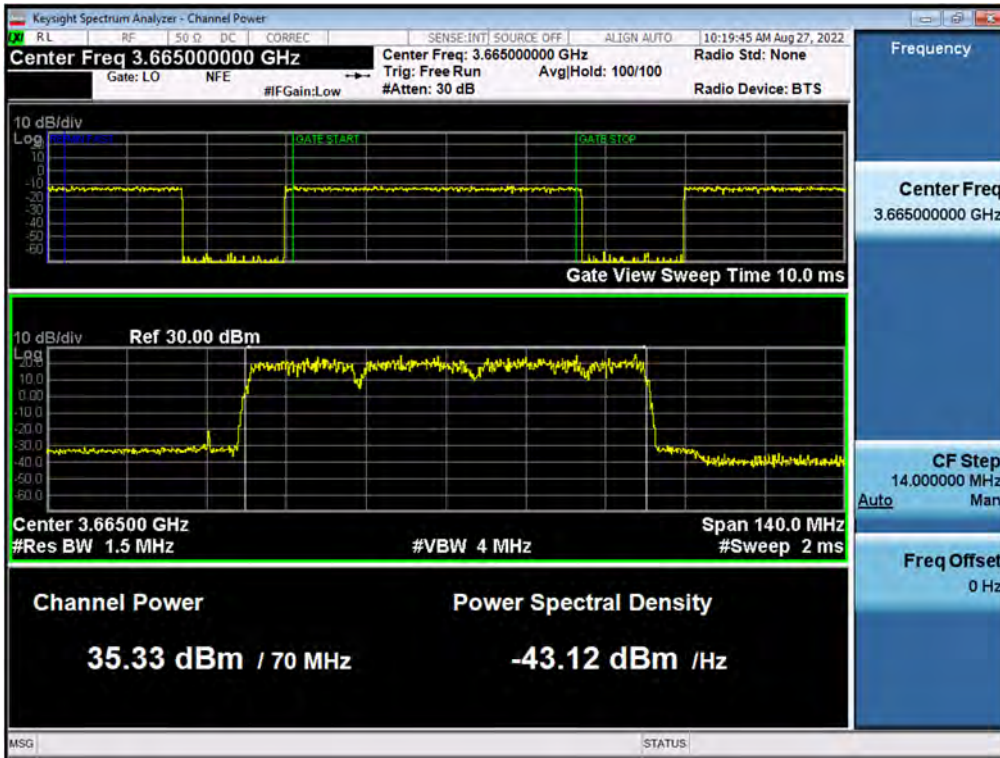

Antenna 3 / CBRS LTE[(20 MHz 1C + 20 MHz 1C + 20 MHz 1C + 20 MHz 1C) + 10 MHz 1C][5C(4C+1C)] / LTE 20 MHz 1C + LTE 20 MHz 1C + LTE 20 MHz 1C + LTE 20 MHz 1C / Non-Contiguous / 64QAM / Low

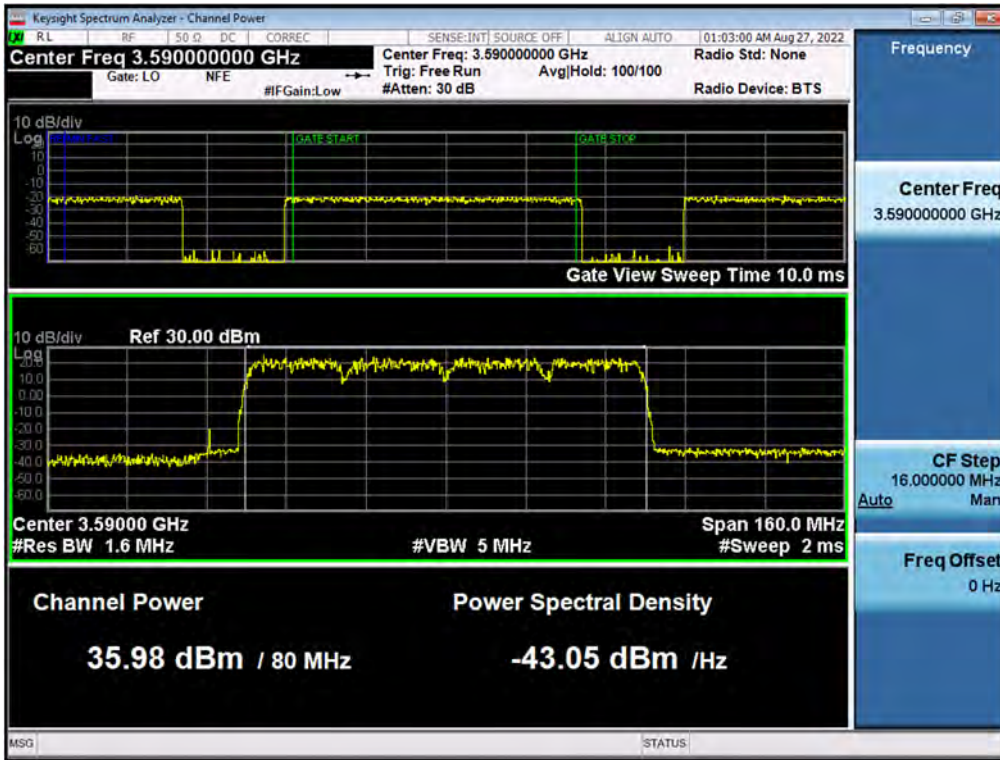

Antenna 3 / CBRS LTE[(20 MHz 1C + 20 MHz 1C + 20 MHz 1C + 20 MHz 1C) + 10 MHz 1C][5C(4C+1C)] / LTE 10 MHz 1C / Non-Contiguous / 64QAM / High

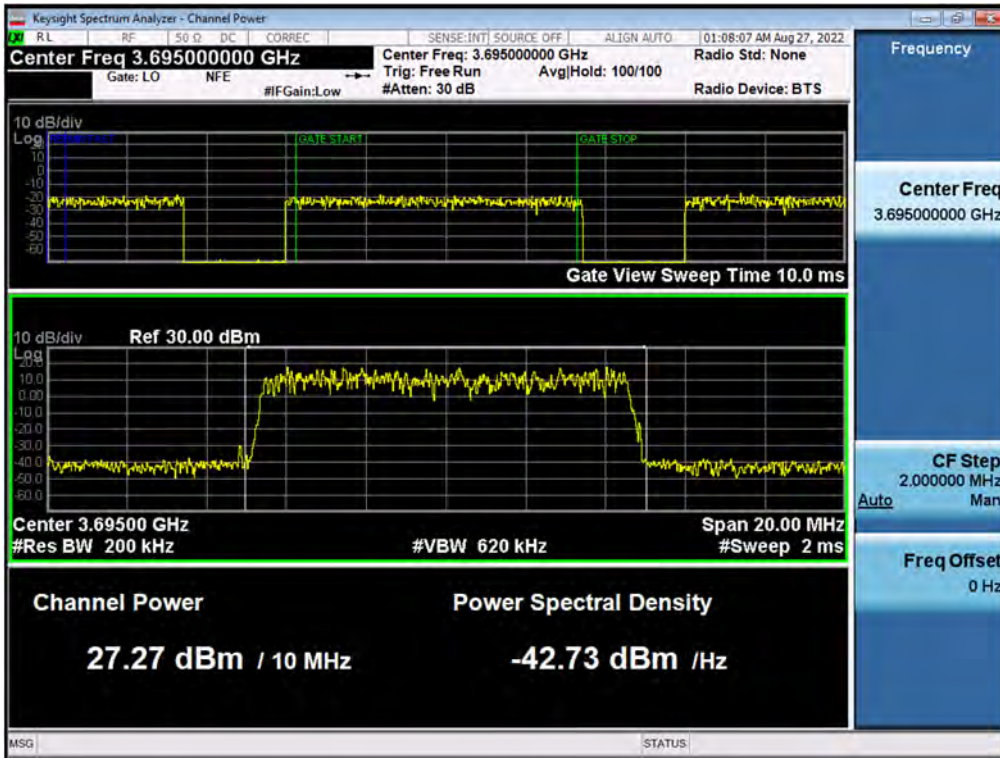

Antenna 0 / CBRS LTE[20 MHz 1C + (20 MHz 1C + 20 MHz 1C + 20 MHz 1C + 20 MHz 1C)][5C(1C+4C)] / LTE 20 MHz 1C / Non-Contiguous / QPSK / Low

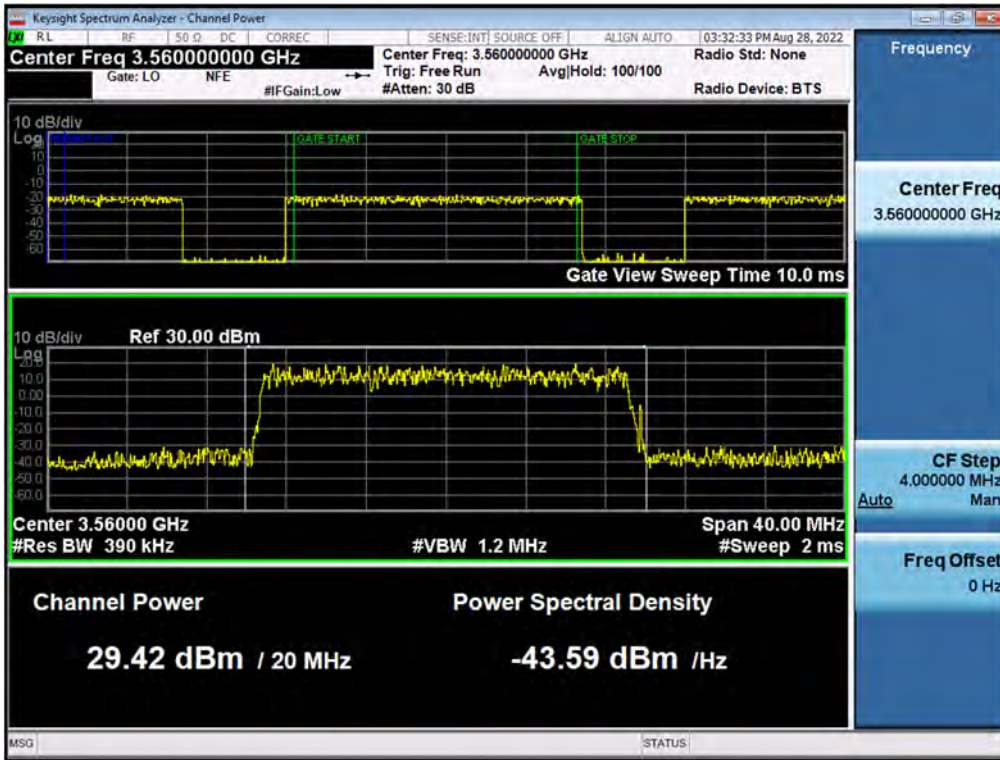

Antenna 0 / CBRS LTE[20 MHz 1C + (20 MHz 1C + 20 MHz 1C + 20 MHz 1C + 20 MHz 1C)][5C(1C+4C)] / LTE 20 MHz 1C + LTE 20 MHz 1C + LTE 20 MHz 1C + LTE 20 MHz 1C / Non-Contiguous / QPSK / High

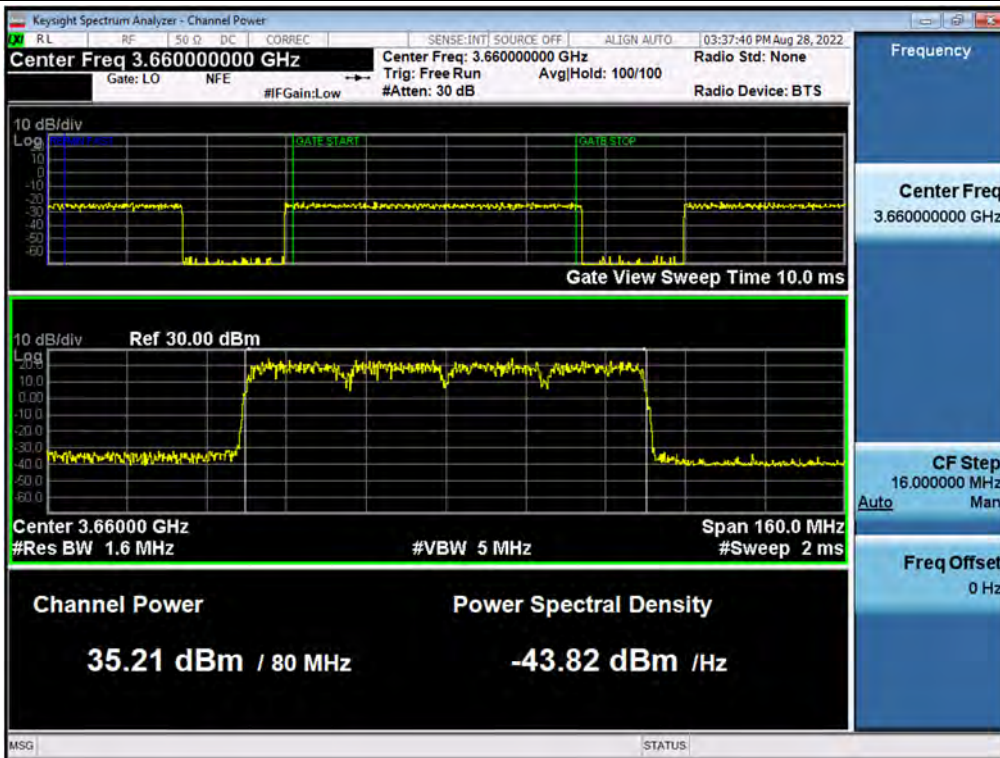

Antenna 1 / CBRS LTE[(20 MHz 1C + 20 MHz 1C + 20 MHz 1C + 20 MHz 1C) + 20 MHz 1C][5C(4C+1C)] / LTE 20 MHz 1C + LTE 20 MHz 1C + LTE 20 MHz 1C + LTE 20 MHz 1C / Non-Contiguous / QPSK / Low

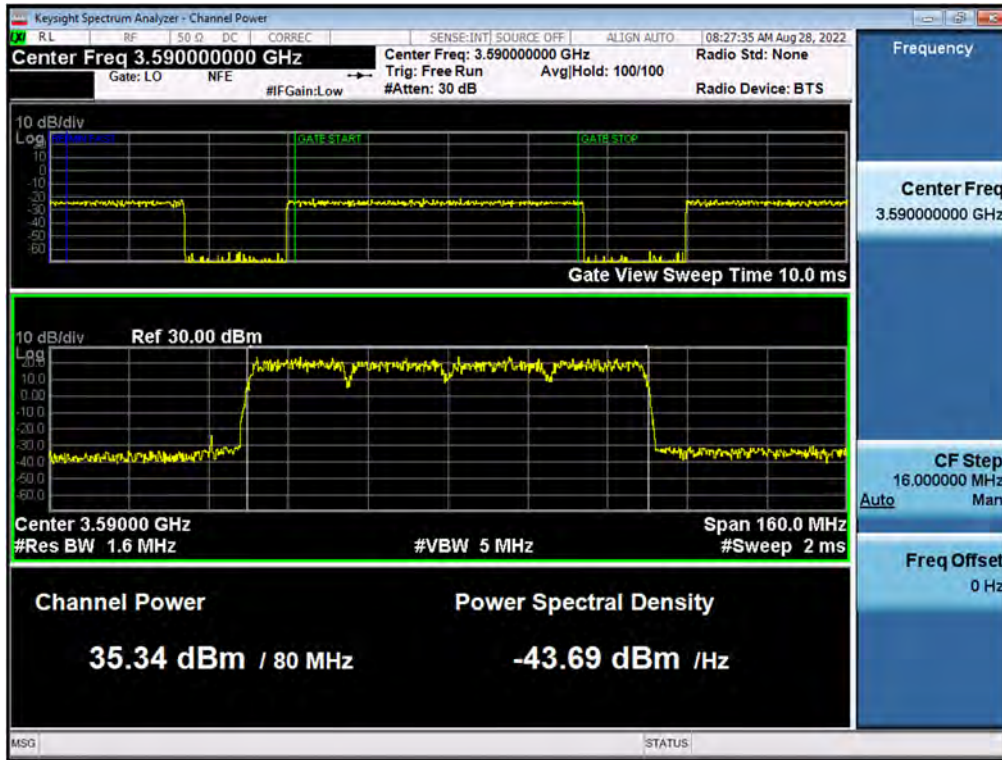

Antenna 1 / CBRS LTE[(20 MHz 1C + 20 MHz 1C + 20 MHz 1C + 20 MHz 1C) + 20 MHz 1C][5C(4C+1C)] / LTE 20 MHz 1C / Non-Contiguous / QPSK / High

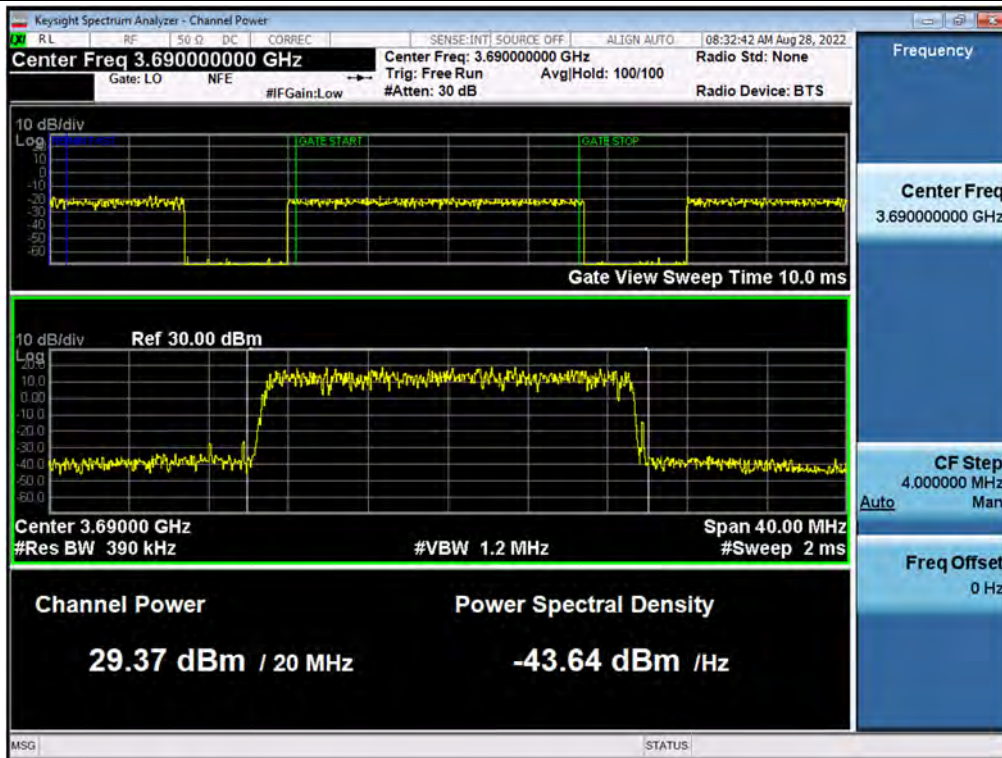

Antenna 3 / CBRS NR 40 MHz 1C + (NR 20 MHz 1C + NR 20 MHz 1C + LTE 10 MHz 1C + LTE 10 MHz 1C)[5C(1C+4C)] / LTE 10 MHz 1C / Non-Contiguous / 16QAM / Low

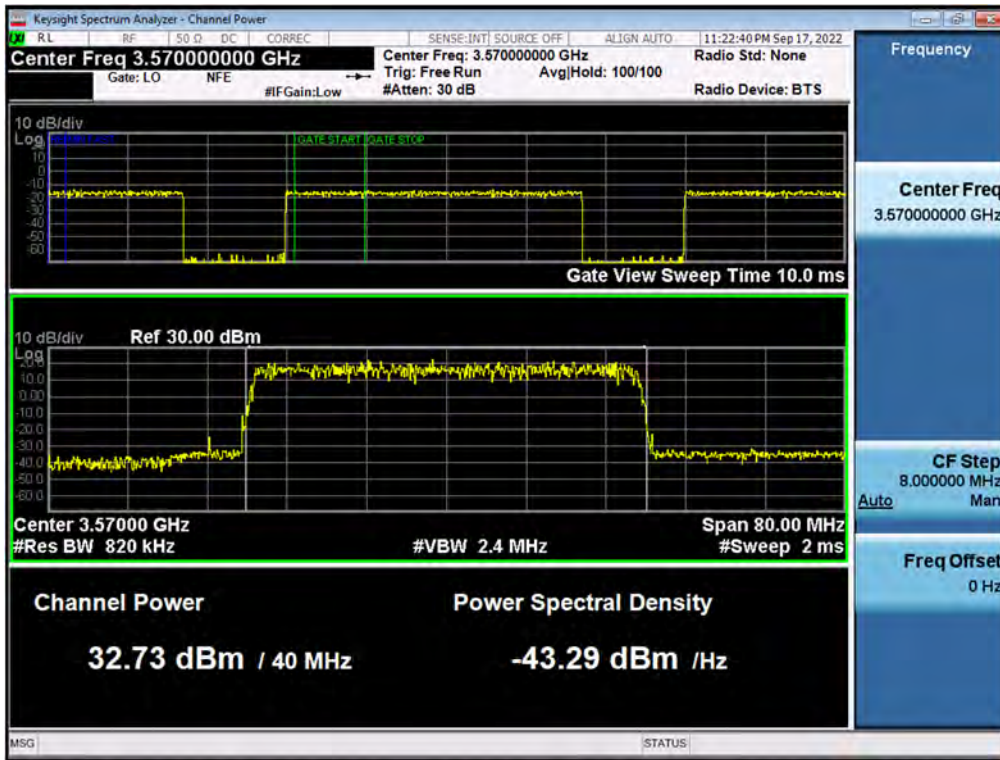

Antenna 3 / CBRS NR 40 MHz 1C + (NR 20 MHz 1C + NR 20 MHz 1C + LTE 10 MHz 1C + LTE 10 MHz 1C)[5C(1C+4C)] / NR 20 MHz 1C + NR 20 MHz 1C + LTE 10 MHz 1C + LTE 10 MHz 1C / Non-Contiguous / 16QAM / High

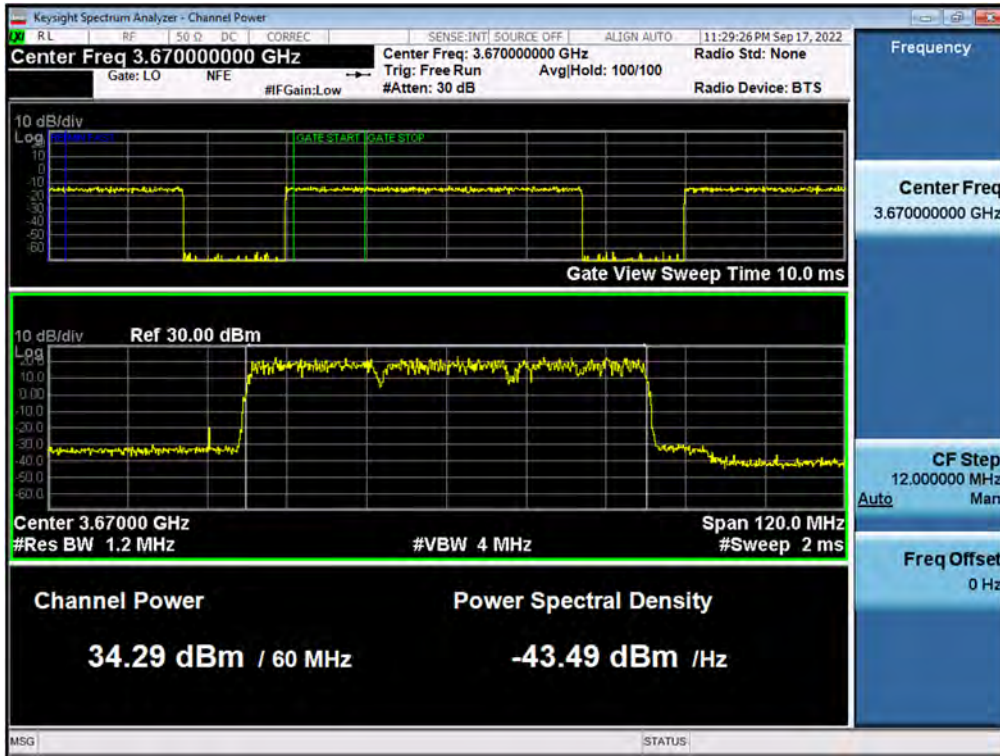

Antenna 3 / CBRS (NR 40 MHz 1C + NR 20 MHz 1C + NR 20 MHz 1C + LTE 10 MHz 1C) + LTE 10 MHz 1C[5C(1C+4C)] / NR 40 MHz 1C + NR 20 MHz 1C + NR 20 MHz 1C + LTE 10 MHz 1C / Non-Contiguous / 16QAM / Low

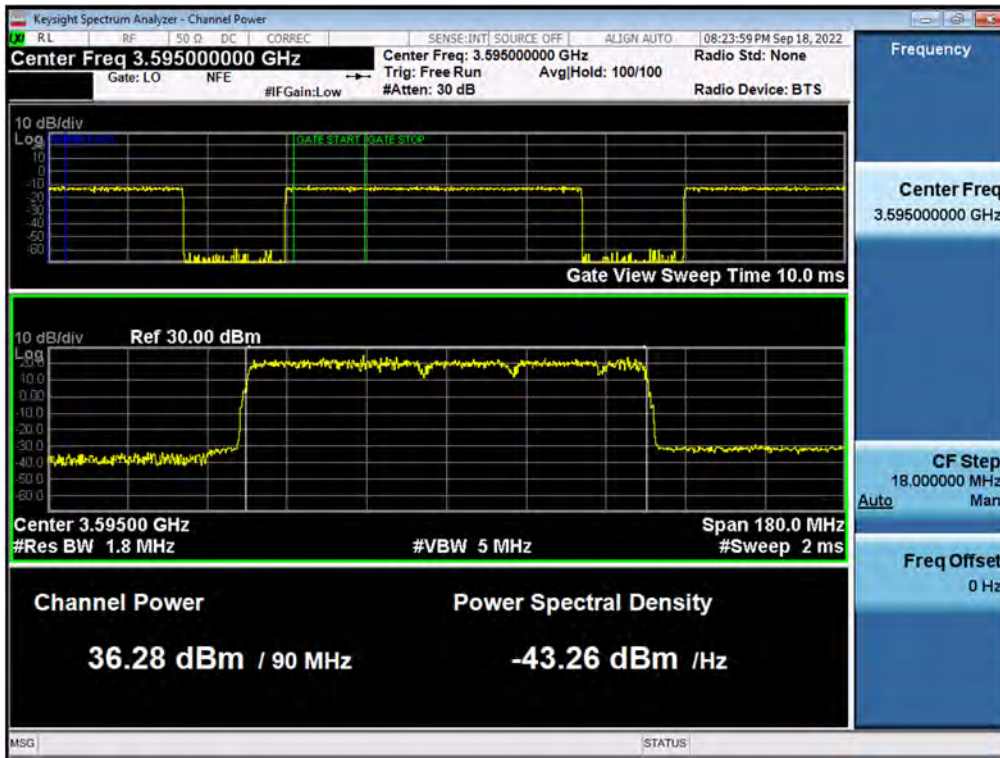

Antenna 3 / CBRS (NR 40 MHz 1C + NR 20 MHz 1C + NR 20 MHz 1C + LTE 10 MHz 1C) + LTE 10 MHz 1C[5C(1C+4C)] / LTE 10 MHz 1C / Non-Contiguous / 16QAM / High

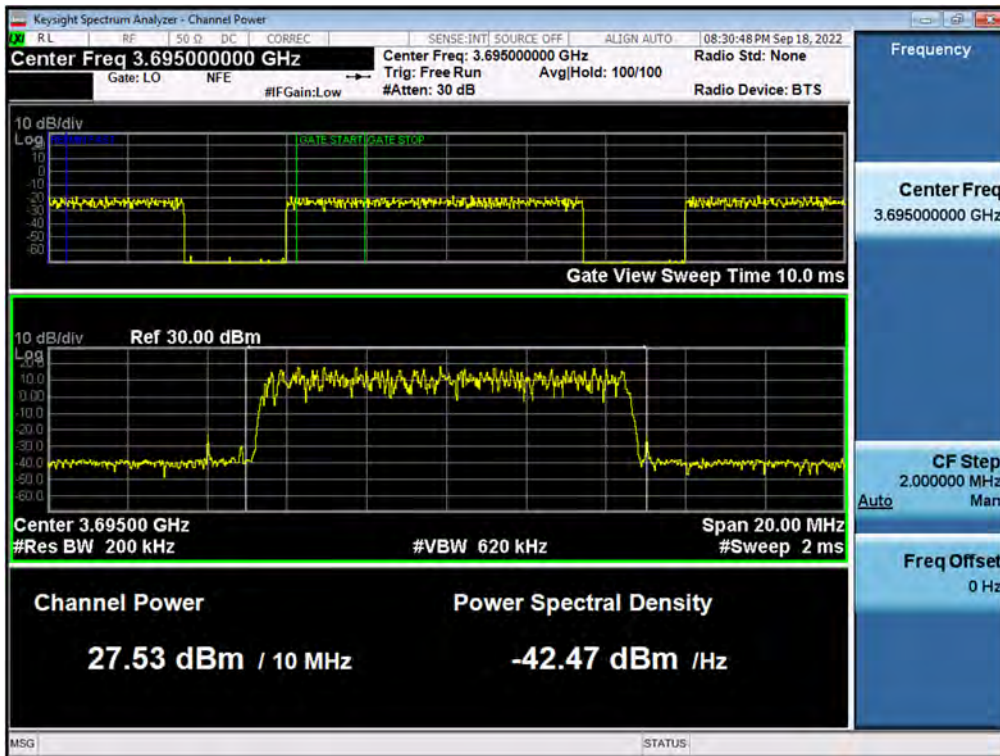

Antenna 3 / CBRS NR 40 MHz 1C + (NR 10 MHz 1C + LTE 20 MHz 1C + LTE 5 MHz 1C + LTE 5 MHz 1C)[5C(1C+4C)] / NR 40 MHz 1C / Non-Contiguous / 16QAM / Low

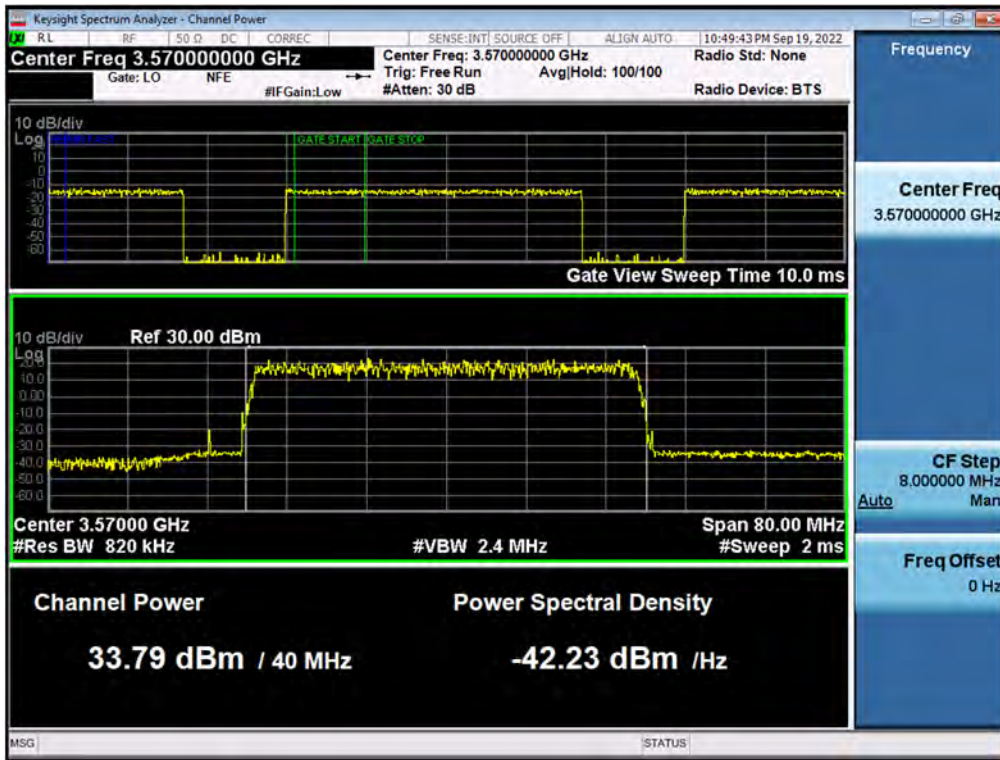

Antenna 3 / CBRS NR 40 MHz 1C + (NR 10 MHz 1C + LTE 20 MHz 1C + LTE 5 MHz 1C + LTE 5 MHz 1C)[5C(1C+4C)] / NR 10 MHz 1C + LTE 20 MHz 1C + LTE 5 MHz 1C + LTE 5 MHz 1C / Non-Contiguous / 16QAM / High

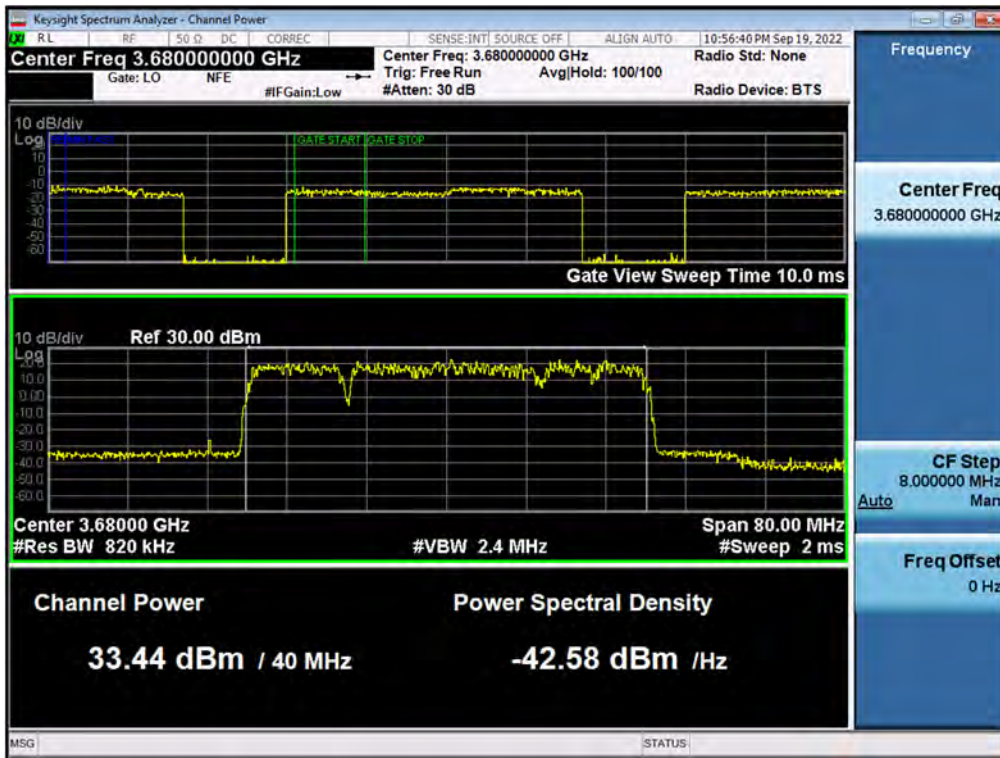

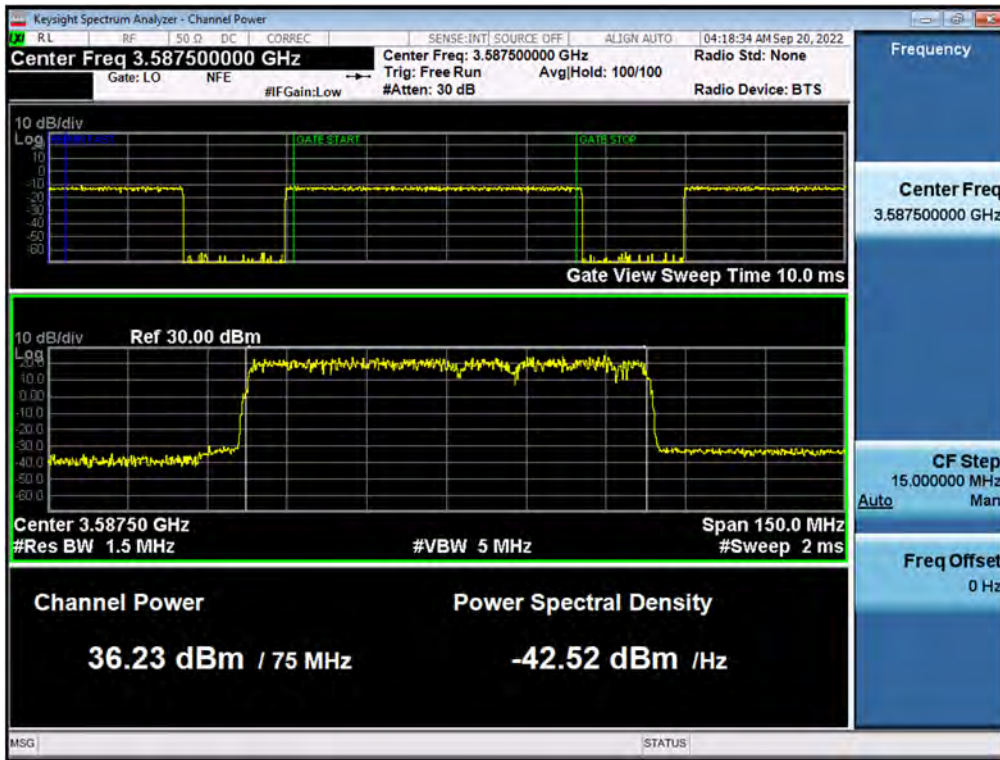
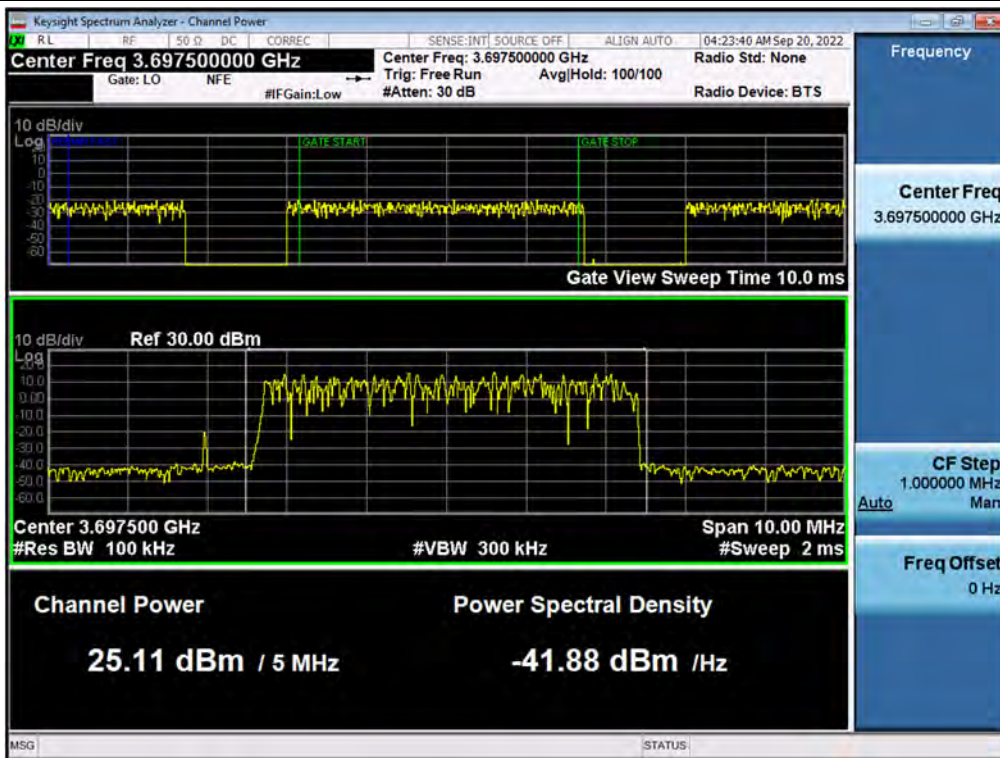
**Antenna 3 / CBRS (NR 40 MHz 1C + NR 10 MHz 1C + LTE 20 MHz 1C + LTE 5 MHz 1C) + LTE 5 MHz 1C[5C(4C+1C)] / NR 40 MHz 1C + NR 10 MHz 1C + LTE 20 MHz 1C + LTE 5 MHz 1C / Non-Contiguous / QPSK / Low**

**Antenna 3 / CBRS (NR 40 MHz 1C + NR 10 MHz 1C + LTE 20 MHz 1C + LTE 5 MHz 1C) + LTE 5 MHz 1C[5C(4C+1C)] / LTE 5 MHz 1C / Non-Contiguous / QPSK / High**



## Tabular Data of PSD

## CBRS NR 10 MHz 1 Carrier

Ant.	Mod	Ch	Frequency (MHz)	Measured Value (dBm/MHz)	Directional Gain (dBi)	PSD (dBm/MHz)	Limit (dBm/MHz)
0	QPSK	Low	3 555.00	19.84	11.00	30.84	37
		Middle	3 625.00	19.88	11.00	30.88	
		High	3 695.00	19.87	11.00	30.87	
	16QAM	Low	3 555.00	19.47	11.00	30.47	
		Middle	3 625.00	19.92	11.00	30.92	
		High	3 695.00	19.87	11.00	30.87	
	64QAM	Low	3 555.00	19.88	11.00	30.88	
		Middle	3 625.00	19.99	11.00	30.99	
		High	3 695.00	19.98	11.00	30.98	
	256QAM	Low	3 555.00	19.87	11.00	30.87	
		Middle	3 625.00	19.81	11.00	30.81	
		High	3 695.00	19.87	11.00	30.87	
1	QPSK	Low	3 555.00	19.86	11.00	30.86	
		Middle	3 625.00	19.96	11.00	30.96	
		High	3 695.00	19.96	11.00	30.96	
	16QAM	Low	3 555.00	19.99	11.00	30.99	
		Middle	3 625.00	19.88	11.00	30.88	
		High	3 695.00	19.87	11.00	30.87	
	64QAM	Low	3 555.00	19.84	11.00	30.84	
		Middle	3 625.00	19.81	11.00	30.81	
		High	3 695.00	19.96	11.00	30.96	
256QAM	Low	3 555.00	19.94	11.00	30.94		
	Middle	3 625.00	19.86	11.00	30.86		
	High	3 695.00	19.87	11.00	30.87		

Ant.	Mod	Ch	Frequency (MHz)	Measured Value (dBm/MHz)	Directional Gain (dBi)	PSD (dBm/MHz)	Limit (dBm/MHz)
2	QPSK	Low	3 555.00	19.88	11.00	30.88	37
		Middle	3 625.00	19.80	11.00	30.80	
		High	3 695.00	19.83	11.00	30.83	
	16QAM	Low	3 555.00	19.86	11.00	30.86	
		Middle	3 625.00	19.89	11.00	30.89	
		High	3 695.00	19.88	11.00	30.88	
	64QAM	Low	3 555.00	19.91	11.00	30.91	
		Middle	3 625.00	19.96	11.00	30.96	
		High	3 695.00	19.89	11.00	30.89	
	256QAM	Low	3 555.00	19.86	11.00	30.86	
		Middle	3 625.00	19.85	11.00	30.85	
		High	3 695.00	19.87	11.00	30.87	
3	QPSK	Low	3 555.00	19.81	11.00	30.81	
		Middle	3 625.00	19.82	11.00	30.82	
		High	3 695.00	19.96	11.00	30.96	
	16QAM	Low	3 555.00	19.86	11.00	30.86	
		Middle	3 625.00	19.82	11.00	30.82	
		High	3 695.00	19.88	11.00	30.88	
	64QAM	Low	3 555.00	19.95	11.00	30.95	
		Middle	3 625.00	19.82	11.00	30.82	
		High	3 695.00	19.82	11.00	30.82	
	256QAM	Low	3 555.00	19.82	11.00	30.82	
		Middle	3 625.00	19.88	11.00	30.88	
		High	3 695.00	19.88	11.00	30.88	

**Sum Data of Port 0, Port 1, Port 2 and Port 3**

Frequency (MHz)	PSD				Limit
	QPSK	16QAM	64QAM	256QAM	
	(dBm/MHz)				
3 555.00	36.87	36.82	36.92	36.89	37
3 625.00	36.89	36.90	36.92	36.87	
3 695.00	36.93	36.89	36.94	36.89	

**CBRS NR 20 MHz 1 Carrier**

Ant.	Mod	Ch	Frequency (MHz)	Measured Value (dBm/MHz)	Directional Gain (dBi)	PSD (dBm/MHz)	Limit (dBm/MHz)
0	QPSK	Low	3 560.00	19.95	11.00	30.95	37
		Middle	3 625.00	19.96	11.00	30.96	
		High	3 690.00	19.89	11.00	30.89	
	16QAM	Low	3 560.00	19.96	11.00	30.96	
		Middle	3 625.00	19.90	11.00	30.90	
		High	3 690.00	19.93	11.00	30.93	
	64QAM	Low	3 560.00	19.94	11.00	30.94	
		Middle	3 625.00	19.98	11.00	30.98	
		High	3 690.00	19.91	11.00	30.91	
	256QAM	Low	3 560.00	19.95	11.00	30.95	
		Middle	3 625.00	19.89	11.00	30.89	
		High	3 690.00	19.98	11.00	30.98	
1	QPSK	Low	3 560.00	19.96	11.00	30.96	
		Middle	3 625.00	19.96	11.00	30.96	
		High	3 690.00	19.87	11.00	30.87	
	16QAM	Low	3 560.00	19.97	11.00	30.97	
		Middle	3 625.00	19.90	11.00	30.90	
		High	3 690.00	19.90	11.00	30.90	
	64QAM	Low	3 560.00	19.97	11.00	30.97	
		Middle	3 625.00	19.98	11.00	30.98	
		High	3 690.00	19.95	11.00	30.95	
	256QAM	Low	3 560.00	19.92	11.00	30.92	
		Middle	3 625.00	19.92	11.00	30.92	
		High	3 690.00	19.99	11.00	30.99	

Ant.	Mod	Ch	Frequency (MHz)	Measured Value (dBm/MHz)	Directional Gain (dBi)	PSD (dBm/MHz)	Limit (dBm/MHz)
2	QPSK	Low	3 560.00	19.92	11.00	30.92	37
		Middle	3 625.00	19.95	11.00	30.95	
		High	3 690.00	19.95	11.00	30.95	
	16QAM	Low	3 560.00	19.92	11.00	30.92	
		Middle	3 625.00	19.91	11.00	30.91	
		High	3 690.00	19.94	11.00	30.94	
	64QAM	Low	3 560.00	19.97	11.00	30.97	
		Middle	3 625.00	19.96	11.00	30.96	
		High	3 690.00	19.91	11.00	30.91	
	256QAM	Low	3 560.00	19.97	11.00	30.97	
		Middle	3 625.00	19.90	11.00	30.90	
		High	3 690.00	19.95	11.00	30.95	
3	QPSK	Low	3 560.00	19.89	11.00	30.89	
		Middle	3 625.00	19.92	11.00	30.92	
		High	3 690.00	19.82	11.00	30.82	
	16QAM	Low	3 560.00	19.99	11.00	30.99	
		Middle	3 625.00	19.99	11.00	30.99	
		High	3 690.00	19.96	11.00	30.96	
	64QAM	Low	3 560.00	19.89	11.00	30.89	
		Middle	3 625.00	19.99	11.00	30.99	
		High	3 690.00	19.94	11.00	30.94	
	256QAM	Low	3 560.00	19.90	11.00	30.90	
		Middle	3 625.00	19.91	11.00	30.91	
		High	3 690.00	19.95	11.00	30.95	

Sum Data of Port 0, Port 1, Port 2 and Port 3

Frequency (MHz)	PSD				Limit
	QPSK	16QAM	64QAM	256QAM	
	(dBm/MHz)				
3 560.00	36.95	36.98	36.96	36.95	37
3 625.00	36.97	36.95	37.00	36.93	
3 690.00	36.90	36.95	36.95	36.99	

**CBRS NR 30 MHz 1 Carrier**

Ant.	Mod	Ch	Frequency (MHz)	Measured Value (dBm/MHz)	Directional Gain (dBi)	PSD (dBm/MHz)	Limit (dBm/MHz)
0	QPSK	Low	3 565.00	18.93	12.00	29.93	37
		Middle	3 625.00	18.99	12.00	29.99	
		High	3 685.00	18.89	12.00	29.89	
	16QAM	Low	3 565.00	18.98	12.00	29.98	
		Middle	3 625.00	18.99	12.00	29.99	
		High	3 685.00	18.88	12.00	29.88	
	64QAM	Low	3 565.00	18.94	12.00	29.94	
		Middle	3 625.00	19.00	12.00	30.00	
		High	3 685.00	18.89	12.00	29.89	
	256QAM	Low	3 565.00	18.96	12.00	29.96	
		Middle	3 625.00	18.92	12.00	29.92	
		High	3 685.00	18.91	12.00	29.91	
1	QPSK	Low	3 565.00	18.91	12.00	29.91	
		Middle	3 625.00	18.95	12.00	29.95	
		High	3 685.00	18.71	12.00	29.71	
	16QAM	Low	3 565.00	18.96	12.00	29.96	
		Middle	3 625.00	18.95	12.00	29.95	
		High	3 685.00	18.85	12.00	29.85	
	64QAM	Low	3 565.00	18.98	12.00	29.98	
		Middle	3 625.00	18.98	12.00	29.98	
		High	3 685.00	18.77	12.00	29.77	
	256QAM	Low	3 565.00	18.95	12.00	29.95	
		Middle	3 625.00	18.92	12.00	29.92	
		High	3 685.00	18.87	12.00	29.87	

Ant.	Mod	Ch	Frequency (MHz)	Measured Value (dBm/MHz)	Directional Gain (dBi)	PSD (dBm/MHz)	Limit (dBm/MHz)
2	QPSK	Low	3 565.00	18.93	12.00	29.93	37
		Middle	3 625.00	18.94	12.00	29.94	
		High	3 685.00	18.89	12.00	29.89	
	16QAM	Low	3 565.00	18.94	12.00	29.94	
		Middle	3 625.00	18.96	12.00	29.96	
		High	3 685.00	18.96	12.00	29.96	
	64QAM	Low	3 565.00	18.96	12.00	29.96	
		Middle	3 625.00	18.96	12.00	29.96	
		High	3 685.00	18.98	12.00	29.98	
	256QAM	Low	3 565.00	18.95	12.00	29.95	
		Middle	3 625.00	18.99	12.00	29.99	
		High	3 685.00	18.95	12.00	29.95	
3	QPSK	Low	3 565.00	18.97	12.00	29.97	
		Middle	3 625.00	18.93	12.00	29.93	
		High	3 685.00	18.73	12.00	29.73	
	16QAM	Low	3 565.00	18.99	12.00	29.99	
		Middle	3 625.00	18.95	12.00	29.95	
		High	3 685.00	18.81	12.00	29.81	
	64QAM	Low	3 565.00	18.92	12.00	29.92	
		Middle	3 625.00	18.97	12.00	29.97	
		High	3 685.00	18.74	12.00	29.74	
	256QAM	Low	3 565.00	18.94	12.00	29.94	
		Middle	3 625.00	18.94	12.00	29.94	
		High	3 685.00	18.80	12.00	29.80	

## Sum Data of Port 0, Port 1, Port 2 and Port 3

Frequency (MHz)	PSD				Limit
	QPSK	16QAM	64QAM	256QAM	
	(dBm/MHz)				
3 565.00	36.96	36.99	36.97	36.97	37
3 625.00	36.97	36.98	37.00	36.96	
3 685.00	36.83	36.90	36.87	36.90	



**CBRS NR 40 MHz 1 Carrier**

Ant.	Mod	Ch	Frequency (MHz)	Measured Value (dBm/MHz)	Directional Gain (dBi)	PSD (dBm/MHz)	Limit (dBm/MHz)
0	QPSK	Low	3 570.00	18.96	12.00	29.96	37
		Middle	3 625.00	18.94	12.00	29.94	
		High	3 680.00	18.97	12.00	29.97	
	16QAM	Low	3 570.00	18.98	12.00	29.98	
		Middle	3 625.00	18.98	12.00	29.98	
		High	3 680.00	18.95	12.00	29.95	
	64QAM	Low	3 570.00	18.98	12.00	29.98	
		Middle	3 625.00	18.92	12.00	29.92	
		High	3 680.00	18.90	12.00	29.90	
	256QAM	Low	3 570.00	18.91	12.00	29.91	
		Middle	3 625.00	18.93	12.00	29.93	
		High	3 680.00	18.94	12.00	29.94	
1	QPSK	Low	3 570.00	18.92	12.00	29.92	
		Middle	3 625.00	18.77	12.00	29.77	
		High	3 680.00	18.79	12.00	29.79	
	16QAM	Low	3 570.00	18.93	12.00	29.93	
		Middle	3 625.00	18.89	12.00	29.89	
		High	3 680.00	18.94	12.00	29.94	
	64QAM	Low	3 570.00	18.96	12.00	29.96	
		Middle	3 625.00	18.86	12.00	29.86	
		High	3 680.00	18.84	12.00	29.84	
	256QAM	Low	3 570.00	18.98	12.00	29.98	
		Middle	3 625.00	18.97	12.00	29.97	
		High	3 680.00	18.89	12.00	29.89	

Ant.	Mod	Ch	Frequency (MHz)	Measured Value (dBm/MHz)	Directional Gain (dBi)	PSD (dBm/MHz)	Limit (dBm/MHz)
2	QPSK	Low	3 570.00	18.94	12.00	29.94	37
		Middle	3 625.00	18.79	12.00	29.79	
		High	3 680.00	18.91	12.00	29.91	
	16QAM	Low	3 570.00	18.92	12.00	29.92	
		Middle	3 625.00	18.90	12.00	29.90	
		High	3 680.00	18.90	12.00	29.90	
	64QAM	Low	3 570.00	18.92	12.00	29.92	
		Middle	3 625.00	18.90	12.00	29.90	
		High	3 680.00	18.87	12.00	29.87	
	256QAM	Low	3 570.00	18.85	12.00	29.85	
		Middle	3 625.00	18.71	12.00	29.71	
		High	3 680.00	18.92	12.00	29.92	
3	QPSK	Low	3 570.00	18.92	12.00	29.92	
		Middle	3 625.00	18.85	12.00	29.85	
		High	3 680.00	18.77	12.00	29.77	
	16QAM	Low	3 570.00	18.90	12.00	29.90	
		Middle	3 625.00	18.93	12.00	29.93	
		High	3 680.00	18.71	12.00	29.71	
	64QAM	Low	3 570.00	18.88	12.00	29.88	
		Middle	3 625.00	18.95	12.00	29.95	
		High	3 680.00	18.84	12.00	29.84	
	256QAM	Low	3 570.00	18.83	12.00	29.83	
		Middle	3 625.00	18.91	12.00	29.91	
		High	3 680.00	18.76	12.00	29.76	

## Sum Data of Port 0, Port 1, Port 2 and Port 3

Frequency (MHz)	PSD				Limit
	QPSK	16QAM	64QAM	256QAM	
	(dBm/MHz)				
3 570.00	36.95	36.95	36.96	36.91	37
3 625.00	36.86	36.95	36.93	36.90	
3 680.00	36.88	36.90	36.88	36.90	

**CBRS NR 60 MHz 1 Carrier**

Ant.	Mod	Ch	Frequency (MHz)	Measured Value (dBm/MHz)	Directional Gain (dBi)	PSD (dBm/MHz)	Limit (dBm/MHz)
0	QPSK	Low	3 580.00	18.62	12.00	29.62	37
		Middle	3 625.00	18.79	12.00	29.79	
		High	3 670.00	18.89	12.00	29.89	
	16QAM	Low	3 580.00	18.65	12.00	29.65	
		Middle	3 625.00	18.97	12.00	29.97	
		High	3 670.00	18.99	12.00	29.99	
	64QAM	Low	3 580.00	18.97	12.00	29.97	
		Middle	3 625.00	18.97	12.00	29.97	
		High	3 670.00	18.84	12.00	29.84	
	256QAM	Low	3 580.00	18.97	12.00	29.97	
		Middle	3 625.00	18.94	12.00	29.94	
		High	3 670.00	18.83	12.00	29.83	
1	QPSK	Low	3 580.00	18.67	12.00	29.67	
		Middle	3 625.00	18.69	12.00	29.69	
		High	3 670.00	18.85	12.00	29.85	
	16QAM	Low	3 580.00	18.98	12.00	29.98	
		Middle	3 625.00	18.92	12.00	29.92	
		High	3 670.00	18.85	12.00	29.85	
	64QAM	Low	3 580.00	18.92	12.00	29.92	
		Middle	3 625.00	18.97	12.00	29.97	
		High	3 670.00	18.78	12.00	29.78	
	256QAM	Low	3 580.00	18.76	12.00	29.76	
		Middle	3 625.00	18.87	12.00	29.87	
		High	3 670.00	18.74	12.00	29.74	

Ant.	Mod	Ch	Frequency (MHz)	Measured Value (dBm/MHz)	Directional Gain (dBi)	PSD (dBm/MHz)	Limit (dBm/MHz)
2	QPSK	Low	3 580.00	18.69	12.00	29.69	37
		Middle	3 625.00	18.99	12.00	29.99	
		High	3 670.00	18.99	12.00	29.99	
	16QAM	Low	3 580.00	18.96	12.00	29.96	
		Middle	3 625.00	18.94	12.00	29.94	
		High	3 670.00	18.95	12.00	29.95	
	64QAM	Low	3 580.00	18.94	12.00	29.94	
		Middle	3 625.00	18.96	12.00	29.96	
		High	3 670.00	18.98	12.00	29.98	
	256QAM	Low	3 580.00	18.92	12.00	29.92	
		Middle	3 625.00	18.93	12.00	29.93	
		High	3 670.00	18.93	12.00	29.93	
3	QPSK	Low	3 580.00	18.66	12.00	29.66	
		Middle	3 625.00	18.88	12.00	29.88	
		High	3 670.00	18.86	12.00	29.86	
	16QAM	Low	3 580.00	18.90	12.00	29.90	
		Middle	3 625.00	18.93	12.00	29.93	
		High	3 670.00	19.00	12.00	30.00	
	64QAM	Low	3 580.00	18.94	12.00	29.94	
		Middle	3 625.00	18.90	12.00	29.90	
		High	3 670.00	18.83	12.00	29.83	
	256QAM	Low	3 580.00	18.94	12.00	29.94	
		Middle	3 625.00	18.98	12.00	29.98	
		High	3 670.00	18.98	12.00	29.98	

Sum Data of Port 0, Port 1, Port 2 and Port 3

Frequency (MHz)	PSD				Limit
	QPSK	16QAM	64QAM	256QAM	
	(dBm/MHz)				
3 580.00	36.68	36.90	36.97	36.92	37
3 625.00	36.86	36.96	36.97	36.95	
3 670.00	36.92	36.97	36.88	36.89	

**CBRS NR 80 MHz 1 Carrier**

Ant.	Mod	Ch	Frequency (MHz)	Measured Value (dBm/MHz)	Directional Gain (dBi)	PSD (dBm/MHz)	Limit (dBm/MHz)
0	QPSK	Low	3 590.00	17.93	13.00	28.93	37
		Middle	3 625.00	17.83	13.00	28.83	
		High	3 660.00	17.95	13.00	28.95	
	16QAM	Low	3 590.00	17.95	13.00	28.95	
		Middle	3 625.00	17.90	13.00	28.90	
		High	3 660.00	17.95	13.00	28.95	
	64QAM	Low	3 590.00	17.86	13.00	28.86	
		Middle	3 625.00	17.96	13.00	28.96	
		High	3 660.00	17.94	13.00	28.94	
	256QAM	Low	3 590.00	17.86	13.00	28.86	
		Middle	3 625.00	17.90	13.00	28.90	
		High	3 660.00	17.94	13.00	28.94	
1	QPSK	Low	3 590.00	17.89	13.00	28.89	
		Middle	3 625.00	17.96	13.00	28.96	
		High	3 660.00	17.96	13.00	28.96	
	16QAM	Low	3 590.00	17.82	13.00	28.82	
		Middle	3 625.00	17.93	13.00	28.93	
		High	3 660.00	17.80	13.00	28.80	
	64QAM	Low	3 590.00	17.83	13.00	28.83	
		Middle	3 625.00	17.95	13.00	28.95	
		High	3 660.00	17.96	13.00	28.96	
	256QAM	Low	3 590.00	17.87	13.00	28.87	
		Middle	3 625.00	17.91	13.00	28.91	
		High	3 660.00	17.78	13.00	28.78	

Ant.	Mod	Ch	Frequency (MHz)	Measured Value (dBm/MHz)	Directional Gain (dBi)	PSD (dBm/MHz)	Limit (dBm/MHz)
2	QPSK	Low	3 590.00	17.89	13.00	28.89	37
		Middle	3 625.00	17.93	13.00	28.93	
		High	3 660.00	17.80	13.00	28.80	
	16QAM	Low	3 590.00	17.89	13.00	28.89	
		Middle	3 625.00	17.91	13.00	28.91	
		High	3 660.00	17.85	13.00	28.85	
	64QAM	Low	3 590.00	17.88	13.00	28.88	
		Middle	3 625.00	17.93	13.00	28.93	
		High	3 660.00	17.95	13.00	28.95	
	256QAM	Low	3 590.00	17.83	13.00	28.83	
		Middle	3 625.00	17.90	13.00	28.90	
		High	3 660.00	17.83	13.00	28.83	
3	QPSK	Low	3 590.00	17.77	13.00	28.77	
		Middle	3 625.00	17.92	13.00	28.92	
		High	3 660.00	17.83	13.00	28.83	
	16QAM	Low	3 590.00	17.80	13.00	28.80	
		Middle	3 625.00	17.93	13.00	28.93	
		High	3 660.00	17.81	13.00	28.81	
	64QAM	Low	3 590.00	17.86	13.00	28.86	
		Middle	3 625.00	17.93	13.00	28.93	
		High	3 660.00	17.90	13.00	28.90	
	256QAM	Low	3 590.00	17.93	13.00	28.93	
		Middle	3 625.00	17.92	13.00	28.92	
		High	3 660.00	17.80	13.00	28.80	



Sum Data of Port 0, Port 1, Port 2 and Port 3

Frequency (MHz)	PSD				Limit
	QPSK	16QAM	64QAM	256QAM	
	(dBm/MHz)				
3 590.00	36.89	36.89	36.88	36.89	37
3 625.00	36.93	36.94	36.96	36.93	
3 660.00	36.90	36.87	36.96	36.86	

**CBRS NR 100 MHz 1 Carrier**

Ant.	Mod	Ch	Frequency (MHz)	Measured Value (dBm/MHz)	Directional Gain (dBi)	PSD (dBm/MHz)	Limit (dBm/MHz)
0	QPSK	Low	3 600.00	16.81	13.00	27.81	37
		Middle	3 625.00	16.74	13.00	27.74	
		High	3 650.00	16.64	13.00	27.64	
	16QAM	Low	3 600.00	16.91	13.00	27.91	
		Middle	3 625.00	16.80	13.00	27.80	
		High	3 650.00	16.74	13.00	27.74	
	64QAM	Low	3 600.00	16.79	13.00	27.79	
		Middle	3 625.00	16.79	13.00	27.79	
		High	3 650.00	16.94	13.00	27.94	
	256QAM	Low	3 600.00	16.81	13.00	27.81	
		Middle	3 625.00	16.65	13.00	27.65	
		High	3 650.00	16.90	13.00	27.90	
1	QPSK	Low	3 600.00	16.90	13.00	27.90	
		Middle	3 625.00	16.86	13.00	27.86	
		High	3 650.00	16.67	13.00	27.67	
	16QAM	Low	3 600.00	16.99	13.00	27.99	
		Middle	3 625.00	16.92	13.00	27.92	
		High	3 650.00	16.70	13.00	27.70	
	64QAM	Low	3 600.00	16.95	13.00	27.95	
		Middle	3 625.00	16.88	13.00	27.88	
		High	3 650.00	16.92	13.00	27.92	
	256QAM	Low	3 600.00	16.81	13.00	27.81	
		Middle	3 625.00	16.73	13.00	27.73	
		High	3 650.00	16.95	13.00	27.95	

Ant.	Mod	Ch	Frequency (MHz)	Measured Value (dBm/MHz)	Directional Gain (dBi)	PSD (dBm/MHz)	Limit (dBm/MHz)
2	QPSK	Low	3 600.00	16.93	13.00	27.93	37
		Middle	3 625.00	16.90	13.00	27.90	
		High	3 650.00	16.75	13.00	27.75	
	16QAM	Low	3 600.00	16.94	13.00	27.94	
		Middle	3 625.00	16.96	13.00	27.96	
		High	3 650.00	16.97	13.00	27.97	
	64QAM	Low	3 600.00	17.00	13.00	28.00	
		Middle	3 625.00	16.75	13.00	27.75	
		High	3 650.00	16.94	13.00	27.94	
	256QAM	Low	3 600.00	16.98	13.00	27.98	
		Middle	3 625.00	16.85	13.00	27.85	
		High	3 650.00	16.98	13.00	27.98	
3	QPSK	Low	3 600.00	16.69	13.00	27.69	
		Middle	3 625.00	16.84	13.00	27.84	
		High	3 650.00	16.97	13.00	27.97	
	16QAM	Low	3 600.00	16.80	13.00	27.80	
		Middle	3 625.00	16.86	13.00	27.86	
		High	3 650.00	16.82	13.00	27.82	
	64QAM	Low	3 600.00	16.88	13.00	27.88	
		Middle	3 625.00	16.77	13.00	27.77	
		High	3 650.00	16.84	13.00	27.84	
	256QAM	Low	3 600.00	16.88	13.00	27.88	
		Middle	3 625.00	16.76	13.00	27.76	
		High	3 650.00	16.86	13.00	27.86	

## Sum Data of Port 0, Port 1, Port 2 and Port 3

Frequency (MHz)	PSD				Limit
	QPSK	16QAM	64QAM	256QAM	
	(dBm/MHz)				
3 600.00	35.86	35.93	35.93	35.89	37
3 625.00	35.86	35.91	35.82	35.77	
3 650.00	35.78	35.83	35.93	35.94	

**CBRS LTE 5 MHz 1 Carrier**

Ant.	Mod	Ch	Frequency (MHz)	Measured Value (dBm/MHz)	Directional Gain (dBi)	PSD (dBm/MHz)	Limit (dBm/MHz)
0	QPSK	Low	3 552.50	20.01	11.00	31.01	37
		Middle	3 625.00	20.00	11.00	31.00	
		High	3 697.50	20.00	11.00	31.00	
	16QAM	Low	3 552.50	20.00	11.00	31.00	
		Middle	3 625.00	19.99	11.00	30.99	
		High	3 697.50	19.84	11.00	30.84	
	64QAM	Low	3 552.50	19.89	11.00	30.89	
		Middle	3 625.00	20.00	11.00	31.00	
		High	3 697.50	19.95	11.00	30.95	
	256QAM	Low	3 552.50	19.94	11.00	30.94	
		Middle	3 625.00	19.83	11.00	30.83	
		High	3 697.50	19.98	11.00	30.98	
1	QPSK	Low	3 552.50	19.95	11.00	30.95	
		Middle	3 625.00	19.88	11.00	30.88	
		High	3 697.50	19.84	11.00	30.84	
	16QAM	Low	3 552.50	19.94	11.00	30.94	
		Middle	3 625.00	19.87	11.00	30.87	
		High	3 697.50	19.86	11.00	30.86	
	64QAM	Low	3 552.50	19.91	11.00	30.91	
		Middle	3 625.00	19.92	11.00	30.92	
		High	3 697.50	19.95	11.00	30.95	
	256QAM	Low	3 552.50	19.98	11.00	30.98	
		Middle	3 625.00	19.95	11.00	30.95	
		High	3 697.50	19.99	11.00	30.99	

Ant.	Mod	Ch	Frequency (MHz)	Measured Value (dBm/MHz)	Directional Gain (dBi)	PSD (dBm/MHz)	Limit (dBm/MHz)
2	QPSK	Low	3 552.50	19.91	11.00	30.91	37
		Middle	3 625.00	19.97	11.00	30.97	
		High	3 697.50	19.89	11.00	30.89	
	16QAM	Low	3 552.50	19.94	11.00	30.94	
		Middle	3 625.00	19.94	11.00	30.94	
		High	3 697.50	19.83	11.00	30.83	
	64QAM	Low	3 552.50	20.00	11.00	31.00	
		Middle	3 625.00	19.89	11.00	30.89	
		High	3 697.50	19.84	11.00	30.84	
	256QAM	Low	3 552.50	19.94	11.00	30.94	
		Middle	3 625.00	20.01	11.00	31.01	
		High	3 697.50	19.97	11.00	30.97	
3	QPSK	Low	3 552.50	20.01	11.00	31.01	
		Middle	3 625.00	19.94	11.00	30.94	
		High	3 697.50	19.87	11.00	30.87	
	16QAM	Low	3 552.50	19.99	11.00	30.99	
		Middle	3 625.00	20.01	11.00	31.01	
		High	3 697.50	20.00	11.00	31.00	
	64QAM	Low	3 552.50	19.99	11.00	30.99	
		Middle	3 625.00	19.95	11.00	30.95	
		High	3 697.50	19.98	11.00	30.98	
	256QAM	Low	3 552.50	20.00	11.00	31.00	
		Middle	3 625.00	20.00	11.00	31.00	
		High	3 697.50	19.93	11.00	30.93	

Sum Data of Port 0, Port 1, Port 2 and Port 3

Frequency (MHz)	PSD				Limit
	QPSK	16QAM	64QAM	256QAM	
	(dBm/MHz)				
3 552.50	36.99	36.99	36.97	36.99	37
3 625.00	36.97	36.97	36.96	36.97	
3 697.50	36.92	36.90	36.95	36.99	

**CBRS LTE 10 MHz 1 Carrier**

Ant.	Mod	Ch	Frequency (MHz)	Measured Value (dBm/MHz)	Directional Gain (dBi)	PSD (dBm/MHz)	Limit (dBm/MHz)
0	QPSK	Low	3 555.00	19.86	11.00	30.86	37
		Middle	3 625.00	19.90	11.00	30.90	
		High	3 695.00	19.76	11.00	30.76	
	16QAM	Low	3 555.00	19.77	11.00	30.77	
		Middle	3 625.00	19.72	11.00	30.72	
		High	3 695.00	19.89	11.00	30.89	
	64QAM	Low	3 555.00	19.84	11.00	30.84	
		Middle	3 625.00	19.74	11.00	30.74	
		High	3 695.00	19.84	11.00	30.84	
	256QAM	Low	3 555.00	19.85	11.00	30.85	
		Middle	3 625.00	19.76	11.00	30.76	
		High	3 695.00	19.88	11.00	30.88	
1	QPSK	Low	3 555.00	19.78	11.00	30.78	
		Middle	3 625.00	19.83	11.00	30.83	
		High	3 695.00	19.78	11.00	30.78	
	16QAM	Low	3 555.00	19.82	11.00	30.82	
		Middle	3 625.00	19.74	11.00	30.74	
		High	3 695.00	19.80	11.00	30.80	
	64QAM	Low	3 555.00	19.77	11.00	30.77	
		Middle	3 625.00	19.82	11.00	30.82	
		High	3 695.00	19.86	11.00	30.86	
	256QAM	Low	3 555.00	19.76	11.00	30.76	
		Middle	3 625.00	19.81	11.00	30.81	
		High	3 695.00	19.71	11.00	30.71	



Ant.	Mod	Ch	Frequency (MHz)	Measured Value (dBm/MHz)	Directional Gain (dBi)	PSD (dBm/MHz)	Limit (dBm/MHz)
2	QPSK	Low	3 555.00	19.75	11.00	30.75	37
		Middle	3 625.00	19.84	11.00	30.84	
		High	3 695.00	19.74	11.00	30.74	
	16QAM	Low	3 555.00	19.72	11.00	30.72	
		Middle	3 625.00	19.78	11.00	30.78	
		High	3 695.00	19.74	11.00	30.74	
	64QAM	Low	3 555.00	19.73	11.00	30.73	
		Middle	3 625.00	19.78	11.00	30.78	
		High	3 695.00	19.86	11.00	30.86	
	256QAM	Low	3 555.00	19.83	11.00	30.83	
		Middle	3 625.00	19.86	11.00	30.86	
		High	3 695.00	19.72	11.00	30.72	
3	QPSK	Low	3 555.00	19.89	11.00	30.89	
		Middle	3 625.00	19.76	11.00	30.76	
		High	3 695.00	19.85	11.00	30.85	
	16QAM	Low	3 555.00	19.89	11.00	30.89	
		Middle	3 625.00	19.81	11.00	30.81	
		High	3 695.00	19.80	11.00	30.80	
	64QAM	Low	3 555.00	19.77	11.00	30.77	
		Middle	3 625.00	19.86	11.00	30.86	
		High	3 695.00	19.84	11.00	30.84	
	256QAM	Low	3 555.00	19.77	11.00	30.77	
		Middle	3 625.00	19.73	11.00	30.73	
		High	3 695.00	19.86	11.00	30.86	

Sum Data of Port 0, Port 1, Port 2 and Port 3

Frequency (MHz)	PSD				Limit
	QPSK	16QAM	64QAM	256QAM	
	(dBm/MHz)				
3 555.00	36.84	36.82	36.80	36.82	37
3 625.00	36.85	36.78	36.82	36.81	
3 695.00	36.80	36.83	36.87	36.81	

**CBRS LTE 15 MHz 1 Carrier**

Ant.	Mod	Ch	Frequency (MHz)	Measured Value (dBm/MHz)	Directional Gain (dBi)	PSD (dBm/MHz)	Limit (dBm/MHz)
0	QPSK	Low	3 557.50	19.87	11.00	30.87	37
		Middle	3 625.00	19.80	11.00	30.80	
		High	3 692.50	19.95	11.00	30.95	
	16QAM	Low	3 557.50	19.95	11.00	30.95	
		Middle	3 625.00	19.96	11.00	30.96	
		High	3 692.50	19.88	11.00	30.88	
	64QAM	Low	3 557.50	19.87	11.00	30.87	
		Middle	3 625.00	19.98	11.00	30.98	
		High	3 692.50	19.82	11.00	30.82	
	256QAM	Low	3 557.50	19.89	11.00	30.89	
		Middle	3 625.00	19.94	11.00	30.94	
		High	3 692.50	19.80	11.00	30.80	
1	QPSK	Low	3 557.50	19.97	11.00	30.97	
		Middle	3 625.00	19.81	11.00	30.81	
		High	3 692.50	19.90	11.00	30.90	
	16QAM	Low	3 557.50	19.85	11.00	30.85	
		Middle	3 625.00	19.90	11.00	30.90	
		High	3 692.50	19.99	11.00	30.99	
	64QAM	Low	3 557.50	19.91	11.00	30.91	
		Middle	3 625.00	19.81	11.00	30.81	
		High	3 692.50	19.81	11.00	30.81	
	256QAM	Low	3 557.50	19.91	11.00	30.91	
		Middle	3 625.00	19.82	11.00	30.82	
		High	3 692.50	19.91	11.00	30.91	

Ant.	Mod	Ch	Frequency (MHz)	Measured Value (dBm/MHz)	Directional Gain (dBi)	PSD (dBm/MHz)	Limit (dBm/MHz)
2	QPSK	Low	3 557.50	19.95	11.00	30.95	37
		Middle	3 625.00	19.84	11.00	30.84	
		High	3 692.50	19.96	11.00	30.96	
	16QAM	Low	3 557.50	19.81	11.00	30.81	
		Middle	3 625.00	19.94	11.00	30.94	
		High	3 692.50	19.82	11.00	30.82	
	64QAM	Low	3 557.50	19.92	11.00	30.92	
		Middle	3 625.00	19.98	11.00	30.98	
		High	3 692.50	19.80	11.00	30.80	
	256QAM	Low	3 557.50	19.82	11.00	30.82	
		Middle	3 625.00	19.85	11.00	30.85	
		High	3 692.50	19.97	11.00	30.97	
3	QPSK	Low	3 557.50	19.84	11.00	30.84	
		Middle	3 625.00	19.90	11.00	30.90	
		High	3 692.50	19.86	11.00	30.86	
	16QAM	Low	3 557.50	19.89	11.00	30.89	
		Middle	3 625.00	19.89	11.00	30.89	
		High	3 692.50	19.92	11.00	30.92	
	64QAM	Low	3 557.50	19.98	11.00	30.98	
		Middle	3 625.00	19.89	11.00	30.89	
		High	3 692.50	19.89	11.00	30.89	
	256QAM	Low	3 557.50	19.95	11.00	30.95	
		Middle	3 625.00	19.96	11.00	30.96	
		High	3 692.50	19.85	11.00	30.85	

## Sum Data of Port 0, Port 1, Port 2 and Port 3

Frequency (MHz)	PSD				Limit
	QPSK	16QAM	64QAM	256QAM	
	(dBm/MHz)				
3 557.50	36.93	36.90	36.94	36.91	37
3 625.00	36.86	36.94	36.94	36.91	
3 692.50	36.94	36.92	36.85	36.90	

**CBRS LTE 20 MHz 1 Carrier**

Ant.	Mod	Ch	Frequency (MHz)	Measured Value (dBm/MHz)	Directional Gain (dBi)	PSD (dBm/MHz)	Limit (dBm/MHz)
0	QPSK	Low	3 560.00	19.48	11.00	30.48	37
		Middle	3 625.00	19.23	11.00	30.23	
		High	3 690.00	19.08	11.00	30.08	
	16QAM	Low	3 560.00	19.71	11.00	30.71	
		Middle	3 625.00	19.49	11.00	30.49	
		High	3 690.00	19.32	11.00	30.32	
	64QAM	Low	3 560.00	19.76	11.00	30.76	
		Middle	3 625.00	19.44	11.00	30.44	
		High	3 690.00	19.43	11.00	30.43	
	256QAM	Low	3 560.00	19.76	11.00	30.76	
		Middle	3 625.00	19.42	11.00	30.42	
		High	3 690.00	19.32	11.00	30.32	
1	QPSK	Low	3 560.00	19.50	11.00	30.50	
		Middle	3 625.00	19.17	11.00	30.17	
		High	3 690.00	19.02	11.00	30.02	
	16QAM	Low	3 560.00	19.84	11.00	30.84	
		Middle	3 625.00	19.57	11.00	30.57	
		High	3 690.00	19.48	11.00	30.48	
	64QAM	Low	3 560.00	19.73	11.00	30.73	
		Middle	3 625.00	19.27	11.00	30.27	
		High	3 690.00	19.24	11.00	30.24	
	256QAM	Low	3 560.00	19.70	11.00	30.70	
		Middle	3 625.00	19.38	11.00	30.38	
		High	3 690.00	19.17	11.00	30.17	

Ant.	Mod	Ch	Frequency (MHz)	Measured Value (dBm/MHz)	Directional Gain (dBi)	PSD (dBm/MHz)	Limit (dBm/MHz)
2	QPSK	Low	3 560.00	19.61	11.00	30.61	37
		Middle	3 625.00	19.29	11.00	30.29	
		High	3 690.00	19.04	11.00	30.04	
	16QAM	Low	3 560.00	19.98	11.00	30.98	
		Middle	3 625.00	19.90	11.00	30.90	
		High	3 690.00	19.61	11.00	30.61	
	64QAM	Low	3 560.00	19.78	11.00	30.78	
		Middle	3 625.00	19.49	11.00	30.49	
		High	3 690.00	19.46	11.00	30.46	
	256QAM	Low	3 560.00	19.79	11.00	30.79	
		Middle	3 625.00	19.50	11.00	30.50	
		High	3 690.00	19.39	11.00	30.39	
3	QPSK	Low	3 560.00	19.55	11.00	30.55	
		Middle	3 625.00	19.31	11.00	30.31	
		High	3 690.00	19.06	11.00	30.06	
	16QAM	Low	3 560.00	19.82	11.00	30.82	
		Middle	3 625.00	19.51	11.00	30.51	
		High	3 690.00	19.17	11.00	30.17	
	64QAM	Low	3 560.00	19.77	11.00	30.77	
		Middle	3 625.00	19.50	11.00	30.50	
		High	3 690.00	19.36	11.00	30.36	
	256QAM	Low	3 560.00	19.80	11.00	30.80	
		Middle	3 625.00	19.50	11.00	30.50	
		High	3 690.00	19.38	11.00	30.38	

## Sum Data of Port 0, Port 1, Port 2 and Port 3

Frequency (MHz)	PSD				Limit
	QPSK	16QAM	64QAM	256QAM	
	(dBm/MHz)				
3 560.00	36.56	36.86	36.78	36.78	37
3 625.00	36.27	36.64	36.44	36.47	
3 690.00	36.07	36.42	36.39	36.33	



## Tabular Data of Contiguous PSD

## CBRS NR(60 MHz 1C + 30 MHz 1C)[2C]

Ant.	Mod	Ch	Frequency (MHz)	Measured Value (dBm/MHz)	Directional Gain (dBi)	PSD (dBm/MHz)	Limit (dBm/MHz)
0	QPSK	Low	3 595.00	17.33	13.00	28.33	37
		Middle	3 625.00	17.34	13.00	28.34	
		High	3 655.00	17.28	13.00	28.28	
	16QAM	Low	3 595.00	17.22	13.00	28.22	
		Middle	3 625.00	17.57	13.00	28.57	
		High	3 655.00	17.24	13.00	28.24	
	64QAM	Low	3 595.00	17.32	13.00	28.32	
		Middle	3 625.00	17.38	13.00	28.38	
		High	3 655.00	17.20	13.00	28.20	
	256QAM	Low	3 595.00	17.28	13.00	28.28	
		Middle	3 625.00	17.31	13.00	28.31	
		High	3 655.00	17.26	13.00	28.26	
1	QPSK	Low	3 595.00	17.16	13.00	28.16	
		Middle	3 625.00	17.21	13.00	28.21	
		High	3 655.00	17.37	13.00	28.37	
	16QAM	Low	3 595.00	17.13	13.00	28.13	
		Middle	3 625.00	17.34	13.00	28.34	
		High	3 655.00	17.38	13.00	28.38	
	64QAM	Low	3 595.00	17.21	13.00	28.21	
		Middle	3 625.00	17.37	13.00	28.37	
		High	3 655.00	17.38	13.00	28.38	
256QAM	Low	3 595.00	17.25	13.00	28.25		
	Middle	3 625.00	17.32	13.00	28.32		
	High	3 655.00	17.38	13.00	28.38		

Ant.	Mod	Ch	Frequency (MHz)	Measured Value (dBm/MHz)	Directional Gain (dBi)	PSD (dBm/MHz)	Limit (dBm/MHz)
2	QPSK	Low	3 595.00	16.98	13.00	27.98	37
		Middle	3 625.00	17.04	13.00	28.04	
		High	3 655.00	17.29	13.00	28.29	
	16QAM	Low	3 595.00	17.00	13.00	28.00	
		Middle	3 625.00	17.18	13.00	28.18	
		High	3 655.00	17.21	13.00	28.21	
	64QAM	Low	3 595.00	17.03	13.00	28.03	
		Middle	3 625.00	17.37	13.00	28.37	
		High	3 655.00	17.37	13.00	28.37	
	256QAM	Low	3 595.00	17.09	13.00	28.09	
		Middle	3 625.00	17.23	13.00	28.23	
		High	3 655.00	17.31	13.00	28.31	
3	QPSK	Low	3 595.00	17.32	13.00	28.32	
		Middle	3 625.00	17.19	13.00	28.19	
		High	3 655.00	17.43	13.00	28.43	
	16QAM	Low	3 595.00	17.42	13.00	28.42	
		Middle	3 625.00	17.44	13.00	28.44	
		High	3 655.00	17.43	13.00	28.43	
	64QAM	Low	3 595.00	17.40	13.00	28.40	
		Middle	3 625.00	17.44	13.00	28.44	
		High	3 655.00	17.43	13.00	28.43	
	256QAM	Low	3 595.00	17.43	13.00	28.43	
		Middle	3 625.00	17.43	13.00	28.43	
		High	3 655.00	17.44	13.00	28.44	

Note: 1C: 1 Carrier, 2C: 2 Carrier

## Sum Data of Port 0, Port 1, Port 2 and Port 3

Frequency (MHz)	PSD				Limit
	QPSK	16QAM	64QAM	256QAM	
	(dBm/MHz)				
3 595.00	36.22	36.22	36.26	36.28	37
3 625.00	36.22	36.40	36.41	36.35	
3 655.00	36.37	36.34	36.37	36.37	

## CBRS LTE(15 MHz 1C + 15 MHz 1C)[2C]

Ant.	Mod	Ch	Frequency (MHz)	Measured Value (dBm/MHz)	Directional Gain (dBi)	PSD (dBm/MHz)	Limit (dBm/MHz)
0	QPSK	Low	3 565.00	18.56	12.00	29.56	37
		Middle	3 625.00	18.82	12.00	29.82	
		High	3 685.00	18.15	12.00	29.15	
	16QAM	Low	3 565.00	18.68	12.00	29.68	
		Middle	3 625.00	18.04	12.00	29.04	
		High	3 685.00	18.49	12.00	29.49	
	64QAM	Low	3 565.00	18.44	12.00	29.44	
		Middle	3 625.00	18.04	12.00	29.04	
		High	3 685.00	18.85	12.00	29.85	
	256QAM	Low	3 565.00	18.52	12.00	29.52	
		Middle	3 625.00	18.01	12.00	29.01	
		High	3 685.00	18.67	12.00	29.67	
1	QPSK	Low	3 565.00	18.22	12.00	29.22	
		Middle	3 625.00	18.74	12.00	29.74	
		High	3 685.00	18.28	12.00	29.28	
	16QAM	Low	3 565.00	18.69	12.00	29.69	
		Middle	3 625.00	18.26	12.00	29.26	
		High	3 685.00	18.37	12.00	29.37	
	64QAM	Low	3 565.00	18.34	12.00	29.34	
		Middle	3 625.00	18.21	12.00	29.21	
		High	3 685.00	18.78	12.00	29.78	
	256QAM	Low	3 565.00	18.52	12.00	29.52	
		Middle	3 625.00	18.16	12.00	29.16	
		High	3 685.00	18.74	12.00	29.74	

Ant.	Mod	Ch	Frequency (MHz)	Measured Value (dBm/MHz)	Directional Gain (dBi)	PSD (dBm/MHz)	Limit (dBm/MHz)
2	QPSK	Low	3 565.00	18.42	12.00	29.42	37
		Middle	3 625.00	18.89	12.00	29.89	
		High	3 685.00	18.50	12.00	29.50	
	16QAM	Low	3 565.00	18.85	12.00	29.85	
		Middle	3 625.00	18.16	12.00	29.16	
		High	3 685.00	18.46	12.00	29.46	
	64QAM	Low	3 565.00	18.58	12.00	29.58	
		Middle	3 625.00	18.47	12.00	29.47	
		High	3 685.00	18.97	12.00	29.97	
	256QAM	Low	3 565.00	18.64	12.00	29.64	
		Middle	3 625.00	18.58	12.00	29.58	
		High	3 685.00	18.90	12.00	29.90	
3	QPSK	Low	3 565.00	18.33	12.00	29.33	
		Middle	3 625.00	18.11	12.00	29.11	
		High	3 685.00	18.02	12.00	29.02	
	16QAM	Low	3 565.00	18.65	12.00	29.65	
		Middle	3 625.00	18.14	12.00	29.14	
		High	3 685.00	18.71	12.00	29.71	
	64QAM	Low	3 565.00	18.51	12.00	29.51	
		Middle	3 625.00	18.13	12.00	29.13	
		High	3 685.00	18.60	12.00	29.60	
	256QAM	Low	3 565.00	18.66	12.00	29.66	
		Middle	3 625.00	18.22	12.00	29.22	
		High	3 685.00	18.54	12.00	29.54	

Note: 1C: 1 Carrier, 2C: 2 Carrier

## Sum Data of Port 0, Port 1, Port 2 and Port 3

Frequency (MHz)	PSD				Limit
	QPSK	16QAM	64QAM	256QAM	
	(dBm/MHz)				
3 565.00	36.41	36.74	36.49	36.60	37
3 625.00	36.67	36.17	36.24	36.27	
3 685.00	36.26	36.53	36.82	36.73	

**CBRS LTE 5 MHz 1C + NR 10 MHz 1C[2C]**

Ant.	Mod	Ch	Frequency (MHz)	Measured Value (dBm/MHz)	Directional Gain (dBi)	PSD (dBm/MHz)	Limit (dBm/MHz)
0	QPSK	Low	3 557.50	18.44	11.00	29.44	37
		Middle	3 625.00	18.28	11.00	29.28	
		High	3 692.50	18.36	11.00	29.36	
	16QAM	Low	3 557.50	18.53	11.00	29.53	
		Middle	3 625.00	18.38	11.00	29.38	
		High	3 692.50	18.31	11.00	29.31	
	64QAM	Low	3 557.50	18.54	11.00	29.54	
		Middle	3 625.00	18.48	11.00	29.48	
		High	3 692.50	18.38	11.00	29.38	
	256QAM	Low	3 557.50	18.56	11.00	29.56	
		Middle	3 625.00	18.41	11.00	29.41	
		High	3 692.50	18.36	11.00	29.36	
1	QPSK	Low	3 557.50	18.72	11.00	29.72	
		Middle	3 625.00	18.18	11.00	29.18	
		High	3 692.50	18.46	11.00	29.46	
	16QAM	Low	3 557.50	18.85	11.00	29.85	
		Middle	3 625.00	18.30	11.00	29.30	
		High	3 692.50	18.58	11.00	29.58	
	64QAM	Low	3 557.50	18.87	11.00	29.87	
		Middle	3 625.00	18.33	11.00	29.33	
		High	3 692.50	18.47	11.00	29.47	
	256QAM	Low	3 557.50	18.94	11.00	29.94	
		Middle	3 625.00	18.33	11.00	29.33	
		High	3 692.50	18.48	11.00	29.48	

Ant.	Mod	Ch	Frequency (MHz)	Measured Value (dBm/MHz)	Directional Gain (dBi)	PSD (dBm/MHz)	Limit (dBm/MHz)
2	QPSK	Low	3 557.50	18.55	11.00	29.55	37
		Middle	3 625.00	18.00	11.00	29.00	
		High	3 692.50	18.36	11.00	29.36	
	16QAM	Low	3 557.50	18.65	11.00	29.65	
		Middle	3 625.00	18.15	11.00	29.15	
		High	3 692.50	18.40	11.00	29.40	
	64QAM	Low	3 557.50	18.61	11.00	29.61	
		Middle	3 625.00	18.08	11.00	29.08	
		High	3 692.50	18.41	11.00	29.41	
	256QAM	Low	3 557.50	18.73	11.00	29.73	
		Middle	3 625.00	18.10	11.00	29.10	
		High	3 692.50	18.41	11.00	29.41	
3	QPSK	Low	3 557.50	18.85	11.00	29.85	
		Middle	3 625.00	18.44	11.00	29.44	
		High	3 692.50	18.67	11.00	29.67	
	16QAM	Low	3 557.50	18.97	11.00	29.97	
		Middle	3 625.00	18.61	11.00	29.61	
		High	3 692.50	18.79	11.00	29.79	
	64QAM	Low	3 557.50	18.99	11.00	29.99	
		Middle	3 625.00	18.66	11.00	29.66	
		High	3 692.50	18.68	11.00	29.68	
	256QAM	Low	3 557.50	18.83	11.00	29.83	
		Middle	3 625.00	18.66	11.00	29.66	
		High	3 692.50	18.70	11.00	29.70	

Note: 1C: 1 Carrier, 2C: 2 Carrier



Sum Data of Port 0, Port 1, Port 2 and Port 3

Frequency (MHz)	PSD				Limit
	QPSK	16QAM	64QAM	256QAM	
	(dBm/MHz)				
3 557.50	35.66	35.77	35.78	35.79	37
3 625.00	35.25	35.38	35.41	35.40	
3 692.50	35.48	35.55	35.51	35.51	

**CBRS NR(20 MHz 1C + 20 MHz 1C + 10 MHz 1C)[3C]**

Ant.	Mod	Ch	Frequency (MHz)	Measured Value (dBm/MHz)	Directional Gain (dBi)	PSD (dBm/MHz)	Limit (dBm/MHz)
0	QPSK	Low	3 575.00	18.11	12.00	29.11	37
		Middle	3 625.00	18.25	12.00	29.25	
		High	3 675.00	18.23	12.00	29.23	
	16QAM	Low	3 575.00	18.15	12.00	29.15	
		Middle	3 625.00	18.16	12.00	29.16	
		High	3 675.00	18.27	12.00	29.27	
	64QAM	Low	3 575.00	18.23	12.00	29.23	
		Middle	3 625.00	18.32	12.00	29.32	
		High	3 675.00	18.34	12.00	29.34	
	256QAM	Low	3 575.00	18.27	12.00	29.27	
		Middle	3 625.00	18.27	12.00	29.27	
		High	3 675.00	18.33	12.00	29.33	
1	QPSK	Low	3 575.00	18.26	12.00	29.26	
		Middle	3 625.00	18.21	12.00	29.21	
		High	3 675.00	18.43	12.00	29.43	
	16QAM	Low	3 575.00	18.33	12.00	29.33	
		Middle	3 625.00	18.10	12.00	29.10	
		High	3 675.00	18.42	12.00	29.42	
	64QAM	Low	3 575.00	18.24	12.00	29.24	
		Middle	3 625.00	18.20	12.00	29.20	
		High	3 675.00	18.46	12.00	29.46	
	256QAM	Low	3 575.00	18.37	12.00	29.37	
		Middle	3 625.00	18.21	12.00	29.21	
		High	3 675.00	18.39	12.00	29.39	

Ant.	Mod	Ch	Frequency (MHz)	Measured Value (dBm/MHz)	Directional Gain (dBi)	PSD (dBm/MHz)	Limit (dBm/MHz)
2	QPSK	Low	3 575.00	18.19	12.00	29.19	37
		Middle	3 625.00	18.02	12.00	29.02	
		High	3 675.00	18.43	12.00	29.43	
	16QAM	Low	3 575.00	18.19	12.00	29.19	
		Middle	3 625.00	17.96	12.00	28.96	
		High	3 675.00	18.40	12.00	29.40	
	64QAM	Low	3 575.00	18.32	12.00	29.32	
		Middle	3 625.00	18.12	12.00	29.12	
		High	3 675.00	18.51	12.00	29.51	
	256QAM	Low	3 575.00	18.29	12.00	29.29	
		Middle	3 625.00	18.07	12.00	29.07	
		High	3 675.00	18.55	12.00	29.55	
3	QPSK	Low	3 575.00	18.40	12.00	29.40	
		Middle	3 625.00	18.28	12.00	29.28	
		High	3 675.00	18.64	12.00	29.64	
	16QAM	Low	3 575.00	18.51	12.00	29.51	
		Middle	3 625.00	18.39	12.00	29.39	
		High	3 675.00	18.67	12.00	29.67	
	64QAM	Low	3 575.00	18.56	12.00	29.56	
		Middle	3 625.00	18.34	12.00	29.34	
		High	3 675.00	18.71	12.00	29.71	
	256QAM	Low	3 575.00	18.52	12.00	29.52	
		Middle	3 625.00	18.31	12.00	29.31	
		High	3 675.00	18.59	12.00	29.59	

Note: 1C: 1 Carrier, 3C: 3 Carrier

## Sum Data of Port 0, Port 1, Port 2 and Port 3

Frequency (MHz)	PSD				Limit
	QPSK	16QAM	64QAM	256QAM	
	(dBm/MHz)				
3 575.00	36.26	36.32	36.36	36.38	37
3 625.00	36.21	36.17	36.27	36.24	
3 675.00	36.46	36.46	36.53	36.49	

**CBRS NR(30 MHz 1C + 30 MHz 1C + 10 MHz 1C)[3C]**

Ant.	Mod	Ch	Frequency (MHz)	Measured Value (dBm/MHz)	Directional Gain (dBi)	PSD (dBm/MHz)	Limit (dBm/MHz)
0	QPSK	Low	3 585.00	17.23	13.00	28.23	37
		Middle	3 625.00	17.09	13.00	28.09	
		High	3 665.00	17.25	13.00	28.25	
	16QAM	Low	3 585.00	17.26	13.00	28.26	
		Middle	3 625.00	17.15	13.00	28.15	
		High	3 665.00	17.33	13.00	28.33	
	64QAM	Low	3 585.00	17.36	13.00	28.36	
		Middle	3 625.00	17.25	13.00	28.25	
		High	3 665.00	17.37	13.00	28.37	
	256QAM	Low	3 585.00	17.28	13.00	28.28	
		Middle	3 625.00	17.24	13.00	28.24	
		High	3 665.00	17.37	13.00	28.37	
1	QPSK	Low	3 585.00	17.24	13.00	28.24	
		Middle	3 625.00	17.19	13.00	28.19	
		High	3 665.00	17.43	13.00	28.43	
	16QAM	Low	3 585.00	17.44	13.00	28.44	
		Middle	3 625.00	17.33	13.00	28.33	
		High	3 665.00	17.47	13.00	28.47	
	64QAM	Low	3 585.00	17.40	13.00	28.40	
		Middle	3 625.00	17.33	13.00	28.33	
		High	3 665.00	17.52	13.00	28.52	
	256QAM	Low	3 585.00	17.40	13.00	28.40	
		Middle	3 625.00	17.39	13.00	28.39	
		High	3 665.00	17.50	13.00	28.50	

Ant.	Mod	Ch	Frequency (MHz)	Measured Value (dBm/MHz)	Directional Gain (dBi)	PSD (dBm/MHz)	Limit (dBm/MHz)
2	QPSK	Low	3 585.00	17.13	13.00	28.13	37
		Middle	3 625.00	17.03	13.00	28.03	
		High	3 665.00	17.46	13.00	28.46	
	16QAM	Low	3 585.00	17.19	13.00	28.19	
		Middle	3 625.00	17.12	13.00	28.12	
		High	3 665.00	17.48	13.00	28.48	
	64QAM	Low	3 585.00	17.21	13.00	28.21	
		Middle	3 625.00	17.13	13.00	28.13	
		High	3 665.00	17.49	13.00	28.49	
	256QAM	Low	3 585.00	17.12	13.00	28.12	
		Middle	3 625.00	17.16	13.00	28.16	
		High	3 665.00	17.49	13.00	28.49	
3	QPSK	Low	3 585.00	17.37	13.00	28.37	
		Middle	3 625.00	17.28	13.00	28.28	
		High	3 665.00	17.55	13.00	28.55	
	16QAM	Low	3 585.00	17.49	13.00	28.49	
		Middle	3 625.00	17.37	13.00	28.37	
		High	3 665.00	17.67	13.00	28.67	
	64QAM	Low	3 585.00	17.34	13.00	28.34	
		Middle	3 625.00	17.36	13.00	28.36	
		High	3 665.00	17.66	13.00	28.66	
	256QAM	Low	3 585.00	17.50	13.00	28.50	
		Middle	3 625.00	17.39	13.00	28.39	
		High	3 665.00	17.69	13.00	28.69	

Note: 1C: 1 Carrier, 3C: 3 Carrier

## Sum Data of Port 0, Port 1, Port 2 and Port 3

Frequency (MHz)	PSD				Limit
	QPSK	16QAM	64QAM	256QAM	
	(dBm/MHz)				
3 585.00	36.26	36.37	36.35	36.35	37
3 625.00	36.17	36.26	36.29	36.32	
3 665.00	36.44	36.51	36.53	36.53	

**CBRS LTE(15 MHz 1C + 15 MHz 1C + 10 MHz 1C)[3C]**

Ant.	Mod	Ch	Frequency (MHz)	Measured Value (dBm/MHz)	Directional Gain (dBi)	PSD (dBm/MHz)	Limit (dBm/MHz)
0	QPSK	Low	3 570.00	18.16	12.00	29.16	37
		Middle	3 625.00	18.12	12.00	29.12	
		High	3 680.00	18.13	12.00	29.13	
	16QAM	Low	3 570.00	18.60	12.00	29.60	
		Middle	3 625.00	18.15	12.00	29.15	
		High	3 680.00	18.61	12.00	29.61	
	64QAM	Low	3 570.00	18.14	12.00	29.14	
		Middle	3 625.00	18.21	12.00	29.21	
		High	3 680.00	18.18	12.00	29.18	
	256QAM	Low	3 570.00	18.11	12.00	29.11	
		Middle	3 625.00	18.19	12.00	29.19	
		High	3 680.00	18.25	12.00	29.25	
1	QPSK	Low	3 570.00	18.23	12.00	29.23	
		Middle	3 625.00	18.09	12.00	29.09	
		High	3 680.00	18.20	12.00	29.20	
	16QAM	Low	3 570.00	18.54	12.00	29.54	
		Middle	3 625.00	18.39	12.00	29.39	
		High	3 680.00	18.73	12.00	29.73	
	64QAM	Low	3 570.00	18.27	12.00	29.27	
		Middle	3 625.00	18.20	12.00	29.20	
		High	3 680.00	18.32	12.00	29.32	
	256QAM	Low	3 570.00	18.25	12.00	29.25	
		Middle	3 625.00	18.14	12.00	29.14	
		High	3 680.00	18.38	12.00	29.38	



Ant.	Mod	Ch	Frequency (MHz)	Measured Value (dBm/MHz)	Directional Gain (dBi)	PSD (dBm/MHz)	Limit (dBm/MHz)
2	QPSK	Low	3 570.00	18.20	12.00	29.20	37
		Middle	3 625.00	17.97	12.00	28.97	
		High	3 680.00	18.15	12.00	29.15	
	16QAM	Low	3 570.00	18.36	12.00	29.36	
		Middle	3 625.00	18.21	12.00	29.21	
		High	3 680.00	18.60	12.00	29.60	
	64QAM	Low	3 570.00	18.24	12.00	29.24	
		Middle	3 625.00	18.02	12.00	29.02	
		High	3 680.00	18.30	12.00	29.30	
	256QAM	Low	3 570.00	18.18	12.00	29.18	
		Middle	3 625.00	18.03	12.00	29.03	
		High	3 680.00	18.35	12.00	29.35	
3	QPSK	Low	3 570.00	18.43	12.00	29.43	
		Middle	3 625.00	18.20	12.00	29.20	
		High	3 680.00	18.39	12.00	29.39	
	16QAM	Low	3 570.00	18.63	12.00	29.63	
		Middle	3 625.00	18.52	12.00	29.52	
		High	3 680.00	18.82	12.00	29.82	
	64QAM	Low	3 570.00	18.35	12.00	29.35	
		Middle	3 625.00	18.31	12.00	29.31	
		High	3 680.00	18.50	12.00	29.50	
	256QAM	Low	3 570.00	18.41	12.00	29.41	
		Middle	3 625.00	18.41	12.00	29.41	
		High	3 680.00	18.52	12.00	29.52	

Note: 1C: 1 Carrier, 3C: 3 Carrier

## Sum Data of Port 0, Port 1, Port 2 and Port 3

Frequency (MHz)	PSD				Limit
	QPSK	16QAM	64QAM	256QAM	
	(dBm/MHz)				
3 570.00	36.28	36.56	36.27	36.26	37
3 625.00	36.12	36.34	36.21	36.22	
3 680.00	36.24	36.71	36.35	36.40	

**CBRS LTE(20 MHz 1C + 15 MHz 1C + 15 MHz 1C)[3C]**

Ant.	Mod	Ch	Frequency (MHz)	Measured Value (dBm/MHz)	Directional Gain (dBi)	PSD (dBm/MHz)	Limit (dBm/MHz)
0	QPSK	Low	3 575.00	18.92	12.00	29.92	37
		Middle	3 625.00	18.02	12.00	29.02	
		High	3 675.00	18.10	12.00	29.10	
	16QAM	Low	3 575.00	18.65	12.00	29.65	
		Middle	3 625.00	18.18	12.00	29.18	
		High	3 675.00	18.33	12.00	29.33	
	64QAM	Low	3 575.00	18.03	12.00	29.03	
		Middle	3 625.00	18.27	12.00	29.27	
		High	3 675.00	18.15	12.00	29.15	
	256QAM	Low	3 575.00	18.11	12.00	29.11	
		Middle	3 625.00	18.23	12.00	29.23	
		High	3 675.00	18.34	12.00	29.34	
1	QPSK	Low	3 575.00	18.05	12.00	29.05	
		Middle	3 625.00	18.99	12.00	29.99	
		High	3 675.00	18.17	12.00	29.17	
	16QAM	Low	3 575.00	18.53	12.00	29.53	
		Middle	3 625.00	18.35	12.00	29.35	
		High	3 675.00	18.77	12.00	29.77	
	64QAM	Low	3 575.00	18.14	12.00	29.14	
		Middle	3 625.00	18.20	12.00	29.20	
		High	3 675.00	18.19	12.00	29.19	
	256QAM	Low	3 575.00	18.27	12.00	29.27	
		Middle	3 625.00	18.21	12.00	29.21	
		High	3 675.00	18.44	12.00	29.44	

Ant.	Mod	Ch	Frequency (MHz)	Measured Value (dBm/MHz)	Directional Gain (dBi)	PSD (dBm/MHz)	Limit (dBm/MHz)
2	QPSK	Low	3 575.00	18.05	12.00	29.05	37
		Middle	3 625.00	18.03	12.00	29.03	
		High	3 675.00	18.06	12.00	29.06	
	16QAM	Low	3 575.00	18.38	12.00	29.38	
		Middle	3 625.00	18.44	12.00	29.44	
		High	3 675.00	18.30	12.00	29.30	
	64QAM	Low	3 575.00	18.24	12.00	29.24	
		Middle	3 625.00	18.01	12.00	29.01	
		High	3 675.00	18.18	12.00	29.18	
	256QAM	Low	3 575.00	18.26	12.00	29.26	
		Middle	3 625.00	18.08	12.00	29.08	
		High	3 675.00	18.42	12.00	29.42	
3	QPSK	Low	3 575.00	18.38	12.00	29.38	
		Middle	3 625.00	18.31	12.00	29.31	
		High	3 675.00	18.28	12.00	29.28	
	16QAM	Low	3 575.00	18.81	12.00	29.81	
		Middle	3 625.00	18.74	12.00	29.74	
		High	3 675.00	18.63	12.00	29.63	
	64QAM	Low	3 575.00	18.48	12.00	29.48	
		Middle	3 625.00	18.20	12.00	29.20	
		High	3 675.00	18.38	12.00	29.38	
	256QAM	Low	3 575.00	18.54	12.00	29.54	
		Middle	3 625.00	18.33	12.00	29.33	
		High	3 675.00	18.62	12.00	29.62	

Note: 1C: 1 Carrier, 3C: 3 Carrier

## Sum Data of Port 0, Port 1, Port 2 and Port 3

Frequency (MHz)	PSD				Limit
	QPSK	16QAM	64QAM	256QAM	
	(dBm/MHz)				
3 575.00	36.39	36.62	36.24	36.32	37
3 625.00	36.38	36.45	36.19	36.23	
3 675.00	36.17	36.53	36.25	36.48	

**CBRS LTE(20 MHz 1C + 20 MHz 1C + 20 MHz 1C)[3C]**

Ant.	Mod	Ch	Frequency (MHz)	Measured Value (dBm/MHz)	Directional Gain (dBi)	PSD (dBm/MHz)	Limit (dBm/MHz)
0	QPSK	Low	3 580.00	18.19	12.00	29.19	37
		Middle	3 625.00	18.92	12.00	29.92	
		High	3 670.00	18.97	12.00	29.97	
	16QAM	Low	3 580.00	18.63	12.00	29.63	
		Middle	3 625.00	18.41	12.00	29.41	
		High	3 670.00	18.26	12.00	29.26	
	64QAM	Low	3 580.00	18.08	12.00	29.08	
		Middle	3 625.00	18.99	12.00	29.99	
		High	3 670.00	18.07	12.00	29.07	
	256QAM	Low	3 580.00	18.13	12.00	29.13	
		Middle	3 625.00	18.99	12.00	29.99	
		High	3 670.00	18.04	12.00	29.04	
1	QPSK	Low	3 580.00	18.27	12.00	29.27	
		Middle	3 625.00	18.01	12.00	29.01	
		High	3 670.00	18.98	12.00	29.98	
	16QAM	Low	3 580.00	18.57	12.00	29.57	
		Middle	3 625.00	18.54	12.00	29.54	
		High	3 670.00	18.43	12.00	29.43	
	64QAM	Low	3 580.00	18.17	12.00	29.17	
		Middle	3 625.00	18.01	12.00	29.01	
		High	3 670.00	18.15	12.00	29.15	
	256QAM	Low	3 580.00	18.06	12.00	29.06	
		Middle	3 625.00	18.08	12.00	29.08	
		High	3 670.00	18.08	12.00	29.08	

Ant.	Mod	Ch	Frequency (MHz)	Measured Value (dBm/MHz)	Directional Gain (dBi)	PSD (dBm/MHz)	Limit (dBm/MHz)
2	QPSK	Low	3 580.00	18.40	12.00	29.40	37
		Middle	3 625.00	18.05	12.00	29.05	
		High	3 670.00	18.05	12.00	29.05	
	16QAM	Low	3 580.00	18.79	12.00	29.79	
		Middle	3 625.00	18.25	12.00	29.25	
		High	3 670.00	18.47	12.00	29.47	
	64QAM	Low	3 580.00	18.19	12.00	29.19	
		Middle	3 625.00	18.03	12.00	29.03	
		High	3 670.00	18.21	12.00	29.21	
	256QAM	Low	3 580.00	18.22	12.00	29.22	
		Middle	3 625.00	18.07	12.00	29.07	
		High	3 670.00	18.17	12.00	29.17	
3	QPSK	Low	3 580.00	18.62	12.00	29.62	
		Middle	3 625.00	18.39	12.00	29.39	
		High	3 670.00	18.29	12.00	29.29	
	16QAM	Low	3 580.00	18.95	12.00	29.95	
		Middle	3 625.00	18.73	12.00	29.73	
		High	3 670.00	18.75	12.00	29.75	
	64QAM	Low	3 580.00	18.42	12.00	29.42	
		Middle	3 625.00	18.40	12.00	29.40	
		High	3 670.00	18.47	12.00	29.47	
	256QAM	Low	3 580.00	18.52	12.00	29.52	
		Middle	3 625.00	18.41	12.00	29.41	
		High	3 670.00	18.47	12.00	29.47	

Note: 1C: 1 Carrier, 3C: 3 Carrier

## Sum Data of Port 0, Port 1, Port 2 and Port 3

Frequency (MHz)	PSD				Limit
	QPSK	16QAM	64QAM	256QAM	
	(dBm/MHz)				
3 580.00	36.39	36.76	36.24	36.26	37
3 625.00	36.38	36.51	36.40	36.42	
3 670.00	36.61	36.50	36.25	36.21	



**CBRS LTE(20 MHz 1C + 20 MHz 1C + 20 MHz 1C + 20 MHz 1C)[4C]**

Ant.	Mod	Ch	Frequency (MHz)	Measured Value (dBm/MHz)	Directional Gain (dBi)	PSD (dBm/MHz)	Limit (dBm/MHz)
0	QPSK	Low	3 590.00	17.20	13.00	28.20	37
		Middle	3 625.00	17.19	13.00	28.19	
		High	3 660.00	17.18	13.00	28.18	
	16QAM	Low	3 590.00	17.57	13.00	28.57	
		Middle	3 625.00	17.23	13.00	28.23	
		High	3 660.00	17.39	13.00	28.39	
	64QAM	Low	3 590.00	17.30	13.00	28.30	
		Middle	3 625.00	17.32	13.00	28.32	
		High	3 660.00	17.14	13.00	28.14	
	256QAM	Low	3 590.00	17.20	13.00	28.20	
		Middle	3 625.00	17.20	13.00	28.20	
		High	3 660.00	17.17	13.00	28.17	
1	QPSK	Low	3 590.00	17.24	13.00	28.24	
		Middle	3 625.00	17.21	13.00	28.21	
		High	3 660.00	17.30	13.00	28.30	
	16QAM	Low	3 590.00	17.57	13.00	28.57	
		Middle	3 625.00	17.58	13.00	28.58	
		High	3 660.00	17.51	13.00	28.51	
	64QAM	Low	3 590.00	17.34	13.00	28.34	
		Middle	3 625.00	17.22	13.00	28.22	
		High	3 660.00	17.41	13.00	28.41	
	256QAM	Low	3 590.00	17.44	13.00	28.44	
		Middle	3 625.00	17.18	13.00	28.18	
		High	3 660.00	17.32	13.00	28.32	

Ant.	Mod	Ch	Frequency (MHz)	Measured Value (dBm/MHz)	Directional Gain (dBi)	PSD (dBm/MHz)	Limit (dBm/MHz)
2	QPSK	Low	3 590.00	17.14	13.00	28.14	37
		Middle	3 625.00	17.05	13.00	28.05	
		High	3 660.00	17.23	13.00	28.23	
	16QAM	Low	3 590.00	17.50	13.00	28.50	
		Middle	3 625.00	17.29	13.00	28.29	
		High	3 660.00	17.21	13.00	28.21	
	64QAM	Low	3 590.00	17.24	13.00	28.24	
		Middle	3 625.00	17.11	13.00	28.11	
		High	3 660.00	17.22	13.00	28.22	
	256QAM	Low	3 590.00	17.31	13.00	28.31	
		Middle	3 625.00	17.15	13.00	28.15	
		High	3 660.00	17.21	13.00	28.21	
3	QPSK	Low	3 590.00	17.36	13.00	28.36	
		Middle	3 625.00	17.36	13.00	28.36	
		High	3 660.00	17.44	13.00	28.44	
	16QAM	Low	3 590.00	17.81	13.00	28.81	
		Middle	3 625.00	17.60	13.00	28.60	
		High	3 660.00	17.70	13.00	28.70	
	64QAM	Low	3 590.00	17.45	13.00	28.45	
		Middle	3 625.00	17.42	13.00	28.42	
		High	3 660.00	17.51	13.00	28.51	
	256QAM	Low	3 590.00	17.47	13.00	28.47	
		Middle	3 625.00	17.37	13.00	28.37	
		High	3 660.00	17.45	13.00	28.45	

Note: 1C: 1 Carrier, 4C: 4 Carrier

## Sum Data of Port 0, Port 1, Port 2 and Port 3

Frequency (MHz)	PSD				Limit
	QPSK	16QAM	64QAM	256QAM	
	(dBm/MHz)				
3 590.00	36.26	36.64	36.35	36.38	37
3 625.00	36.23	36.45	36.29	36.25	
3 660.00	36.31	36.48	36.34	36.31	

**CBRS LTE(15 MHz 1C + 15 MHz 1C + 15 MHz 1C + 15 MHz 1C + 10 MHz 1C)[5C]**

Ant.	Mod	Ch	Frequency (MHz)	Measured Value (dBm/MHz)	Directional Gain (dBi)	PSD (dBm/MHz)	Limit (dBm/MHz)
0	QPSK	Low	3 585.00	17.21	13.00	28.21	37
		Middle	3 625.00	17.08	13.00	28.08	
		High	3 665.00	17.01	13.00	28.01	
	16QAM	Low	3 585.00	17.69	13.00	28.69	
		Middle	3 625.00	17.09	13.00	28.09	
		High	3 665.00	17.46	13.00	28.46	
	64QAM	Low	3 585.00	17.20	13.00	28.20	
		Middle	3 625.00	17.14	13.00	28.14	
		High	3 665.00	17.14	13.00	28.14	
	256QAM	Low	3 585.00	17.04	13.00	28.04	
		Middle	3 625.00	17.17	13.00	28.17	
		High	3 665.00	17.15	13.00	28.15	
1	QPSK	Low	3 585.00	17.31	13.00	28.31	
		Middle	3 625.00	17.10	13.00	28.10	
		High	3 665.00	17.14	13.00	28.14	
	16QAM	Low	3 585.00	17.60	13.00	28.60	
		Middle	3 625.00	17.63	13.00	28.63	
		High	3 665.00	17.61	13.00	28.61	
	64QAM	Low	3 585.00	17.41	13.00	28.41	
		Middle	3 625.00	17.15	13.00	28.15	
		High	3 665.00	17.31	13.00	28.31	
	256QAM	Low	3 585.00	17.39	13.00	28.39	
		Middle	3 625.00	17.23	13.00	28.23	
		High	3 665.00	17.32	13.00	28.32	

Ant.	Mod	Ch	Frequency (MHz)	Measured Value (dBm/MHz)	Directional Gain (dBi)	PSD (dBm/MHz)	Limit (dBm/MHz)
2	QPSK	Low	3 585.00	17.21	13.00	28.21	37
		Middle	3 625.00	17.89	13.00	28.89	
		High	3 665.00	17.07	13.00	28.07	
	16QAM	Low	3 585.00	17.41	13.00	28.41	
		Middle	3 625.00	17.37	13.00	28.37	
		High	3 665.00	17.35	13.00	28.35	
	64QAM	Low	3 585.00	17.20	13.00	28.20	
		Middle	3 625.00	17.04	13.00	28.04	
		High	3 665.00	17.19	13.00	28.19	
	256QAM	Low	3 585.00	17.45	13.00	28.45	
		Middle	3 625.00	17.03	13.00	28.03	
		High	3 665.00	17.16	13.00	28.16	
3	QPSK	Low	3 585.00	17.38	13.00	28.38	
		Middle	3 625.00	17.21	13.00	28.21	
		High	3 665.00	17.30	13.00	28.30	
	16QAM	Low	3 585.00	17.62	13.00	28.62	
		Middle	3 625.00	17.60	13.00	28.60	
		High	3 665.00	17.84	13.00	28.84	
	64QAM	Low	3 585.00	17.42	13.00	28.42	
		Middle	3 625.00	17.31	13.00	28.31	
		High	3 665.00	17.45	13.00	28.45	
	256QAM	Low	3 585.00	17.67	13.00	28.67	
		Middle	3 625.00	17.35	13.00	28.35	
		High	3 665.00	17.42	13.00	28.42	

Note: 1C: 1 Carrier, 5C: 5 Carrier

## Sum Data of Port 0, Port 1, Port 2 and Port 3

Frequency (MHz)	PSD				Limit
	QPSK	16QAM	64QAM	256QAM	
	(dBm/MHz)				
3 585.00	36.30	36.60	36.33	36.42	37
3 625.00	36.35	36.45	36.18	36.22	
3 665.00	36.15	36.59	36.30	36.28	

**CBRS LTE(20 MHz 1C + 20 MHz 1C + 20 MHz 1C + 20 MHz 1C + 10 MHz 1C)[5C]**

Ant.	Mod	Ch	Frequency (MHz)	Measured Value (dBm/MHz)	Directional Gain (dBi)	PSD (dBm/MHz)	Limit (dBm/MHz)
0	QPSK	Low	3 595.00	17.35	13.00	28.35	37
		Middle	3 625.00	17.32	13.00	28.32	
		High	3 655.00	17.32	13.00	28.32	
	16QAM	Low	3 595.00	17.35	13.00	28.35	
		Middle	3 625.00	17.34	13.00	28.34	
		High	3 655.00	17.36	13.00	28.36	
	64QAM	Low	3 595.00	17.35	13.00	28.35	
		Middle	3 625.00	17.35	13.00	28.35	
		High	3 655.00	17.36	13.00	28.36	
	256QAM	Low	3 595.00	17.31	13.00	28.31	
		Middle	3 625.00	17.31	13.00	28.31	
		High	3 655.00	17.32	13.00	28.32	
1	QPSK	Low	3 595.00	17.32	13.00	28.32	
		Middle	3 625.00	17.37	13.00	28.37	
		High	3 655.00	17.32	13.00	28.32	
	16QAM	Low	3 595.00	17.31	13.00	28.31	
		Middle	3 625.00	17.34	13.00	28.34	
		High	3 655.00	17.38	13.00	28.38	
	64QAM	Low	3 595.00	17.38	13.00	28.38	
		Middle	3 625.00	17.36	13.00	28.36	
		High	3 655.00	17.34	13.00	28.34	
	256QAM	Low	3 595.00	17.32	13.00	28.32	
		Middle	3 625.00	17.33	13.00	28.33	
		High	3 655.00	17.39	13.00	28.39	

Ant.	Mod	Ch	Frequency (MHz)	Measured Value (dBm/MHz)	Directional Gain (dBi)	PSD (dBm/MHz)	Limit (dBm/MHz)
2	QPSK	Low	3 595.00	17.34	13.00	28.34	37
		Middle	3 625.00	17.34	13.00	28.34	
		High	3 655.00	17.33	13.00	28.33	
	16QAM	Low	3 595.00	17.36	13.00	28.36	
		Middle	3 625.00	17.39	13.00	28.39	
		High	3 655.00	17.35	13.00	28.35	
	64QAM	Low	3 595.00	17.32	13.00	28.32	
		Middle	3 625.00	17.34	13.00	28.34	
		High	3 655.00	17.35	13.00	28.35	
	256QAM	Low	3 595.00	17.33	13.00	28.33	
		Middle	3 625.00	17.34	13.00	28.34	
		High	3 655.00	17.32	13.00	28.32	
3	QPSK	Low	3 595.00	17.37	13.00	28.37	
		Middle	3 625.00	17.35	13.00	28.35	
		High	3 655.00	17.39	13.00	28.39	
	16QAM	Low	3 595.00	17.38	13.00	28.38	
		Middle	3 625.00	17.36	13.00	28.36	
		High	3 655.00	17.39	13.00	28.39	
	64QAM	Low	3 595.00	17.36	13.00	28.36	
		Middle	3 625.00	17.34	13.00	28.34	
		High	3 655.00	17.35	13.00	28.35	
	256QAM	Low	3 595.00	17.38	13.00	28.38	
		Middle	3 625.00	17.36	13.00	28.36	
		High	3 655.00	17.31	13.00	28.31	

Note: 1C: 1 Carrier, 5C: 5 Carrier



## Sum Data of Port 0, Port 1, Port 2 and Port 3

Frequency (MHz)	PSD				Limit
	QPSK	16QAM	64QAM	256QAM	
	(dBm/MHz)				
3 595.00	36.37	36.37	36.38	36.36	37
3 625.00	36.37	36.38	36.37	36.36	
3 655.00	36.36	36.39	36.37	36.35	

**CBRS LTE(20 MHz 1C + 20 MHz 1C + 20 MHz 1C + 20 MHz 1C + 20 MHz 1C)[5C]**

Ant.	Mod	Ch	Frequency (MHz)	Measured Value (dBm/MHz)	Directional Gain (dBi)	PSD (dBm/MHz)	Limit (dBm/MHz)
0	QPSK	Low	3 600.00	16.72	13.00	27.72	37
		Middle	3 625.00	16.91	13.00	27.91	
		High	3 650.00	16.73	13.00	27.73	
	16QAM	Low	3 600.00	16.91	13.00	27.91	
		Middle	3 625.00	16.77	13.00	27.77	
		High	3 650.00	16.91	13.00	27.91	
	64QAM	Low	3 600.00	16.79	13.00	27.79	
		Middle	3 625.00	16.58	13.00	27.58	
		High	3 650.00	16.93	13.00	27.93	
	256QAM	Low	3 600.00	16.71	13.00	27.71	
		Middle	3 625.00	16.93	13.00	27.93	
		High	3 650.00	16.51	13.00	27.51	
1	QPSK	Low	3 600.00	16.90	13.00	27.90	
		Middle	3 625.00	16.77	13.00	27.77	
		High	3 650.00	16.74	13.00	27.74	
	16QAM	Low	3 600.00	16.99	13.00	27.99	
		Middle	3 625.00	16.77	13.00	27.77	
		High	3 650.00	16.59	13.00	27.59	
	64QAM	Low	3 600.00	16.72	13.00	27.72	
		Middle	3 625.00	16.52	13.00	27.52	
		High	3 650.00	16.50	13.00	27.50	
	256QAM	Low	3 600.00	16.93	13.00	27.93	
		Middle	3 625.00	16.72	13.00	27.72	
		High	3 650.00	16.53	13.00	27.53	

Ant.	Mod	Ch	Frequency (MHz)	Measured Value (dBm/MHz)	Directional Gain (dBi)	PSD (dBm/MHz)	Limit (dBm/MHz)
2	QPSK	Low	3 600.00	16.79	13.00	27.79	37
		Middle	3 625.00	16.58	13.00	27.58	
		High	3 650.00	16.90	13.00	27.90	
	16QAM	Low	3 600.00	16.72	13.00	27.72	
		Middle	3 625.00	16.99	13.00	27.99	
		High	3 650.00	16.28	13.00	27.28	
	64QAM	Low	3 600.00	16.29	13.00	27.29	
		Middle	3 625.00	16.77	13.00	27.77	
		High	3 650.00	16.17	13.00	27.17	
	256QAM	Low	3 600.00	16.30	13.00	27.30	
		Middle	3 625.00	16.97	13.00	27.97	
		High	3 650.00	16.19	13.00	27.19	
3	QPSK	Low	3 600.00	16.35	13.00	27.35	
		Middle	3 625.00	16.39	13.00	27.39	
		High	3 650.00	16.19	13.00	27.19	
	16QAM	Low	3 600.00	16.22	13.00	27.22	
		Middle	3 625.00	16.53	13.00	27.53	
		High	3 650.00	16.67	13.00	27.67	
	64QAM	Low	3 600.00	16.49	13.00	27.49	
		Middle	3 625.00	16.30	13.00	27.30	
		High	3 650.00	16.47	13.00	27.47	
	256QAM	Low	3 600.00	16.59	13.00	27.59	
		Middle	3 625.00	16.23	13.00	27.23	
		High	3 650.00	16.38	13.00	27.38	

Note: 1C: 1 Carrier, 5C: 5 Carrier

## Sum Data of Port 0, Port 1, Port 2 and Port 3

Frequency (MHz)	PSD				Limit
	QPSK	16QAM	64QAM	256QAM	
	(dBm/MHz)				
3 600.00	35.71	35.74	35.60	35.66	37
3 625.00	35.69	35.79	35.56	35.75	
3 650.00	35.67	35.64	35.55	35.43	

**CBRS NR 40 MHz 1C + NR 20 MHz 1C + NR 20 MHz + LTE 10 MHz 1C + LTE 10 MHz 1C 1C[5C]**

Ant.	Mod	Ch	Frequency (MHz)	Measured Value (dBm/MHz)	Directional Gain (dBi)	PSD (dBm/MHz)	Limit (dBm/MHz)
0	QPSK	Low	3 600.00	16.92	13.00	29.92	37
		Middle	3 625.00	16.95	13.00	29.95	
		High	3 650.00	16.96	13.00	29.96	
	16QAM	Low	3 600.00	16.95	13.00	29.95	
		Middle	3 625.00	16.90	13.00	29.90	
		High	3 650.00	16.90	13.00	29.90	
	64QAM	Low	3 600.00	16.93	13.00	29.93	
		Middle	3 625.00	16.94	13.00	29.94	
		High	3 650.00	17.37	13.00	30.37	
	256QAM	Low	3 600.00	16.91	13.00	29.91	
		Middle	3 625.00	16.97	13.00	29.97	
		High	3 650.00	17.35	13.00	30.35	
1	QPSK	Low	3 600.00	16.96	13.00	29.96	
		Middle	3 625.00	16.97	13.00	29.97	
		High	3 650.00	16.92	13.00	29.92	
	16QAM	Low	3 600.00	16.99	13.00	29.99	
		Middle	3 625.00	16.92	13.00	29.92	
		High	3 650.00	16.95	13.00	29.95	
	64QAM	Low	3 600.00	16.96	13.00	29.96	
		Middle	3 625.00	16.94	13.00	29.94	
		High	3 650.00	17.48	13.00	30.48	
	256QAM	Low	3 600.00	16.92	13.00	29.92	
		Middle	3 625.00	16.95	13.00	29.95	
		High	3 650.00	17.44	13.00	30.44	

Ant.	Mod	Ch	Frequency (MHz)	Measured Value (dBm/MHz)	Directional Gain (dBi)	PSD (dBm/MHz)	Limit (dBm/MHz)
2	QPSK	Low	3 600.00	16.75	13.00	29.75	37
		Middle	3 625.00	16.92	13.00	29.92	
		High	3 650.00	16.90	13.00	29.90	
	16QAM	Low	3 600.00	16.95	13.00	29.95	
		Middle	3 625.00	16.99	13.00	29.99	
		High	3 650.00	16.97	13.00	29.97	
	64QAM	Low	3 600.00	16.94	13.00	29.94	
		Middle	3 625.00	16.98	13.00	29.98	
		High	3 650.00	17.38	13.00	30.38	
	256QAM	Low	3 600.00	16.97	13.00	29.97	
		Middle	3 625.00	16.92	13.00	29.92	
		High	3 650.00	17.32	13.00	30.32	
3	QPSK	Low	3 600.00	16.91	13.00	29.91	
		Middle	3 625.00	16.97	13.00	29.97	
		High	3 650.00	16.20	13.00	29.20	
	16QAM	Low	3 600.00	16.95	13.00	29.95	
		Middle	3 625.00	16.96	13.00	29.96	
		High	3 650.00	16.92	13.00	29.92	
	64QAM	Low	3 600.00	16.97	13.00	29.97	
		Middle	3 625.00	16.99	13.00	29.99	
		High	3 650.00	17.62	13.00	30.62	
	256QAM	Low	3 600.00	16.91	13.00	29.91	
		Middle	3 625.00	16.93	13.00	29.93	
		High	3 650.00	17.59	13.00	30.59	

Note: 1C: 1 Carrier, 5C: 5 Carrier

## Sum Data of Port 0, Port 1, Port 2 and Port 3

Frequency (MHz)	PSD				Limit
	QPSK	16QAM	64QAM	256QAM	
	(dBm/MHz)				
3 600.00	35.91	35.98	35.97	35.95	37
3 625.00	35.97	35.96	35.99	35.96	
3 650.00	35.78	35.96	36.48	36.45	

**CBRS NR 40 MHz 1C + NR 10 MHz 1C + LTE 20 MHz 1C + LTE 5 MHz 1C + LTE 5 MHz 1C[5C]**

Ant.	Mod	Ch	Frequency (MHz)	Measured Value (dBm/MHz)	Directional Gain (dBi)	PSD (dBm/MHz)	Limit (dBm/MHz)
0	QPSK	Low	3 590.00	17.13	13.00	30.13	37
		Middle	3 625.00	17.43	13.00	30.43	
		High	3 660.00	17.23	13.00	30.23	
	16QAM	Low	3 590.00	17.12	13.00	30.12	
		Middle	3 625.00	17.99	13.00	30.99	
		High	3 660.00	17.23	13.00	30.23	
	64QAM	Low	3 590.00	17.25	13.00	30.25	
		Middle	3 625.00	17.47	13.00	30.47	
		High	3 660.00	17.28	13.00	30.28	
	256QAM	Low	3 590.00	17.22	13.00	30.22	
		Middle	3 625.00	17.46	13.00	30.46	
		High	3 660.00	17.30	13.00	30.30	
1	QPSK	Low	3 590.00	17.10	13.00	30.10	
		Middle	3 625.00	17.14	13.00	30.14	
		High	3 660.00	17.23	13.00	30.23	
	16QAM	Low	3 590.00	17.35	13.00	30.35	
		Middle	3 625.00	17.22	13.00	30.22	
		High	3 660.00	17.31	13.00	30.31	
	64QAM	Low	3 590.00	17.26	13.00	30.26	
		Middle	3 625.00	17.28	13.00	30.28	
		High	3 660.00	17.36	13.00	30.36	
	256QAM	Low	3 590.00	17.26	13.00	30.26	
		Middle	3 625.00	17.29	13.00	30.29	
		High	3 660.00	17.35	13.00	30.35	



Ant.	Mod	Ch	Frequency (MHz)	Measured Value (dBm/MHz)	Directional Gain (dBi)	PSD (dBm/MHz)	Limit (dBm/MHz)
2	QPSK	Low	3 590.00	17.04	13.00	30.04	37
		Middle	3 625.00	17.96	13.00	30.96	
		High	3 660.00	17.15	13.00	30.15	
	16QAM	Low	3 590.00	17.09	13.00	30.09	
		Middle	3 625.00	17.06	13.00	30.06	
		High	3 660.00	17.17	13.00	30.17	
	64QAM	Low	3 590.00	17.19	13.00	30.19	
		Middle	3 625.00	17.12	13.00	30.12	
		High	3 660.00	17.17	13.00	30.17	
	256QAM	Low	3 590.00	17.13	13.00	30.13	
		Middle	3 625.00	17.06	13.00	30.06	
		High	3 660.00	17.13	13.00	30.13	
3	QPSK	Low	3 590.00	17.18	13.00	30.18	
		Middle	3 625.00	17.37	13.00	30.37	
		High	3 660.00	17.36	13.00	30.36	
	16QAM	Low	3 590.00	17.33	13.00	30.33	
		Middle	3 625.00	17.30	13.00	30.30	
		High	3 660.00	17.33	13.00	30.33	
	64QAM	Low	3 590.00	17.34	13.00	30.34	
		Middle	3 625.00	17.50	13.00	30.50	
		High	3 660.00	17.42	13.00	30.42	
	256QAM	Low	3 590.00	17.32	13.00	30.32	
		Middle	3 625.00	17.42	13.00	30.42	
		High	3 660.00	17.34	13.00	30.34	

Note: 1C: 1 Carrier, 5C: 5 Carrier

## Sum Data of Port 0, Port 1, Port 2 and Port 3

Frequency (MHz)	PSD				Limit
	QPSK	16QAM	64QAM	256QAM	
	(dBm/MHz)				
3 590.00	36.13	36.25	36.28	36.25	37
3 625.00	36.51	36.43	36.37	36.33	
3 660.00	36.26	36.28	36.33	36.30	

**Tabular Data of Non-Contiguous PSD**
**CBRS NR(60 MHz 1C + 30 MHz 1C)[2C]**

Ant.	Mod	Frequency (MHz)	Measured Value (dBm/MHz)	Directional Gain (dBi)	PSD (dBm/MHz)	Limit (dBm/MHz)
0	QPSK	3 580.00 + 3 685.00	17.18	13.00	28.18	37
	16QAM	3 580.00 + 3 685.00	17.31	13.00	28.31	
	64QAM	3 580.00 + 3 685.00	17.35	13.00	28.35	
	256QAM	3 580.00 + 3 685.00	17.41	13.00	28.41	
1	QPSK	3 580.00 + 3 685.00	17.36	13.00	28.36	
	16QAM	3 580.00 + 3 685.00	17.43	13.00	28.43	
	64QAM	3 580.00 + 3 685.00	17.45	13.00	28.45	
	256QAM	3 580.00 + 3 685.00	17.43	13.00	28.43	
2	QPSK	3 580.00 + 3 685.00	17.43	13.00	28.43	
	16QAM	3 580.00 + 3 685.00	17.27	13.00	28.27	
	64QAM	3 580.00 + 3 685.00	17.33	13.00	28.33	
	256QAM	3 580.00 + 3 685.00	17.37	13.00	28.37	
3	QPSK	3 580.00 + 3 685.00	17.43	13.00	28.43	
	16QAM	3 580.00 + 3 685.00	17.43	13.00	28.43	
	64QAM	3 580.00 + 3 685.00	17.43	13.00	28.43	
	256QAM	3 580.00 + 3 685.00	17.44	13.00	28.44	

Note: 1C: 1 Carrier, 2C: 2 Carrier

**Sum Data of Port 0, Port 1, Port 2 and Port 3**

Frequency (MHz)	PSD				Limit
	QPSK	16QAM	64QAM	256QAM	
	(dBm/MHz)				
3 580.00 + 3 685.00	36.37	36.38	36.41	36.43	37

**CBRS LTE(15 MHz 1C + 15 MHz 1C)[2C]**

Ant.	Mod	Frequency (MHz)	Measured Value (dBm/MHz)	Directional Gain (dBi)	PSD (dBm/MHz)	Limit (dBm/MHz)
0	QPSK	3 557.50 + 3 692.50	18.47	12.00	29.47	37
	16QAM	3 557.50 + 3 692.50	18.91	12.00	29.91	
	64QAM	3 557.50 + 3 692.50	18.41	12.00	29.41	
	256QAM	3 557.50 + 3 692.50	18.62	12.00	29.62	
1	QPSK	3 557.50 + 3 692.50	18.39	12.00	29.39	
	16QAM	3 557.50 + 3 692.50	18.84	12.00	29.84	
	64QAM	3 557.50 + 3 692.50	18.44	12.00	29.44	
	256QAM	3 557.50 + 3 692.50	18.63	12.00	29.63	
2	QPSK	3 557.50 + 3 692.50	18.91	12.00	29.91	
	16QAM	3 557.50 + 3 692.50	18.36	12.00	29.36	
	64QAM	3 557.50 + 3 692.50	18.77	12.00	29.77	
	256QAM	3 557.50 + 3 692.50	18.91	12.00	29.91	
3	QPSK	3 557.50 + 3 692.50	18.60	12.00	29.60	
	16QAM	3 557.50 + 3 692.50	18.50	12.00	29.50	
	64QAM	3 557.50 + 3 692.50	18.65	12.00	29.65	
	256QAM	3 557.50 + 3 692.50	18.55	12.00	29.55	

Note: 1C: 1 Carrier, 2C: 2 Carrier

**Sum Data of Port 0, Port 1, Port 2 and Port 3**

Frequency (MHz)	PSD				Limit
	QPSK	16QAM	64QAM	256QAM	
	(dBm/MHz)				
3 557.50 + 3 692.50	36.62	36.68	36.59	36.70	37

**CBRS LTE 5 MHz 1C + NR 10 MHz 1C[2C]**

Ant.	Mod	Frequency (MHz)	Measured Value (dBm/MHz)	Directional Gain (dBi)	PSD (dBm/MHz)	Limit (dBm/MHz)
0	QPSK	3 552.50 + 3 695.00	18.31	11.00	29.31	37
	16QAM	3 552.50 + 3 695.00	18.77	11.00	29.77	
	64QAM	3 552.50 + 3 695.00	18.39	11.00	29.39	
	256QAM	3 552.50 + 3 695.00	18.37	11.00	29.37	
1	QPSK	3 552.50 + 3 695.00	18.48	11.00	29.48	
	16QAM	3 552.50 + 3 695.00	18.83	11.00	29.83	
	64QAM	3 552.50 + 3 695.00	18.74	11.00	29.74	
	256QAM	3 552.50 + 3 695.00	18.64	11.00	29.64	
2	QPSK	3 552.50 + 3 695.00	18.33	11.00	29.33	
	16QAM	3 552.50 + 3 695.00	18.62	11.00	29.62	
	64QAM	3 552.50 + 3 695.00	18.47	11.00	29.47	
	256QAM	3 552.50 + 3 695.00	18.47	11.00	29.47	
3	QPSK	3 552.50 + 3 695.00	18.61	11.00	29.61	
	16QAM	3 552.50 + 3 695.00	18.97	11.00	29.97	
	64QAM	3 552.50 + 3 695.00	18.83	11.00	29.83	
	256QAM	3 552.50 + 3 695.00	18.80	11.00	29.80	

Note: 1C: 1 Carrier, 2C: 2 Carrier

**Sum Data of Port 0, Port 1, Port 2 and Port 3**

Frequency (MHz)	PSD				Limit
	QPSK	16QAM	64QAM	256QAM	
	(dBm/MHz)				
3 552.50 + 3 695.00	35.45	35.82	35.63	35.59	37

**CBRS NR[20 MHz 1C + (20 MHz 1C + 10 MHz 1C)][3C(1C+2C)]**

Ant.	Mod	Frequency (MHz)	Measured Value (dBm/MHz)	Directional Gain (dBi)	PSD (dBm/MHz)	Limit (dBm/MHz)
0	QPSK	3 560.00 + 3 685.00	18.34	12.00	29.34	37
	16QAM	3 560.00 + 3 685.00	18.40	12.00	29.40	
	64QAM	3 560.00 + 3 685.00	18.42	12.00	29.42	
	256QAM	3 560.00 + 3 685.00	18.37	12.00	29.37	
1	QPSK	3 560.00 + 3 685.00	18.52	12.00	29.52	
	16QAM	3 560.00 + 3 685.00	18.60	12.00	29.60	
	64QAM	3 560.00 + 3 685.00	18.53	12.00	29.53	
	256QAM	3 560.00 + 3 685.00	18.54	12.00	29.54	
2	QPSK	3 560.00 + 3 685.00	18.45	12.00	29.45	
	16QAM	3 560.00 + 3 685.00	18.50	12.00	29.50	
	64QAM	3 560.00 + 3 685.00	18.50	12.00	29.50	
	256QAM	3 560.00 + 3 685.00	18.40	12.00	29.40	
3	QPSK	3 560.00 + 3 685.00	18.72	12.00	29.72	
	16QAM	3 560.00 + 3 685.00	18.63	12.00	29.63	
	64QAM	3 560.00 + 3 685.00	18.71	12.00	29.71	
	256QAM	3 560.00 + 3 685.00	18.73	12.00	29.73	

Note: 1C: 1 Carrier, 2C: 2 Carrier, 3C: 3 Carrier

**Sum Data of Port 0, Port 1, Port 2 and Port 3**

Frequency (MHz)	PSD				Limit
	QPSK	16QAM	64QAM	256QAM	
	(dBm/MHz)				
3 560.00 + 3 685.00	36.53	36.56	36.56	36.53	37

**CBRS NR[(20 MHz 1C + 20 MHz 1C) + 10 MHz 1C][3C(2C+1C)]**

Ant.	Mod	Frequency (MHz)	Measured Value (dBm/MHz)	Directional Gain (dBi)	PSD (dBm/MHz)	Limit (dBm/MHz)
0	QPSK	3 570.00 + 3 695.00	18.95	12.00	29.95	37
	16QAM	3 570.00 + 3 695.00	18.99	12.00	29.99	
	64QAM	3 570.00 + 3 695.00	18.41	12.00	29.41	
	256QAM	3 570.00 + 3 695.00	18.30	12.00	29.30	
1	QPSK	3 570.00 + 3 695.00	18.36	12.00	29.36	
	16QAM	3 570.00 + 3 695.00	18.44	12.00	29.44	
	64QAM	3 570.00 + 3 695.00	18.58	12.00	29.58	
	256QAM	3 570.00 + 3 695.00	18.26	12.00	29.26	
2	QPSK	3 570.00 + 3 695.00	18.36	12.00	29.36	
	16QAM	3 570.00 + 3 695.00	18.46	12.00	29.46	
	64QAM	3 570.00 + 3 695.00	18.43	12.00	29.43	
	256QAM	3 570.00 + 3 695.00	18.59	12.00	29.59	
3	QPSK	3 570.00 + 3 695.00	18.66	12.00	29.66	
	16QAM	3 570.00 + 3 695.00	18.60	12.00	29.60	
	64QAM	3 570.00 + 3 695.00	18.73	12.00	29.73	
	256QAM	3 570.00 + 3 695.00	18.72	12.00	29.72	

Note: 1C: 1 Carrier, 2C: 2 Carrier, 3C: 3 Carrier

**Sum Data of Port 0, Port 1, Port 2 and Port 3**

Frequency (MHz)	PSD				Limit
	QPSK	16QAM	64QAM	256QAM	
	(dBm/MHz)				
3 570.00 + 3 695.00	36.61	36.65	36.56	36.49	37

**CBRS NR[30 MHz 1C + (30 MHz 1C + 10 MHz 1C)][3C(1C+2C)]**

Ant.	Mod	Frequency (MHz)	Measured Value (dBm/MHz)	Directional Gain (dBi)	PSD (dBm/MHz)	Limit (dBm/MHz)
0	QPSK	3 565.00 + 3 680.00	17.73	13.00	28.73	37
	16QAM	3 565.00 + 3 680.00	17.98	13.00	28.98	
	64QAM	3 565.00 + 3 680.00	17.93	13.00	28.93	
	256QAM	3 565.00 + 3 680.00	17.99	13.00	28.99	
1	QPSK	3 565.00 + 3 680.00	17.75	13.00	28.75	
	16QAM	3 565.00 + 3 680.00	17.98	13.00	28.98	
	64QAM	3 565.00 + 3 680.00	17.99	13.00	28.99	
	256QAM	3 565.00 + 3 680.00	17.75	13.00	28.75	
2	QPSK	3 565.00 + 3 680.00	17.76	13.00	28.76	
	16QAM	3 565.00 + 3 680.00	17.99	13.00	28.99	
	64QAM	3 565.00 + 3 680.00	17.98	13.00	28.98	
	256QAM	3 565.00 + 3 680.00	17.91	13.00	28.91	
3	QPSK	3 565.00 + 3 680.00	17.94	13.00	28.94	
	16QAM	3 565.00 + 3 680.00	17.98	13.00	28.98	
	64QAM	3 565.00 + 3 680.00	17.92	13.00	28.92	
	256QAM	3 565.00 + 3 680.00	17.97	13.00	28.97	

Note: 1C: 1 Carrier, 2C: 2 Carrier, 3C: 3 Carrier

**Sum Data of Port 0, Port 1, Port 2 and Port 3**

Frequency (MHz)	PSD				Limit
	QPSK	16QAM	64QAM	256QAM	
	(dBm/MHz)				
3 565.00 + 3 680.00	36.82	36.99	36.98	36.92	37



**CBRS NR[(30 MHz 1C + 30 MHz 1C) + 10 MHz 1C][3C(2C+1C)]**

Ant.	Mod	Frequency (MHz)	Measured Value (dBm/MHz)	Directional Gain (dBi)	PSD (dBm/MHz)	Limit (dBm/MHz)
0	QPSK	3 580.00 + 3 695.00	18.00	13.00	29.00	37
	16QAM	3 580.00 + 3 695.00	17.95	13.00	28.95	
	64QAM	3 580.00 + 3 695.00	17.90	13.00	28.90	
	256QAM	3 580.00 + 3 695.00	17.95	13.00	28.95	
1	QPSK	3 580.00 + 3 695.00	17.99	13.00	28.99	
	16QAM	3 580.00 + 3 695.00	17.99	13.00	28.99	
	64QAM	3 580.00 + 3 695.00	17.93	13.00	28.93	
	256QAM	3 580.00 + 3 695.00	17.97	13.00	28.97	
2	QPSK	3 580.00 + 3 695.00	17.97	13.00	28.97	
	16QAM	3 580.00 + 3 695.00	17.93	13.00	28.93	
	64QAM	3 580.00 + 3 695.00	17.98	13.00	28.98	
	256QAM	3 580.00 + 3 695.00	18.00	13.00	29.00	
3	QPSK	3 580.00 + 3 695.00	17.99	13.00	28.99	
	16QAM	3 580.00 + 3 695.00	17.93	13.00	28.93	
	64QAM	3 580.00 + 3 695.00	17.99	13.00	28.99	
	256QAM	3 580.00 + 3 695.00	17.91	13.00	28.91	

Note: 1C: 1 Carrier, 2C: 2 Carrier, 3C: 3 Carrier

**Sum Data of Port 0, Port 1, Port 2 and Port 3**

Frequency (MHz)	PSD				Limit
	QPSK	16QAM	64QAM	256QAM	
	(dBm/MHz)				
3 580.00 + 3 695.00	35.01	34.97	34.97	34.98	37

**CBRS LTE[15 MHz 1C + (15 MHz 1C + 10 MHz 1C)][3C(1C+2C)]**

Ant.	Mod	Frequency (MHz)	Measured Value (dBm/MHz)	Directional Gain (dBi)	PSD (dBm/MHz)	Limit (dBm/MHz)
0	QPSK	3 557.50 + 3 687.50	18.90	12.00	29.90	37
	16QAM	3 557.50 + 3 687.50	18.73	12.00	29.73	
	64QAM	3 557.50 + 3 687.50	18.48	12.00	29.48	
	256QAM	3 557.50 + 3 687.50	18.41	12.00	29.41	
1	QPSK	3 557.50 + 3 687.50	18.44	12.00	29.44	
	16QAM	3 557.50 + 3 687.50	18.91	12.00	29.91	
	64QAM	3 557.50 + 3 687.50	18.77	12.00	29.77	
	256QAM	3 557.50 + 3 687.50	18.69	12.00	29.69	
2	QPSK	3 557.50 + 3 687.50	18.43	12.00	29.43	
	16QAM	3 557.50 + 3 687.50	18.71	12.00	29.71	
	64QAM	3 557.50 + 3 687.50	18.60	12.00	29.60	
	256QAM	3 557.50 + 3 687.50	18.65	12.00	29.65	
3	QPSK	3 557.50 + 3 687.50	18.64	12.00	29.64	
	16QAM	3 557.50 + 3 687.50	18.99	12.00	29.99	
	64QAM	3 557.50 + 3 687.50	18.80	12.00	29.80	
	256QAM	3 557.50 + 3 687.50	18.83	12.00	29.83	

Note: 1C: 1 Carrier, 2C: 2 Carrier, 3C: 3 Carrier

**Sum Data of Port 0, Port 1, Port 2 and Port 3**

Frequency (MHz)	PSD				Limit
	QPSK	16QAM	64QAM	256QAM	
	(dBm/MHz)				
3 557.50 + 3 687.50	36.63	36.86	36.68	36.67	37

**CBRS LTE[(15 MHz 1C + 15 MHz 1C) + 10 MHz 1C][3C(2C+1C)]**

Ant.	Mod	Frequency (MHz)	Measured Value (dBm/MHz)	Directional Gain (dBi)	PSD (dBm/MHz)	Limit (dBm/MHz)
0	QPSK	3 565.00 + 3 695.00	18.31	12.00	29.31	37
	16QAM	3 565.00 + 3 695.00	18.78	12.00	29.78	
	64QAM	3 565.00 + 3 695.00	18.38	12.00	29.38	
	256QAM	3 565.00 + 3 695.00	18.40	12.00	29.40	
1	QPSK	3 565.00 + 3 695.00	18.47	12.00	29.47	
	16QAM	3 565.00 + 3 695.00	18.97	12.00	29.97	
	64QAM	3 565.00 + 3 695.00	18.55	12.00	29.55	
	256QAM	3 565.00 + 3 695.00	18.56	12.00	29.56	
2	QPSK	3 565.00 + 3 695.00	18.37	12.00	29.37	
	16QAM	3 565.00 + 3 695.00	18.71	12.00	29.71	
	64QAM	3 565.00 + 3 695.00	18.47	12.00	29.47	
	256QAM	3 565.00 + 3 695.00	18.49	12.00	29.49	
3	QPSK	3 565.00 + 3 695.00	18.61	12.00	29.61	
	16QAM	3 565.00 + 3 695.00	19.00	12.00	30.00	
	64QAM	3 565.00 + 3 695.00	18.69	12.00	29.69	
	256QAM	3 565.00 + 3 695.00	18.65	12.00	29.65	

Note: 1C: 1 Carrier, 2C: 2 Carrier, 3C: 3 Carrier

**Sum Data of Port 0, Port 1, Port 2 and Port 3**

Frequency (MHz)	PSD				Limit
	QPSK	16QAM	64QAM	256QAM	
	(dBm/MHz)				
3 565.00 + 3 695.00	36.46	36.89	36.55	36.55	37

**CBRS LTE[20 MHz 1C + (15 MHz 1C + 15 MHz 1C)][3C(1C+2C)]**

Ant.	Mod	Frequency (MHz)	Measured Value (dBm/MHz)	Directional Gain (dBi)	PSD (dBm/MHz)	Limit (dBm/MHz)
0	QPSK	3 560.00 + 3 685.00	18.94	12.00	29.94	37
	16QAM	3 560.00 + 3 685.00	18.49	12.00	29.49	
	64QAM	3 560.00 + 3 685.00	18.99	12.00	29.99	
	256QAM	3 560.00 + 3 685.00	18.21	12.00	29.21	
1	QPSK	3 560.00 + 3 685.00	18.44	12.00	29.44	
	16QAM	3 560.00 + 3 685.00	18.80	12.00	29.80	
	64QAM	3 560.00 + 3 685.00	18.44	12.00	29.44	
	256QAM	3 560.00 + 3 685.00	18.52	12.00	29.52	
2	QPSK	3 560.00 + 3 685.00	18.41	12.00	29.41	
	16QAM	3 560.00 + 3 685.00	18.65	12.00	29.65	
	64QAM	3 560.00 + 3 685.00	18.37	12.00	29.37	
	256QAM	3 560.00 + 3 685.00	18.37	12.00	29.37	
3	QPSK	3 560.00 + 3 685.00	18.54	12.00	29.54	
	16QAM	3 560.00 + 3 685.00	18.78	12.00	29.78	
	64QAM	3 560.00 + 3 685.00	18.58	12.00	29.58	
	256QAM	3 560.00 + 3 685.00	18.64	12.00	29.64	

Note: 1C: 1 Carrier, 2C: 2 Carrier, 3C: 3 Carrier

**Sum Data of Port 0, Port 1, Port 2 and Port 3**

Frequency (MHz)	PSD				Limit
	QPSK	16QAM	64QAM	256QAM	
	(dBm/MHz)				
3 560.00 + 3 685.00	36.61	36.70	36.62	36.46	37

**CBRS LTE[(20 MHz 1C + 15 MHz 1C) + 15 MHz 1C][3C(2C+1C)]**

Ant.	Mod	Frequency (MHz)	Measured Value (dBm/MHz)	Directional Gain (dBi)	PSD (dBm/MHz)	Limit (dBm/MHz)
0	QPSK	3 567.50 + 3 692.50	18.82	12.00	29.82	37
	16QAM	3 567.50 + 3 692.50	18.42	12.00	29.42	
	64QAM	3 567.50 + 3 692.50	18.07	12.00	29.07	
	256QAM	3 567.50 + 3 692.50	18.99	12.00	29.99	
1	QPSK	3 567.50 + 3 692.50	18.18	12.00	29.18	
	16QAM	3 567.50 + 3 692.50	18.84	12.00	29.84	
	64QAM	3 567.50 + 3 692.50	18.26	12.00	29.26	
	256QAM	3 567.50 + 3 692.50	18.36	12.00	29.36	
2	QPSK	3 567.50 + 3 692.50	18.31	12.00	29.31	
	16QAM	3 567.50 + 3 692.50	18.59	12.00	29.59	
	64QAM	3 567.50 + 3 692.50	18.23	12.00	29.23	
	256QAM	3 567.50 + 3 692.50	18.38	12.00	29.38	
3	QPSK	3 567.50 + 3 692.50	18.43	12.00	29.43	
	16QAM	3 567.50 + 3 692.50	18.82	12.00	29.82	
	64QAM	3 567.50 + 3 692.50	18.44	12.00	29.44	
	256QAM	3 567.50 + 3 692.50	18.55	12.00	29.55	

Note: 1C: 1 Carrier, 2C: 2 Carrier, 3C: 3 Carrier

**Sum Data of Port 0, Port 1, Port 2 and Port 3**

Frequency (MHz)	PSD				Limit
	QPSK	16QAM	64QAM	256QAM	
	(dBm/MHz)				
3 567.50 + 3 692.50	36.46	36.69	36.27	36.60	37

**CBRS LTE[20 MHz 1C + (20 MHz 1C + 20 MHz 1C)][3C(1C+2C)]**

Ant.	Mod	Frequency (MHz)	Measured Value (dBm/MHz)	Directional Gain (dBi)	PSD (dBm/MHz)	Limit (dBm/MHz)
0	QPSK	3 560.00 + 3 680.00	18.88	12.00	29.88	37
	16QAM	3 560.00 + 3 680.00	18.59	12.00	29.59	
	64QAM	3 560.00 + 3 680.00	18.34	12.00	29.34	
	256QAM	3 560.00 + 3 680.00	18.85	12.00	29.85	
1	QPSK	3 560.00 + 3 680.00	18.49	12.00	29.49	
	16QAM	3 560.00 + 3 680.00	18.94	12.00	29.94	
	64QAM	3 560.00 + 3 680.00	18.59	12.00	29.59	
	256QAM	3 560.00 + 3 680.00	18.50	12.00	29.50	
2	QPSK	3 560.00 + 3 680.00	18.44	12.00	29.44	
	16QAM	3 560.00 + 3 680.00	18.67	12.00	29.67	
	64QAM	3 560.00 + 3 680.00	18.55	12.00	29.55	
	256QAM	3 560.00 + 3 680.00	18.52	12.00	29.52	
3	QPSK	3 560.00 + 3 680.00	18.68	12.00	29.68	
	16QAM	3 560.00 + 3 680.00	18.90	12.00	29.90	
	64QAM	3 560.00 + 3 680.00	18.64	12.00	29.64	
	256QAM	3 560.00 + 3 680.00	18.79	12.00	29.79	

Note: 1C: 1 Carrier, 2C: 2 Carrier, 3C: 3 Carrier

**Sum Data of Port 0, Port 1, Port 2 and Port 3**

Frequency (MHz)	PSD				Limit
	QPSK	16QAM	64QAM	256QAM	
	(dBm/MHz)				
3 560.00 + 3 680.00	36.65	36.80	36.55	36.69	37

**CBRS LTE[(20 MHz 1C + 20 MHz 1C) + 20 MHz 1C][3C(2C+1C)]**

Ant.	Mod	Frequency (MHz)	Measured Value (dBm/MHz)	Directional Gain (dBi)	PSD (dBm/MHz)	Limit (dBm/MHz)
0	QPSK	3 570.00 + 3 690.00	18.65	12.00	29.65	37
	16QAM	3 570.00 + 3 690.00	18.52	12.00	29.52	
	64QAM	3 570.00 + 3 690.00	18.92	12.00	29.92	
	256QAM	3 570.00 + 3 690.00	18.80	12.00	29.80	
1	QPSK	3 570.00 + 3 690.00	18.25	12.00	29.25	
	16QAM	3 570.00 + 3 690.00	18.52	12.00	29.52	
	64QAM	3 570.00 + 3 690.00	18.17	12.00	29.17	
	256QAM	3 570.00 + 3 690.00	18.34	12.00	29.34	
2	QPSK	3 570.00 + 3 690.00	18.28	12.00	29.28	
	16QAM	3 570.00 + 3 690.00	18.17	12.00	29.17	
	64QAM	3 570.00 + 3 690.00	18.25	12.00	29.25	
	256QAM	3 570.00 + 3 690.00	18.32	12.00	29.32	
3	QPSK	3 570.00 + 3 690.00	18.48	12.00	29.48	
	16QAM	3 570.00 + 3 690.00	18.69	12.00	29.69	
	64QAM	3 570.00 + 3 690.00	18.43	12.00	29.43	
	256QAM	3 570.00 + 3 690.00	18.47	12.00	29.47	

Note: 1C: 1 Carrier, 2C: 2 Carrier, 3C: 3 Carrier

**Sum Data of Port 0, Port 1, Port 2 and Port 3**

Frequency (MHz)	PSD				Limit
	QPSK	16QAM	64QAM	256QAM	
	(dBm/MHz)				
3 570.00 + 3 690.00	36.44	36.50	36.47	36.51	37

**CBRS LTE[20 MHz 1C + (20 MHz 1C + 20 MHz 1C + 20 MHz 1C)][4C(1C+3C)]**

Ant.	Mod	Frequency (MHz)	Measured Value (dBm/MHz)	Directional Gain (dBi)	PSD (dBm/MHz)	Limit (dBm/MHz)
0	QPSK	3 560.00 + 3 670.00	17.72	13.00	28.72	37
	16QAM	3 560.00 + 3 670.00	17.83	13.00	28.83	
	64QAM	3 560.00 + 3 670.00	17.41	13.00	28.41	
	256QAM	3 560.00 + 3 670.00	17.51	13.00	28.51	
1	QPSK	3 560.00 + 3 670.00	17.92	13.00	28.92	
	16QAM	3 560.00 + 3 670.00	17.93	13.00	28.93	
	64QAM	3 560.00 + 3 670.00	17.64	13.00	28.64	
	256QAM	3 560.00 + 3 670.00	17.63	13.00	28.63	
2	QPSK	3 560.00 + 3 670.00	17.74	13.00	28.74	
	16QAM	3 560.00 + 3 670.00	17.78	13.00	28.78	
	64QAM	3 560.00 + 3 670.00	17.49	13.00	28.49	
	256QAM	3 560.00 + 3 670.00	17.56	13.00	28.56	
3	QPSK	3 560.00 + 3 670.00	17.99	13.00	28.99	
	16QAM	3 560.00 + 3 670.00	17.96	13.00	28.96	
	64QAM	3 560.00 + 3 670.00	17.75	13.00	28.75	
	256QAM	3 560.00 + 3 670.00	17.78	13.00	28.78	

Note: 1C: 1 Carrier, 3C: 3 Carrier, 4C: 4 Carrier

**Sum Data of Port 0, Port 1, Port 2 and Port 3**

Frequency (MHz)	PSD				Limit
	QPSK	16QAM	64QAM	256QAM	
	(dBm/MHz)				
3 560.00 + 3 670.00	36.86	36.89	36.59	36.64	37



**CBRS LTE[(20 MHz 1C + 20 MHz 1C + 20 MHz 1C) + 20 MHz 1C][4C(3C+1C)]**

Ant.	Mod	Frequency (MHz)	Measured Value (dBm/MHz)	Directional Gain (dBi)	PSD (dBm/MHz)	Limit (dBm/MHz)
0	QPSK	3 580.00 + 3 690.00	17.10	13.00	28.10	37
	16QAM	3 580.00 + 3 690.00	17.47	13.00	28.47	
	64QAM	3 580.00 + 3 690.00	17.07	13.00	28.07	
	256QAM	3 580.00 + 3 690.00	17.18	13.00	28.18	
1	QPSK	3 580.00 + 3 690.00	17.26	13.00	28.26	
	16QAM	3 580.00 + 3 690.00	17.69	13.00	28.69	
	64QAM	3 580.00 + 3 690.00	17.29	13.00	28.29	
	256QAM	3 580.00 + 3 690.00	17.27	13.00	28.27	
2	QPSK	3 580.00 + 3 690.00	17.06	13.00	28.06	
	16QAM	3 580.00 + 3 690.00	17.34	13.00	28.34	
	64QAM	3 580.00 + 3 690.00	17.30	13.00	28.30	
	256QAM	3 580.00 + 3 690.00	17.19	13.00	28.19	
3	QPSK	3 580.00 + 3 690.00	17.32	13.00	28.32	
	16QAM	3 580.00 + 3 690.00	17.73	13.00	28.73	
	64QAM	3 580.00 + 3 690.00	17.48	13.00	28.48	
	256QAM	3 580.00 + 3 690.00	17.38	13.00	28.38	

Note: 1C: 1 Carrier, 3C: 3 Carrier, 4C: 4 Carrier

**Sum Data of Port 0, Port 1, Port 2 and Port 3**

Frequency (MHz)	PSD				Limit
	QPSK	16QAM	64QAM	256QAM	
	(dBm/MHz)				
3 580.00 + 3 690.00	36.21	36.58	36.31	36.28	37

**CBRS LTE[15 MHz 1C + (15 MHz 1C + 15 MHz 1C + 15 MHz 1C + 10 MHz 1C)][5C(1C+4C)]**

Ant.	Mod	Frequency (MHz)	Measured Value (dBm/MHz)	Directional Gain (dBi)	PSD (dBm/MHz)	Limit (dBm/MHz)
0	QPSK	3 575.00 + 3 672.50	17.37	13.00	28.37	37
	16QAM	3 575.00 + 3 672.50	17.75	13.00	28.75	
	64QAM	3 575.00 + 3 672.50	17.53	13.00	28.53	
	256QAM	3 575.00 + 3 672.50	17.56	13.00	28.56	
1	QPSK	3 575.00 + 3 672.50	17.59	13.00	28.59	
	16QAM	3 575.00 + 3 672.50	17.96	13.00	28.96	
	64QAM	3 575.00 + 3 672.50	17.72	13.00	28.72	
	256QAM	3 575.00 + 3 672.50	17.80	13.00	28.80	
2	QPSK	3 575.00 + 3 672.50	17.44	13.00	28.44	
	16QAM	3 575.00 + 3 672.50	17.59	13.00	28.59	
	64QAM	3 575.00 + 3 672.50	17.52	13.00	28.52	
	256QAM	3 575.00 + 3 672.50	17.69	13.00	28.69	
3	QPSK	3 575.00 + 3 672.50	17.65	13.00	28.65	
	16QAM	3 575.00 + 3 672.50	17.33	13.00	28.33	
	64QAM	3 575.00 + 3 672.50	17.76	13.00	28.76	
	256QAM	3 575.00 + 3 672.50	17.83	13.00	28.83	

Note: 1C: 1 Carrier, 4C: 4 Carrier, 5C: 5 Carrier

**Sum Data of Port 0, Port 1, Port 2 and Port 3**

Frequency (MHz)	PSD				Limit
	QPSK	16QAM	64QAM	256QAM	
	(dBm/MHz)				
3 575.00 + 3 672.50	36.54	36.69	36.65	36.74	37

**CBRS LTE[(15 MHz 1C + 15 MHz 1C + 15 MHz 1C + 15 MHz 1C) + 10 MHz 1C][5C(4C+1C)]**

Ant.	Mod	Frequency (MHz)	Measured Value (dBm/MHz)	Directional Gain (dBi)	PSD (dBm/MHz)	Limit (dBm/MHz)
0	QPSK	3 580.00 + 3 695.00	17.12	13.00	28.12	37
	16QAM	3 580.00 + 3 695.00	17.44	13.00	28.44	
	64QAM	3 580.00 + 3 695.00	17.11	13.00	28.11	
	256QAM	3 580.00 + 3 695.00	17.18	13.00	28.18	
1	QPSK	3 580.00 + 3 695.00	17.38	13.00	28.38	
	16QAM	3 580.00 + 3 695.00	17.69	13.00	28.69	
	64QAM	3 580.00 + 3 695.00	17.30	13.00	28.30	
	256QAM	3 580.00 + 3 695.00	17.40	13.00	28.40	
2	QPSK	3 580.00 + 3 695.00	17.15	13.00	28.15	
	16QAM	3 580.00 + 3 695.00	17.47	13.00	28.47	
	64QAM	3 580.00 + 3 695.00	17.20	13.00	28.20	
	256QAM	3 580.00 + 3 695.00	17.28	13.00	28.28	
3	QPSK	3 580.00 + 3 695.00	17.37	13.00	28.37	
	16QAM	3 580.00 + 3 695.00	17.67	13.00	28.67	
	64QAM	3 580.00 + 3 695.00	17.54	13.00	28.54	
	256QAM	3 580.00 + 3 695.00	17.46	13.00	28.46	

Note: 1C: 1 Carrier, 4C: 4 Carrier, 5C: 5 Carrier

**Sum Data of Port 0, Port 1, Port 2 and Port 3**

Frequency (MHz)	PSD				Limit
	QPSK	16QAM	64QAM	256QAM	
	(dBm/MHz)				
3 580.00 + 3 695.00	36.28	36.59	36.31	36.35	37

**CBRS LTE[20 MHz 1C + (20 MHz 1C + 20 MHz 1C + 20 MHz 1C + 10 MHz 1C)][5C(1C+4C)]**

Ant.	Mod	Frequency (MHz)	Measured Value (dBm/MHz)	Directional Gain (dBi)	PSD (dBm/MHz)	Limit (dBm/MHz)
0	QPSK	3 560.00 + 3 665.00	17.40	13.00	28.40	37
	16QAM	3 560.00 + 3 665.00	17.34	13.00	28.34	
	64QAM	3 560.00 + 3 665.00	17.30	13.00	28.30	
	256QAM	3 560.00 + 3 665.00	17.36	13.00	28.36	
1	QPSK	3 560.00 + 3 665.00	17.39	13.00	28.39	
	16QAM	3 560.00 + 3 665.00	17.31	13.00	28.31	
	64QAM	3 560.00 + 3 665.00	17.34	13.00	28.34	
	256QAM	3 560.00 + 3 665.00	17.34	13.00	28.34	
2	QPSK	3 560.00 + 3 665.00	17.37	13.00	28.37	
	16QAM	3 560.00 + 3 665.00	17.34	13.00	28.34	
	64QAM	3 560.00 + 3 665.00	17.38	13.00	28.38	
	256QAM	3 560.00 + 3 665.00	17.39	13.00	28.39	
3	QPSK	3 560.00 + 3 665.00	17.40	13.00	28.40	
	16QAM	3 560.00 + 3 665.00	17.36	13.00	28.36	
	64QAM	3 560.00 + 3 665.00	17.37	13.00	28.37	
	256QAM	3 560.00 + 3 665.00	17.36	13.00	28.36	

Note: 1C: 1 Carrier, 4C: 4 Carrier, 5C: 5 Carrier

**Sum Data of Port 0, Port 1, Port 2 and Port 3**

Frequency (MHz)	PSD				Limit
	QPSK	16QAM	64QAM	256QAM	
	(dBm/MHz)				
3 560.00 + 3 665.00	36.41	36.36	36.37	36.38	37

**CBRS LTE[(20 MHz 1C + 20 MHz 1C + 20 MHz 1C + 20 MHz 1C) + 10 MHz 1C][5C(4C+1C)]**

Ant.	Mod	Frequency (MHz)	Measured Value (dBm/MHz)	Directional Gain (dBi)	PSD (dBm/MHz)	Limit (dBm/MHz)
0	QPSK	3 590.00 + 3 695.00	17.37	13.00	28.37	37
	16QAM	3 590.00 + 3 695.00	17.35	13.00	28.35	
	64QAM	3 590.00 + 3 695.00	17.39	13.00	28.39	
	256QAM	3 590.00 + 3 695.00	17.36	13.00	28.36	
1	QPSK	3 590.00 + 3 695.00	17.38	13.00	28.38	
	16QAM	3 590.00 + 3 695.00	17.32	13.00	28.32	
	64QAM	3 590.00 + 3 695.00	17.36	13.00	28.36	
	256QAM	3 590.00 + 3 695.00	17.36	13.00	28.36	
2	QPSK	3 590.00 + 3 695.00	17.36	13.00	28.36	
	16QAM	3 590.00 + 3 695.00	17.34	13.00	28.34	
	64QAM	3 590.00 + 3 695.00	17.39	13.00	28.39	
	256QAM	3 590.00 + 3 695.00	17.38	13.00	28.38	
3	QPSK	3 590.00 + 3 695.00	17.40	13.00	28.40	
	16QAM	3 590.00 + 3 695.00	17.38	13.00	28.38	
	64QAM	3 590.00 + 3 695.00	17.39	13.00	28.39	
	256QAM	3 590.00 + 3 695.00	17.37	13.00	28.37	

Note: 1C: 1 Carrier, 4C: 4 Carrier, 5C: 5 Carrier

**Sum Data of Port 0, Port 1, Port 2 and Port 3**

Frequency (MHz)	PSD				Limit
	QPSK	16QAM	64QAM	256QAM	
	(dBm/MHz)				
3 590.00 + 3 695.00	36.40	36.37	36.40	36.39	37

**CBRS LTE[20 MHz 1C + (20 MHz 1C + 20 MHz 1C + 20 MHz 1C + 20 MHz 1C)][5C(1C+4C)]**

Ant.	Mod	Frequency (MHz)	Measured Value (dBm/MHz)	Ant. Gain (dBi)	PSD (dBm/MHz)	Limit (dBm/MHz)
0	QPSK	3 560.00 + 3 660.00	16.32	13.00	27.32	37
	16QAM	3 560.00 + 3 660.00	16.97	13.00	27.97	
	64QAM	3 560.00 + 3 660.00	16.92	13.00	27.92	
	256QAM	3 560.00 + 3 660.00	16.84	13.00	27.84	
1	QPSK	3 560.00 + 3 660.00	16.96	13.00	27.96	
	16QAM	3 560.00 + 3 660.00	16.53	13.00	27.53	
	64QAM	3 560.00 + 3 660.00	16.74	13.00	27.74	
	256QAM	3 560.00 + 3 660.00	16.83	13.00	27.83	
2	QPSK	3 560.00 + 3 660.00	16.76	13.00	27.76	
	16QAM	3 560.00 + 3 660.00	16.81	13.00	27.81	
	64QAM	3 560.00 + 3 660.00	16.63	13.00	27.63	
	256QAM	3 560.00 + 3 660.00	16.75	13.00	27.75	
3	QPSK	3 560.00 + 3 660.00	16.87	13.00	27.87	
	16QAM	3 560.00 + 3 660.00	16.85	13.00	27.85	
	64QAM	3 560.00 + 3 660.00	16.86	13.00	27.86	
	256QAM	3 560.00 + 3 660.00	16.96	13.00	27.96	

Note: 1C: 1 Carrier, 4C: 4 Carrier, 5C: 5 Carrier

**Sum Data of Port 0, Port 1, Port 2 and Port 3**

Frequency (MHz)	PSD				Limit
	QPSK	16QAM	64QAM	256QAM	
	(dBm/MHz)				
3 560.00 + 3 660.00	35.75	35.81	35.81	35.87	37

**CBRS LTE[(20 MHz 1C + 20 MHz 1C + 20 MHz 1C + 20 MHz 1C) + 20 MHz 1C][5C(4C+1C)]**

Ant.	Mod	Frequency (MHz)	Measured Value (dBm/MHz)	Ant. Gain (dBi)	PSD (dBm/MHz)	Limit (dBm/MHz)
0	QPSK	3 590.00 + 3 690.00	16.29	13.00	27.29	37
	16QAM	3 590.00 + 3 690.00	16.41	13.00	27.41	
	64QAM	3 590.00 + 3 690.00	17.00	13.00	28.00	
	256QAM	3 590.00 + 3 690.00	16.95	13.00	27.95	
1	QPSK	3 590.00 + 3 690.00	16.30	13.00	27.30	
	16QAM	3 590.00 + 3 690.00	16.57	13.00	27.57	
	64QAM	3 590.00 + 3 690.00	16.17	13.00	27.17	
	256QAM	3 590.00 + 3 690.00	16.19	13.00	27.19	
2	QPSK	3 590.00 + 3 690.00	16.16	13.00	27.16	
	16QAM	3 590.00 + 3 690.00	16.41	13.00	27.41	
	64QAM	3 590.00 + 3 690.00	16.97	13.00	27.97	
	256QAM	3 590.00 + 3 690.00	16.97	13.00	27.97	
3	QPSK	3 590.00 + 3 690.00	16.23	13.00	27.23	
	16QAM	3 590.00 + 3 690.00	16.52	13.00	27.52	
	64QAM	3 590.00 + 3 690.00	16.23	13.00	27.23	
	256QAM	3 590.00 + 3 690.00	16.28	13.00	27.28	

Note: 1C: 1 Carrier, 4C: 4 Carrier, 5C: 5 Carrier

**Sum Data of Port 0, Port 1, Port 2 and Port 3**

Frequency (MHz)	PSD				Limit
	QPSK	16QAM	64QAM	256QAM	
	(dBm/MHz)				
3 590.00 + 3 690.00	35.26	35.50	35.63	35.64	37

**CBRS NR 40 MHz 1C + (NR 20 MHz 1C + NR 20 MHz 1C + LTE 10 MHz 1C + LTE 10 MHz 1C)[5C(1C+4C)]**

Ant.	Mod	Frequency (MHz)	Measured Value (dBm/MHz)	Ant. Gain (dBi)	PSD (dBm/MHz)	Limit (dBm/MHz)
0	QPSK	3 570.00 + 3 670.00	16.97	13.00	29.97	37
	16QAM	3 570.00 + 3 670.00	16.95	13.00	29.95	
	64QAM	3 570.00 + 3 670.00	17.16	13.00	30.16	
	256QAM	3 570.00 + 3 670.00	17.26	13.00	30.26	
1	QPSK	3 570.00 + 3 670.00	16.97	13.00	29.97	
	16QAM	3 570.00 + 3 670.00	16.99	13.00	29.99	
	64QAM	3 570.00 + 3 670.00	17.29	13.00	30.29	
	256QAM	3 570.00 + 3 670.00	17.23	13.00	30.23	
2	QPSK	3 570.00 + 3 670.00	16.97	13.00	29.97	
	16QAM	3 570.00 + 3 670.00	16.95	13.00	29.95	
	64QAM	3 570.00 + 3 670.00	17.15	13.00	30.15	
	256QAM	3 570.00 + 3 670.00	17.16	13.00	30.16	
3	QPSK	3 570.00 + 3 670.00	16.98	13.00	29.98	
	16QAM	3 570.00 + 3 670.00	16.98	13.00	29.98	
	64QAM	3 570.00 + 3 670.00	17.43	13.00	30.43	
	256QAM	3 570.00 + 3 670.00	17.42	13.00	30.42	

Note: 1C: 1 Carrier, 4C: 4 Carrier, 5C: 5 Carrier

**Sum Data of Port 0, Port 1, Port 2 and Port 3**

Frequency (MHz)	PSD				Limit
	QPSK	16QAM	64QAM	256QAM	
	(dBm/MHz)				
3 570.00 + 3 670.00	35.99	35.99	36.28	36.29	37



**CBRS (NR 40 MHz 1C + NR 20 MHz 1C + NR 20 MHz 1C + LTE 10 MHz 1C) + LTE 10 MHz 1C[5C(4C+1C)]**

Ant.	Mod	Frequency (MHz)	Measured Value (dBm/MHz)	Ant. Gain (dBi)	PSD (dBm/MHz)	Limit (dBm/MHz)
0	QPSK	3 595.00 + 3 695.00	17.26	13.00	30.26	37
	16QAM	3 595.00 + 3 695.00	16.98	13.00	29.98	
	64QAM	3 595.00 + 3 695.00	16.91	13.00	29.91	
	256QAM	3 595.00 + 3 695.00	17.00	13.00	30.00	
1	QPSK	3 595.00 + 3 695.00	17.28	13.00	30.28	
	16QAM	3 595.00 + 3 695.00	16.92	13.00	29.92	
	64QAM	3 595.00 + 3 695.00	16.97	13.00	29.97	
	256QAM	3 595.00 + 3 695.00	16.99	13.00	29.99	
2	QPSK	3 595.00 + 3 695.00	17.13	13.00	30.13	
	16QAM	3 595.00 + 3 695.00	16.98	13.00	29.98	
	64QAM	3 595.00 + 3 695.00	16.99	13.00	29.99	
	256QAM	3 595.00 + 3 695.00	16.91	13.00	29.91	
3	QPSK	3 595.00 + 3 695.00	17.36	13.00	30.36	
	16QAM	3 595.00 + 3 695.00	16.96	13.00	29.96	
	64QAM	3 595.00 + 3 695.00	16.99	13.00	29.99	
	256QAM	3 595.00 + 3 695.00	16.98	13.00	29.98	

Note: 1C: 1 Carrier, 4C: 4 Carrier, 5C: 5 Carrier

**Sum Data of Port 0, Port 1, Port 2 and Port 3**

Frequency (MHz)	PSD				Limit
	QPSK	16QAM	64QAM	256QAM	
	(dBm/MHz)				
3 595.00 + 3 695.00	36.28	35.98	35.99	35.99	37

**CBRS NR 40 MHz 1C + (NR 10 MHz 1C + LTE 20 MHz 1C + LTE 5 MHz 1C + LTE 5 MHz 1C)5C(1C+4C)]**

Ant.	Mod	Frequency (MHz)	Measured Value (dBm/MHz)	Ant. Gain (dBi)	PSD (dBm/MHz)	Limit (dBm/MHz)
0	QPSK	3 570.00 + 3 680.00	17.88	13.00	30.88	37
	16QAM	3 570.00 + 3 680.00	17.82	13.00	30.82	
	64QAM	3 570.00 + 3 680.00	17.42	13.00	30.42	
	256QAM	3 570.00 + 3 680.00	17.34	13.00	30.34	
1	QPSK	3 570.00 + 3 680.00	17.86	13.00	30.86	
	16QAM	3 570.00 + 3 680.00	17.35	13.00	30.35	
	64QAM	3 570.00 + 3 680.00	17.50	13.00	30.50	
	256QAM	3 570.00 + 3 680.00	17.38	13.00	30.38	
2	QPSK	3 570.00 + 3 680.00	17.87	13.00	30.87	
	16QAM	3 570.00 + 3 680.00	17.93	13.00	30.93	
	64QAM	3 570.00 + 3 680.00	17.93	13.00	30.93	
	256QAM	3 570.00 + 3 680.00	17.86	13.00	30.86	
3	QPSK	3 570.00 + 3 680.00	17.53	13.00	30.53	
	16QAM	3 570.00 + 3 680.00	17.46	13.00	30.46	
	64QAM	3 570.00 + 3 680.00	17.44	13.00	30.44	
	256QAM	3 570.00 + 3 680.00	17.43	13.00	30.43	

Note: 1C: 1 Carrier, 4C: 4 Carrier, 5C: 5 Carrier

**Sum Data of Port 0, Port 1, Port 2 and Port 3**

Frequency (MHz)	PSD				Limit
	QPSK	16QAM	64QAM	256QAM	
	(dBm/MHz)				
3 570.00 + 3 680.00	36.81	36.67	36.60	36.53	37

**CBRS (NR 40 MHz 1C + NR 10 MHz 1C + LTE 20 MHz 1C + LTE 5 MHz 1C) + LTE 5 MHz 1C[5C(4C+1C)]**

Ant.	Mod	Frequency (MHz)	Measured Value (dBm/MHz)	Ant. Gain (dBi)	PSD (dBm/MHz)	Limit (dBm/MHz)
0	QPSK	3 587.50 + 3 697.50	17.13	13.00	30.13	37
	16QAM	3 587.50 + 3 697.50	17.24	13.00	30.24	
	64QAM	3 587.50 + 3 697.50	17.37	13.00	30.37	
	256QAM	3 587.50 + 3 697.50	17.38	13.00	30.38	
1	QPSK	3 587.50 + 3 697.50	17.17	13.00	30.17	
	16QAM	3 587.50 + 3 697.50	17.44	13.00	30.44	
	64QAM	3 587.50 + 3 697.50	17.37	13.00	30.37	
	256QAM	3 587.50 + 3 697.50	17.39	13.00	30.39	
2	QPSK	3 587.50 + 3 697.50	17.18	13.00	30.18	
	16QAM	3 587.50 + 3 697.50	17.26	13.00	30.26	
	64QAM	3 587.50 + 3 697.50	17.29	13.00	30.29	
	256QAM	3 587.50 + 3 697.50	17.26	13.00	30.26	
3	QPSK	3 587.50 + 3 697.50	17.46	13.00	30.46	
	16QAM	3 587.50 + 3 697.50	17.52	13.00	30.52	
	64QAM	3 587.50 + 3 697.50	17.62	13.00	30.62	
	256QAM	3 587.50 + 3 697.50	17.51	13.00	30.51	

Note: 1C: 1 Carrier, 4C: 4 Carrier, 5C: 5 Carrier

**Sum Data of Port 0, Port 1, Port 2 and Port 3**

Frequency (MHz)	PSD				Limit
	QPSK	16QAM	64QAM	256QAM	
	(dBm/MHz)				
3 587.50 + 3 697.50	36.26	36.39	36.43	36.40	37

## Plot Data of PSD

## Antenna 0 / CBRS NR 10 MHz 1 Carrier / 64QAM / Middle

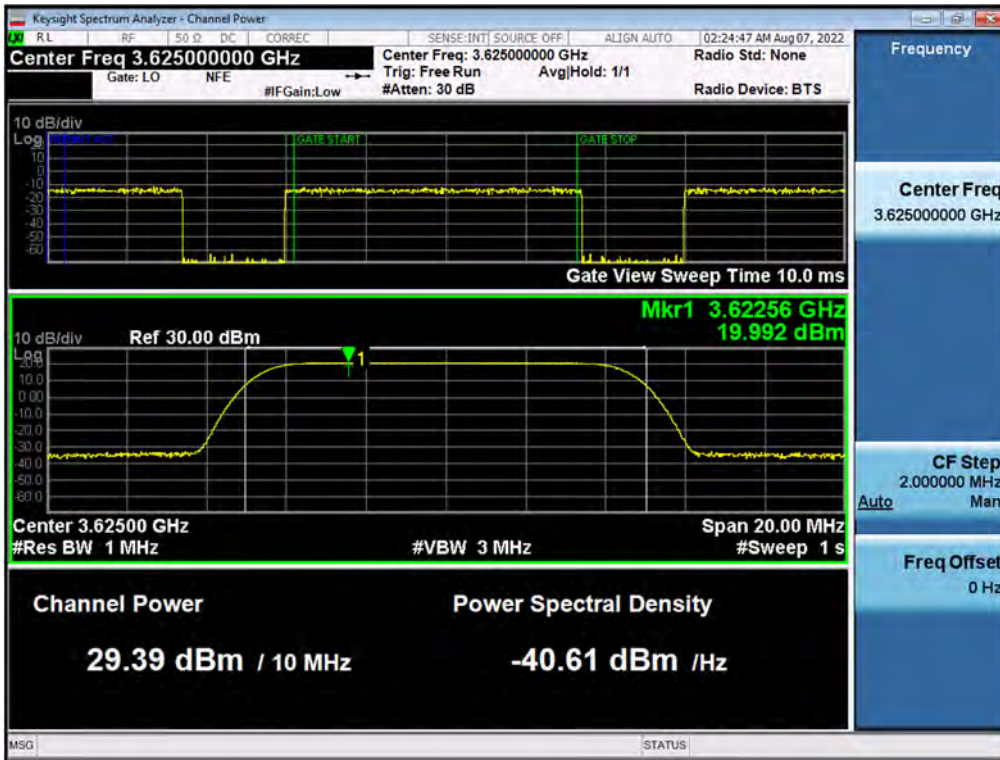

## Antenna 1 / CBRS NR 20 MHz 1 Carrier / 256QAM / High

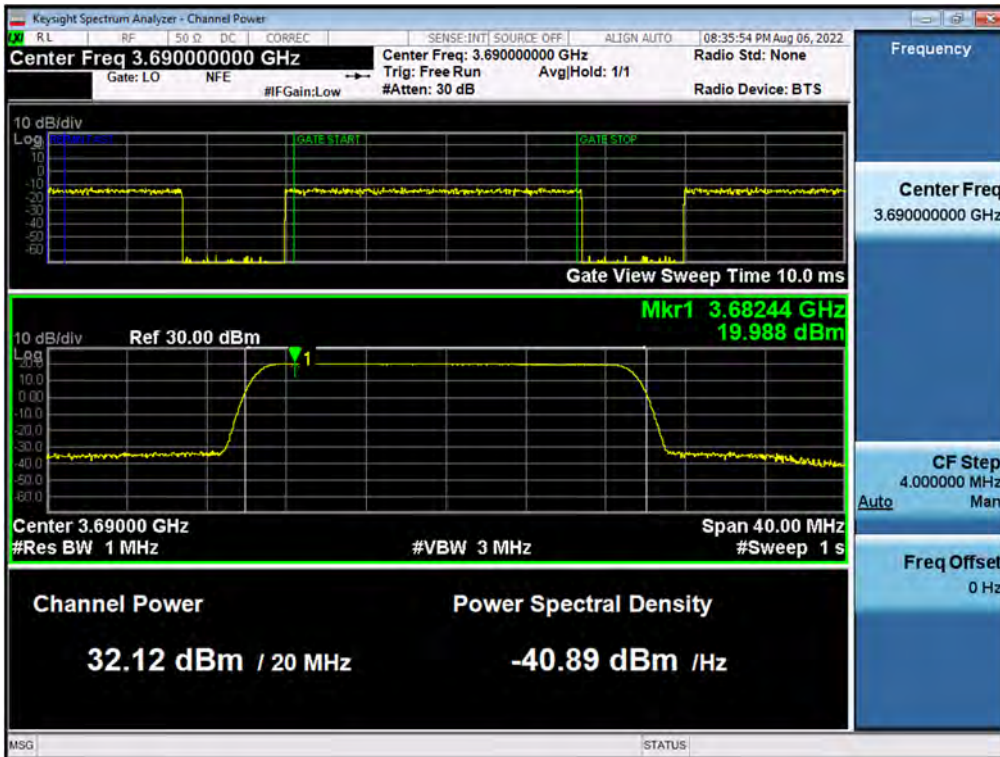

Antenna 0 / CBRS NR 30 MHz 1 Carrier / 64QAM / Middle

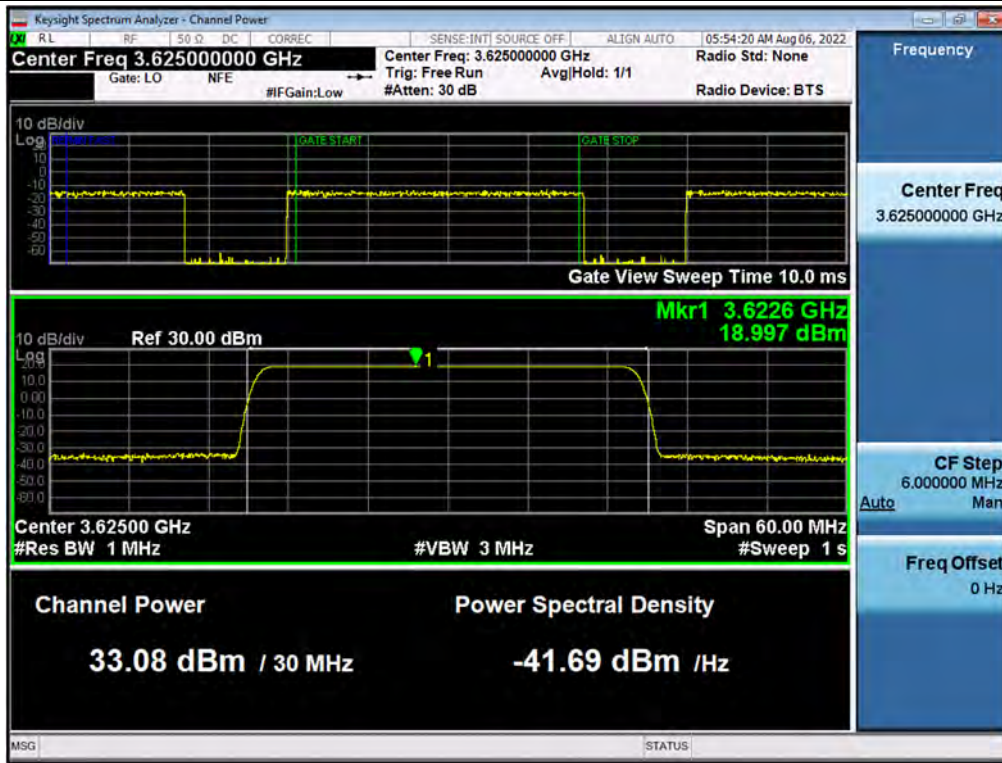

Antenna 0 / CBRS NR 40 MHz 1 Carrier / 64QAM / Low

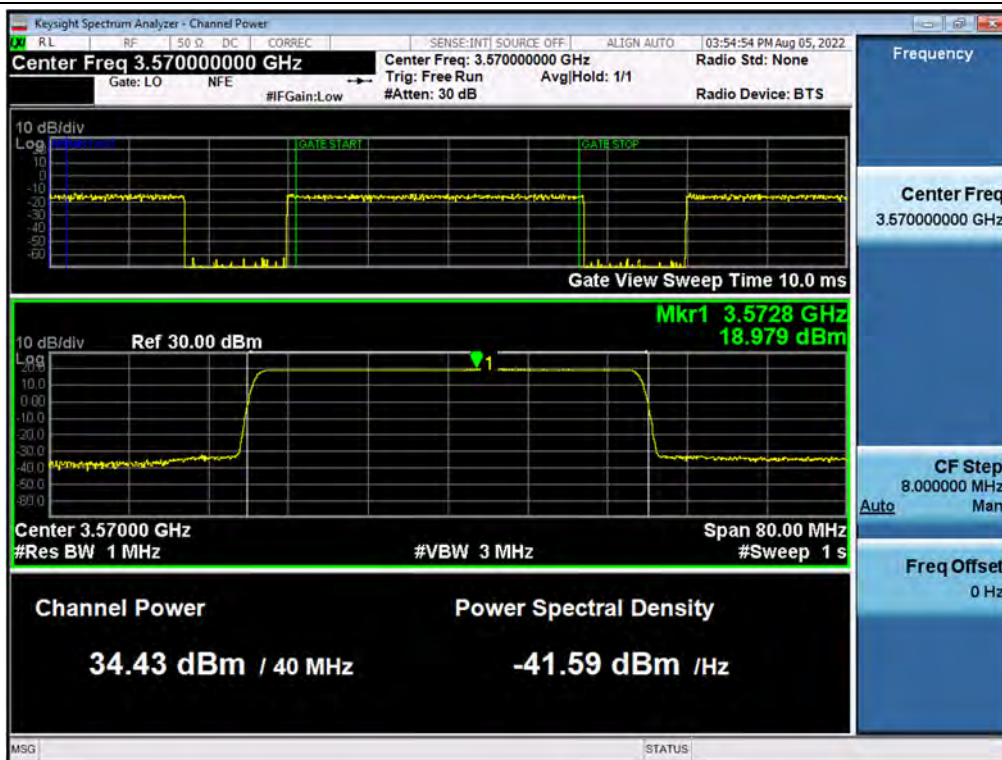

## Antenna 3 / CBRS NR 60 MHz 1 Carrier / 16QAM / High

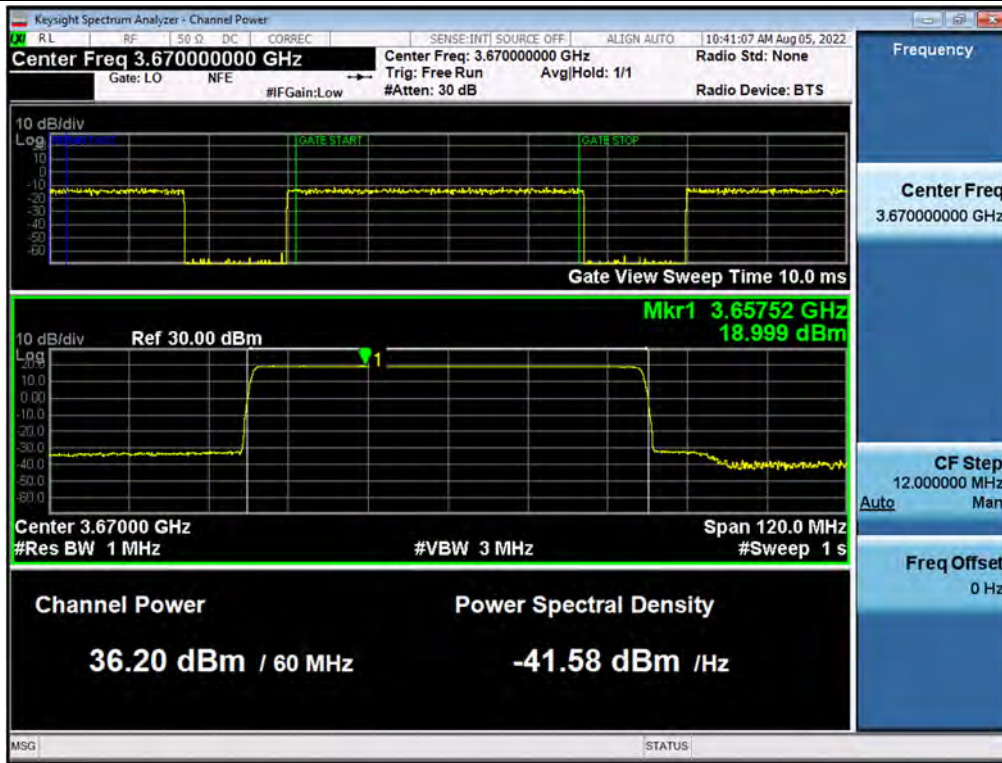

## Antenna 1 / CBRS NR 80 MHz 1 Carrier / QPSK / Middle

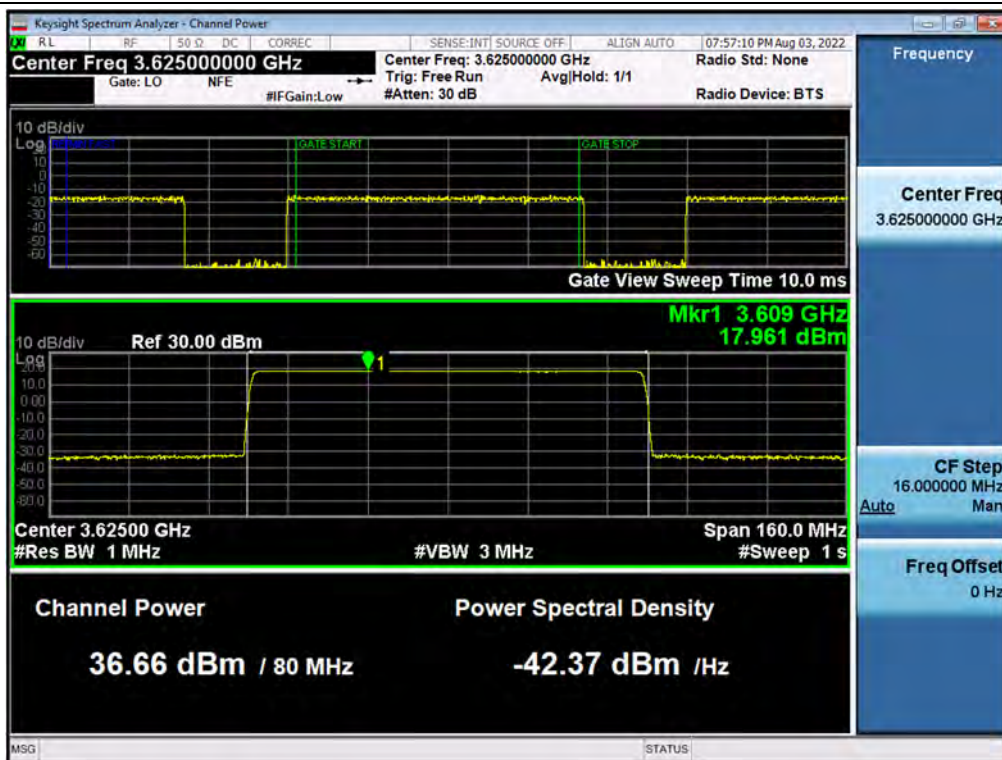

Antenna 2 / CBRS NR 100 MHz 1 Carrier / 64QAM / Low

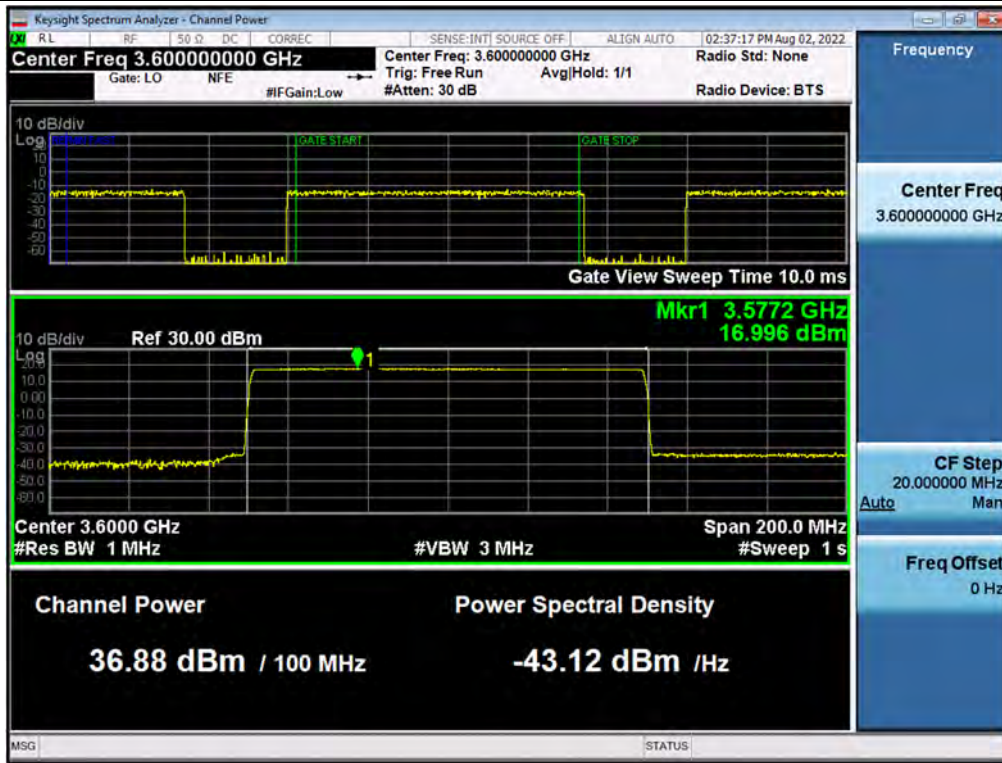

Antenna 2 / CBRS LTE 5 MHz 1 Carrier / 256QAM / Middle

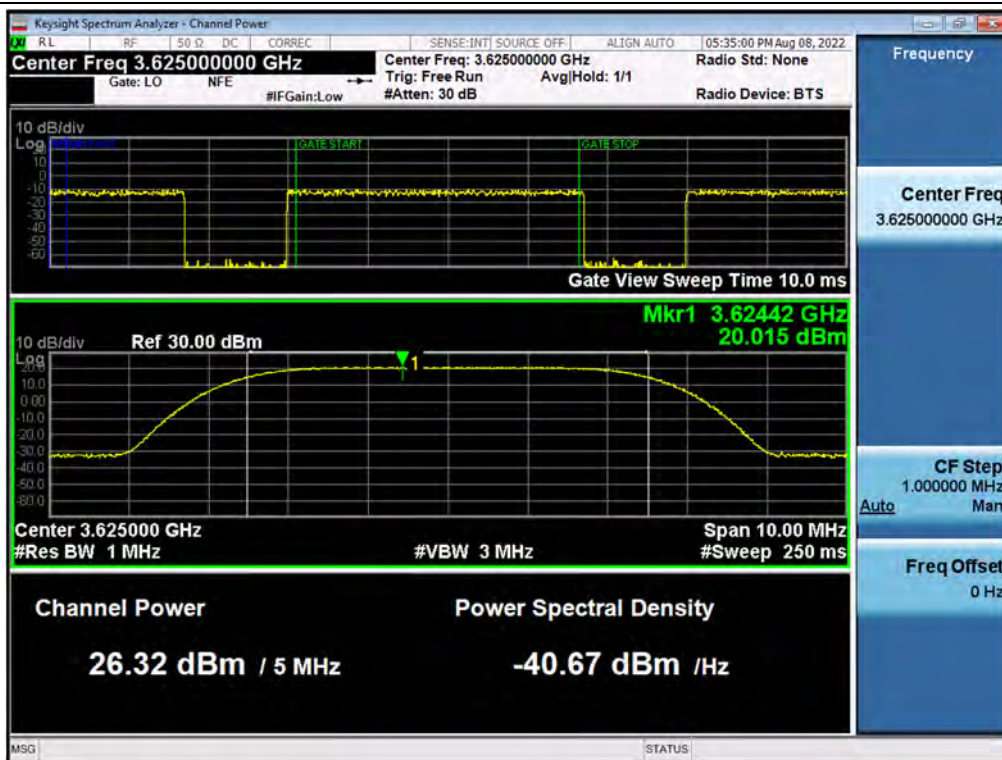

## Antenna 0 / CBRS LTE 10 MHz 1 Carrier / QPSK / Middle

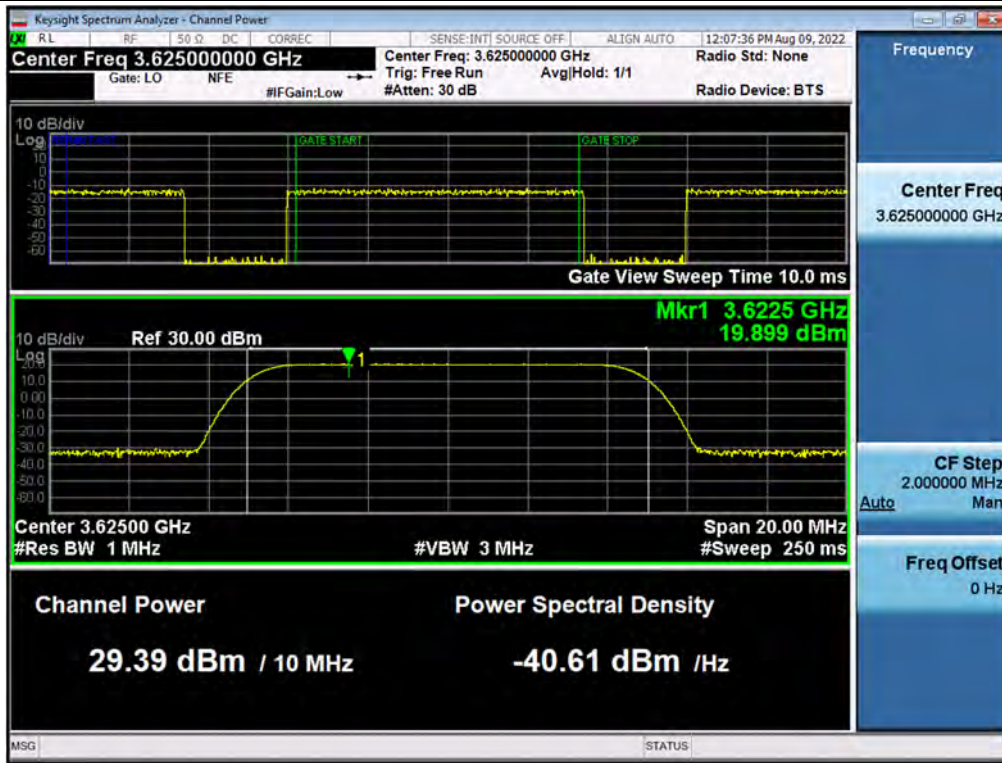

## Antenna 1 / CBRS LTE 15 MHz 1 Carrier / 16QAM / High

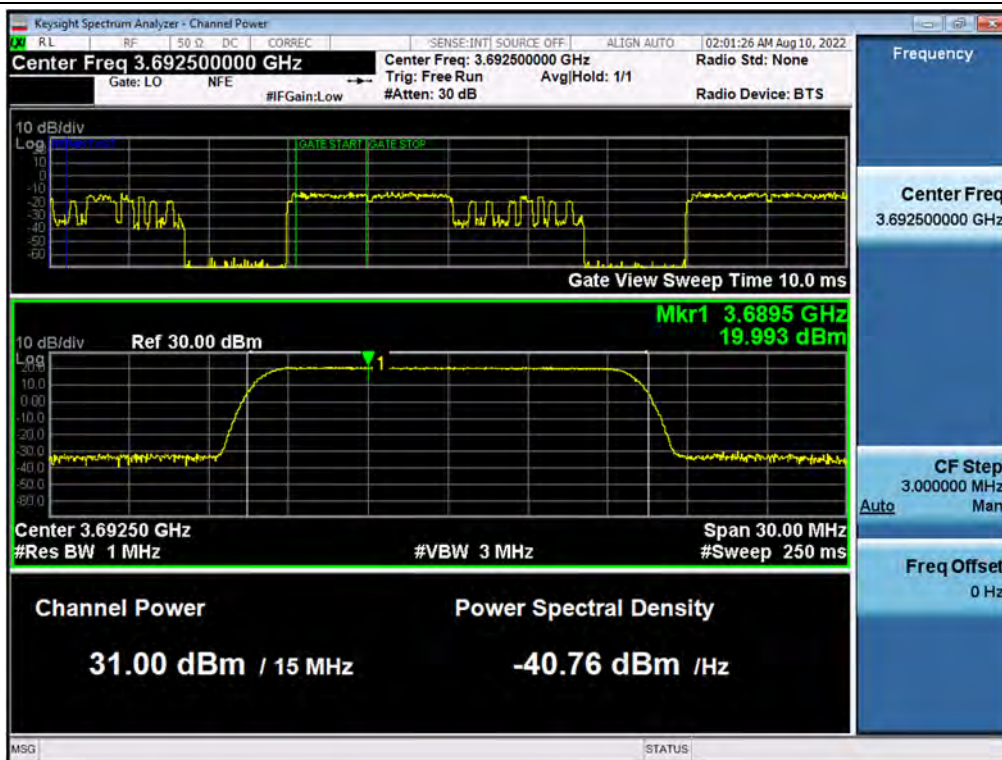



## Antenna 2 / CBRS LTE 20 MHz 1 Carrier / 16QAM / Low

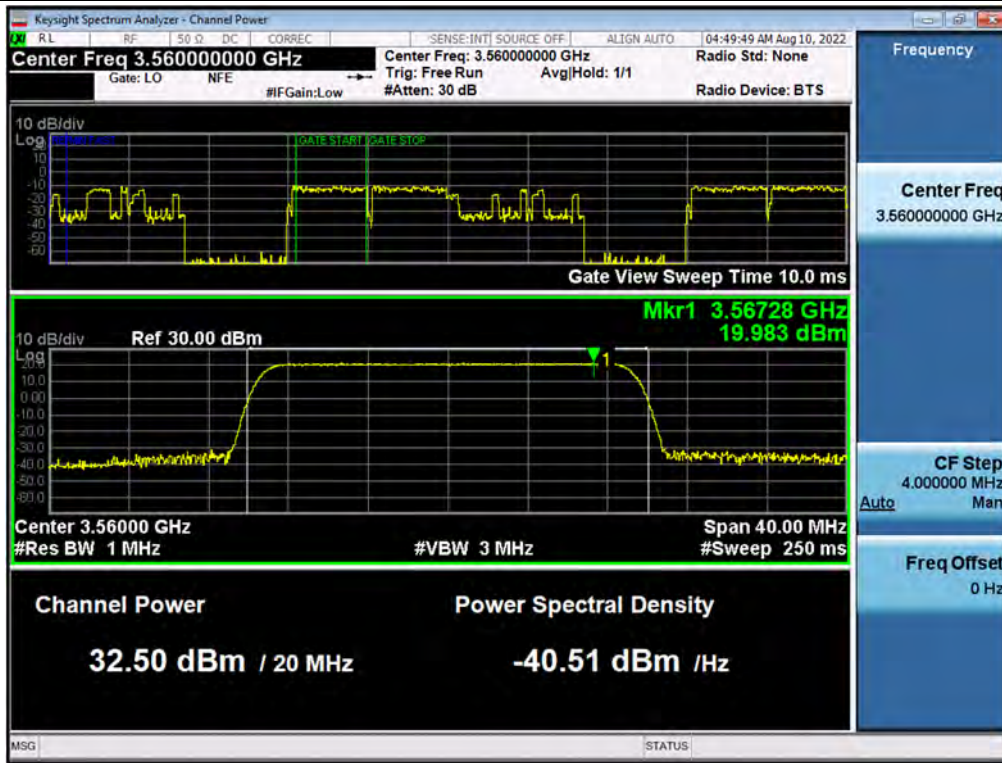

Antenna 0 / CBRS NR(60 MHz 1C + 30 MHz 1C)[2C] / Contiguous / 16QAM / Middle

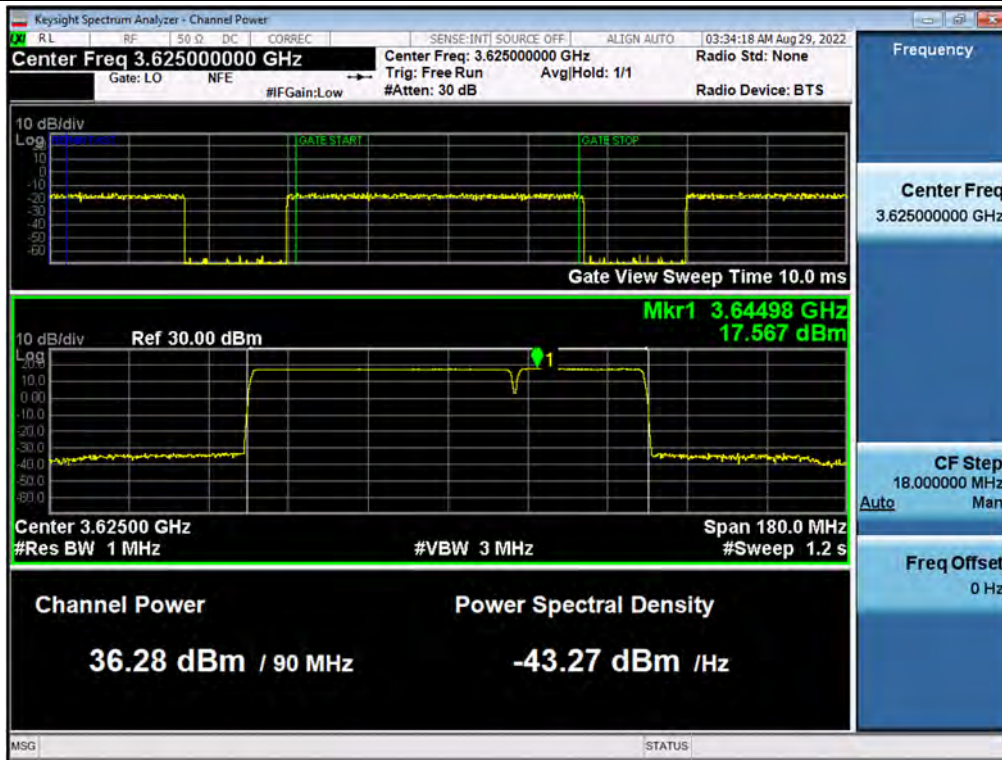

Antenna 2 / CBRS LTE(15 MHz 1C + 15 MHz 1C)[2C] / Contiguous / 64QAM / High

