



SAR EVALUATION REPORT

Test Report No.	OT-18D-RWD-038	
AGR.No.	A18DA-305	
Applicant	Samsung Electronics Co Ltd 19 Chapin Rd., Building D, Pine Brook, New Jersey, 07058, United States	
Model Name	RMCRMR1BP1	
DUT Type	SMART CONTROL	
Application Type	Certification	
FCC ID	A3LRMCRMR1BP1	
Date of Report	Dec 27, 2018	
Date of Test	Dec 20, 2018	
Test Laboratory	ONETECH 43-14, Jinsaegol-gil, Chowol-eup, Gwangju-si, Gyeonggi-do, 12735, Korea	
Procedures	KDB 447498, KDB 865664 IEEE 1528-2013 ANSI/IEEE C95.1, C95.3 FCC CFR §2.1093 RSS-102 Issue 5	
Max SAR(10g)	0.167 W/kg	
Test Opinion	Satisfied to FCC requirements	
Report Author	Jungwook Kim  _____	Dec 27, 2018
Test Engineer	Junghun Park  _____	Dec 27, 2018

This report details the results of the testing carried out on one sample, the results contained in this test report do not relate to other samples of the same product. The manufacturer should ensure that all products in series production are in conformity with the product sample detailed in this report.

This report may only be reproduced and distribute in full. If the product in this report is used in any configuration other than that detailed in the report, the manufacturer must ensure the new system complies with all relevant standards. Any mention of ONETECH Corp. or testing done by ONETECH Corp. In connection with distribution or use of the product described in this report must be approved by ONETECH Corp. in writing.

TABLE OF CONTENTS

1. INFORMATION	3
2. INTRODUCTION	4
3. SAR MEASUREMENT SETUP	5
4. MEASUREMENT UNCERTAINTY	9
5. ANSI/IEEE C95.1-2005 RF EXPOSURE LIMIT	11
6. SYSTEM AND LIQUID VERIFICATION	12
7. SAR MEASUREMENT PROCEDURES	16
8. TEST EQUIPMENT LIST	18
9. RF CONDUCTED POWER	19
10. SAR TEST RESULTS	20
ANNEX A. SYSTEM VERIFICATION PLOTS	22
ANNEX B. SAR TEST PLOTS	23
ANNEX C. PHOTOGRAPHS	25
ANNEX D. ANTENNA INFORMATION	26
ANNEX E. PROBE AND DIPOLE CALIBRATION CERTIFICATES	27

1. INFORMATION

1.1 DUT INFORMATION

DUT Description	SMART CONTROL
Model Name	RMCRMR1BP1
Serial Number	Identical Prototype
Mode of Operation	Bluetooth LE, Zigbee
TX Frequency Range	Bluetooth LE : 2 402 MHz ~ 2 480 MHz Zigbee : 2 405 MHz ~ 2 475 MHz
Maximum Average Conducted Power	Bluetooth LE : 8.02 dBm (Max. Allowed target power : 8 ± 1 dBm)
Summary of peak SAR	0.167 W/kg
Body Worn Accessory	N/A
Antenna Type & Gain	Antenna Type : Chip Antenna 2 400 MHz ~ 2 500 MHz : 0.97 dBi
Antenna Operation	1 Antenna Transmit
Battery	DC 3.0 V

1.2 SAR SUMMARY

Mode	Position	Freq. (MHz)	CH	Type	Distance (mm)	Maximum SAR (W/kg)
Bluetooth LE	Front	2 402	0	Limb	0	0.167
Zigbee	Front	2 440	18	Limb	0	0.141

2. INTRODUCTION

The FCC and Industry Canada have adopted the guidelines for evaluating the environmental effects of radio frequency (RF) radiation in ET Docket 93-62 on Aug. 6, 1996 and Health Canada Safety Code 6 to protect the public and workers from the potential hazards of RF emissions due to FCC-regulated portable devices.

The safety limits used for the environmental evaluation measurements are based on the criteria published by the American National Standards Institute (ANSI) for localized specific absorption rate (SAR) in IEEE/ANSI C95.1-1992 Standard for Safety Levels with Respect to Human Exposure to Radio Frequency Electromagnetic Fields, 3 kHz to 300 GHz and Health Canada RF Exposure Guidelines Safety Code 6. The measurement procedure described in IEEE/ANSI C95.3-2002 Recommended Practice for the Measurement of Potentially Hazardous Electromagnetic Fields - RF and Microwave is used for guidance in measuring the Specific Absorption Rate (SAR) due to the RF radiation exposure from the Equipment Under Test (EUT). These criteria for SAR evaluation are similar to those recommended by the International Committee for Non-Ionizing Radiation Protection (ICNIRP) in Biological Effects and Exposure Criteria for Radiofrequency Electromagnetic Fields,” Report No. Vol 74. SAR is a measure of the rate of energy absorption due to exposure to an RF transmitting source. SAR values have been related to threshold levels for potential biological hazards.

2.1 SAR Definition

Specific Absorption Rate is defined as the time derivative (rate) of the incremental energy (dU) absorbed by (dissipated in) an incremental mass (dm) contained in a volume element (dV) of a given density (ρ).

$$SAR = \frac{d}{dt} \left(\frac{dW}{dm} \right) = \frac{d}{dt} \left(\frac{dW}{\rho dV} \right)$$

SAR is expressed in units of watts per kilogram (W/kg). SAR can be related to the electric field at a point by

$$SAR = \frac{\sigma |E|^2}{\rho}$$

where:

- σ = conductivity of the tissue (S/m)
- ρ = mass density of the tissue (kg/m³)
- E = rms electric field strength (V/m)

3. SAR MEASUREMENT SETUP

- A standard high precision 6-axis robot with controller, teach pendant and software. An arm extension for accommodating the data acquisition electronics (DAE).
- An isotropic Field probe optimized and calibrated for the targeted measurement.
- Data acquisition electronics (DAE) which performs the signal amplification, signal multiplexing,
- AD-conversion, offset measurements, mechanical surface detection, collision detection, etc. The unit is battery powered with standard or rechargeable batteries. The signal is optically transmitted to the EOC.
- The Electro-optical converter (EOC) performs the conversion from optical to electrical signals for the digital communication to the DAE. To use optical surface detection, a special version of the EOC is required. The EOC signal is transmitted to the measurement server.
- The function of the measurement server is to perform the time critical tasks such as signal filtering, control of the robot operation and fast movement interrupts.
- The Light Beam used is for probe alignment. This improves the (absolute) accuracy of the probe positioning.
- A computer running WinXP or Win7 and the DASY5 software.
- Remote control and teach pendant as well as additional circuitry for robot safety such as warning lamps, etc.
- The phantom, the device holder and other accessories according to the targeted measurement.

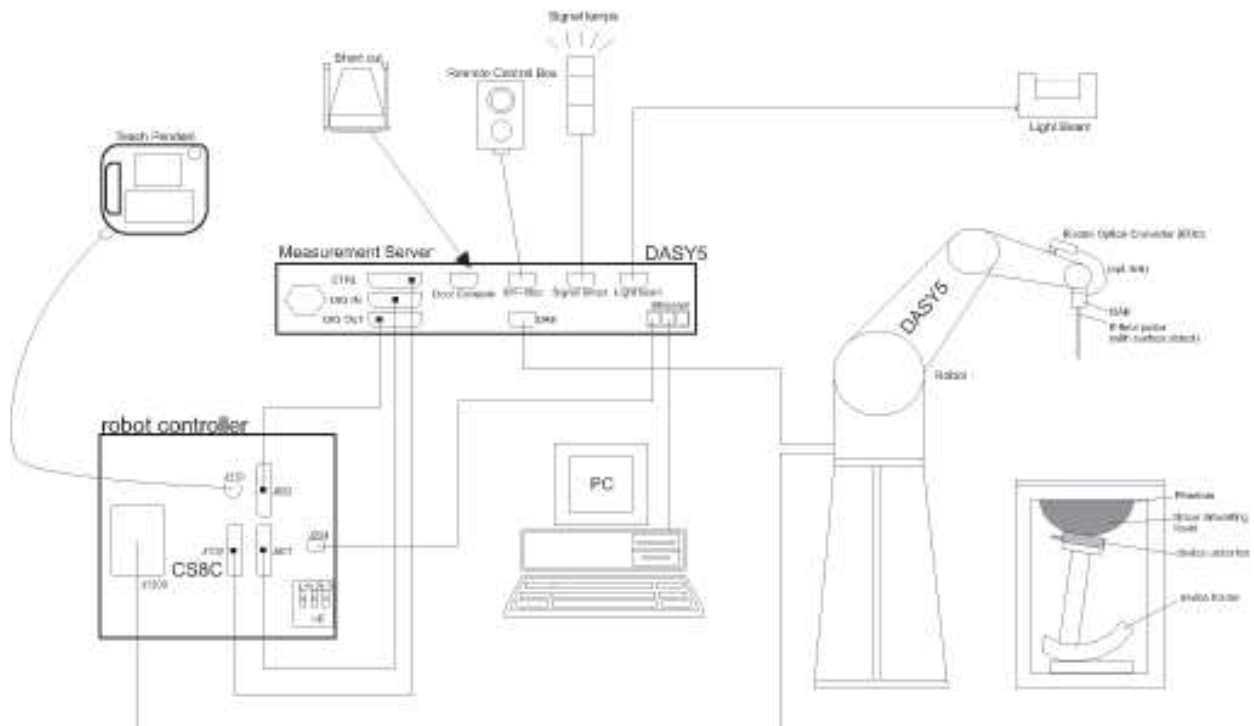

3.1 Dasy 5 system

DASY52 SAR	
	DASY52 SAR is a cost-effective package for demonstration of compliance of mobile phones with specific absorption rate (SAR) limits. The fastest and most accurate scanner on the market, it is fully compatible with all worldwide standards for transmitters operating at the ear or near the body (<200 mm from the skin).
Components (typical configuration)	<ul style="list-style-type: none"> 1 TX90XL Stäubli Robot and Controller CS8c incl. Cabinet 1 EOCx Electro Optical Converter (mounted on robot arm) 1 Robot Stand for TX90XL 1 Robot Arm Extension and Adaptors 1 Robot Remote Control 1 LB5 Light Beam Switch for Probe Tooling (incl. LB Adaptor) 1 Light Beam Mounting Plate 1 DASY5 Measurement Server 1 PC Intel Core 2 Dual / 3.16 GHz (or higher) incl. Color-Monitor 23" - 4 GB RAM, 220 GB HD (or larger) / Win7 1 SAM Twin Phantom V5.0 incl. Support DASY5 1 MD4HHTV5 Mounting Device for Hand-Held Transmitters 1 DAEx Data Acquisition Electronics 1 ES3DVx SAR Probe (incl. ConvF for HSL at 900 and 1750 MHz)

3.2 E-Field Probe (EX3DV4)

EX3DV4 Smallest Isotropic E-Field Probe for Dosimetric Measurements (Preliminary Specifications)	
	Symmetrical design with triangular core Built-in shielding against static charges PEEK enclosure material (resistant to organic solvents, e.g., DGBE)
Calibration	ISO/IEC 17025 calibration service available.
Frequency	10 MHz to > 6 GHz Linearity: ± 0.2 dB (30 MHz to 6 GHz)
Directivity	± 0.3 dB in TSL (rotation around probe axis) ± 0.5 dB in TSL (rotation normal to probe axis)
Dynamic Range	10 µW/g to > 100 mW/g Linearity: ± 0.2 dB (noise: typically < 1 µW/g)
Dimensions	Overall length: 337 mm (Tip: 20 mm) Tip diameter: 2.5 mm (Body: 12 mm) Typical distance from probe tip to dipole centers: 1 mm
Application	High precision dosimetric measurements in any exposure scenario (e.g., very strong gradient fields); the only probe that enables compliance testing for frequencies up to 6 GHz with precision of better 30%.

3.3 E-Field Probe(ES3DV3)

ES3DV3 Isotropic E-Field Probe for Dosimetric Measurements	
	Symmetrical design with triangular core Interleaved sensors Built-in shielding against static charges PEEK enclosure material (resistant to organic solvents, e.g., DGBE)
Calibration	ISO/IEC 17025 calibration service available.
Frequency	10 MHz to 4 GHz; Linearity: ± 0.2 dB (30 MHz to 4 GHz)
Directivity	± 0.2 dB in TSL (rotation around probe axis) ± 0.3 dB in TSL (rotation normal to probe axis)
Dynamic Range	5 μ W/g to > 100 mW/g; Linearity: ± 0.2 dB
Dimensions	Overall length: 337 mm (Tip: 20 mm) Tip diameter: 3.9 mm (Body: 12 mm) Distance from probe tip to dipole centers: 2.0 mm
Application	General dosimetry up to 4 GHz Dosimetry in strong gradient fields Compliance tests of mobile phones
Compatibility	DASY3, DASY4, DASY52 SAR and higher, EASY4/MRI

3.4 ELI Phantom

ELI Phantom	
	The ELI phantom is used for compliance testing of handheld and body-mounted wireless devices in the frequency range of 30 MHz to 6 GHz. ELI is fully compatible with the IEC 62209-2 standard and all known tissue simulating liquids. ELI has been optimized regarding its performance and can be integrated into our standard phantom tables. A cover prevents evaporation of the liquid. Reference markings on the phantom allow installation of the complete setup, including all predefined phantom positions and measurement grids, by teaching three points. The phantom is compatible with all SPEAG dosimetric probes and dipoles. ELI V5.0 and higher has the same shell geometry and is manufactured from the same material as ELI V4.0, but has reinforced top structure. ELI V6.0, released in August 2014, has the same shell geometry as ELI V4.0 but offers increased longterm stability.
Material	Vinyl ester, fiberglass reinforced (VE-GF)
Liquid Compatibility	The phantom shell is compatible with SPEAG tissue simulating liquids (sugar and oil based). Use of other liquids may render the phantom warranty void (see note or consult SPEAG support).
Shell Thickness	2.0 \pm 0.2 mm (bottom plate)
Dimensions	Major axis: 600 mm Minor axis: 400 mm
Filling Volume	approx. 30 liters
Support	DASY6: standard-size platform slot DASY52 stand-alone: SPEAG standard phantom table
Accessories	Mounting Device and Adaptors

3.5 Mounting Device



Mounting Device for Hand-Held Transmitters

MD4HHTV5 - Mounting Device for Hand-Held Transmitters

In combination with the Twin SAM V5.0/V5.0c or ELI phantoms, the Mounting Device for Hand-Held Transmitters enables rotation of the mounted transmitter device to specified spherical coordinates. At the heads, the rotation axis is at the ear opening. Transmitter devices can be easily and accurately positioned according to IEC 62209-1, IEEE 1528, FCC, or other specifications. The device holder can be locked for positioning at different phantom sections (left head, right head, flat).

Material: Polyoxymethylene (POM)

4. MEASUREMENT UNCERTAINTY

Uncertainty of SAR equipment for measurement Body 0.3 GHz to 3 GHz

No.		Error Description	Uncertainty Value (1 g) (%)	Uncertainty Value (10 g) (%)	Probe Dist.	Div.	C_i (1 g)	C_i (10 g)	$U_i(y)$ (1 g)	$U_i(y)$ (10 g)	V_i or V_{eff}
1	$U(PR_c)$	Probe Calibration	6.30	6.30	N	1.00	1.00	1.00	6.30	6.30	∞
2	$U(PR_i)$	Isotropy	1.87	1.87	R	$\sqrt{3}$	1.00	1.00	1.08	1.08	∞
3	$U(L)$	Linearity	0.60	0.60	R	$\sqrt{3}$	1.00	1.00	0.35	0.35	∞
4	$U(PR_{MR})$	Probe modulation response	2.40	2.40	R	$\sqrt{3}$	1.00	1.00	1.39	1.39	∞
6	$U(DL)$	Detection Limits	1.00	1.00	R	$\sqrt{3}$	1.00	1.00	0.58	0.58	∞
5	$U(BE)$	Boundary effect	1.00	1.00	R	$\sqrt{3}$	1.00	1.00	0.58	0.58	∞
7	$U(RE)$	Readout Electronics	0.30	0.30	N	1.00	1.00	1.00	0.30	0.30	∞
8	$U(T_{RT})$	Response Time	0.80	0.80	R	$\sqrt{3}$	1.00	1.00	0.46	0.46	∞
9	$U(T_{IT})$	Integration Time	2.60	2.60	R	$\sqrt{3}$	1.00	1.00	1.50	1.50	∞
10	$U(A_{RN})$	RF ambient conditions—noise	3.00	3.00	R	$\sqrt{3}$	1.00	1.00	1.73	1.73	∞
11	$U(A_{RR})$	RF ambient conditions—reflections	3.00	3.00	R	$\sqrt{3}$	1.00	1.00	1.73	1.73	∞
12	$U(PP_{RM})$	Probe positioner mech. Restrictions	0.40	0.40	R	$\sqrt{3}$	1.00	1.00	0.23	0.23	∞
13	$U(PP_{RP})$	Probe positioning with respect to phantom shell	2.90	2.90	R	$\sqrt{3}$	1.00	1.00	1.67	1.67	∞
14	$U(PP_{SAR})$	Post-processing(for max. SAR evaluation)	2.00	2.00	R	$\sqrt{3}$	1.00	1.00	1.15	1.15	∞
15	$U(DU)$	Device Holder Uncertainty	3.60	3.60	N	1.00	1.00	1.00	3.60	3.60	5.00
16	$U(PO_{ENV})$	Test sample positioning	0.92	0.94	N	1.00	1.00	1.00	0.92	0.94	9.00
17	$U(PS)$	Power scaling	0.00	0.00	R	$\sqrt{3}$	1.00	1.00	0.00	0.00	∞
18	$U(PD)$	Drift of output power(measured SAR drift)	5.00	5.00	R	$\sqrt{3}$	1.00	1.00	2.89	2.89	∞
19	$U(PU)$	Phantom Uncertainty	6.10	6.10	R	$\sqrt{3}$	1.00	1.00	3.52	3.52	∞
20	$U(CS_{DR})$	Algorithm for correcting SAR for deviations in permittivity and conductivity	1.90	1.90	N	1.00	1.00	0.84	1.90	1.60	∞
21	$U(LC_M)$	Liquid Conductivity (meas.)	1.39	1.26	N	1.00	0.78	0.71	1.08	0.89	5.00
22	$U(LP_M)$	Liquid Permittivity (meas.)	0.34	0.38	N	1.00	0.23	0.26	0.08	0.10	5.00
23	$U(LC_T)$	Liquid conductivity(temperature uncertainty)	1.87	1.71	R	$\sqrt{3}$	0.78	0.71	0.84	0.70	∞
24	$U(LP_T)$	Liquid permittivity(temperature uncertainty)	0.11	0.13	R	$\sqrt{3}$	0.23	0.26	0.01	0.02	∞
$U_c(sar)$ Combined standard uncertainty (%)									9.82	9.73	275
Extended uncertainty $U(\%)$									19.63	19.47	

Uncertainty of SAR equipment for measurement Body 3 GHz to 6 GHz

No.		Error Description	Uncertainty Value (1 g) (%)	Uncertainty Value (10 g) (%)	Probe Dist.	Div.	C _i (1 g)	C _i (10 g)	U _i (t) (1 g)	U _i (t) (10 g)	V _i or V _{eff}
1	U(PR _c)	Probe Calibration	6.30	6.30	N	1.00	1.00	1.00	6.30	6.30	∞
2	U(PR _i)	Isotropy	1.87	1.87	R	√3	1.00	1.00	1.08	1.08	∞
3	U(L)	Linearity	0.60	0.60	R	√3	1.00	1.00	0.35	0.35	∞
4	U(PR _{MR})	Probe modulation response	2.40	2.40	R	√3	1.00	1.00	1.39	1.39	∞
6	U(DL)	Detection Limits	1.00	1.00	R	√3	1.00	1.00	0.58	0.58	∞
5	U(BE)	Boundary effect	2.00	2.00	R	√3	1.00	1.00	1.15	1.15	∞
7	U(RE)	Readout Electronics	0.30	0.30	N	1.00	1.00	1.00	0.30	0.30	∞
8	U(TR _R)	Response Time	0.80	0.80	R	√3	1.00	1.00	0.46	0.46	∞
9	U(TR _I)	Integration Time	2.60	2.60	R	√3	1.00	1.00	1.50	1.50	∞
10	U(A _{no})	RF ambient conditions-noise	3.00	3.00	R	√3	1.00	1.00	1.73	1.73	∞
11	U(A _{re})	RF ambient conditions-reflections	3.00	3.00	R	√3	1.00	1.00	1.73	1.73	∞
12	U(PR _{pr})	Probe positioner mech. Restrictions	0.80	0.80	R	√3	1.00	1.00	0.46	0.46	∞
13	U(PR _{ps})	Probe positioning with respect to phantom shell	6.70	6.70	R	√3	1.00	1.00	3.87	3.87	∞
14	U(PP _{max})	Post-processing(for max. SAR evaluation)	4.00	4.00	R	√3	1.00	1.00	2.31	2.31	∞
15	U(DU)	Device Holder Uncertainty	3.60	3.60	N	1.00	1.00	1.00	3.60	3.60	5.00
16	U(PO _{env})	Test sample positioning	1.81	1.42	N	1.00	1.00	1.00	1.81	1.42	9.00
17	U(PS)	Power scaling	0.00	0.00	R	√3	1.00	1.00	0.00	0.00	∞
18	U(PD)	Drift of output power(measured SAR drift)	5.00	5.00	R	√3	1.00	1.00	2.89	2.89	∞
19	U(PI)	Phantom Uncertainty	6.60	6.60	R	√3	1.00	1.00	3.81	3.81	∞
20	U(CS _{alc})	Algorithm for correcting SAR for deviations in permittivity and conductivity	1.90	1.90	N	1.00	1.00	0.84	1.90	1.60	∞
21	U(LC _m)	Liquid Conductivity (meas.)	1.29	1.18	N	1.00	0.78	0.71	1.01	0.84	5.00
22	U(LP _m)	Liquid Permittivity (meas.)	0.59	0.67	N	1.00	0.23	0.26	0.14	0.17	5.00
23	U(LC _{tr})	Liquid conductivity(temperature uncertainty)	0.95	0.87	R	√3	0.78	0.71	0.43	0.36	∞
24	U(LP _{tr})	Liquid permittivity(temperature uncertainty)	0.05	0.06	R	√3	0.23	0.26	0.01	0.01	∞
U(sar) Combined standard uncertainty (%)									10.84	10.72	396
Extended uncertainty U(%)									21.68	21.44	

5. ANSI/IEEE C95.1-2005 RF EXPOSURE LIMIT

In order for users to be aware of the body-worn operating requirements for meeting RF exposure compliance, operating instructions and cautions statements are included in the user's manual.

5.1 Uncontrolled Environment

Uncontrolled Environments are defined as locations where there is the exposure of individuals who have no knowledge or control of their exposure. The general population/uncontrolled exposure limits are applicable to situations in which the general public may be exposed or in which persons who are exposed as a consequence of their employment may not be made fully aware of the potential for exposure or cannot exercise control over their exposure. Members of the general public would come under this category when exposure is not employment-related; for example, in the case of a wireless transmitter that exposes persons in its vicinity.

5.2 Controlled Environment

Controlled Environments are defined as locations where there is exposure that may be incurred by persons who are aware of the potential for exposure, (i.e. as a result of employment or occupation). In general, occupational/controlled exposure limits are applicable to situations in which persons are exposed as a consequence of their employment, who have been made fully aware of the potential for exposure and can exercise control over their exposure. This exposure category is also applicable when the exposure is of a transient nature due to incidental passage through a location where the exposure levels may be higher than the general population/uncontrolled limits, but the exposed person is fully aware of the potential for exposure and can exercise control over his or her exposure by leaving the area or by some other appropriate means.

Human Exposure Limits

	UNCONTROLLED ENVIRONMENT General Population (W/kg) or (mW/g)	CONTROLLED ENVIROMENT Professional Population (W/kg) or (mW/g)
SPATIAL PEAK SAR ¹ Brain	1.60	8.00
SPATIAL AVERAGE SAR ² Whole Body	0.08	0.40
SPATIAL PEAK SAR ³ Hands, Feet, Ankles, Wrists	4.00	20.00

¹ The Spatial Peak value of the SAR averaged over any 1 gram of tissue (defined as a tissue volume in the shape of a cube) and over the appropriate averaging time.

² The Spatial Average value of the SAR averaged over the whole body.

³ The Spatial Peak value of the SAR averaged over any 10 grams of tissue (defined as a tissue volume in the shape of a cube) and over the appropriate averaging time.

6. SYSTEM AND LIQUID VERIFICATION

6.1 System Verification setup

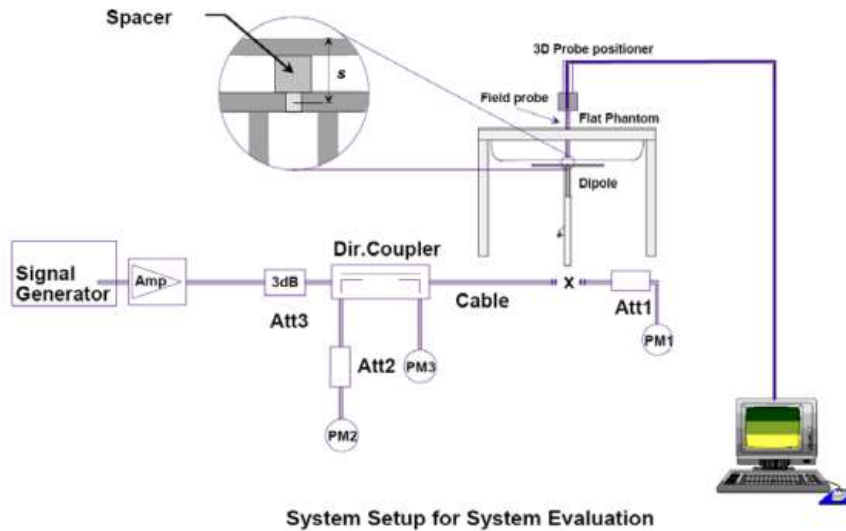

The system performance check verifies that the system operates within its specifications. System and operator errors can be detected and corrected. It is recommended that the system performance check be performed prior to any usage of the system in order to guarantee reproducible results. The system performance check uses normal SAR measurements in a simplified setup with a well characterized source. This setup was selected to give a high sensitivity to all parameters that might fail or vary over time. The system check does not intend to replace the calibration of the components, but indicates situations where the system uncertainty is exceeded due to drift or failure.

In the simplified setup for system evaluation, the DUT is replaced by a calibrated dipole and the power source is replaced by a continuous wave that comes from a signal generator. The calibrated dipole must be placed beneath the flat phantom section of the SAM twin phantom with the correct distance holder. The distance holder should touch the phantom surface with a light pressure at the reference marking and be oriented parallel to the long side of the phantom. The equipment setup is shown below:

1. Signal Generator
2. Amplifier
3. Directional Coupler
4. Power Meter
5. Calibrated Dipole

The output power on dipole port must be calibrated to 30 dBm (1000 mW) before dipole is connected.

Numerical reference SAR values (W/kg) for reference dipole and flat phantom

Frequency (MHz)	Phantom shell thickness (mm)	1 g SAR (W/kg)	10 g SAR (W/kg)	Local SAR at surface (above feed point) (W/kg)	Local SAR at surface (y = 2 cm offset from feed point) ^a (W/kg)
300	6.3	3.02	2.04	4.40	2.10
300	2.0	2.85	1.94	4.14	2.00
450	6.3	4.92	3.28	7.20	3.20
450	2.0	4.58	3.06	6.75	2.98
750	2.0	8.49	5.55	12.6	4.59
835	2.0	9.56	6.22	14.1	4.90
900	2.0	10.9	6.99	16.4	5.40
1450	2.0	29.0	16.0	50.2	6.50
1500	2.0	30.5	16.8	52.8	6.53
1640	2.0	34.2	18.4	60.4	6.69
1750	2.0	36.4	19.3	64.9	6.53
1800	2.0	38.4	20.1	69.5	6.80
1900	2.0	39.7	20.5	72.1	6.60
1950	2.0	40.5	20.9	72.7	6.60
2000	2.0	41.1	21.1	74.6	6.50
2100	2.0	43.6	21.9	79.9	6.58
2300	2.0	48.7	23.3	92.8	7.18
2450	2.0	52.4	24.0	104	7.70
2600	2.0	55.3	24.6	113	8.29
3000	2.0	63.4	25.6	142	9.50
3500	2.0	67.1	25.0	169	12.1
3700	2.0	67.4	24.2	178	12.7
5000	2.0	77.9	22.1	305	15.1
5200	2.0	76.5	21.6	310	15.9
5500	2.0	83.3	23.4	349	18.1
5800	2.0	78.0	21.9	341	20.3

NOTE 1—All SAR values are normalized to 1 W forward power.

NOTE 2—The 1 g and 10 g target SAR values are only valid for the system validation defined in 8.3, using dipoles having dimensions as defined in G.1.

NOTE 3—The values above 3 GHz depend on the dipole spacer and detailed construction of the dipoles and can vary by as much as ± 10%. The reasons are that the dipole dimensions are short with respect to arm diameter and spacer dimensions, i.e., the numerical target values are not generic and shall be determined for a particular test setup. Also, the results can be sensitive to the permittivity of the phantom shell (see Onishi and Uebayashi [B167] for details). For these reasons, the laboratory shall determine using numerical and experimental methods the target SAR values for the particular test setup.

NOTE 4—The dipole forward power should be limited so that the measured SAR values are within the dynamic range of the probe to avoid probe damage.

^a The nonmonotonic behavior of the local SAR values at 2 cm transverse offset from the feed point for 1640 MHz to 2100 MHz is due to tissue-equivalent liquid conductivity values selected for these frequencies (see Table 3).

6.2 Liquid Validation

The dielectric parameters were checked prior to assessment using the DAK dielectric probe kit. The dielectric parameters measured are reported in each correspondent section.

6.3 Recommended Tissue Dielectric Parameters

The head and body tissue dielectric parameters recommended by KDB865664 have been incorporated in the following table.

Target Frequency (MHz)	Head		Body	
	ϵ_r	σ (S/m)	ϵ_r	σ (S/m)
150	52.3	0.76	61.9	0.80
300	45.3	0.87	58.2	0.92
450	43.5	0.87	56.7	0.94
835	41.5	0.90	55.2	0.97
900	41.5	0.97	55.0	1.05
915	41.5	0.98	55.0	1.06
1450	40.5	1.20	54.0	1.30
1610	40.3	1.29	53.8	1.40
1800 – 2000	40.0	1.40	53.3	1.52
2450	39.2	1.80	52.7	1.95
3000	38.5	2.40	52.0	2.73
5800	35.3	5.27	48.2	6.00

(ϵ_r = relative permittivity, σ = conductivity and $\rho = 1000 \text{ kg/m}^3$)

6.4 Liquid Confirmation Results

6.4.1 System Verification

Frequency (MHz)	Tissue Type	Liquid Temp.(°C)	Parameter	Target Value	Measured Value	Deviation	Limit (%)	Date
2 450	Body	21.4	Permittivity	52.7	50.9	-3.48%	± 5	2018, Dec, 20
			Conductivity	1.95	1.95	-0.03%	± 5	

6.4.2 Test Channel

Frequency (MHz)	Tissue Type	Liquid Temp.(°C)	Parameter	Target Value	Measured Value	Deviation	Limit (%)	Date
2 402	Body	21.4	Permittivity	52.8	51.1	-3.17%	± 5	2018, Dec, 20
			Conductivity	1.89	1.90	0.85%	± 5	
2 440	Body	21.4	Permittivity	52.7	50.9	-3.43%	± 5	2018, Dec, 20
			Conductivity	1.94	1.94	0.05%	± 5	
2 480	Body	21.4	Permittivity	52.7	50.7	-3.65%	± 5	2018, Dec, 20
			Conductivity	1.99	1.98	-0.45%	± 5	
2 405	Body	21.4	Permittivity	52.8	51.1	-3.18%	± 5	2018, Dec, 20
			Conductivity	1.89	1.91	0.78%	± 5	
2 440	Body	21.4	Permittivity	52.7	50.9	-3.43%	± 5	2018, Dec, 20
			Conductivity	1.94	1.94	0.05%	± 5	
2 475	Body	21.4	Permittivity	52.7	50.8	-3.63%	± 5	2018, Dec, 20
			Conductivity	1.98	1.98	-0.42%	± 5	

6.5 System Verification Results

Freq. (MHz)	Tissue Type	Amb. Temp (°C)	Liquid Temp (°C)	Input Power (mW)	Dipole S/N	Probe S/N	Measured SAR 10g	1W Normalized SAR 10g	1W Target SAR 10g	Deviation	Date
2 450	Body	21.6	21.4	250	923	3832	6.07	24.3	24.0	1.17%	2018, Dec,20

7. SAR MEASUREMENT PROCEDURES

Step 1: Power Reference Measurement

The Power Reference Measurement and Power Drift Measurements are for monitoring the power drift of the device under test in the batch process. The Minimum distance of probe sensors to surface determines the closest measurement point to phantom surface. The minimum distance of probe sensors to surface is 2 mm. This distance cannot be smaller than the Distance of sensor calibration points to probe tip as defined in the probe properties.

Step 2: Area Scan

The Area Scan is used as a fast scan in two dimensions to find the area of high field values, before doing a fine measurement around the hot spot. The sophisticated interpolation routines implemented in DASY software can find the maximum locations even in relatively coarse grids. When an Area Scan has measured all reachable points, it computes the field maximal found in the scanned area, within a range of the global maximum. The range (in dB) is specified in the standards for compliance testing.

For example, a 2 dB range is required in IEEE Standard 1528 and IEC 62209 standards, whereby 3 dB is a requirement when compliance is assessed in accordance with the ARIB standard (Japan). If only one Zoom Scan follows the Area Scan, then only the absolute maximum will be taken as reference. For cases where multiple maximums are detected, the number of Zoom Scans has to be increased accordingly.

Step 3: Zoom Scan

Zoom Scans are used to assess the peak spatial SAR values within a cubic averaging volume containing 1 g and 10 g of simulated tissue. The Zoom Scan measures 5x5x7 points within a cube whose base faces are centered on the maxima found in a preceding area scan job within the same procedure. When the measurement is done, the Zoom Scan evaluates the averaged SAR for 1 g and 10 g and displays these values next to the job's label.

Step 4: Power drift measurement

The Power Drift Measurement measures the field at the same location as the most recent power reference measurement within the same procedure, and with the same settings. The Power Drift Measurement gives the field difference in dB from the reading conducted within the last Power Reference Measurement. This allows a user to monitor the power drift of the device under test within a batch process. The measurement procedure is the same as Step 1.

Step 5: Z-Scan

The Z Scan measures points along a vertical straight line. The line runs along the Z-axis of a one dimensional grid. In order to get a reasonable extrapolation, the extrapolated distance should not be larger than the step size in Z-direction.

* Z Scan Report on Liquid Measure the height ANNEX C. Liquid Depth photo to replace

		≤ 3 GHz	> 3 GHz
Maximum distance from closest measurement point (geometric center of probe sensors) to phantom surface		5 ± 1 mm	½·δ·ln(2) ± 0.5 mm
Maximum probe angle from probe axis to phantom surface normal at the measurement location		30° ± 1°	20° ± 1°
Maximum area scan spatial resolution: Δx _{Area} , Δy _{Area}		≤ 2 GHz: ≤ 15 mm 2 – 3 GHz: ≤ 12 mm	3 – 4 GHz: ≤ 12 mm 4 – 6 GHz: ≤ 10 mm
		When the x or y dimension of the test device, in the measurement plane orientation, is smaller than the above, the measurement resolution must be ≤ the corresponding x or y dimension of the test device with at least one measurement point on the test device.	
Maximum zoom scan spatial resolution: Δx _{Zoom} , Δy _{Zoom}		≤ 2 GHz: ≤ 8 mm 2 – 3 GHz: ≤ 5 mm*	3 – 4 GHz: ≤ 5 mm* 4 – 6 GHz: ≤ 4 mm*
Maximum zoom scan spatial resolution, normal to phantom surface	uniform grid: Δz _{Zoom} (n)	≤ 5 mm	3 – 4 GHz: ≤ 4 mm 4 – 5 GHz: ≤ 3 mm 5 – 6 GHz: ≤ 2 mm
	graded grid	Δz _{Zoom} (1): between 1 st two points closest to phantom surface	≤ 4 mm 3 – 4 GHz: ≤ 3 mm 4 – 5 GHz: ≤ 2.5 mm 5 – 6 GHz: ≤ 2 mm
		Δz _{Zoom} (n>1): between subsequent points	≤ 1.5 · Δz _{Zoom} (n-1)
Minimum zoom scan volume	x, y, z	≥ 30 mm	3 – 4 GHz: ≥ 28 mm 4 – 5 GHz: ≥ 25 mm 5 – 6 GHz: ≥ 22 mm
Note: δ is the penetration depth of a plane-wave at normal incidence to the tissue medium; see draft standard IEEE P1528-2011 for details. * When zoom scan is required and the <i>reported</i> SAR from the <i>area scan based 1-g SAR estimation</i> procedures of KDB 447498 is ≤ 1.4 W/kg, ≤ 8 mm, ≤ 7 mm and ≤ 5 mm zoom scan resolution may be applied, respectively, for 2 GHz to 3 GHz, 3 GHz to 4 GHz and 4 GHz to 6 GHz.			

8. TEST EQUIPMENT LIST

Manufacturer	Model	Serial No.	CaL.Due	Used
STAUBLI	TX90XL	F17/59RBA1/A/01	N/A	V
STAUBLI	CS8C Speag TX90	F17/59RBA1/C/01	N/A	V
SPEAG	SE UMS 028 BB	1544	N/A	V
STAUBLI	SP1	D 221 426 06B	N/A	V
SPEAG	SE UKS 030 AA	1040	N/A	V
SPEAG	Twin Phantom	TP-1381	N/A	
SPEAG	ELI4 Phantom V8.0	TP-2056	N/A	V
SPEAG	Mounting Device	N/A	N/A	
SPEAG	Mounting Device	SM LH1 001 AC	N/A	V
Agilent	85033E	N/A	N/A	V
SPEAG	SD 000 D04 BM	557	2019-02-15	V
SPEAG	EX3DV4	3832	2019-02-21	V
SPEAG	D835V2	4d172	2020-07-23	
SPEAG	D2450V2	923	2019-11-21	V
SPEAG	D5GHzV2	1094	2019-11-22	
SPEAG	DAK-3.5 Short	1140	2019-11-20	V
HP	8665B	3744A01349	2019-08-28	V
EMPOWER	BBS3Q7ECK-2001	1045D/C0536	2019-08-28	V
SUNGSAN	M1001	1	2019-08-28	
VARIAN	VZC6961K11212	6673	2019-08-27	
HP	778D	16500	2019-08-27	V
HP	11692D	1212A05057	2019-08-27	
Agilent	E4419B	MY45100284	2019-08-27	V
Agilent	E4419B	MY45100286	2019-08-27	V
HP	8481H	3318A17600	2019-08-27	V
HP	8481A	US37290447	2019-08-27	V
HP	8481A	3318A89373	2019-08-27	V
WAINWRIGHT	WLJS1500-6EF	1	2019-08-28	
WAINWRIGHT	WLJS3000-6EF	1	2019-08-28	
Agilent	E8357A	US41070399	2019-08-27	V
ROHDE & SCHWARZ	FSP	10017	2019-08-23	V
LKM Electronic GmbH	DTM3000-Spezial	3247	2019-08-28	V
CAS	TE-201	14011777-1	2019-08-28	V
Bird	50-6A-MFN-30	N/A	2019-08-27	V
Agilent	E5515C	MY4836717	2019-08-27	

9. RF CONDUCTED POWER

9.1 Bluetooth

LE

Mode	Freq. (MHz)	CH	Conducted Power (dBm)	Tolerance (dBm)
LE	2402	0	7.78	8.0 ± 1
	2440	19	7.96	
	2480	39	8.02	

9.2 Zigbee

Mode	Freq. (MHz)	CH	Conducted Power (dBm)	Tolerance (dBm)
Zigbee	2 405	11	7.81	8.0 ± 1
	2 440	18	7.93	
	2 475	25	8.01	

10.SAR TEST RESULTS

< Bluetooth LE Limb SAR_0mm distance from Phantom >

Mode	Position	Freq. (MHz)	CH	Conducted Power (dBm)	Max. Allowed Power (dBm)	Scaling Factor	Measured 10g SAR (W/kg)	Reported SAR (W/kg)
BT LE	Front	2 402	0	7.78	9.00	1.32	0.126	0.167
		2 440	19	7.96	9.00	1.27	0.100	0.127
		2 480	39	8.02	9.00	1.25	0.077	0.097
	Back	2 440	19	7.96	9.00	1.27	0.065	0.083
	Top	2 440	19	7.96	9.00	1.27	0.054	0.068
	Left	2 440	19	7.96	9.00	1.27	0.007	0.009
	Right	2 440	19	7.96	9.00	1.27	0.008	0.010

< Zigbee Limb SAR_0mm distance from Phantom >

Mode	Position	Freq. (MHz)	CH	Conducted Power (dBm)	Max. Allowed Power (dBm)	Scaling Factor	Measured 10g SAR (W/kg)	Reported SAR (W/kg)
Zigbee	Front	2 405	11	7.81	9.00	1.32	0.101	0.133
		2 440	18	7.93	9.00	1.28	0.110	0.141
		2 475	25	8.01	9.00	1.26	0.075	0.094
	Back	2 440	18	7.93	9.00	1.28	0.058	0.074
	Top	2 440	18	7.93	9.00	1.28	0.050	0.064
	Left	2 440	18	7.93	9.00	1.28	0.006	0.008
	Right	2 440	18	7.93	9.00	1.28	0.008	0.011

* Note

1. According to KDB 447498 D01, Head/Body SAR test was omitted.

$$[(\text{max. power of channel, including tune-up tolerance, mW}) / (\text{min. test separation distance, mm})] \cdot [\sqrt{f(\text{GHz})}] \leq 3.0$$

max. power of channel = 9 dBm = 7.94 mW

min. test separation distance: 15 mm is the minimum separation distance required under KDB 447498 for held to face and next to mouth usage conditions (refer sections 6.1 and 6.2)

$$(7.94 \text{ mW} / 15 \text{ mm}) \cdot \sqrt{2.48} = 0.83$$

As the calculated value is less than 3.0 this device is exempt from SAR measurement for held to face operations at a separation distance of 15 mm or more between device and face.

2. Antenna located > 25 mm From bottom. So bottom side of SAR TEST was omitted.

3. This SAR evaluation was performed under "Test mode (continuous signal)" for "push to talk" function.

ANNEX A. SYSTEM VERIFICATION PLOTS

< 2 450 MHz Body / Date : Dec 20, 2018 >

DUT: Dipole 2450 MHz; Type: D2450V2; Serial: D2450V2 - SN:923

Communication System: UID 0, CW (0); Communication System Band: D2450 (2450.0 MHz);

Frequency: 2450 MHz; Communication System PAR: 0 dB; PMF: 1

Medium parameters used: $f = 2450$ MHz; $\sigma = 1.949$ S/m; $\epsilon_r = 50.865$; $\rho = 1000$ kg/m³

Phantom section: Flat Section

Measurement Standard: DASY5 (IEEE/IEC/ANSI C63.19-2011)

DASY Configuration:

Probe: EX3DV4 - SN3832; ConvF(7.28, 7.28, 7.28); Calibrated: 2/21/2018;

Modulation Compensation:

Sensor-Surface: 1.4mm (Mechanical Surface Detection), $z = 1.0, 31.0$

Electronics: DAE4 Sn557; Calibrated: 2/15/2018

Phantom: ELI V8.0_20170913; Type: QD OVA 004 AA; Serial: 2056

DASY52 52.10.0(1446); SEMCAD X 14.6.10(7417)

Configuration/2 450 MHz SPC/Area Scan (71x101x1): Interpolated grid: $dx=1.200$ mm, $dy=1.200$ mm

Maximum value of SAR (interpolated) = 22.4 W/kg

Configuration/2 450 MHz SPC/Zoom Scan (7x7x7)/Cube 0: Measurement grid: $dx=5$ mm, $dy=5$ mm, $dz=5$ mm

Reference Value = 108.9 V/m; Power Drift = 0.02 dB

Peak SAR (extrapolated) = 28.0 W/kg

SAR(1 g) = 13.1 W/kg; SAR(10 g) = 6.07 W/kg

Maximum value of SAR (measured) = 22.2 W/kg

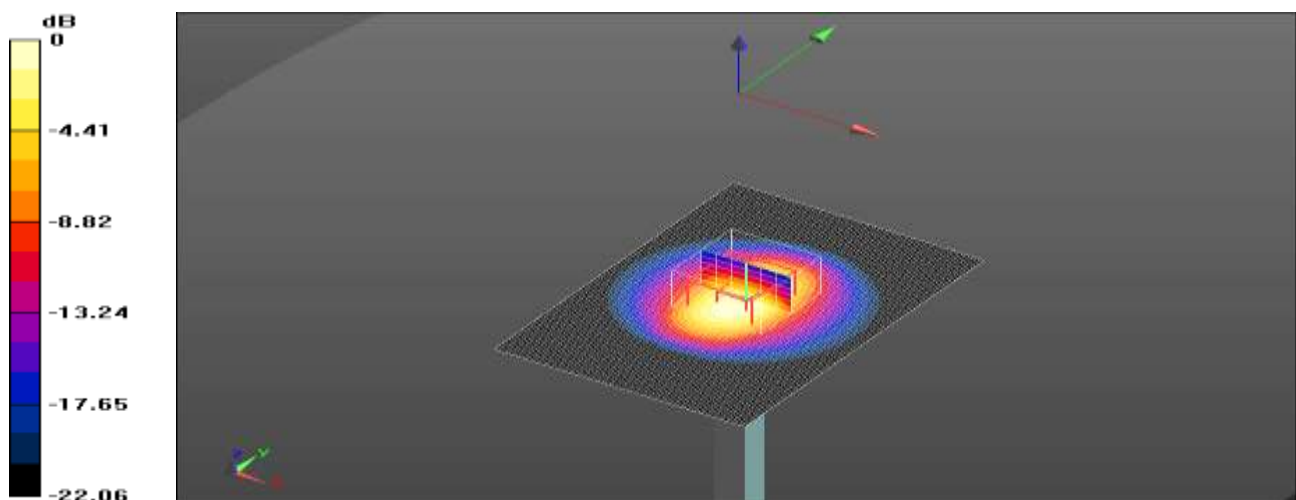

0 dB = 22.2 W/kg = 13.46 dBW/kg

ANNEX B. SAR TEST PLOTS

< Bluetooth LE CH 0_2 402 MHz Front / Date : Dec 20, 2018 >

DUT: RMCRRM1BP1; Type: Sample; Serial: Not Specified

Communication System: UID 0, Bluetooth (0); Communication System Band: Bluetooth;

Frequency: 2402 MHz; Communication System PAR: 0 dB; PMF: 1

Medium parameters used (interpolated): $f = 2402$ MHz; $\sigma = 1.904$ S/m; $\epsilon_r = 51.086$; $\rho = 1000$ kg/m³

Phantom section: Flat Section

Measurement Standard: DASYS (IEEE/IEC/ANSI C63.19-2011)

DASY Configuration:

Probe: EX3DV4 - SN3832; ConvF(7.28, 7.28, 7.28); Calibrated: 2/21/2018;

Modulation Compensation:

Sensor-Surface: 1.4mm (Mechanical Surface Detection), $z = 1.0, 31.0$

Electronics: DAE4 Sn557; Calibrated: 2/15/2018

Phantom: ELI V8.0_20170913; Type: QD OVA 004 AA; Serial: 2056

DASY52 52.10.0(1446); SEMCAD X 14.6.10(7417)

Configuration/Bluetooth_LE_ch 0_Front/Area Scan (61x81x1): Interpolated grid: $dx=1.200$ mm, $dy=1.200$ mm

Maximum value of SAR (interpolated) = 0.611 W/kg

Configuration/Bluetooth_LE_ch 0_Front/Zoom Scan (7x7x7)/Cube 0: Measurement grid: $dx=5$ mm, $dy=5$ mm, $dz=5$ mm

Reference Value = 12.14 V/m; Power Drift = 0.09 dB

Peak SAR (extrapolated) = 0.810 W/kg

SAR(1 g) = 0.287 W/kg; SAR(10 g) = 0.126 W/kg

Maximum value of SAR (measured) = 0.567 W/kg

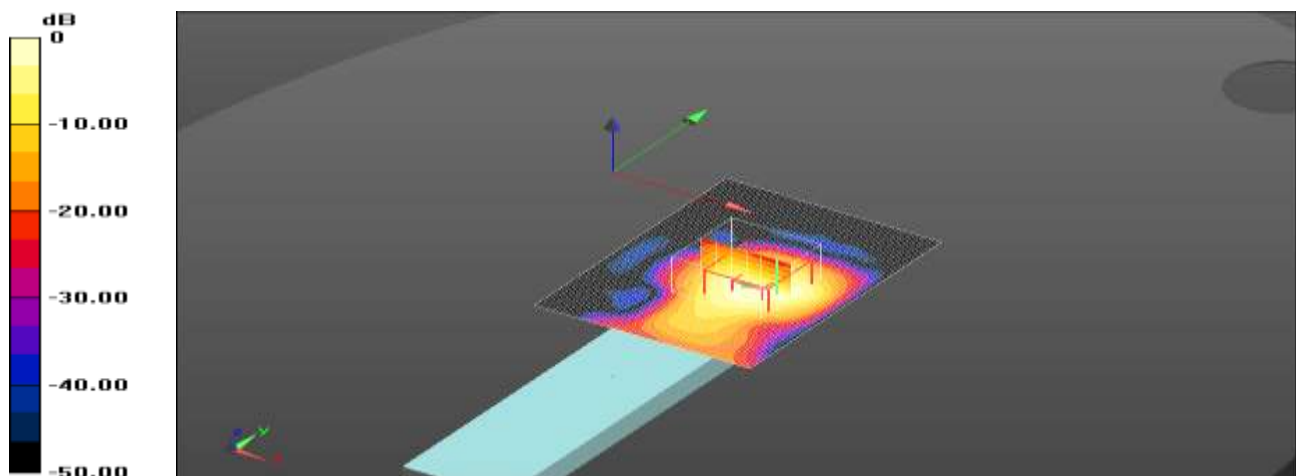

0 dB = 0.567 W/kg = -2.46 dBW/kg

< Zigbee CH 18_2 440 MHz Front / Date : Dec 20, 2018 >

DUT: RMCRM1BP1; Type: Sample; Serial: Not Specified
 Communication System: UID 0, Zigbee (0); Communication System Band: Zigbee;
 Frequency: 2440 MHz; Communication System PAR: 0 dB; PMF: 1.12202e-005
 Medium parameters used: $f = 2440$ MHz; $\sigma = 1.938$ S/m; $\epsilon_r = 50.906$; $\rho = 1000$ kg/m³
 Phantom section: Flat Section
 Measurement Standard: DASY5 (IEEE/IEC/ANSI C63.19-2011)
 DASY Configuration:
 Probe: EX3DV4 - SN3832; ConvF(7.28, 7.28, 7.28); Calibrated: 2/21/2018;
 Modulation Compensation:
 Sensor-Surface: 1.4mm (Mechanical Surface Detection), $z = 1.0, 31.0$
 Electronics: DAE4 Sn557; Calibrated: 2/15/2018
 Phantom: ELI V8.0_20170913; Type: QD OVA 004 AA; Serial: 2056
 DASY52 52.10.0(1446); SEMCAD X 14.6.10(7417)

Configuration/Zigbee_ch 18_Front/Area Scan (71x81x1): Interpolated grid: $dx=1.200$ mm, $dy=1.200$ mm

Maximum value of SAR (interpolated) = 0.591 W/kg

Configuration/Zigbee_ch 18_Front/Zoom Scan (7x7x7)/Cube 0: Measurement grid: $dx=5$ mm, $dy=5$ mm, $dz=5$ mm

Reference Value = 10.81 V/m; Power Drift = -0.08 dB

Peak SAR (extrapolated) = 0.675 W/kg

SAR(1 g) = 0.257 W/kg; SAR(10 g) = 0.110 W/kg

Maximum value of SAR (measured) = 0.455 W/kg

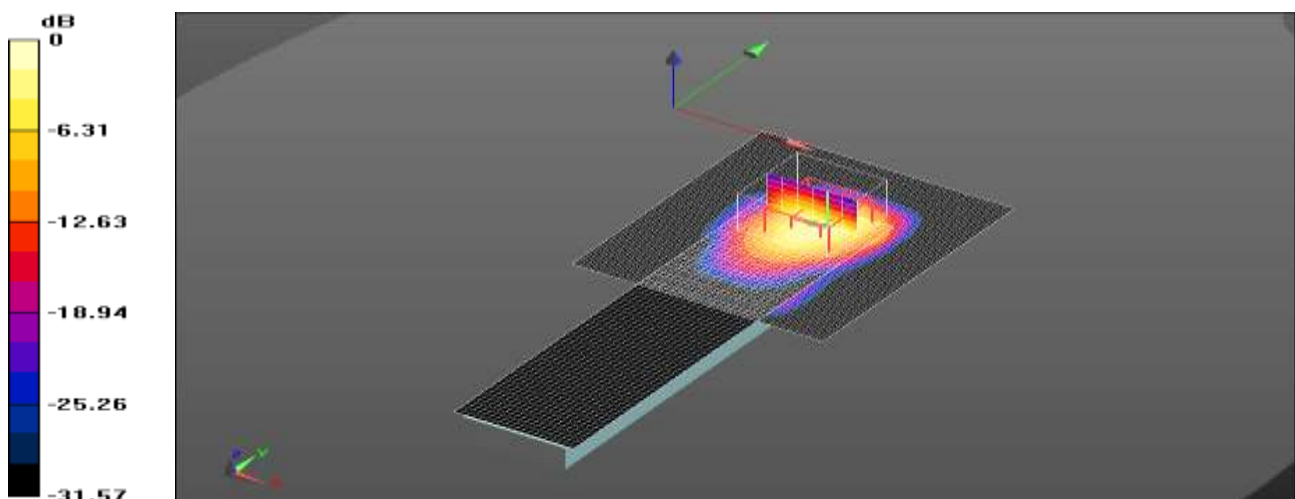

0 dB = 0.455 W/kg = -3.42 dBW/kg

ANNEX C. PHOTOGRAPHS

< System Verification >



< 2 450 MHz >

< Liquid Depth >

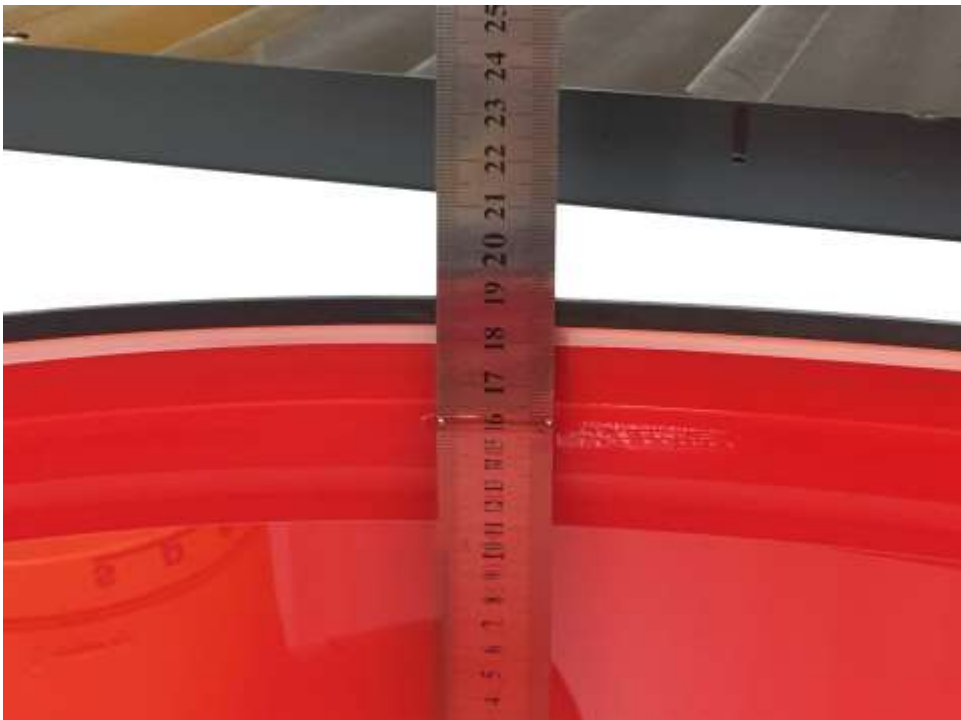

< 2 450 MHz >

ANNEX D. ANTENNA INFORMATION

< Antenna Location >

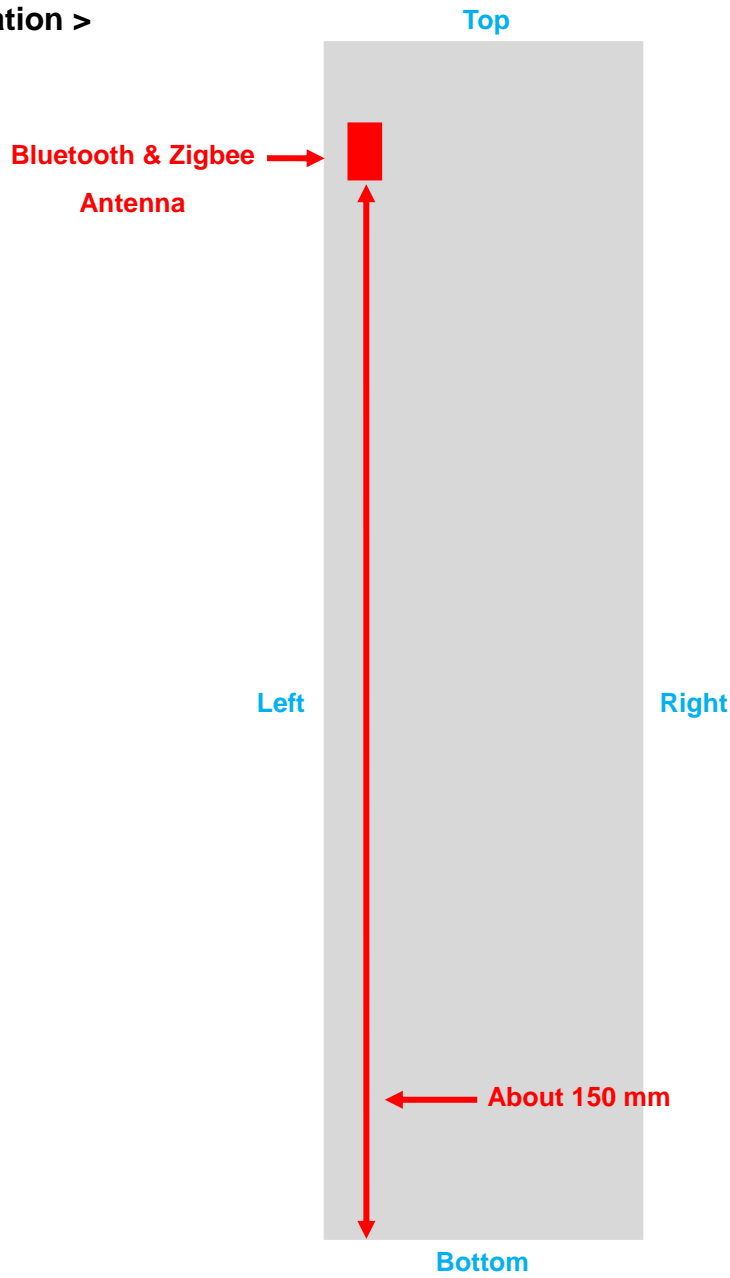

ANNEX E. PROBE AND DIPOLE CALIBRATION CERTIFICATES

< E-Field Probe : EX3DV4 – SN 3832 >

Calibration Laboratory of
Schmid & Partner
Engineering AG
Zeughausstrasse 43, 8004 Zurich, Switzerland



S Schweizerischer Kalibrierdienst
C Service suisse d'étalonnage
S Servizio svizzero di taratura
S Swiss Calibration Service

Accredited by the Swiss Accreditation Service (SAS)
The Swiss Accreditation Service is one of the signatories to the EA
Multilateral Agreement for the recognition of calibration certificates

Accreditation No.: SCS 0108

Client **Onetech (Dymstec)**

Certificate No: **EX3-3832_Feb18**

CALIBRATION CERTIFICATE	
Object	EX3DV4 - SN:3832
Calibration procedure(s)	QA CAL-01.v9, QA CAL-12.v9, QA CAL-14.v4, QA CAL-23.v5, QA CAL-25.v6 Calibration procedure for dosimetric E-field probes
Calibration date:	February 21, 2018
This calibration certificate documents the traceability to national standards, which realize the physical units of measurements (SI). The measurements and the uncertainties with confidence probability are given on the following pages and are part of the certificate.	
All calibrations have been conducted in the closed laboratory facility: environment temperature (22 ± 3)°C and humidity < 70%.	
Calibration Equipment used (M&TE critical for calibration)	

Primary Standards	ID	Cal Date (Certificate No.)	Scheduled Calibration
Power meter NRP	SN: 104778	04-Apr-17 (No. 217-02521/02522)	Apr-18
Power sensor NRP-ZB1	SN: 103244	04-Apr-17 (No. 217-02521)	Apr-18
Power sensor NRP-Z91	SN: 103245	04-Apr-17 (No. 217-02525)	Apr-18
Reference 20 dB Attenuator	SN: 85277 (20x)	07-Apr-17 (No. 217-02528)	Apr-18
Reference Probe ES3DV2	SN: 3013	30-Dec-17 (No. ES3-3013, Dec17)	Dec-18
DAE4	SN: 860	21-Dec-17 (No. DAE4-860, Dec17)	Dec-18
Secondary Standards	ID	Check Date (in house)	Scheduled Check
Power meter E4419B	SN: GB41293874	08-Apr-16 (in house check Jun-16)	In house check: Jun-18
Power sensor E4412A	SN: MY41498087	06-Apr-16 (in house check Jun-16)	In house check: Jun-18
Power sensor E4412A	SN: 000110210	06-Apr-16 (in house check Jun-16)	In house check: Jun-18
RF generator HP 8648C	SN: US3642U01700	04-Aug-99 (in house check Jun-16)	In house check: Jun-18
Network Analyzer HP 8753E	SN: US37390585	18-Oct-01 (in house check Oct-17)	In house check: Oct-18

Calibrated by:	Name Jeton Kastrati	Function Laboratory Technician	Signature
Approved by:	Name Katja Pukovic	Function Technical Manager	Signature
This calibration certificate shall not be reproduced except in full without written approval of the laboratory.			Issued: February 22, 2018

**Calibration Laboratory of
Schmid & Partner
Engineering AG**
Zeughausstrasse 43, 8004 Zurich, Switzerland



S Schweizerischer Kalibrierdienst
C Service suisse d'étalonnage
S Servizio svizzero di taratura
S Swiss Calibration Service

Accredited by the Swiss Accreditation Service (SAS)
The Swiss Accreditation Service is one of the signatories to the EA
Multilateral Agreement for the recognition of calibration certificates

Accreditation No.: **SCS 0108**

Glossary:

TSL	Issue simulating liquid
NORM _{x,y,z}	sensitivity in free space
ConvF	sensitivity in TSL / NORM _{x,y,z}
DCP	diode compression point
CF	crest factor (1/duty_cycle) of the RF signal
A, B, C, D	modulation dependent linearization parameters
Polarization φ	φ rotation around probe axis
Polarization ϑ	ϑ rotation around an axis that is in the plane normal to probe axis (at measurement center), i.e., $\vartheta = 0$ is normal to probe axis
Connector Angle	information used in DASY system to align probe sensor X to the robot coordinate system

Calibration is Performed According to the Following Standards:

- a) IEEE Std 1528-2013, "IEEE Recommended Practice for Determining the Peak Spatial-Averaged Specific Absorption Rate (SAR) in the Human Head from Wireless Communications Devices: Measurement Techniques", June 2013
- b) IEC 62209-1, "Measurement procedure for the assessment of Specific Absorption Rate (SAR) from hand-held and body-mounted devices used next to the ear (frequency range of 300 MHz to 6 GHz)", July 2016
- c) IEC 62209-2, "Procedure to determine the Specific Absorption Rate (SAR) for wireless communication devices used in close proximity to the human body (frequency range of 30 MHz to 6 GHz)", March 2010
- d) KDB 865664, "SAR Measurement Requirements for 100 MHz to 6 GHz"

Methods Applied and Interpretation of Parameters:

- **NORM_{x,y,z}**: Assessed for E-field polarization $\vartheta = 0$ ($f \leq 900$ MHz in TEM-cell; $f > 1800$ MHz: R22 waveguide). NORM_{x,y,z} are only intermediate values, i.e., the uncertainties of NORM_{x,y,z} does not affect the E²-field uncertainty inside TSL (see below ConvF).
- **NORM(f)_{x,y,z}** = NORM_{x,y,z} * frequency_response (see Frequency Response Chart). This linearization is implemented in DASY4 software versions later than 4.2. The uncertainty of the frequency response is included in the stated uncertainty of ConvF.
- **DCP_{x,y,z}**: DCP are numerical linearization parameters assessed based on the data of power sweep with CW signal (no uncertainty required). DCP does not depend on frequency nor media.
- **PAR**: PAR is the Peak to Average Ratio that is not calibrated but determined based on the signal characteristics
- **A_{x,y,z}; B_{x,y,z}; C_{x,y,z}; D_{x,y,z}; VR_{x,y,z}**: A, B, C, D are numerical linearization parameters assessed based on the data of power sweep for specific modulation signal. The parameters do not depend on frequency nor media. VR is the maximum calibration range expressed in RMS voltage across the diode.
- **ConvF and Boundary Effect Parameters**: Assessed in flat phantom using E-field (or Temperature Transfer Standard for $f \leq 800$ MHz) and inside waveguide using analytical field distributions based on power measurements for $f > 800$ MHz. The same setups are used for assessment of the parameters applied for boundary compensation (alpha, depth) of which typical uncertainty values are given. These parameters are used in DASY4 software to improve probe accuracy close to the boundary. The sensitivity in TSL corresponds to NORM_{x,y,z} * ConvF whereby the uncertainty corresponds to that given for ConvF. A frequency dependent ConvF is used in DASY version 4.4 and higher which allows extending the validity from ± 50 MHz to ± 100 MHz.
- **Spherical isotropy (3D deviation from isotropy)**: in a field of low gradients realized using a flat phantom exposed by a patch antenna.
- **Sensor Offset**: The sensor offset corresponds to the offset of virtual measurement center from the probe tip (on probe axis). No tolerance required.
- **Connector Angle**: The angle is assessed using the information gained by determining the NORM_x (no uncertainty required).

EX3DV4 – SN:3832

February 21, 2018

Probe EX3DV4

SN:3832

Manufactured: November 7, 2011
Calibrated: February 21, 2018

Calibrated for DASY/EASY Systems
(Note: non-compatible with DASY2 system!)

EX3DV4- SN:3832

February 21, 2018

DASY/EASY - Parameters of Probe: EX3DV4 - SN:3832

Basic Calibration Parameters

	Sensor X	Sensor Y	Sensor Z	Unc (k=2)
Norm ($\mu\text{V}/(\text{V}/\text{m})^2$) ^A	0.44	0.43	0.57	
DCP (mV) ^B	96.4	104.5	97.9	± 10.1 %

Modulation Calibration Parameters

UID	Communication System Name		A dB	B dB $\sqrt{\mu\text{V}}$	C	D dB	VR mV	Unc ^E (k=2)
0	CW	X	0.0	0.0	1.0	0.00	144.7	±3.5 %
		Y	0.0	0.0	1.0		147.9	
		Z	0.0	0.0	1.0		132.6	

Note: For details on UID parameters see Appendix.

Sensor Model Parameters

	C1 fF	C2 fF	α V ⁻¹	T1 ms.V ⁻²	T2 ms.V ⁻¹	T3 ms	T4 V ⁻²	T5 V ⁻¹	T6
X	50.28	372.8	35.32	18.56	0.744	5.096	0.931	0.467	1.007
Y	46.38	353.8	36.96	15.73	0.988	5.079	0.000	0.653	1.01
Z	48.64	356.8	34.59	21.38	0.412	5.100	0.980	0.392	1.009

The reported uncertainty of measurement is stated as the standard uncertainty of measurement multiplied by the coverage factor k=2, which for a normal distribution corresponds to a coverage probability of approximately 95%.

^A The uncertainties of Norm X,Y,Z do not affect the E²-field uncertainty inside TSL (see Pages 5 and 6).

^B Numerical linearization parameter; uncertainty not required.

^E Uncertainty is determined using the max. deviation from linear response applying rectangular distribution and is expressed for the square of the field value.

EX3DV4- SN:3832

February 21, 2018

DASY/EASY - Parameters of Probe: EX3DV4 - SN:3832

Calibration Parameter Determined in Head Tissue Simulating Media

f (MHz) ^c	Relative Permittivity ^f	Conductivity (S/m) ^f	ConvF X	ConvF Y	ConvF Z	Alpha ^g	Depth ^h (mm)	Unc (k=2)
150	52.3	0.76	11.52	11.52	11.52	0.00	1.00	± 13.3 %
300	45.3	0.87	11.16	11.16	11.16	0.08	1.20	± 13.3 %
450	43.5	0.87	10.51	10.51	10.51	0.15	1.30	± 13.3 %
750	41.9	0.89	10.23	10.23	10.23	0.48	0.90	± 12.0 %
835	41.5	0.90	9.54	9.54	9.54	0.47	0.88	± 12.0 %
1750	40.1	1.37	8.36	8.36	8.36	0.38	0.86	± 12.0 %
1950	40.0	1.40	7.96	7.96	7.96	0.43	0.82	± 12.0 %
2450	39.2	1.80	7.28	7.28	7.28	0.35	0.80	± 12.0 %
5200	36.0	4.66	5.50	5.50	5.50	0.30	1.80	± 13.1 %
5300	35.9	4.76	5.34	5.34	5.34	0.30	1.80	± 13.1 %
5500	35.6	4.96	4.82	4.82	4.82	0.40	1.80	± 13.1 %
5600	35.5	5.07	4.74	4.74	4.74	0.40	1.80	± 13.1 %
5800	35.3	5.27	4.68	4.68	4.68	0.40	1.80	± 13.1 %

^c Frequency validity above 300 MHz of ± 100 MHz only applies for DASY v4.4 and higher (see Page 2), else it is restricted to ± 50 MHz. The uncertainty is the RSS of the ConvF uncertainty at calibration frequency and the uncertainty for the indicated frequency band. Frequency validity below 300 MHz is ± 10, 25, 40, 50 and 70 MHz for ConvF assessments at 30, 64, 128, 150 and 220 MHz respectively. Above 5 GHz frequency validity can be extended to ± 110 MHz.

^f At frequencies below 3 GHz, the validity of tissue parameters (ϵ and σ) can be relaxed to ± 10% if liquid compensation formula is applied to measured SAR values. At frequencies above 3 GHz, the validity of tissue parameters (ϵ and σ) is restricted to ± 5%. The uncertainty is the RSS of the ConvF uncertainty for indicated target tissue parameters.

^g Alpha/Depth are determined during calibration. SPEAG warrants that the remaining deviation due to the boundary effect after compensation is always less than ± 1% for frequencies below 3 GHz and below ± 2% for frequencies between 3-6 GHz at any distance larger than half the probe tip diameter from the boundary.

EX3DV4- SN:3832

February 21, 2018

DASY/EASY - Parameters of Probe: EX3DV4 - SN:3832

Calibration Parameter Determined in Body Tissue Simulating Media

f (MHz) ^c	Relative Permittivity ^f	Conductivity (S/m) ^f	ConvF X	ConvF Y	ConvF Z	Alpha ^g	Depth ^g (mm)	Unc (k=2)
150	61.9	0.80	11.02	11.02	11.02	0.00	1.00	± 13.3 %
300	58.2	0.92	10.69	10.69	10.69	0.05	1.20	± 13.3 %
450	56.7	0.94	10.56	10.56	10.56	0.09	1.30	± 13.3 %
750	55.5	0.96	9.38	9.38	9.38	0.35	1.02	± 12.0 %
835	55.2	0.97	9.15	9.15	9.15	0.46	0.80	± 12.0 %
1750	53.4	1.49	7.78	7.78	7.78	0.39	0.80	± 12.0 %
1950	53.3	1.52	7.72	7.72	7.72	0.45	0.80	± 12.0 %
2450	52.7	1.95	7.28	7.28	7.28	0.33	0.80	± 12.0 %
5200	49.0	5.30	5.02	5.02	5.02	0.35	1.90	± 13.1 %
5300	48.9	5.42	4.86	4.86	4.86	0.35	1.90	± 13.1 %
5500	48.6	5.65	4.34	4.34	4.34	0.40	1.90	± 13.1 %
5600	48.5	5.77	4.21	4.21	4.21	0.40	1.90	± 13.1 %
5800	48.2	6.00	4.33	4.33	4.33	0.40	1.90	± 13.1 %

^c Frequency validity above 300 MHz of ± 100 MHz only applies for DASY v4.4 and higher (see Page 2), else it is restricted to ± 50 MHz. The uncertainty is the RSS of the ConvF uncertainty at calibration frequency and the uncertainty for the indicated frequency band. Frequency validity below 300 MHz is ± 10, 25, 40, 50 and 70 MHz for ConvF assessments at 30, 64, 128, 150 and 220 MHz respectively. Above 5 GHz frequency validity can be extended to ± 110 MHz.

^f At frequencies below 3 GHz, the validity of tissue parameters (ϵ and σ) can be relaxed to ± 10% if liquid compensation formula is applied to measured SAR values. At frequencies above 3 GHz, the validity of tissue parameters (ϵ and σ) is restricted to ± 5%. The uncertainty is the RSS of the ConvF uncertainty for indicated target tissue parameters.

^g Alpha/Depth are determined during calibration. SPEAG warrants that the remaining deviation due to the boundary effect after compensation is always less than ± 1% for frequencies below 3 GHz and below ± 2% for frequencies between 3-6 GHz at any distance larger than half the probe tip diameter from the boundary.

EX3DV4- SN:3832

February 21, 2018

Frequency Response of E-Field (TEM-Cell:ifi110 EXX, Waveguide: R22)

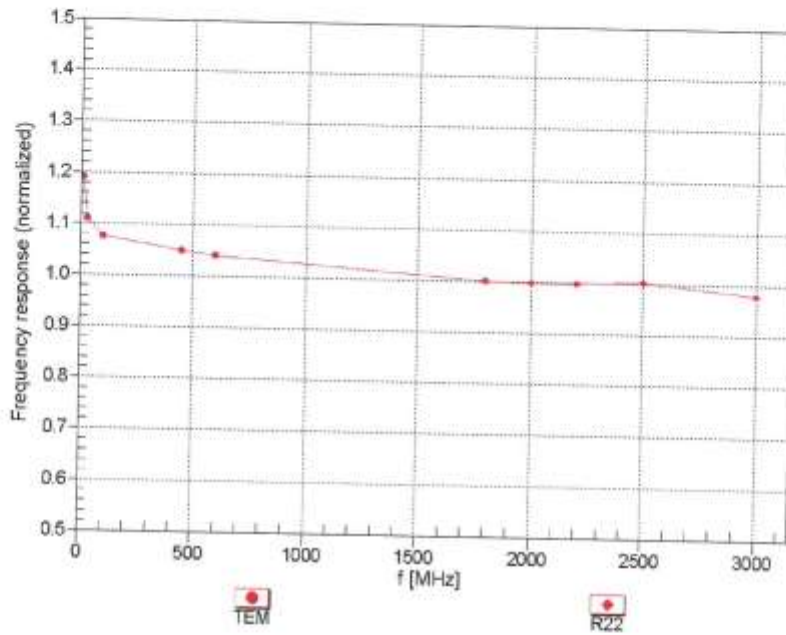

Uncertainty of Frequency Response of E-field: $\pm 6.3\%$ (k=2)

EX3DV4- SN:3832

February 21, 2018

Receiving Pattern (ϕ), $\theta = 0^\circ$

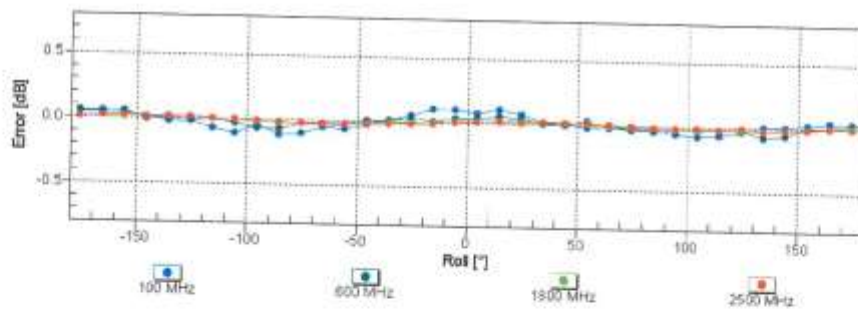
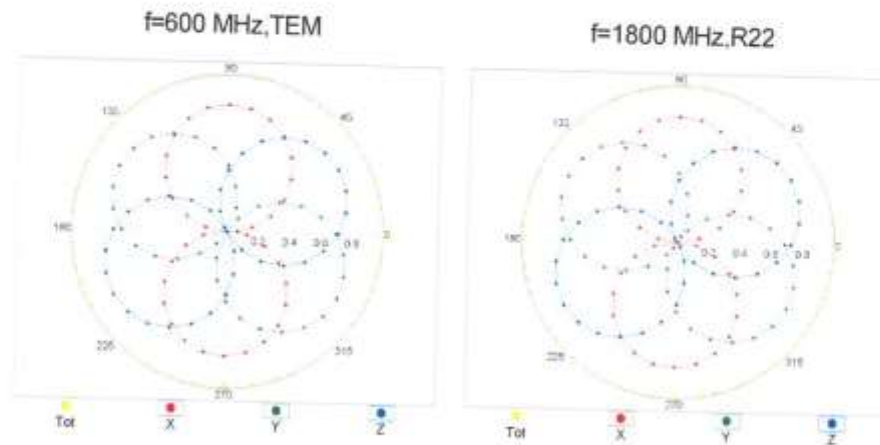

Uncertainty of Axial Isotropy Assessment: $\pm 0.5\%$ ($k=2$)

EX3DV4- SN:3832

February 21, 2018

Dynamic Range f(SAR_{head}) (TEM cell, f_{eval} = 1900 MHz)

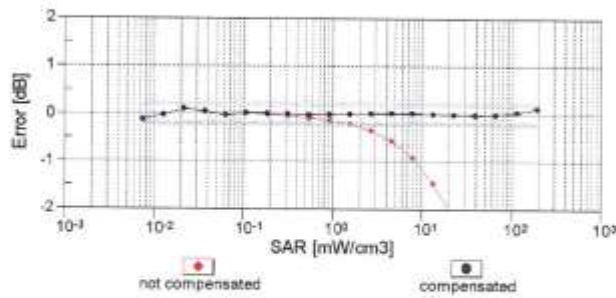
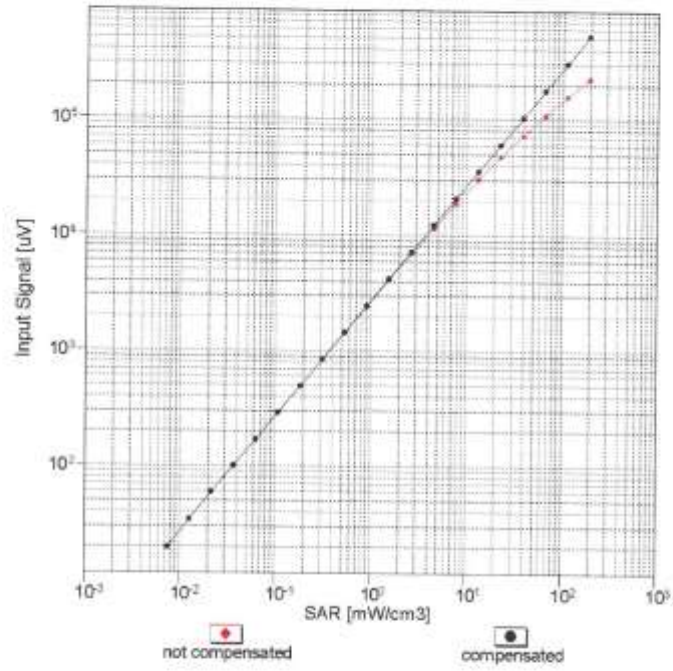

Uncertainty of Linearity Assessment: ± 0.6% (k=2)

EX30V4- SN:3832

February 21, 2018

Conversion Factor Assessment

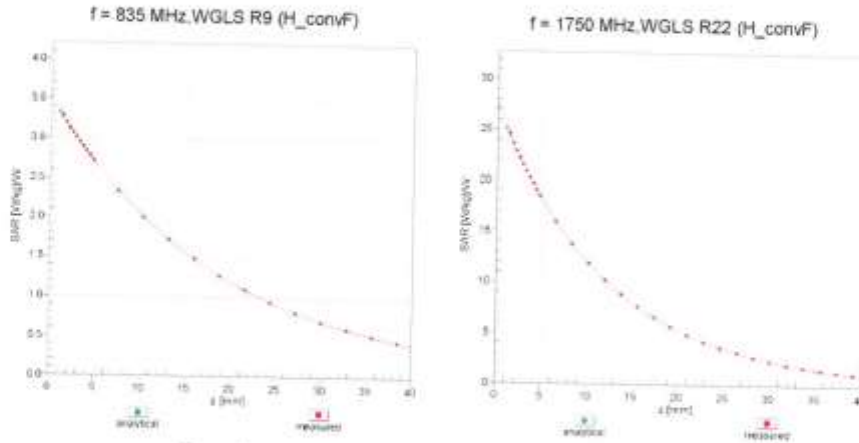

Deviation from Isotropy in Liquid Error (ϕ, θ), $f = 900 \text{ MHz}$

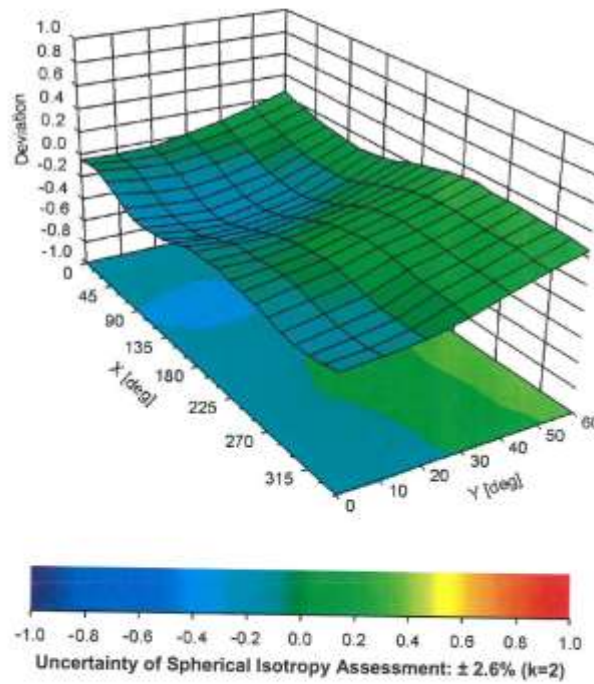

EX3DV4- SN:3832

February 21, 2018

DASY/EASY - Parameters of Probe: EX3DV4 - SN:3832

Other Probe Parameters

Sensor Arrangement	Triangular
Connector Angle (°)	54.2
Mechanical Surface Detection Mode	enabled
Optical Surface Detection Mode	disabled
Probe Overall Length	337 mm
Probe Body Diameter	10 mm
Tip Length	9 mm
Tip Diameter	2.5 mm
Probe Tip to Sensor X Calibration Point	1 mm
Probe Tip to Sensor Y Calibration Point	1 mm
Probe Tip to Sensor Z Calibration Point	1 mm
Recommended Measurement Distance from Surface	1.4 mm

< Dipole Antenna : D2450V2 – SN 923 >

**Calibration Laboratory of
Schmid & Partner
Engineering AG**
Zeughausstrasse 43, 8004 Zurich, Switzerland



S Schweizerischer Kalibrierdienst
C Service suisse d'étalonnage
S Servizio svizzero di taratura
S Swiss Calibration Service

Accredited by the Swiss Accreditation Service (SAS)
The Swiss Accreditation Service is one of the signatories to the EA
Multilateral Agreement for the recognition of calibration certificates

Accreditation No.: **SCS 0108**

Client **Onetech (Dymstec)**

Certificate No: **D2450V2-923_Nov17**

CALIBRATION CERTIFICATE			
Object	D2450V2 - SN:923		
Calibration procedure(s)	QA CAL-05.v9 Calibration procedure for dipole validation kits above 700 MHz		
Calibration date:	November 21, 2017		
<p>This calibration certificate documents the traceability to national standards, which realize the physical units of measurements (SI). The measurements and the uncertainties with confidence probability are given on the following pages and are part of the certificate.</p> <p>All calibrations have been conducted in the closed laboratory facility: environment temperature (22 ± 3)°C and humidity < 70%.</p> <p>Calibration Equipment used (M&TE critical for calibration)</p>			
Primary Standards	ID #	Cal Date (Certificate No.)	Scheduled Calibration
Power meter NRP	SN: 104778	04-Apr-17 (No. 217-02521/02522)	Apr-18
Power sensor NRP-Z91	SN: 103244	04-Apr-17 (No. 217-02521)	Apr-18
Power sensor NRP-Z91	SN: 103245	04-Apr-17 (No. 217-02522)	Apr-18
Reference 20 dB Attenuator	SN: 5058 (20k)	07-Apr-17 (No. 217-02528)	Apr-18
Type-N mismatch combination	SN: 5047.2 / 06327	07-Apr-17 (No. 217-02529)	Apr-18
Reference Probe EX3DV4	SN: 7349	31-May-17 (No. EX3-7349_May17)	May-18
DAE4	SN: 601	26-Oct-17 (No. DAE4-601_Oct17)	Oct-18
Secondary Standards	ID #	Check Date (in house)	Scheduled Check
Power meter EPM-442A	SN: GB37480704	07-Oct-15 (in house check Oct-16)	In house check: Oct-18
Power sensor HP 8481A	SN: US37292783	07-Oct-15 (in house check Oct-16)	In house check: Oct-18
Power sensor HP 8481A	SN: MY41092317	07-Oct-15 (in house check Oct-16)	In house check: Oct-18
RF generator R&S SMT-06	SN: 100972	15-Jun-15 (in house check Oct-16)	In house check: Oct-18
Network Analyzer HP 8753E	SN: US37390585	18-Oct-01 (in house check Oct-17)	In house check: Oct-18
Calibrated by:	Name Michael Weber	Function Laboratory Technician	Signature
Approved by:	Name Katja Pokovic	Function Technical Manager	Signature
This calibration certificate shall not be reproduced except in full without written approval of the laboratory.			Issued: November 21, 2017

**Calibration Laboratory of
Schmid & Partner
Engineering AG**
Zeughausstrasse 43, 8004 Zurich, Switzerland



S Schweizerischer Kalibrierdienst
C Service suisse d'étalonnage
S Servizio svizzero di taratura
S Swiss Calibration Service

Accredited by the Swiss Accreditation Service (SAS)
The Swiss Accreditation Service is one of the signatories to the EA
Multilateral Agreement for the recognition of calibration certificates

Accreditation No.: **SCS 0108**

Glossary:

TSL tissue simulating liquid
ConvF sensitivity in TSL / NORM x,y,z
N/A not applicable or not measured

Calibration is Performed According to the Following Standards:

- a) IEEE Std 1528-2013, "IEEE Recommended Practice for Determining the Peak Spatial-Averaged Specific Absorption Rate (SAR) in the Human Head from Wireless Communications Devices: Measurement Techniques", June 2013
- b) IEC 62209-1, "Measurement procedure for the assessment of Specific Absorption Rate (SAR) from hand-held and body-mounted devices used next to the ear (frequency range of 300 MHz to 6 GHz)", July 2016
- c) IEC 62209-2, "Procedure to determine the Specific Absorption Rate (SAR) for wireless communication devices used in close proximity to the human body (frequency range of 30 MHz to 6 GHz)", March 2010
- d) KDB 865664, "SAR Measurement Requirements for 100 MHz to 6 GHz"

Additional Documentation:

- e) DASY4/5 System Handbook

Methods Applied and Interpretation of Parameters:

- *Measurement Conditions:* Further details are available from the Validation Report at the end of the certificate. All figures stated in the certificate are valid at the frequency indicated.
- *Antenna Parameters with TSL:* The dipole is mounted with the spacer to position its feed point exactly below the center marking of the flat phantom section, with the arms oriented parallel to the body axis.
- *Feed Point Impedance and Return Loss:* These parameters are measured with the dipole positioned under the liquid filled phantom. The impedance stated is transformed from the measurement at the SMA connector to the feed point. The Return Loss ensures low reflected power. No uncertainty required.
- *Electrical Delay:* One-way delay between the SMA connector and the antenna feed point. No uncertainty required.
- *SAR measured:* SAR measured at the stated antenna input power.
- *SAR normalized:* SAR as measured, normalized to an input power of 1 W at the antenna connector.
- *SAR for nominal TSL parameters:* The measured TSL parameters are used to calculate the nominal SAR result.

The reported uncertainty of measurement is stated as the standard uncertainty of measurement multiplied by the coverage factor $k=2$, which for a normal distribution corresponds to a coverage probability of approximately 95%.

Measurement Conditions

DASY system configuration, as far as not given on page 1.

DASY Version	DASY5	V52.10.0
Extrapolation	Advanced Extrapolation	
Phantom	Modular Flat Phantom	
Distance Dipole Center - TSL	10 mm	with Spacer
Zoom Scan Resolution	dx, dy, dz = 5 mm	
Frequency	2450 MHz ± 1 MHz	

Head TSL parameters

The following parameters and calculations were applied.

	Temperature	Permittivity	Conductivity
Nominal Head TSL parameters	22.0 °C	39.2	1.80 mho/m
Measured Head TSL parameters	(22.0 ± 0.2) °C	37.8 ± 6 %	1.86 mho/m ± 6 %
Head TSL temperature change during test	< 0.5 °C	---	----

SAR result with Head TSL

SAR averaged over 1 cm³ (1 g) of Head TSL	Condition	
SAR measured	250 mW input power	13.3 W/kg
SAR for nominal Head TSL parameters	normalized to 1W	51.9 W/kg ± 17.0 % (k=2)

SAR averaged over 10 cm³ (10 g) of Head TSL	condition	
SAR measured	250 mW input power	6.16 W/kg
SAR for nominal Head TSL parameters	normalized to 1W	24.3 W/kg ± 16.5 % (k=2)

Body TSL parameters

The following parameters and calculations were applied.

	Temperature	Permittivity	Conductivity
Nominal Body TSL parameters	22.0 °C	52.7	1.95 mho/m
Measured Body TSL parameters	(22.0 ± 0.2) °C	51.5 ± 6 %	2.02 mho/m ± 6 %
Body TSL temperature change during test	< 0.5 °C	----	----

SAR result with Body TSL

SAR averaged over 1 cm³ (1 g) of Body TSL	Condition	
SAR measured	250 mW input power	13.1 W/kg
SAR for nominal Body TSL parameters	normalized to 1W	51.3 W/kg ± 17.0 % (k=2)

SAR averaged over 10 cm³ (10 g) of Body TSL	condition	
SAR measured	250 mW input power	6.08 W/kg
SAR for nominal Body TSL parameters	normalized to 1W	24.0 W/kg ± 16.5 % (k=2)

Appendix (Additional assessments outside the scope of SCS 0108)

Antenna Parameters with Head TSL

Impedance, transformed to feed point	54.7 Ω + 1.4 j Ω
Return Loss	- 26.7 dB

Antenna Parameters with Body TSL

Impedance, transformed to feed point	50.2 Ω + 4.1 j Ω
Return Loss	- 27.7 dB

General Antenna Parameters and Design

Electrical Delay (one direction)	1.158 ns
----------------------------------	----------

After long term use with 100W radiated power, only a slight warming of the dipole near the feedpoint can be measured.

The dipole is made of standard semirigid coaxial cable. The center conductor of the feeding line is directly connected to the second arm of the dipole. The antenna is therefore short-circuited for DC-signals. On some of the dipoles, small end caps are added to the dipole arms in order to improve matching when loaded according to the position as explained in the "Measurement Conditions" paragraph. The SAR data are not affected by this change. The overall dipole length is still according to the Standard.

No excessive force must be applied to the dipole arms, because they might bend or the soldered connections near the feedpoint may be damaged.

Additional EUT Data

Manufactured by	SPEAG
Manufactured on	September 26, 2013

DASY5 Validation Report for Head TSL

Date: 21.11.2017

Test Laboratory: SPEAG, Zurich, Switzerland

DUT: Dipole 2450 MHz; Type: D2450V2; Serial: D2450V2 - SN: 923

Communication System: UID 0 - CW; Frequency: 2450 MHz

Medium parameters used: $f = 2450$ MHz; $\sigma = 1.86$ S/m; $\epsilon_r = 37.8$; $\rho = 1000$ kg/m³

Phantom section: Flat Section

Measurement Standard: DASY5 (IEEE/IEC/ANSI C63.19-2011)

DASY52 Configuration:

- Probe: EX3DV4 - SN7349; ConvF(8.12, 8.12, 8.12); Calibrated: 31.05.2017;
- Sensor-Surface: 1.4mm (Mechanical Surface Detection)
- Electronics: DAE4 Sn601; Calibrated: 26.10.2017
- Phantom: Flat Phantom 5.0 (front); Type: QD 000 P50 AA; Serial: 1001
- DASY52 52.10.0(1446); SEMCAD X 14.6.10(7417)

Dipole Calibration for Head Tissue/Pin=250 mW, d=10mm/Zoom Scan (7x7x7)/Cube 0:

Measurement grid: dx=5mm, dy=5mm, dz=5mm

Reference Value = 114.3 V/m; Power Drift = -0.04 dB

Peak SAR (extrapolated) = 27.0 W/kg

SAR(1 g) = 13.3 W/kg; SAR(10 g) = 6.16 W/kg

Maximum value of SAR (measured) = 22.0 W/kg

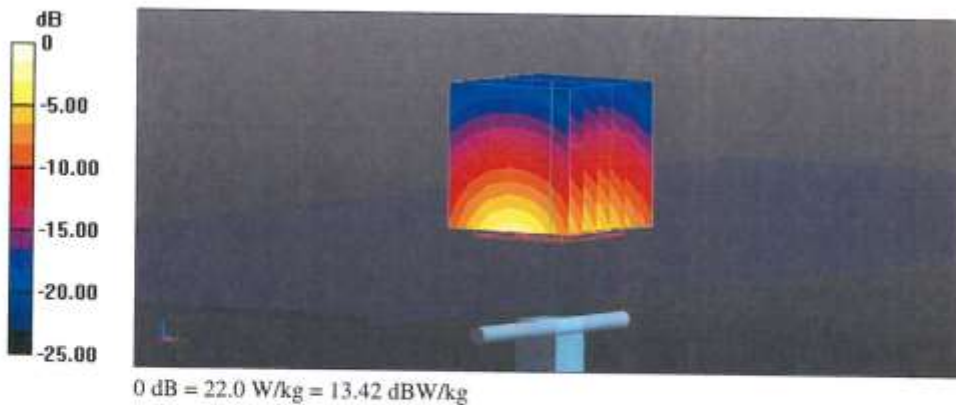

Impedance Measurement Plot for Head TSL

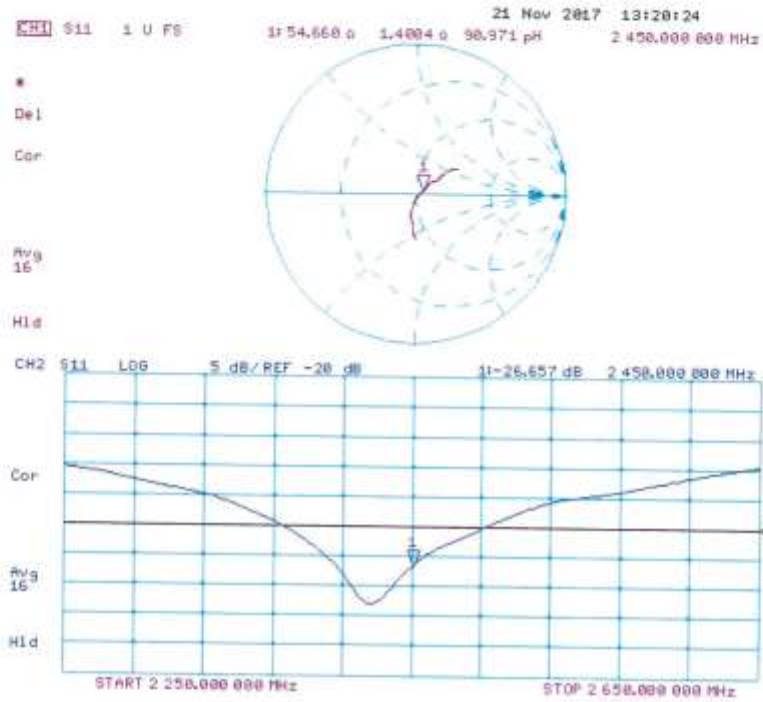

DASY5 Validation Report for Body TSL

Date: 21.11.2017

Test Laboratory: SPEAG, Zurich, Switzerland

DUT: Dipole 2450 MHz; Type: D2450V2; Serial: D2450V2 - SN: 923

Communication System: UID 0 - CW; Frequency: 2450 MHz
 Medium parameters used: $f = 2450$ MHz; $\sigma = 2.02$ S/m; $\epsilon_r = 51.5$; $\rho = 1000$ kg/m³
 Phantom section: Flat Section
 Measurement Standard: DASY5 (IEEE/IEC/ANSI C63.19-2011)

DASY52 Configuration:

- Probe: EX3DV4 - SN7349; ConvF(8.1, 8.1, 8.1); Calibrated: 31.05.2017;
- Sensor-Surface: 1.4mm (Mechanical Surface Detection)
- Electronics: DAE4 Sn601; Calibrated: 26.10.2017
- Phantom: Flat Phantom 5.0 (back); Type: QD 000 P50 AA; Serial: 1002
- DASY52 52.10.0(1446); SEMCAD X 14.6.10(7417)

Dipole Calibration for Body Tissue/Pin=250 mW, d=10mm/Zoom Scan (7x7x7)/Cube 0:

Measurement grid: dx=5mm, dy=5mm, dz=5mm
 Reference Value = 106.8 V/m; Power Drift = -0.05 dB
 Peak SAR (extrapolated) = 25.9 W/kg
SAR(1 g) = 13.1 W/kg; SAR(10 g) = 6.08 W/kg
 Maximum value of SAR (measured) = 20.7 W/kg

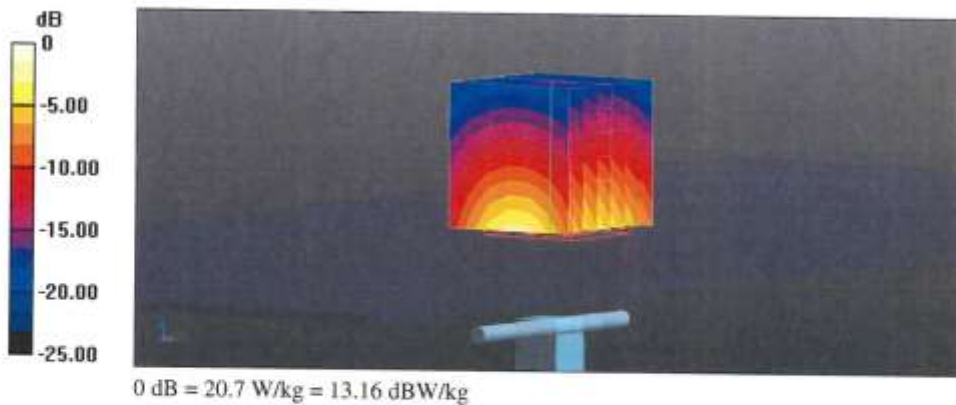

Impedance Measurement Plot for Body TSL

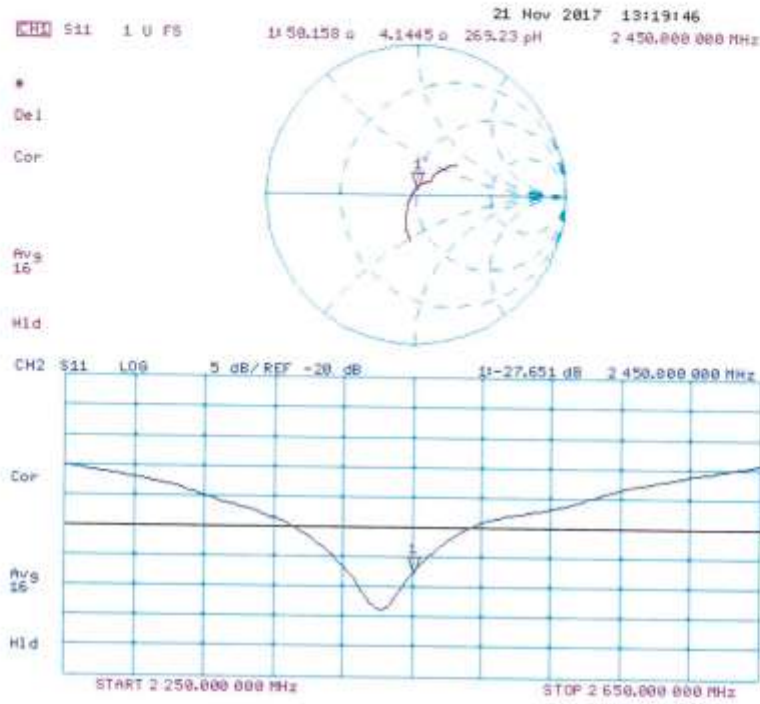

Return Loss for Head simulant tissue (measured on Nov 22, 2018)

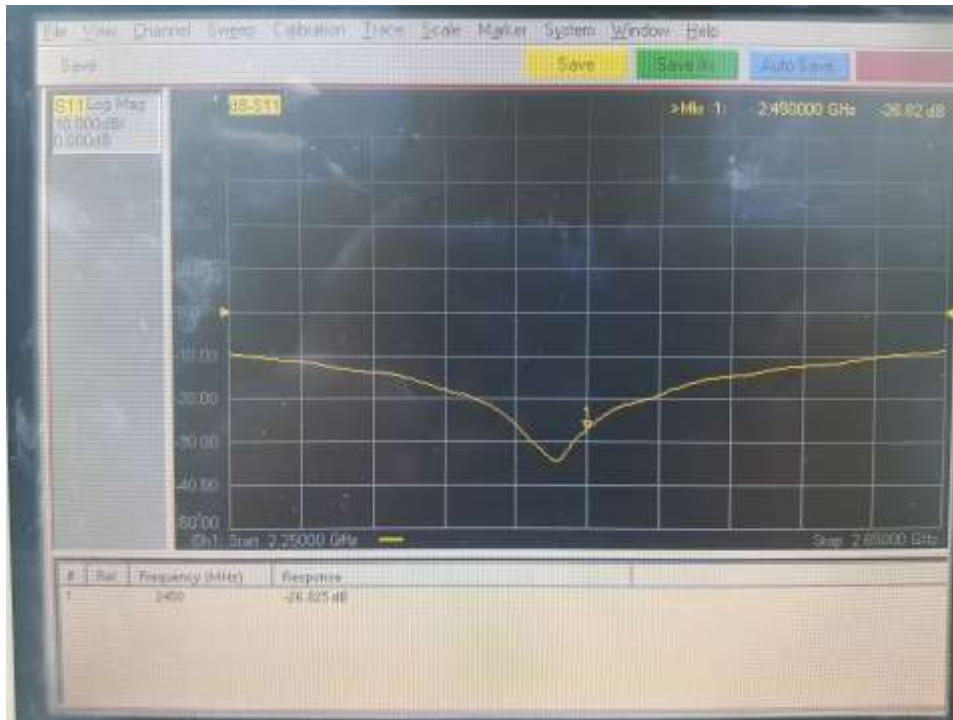

Return Loss for Body simulant tissue (measured on Nov 22, 2018)

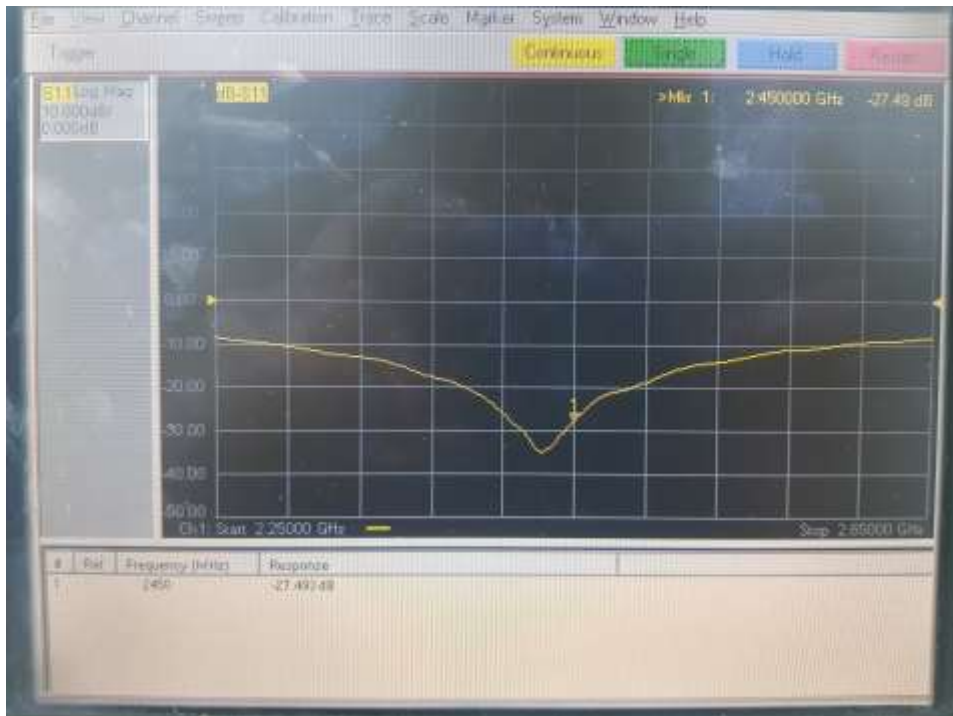

< Dielectric Probe : DAK-3.5 SN 1140 >

**Calibration Laboratory of
Schmid & Partner
Engineering AG**
Zeughausstrasse 43, 8004 Zurich, Switzerland



S Schweizerischer Kalibrierdienst
C Service suisse d'étalonnage
S Servizio svizzero di taratura
S Swiss Calibration Service

Accredited by the Swiss Accreditation Service (SAS)
The Swiss Accreditation Service is one of the signatories to the EA
Multilateral Agreement for the recognition of calibration certificates

Accreditation No.: **SCS 0108**

Client **Onetech (Dymstec)**

Certificate No: **OCP-DAK3.5-1140_Nov18**

CALIBRATION CERTIFICATE			
Object	DAK-3.5 - SN: 1140		
Calibration procedure(s)	QA CAL-33.v2 Calibration of dielectric parameter probes		
Calibration date	November 20, 2018		
This calibration certificate documents the traceability to national standards, which realize the physical units of measurements (SI). The measurements and the uncertainties with confidence probability are given on the following pages and are part of the certificate.			
All calibrations have been conducted in the closed laboratory facility: environment temperature (22 ± 3)°C and humidity < 70%.			
Calibration Equipment used (M&TE critical for calibration)			
Primary Standards	ID #	Cal Date (Certificate No)	Scheduled Calibration
OCP DAK-3.5 (weighted)	SN: 1249	09-Oct-18 (OCP-DAK3.5-1249_Oct18)	Oct-19
Secondary Standards	ID #	Check Date (in house)	Scheduled Check
Rohde & Schwarz ZVA67	T4383	16-Jan-18 (in house check Jun-18)	Jun-19
Digital Thermometer DTM3000	2148	18-May-18 (DTM-2148_May18)	May-19
Methanol 99.9% Type 34860	STBH4051	04-Apr-18 (bottle opened, check May-18)	May-19
Head Liquid, HBBL U16	180314-0	06-Apr-18 (in house check May-18)	May-19
0.1 mol/L NaCl solution Type 35275	SZBF3280V	25-Jan-18 (in house check May-18)	May-19
0.05 mol/L NaCl solution	180125-1	25-Jan-18 (in house check May-18)	May-19
Head Gel, SI, AGH U08 AB-B	150430	06-May-18 (in house check May-18)	May-19
Eccostock0005	1507101	01-Jul-15 (in house check May-18)	May-19
Calibrated by:	Name Claudio Leubler	Function Laboratory Technician	Signature
Approved by:	Name Katja Pokovic	Function Technical Manager	Signature
This calibration certificate shall not be reproduced except in full without written approval of the laboratory.			Issued: November 20, 2018

**Calibration Laboratory of
Schmid & Partner
Engineering AG**
Zeughausstrasse 43, 8004 Zurich, Switzerland



S Schweizerischer Kalibrierdienst
C Service suisse d'étalonnage
S Servizio svizzero di taratura
S Swiss Calibration Service

Accredited by the Swiss Accreditation Service (SAS)
The Swiss Accreditation Service is one of the signatories to the EA
Multilateral Agreement for the recognition of calibration certificates

Accreditation No.: **SCS 0108**

References

- [1] IEEE Std 1528-2013, "IEEE Recommended Practice for Determining the Peak Spatial-Averaged Specific Absorption Rate (SAR) in the Human Head from Wireless Communications Devices: Measurement Techniques", June 2013
- [2] IEC 62209-1, "Measurement procedure for the assessment of Specific Absorption Rate (SAR) from hand-held and body-mounted devices used next to the ear (frequency range of 300 MHz to 6 GHz)", July 2016
- [3] IEC 62209-2 Ed.1, "Human Exposure to Radio Frequency Fields from Handheld and Body-Mounted Wireless Communication Devices – Human models, Instrumentation, and Procedures Part 2: Procedure to determine the specific absorption rate (SAR) for mobile wireless communication devices used in close proximity to the human body (frequency range of 30 MHz to 8 GHz)", March 2010
- [4] A. P. Gregory and R. N. Clarke, "NPL Report MAT 23", January 2012
Tables of the Complex Permittivity of Dielectric Reference Liquids at Frequencies up to 5 GHz
- [5] DAK Professional Handbook, SPEAG, September 2018
- [6] A. Toropainen et al, "Method for accurate measurement of complex permittivity of tissue equivalent liquids", Electronics Letters 36 (1) 2000 pp32-34
- [7] J. Hilland, "Simple sensor system for measuring the dielectric properties of saline solutions", Meas. Sci. Technol. 8 pp901–910 (1997)
- [8] K. Nörtemann, J. Hilland and U. Kaatze, "Dielectric Properties of Aqueous NaCl Solutions at Microwave Frequencies", J. Phys. Chem. A 101 pp6864-6869 (1997)
- [9] R. Buchner, G. T. Hefter and Peter M. May, "Dielectric Relaxation of Aqueous NaCl Solutions", J. Phys. Chem. A 103 (1) (1999)

Description of the dielectric probe

Dielectric probes are used to measure the dielectric parameters of tissue simulating media in a wide frequency range. The complex permittivity $\epsilon_c = (\epsilon'/\epsilon_0) - j(\epsilon''/\epsilon_0)$ is determined from the S parameters measured with a vector network analyzer (VNA) with software specific to the probe type. The parameters of interest e.g. in standards [1, 2, 3] and for other applications are presented are calculated as follows:

(Relative) permittivity ϵ' (real part of $\epsilon_c = (\epsilon'/\epsilon_0) - j(\epsilon''/\epsilon_0)$ where $\epsilon_0 = 8.854 \text{ pF/m}$ is the permittivity in free space)

Conductivity $\sigma = 2 \pi f \epsilon'' \epsilon_0$,

Loss Tangent = (ϵ''/ϵ')

The **OCP** (open ended coaxial) is a cut off section of 50 Ohm transmission line, similar to the system described in [1, 2, 3, 5], used for contact measurement. The material is measured either by touching the probe to the surface of a solid/gelly or by immersing it into a liquid media. The electromagnetic fields at the probe end fringe into the material to be measured, and its parameters are determined from the change of the S_{11} parameters. With larger diameter of the dielectrics, the probe can be used down to lower frequencies.

The flange surrounding the active area shapes the near field similar to a semi-infinite geometry and is inserted fully into the measured lossy liquid.

The probe is connected with a phase and amplitude stable cable to a VNA which is then calibrated with Open, Short and a Liquid with well-known parameters. All parts in the setup influencing the amplitude and phase of the signal are important and shall remain stable.

Handling of the item

Before usage, the active probe area has to be cleaned from any material residuals potentially contaminating the reference standards. The metal and dielectric surface must be protected to keep the precision of the critical mechanical dimensions. The connector and cable quality are critical; any movements between calibration and measurement shall be avoided. The temperature must be stable and must not differ from the material temperature.

Methods Applied and Interpretation of Parameters

The calibration of the dielectric probe system is done in the steps described below for the desired frequency range and calibration package (SAR/MRI liquids, Semi-solid/solid material). Because the standard calibration in step 3 is critical for the results in steps 4 to 8, the sequence 3 to 8 is repeated 3 times. As a result, the result from these 3 sets is represented.

1. Configuration and mechanical / optical status.
2. Measurement resolution is 5 MHz from 10 to 300 MHz, 50 MHz from 300 to 6000 MHz and 250 MHz from 6 to 20 GHz.
3. Standard calibration uses Air / Short / Liquid. 1 liter liquid quantity is used to reduce the influence the reflections. The liquid type is selected depending on the lowest frequency and probe diameter.
 DAK-1.2, DAK-3.5, Agilent OCP: de-ionized water (approx. 22 °C)
 DAK-12: saline solution with static conductivity 1 S/m (approx. 22 °C)
 NPL OCP: pure ethanol (approx. 22 °C)
4. The cable used in the setup stays in a fixed position, i.e. the probe is fixed and measuring from the top in an angle of typ. 20° from the vertical axis. For DAK and Agilent probes, the refresh function (air standard) is used previous to the individual measurements in order to compensate for possible deviations from cable movements. After insertion of the probe into a liquid, the possible air bubbles are removed from the active surface.
5. Measurement of multiple shorts if not already available from the calibration in the previous step (NPL). Evaluation of the deviation from the previous calibration short with graphical representation of the complex quantities and magnitude over the frequency range. Probe specific short is used. This assessment shows ability to define a short circuit at the end of the probe for the VNA calibration in the setup which is essential at high frequencies and depends on the probe surface quality.
6. Measurement of validation liquids in a quantity of 1 liter at well defined temperature. Evaluation of the deviations from the target. The targets base on traceable data from reference sources. The deviation of the measurement is graphically presented for permittivity and conductivity (for lossy liquids) or loss tangent (for low losses at low frequencies).
7. Measurement of lossy liquids in a quantity of 1 liter at well defined temperature. Head tissue simulating liquid or saline solution with 0.5 S/m static conductivity are representative. The target data base on traceable data from reference sources or from multiple measurements with precision reference probes or different evaluations such as transmission line or slotted line methods. Evaluation of the deviation from the target and graphical representation for permittivity and conductivity over the frequency range.
8. Semi-solid / solid material calibration:
 Measurements of an elastic lossy broadband semi-solid gel with parameters close to the head tissue target. Measurements of a planar very low loss solid microwave-substrate. The average of 4 measurements of the same sample at different location is shown as a single result. The deviation of the permittivity and conductivity from the reference data is evaluated.
 Measurements of a planar very low loss solid microwave-substrate. The average of 4 measurements of the same sample at different location is shown as a single result. The relative deviation of the permittivity and the absolute deviation of the loss tangent is evaluated.
 The targets base on multiple measurements (on the same material batch at identical temperature) on convex and planar surfaces with precision reference OCP.

- The measurement on semi-solid / solid materials is sensitive to the quality and planarity of the probe contact area, such as air gaps due to imperfect probes (resulting lower permittivity values).
9. Table for the probe uncertainty: The uncertainty of the probe depending on probe type, size, material parameter range and frequency is given in a table. It represents the best measurement capability of the specific probe but does not include the material (deviation from the target values).
 10. Appendix with detailed results of all measurements with the uncertainties for the specific measurement. In addition to the probe uncertainty (see above), it includes the uncertainty of the reference material used for the measurement. A set of results from independent calibrations represents the capability of the setup and the lossy materials used, including the precision of the measured material and the influence of temperature deviations. Temperature and operator influence was minimized and gives a good indication of the achievable repeatability of a measurement.
 11. Summary assessment of the measured deviations and detailed comments if not typical for the probe type.

Dielectric probe identification and configuration data

Item description

Probe type	OCP Open-ended coaxial probe
Probe name	SPEAG Dielectric Assessment Kit DAK-3.5
Type No	SM DAK 040 CA
Serial No	1140
Description	Open-ended coaxial probe with flange Flange diameter: 19.0 mm Dielectric diameter: 3.5 mm Material: stainless steel
Connector 1	PC 3.5 pos.
Software version	DAK Measurement Solver 2.4.1.144 Calibration Type: Air / short / water (set to measured water temp.) Probe type: "DAK3.5" (software setting)
Further settings	VNA bandwidth setting: 50 Hz

SCS 0108 Accessories used for customer probe calibration

Cable	Huber & Suhner Sucoflex 404, SN: 4361, length 1 m, PC3.5 neg. – PC3.5 neg.
Short	DAK-3.5 shorting block, type SM DAK 200 BA Contact area covered with cleaned Cu stripe

Additional items used during measurements

Adapter 1	PC3.5 pos. – PC1.85 (VNA side)
Adapter 2	PC3.5 pos. – PC3.5 neg. (probe side)

Notes

- Before the calibration, the connectors of the probe and cable were inspected and cleaned.
- Probe visual inspection: according to requirements
- Short inspection: according to the requirements

Probe Uncertainty

The following tables provide material and frequency specific uncertainties (k=2) for the dielectric probe. The values in the tables represent the measurement capability for the probe when measuring a material in the indicated parameter range. They include all uncertainties of

- probe system
- possible systematic errors due to the design
- calibration
- temperature differences during the calibration and measurements, as described,
- VNA noise

Apart from the material used for the calibration (de-ionized water), material uncertainties of the reference materials used during the measurement in Appendix A are not included in these tables.

DAK-3.5				
Permittivity range		Frequency range	(sigma / LT range)	Unc. (k=2)
1 – 15		10 MHz - 20 MHz		---
		20 MHz - 200 MHz		---
		200 MHz - 3 GHz	LT < 0.1	2.0%
		3 GHz - 6 GHz	LT < 0.1	2.0%
		6 GHz - 20 GHz	LT < 0.1	2.1%
10 – 40		10 MHz - 20 MHz		---
		20 MHz - 200 MHz		---
		200 MHz - 3 GHz	sigma : 1 – 10 S/m	1.8%
		3 GHz - 6 GHz	sigma : 1 – 10 S/m	2.3%
		6 GHz - 20 GHz	sigma > 10 S/m	3.4%
35 – 100		10 MHz - 20 MHz		---
		20 MHz - 200 MHz		---
		200 MHz - 3 GHz	sigma : 1 – 10 S/m	1.7%
		3 GHz - 6 GHz	sigma : 1 – 10 S/m	1.9%
		6 GHz - 20 GHz	sigma > 10 S/m	2.4%
Conductivity range (S/m)				
		Frequency range	(epsilon / LT range)	Unc. (k=2)
1 – 10		10 MHz - 20 MHz		---
		20 MHz - 200 MHz		---
		200 MHz - 3 GHz	eps : 35 - 100	2.7%
		3 GHz - 6 GHz	eps : 35 - 100	3.0%
		6 GHz - 20 GHz	eps : 10 - 40	3.0%
Loss tangent range				
		Frequency range	(epsilon / LT range)	Unc. (k=2)
< 0.1		10 MHz - 20 MHz		---
		20 MHz - 200 MHz		---
		200 MHz - 3 GHz	eps : 1 - 15	0.03
		3 GHz - 6 GHz	eps : 1 - 15	0.03
		6 GHz - 20 GHz	eps : 1 - 15	0.03

Calibration Results

Uncertainty limits ($k=2$) for the material measurements in the figures of Appendix A are represented with red dashed lines. These uncertainties contain - in addition to probe uncertainty - the uncertainty of the material target parameter determination.

The measurements show the results obtained from independent calibrations for the same material. The differences between the individual measurement curves give therefore an indication for the obtainable repeatability and shall lie within the uncertainties stated in the tables.

Materials for DAK-3.5 calibration:

Appendix A with curves for Methanol, HBBL, and 0.05 mol/L NaCl solution (200 MHz - 6 GHz, optional 20 GHz), HS gel and low loss solid substrate are optional.

Appendix A: Detailed Results (additional assessments outside the scope of SCS0108)

A.1 Probe appearance and calibration sequence

A.1.1 Appearance

The OCP appearance is fully according to the expectations;

- the flange surface is intact

A.1.2 Calibration sequence

The following sequence was repeated 3 times in the low frequency range from 200 – 300 MHz in 5 MHz steps and in the high frequency range from 300 to 6000 MHz in 50 MHz steps, and from 6 GHz to 20 GHz in 250 MHz steps.

- Air
- Short 1 short, then immediate verification with a second short (with eventual repetition)
- Water De-ionized water, temperature measured and set in the software (for DAK-12 0.1 mol/L saline solution, temperature measured and set in the software)
- Methanol Pure methanol, temperature measured and set in the software
- Liquids Measurement of further liquids (e.g. Head tissue simulating liquid and 0.05 mol/l saline)
- Cleaning Probe washed with water and isopropanol at the end of the sequence.
- Shorts 4 additional separate short measurements to determine the deviation from the original
- Refresh Refresh with Air
- Solid 4 separate solid low loss planar substrate measurements to determine one average (optional)
- Semisolid 4 separate head gel measurements on fresh intact surface to determine one average (optional)
- Cleaning Probe washed with water and isopropanol at the end of the sequence

Evaluation of the additional shorts from the calibrated (ideal) short point at the left edge of the Smith Chart, represented as magnitude over the frequency range (fig. 2.1.x) and in polar representation (fig. 2.2.x).

Evaluation of the Liquid measurements and representation of the permittivity and conductivity deviation from their reference data at the measurement temperature. The results of each of the 3 calibrations is shown in the appendix for each material (fig. 3ff) in black, red, blue. The red dashed line shows the uncertainty of the reference material parameter determination.

Evaluation of the Semisolid measurements (optional) by representing the 3 average deviations (each resulting from the 4 separate measurements per set), equivalent to the liquid measurement. Representation of the permittivity and conductivity deviation from their reference data at the nominal temperature.

Evaluation of the Solid measurements (optional) by representing the 3 average deviations (each resulting from the 4 separate measurements per set), equivalent to the liquid measurement. Representation of the permittivity deviation from their reference data and the loss tangent at the nominal temperature.

A.2 Short residual magnitudes

After each of the 3 calibrations with a single short (as per the DAK software), 4 additional separate, short measurements were performed after the liquid measurements and evaluated from the S11 data. The residuals in the graphs represent the deviation from the ideal short point on the polar representation on the VNA screen.

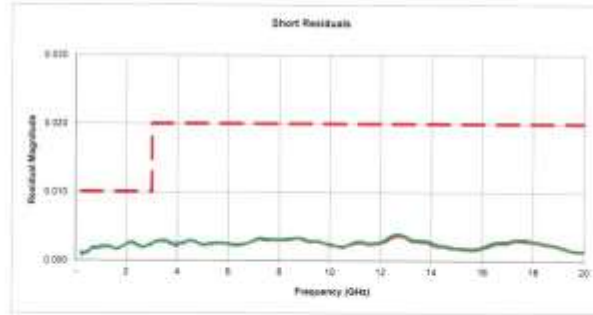

Fig. 2.1a Magnitude of the residual of the shorts, 200 MHz – 20 GHz, after calibration a)

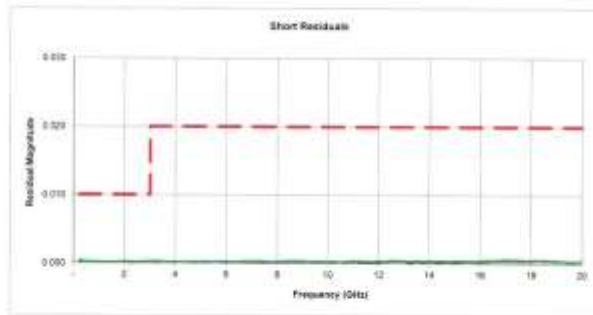

Fig. 2.1b Magnitude of the residual of the shorts, 200 MHz – 20 GHz, after calibration b)

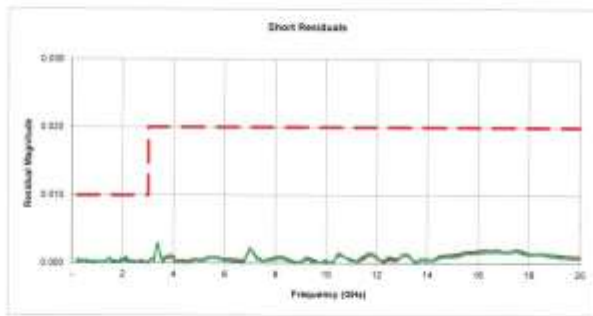

Fig. 2.1c Magnitude of the residual of the shorts, 200 MHz – 20 GHz, after calibration c)

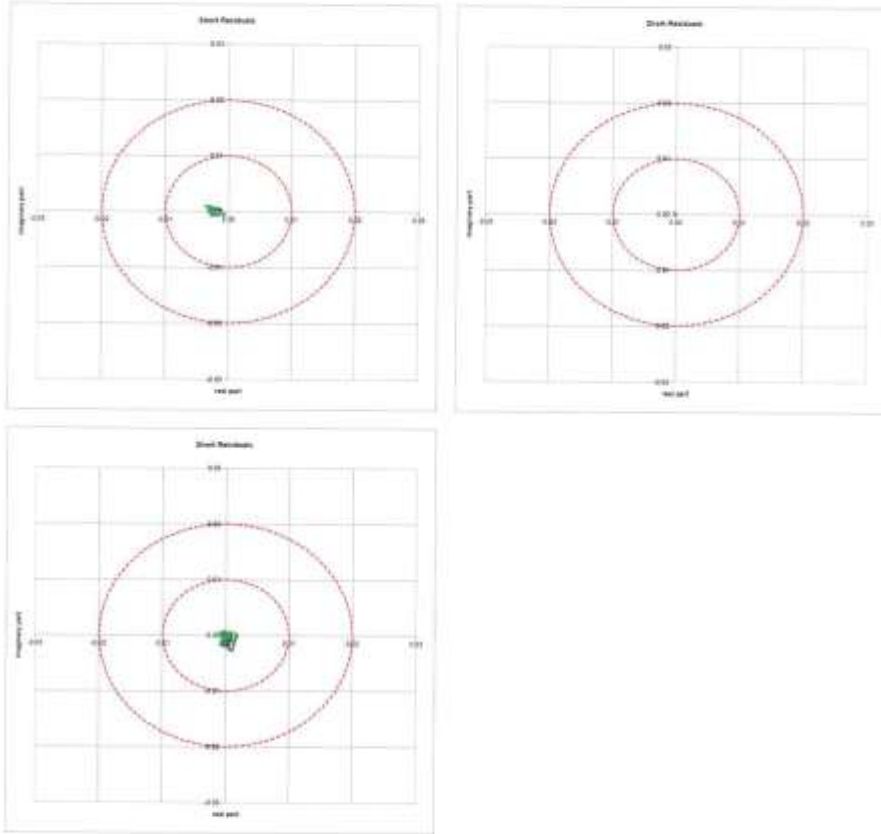

Fig. 2.2a-c Complex representation of the residuals of the shorts, 200 MHz - 20 GHz, after calibrations a)-b) in the top and c) in the bottom

All shorts have good quality. Some minor deviations might be visible from contact quality (left - right).

A.3 Methanol

Methanol (99.9% pure) was measured at a temperature of 22 +/- 2 °C. The liquid temperature was stabilized within 0.05 °C of the desired temperature. Deviations are presented relative to the nominal material parameters at this temperature, calculated from NPL data for this temperature. For the measurements the Noise Filter was activated in the software.

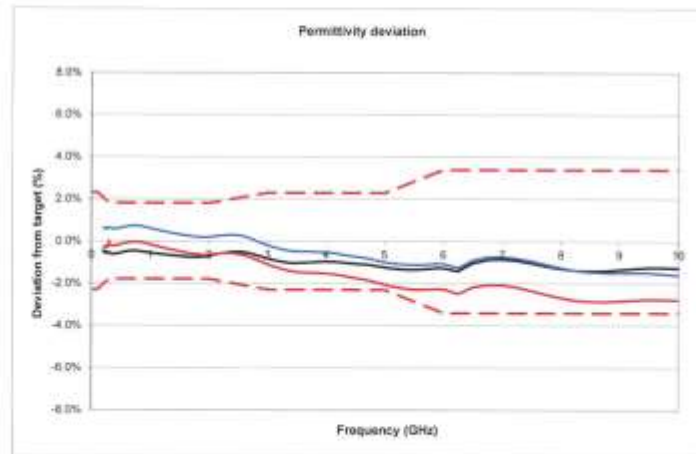

Fig. 3.1 Methanol permittivity deviation from target, 200 MHz – 10 GHz

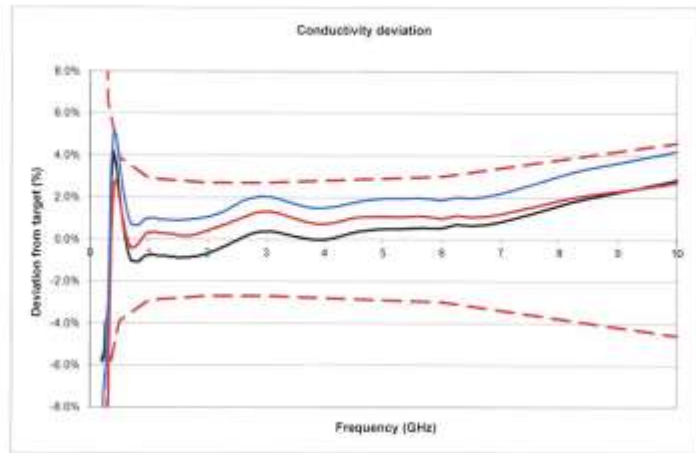

Fig. 3.2 Methanol conductivity deviation from target, 200 MHz – 10 GHz

Note: Conductivity error can be high at low frequencies due to the low absolute conductivity values.

A.4 Head Tissue

Broadband head simulating liquid was measured at a temperature of 22 +/- 2 °C. The liquid temperature was stabilized within 0.05 °C of the desired temperature. Deviations are presented relative to the reference data for this material. Those parameters have been evaluated from multiple measurements on the used bath with precision reference OCP and further methods. For the measurements the Noise Filter was activated in the software.

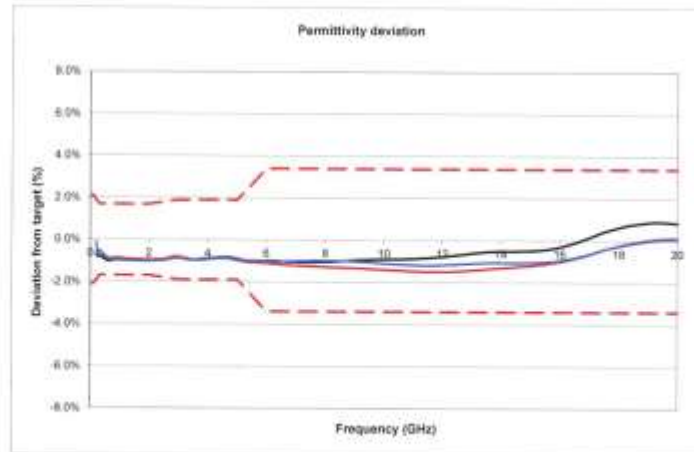

Fig. 4.1 HBBL permittivity deviation from target, 200 MHz – 20 GHz

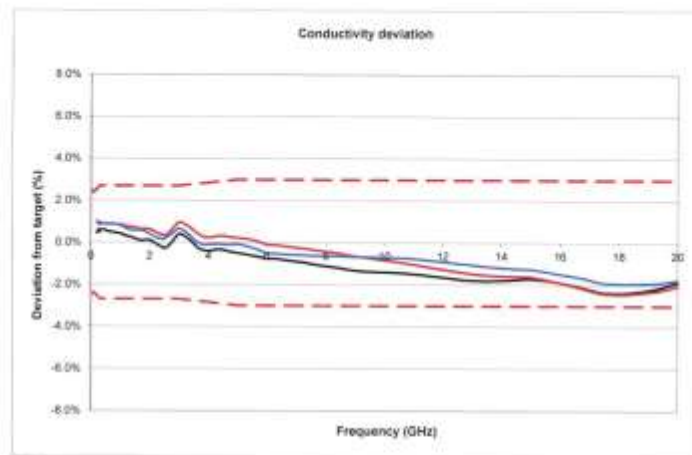

Fig. 4.2 HBBL conductivity deviation from target, 200 MHz – 20 GHz

A.5 0.05 mol/L NaCl solution

0.05 mol/L NaCl / water solution has a static conductivity of 0.5 S/m, similar to MRI HCL (High Conductivity Liquid). It was measured at a temperature of 22 +/- 2 °C. The liquid temperature was stabilized within 0.05 °C of the desired temperature. Deviations are presented relative to the reference data for this material. These parameters have been derived from the theoretical model according to [7], matched to the measurements from reference probes and other sources. A quantity of 1 liter was used for the measurement. For the measurements the Noise Filter was activated in the software.

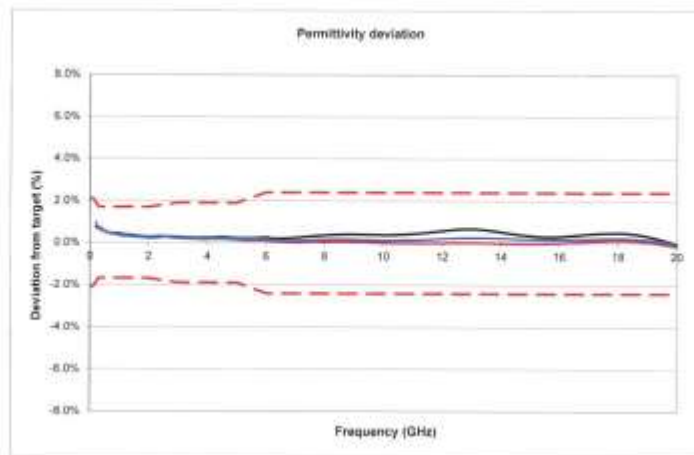

Fig. 5.1 0.05 mol/L solution permittivity deviation from target, 200 MHz – 20 GHz

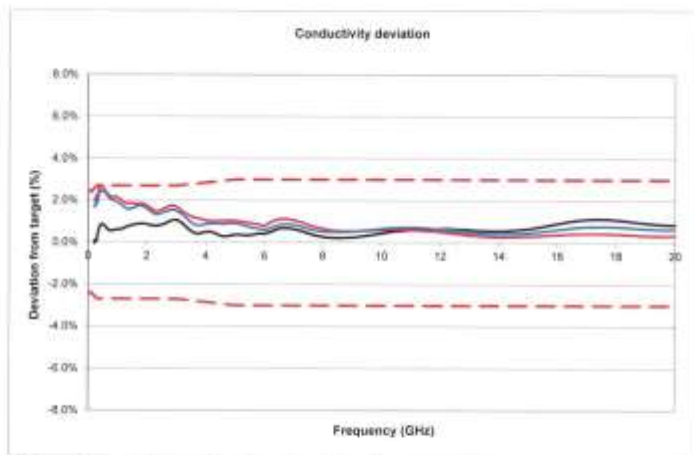

Fig. 5.2 0.05 mol/L solution conductivity deviation from target, 200 MHz – 20 GHz

Appendix B: Nominal parameters of reference materials used for calibration (additional assessments outside the scope of SCS0108)

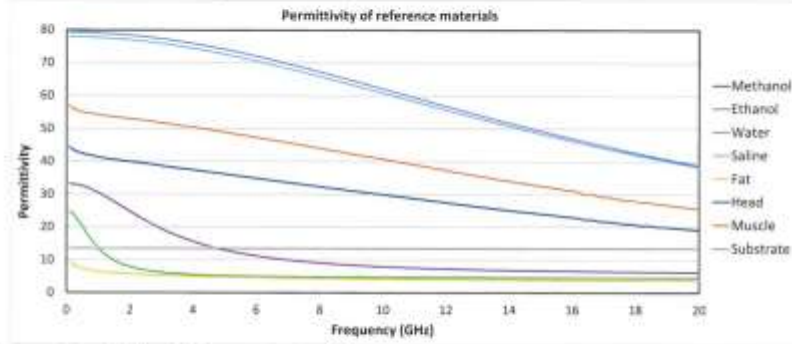

Fig. B.1 Permittivity of reference materials

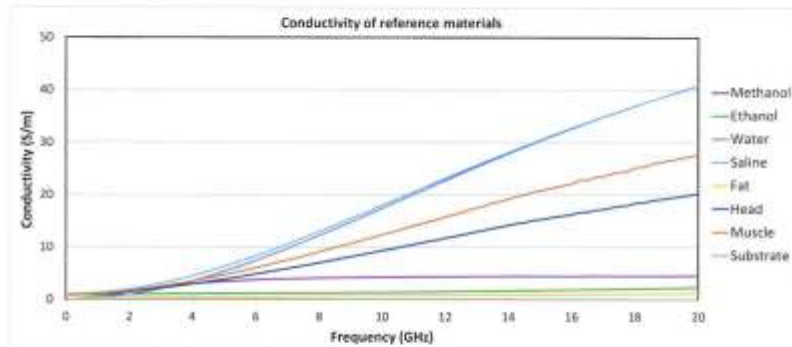

Fig. B.2 Conductivity of reference materials

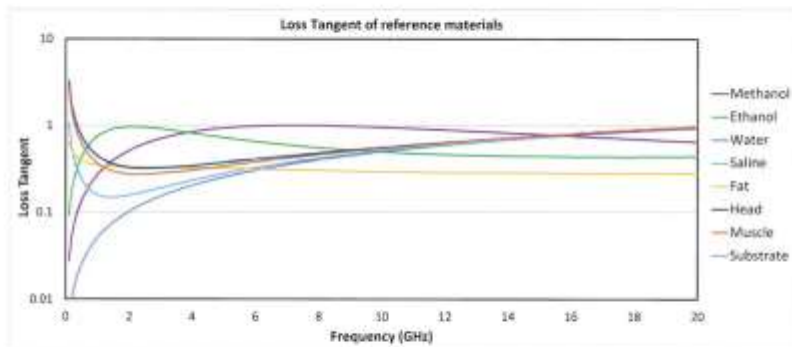

Fig. B.3 Loss tangent of reference materials