



TEST REPORT

<p>Eurofins KCTL Co.,Ltd. 65, Sinwon-ro, Yeongtong-gu, Suwon-si, Gyeonggi-do, 16677, Korea TEL: 82-70-5008-1021 FAX: 82-505-299-8311 www.kctl.co.kr</p>	<p>Report No.: KR23-SPF0031-A Page (1) of (80)</p>	
--	--	--

1. Client

- Name : Samsung Electronics Co., Ltd.
- Address : 129, Samsung-ro, Yeongtong-gu, Suwon-si, Gyeonggi-do, 16677 Rep. of Korea
- Date of Receipt : 2023-03-14

2. Use of Report : Class II Permissive Change

3. Name of Product and Model : 5G Sub-6 GHz M.2 Module with WCDMA and LTE

- Model Number : RM520N-GL
- Manufacturer and Country of Origin : Samsung Electronics Co., Ltd. / Vietnam

4. Host Product Name : Notebook PC

- Host Model Name : NP935QNA
- Manufacturer : Samsung Electronics Co., Ltd.



5. FCC ID : A3LRM520N935QNA

6. Date of Test : 2023-05-17 ~ 2023-05-25

7. Location of Test : Permanent Testing Lab On Site Testing
 (Address: 65, Sinwon-ro, Yeongtong-gu, Suwon-si, Gyeonggi-do, 16677, Korea)

8. Test Standards : FCC 47 CFR § 2.1093

9. Test Results : Refer to the test result in the test report

Affirmation	Tested by	Technical Manager
	Name : Jewon Choi  (Signature)	Name : Jongwon Ma  (Signature)

2023-06-07

Eurofins KCTL Co.,Ltd.

As a test result of the sample which was submitted from the client, this report does not guarantee the whole product quality. This test report should not be used and copied without a written agreement by Eurofins KCTL Co.,Ltd.

<p>Eurofins KCTL Co.,Ltd. 65, Sinwon-ro, Yeongtong-gu, Suwon-si, Gyeonggi-do, 16677, Korea TEL: 82-70-5008-1021 FAX: 82-505-299-8311 www.kctl.co.kr</p>	<p>Report No.: KR23-SPF0031-A Page (2) of (80)</p>	
--	---	---

REPORT REVISION HISTORY

Date	Revision	Page No
2023-05-30	Originally issued	-
2023-06-07	Set up photo removed	-

Note: The Report No. KR23-SPF0031 is superseded by the report No. KR23-SPF0031-A.

This report shall not be reproduced except in full, without the written approval of Eurofins KCTL Co.,Ltd. This document may be altered or revised by Eurofins KCTL Co.,Ltd. personnel only, and shall be noted in the revision section of the document. Any alteration of this document not carried out by Eurofins KCTL Co.,Ltd. will constitute fraud and shall nullify the document. This test report is a general report that does not use the KOLAS accreditation mark and is not related to KS Q ISO/IEC 17025 and KOLAS accreditation.

General remarks for test reports

Statement concerning the uncertainty of the measurement systems used for the tests

(may be required by the product standard or client)

Internal procedure used for type testing through which traceability of the measuring uncertainty has been established:

Procedure number, issue date and title:

Calculations leading to the reported values are on file with the testing laboratory that conducted the testing.

Statement not required by the standard or client used for type testing

1. Identification when information is provided by the customer: Information marked " # " is provided by the customer. - Disclaimer: This information is provided by the customer and can affect the validity of results.

CONTENTS

1.	General information.....	4
2.	Device information.....	5
3.	Test Under Dynamic Transmission Condition for RF Exposure Compliance.....	7
4.	Tx Varying Transmission Test Cases and Test Proposal	10
5.	SAR Time Averaging Validation Test configuration selection.....	13
6.	Test procedures description	16
7.	Test Configurations.....	24
8.	Time-varying Tx power measurement for below 6GHz frequency.....	29
9.	Radiated SAR Test Results for Smart Transmit Feature Validation	57
10.	Equipment list.....	72
11.	Conclusion	73
Appendix A. Test Sequences and Test setup photo.....		74
Appendix B. Test Procedures for sub6 NR + LTE Radio.....		76
Appendix C. System Validation Plot.....		78
End of test report		80

<p>Eurofins KCTL Co.,Ltd. 65, Sinwon-ro, Yeongtong-gu, Suwon-si, Gyeonggi-do, 16677, Korea TEL: 82-70-5008-1021 FAX: 82-505-299-8311 www.kctl.co.kr</p>	<p>Report No.: KR23-SPF0031-A Page (4) of (80)</p>	
--	---	---

1. General information

Client : Samsung Electronics Co., Ltd
Address : 129, Samsung-ro, Yeongtong-gu, Suwon-si, Gyeonggi-do, 16677, Rep. of Korea
Manufacturer : Samsung Electronics Co., Ltd
Address : 129, Samsung-ro, Yeongtong-gu, Suwon-si, Gyeonggi-do, 16677, Rep. of Korea
Laboratory : Eurofins KCTL Co.,Ltd.
Address : 65, Sinwon-ro, Yeongtong-gu, Suwon-si, Gyeonggi-do, 16677, Korea
Accreditations : FCC Site Designation No: KR0040, FCC Site Registration No: 687132
VCCI Registration No. : R-3327, G-198, C-3706, T-1849
CAB Identifier: KR0040, ISED Number: 8035A
KOLAS No.: KT231

1.1 Report Overview

This report details the results of testing carried out on the samples listed in section 2, the results contained in this test report do not relate to other samples of the same product. The manufacturer should ensure that all products in series production are in conformity with the product sample detailed in this report.

This report may only be reproduced and distributed in full. If the product in this test report is used in any configuration other than that detailed in the test report, the manufacturer must ensure the new configuration complies with all relevant standards and certification requirements. Any mention of Eurofins KCTL Co.,Ltd. Wireless lab or testing done by Eurofins KCTL Co.,Ltd. Wireless lab made in connection with the distribution or use of the tested product must be approved in writing by Eurofins KCTL Co.,Ltd. Wireless lab.

2. Device information

Product Name		5G Sub-6 GHz M.2 Module with WCDMA and LTE
Product Model Number		RM520N-GL
Product Manufacturer		Samsung Electronics Co., Ltd.
Host Product Name		Notebook PC
Host Model Number		NP935QNA
Host Manufacturer		Samsung Electronics Co., Ltd.
Product Serial Number	Radiation	KQZZ930W300218X
		KQZZ930W300355W
	Conduction	KQZZ930W300188W
		KQZZ930W300187X
Mode of Operation		WCDMA II/ IV/ V, LTE Band 2/4/5/12/14/66 NR Band n2/n5/n66/n77
Device Overview		WCDMA II: 1 852.4 MHz ~ 1 907.6 MHz
		WCDMA IV: 1 712.4 MHz ~ 1 752.6 MHz
		WCDMA V: 826.4 MHz ~ 846.6 MHz
		LTE Band 2: 1 850.7 MHz ~ 1 909.3 MHz
		LTE Band 4: 1 710.7 MHz ~ 1 754.3 MHz
		LTE Band 5: 824.7 MHz ~ 848.3 MHz
		LTE Band 12: 699.7 MHz ~ 715.3 MHz
		LTE Band 14: 790.5 MHz ~ 795.5 MHz
		LTE Band 66: 1 710.7 MHz ~ 1 779.3 MHz
		NR Band n2: 1 852.5 MHz ~ 1 907.5 MHz
		NR Band n5: 826.5 MHz ~ 846.5 MHz
		NR Band n66: 1 712.5 MHz ~ 1 777.5 MHz
		NR Band n77(DoD): 3 460.02 MHz ~ 3 540.00 MHz
NR Band n77: 3 710.01 MHz ~ 3 969.99 MHz		

The equipment under test (EUT) is NP935QNA (FCC ID : A3LRM520N935QNA), it contains the Qualcomm modems supporting 3G/4G technologies and 5G NR bands (Sub-6 only). Both of these modems are enabled with Qualcomm Smart Transmit feature to control and manage transmitting power in real time and to ensure at all times the time-averaged RF exposure is in compliance with the FCC requirement.

Purpose of the Part 2 report is to demonstrate the EUT complies with FCC RF exposure requirement under Tx varying transmission scenarios, thereby validity of Qualcomm Smart Transmit feature for FCC equipment authorization of A3LRM520N935QNA.

The P_{limit} (For 3G/4G and 5G NR Sub-6) used in this report is determined in Part 0 and Part 1 reports. Refer to Part0 report for product description and terminology used in this report.

2.1.1 EFS v16 Verification

Per Qualcomm's 80-w2112-5 document, embedded file system (EFS) version 16 products are required to be verified for Smart Tx generation for relevant EFS file operations.

It was confirmed that this DUT contains embedded file system (EFS) version 16 configured for Smart Tx second generation (GEN2) for Sub6 with EFS file change. (0dB EFS file, Actual reserve margin EFS file)



EFS v16 Generation	RTSAR EFS file
	0dB, 3dB

2.1.2 EN-DC Carrier Aggregation

EN-DC Carrier Aggregation Possible Combinations	The technical description includes all the possible carrier aggregation combinations
LTE Anchor Bands for NR Band n2(Ant.0)	LTE Band 4/66(Ant.2)
LTE Anchor Bands for NR Band n2(Ant.2)	LTE Band 5/12/14(Ant.0)
LTE Anchor Bands for NR Band n5(Ant.0)	LTE Band 2/66(Ant.2)
LTE Anchor Bands for NR Band n66(Ant.0)	LTE Band 2(Ant.2)
LTE Anchor Bands for NR Band n66(Ant.2)	LTE Band 5/12/14(Ant.0)
LTE Anchor Bands for NR Band n77(Ant.2)	LTE Band 2/5/12/14/66(Ant.0)

NOTE:

All of the NR band are operating on NSA environments only.

<p>Eurofins KCTL Co.,Ltd. 65, Sinwon-ro, Yeongtong-gu, Suwon-si, Gyeonggi-do, 16677, Korea TEL: 82-70-5008-1021 FAX: 82-505-299-8311 www.kctl.co.kr</p>	<p>Report No.: KR23-SPF0031-A Page (7) of (80)</p>	 
--	--	---

3. Test Under Dynamic Transmission Condition for RF Exposure Compliance

This device is enabled with Qualcomm® Smart Transmit algorithm to control and manage transmitting power in real time and to ensure that the time-averaged RF exposure from 2G/3G/4G/5G NR WWAN is in compliance with FCC requirements.

This feature performs time averaging algorithm in real time to control and manage transmitting power and ensure the time-averaged RF exposure is in compliance with FCC requirements all the time.

The Smart Transmit algorithm maintains the time-averaged transmit power, in turn, time-averaged RF exposure of SAR_design_target for sub 6 radio, below the predefined time averaged power limit for each characterized technology and band.

Smart Transmit allows the device to transmit at higher power instantaneously, as high as P_{max} , when needed, but enforces power limiting to maintain time-averaged transmit power to P_{limit} for frequencies < 6 GHz and input.power.limit for frequencies > 6 GHz.

Note that the device uncertainty for sub 6GHz WWAN is UMTS(+1.0dB/-3.0dB), LTE(+2.0dB/-2.0dB) Sub6 NR(+2.0dB/-3.0dB) for this DUT, and the reserve power margin is 3 dB.

This purpose of the Part 2 report is to demonstrate the DUT complies with FCC RF exposure requirement under Tx varying transmission scenarios, thereby validity of Qualcomm® Smart Transmit feature implementation in this device. It serves to compliment the Part 0 and Part 1 Test Reports to justify compliance per FCC.

All Part 2 tests of this device were conducted according to the guidelines of the Qualcomm document 80-W2112-5 Rev. U

■ Test case reduction for multiple filings

Per the Guidance of the FCC and Qualcomm (Document No: 80-W2112-5 Rev. U, Sec.4.2.)

For multiple filings with same chipset, the test case reduction proposal for Part 2 testing is:

1. Full set of tests in the first filing, i.e., both power measurement and RF exposure measurement, are required.
2. For all subsequent filings with the same chipset, only power measurement (scenarios (a) – (h)) is required.
In the case of scenario (a) time-varying Tx transmission test, only one band (instead of two bands) per technology is sufficient

■ Regulatory body configuration:

Based on regulatory requirement for each countries/regions, FCC time window/limits and/or ICNIRP 1998 time window/limits can be selected and/or combined. Additionally, Time-Averaged Exposure mode or Peak Exposure mode can be selected based on MCC for Smart Transmit to operate. In Time-Averaged Exposure mode, the wireless device can instantaneously transmit at high transmit powers and exceed the P_{limit} for a short duration before limiting the power to maintain the time-averaged transmit power under the P_{limit} , while in Peak Exposure mode, the maximum instantaneous transmit power is limited to P_{limit} . Depending on EFS version, regulatory body configuration is different.

■ force peak for Tx transmitting frequency

The Smart Transmit feature applies time-averaging windows when the device detects an MCC that matches Time-Averaged Exposure MCCs list. For each of the MCCs under Time-Averaged Exposure MCCs list, the Smart Transmit feature can limit either maximum peak power or maximum time-average power to P_{limit} per tech/band/antenna/DSI. If force peak is set to '1' for a given tech/band/antenna/DSI in the EFS, then the Smart Transmit feature limits the maximum Tx power to P_{limit} for the selected tech/band/antenna/DSI. In other words, with force peak set to '1', under static condition (i.e., fixed tech/band/antenna/DSI) and in single active Tx scenario, Smart Transmit can guarantee Tx power level of P_{limit} at all times.

The EFS Version of A3LRM520N935QNA is EFS ver.16

3.1 RF Exposure Limits for Frequencies < 6 GHz

HUMAN EXPOSURE	UNCONTROLLED ENVIRONMENT General Population (W/kg) or (mW/g)	CONTROLLED ENVIRONMENT Occupational (W/kg) or (mW/g)
SPATIAL PEAK SAR * (Partial Body)	1.6	8.0
SPATIAL AVERAGE SAR ** (Whole Body)	0.08	0.4
SPATIAL PEAK SAR *** (Hands / Feet / Ankle / Wrist)	4.0	20.0

Table 3-1

SAR Human Exposure Specified in ANSI/IEEE C95.1-1992 and Health Canada Safety Code 6

NOTES:

* The Spatial Peak value of the SAR averaged over any 1 g of tissue (defined as a tissue volume in the shape of a cube) and over the appropriate averaging time.

** The Spatial Average value of the SAR averaged over the whole-body.

*** The Spatial Peak value of the SAR averaged over any 10 g of tissue (defined as a tissue volume in the shape of a cube) and over the appropriate averaging time.

Uncontrolled Environments are defined as locations where there is the exposure of individuals who have no knowledge or control of their exposure. The general population/uncontrolled exposure limits are applicable to situations in which the general public may be exposed or in which persons who are exposed as a consequence of their employment may not be made fully aware of the potential for exposure or cannot exercise control over their exposure. Members of the general public would come under this category when exposure is not employment-related; for example, in the case of a wireless transmitter that exposes persons in its vicinity.



Controlled Environments are defined as locations where there is exposure that may be incurred by persons who are aware of the potential for exposure, (i.e.as a result of employment or occupation). In general, occupational/controlled exposure limits are applicable to situations in which persons are exposed as a consequence of their employment, who have been made fully aware of the potential for exposure and can exercise control over their exposure. This exposure category is also applicable when the exposure is of a transient nature due to incidental passage through a location where the exposure levels may be higher than the general population/uncontrolled limits, but the exposed person is fully aware of the potential for exposure and can exercise control over his or her exposure by leaving the area or by some other appropriate means.

3.2 Interim Guidance for Time Averaging

Per October 2018 TCB Workshop Notes, the below time-averaging windows can be used for assessing time-averaged exposures for devices that are capable of actively monitoring and adjusting power output over time to comply with exposure limits.

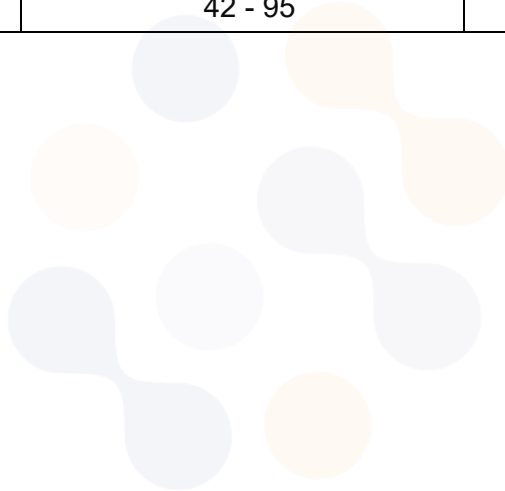
Interim Guidance	Frequency	Maximum Averaging Time
SAR	< 3	100
	3 – 6	60
MPE	6 – 10	30
	10 - 16	14
	16 - 24	8
	24 – 42	4
	42 - 95	2



<p>Eurofins KCTL Co.,Ltd. 65, Sinwon-ro, Yeongtong-gu, Suwon-si, Gyeonggi-do, 16677, Korea TEL: 82-70-5008-1021 FAX: 82-505-299-8311 www.kctl.co.kr</p>	<p>Report No.: KR23-SPF0031-A Page (10) of (80)</p>	<p> </p>
--	---	--

4. Tx Varying Transmission Test Cases and Test Proposal

To validate time averaging feature and demonstrate the compliance in Tx varying transmission conditions, the following transmission scenarios are covered in Part 2 test:

1. During a time-varying Tx power transmission: To prove that the Smart Transmit feature accounts for Tx power variations in time accurately.
2. During a call disconnect and re-establish scenario: To prove that the Smart Transmit feature accounts for history of past Tx power transmissions accurately.
3. During technology/band handover: To prove that the Smart Transmit feature functions correctly during transitions in technology/band.
4. During DSI (Device State Index) change: To prove that the Smart Transmit feature functions correctly during transition from one device state (DSI) to another.
5. SAR exposure switching between two active radios (radio1 and radio2): To prove that the Smart Transmit feature functions correctly and ensures total RF exposure compliance when exposure varies among SAR_radio1 only, SAR_radio1 + SAR_radio2, and SAR_radio2 only scenarios.

Note: Due to EUT's antenna configuration and NSA only EN-DC operation, Some parts of test cases were excluded because it was not configurable. The excluded test items are as follows – Antenna change, Time window switch test.

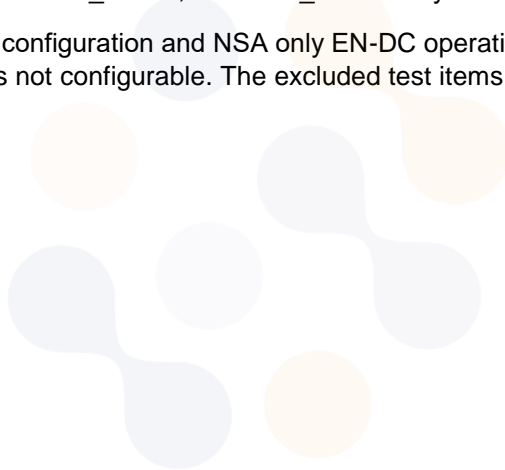

The strategy for testing in Tx varying transmission condition is outlined as follows:

- Demonstrate the total RF exposure averaged over FCC defined time windows does not exceed FCC's SAR and PD limits, through time-averaged power measurements
- Measure conducted Tx power (for f < 6GHz) versus time, and radiated Tx power (EIRPforf > 10GHz) versus time.
- Convert it into RF exposure and divide by respective FCC limits to get normalized exposure versus time.
- Perform running time-averaging over FCC defined time windows.
- Demonstrate that the total normalized time-averaged RF exposure is less than 1 for all transmission scenarios (i.e., transmission scenarios 1, 2, 3, 4, 5, and 6) at all times.

Mathematical expression:

– For sub-6 transmissions only:

$$1g_or_10gSAR(t) = \frac{conducted_Tx_power(t)}{conducted_Tx_power_P_{limit}} * 1g_or_10gSAR_P_{limit} \quad (1a)$$

$$\frac{\frac{1}{T_{SAR}} \int_{t-T_{SAR}}^t 1g_or_10gSAR(t) dt}{FCC\ SAR\ limit} \leq 1 \quad (1b)$$

where, *conducted_Tx_power(t)*, *conducted_Tx_power_Plimit*, and *1g_or_10gSAR_Plimit* correspond to the measured instantaneous conducted Tx power, measured conducted Tx power at *Plimit*, and measured 1gSAR or 10gSAR values at *Plimit* corresponding to sub-6 transmission. Both *Plimit* and *input.power.limit* are the parameters pre-defined in Part 0 and loaded via Embedded File System (EFS) onto the EUT. *T_{SAR}* is the FCC defined time window for sub-6 radio.

- Demonstrate the total RF exposure averaged over FCC defined time windows does not exceed FCC's SAR and PD limits, through time-averaged SAR and PD measurements. Note as mentioned earlier, this measurement is performed for transmission scenario 1 only.
- For sub-6 transmission only, measure instantaneous SAR versus time; for LTE+sub6 NR transmission, request low power (or all-down bits) on LTE so that measured SAR predominantly corresponds to sub6 NR.
- Convert it into RF exposure and divide by respective FCC limits to obtain normalized exposure versus time.
- Perform time averaging over FCC defined time window.
- Demonstrate that the total normalized time-averaged RF exposure is less than 1 for transmission scenario 1 at all times.

Mathematical expression:

- For sub-6 transmission only:



$$1g_or_10gSAR(t) = \frac{PointSAR(t)}{pointSAR_{P_{limit}}} * 1g_or_10gSAR(t)_{P_{limit}} \quad (3a)$$

$$\frac{\frac{1}{T_{SAR}} \int_{t-T_{SAR}}^t 1g_or_10gSAR(t) dt}{FCC\ SAR\ limit} \leq 1 \quad (3b)$$

where, $pointSAR(t)$, $PointSAR_{P_{limit}}$ and $1g_or_10gSAR_{P_{limit}}$ correspond to the measured instantaneous point SAR, measured. $pointSAR$ at P_{limit} , and measured 1gSAR or 10gSAR values at P_{limit} corresponding to sub-6 transmission.

Note: cDASY6 measurement system by Schmid & Partner Engineering AG (SPEAG) of Zurich, Switzerland measures relative E-field, and provides ratio of $\frac{[pointE(t)]^2}{[pointE_input.power.limit]^2}$ versus time.



<p style="text-align: center;">Eurofins KCTL Co.,Ltd. 65, Sinwon-ro, Yeongtong-gu, Suwon-si, Gyeonggi-do, 16677, Korea TEL: 82-70-5008-1021 FAX: 82-505-299-8311 www.kctl.co.kr</p>	<p style="text-align: center;">Report No.: KR23-SPF0031-A Page (13) of (80)</p>	 
--	---	---

5. SAR Time Averaging Validation Test configuration selection

This chapter provides the test plan and test procedure for validating Qualcomm Smart Transmit feature for sub-6 transmission. The 100 seconds time window for operating $f < 3\text{GHz}$ is used as an example to detail the test procedures in this chapter. The same test plan and test procedures described in this chapter apply to 60 seconds time window for operating $f \geq 3\text{GHz}$.

5.1 Test sequence determination for validation

Following the FCC recommendation, two test sequences having time-variation in Tx power are predefined for sub-6 ($f < 6\text{GHz}$) validation:

- **Test sequence 1:** request EUT's Tx power to be at maximum power, measured P_{max} , for 80s, then requesting for half of the maximum power, i.e., measured $P_{max}/2$, for the rest of the time.
- **Test sequence 2:** request EUT's Tx power to vary with time. This sequence is generated relative to measured P_{max} , measured P_{limit} and calculated $P_{reserve}$ (= measured P_{limit} in dBm - Reserve_power_margin in dB) of EUT based on measured P_{limit} .

The details for generating these two test sequences is described and listed in Appendix A.

NOTE: For test sequence generation, "measured P_{limit} " and "measured P_{max} " are used instead of the " P_{limit} " specified in EFS entry and " P_{max} " specified for the device, because Smart Transmit feature operates against the actual power level of the " P_{limit} " that was calibrated for the EUT. The "measured P_{limit} " accurately reflects what the feature is referencing to, therefore, it should be used during feature validation testing. The RF tune up and device- to-device variation are already considered in Part 0 report prior to determining P_{limit} .

5.2 Test configuration selection criteria for validating Smart Transmit feature

For validating Smart Transmit feature, this section provides a general guidance to select test cases. In practice, a n adjustment can be made in test case selection. The justification/clarification may be provided.

5.2.1 Test configuration selection for time-varying Tx power transmission



The Smart Transmit time averaging feature operation is independent of bands, modes, and channels for a given technology. Hence, validation of Smart Transmit in one band/mode/channel per technology is sufficient. Two bands per technology are proposed and selected for this testing to provide high confidence in this validation.

The criteria for the selection are based on the P_{limit} values determined in Part 0 report. Select two bands* in each supported technology that correspond to least** and highest*** P_{limit} values that are less than P_{max} for validating Smart Transmit.

*If one P_{limit} level applies to all the bands within a technology, then only one band needs to be tested. In this case, within the bands having the same P_{limit} , the radio configuration (e.g., # of RBs, channel#) and device position that correspond to the highest measured 1gSAR at P_{limit} shown in Part 1 report is selected.

** In case of multiple bands having the same least P_{limit} within the technology, then select the band having the highest measured 1gSAR at P_{limit} .

*** The band having a higher P_{limit} needs to be properly selected so that the power limiting enforced by Smart Transmit can be validated using the pre-defined test sequences. If the highest P_{limit} in a technology is too high where the power limiting enforcement is not needed when testing with the pre-defined test sequences, then the next highest level is checked. This process is continued within the technology until the second band for validation testing is determined.

<p style="text-align: center;">Eurofins KCTL Co.,Ltd. 65, Sinwon-ro, Yeongtong-gu, Suwon-si, Gyeonggi-do, 16677, Korea TEL: 82-70-5008-1021 FAX: 82-505-299-8311 www.kctl.co.kr</p>	<p style="text-align: center;">Report No.: KR23-SPF0031-A Page (14) of (80)</p>	 
--	---	---

5.2.2 Test configuration selection for change in call

The criteria to select a test configuration for call-drop measurement is:

- Select technology/band with least P_{limit} among all supported technologies/bands, and select the radio configuration (e.g., # of RBs, channel#) in this technology/band that corresponds to the highest measured 1gSAR at P_{limit} listed in Part 1 report.
- In case of multiple bands having same least P_{limit} , then select the band having the highest measured 1gSAR at P_{limit} in Part 1 report.

This test is performed with the EUT's Tx power requested to be at maximum power, the above band selection will result in Tx power enforcement (i.e., EUT forced to have Tx power at $P_{reserve}$) for longest duration in one FCC defined time window. The call change (call drop/reestablish) is performed during the Tx power enforcement duration (i.e., during the time when EUT is forced to have Tx power at $P_{reserve}$). One test is sufficient as the feature operation is independent of technology and band.

5.2.3 Test configuration selection for change in technology/band

The selection criteria for this measurement is, for a given antenna, to have EUT switch from a technology/band with lowest P_{limit} within the technology group (in case of multiple bands having the same P_{limit} , then select the band with highest measured 1gSAR at P_{limit}) to a technology/band with highest P_{limit} within the technology group, in case of multiple bands having the same P_{limit} , then select the band with lowest measured 1gSAR at P_{limit} in Part 1 report, or vice versa.

This test is performed with the EUT's Tx power requested to be at maximum power, the technology/band switch is performed during Tx power enforcement duration (i.e., during the time when EUT is forced to have Tx power at $P_{reserve}$).

5.2.4 Test configuration selection for change in DSI

The criteria to select a test configuration for DSI change test is

- Select a technology/band having the $P_{limit} < P_{max}$ within any technology and DSI group, and for the same technology/band having a different P_{limit} in any other DSI group. Note that the selected DSI transition need to be supported by the device.

This test is performed with the EUT's Tx power requested to be at maximum power in selected technology/band, and DSI change is conducted during Tx power enforcement duration (i.e., during the time when EUT is forced to have Tx power at $P_{reserve}$).

5.2.5 Test configuration selection for SAR exposure switching

If supported, the test configuration for SAR exposure switching should cover

1. SAR exposure switch when two active radios are in the same time window.
2. SAR exposure switch when two active radios are in different time windows. One test with two active radios in any two different time windows is sufficient as Smart Transmit operation is the same for RF exposure switch in any combination of two different time windows. For device supporting LTE + mmW NR, this test is covered in SAR vs PD exposure switch validation.

The Smart Transmit time averaging operation is independent of the source of SAR exposure (for example, LTE vs. Sub6 NR) and ensures total time-averaged RF exposure compliance. Hence, validation of Smart Transmit in any one simultaneous SAR transmission scenario (i.e., one combination for LTE + Sub6 NR transmission) is sufficient, where the SAR exposure varies among SAR_{Radio1} only, $SAR_{Radio1} + S_{AR_{Radio2}}$, and SAR_{Radio2} only scenarios.

The criteria to select a test configuration for validating Smart Transmit feature during SAR exposure switching scenarios is

- Select any two < 6GHz technologies/bands that the EUT supports simultaneous transmission (for example, LTE+Sub6NR).
- Among all supported simultaneous transmission configurations, the selection order is
 1. select one configuration where both P_{limit} of radio1 and radio2 is less than their corresponding P_{max} , preferably, with different P_{limits} . If this configuration is not available, then,
 2. select one configuration that has P_{limit} less than its P_{max} for at least one radio. If this cannot be found, then,
 3. select one configuration that has P_{limit} of radio1 and radio2 greater than P_{max} but with least $(P_{limit} - P_{max})$ delta.

Test for one simultaneous transmission scenario is sufficient as the feature operation is the same.



6 Test procedures description

6.1 Test procedures for conducted power measurements

This section provides general conducted power measurement procedures to perform compliance test under dynamic transmission scenarios described in Section 4. In practice, an adjustment can be made in these procedures. The justification/clarification may be provided.

6.1.1 Time-varying Tx power transmission scenario

This test is performed with the two pre-defined test sequences described in Section 5.1 for all the technologies and bands selected in Section 5.2.1. The purpose of the test is to demonstrate the effectiveness of power limiting enforcement and that the time-averaged SAR (corresponding time-averaged Tx power) does not exceed the FCC limit at all times (see Eq. (1a) and (1b)).

Test procedure

1. Measure P_{max} , measure P_{limit} and calculate Preserve (= measured P_{limit} in dBm – Reserve_power_margin in dB) and follow Section 5.1 to generate the test sequences for all the technologies and bands selected in Section 5.2.1. Both test sequence 1 and test sequence 2 are created based on measured P_{max} and measured P_{limit} of the EUT. Test condition to measure P_{max} and P_{limit} is:
 - Measure P_{max} with Smart Transmit disabled and callbox set to request maximum power.
 - Measure P_{limit} with Smart Transmit enabled and Reserve_power_margin set to 0 dB, callbox set to request maximum power.
2. Set *Reserve_power_margin* to actual (intended) value (3dB for this EUT based on Part 1 report) and reset power on EUT to enable Smart Transmit, establish radio link in desired radio configuration, with callbox requesting the EUT's Tx power to be at pre-defined test sequence 1, measure and record Tx power versus time, and then convert the conducted Tx power into 1gSAR or 10gSAR value (see Eq.(1a)) using measured P_{limit} from above Step 1. Perform running time average to determine time-averaged power and 1gSAR or 10gSAR versus time as illustrated in Figure 5-1 where using 10 0-second time window as an example.

NOTE: In Eq.(1a), instantaneous Tx power is converted into instantaneous 1gSAR or 10gSAR value by applying the measured worst-case 1gSAR or 10gSAR value at P_{limit} for the corresponding technology/band/antenna/DSI reported in Part 1 report.

NOTE: For an easier computation of the running time average, 0 dBm can be added at the beginning of the test sequences the length of the responding time window, for example, add 0dBm for 100-seconds so the running time average can be directly performed starting with the first 100-seconds data using excel spreadsheet. This technique applies to all tests performed in this Part 2 report for easier time-averaged computation using excel spreadsheet.

Figure 6-1 100s running average illustration

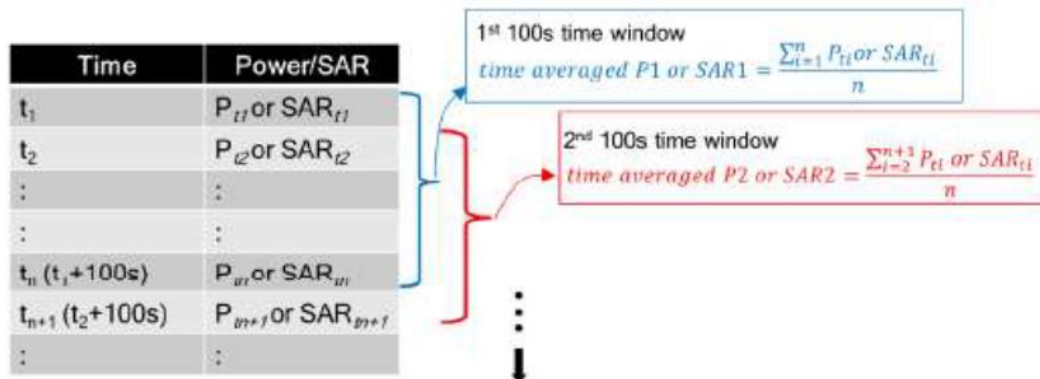

3. Make one plot containing:

- Instantaneous Tx power versus time measured in Step2,
- Requested Tx power used in Step 2 (test sequence1),
- Computed time-averaged power versus time determined in Step2,
- Time-averaged power limit (corresponding to FCC SAR limit of 1.6 W/kg for 1gSAR or 4.0W/kg for 10gSAR) given by



$$Time\ averaged\ power\ limit = meas.P_{limit} + 10 \times \log\left(\frac{FCC\ SAR\ limit}{meas.SAR_P_{limit}}\right) \quad (5a)$$

where $meas. P_{limit}$ and $meas. SAR_P_{limit}$ correspond to measured power at P_{limit} and measured SAR at P_{limit} .

4. Make another plot containing:

- Computed time-averaged 1gSAR or 10gSAR versus time determined in Step2
 - FCC1gSARlimit of 1.6W/kg or FCC 10gSAR of 4.0W/kg.
- Repeat Steps 2 ~ 4 for pre-defined test sequence 2 and replace the requested Tx power (test sequence 1) in Step 2 with test sequence2.
 - Repeat Steps 2 ~ 5 for all the selected technologies and bands.

The validation criteria are, at all times, the time-averaged power versus time shown in Step 3 plot shall not exceed the time-averaged power limit (defined in Eq. (5a)), in turn, the time-averaged 1gSAR or 10gSAR versus time shown in Step 4 plot shall not exceed the FCC limit of 1.6 W/kg for 1gSAR or 4.0 W/kg for 10gSAR (i.e., Eq. (1b)).

<p style="text-align: center;">Eurofins KCTL Co.,Ltd. 65, Sinwon-ro, Yeongtong-gu, Suwon-si, Gyeonggi-do, 16677, Korea TEL: 82-70-5008-1021 FAX: 82-505-299-8311 www.kctl.co.kr</p>	<p style="text-align: center;">Report No.: KR23-SPF0031-A Page (18) of (80)</p>	 
--	---	---

6.1.2 Change in call scenario



This test is to demonstrate that Smart Transmit feature accurately accounts for the past Tx powers during time-averaging when a new call is established.

The call disconnect and re-establishment needs to be performed during power limit enforcement, i.e., when the EUT's Tx power is at Preserve level, to demonstrate the continuity of RF exposure management and limiting in call change scenario. In other words, the RF exposure averaged over any FCC defined time window (including the time windows containing the call change) doesn't exceed FCC limit of 1.6 W/kg for 1gSAR or 4.0 W/kg for 10gSAR.

Test procedure

1. Measure P_{limit} for the technology/band selected in Section 5.2.2. Measure P_{limit} with Smart Transmit enabled and Reserve_power_margin set to 0 dB, callbox set to request maximum power.
2. Set Reserve_power_margin to actual (intended) value and reset power on EUT to enable Smart Transmit.
3. Establish radio link with callbox in the selected technology/band.
4. Request EUT's Tx power at 0 dBm for at least one time window specified for the selected technology/band, followed by requesting EUT's Tx power to be at maximum power for about ~60 seconds, and then drop the call for ~10 seconds. Afterwards, re-establish another call in the same radio configuration (i.e., same technology/band/channel) and continue callbox requesting EUT's Tx power to be at maximum power for the remaining time of at least another full duration of the specified time window. Measure and record Tx power versus time. Once the measurement is done, extract instantaneous Tx power versus time, convert the measured conducted Tx power into 1g SAR or 10g SAR value using Eq. (1a), and then perform the running time average to determine time-averaged power and 1g SAR or 10g SAR versus time.
NOTE: In Eq.(1a), instantaneous Tx power is converted into instantaneous 1gSAR or 10gSAR value by applying the measured worst-case 1gSAR or 10gSAR value at P_{limit} for the corresponding technology/band/antenna/DSI reported in Part 1 report.
5. Make one plot containing: (a) instantaneous Tx power versus time, (b) requested power, (c) computed time-averaged power, (d) time-averaged power limit calculated using Eq.(5a).
6. Make another plot containing: (a) computed time-averaged 1gSAR or 10gSAR versus time, and (b) FCC limit of 1.6 W/kg for 1gSAR or 4.0 W/kg for 10gSAR.

The validation criteria are, at all times, the time-averaged power versus time shall not exceed the time-averaged power limit (defined in Eq.(5a)), in turn, the time-averaged 1gSAR or 10gSAR versus time shall not exceed the FCC limit of 1.6 W/kg for 1gSAR or 4.0 W/kg for 10gSAR (i.e., Eq. (1b)).

<p style="text-align: center;">Eurofins KCTL Co.,Ltd. 65, Sinwon-ro, Yeongtong-gu, Suwon-si, Gyeonggi-do, 16677, Korea TEL: 82-70-5008-1021 FAX: 82-505-299-8311 www.kctl.co.kr</p>	<p style="text-align: center;">Report No.: KR23-SPF0031-A Page (19) of (80)</p>	 
--	---	---

6.1.3. Change in technology and band

This test is to demonstrate the correct power control by Smart Transmit during technology switches and/or band handovers.

Similar to the change in call test in Section 6.1.2, to validate the continuity of RF exposure limiting during the transition, the technology and band handover needs to be performed when EUT's Tx power is at $P_{reserve}$ level (i.e., during Tx power enforcement) to make sure that the EUT's Tx power from previous $P_{reserve}$ level to the new $P_{reserve}$ level (corresponding to new technology/band). Since the P_{limit} could vary with technology and band, Eq. (1a) can be written as follows to convert the instantaneous Tx power in 1gSAR or 10gSAR exposure for the two given radios, respectively:

$$1g_or_10gSAR(t) = \frac{conducted_Tx_power_1(t)}{conducted_Tx_power_P_{limit_1}} * 1g_or_10gSAR_P_{limit_1} \quad (6a)$$

$$1g_or_10gSAR(t) = \frac{conducted_Tx_power_2(t)}{conducted_Tx_power_P_{limit_2}} * 1g_or_10gSAR_P_{limit_2} \quad (6b)$$



$$\frac{1}{T_{SAR}} \left[\int_{t-T_{SAR}}^t \frac{1g_or_10gSAR_1(t)}{FCC\ SAR\ limit} dt + \int_{t-T_{SAR}}^t \frac{1g_or_10gSAR_2(t)}{FCC\ SAR\ limit} dt \right] \leq 1 \quad (6c)$$

where, $conducted_Tx_power_1(t)$, $conducted_Tx_power_P_{limit_1}$, and $1g_or_10gSAR_P_{limit_1}$ correspond to the measured instantaneous conducted Tx power, measured conducted Tx power at P_{limit} , and measured 1gSAR or 10gSAR value at P_{limit} of technology1/band1; $conducted_Tx_power_2(t)$, $conducted_Tx_power_P_{limit_2}(t)$, and $1g_or_10gSAR_P_{limit_2}$ correspond to the measured instantaneous conducted Tx power, measured conducted Tx power at P_{limit} , and measured 1gSAR or 10gSAR value at P_{limit} of technology2/band2. Transition from technology1/band1 to the technology2/band2 happens at time-instant ' t_1 '.

Test procedure

1. Measure P_{limit} for both the technologies and bands selected in Section 5.2.3. Measure P_{limit} with Smart Transmit *enabled* and *Reserve_power_margin* set to 0 dB, callbox set to request maximum power.
2. Set *Reserve_power_margin* to actual (intended) value and reset power on EUT to enable Smart Transmit
3. Establish radio link with callbox in first technology/band selected.
4. Request EUT's Tx power at 0 dBm for at least one time window specified for the selected technology/band, followed by requesting EUT's Tx power to be at maximum power for about ~60 seconds, and then switch to second technology/band selected. Continue with callbox requesting EUT's Tx power to be at maximum power for the remaining time of at least another full duration of the specified time window. Measure and record Tx power versus time for the full duration of the test.
5. Once the measurement is done, extract instantaneous Tx power versus time, and convert the conducted Tx power into 1gSAR or 10gSAR value using Eq. (6a) and (6b) and corresponding measured P_{limit} values from Step 1 of this section. Perform the running time average to determine time-averaged power and 1gSAR or 10gSAR versus time.
NOTE: In Eq.(6a) & (6b), instantaneous Tx power is converted into instantaneous 1gSAR or 10gSAR value by applying the measured worst-case 1gSAR or 10gSAR value at P_{limit} for the corresponding technology/band/antenna/DSI reported in Part 1 report.
6. Make one plot containing: (a) instantaneous Tx power versus time, (b) requested power, (c) computed time-averaged power, (d) time-averaged power limit calculated using Eq.(5a).
7. Make another plot containing: (a) computed time-averaged 1gSAR or 10gSAR versus time, and (b) FCC limit of 1.6 W/kg for 1gSAR or 4.0 W/kg for 10gSAR

The validation criteria are, at all times, the time-averaged 1gSAR or 10gSAR versus time shall not exceed the FCC limit of 1.6 W/kg for 1gSAR or 4.0 W/kg for 10gSAR (i.e., Eq. (6c)).

<p>Eurofins KCTL Co.,Ltd. 65, Sinwon-ro, Yeongtong-gu, Suwon-si, Gyeonggi-do, 16677, Korea TEL: 82-70-5008-1021 FAX: 82-505-299-8311 www.kctl.co.kr</p>	<p>Report No.: KR23-SPF0031-A Page (20) of (80)</p>	 
--	--	---

6.1.4 Change in antenna

This test is to demonstrate the correct power control by Smart Transmit during antenna switches from one antenna to another. The test procedure is identical to Section 6.1.3, by replacing technology/band switch operation with antenna switch. The validation criteria are, at all times, the time-averaged 1gSAR or 10gSAR versus time shall not exceed FCC limit of 1.6 W/kg for 1gSAR or 4.0 W/kg for 10gSAR.

Note: If the EUT does not support antenna switch within the same technology/band, but has multiple antennas to support different frequency bands, then the antenna switch test is included as part of change in technology and band (Section 6.1.3) test.

At this EUT, the antenna switch test is included as part of change in technology and band (Section 6.1.3) test.

6.1.5 Change in DSI



This test is to demonstrate the correct power control by Smart Transmit during DSI switches from one DSI to another. The test procedure is identical to Section 6.1.3, by replacing technology/band switch operation with DSI switch. The validation criteria are, at all times, the time-averaged 1gSAR or 10gSAR versus time shall not exceed FCC limit of 1.6 W/kg for 1gSAR or 4.0 W/kg for 10gSAR.

6.1.6 SAR exposure switching

This test is to demonstrate that Smart Transmit feature is accurately accounts for switching in exposures among SAR from radio1 only, SAR from both radio1 and radio2, and SAR from radio2 only scenarios, and ensures total time-averaged RF exposure complies with the FCC limit. The detailed test procedure for SAR exposure switching in the case of LTE+Sub6 NR non- standalone mode transmission scenario is provided in Appendix B.2.

Test procedure:

1. Measure conducted Tx power corresponding to P_{limit} for radio1 and radio2 in selected band. Test condition to measure conducted P_{limit} is:
 - Establish device in call with the callbox for radio1 technology/band. Measure conducted Tx power corresponding to radio1 P_{limit} with Smart Transmit enabled and Reserve_power_margin set to 0 dB, callbox set to request maximum power.
 - Repeat above step to measure conducted Tx power corresponding to radio2 P_{limit} . If radio2 is dependent on radio1 (for example, non-standalone mode of Sub6 NR requiring radio1 LTE as anchor), then establish radio1 + radio2 call with callbox, and request all down bits for radio1 LTE. In this scenario, with callbox requesting maximum power from radio2 Sub6 NR, measured conducted Tx power corresponds to radio2 P_{limit} (as radio1 LTE is at all-down bits)
2. Set Reserve_power_margin to actual (intended) value, with EUT setup for radio1 + radio2 call. In this description, it is assumed that radio2 has lower priority than radio1. Establish device in radio1+radio2 call, and request all-down bits or low power on radio1, with callbox requesting EUT's Tx power to be at maximum power in radio2 for at least one time window. After one time window, set callbox to request EUT's Tx power to be at maximum power on radio1, i.e., all-up bits. Continue radio1+radio2 call with both radios at maximum power for at least one time window, and drop (or request all-down bits on) radio2. Continue radio1 at maximum power for at least one time window. Record the conducted Tx power for both radio1 and radio2 for the entire duration of this test.

<p>Eurofins KCTL Co.,Ltd. 65, Sinwon-ro, Yeongtong-gu, Suwon-si, Gyeonggi-do, 16677, Korea TEL: 82-70-5008-1021 FAX: 82-505-299-8311 www.kctl.co.kr</p>	<p>Report No.: KR23-SPF0031-A Page (21) of (80)</p>	<p> </p>
--	---	--

3. Once the measurement is done, extract instantaneous Tx power versus time for both radio1 and radio2 links. Convert the conducted Tx power for both these radios into 1gSAR or 10gSAR value (see Eq. (6a) and (6b)) using corresponding technology/band P_{limit} measured in Step 1, and then perform the running time average to determine time-averaged 1gSAR or 10gSAR versus time.
4. Make one plot containing: (a) instantaneous Tx power versus time measured in Step2.
5. Make another plot containing: (a) instantaneous 1gSAR versus time determined in Step 3, (b) computed time-averaged 1gSAR versus time determined in Step 3, and (c) corresponding regulatory 1gSARlimit of 1.6W/kg or 10gSARlimit of 4.0W/kg.

The validation criteria is, at all times, the time-averaged 1gSAR or 10gSAR versus time shall not exceed the regulatory $1gSAR_{limit}$ of 1.6W/kg or $10gSAR_{limit}$ of 4.0W/kg.



6.2 Test procedure for time-varying SAR measurements

This section provides general time-varying SAR measurement procedures to perform compliance test under dynamic transmission scenarios described in Section 4. In practice, an adjustment can be made in these procedures. The justification/clarification may be provided.

To perform the validation through SAR measurement for transmission scenario 1 described in Section 4, the “path loss” between callbox antenna and EUT needs to be calibrated to ensure that the EUT Tx power reacts to the requested power from callbox in a radiated call. It should be noted that when signaling in closed loop mode, protocol-level power control is in play, resulting in EUT not solely following callbox TPC (Tx power control) commands. In other words, EUT response has many dependencies (RSSI, quality of signal, path loss variation, fading, etc.) other than just TPC commands. These dependencies have less impact in conducted setup (as it is a controlled environment and the path loss can be very well calibrated) but have significant impact on radiated testing in an uncontrolled environment, such as SAR test setup. Therefore, the deviation in EUT Tx power from callbox requested power is expected, however the time- averaged SAR should not exceed FCC SAR requirement at all times as Smart Transmit controls Tx power at EUT.

The following steps are for time averaging feature validation through SAR measurement:

1. “Path Loss” calibration: Place the EUT against the phantom in the worst-case position determined based on Section 5.2.1. For each band selected, prior to SAR measurement, perform “path loss” calibration between callbox antenna and EUT. Since the SAR test environment is not controlled and well calibrated for OTA (Over the Air) test, extreme care needs to be taken to avoid the influence from reflections. The test setup is described in Section 7.1.
2. Time averaging feature validation:
 - i. For a given radio configuration (technology/band) selected in Section 5.2.1, enable Smart Transmit and set Reserve_power_margin to 0 dB, with callbox to request maximum power, perform area scan, conduct point SAR measurement at peak location of the area scan. This point SAR value, *point SAR_{P_{limit}}*, corresponds to point SAR at the measured *P_{limit}* (i.e., measured *P_{limit}* from the EUT in Step 1 of Section 6.1.1).
 - ii. Set *Reserve_power_margin* to actual (intended) value and reset power on EUT to enable Smart Transmit. *Note*, if *Reserve_power_margin* cannot be set wirelessly, care must be taken to re-position the EUT in the *exact* same position relative to the SAM phantom as in above Step 2.i. Establish radio link in desired radio configuration, with callbox requesting the EUT’s Tx power at power levels described by test sequence 1 generated in Step 1 of Section 6.1.1, conduct point SAR measurement versus time at peak location of the area scan determined in Step 2.i of this section. Once the measurement is done, extract instantaneous point SAR vs time data, *point SAR(t)*, and convert it into instantaneous 1gSAR or 10gSAR vs. time using Eq. (3a), re-written below:

$$1g_or_10gSAR(t) = \frac{PointSAR(t)}{pointSAR_P_{limit}} * 1g_or_10gSAR_P_{limit}$$

where, *pointSAR_{P_{limit}}* is the value determined in Step 2.i, and *pointSAR(t)* is the instantaneous point SAR measured in Step 2.ii, *1g-or10gSAR_{P_{limit}}* is the measured 1gSAR or 10gSAR value listed in Part 1 report.

- iii. Perform 100s running average to determine time-averaged 1gSAR or 10gSAR versus time.
- iv. Make one plot containing: (a) time-averaged 1gSAR or 10gSAR versus time determined in Step 2.iii of this section, (b) FCC limit of 1.6 W/kg for 1gSAR or 4.0 W/kg for 10gSAR.
- v. Repeat 2.ii ~ 2.iv for test sequence 2 generated in Step 1 of Section 6.1.1.
- vi. Repeat 2.i ~ 2.v for all the technologies and bands selected in Section 5.2.1.

The time-averaging validation criteria for SAR measurement is that, at all times, the time- averaged 1gSAR or 10gSAR versus time shall not exceed FCC limit of 1.6 W/kg for 1gSAR or 4.0 W/kg for 10gSAR (i.e., Eq.(3b)).

6.3 Time-Averaging Algorithm for RF Exposure Compliance

This Device is enabled with the Qualcomm® Smart Transmit Gen2 feature.

This feature performs time averaging algorithm in real time to control and manage transmitting power and ensure the time-averaged RF exposure is in compliance with FCC requirements all the time.

Note that WLAN operations are not enabled with Smart Transmit.

The Smart Transmit algorithm maintains the time-averaged transmit power, in turn, time-averaged RF exposure of SAR_design_target, below the predefined time-averaged power limit (i.e., P_{limit} for sub-6 radio), for each characterized technology and band.

Smart Transmit allows the device to transmit at higher power instantaneously, as high as P_{max} , when needed, but enforces power limiting to maintain time-averaged transmit power to P_{limit} .

Below table shows P_{limit} EFS settings and maximum tune up output power P_{max} configured for this EUT for various transmit conditions (Device State Index DSI).

Note that the device uncertainty for sub-6GHz WWAN is UMTS(+1.0dB/-3.0dB), LTE(+2.0dB/-2.0dB) Sub6 NR(+2.0dB/-3.0dB) as provided by manufacturer.



7. Test Configurations



7.1 WWAN (sub-6) transmission

The P_{limit} values, corresponding to 1.0 W/kg (1gSAR) of SAR_design_target, for technologies and bands supported by EUT are derived in Part 0 report and summarized in Table 7-1.

P_{limit} values in blue indicate $P_{limit} < P_{max}$		Plim values in grey indicate $P_{limit} > P_{max}$			
P_{limit} corresponding to 1 W/kg(1g) SAR_Design_target					P_{max}
SAR Exposure Position		Notebook Mode		Tablet Mode	
		Grip sensor Off	Grip sensor On	Tablet	Maximum Tune-up Output power (Frame Averaged Power) [dBm]
Averaging Volume		1g	1g	1g	
Separation Distance		12 mm	0 mm	0 mm	
Mode	Band	DSI = 0	DSI = 1	DSI = 2	
UMTS	2	25.5	17.0	14.0	
UMTS	4	25.3	15.0	14.0	24.0
UMTS	5	30.0	22.0	20.0	24.0
LTE FDD (Ant.0)	2	25.7	16.0	13.0	23.0
LTE FDD (Ant.2)	2	27.0	16.0	13.0	22.0
LTE FDD (Ant.0)	4	N/A	N/A	N/A	24.0
LTE FDD (Ant.2)	4	N/A	N/A	N/A	23.0
LTE FDD	5	30.3	21.0	19.0	23.0
LTE FDD	12	32.4	19.0	14.0	23.0
LTE FDD	14	30.3	20.0	18.0	23.0
LTE FDD (Ant.0)	66	25.0	14.0	13.0	23.0
LTE FDD (Ant.2)	66	28.4	14.0	13.0	22.0
NR FDD (Ant.0)	n2	25.5	16.0	13.0	23.0
NR FDD (Ant.2)	n2	29.7	16.0	13.0	23.0
NR FDD (Ant.0)	n5	30.1	21.0	19.0	23.0
NR FDD (Ant.0)	n66	25.2	14.0	13.0	23.0
NR FDD (Ant.2)	n66	28.5	14.0	13.0	23.0
NR TDD (Ant.2)	n77	24.9	11.5	6.5	25.0
NR TDD (Ant.2)	n77 DoD	26.0	11.5	6.5	25.0

Table 7-1

P_{limit} for supported technologies and bands (P_{limit} in EFS file)

<p>Eurofins KCTL Co.,Ltd. 65, Sinwon-ro, Yeongtong-gu, Suwon-si, Gyeonggi-do, 16677, Korea TEL: 82-70-5008-1021 FAX: 82-505-299-8311 www.kctl.co.kr</p>	<p>Report No.: KR23-SPF0031-A Page (25) of (80)</p>	 
--	---	---

Maximum Tune-up Target Power, P_{max} is configured in NV settings in DUT to limit maximum average transmitting power. The DUT maximum allowed output power is equal to P_{max} is UMTS(+1.0dB/-3.0dB), LTE(+2.0dB/-2.0dB) Sub6 NR(+2.0dB/-3.0dB) for this DUT device uncertainty.

Based on selection criteria described in Section 5.2.1, the selected technologies/bands for testing time-varying test sequences are highlighted in Table 7-1. During Part 2 testing, the *Reserve_power_margin* (dB) is set to 3dB in EFS according to the manufacturer guide.

The radio configurations used in Part 2 test for selected technologies, bands, DSIs and antennas are listed in Table 7-2. The corresponding worst-case radio configuration 1gSAR values for selected technology/band/DSI are extracted from Part 1 report and are listed in the last column of Table 7-2.

Based on equations (1a), (2a), (3a) and (4a), it is clear that Part 2 testing outcome is normalized quantity, which implies that it can be applied to any radio configuration within a selected technology/band/DSI. Thus, as long as applying the worst-case SAR obtained from the worst radio configuration in Part 1 testing to calculate time-varying SAR exposure in equations (1a), (2a), (3a) and (4a), the accuracy in compliance demonstration remains the same. Therefore, there may be some differences between the radio configuration selected for Part 2 testing and the radio configuration associated with worst-case SAR obtained in the Part 1 evaluation.

Note:

In the case of LTE band 4 is marked as N/A, which frequency overlapping band with band 66.



7.2 Test Radio Configurations

The measured P_{limit} for all the selected radio configurations are listed in below Table 7-2.

P_{max} was also measured for radio configurations selected for testing time-varying Tx power transmission scenarios in order to generate test sequences following the test procedures.

Table 7-2

Measured P_{limit} and P_{max} of selected radio configurations

Test Case	Test Scenario	Tech	Band	Ant.	DSI	Frequency [MHz]	RB /RB Offset /Bandwidth [MHz]	Mode	SAR Exposure Scenario	Part 1 Worst Case Measured SAR at P_{limit} (W/kg)	
1	Time-varying Tx power transmission	UMTS	2	Ant.0	2	1 907.6	-	RMC	Tablet, Rear, 0mm	0.737	
		UMTS	5	Ant.0	2	836.6	-	RMC	Tablet, Rear, 0mm	0.961	
2		LTE	B5	Ant.0	2	836.5	25 / 25 / 10	QPSK	Tablet, Rear, 0mm	0.999	
		LTE	B66	Ant.0	2	1 770.0	1 / 0 / 20	QPSK	Tablet, Rear, 0mm	0.694	
3		Sub6 NR	n5	Ant.0	2	836.5	100 / 0 / 20	DFT-S-OFDM QPSK	Tablet, Rear, 0mm	1.240	
		Sub6 NR	n66	Ant.0	2	1 745.0	1 / 158 / 30	DFT-S-OFDM QPSK	Tablet, Rear, 0mm	0.894	
4		Change in Call	UMTS	2	Ant.0	2	1 907.6	-	RMC	Tablet, Rear, 0mm	0.737
5		Tech/Band Switch	UMTS	4	Ant.0	2	1 732.4	-	RMC	Tablet, Rear, 0mm	0.516
	LTE		B5	Ant.0	2	836.5	25 / 25 / 10	QPSK	Tablet, Rear, 0mm	0.999	
6	DSI Switch	UMTS	2	Ant.0	1	1 852.4	-	RMC	Grip Sensor On, Rear, 0mm	0.954	
					2		-	RMC	Tablet, Rear, 0mm	0.737	
7	SAR1 vs SAR2	LTE	B5	Ant.0	2	836.5	25 / 25 / 10	QPSK	Grip Sensor On, Rear, 0mm	0.999	
		Sub6 NR	n66	Ant.2	2	1 745.0	1 / 1 / 30	CP-OFDM QPSK	Grip Sensor On, Rear, 0mm	0.537	

Notes:

Reported SAR values in Part 1 SAR report are tested at P_{limit} + tolerance. Therefore, 100s(or 60s) average SAR is shown to be ± 1.0 dB from SAR design target.

Table 7-3

DSI and Corresponding Exposure Scenarios

Exposure Scenario (DSI = No.)		Description	KDB guide for SAR test
Notebook Mode	Standalone exposure Without triggering sensor (DSI = 0)	<ul style="list-style-type: none"> ■ Grip sensor is not triggered even if Device was touched to user's body. ■ Grip sensor is not triggered due to triggering distance. ■ Standalone SAR measured at 12 mm spacing for Rear 	KDB 616217 D04
Notebook Mode	Standalone exposure With triggering sensor (DSI = 1)	<ul style="list-style-type: none"> ■ Grip sensor is triggered, when Device was touched to user's body. 	KDB 616217 D04
Tablet Mode	Standalone exposure With Tablet mode Back-off (DSI = 2)	<ul style="list-style-type: none"> ■ Back-off sensor is triggered, when Device was LCD angle ≥ 190 degrees. 	KDB 616217 D04

Note: that the EUT has a proximity sensor to manage extremity exposure, which is represented using DSI = 1; Grip sensor is triggered, when Device was touched to user's body or hands. and is managed as the same exposure condition as extremity exposure at 0 mm; DSI = 0 represents all other exposures which cannot be distinguished, thus, in this case, the maximum 1gSAR among all remaining exposure scenarios or the minimum P_{limit} among all remaining exposure scenarios (i.e., body worn 1gSAR evaluation at 0mm spacing, body worn 1gSAR extremity evaluation at 0mm spacing, body worn 1gSAR extremity evaluation at 0mm spacing for rear surfaces) is used in Smart Transmit feature for time averaging operation. Reported SAR values in Part 1 SAR report are tested at $P_{limit} + \text{tolerance}$. Therefore, 100s(or 60s) average SAR is shown to be ± 1.0 dB from SAR design target.

Based on the selection criteria described in Section 5.2, the radio configurations for the Tx varying transmission test cases listed in Section 6 are:



1. Technologies and bands for time-varying Tx power transmission: The test case 1~3 listed in Table 7-1 are selected to test with the test sequences defined in Section 6.1.1 in both time-varying conducted power measurement and time-varying SAR measurement.
2. Technology and band for change in call test: WCDMA B2 (test case 4 in Table 7-2) having the lowest P_{limit} among all technologies and bands is selected for performing the call drop test in conducted power setup.
3. Technologies and bands for change in technology/band test: Following the guidelines in Section 5.2.3, test case 5 in Table 7-2 is selected for handover test from a technology/band with lowest P_{limit} / within one technology group (WCDMA B4, Ant.0, DSI=2), to a technology/band in the same DSI with lowest P_{limit} within another technology group (LTE B5, Ant.0, DSI=2) in conducted power setup.
4. Technologies and bands for change in DSI: Based on selection criteria in Section 5.2.4, for a given technology and band, test case 6 in Table 7-2 is selected for DSI switch test by establishing a call in WCDMA B4 in Grip Sensor On (i.e., DSI=1), and then handing over to DSI = 2 with Tablet back-off scenario in conducted power setup.

5. Technologies and bands for switch in SAR exposure: Based on selection criteria in Section 5.2.5 Scenario 1, test case 7 in Table 7-2 is selected for SAR exposure switching test in one of the supported simultaneous WWAN transmission scenario, i.e., LTE + Sub6 NR active in the same 100s time window, in conducted power setup.

Note: Due to EUT's antenna configuration and NSA only EN-DC operation, Some parts of test cases were excluded because it was not configurable. The excluded test items are as follows – Antenna change, Time window switch test.

Some parts of switching and EN-DC test cases (#7) were done with modes/bands within the different antenna group..



<p>Eurofins KCTL Co.,Ltd. 65, Sinwon-ro, Yeongtong-gu, Suwon-si, Gyeonggi-do, 16677, Korea TEL: 82-70-5008-1021 FAX: 82-505-299-8311 www.kctl.co.kr</p>	<p>Report No.: KR23-SPF0031-A Page (29) of (80)</p>	 
--	---	---

8. Time-varying Tx power measurement for below 6GHz frequency

8.1 Conducted Measurement Test setup

Legacy Test Setup

The Rohde & Schwarz CMW500 callbox is used in this test. The test setup picture and schematic are shown in Figures 8-2a for measurements with a single antenna of EUT. And in Figures 8-2b for measurements involving antenna switch.

For single antenna measurement, one port (RF1 COM) of the callbox is connected to the RF port of the EUT using a directional coupler. For antenna & technology / technology/band switch measurement, one port (RF1 COM) of the callbox used for signaling two different technologies are connected to a combiner or splitter, which is in turn connected to a directional coupler. The other end of the directional coupler is connected to a splitter to connect to two RF ports of the EUT corresponding to the two antennas of interest. In the setups, power meter is used to tap the directional coupler for measuring the conducted output power of the EUT. For all legacy conducted tests, only RF1 COM port of the callbox is used to communicate with the EUT.

Note that for this EUT, antenna switch test is excluded due to EUT's antenna configuration.

All the path losses from RF port of EUT to the callbox RF COM port and to the power meter are calibrated and automatically entered as offsets in the callbox and the power meter via test scripts on the PC used to control callbox and power meter.

LTE+Sub6 NR test setup:

The MT8000A, MT8821C callbox were used in this test. The test setup schematic is the same as the Legacy Test Setup shown in Figure 8-2a. Each port of the callbox is connected to the RF port of the DUT using a directional coupler. In the setup, the power meter is used to tap the directional coupler for measuring the conducted output power of the DUT.

Note: on this EUT, LTE conducted port and Sub6 NR conducted port are separated on test setup. each ports are connected via directional coupler separately, as shown in below Figures 8-2c.

WCDMA / LTE test setup using The Rohde & Schwarz CMW500 callbox
The Rohde & Schwarz CMW500 callbox is used in this test.

Table 8-1a: Conducted measurement test setup (legacy)

Test setup Schematic	Test item(s)	Description(s)	Test setup photo
Figure 8-1(a)	Time-varying Tx power transmission test (section 3.3.1)	Single antenna measurements, one port (RF1 COM) of callbox	A.1
	Change in Call test (Section 3.3.2)		
	Change in DSI test (Section 3.3.5)		
Figure 8-1(a)	Change in Tech / Band test (section)	Two different tech measurements, one port (RF1 COM) of callbox	A.1

Table 8-1b: Radiated measurement test setup (legacy)

Test setup Schematic	Test item(s)	Description(s)	Test setup photo
Figure 8-2(a)	Time-varying Tx power transmission test (section 3.3.1)	Single antenna measurements, one port (RF1 COM) of callbox	A.3

LTE + Sub6 NR(NSA mode) test setup using The MT8000A, MT8821C callbox
The MT8000A, MT8821C callbox are used in this test.

Table 8-1c: Conducted measurement test setup (LTE + Sub6 NR NSA)

Test setup Schematic	Test item(s)	Description(s)	Test setup photo
Figure 8-1(b)	Time-varying Tx power transmission test (section 3.3.1) -NSA mode-	Single tech measurements, two port (RF1 & RF8 COM) of callbox	A.2
Figure 8-1(b)	SAR exposure switch test (Section 3.3.7)	two different tech measurements, two port (RF1 & RF8 COM) of callbox	A.2

Table 8-1d: Radiated measurement test setup (LTE + Sub6 NR NSA)

Test setup Schematic	Test item(s)	Description(s)	Test setup photo
Figure 8-2(b)	Time-varying Tx power transmission test (section 3.3.1) -NSA mode-	Single tech measurements, two port (RF1 & RF8 COM) of callbox	A.4

All the path losses from RF port of DUT to the callbox RF COM port and to the power meter are calibrated and automatically entered as offsets in the callbox and the power meter via test scripts on the PC used to control callbox and power meter.

Setup photos of Test setup Schematic are list in Appendix A.

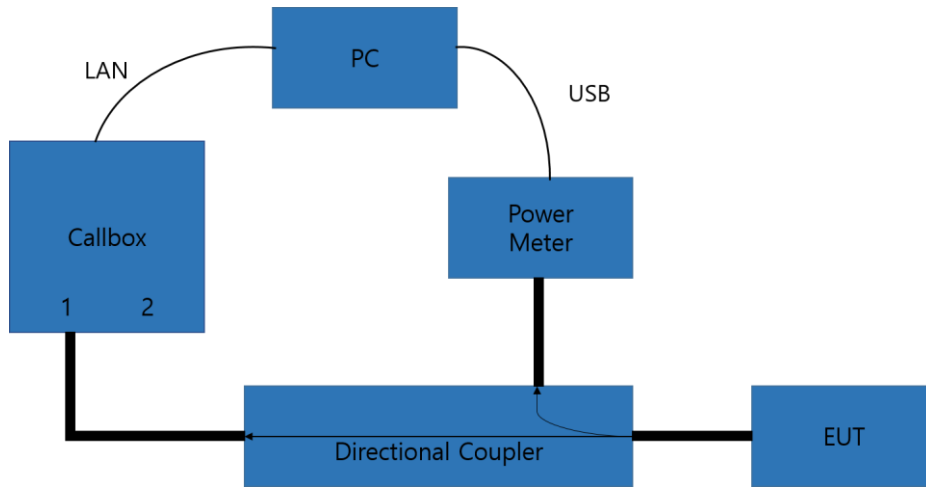

8-1a

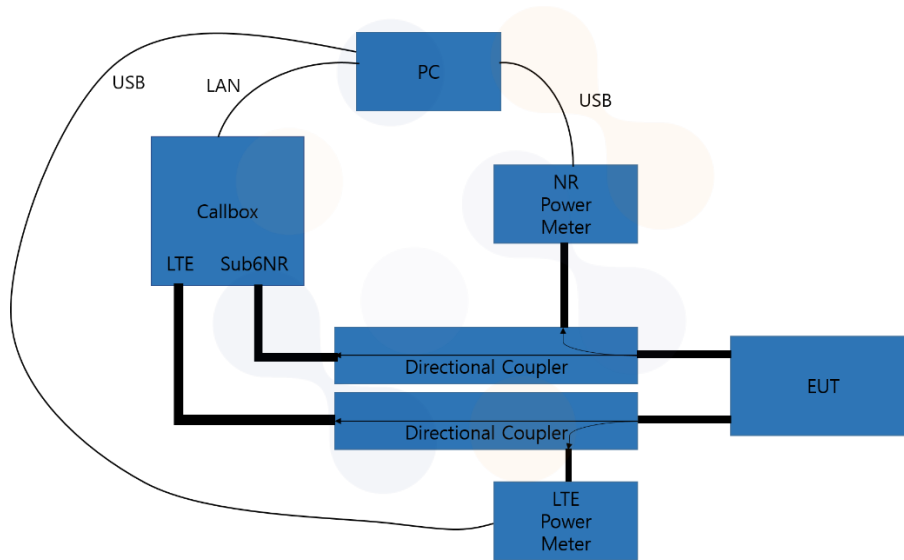

8-1b

Figure 8-1

Conducted power measurement setup

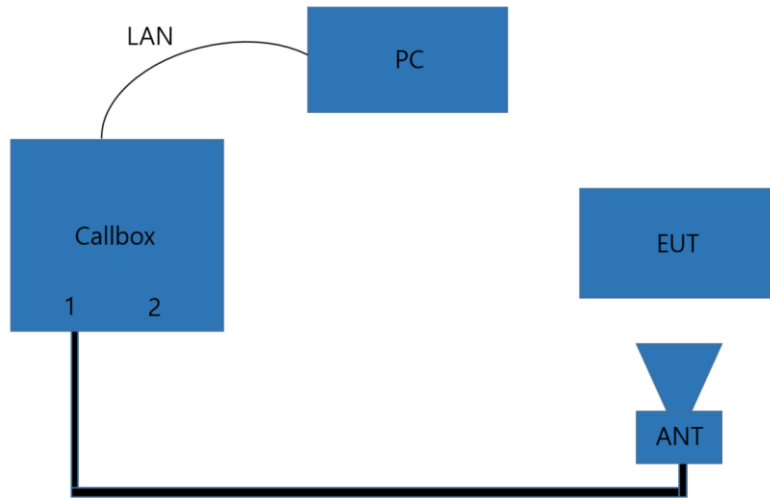

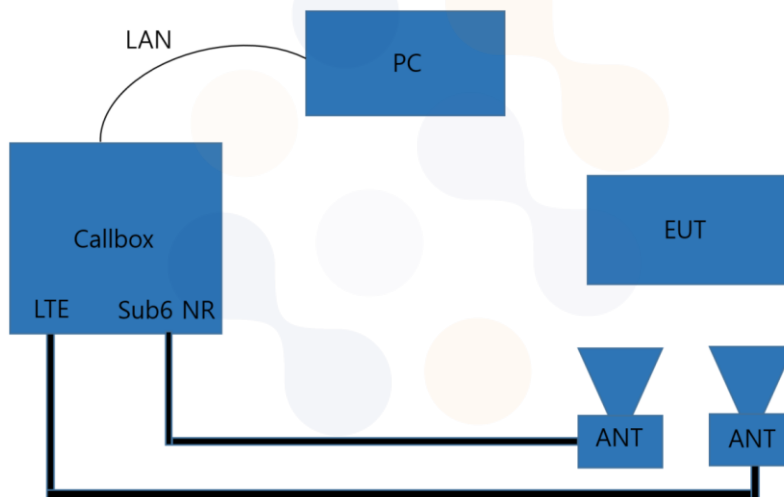

8-2a



8-2b

Figure 8-2
Radiated power measurement setup

<p>Eurofins KCTL Co.,Ltd. 65, Sinwon-ro, Yeongtong-gu, Suwon-si, Gyeonggi-do, 16677, Korea TEL: 82-70-5008-1021 FAX: 82-505-299-8311 www.kctl.co.kr</p>	<p>Report No.: KR23-SPF0031-A Page (34) of (80)</p>	 
--	--	---

Both the callbox and power meter are connected to the PC using LAN / USB cables.

Two test scripts are custom made for automation, and the test duration set in the test scripts is 500 seconds.

For time-varying Tx power measurement, the PC runs the 1st test script to send LAN commands to control the callbox's requested power versus time, while at the same time to record the conducted power measured at EUT RF port using the power meter. The commands sent to the callbox to request power are:

- 0dBm for 100 seconds
- test sequence 1 or test sequence 2 (defined in Section 5.1 and generated in Section 6.5.1), for 360 seconds
- stay at the last power level of test sequence 1 or test sequence 2 for the remaining time.

Power meter readings are periodically recorded every 100ms. A running average of this measured Tx power over 100 seconds is performed in the post-data processing to determine the 100s-time averaged power.

For call drop, technology/band/antenna switch, and DSI switch tests, after the call is established, the callbox is set to request the EUT's Tx power at 0dBm for 100 seconds while simultaneously starting the 2nd test script runs at the same time to start recording the Tx power measured at EUT RF port using the power meter. After the initial 100 seconds since starting the Tx power recording, the callbox is set to request maximum power from the EUT for the rest of the test.

Note that the technology/band/antenna switch or DSI switch is manually performed when the Tx power of EUT is at $P_{reserve}$ level.

See Section 6.1 for detailed technology/band/antenna switch test and DSI switch test.

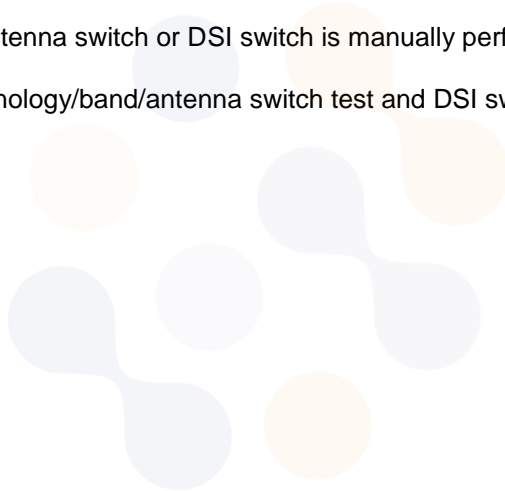

8.2 P_{limit} and P_{max} measurement results

This measured P_{limit} for all the selected radio configurations given in Table 7-2 are listed in below Table 8-1. P_{max} was also measured for radio configurations selected for testing time-varying Tx power transmission scenarios in order to generate test sequences following the test procedures in Section 6.1.

Table 8-1 : Measured P_{limit} and P_{max} of selected radio configurations
Note: the device uncertainty of P_{max} is UMTS(+1.0dB/-3.0dB), LTE(+2.0dB/-2.0dB)
Sub6 NR(+2.0dB/-3.0dB) as provided by manufacturer.

Test Case	Test Scenario	Tech	Band	Ant.	DSI	Frequency [MHz]	RB/RB Offset/Band width [MHz]	Mode	SAR Exposure Scenario	Part 1 Worst Case Measured SAR at P_{limit} (W/kg)	EFS P_{limit} [dBm]	Measured P_{limit} [dBm]	Tune-up [dBm]	Measured P_{max} (dBm)
1		UMTS	2	Ant.0	2	1 907.6	-	RMC	Tablet, Rear, 0mm	0.737	14	14.8	24	24.4
		UMTS	5	Ant.0	2	836.6	-	RMC	Tablet, Rear, 0mm	0.961	20	20.5	24	24.2
2	Time-varying Tx power transmission	LTE	B5	Ant.0	2	836.5	25 / 25 / 10	QPSK	Tablet, Rear, 0mm	0.999	19	20.8	23	23.6
		LTE	B66	Ant.0	2	1770	1 / 0 / 20	QPSK	Tablet, Rear, 0mm	0.694	13	14.6	23	23.3
3		Sub6 NR	n5	Ant.0	2	836.5	100 / 0 / 20	DFT-S-OFDM QPSK	Tablet, Rear, 0mm	1.24	19	20.4	23	24.6
		Sub6 NR	n66	Ant.0	2	1745	1 / 158 / 30	DFT-S-OFDM QPSK	Tablet, Rear, 0mm	0.894	13	14.8	23	24.6
4	Change in Call	UMTS	2	Ant.0	2	1 907.6	-	RMC	Tablet, Rear, 0mm	0.737	14	14.8	24	24.2
5	Tech/Band Switch	UMTS	4	Ant.0	2	1 732.4	-	RMC	Tablet, Rear, 0mm	0.516	14	14.9	24	24.3
		LTE	B5	Ant.0	2	836.5	25 / 25 / 10	QPSK	Tablet, Rear, 0mm	0.999	19	20.8	23	24.2
6	DSI Switch	UMTS	2	Ant.0	1	1 852.4	-	RMC	Grip Sensor On, Rear, 0mm	0.954	17	17.7	24	24.2
					2		-	RMC	Tablet, Rear, 0mm	0.737	14	14.8	24	24.2
7	SAR1 vs SAR2	LTE	B5	Ant.0	2	836.5	25 / 25 / 10	QPSK	Grip Sensor On, Rear, 0mm	0.999	19	20.8	23	23.6
		Sub6 NR	n66	Ant.2	2	1745	1 / 1 / 30	CP-OFDM QPSK	Grip Sensor On, Rear, 0mm	0.537	13	14.8	23	24.6

Notes:

Note that for this EUT, antenna switch test and time window switch test are excluded due to EUT's antenna configuration and NR NSA only operations.

8.3 Time-varying Tx power measurement results

The measurement setup is shown in Figures 8-2(a), 8-2(b) and 8-2(c). The purpose of the time-varying Tx power measurement is to demonstrate the effectiveness of power limiting enforcement and that the time-averaged Tx power when represented in time-averaged 1gSAR or 10gSAR values does not exceed FCC limit as shown in Eq. (1a) and (1b), rewritten below:

$$1g_or_10gSAR(t) = \frac{\text{conducted_Tx_power}(t)}{\text{conducted_Tx_power_P}_{limit}} * 1g_or_10gSAR_P_{limit} \quad (1a)$$

$$\frac{\frac{1}{T_{SAR}} \int_{t-T_{SAR}}^t 1g_or_10gSAR(t) dt}{FCC\ SAR\ limit} \leq 1 \quad (1b)$$

where, $\text{conducted_Tx_Power}(t)$, $\text{conducted_Tx_P}_{limit}$, and $1g_or_10gSAR_P_{limit}$ correspond to the measured instantaneous conducted Tx power, measured conducted Tx power at P_{limit} , and measured 1gSAR and 10gSAR values at P_{limit} reported in Part 1 test (listed in Table 7-2 of this report as well).

Following the test procedure in Section 5.3, the conducted Tx power measurement for all selected configurations are reported in this section. In all the conducted Tx power plots, the dotted line represents the requested power by callbox (test sequence 1 or test sequence 2), the blue curve represents the instantaneous conducted Tx power measured using power meter, the green curve represents time-averaged power and red line represents the conducted power limit that corresponds to FCC limit of 1.6 W/kg for 1gSAR or 4.0 W/kg for 10gSAR.

Similarly, in all the 1g or 10gSAR plots (when converted using Eq. (1a)), the green curve represents the 100s time averaged 1gSAR or 10gSAR value calculated based on instantaneous 1gSAR or 10gSAR; and the red line limit represents the FCC limit of 1.6 W/kg for 1gSAR or 4.0 W/kg for 10gSAR.

Time-varying Tx power measurements were conducted on test cases 1) ~ 3) in Table 7-2, by generating test sequence 1 and test sequence 2 given in Appendix A using measured P_{limit} and measured P_{max} for each of these test cases. Measurement results for test cases 1) ~ 3) are given in Sections 8.3.1 - 8.3.3.

8.3.1 WCDMA Band 2 (test case 1 in Table 7-2)

Conducted Plot No. 1

Test result for test sequence 1:

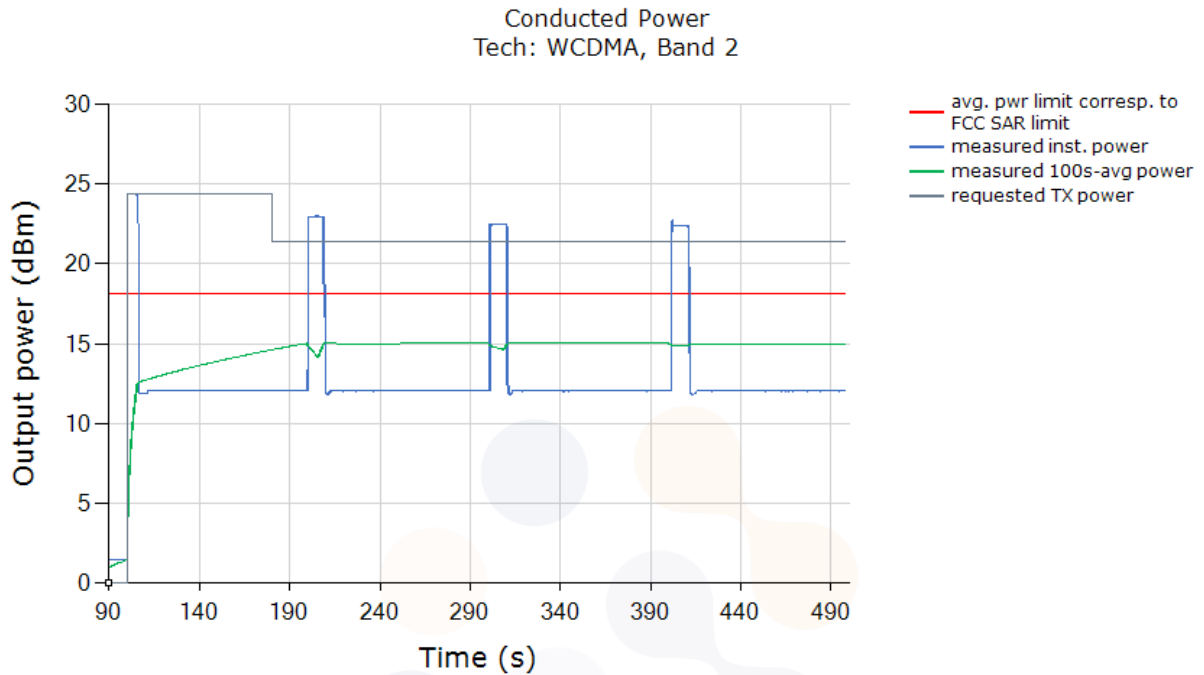

FCC 1g SAR Limit [W/kg]	1.6 W/kg
Max 100s-time averaged 1g SAR (green curve)	0.777 W/kg
Validated: Max time averaged SAR (green curve) is within 1dB device uncertainty of measured SAR at P_{limit} (last column in Table 7-2)	

Conducted Plot No. 2

Test result for test sequence 2:

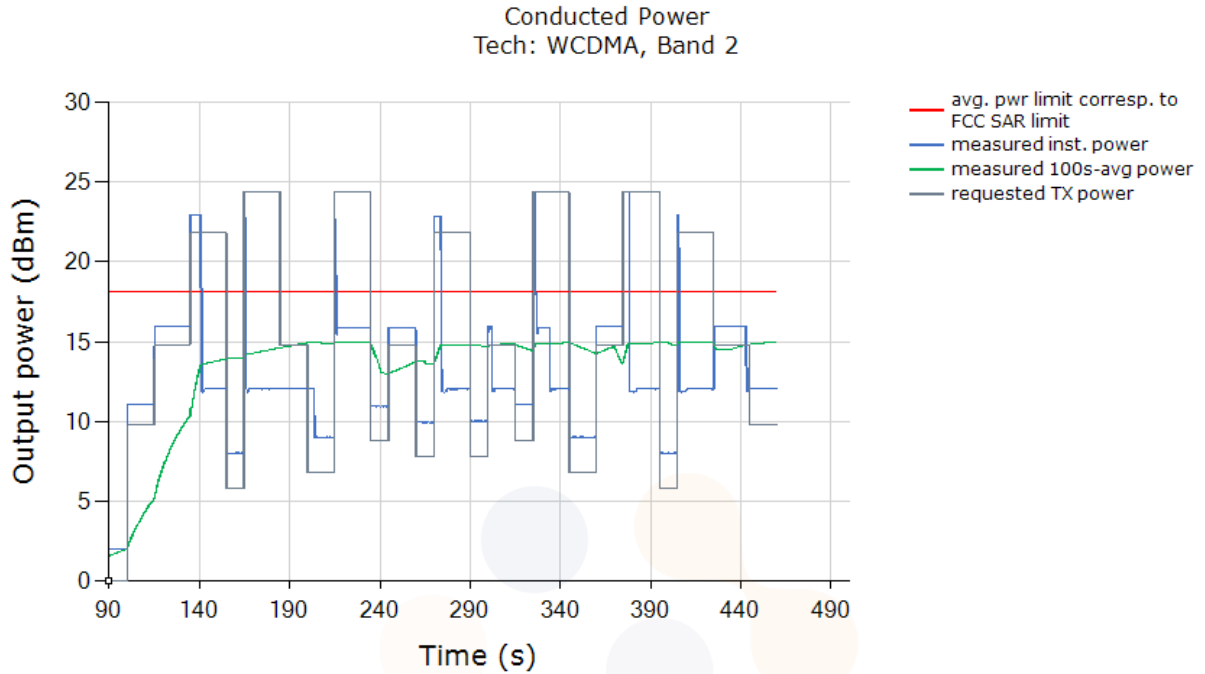

FCC 1g SAR Limit [W/kg]	1.6 W/kg
Max 100s-time averaged 1g SAR (green curve)	0.711 W/kg
Validated: Max time averaged SAR (green curve) is within 1dB device uncertainty of measured SAR at P_{limit} (last column in Table 7-2)	

8.3.2 WCDMA Band 5 (test case 1 in Table 7-2)

Conducted Plot No. 3

Test result for test sequence 1:

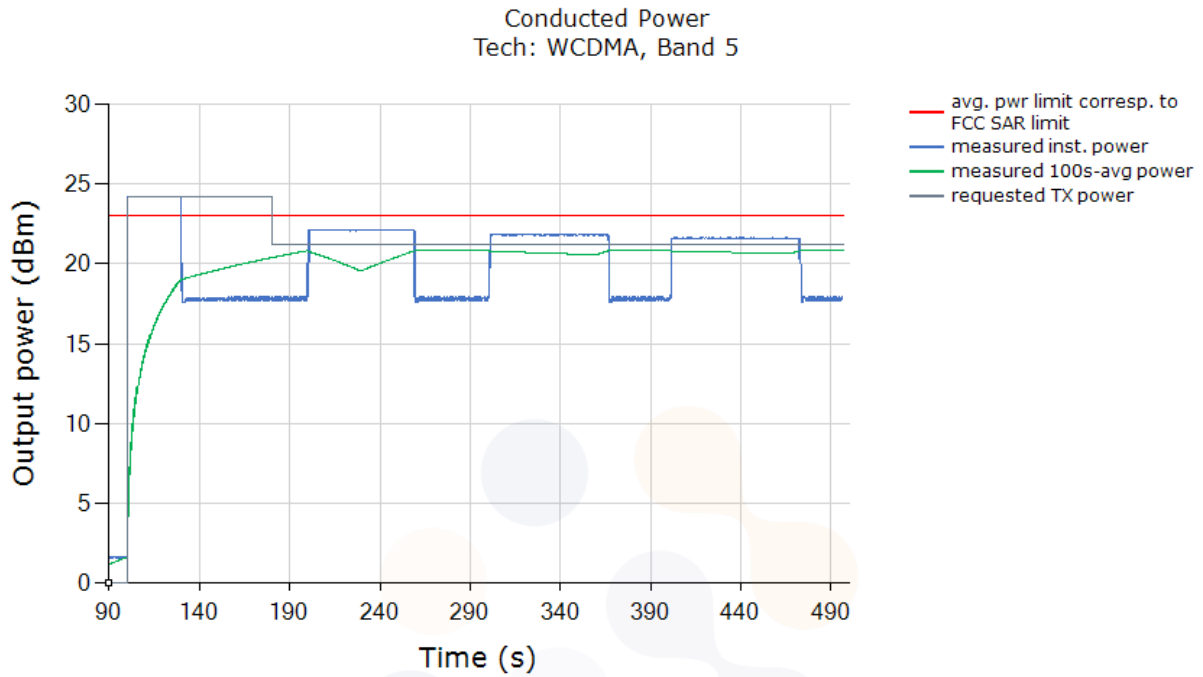

FCC 1g SAR Limit [W/kg]	1.6 W/kg
Max 100s-time averaged 1g SAR (green curve)	0.966 W/kg
Validated: Max time averaged SAR (green curve) is within 1dB device uncertainty of measured SAR at P_{limit} (last column in Table 7-2)	

Conducted Plot No. 4

Test result for test sequence 2:

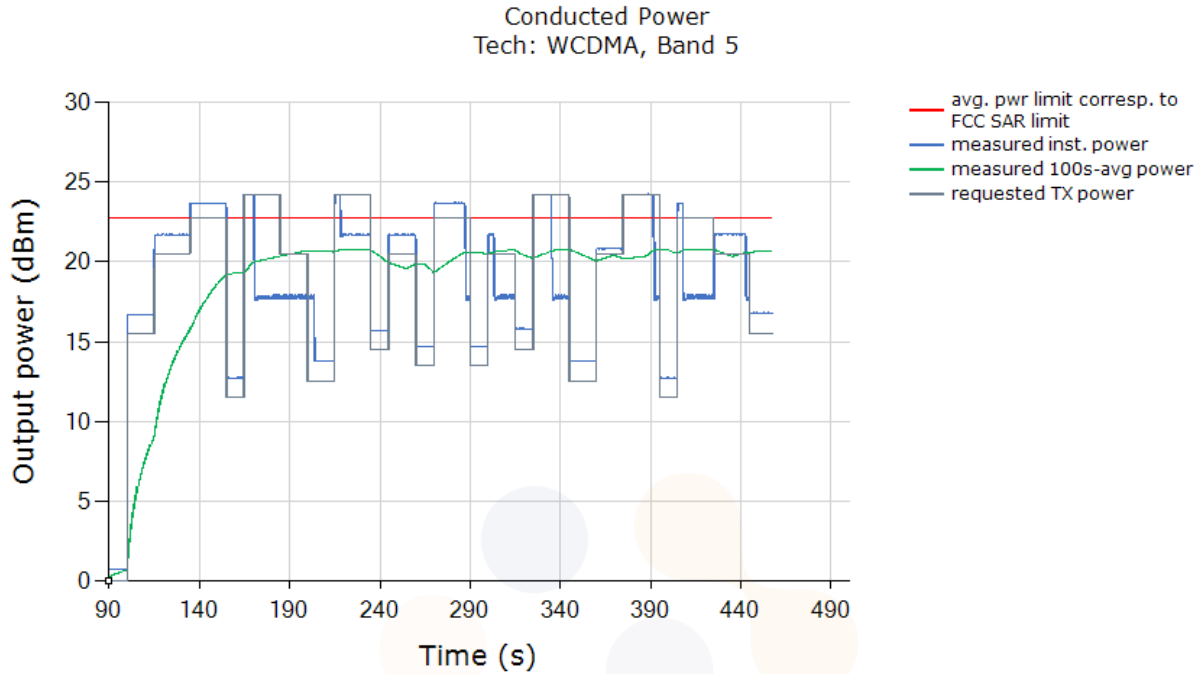

FCC 1g SAR Limit [W/kg]	1.6 W/kg
Max 100s-time averaged 1g SAR (green curve)	1.030 W/kg
Validated: Max time averaged SAR (green curve) is within 1dB device uncertainty of measured SAR at P_{limit} (last column in Table 7-2)	

8.3.3 LTE Band 5 (test case 2 in Table 7-2)

Conducted Plot No. 5

Test result for test sequence 1:

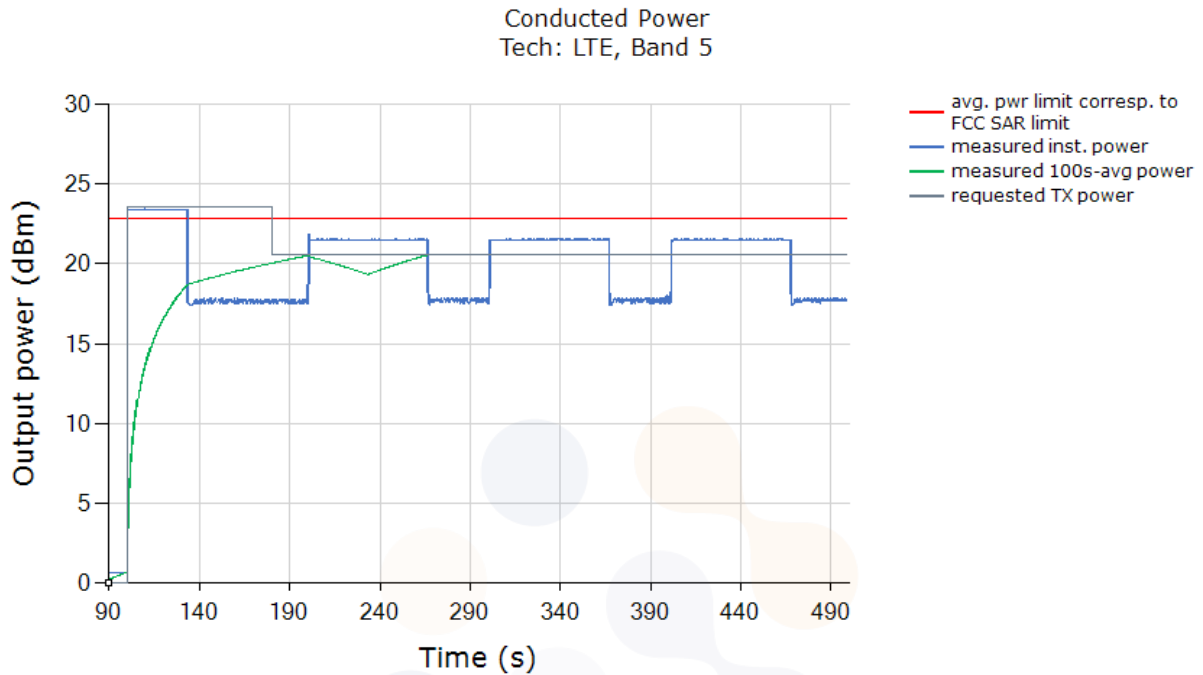

FCC 1g SAR Limit [W/kg]	1.6 W/kg
Max 100s-time averaged 1g SAR (green curve)	0.946 W/kg
Validated: Max time averaged SAR (green curve) is within 1dB device uncertainty of measured SAR at P_{limit} (last column in Table 7-2)	

Conducted Plot No. 6

Test result for test sequence 2:

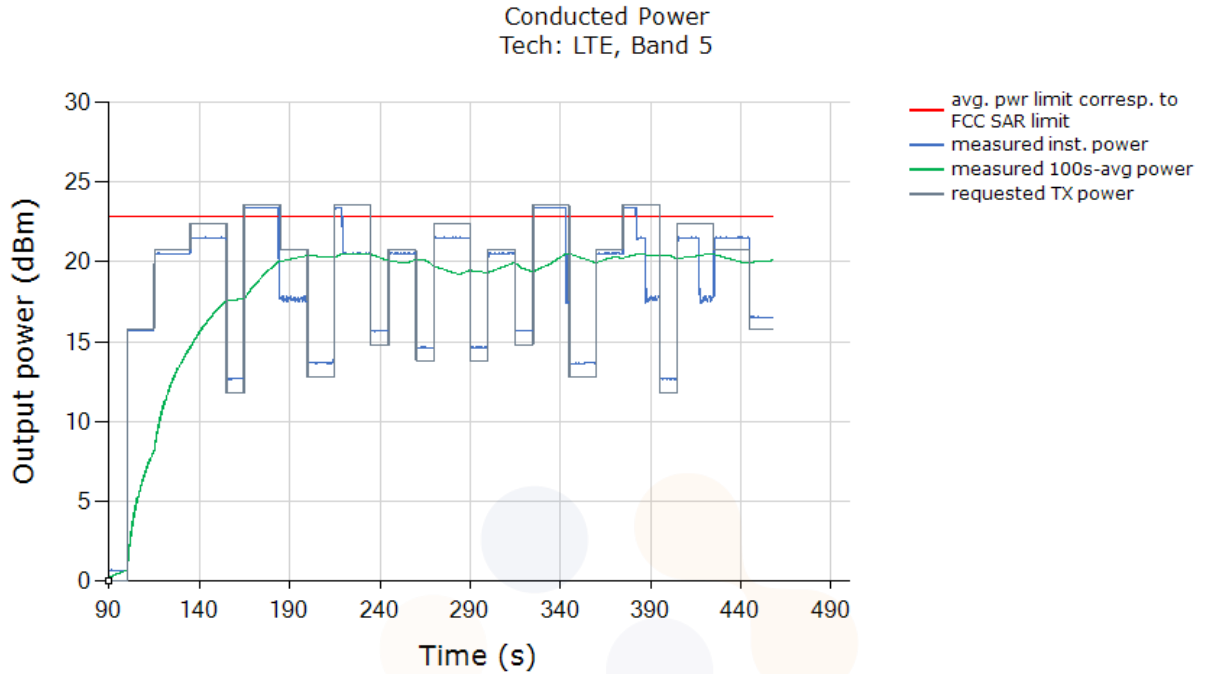

FCC 1g SAR Limit [W/kg]	1.6 W/kg
Max 100s-time averaged 1g SAR (green curve)	0.933 W/kg
Validated: Max time averaged SAR (green curve) is within 1dB device uncertainty of measured SAR at P_{limit} (last column in Table 7-2)	

8.3.4 LTE Band 66 (test case 1 in Table 7-2)

Conducted Plot No. 7

Test result for test sequence 1:

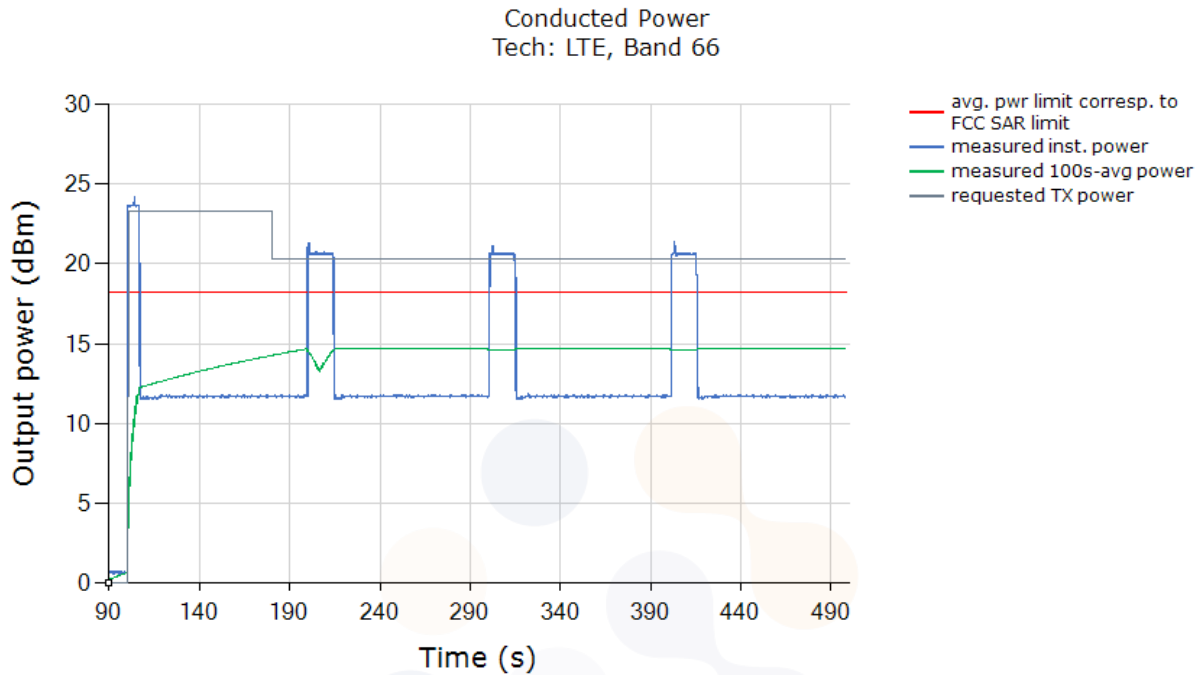

FCC 1g SAR Limit [W/kg]	1.6 W/kg
Max 100s-time averaged 1g SAR (green curve)	0.706 W/kg
Validated: Max time averaged SAR (green curve) is within 1dB device uncertainty of measured SAR at P_{limit} (last column in Table 7-2)	

Conducted Plot No. 8

Test result for test sequence 2:

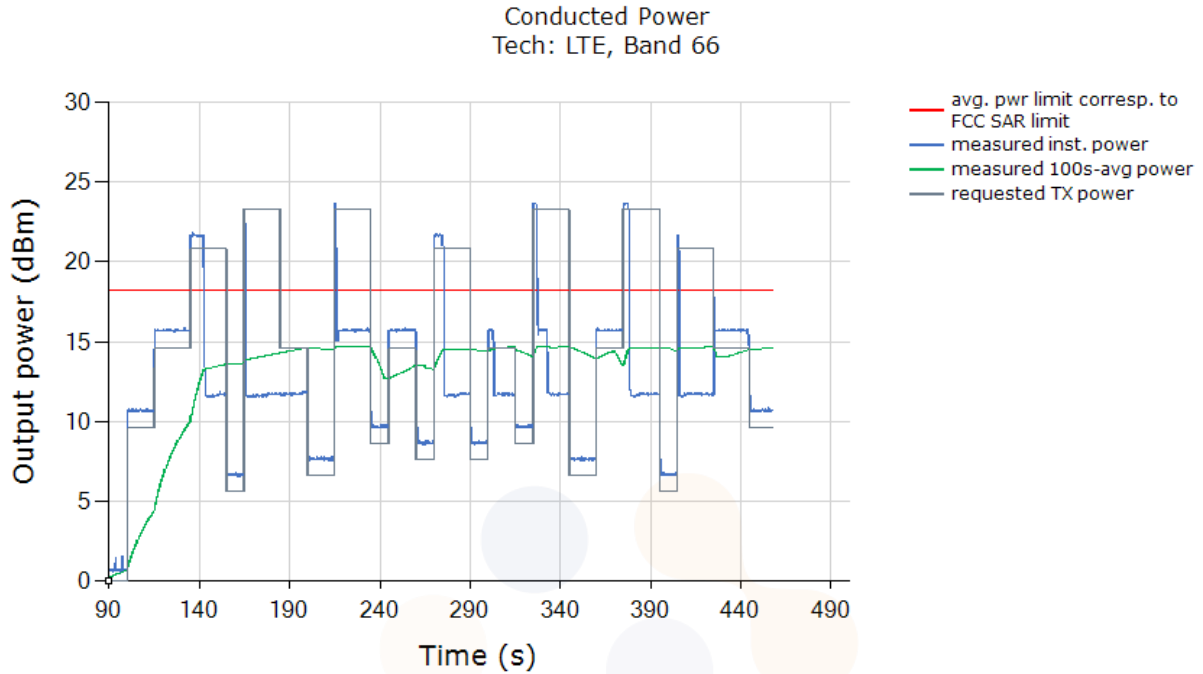

FCC 1g SAR Limit [W/kg]	1.6 W/kg
Max 100s-time averaged 1g SAR (green curve)	0.711 W/kg
Validated: Max time averaged SAR (green curve) is within 1dB device uncertainty of measured SAR at P_{limit} (last column in Table 7-2)	

8.3.5 Sub6 NR n5 (test case 3 in Table 7-2)

Conducted Plot No. 9

Test result for test sequence 1:

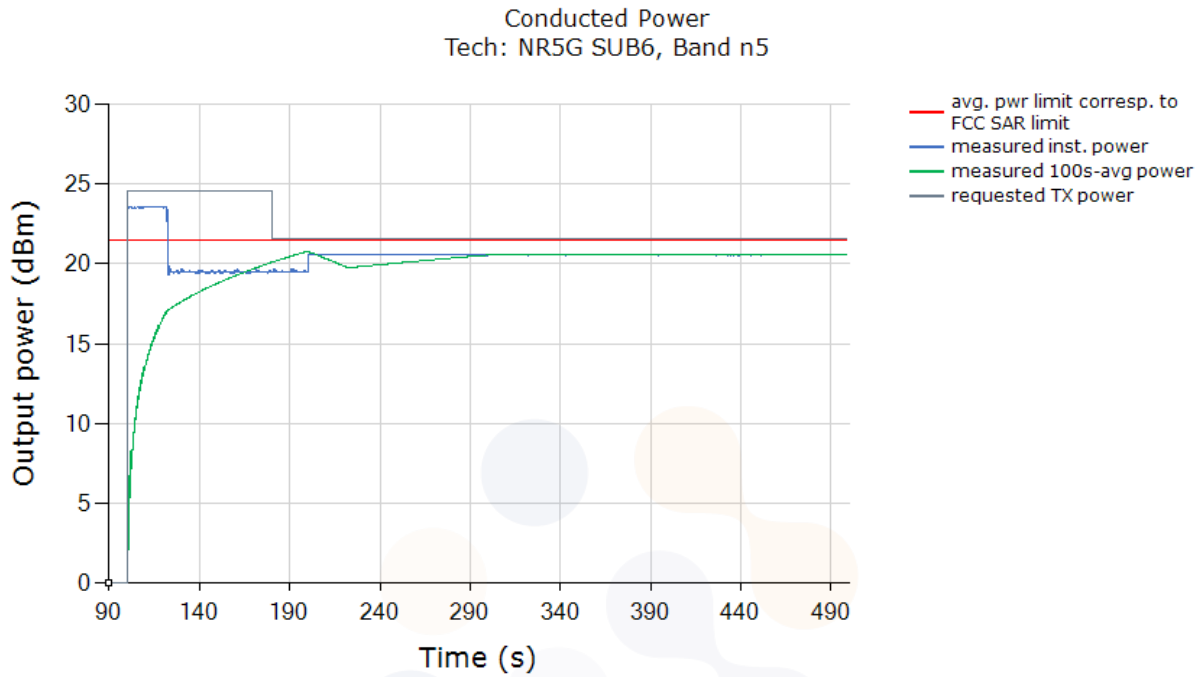

FCC 1g SAR Limit [W/kg]	1.6 W/kg
Max 100s-time averaged 1g SAR (green curve)	1.351 W/kg
Validated: Max time averaged SAR (green curve) is within 1dB device uncertainty of measured SAR at P_{limit} (last column in Table 7-2)	

Conducted Plot No. 10

Test result for test sequence 2:

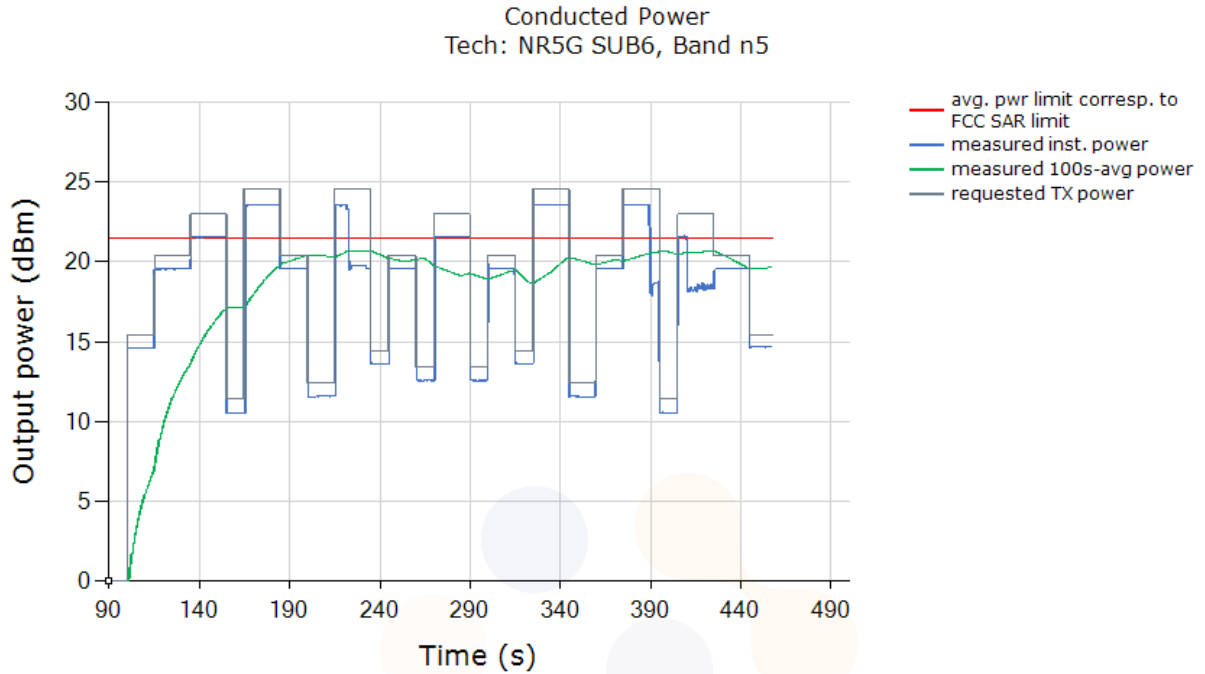

FCC 1g SAR Limit [W/kg]	1.6 W/kg
Max 100s-time averaged 1g SAR (green curve)	1.334 W/kg
Validated: Max time averaged SAR (green curve) is within 1dB device uncertainty of measured SAR at P_{limit} (last column in Table 7-2)	

8.3.6 Sub6 NR n66 (test case 3 in Table 7-2)

Conducted Plot No. 11

Test result for test sequence 1:

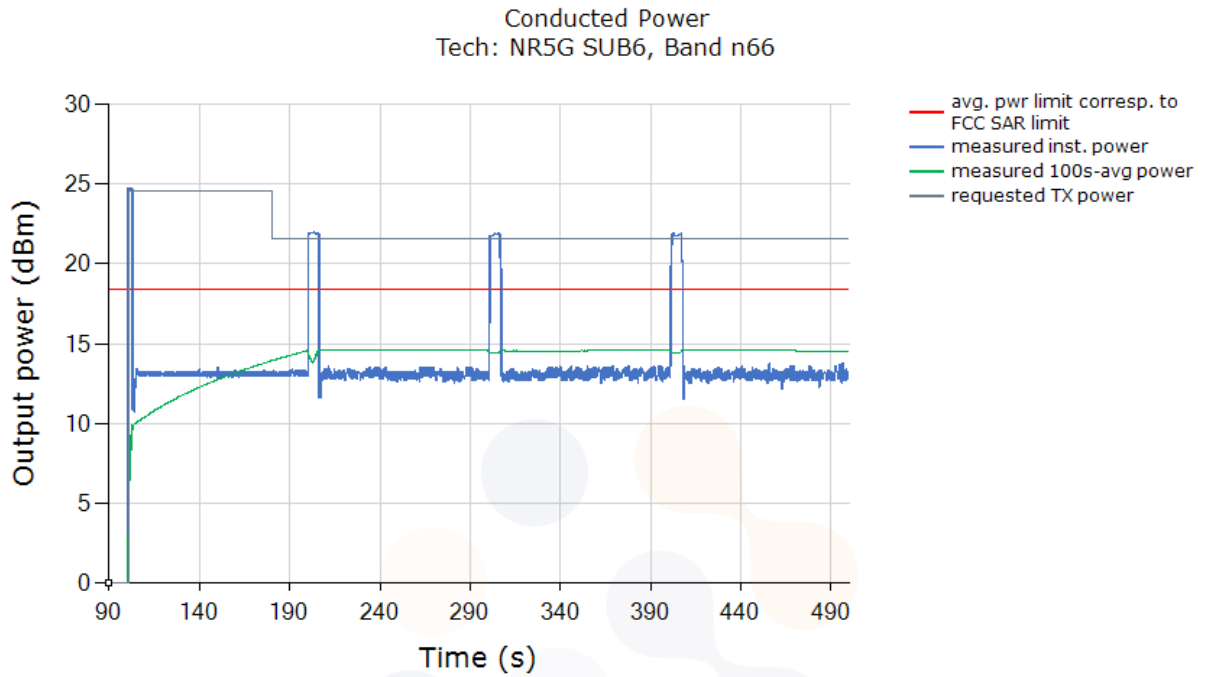

FCC 1g SAR Limit [W/kg]	1.6 W/kg
Max 100s-time averaged 1g SAR (green curve)	0.664 W/kg
Validated: Max time averaged SAR (green curve) is within 1dB device uncertainty of measured SAR at P_{limit} (last column in Table 7-2)	

Conducted Plot No. 12

Test result for test sequence 2:

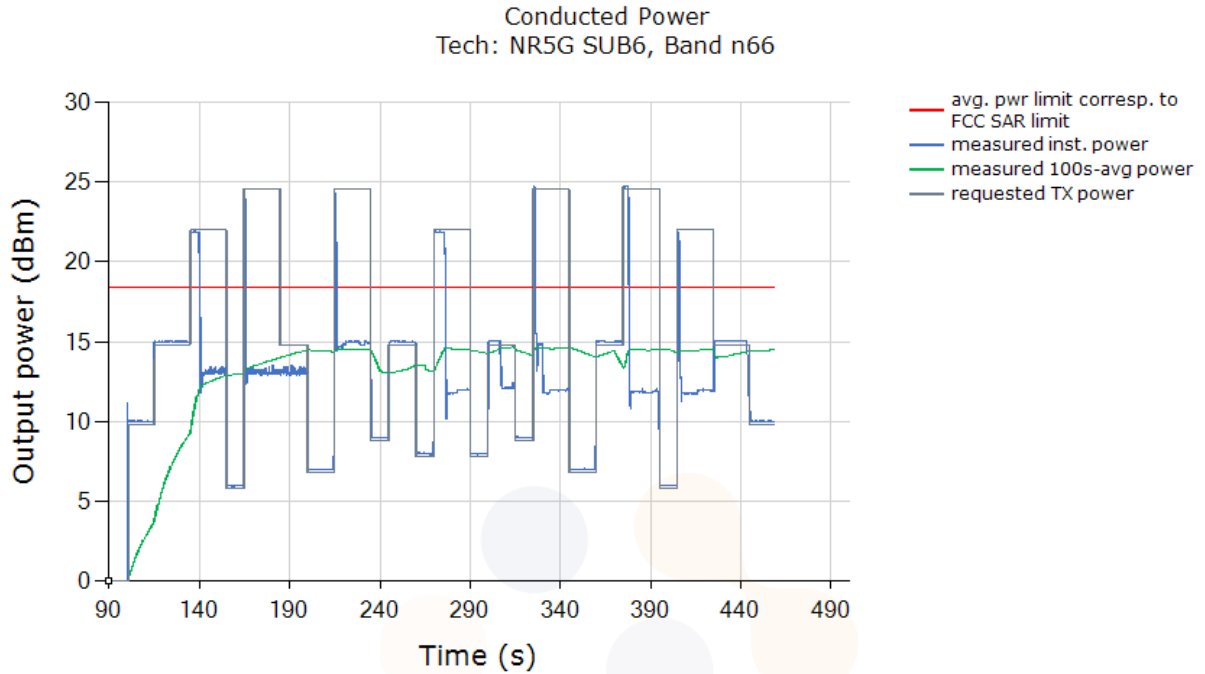

FCC 1g SAR Limit [W/kg]	1.6 W/kg
Max 100s-time averaged 1g SAR (green curve)	0.676 W/kg
Validated: Max time averaged SAR (green curve) is within 1dB device uncertainty of measured SAR at P_{limit} (last column in Table 7-2)	

8.4 Change in Call Test results (test case 4 in Table 7-2)

This test was measured with WCDMA B2, DSI=2, and with callbox requesting maximum power. The call drop was manually performed when the EUT is transmitting at *Preserve* level as shown in the plot below (dotted black region). The measurement setup is shown in Figure 8-1(a) and (c). The detailed test procedure is described in Section 6.1.2.

Conducted Plot No. 13

Call drop test result:

Plot 1: Measured Tx power (dBm) versus time shows that the transmitting power kept the same *Preserve* level of WCDMA B2 after the call was re-established:

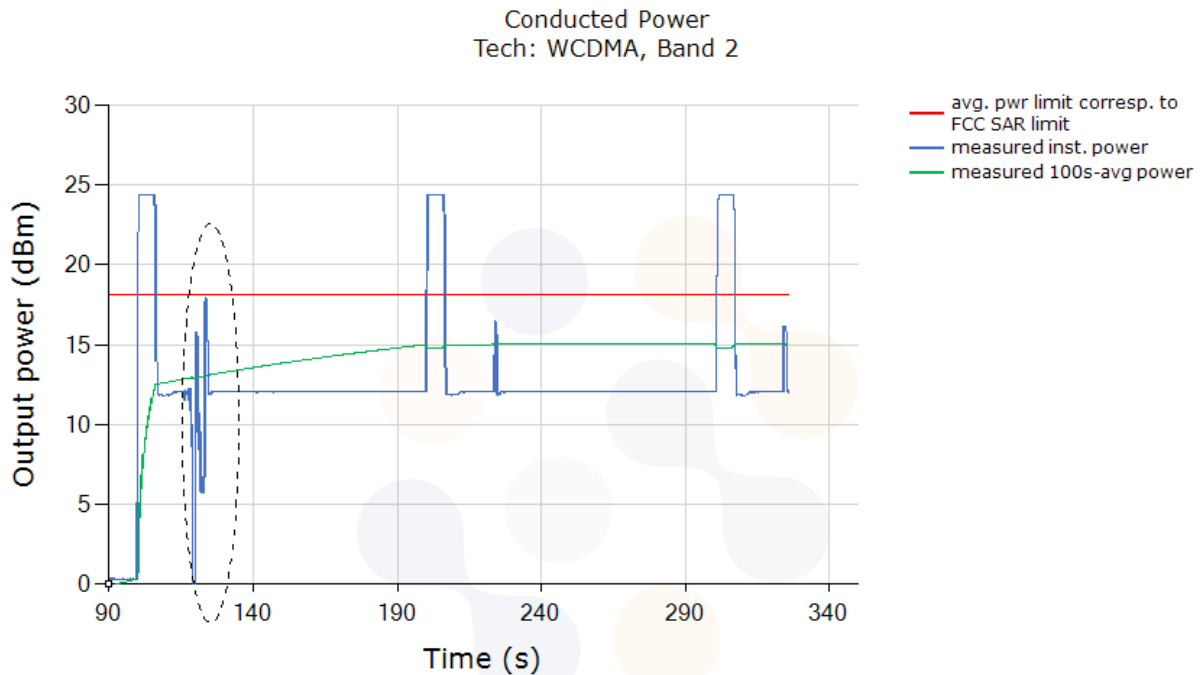

Note: The power level after the change in call kept the same *Preserve* level of WCDMA B2. The conducted power plot shows expected Tx transition.

Conducted Plot No. 14

Plot 2: Above time-averaged conducted Tx power is converted/calculated into time-averaged 1g SAR using Equation (1a) and plotted below to demonstrate that the time-averaged 1g SAR versus time does not exceed the FCC limit of 1.6 W/kg for 1g SAR:

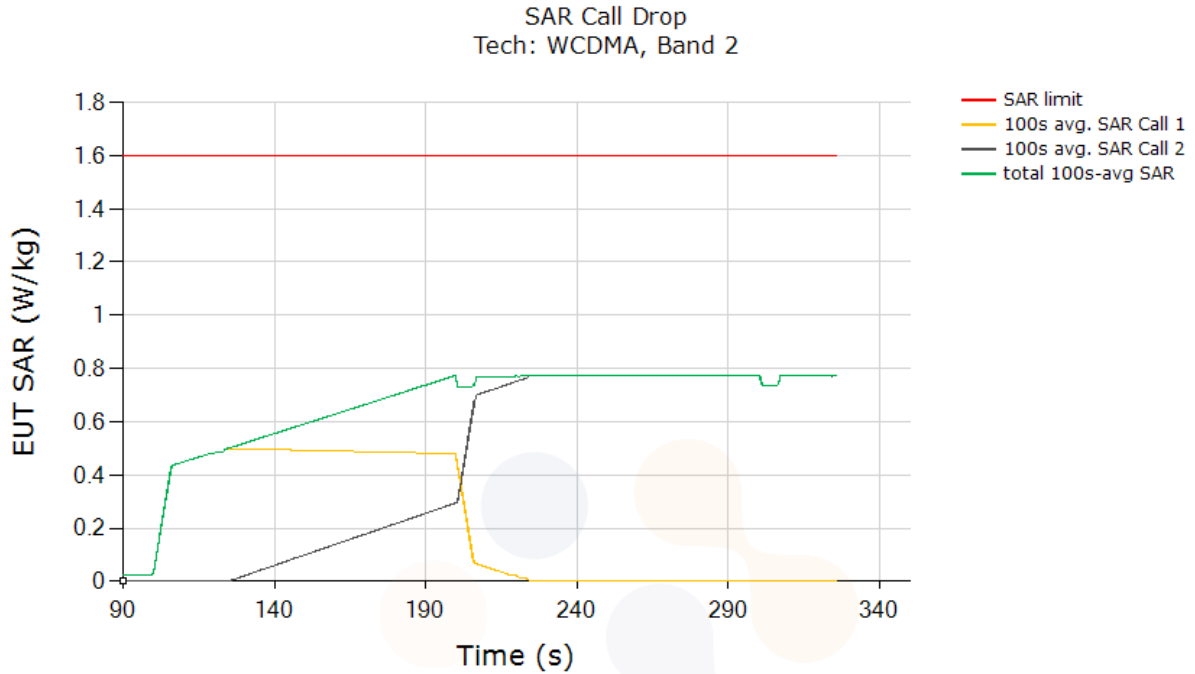

FCC 1g SAR Limit [W/kg]	1.6 W/kg
Max 100s-time averaged 1g SAR (green curve)	0.775 W/kg
Validated: The test result validated the continuity of power limiting in call change scenario.	

8.5 Change in technology/band test results (test case 5 in Table 7-2)

Since the EUT does not support the band supporting the 60-second time window, the antenna change test were integrated into this test case.

This test was conducted with callbox requesting maximum power, and with antenna / technology switch from WCDMA B4, Ant.0, DSI =2 (Tablet back-off) to LTE B5, Ant.0, DSI =2 (Tablet back-off). Following procedure detailed in Section 6.1.3 and Section 6.1.6, and using the measurement setup shown in Figure 8-1(b) the antenna/technology/band switch was performed when the EUT is transmitting at *Preserve* level as shown in the plot below (dotted black region).

Conducted Plot No. 15

Test result for change in technology/band:

Plot 1: Measured Tx power (dBm) versus time shows that the transmitting power changed from WCDMA B4, Ant.0, DSI =2 *Preserve* level to LTE B5, Ant.0, DSI =2 *Preserve* level (within 1dB device uncertainty):

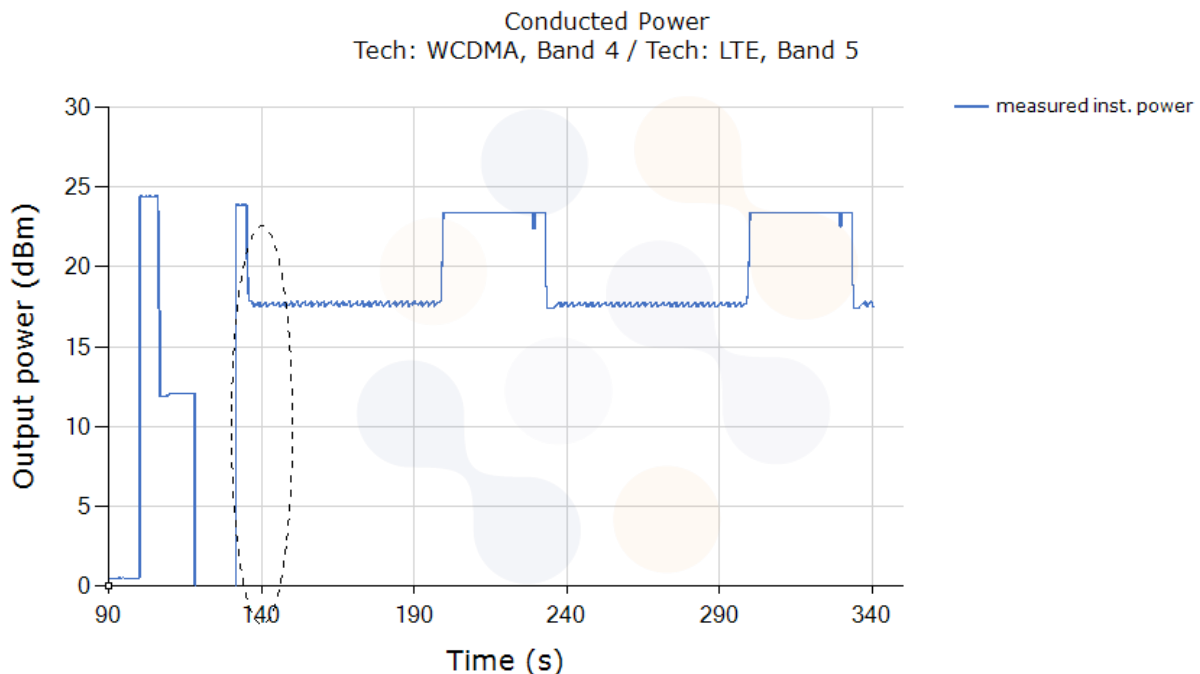

Note: As per Part 1 report, *Reserve_power_margin*= 3dB. Based on Table 7-1, EFS $P_{limit} = 14\text{dBm}$ for WCDMA B4 (DSI=2), and EFS $P_{limit} = 20\text{ dBm}$ for LTE B5 (DSI=2), it can be seen from above plot that the difference in *Preserve* (= $P_{limit} - 3\text{dB Reserve_power_margin}$) power level corresponds to the expected difference in P_{limit} levels of 1dB (within 1dB of radio design related uncertainty). Therefore, the conducted power plot shows expected transition in Tx power.

Conducted Plot No. 16

Plot 2: All the time-averaged conducted Tx power measurement results were converted into time averaged normalized SAR values using Equation (6a), (6b) and (6c), and plotted below to demonstrate that the time-averaged normalized SAR versus time does not exceed the normalized FCC limit of 1.0:

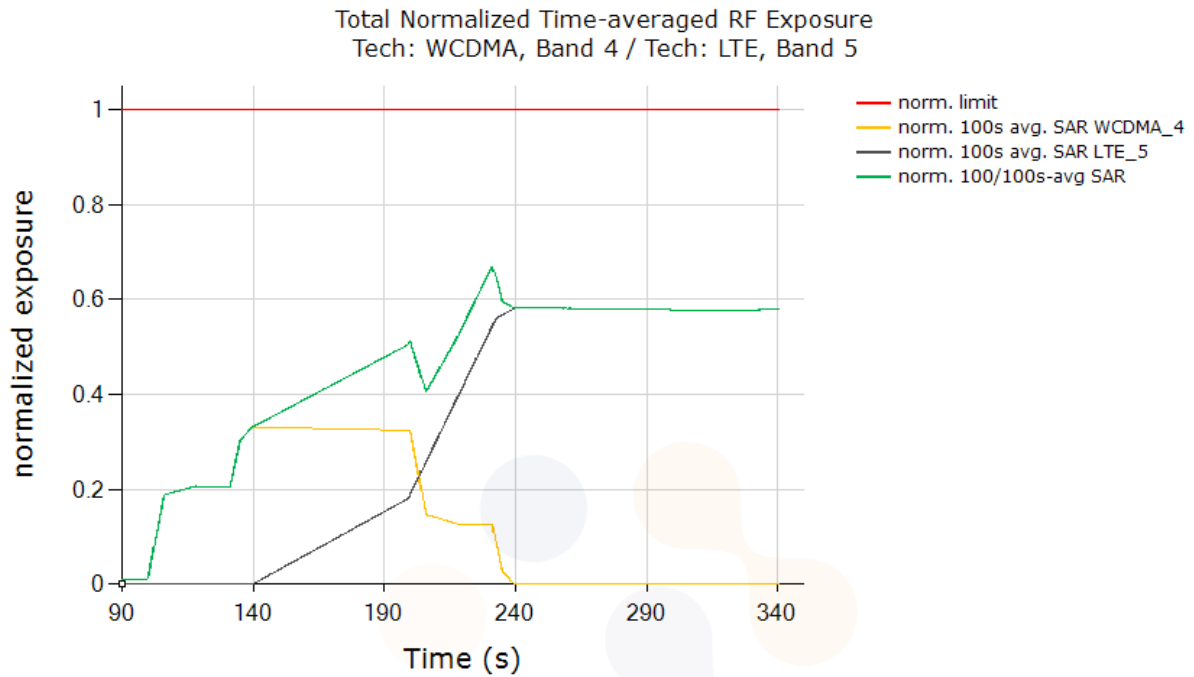

FCC nomarized SAR Limit [W/kg]	1.0 W/kg
Max Norm. Total time-avg. 1g SAR (green curve)	0.669 W/kg
Validated: The test result validated the continuity of power limiting in technology/band switch scenario	

8.6 Change in DSI test results (test case 6 in Table 7-2)

This test was conducted with callbox requesting maximum power, and with DSI switch from WCDMA B2, DSI = 1 (Grip sensor On) to DSI = 2 (Tablet back-off). Following procedure detailed in Section 6.1.5 using the measurement setup shown in Figure 8-1(a) and (c), the DSI switch was performed when the EUT is transmitting at *Preserve* level as shown in the plot below (dotted black circle).

Conducted Plot No.17

Test result for change in DSI:

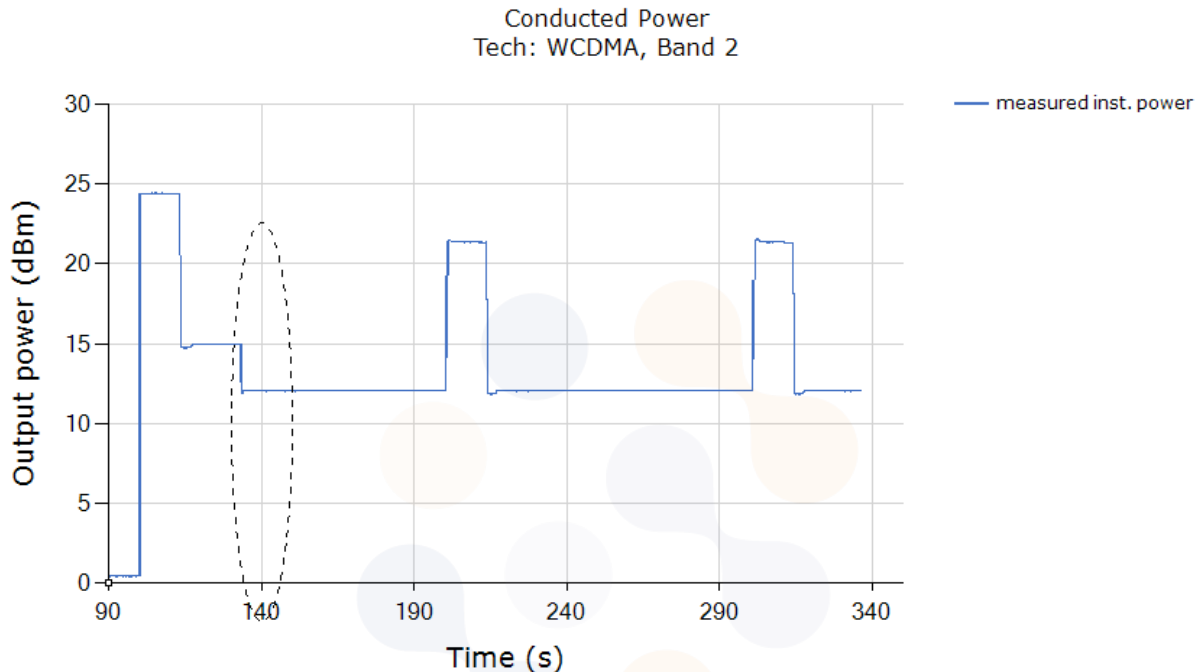

Plot 1: Measured Tx power (dBm) versus time shows that the transmitting power changed when DSI = 1 switches to DSI = 2:

Note: As per the manufacturer, *Reserve_power_margin* = 3dB. Based on Table 8-1, EFS P_{limit} = 17dBm for WCDMA B2, Grip sensor On DSI = 1, and EFS P_{limit} = 14dBm for Tablet back-off DSI = 2. The difference in *Preserve* (= $P_{limit} - 3dB Reserve_power_margin$) level corresponds to the expected different in P_{limit} levels of 3.0 dB (within 1dB of radio design related uncertainty). Therefore, the conducted power plot shows expected transition in Tx power.

Conducted Plot No.18

Plot 2: All the time-averaged conducted Tx power measurement results were converted into time averaged normalized SAR values using Equation (6a), (6b) and (6c), and plotted below to demonstrate that the time-averaged normalized SAR versus time does not exceed the FCC limit of 1 unit.

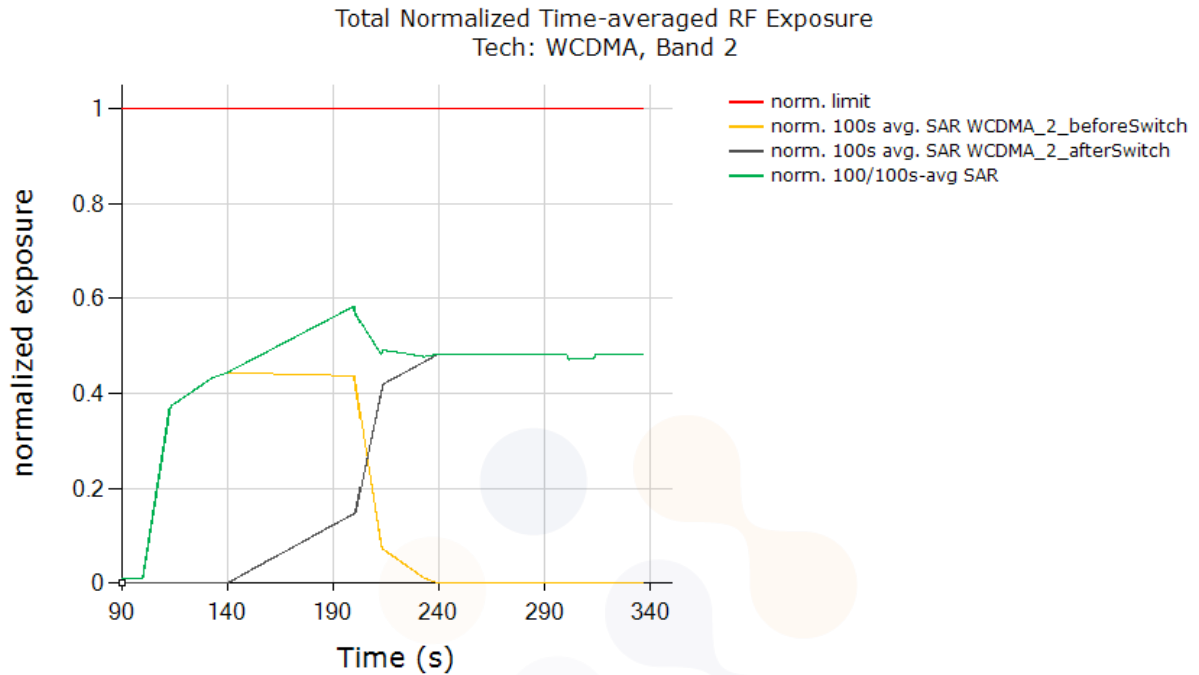

FCC normalized SAR Limit [W/kg]	1.0 W/kg
Max Norm. Total time-avg. 1g SAR (green curve)	0.584 W/kg
Validated: The test result validated the continuity of power limiting in DSI switch scenario.	

8.7 Switch in SAR exposure test results (test case 12 in Table 7-2)

This test was conducted with callbox requesting maximum power, and with the EUT in LTE B5 + Sub6 NR Band n66 call. Here, LTE B5, DSI = 2 (100s window, EFS $P_{limit} = 20\text{dBm}$, $P_{max} = 24\text{dBm}$, measured $P_{limit} = 20.80\text{dBm}$), and Sub6 NR Band n66, DSI = 2 (100s window, $P_{limit} = 14\text{dBm}$ in EFS setting, EUT's average $P_{max} = 24\text{dBm}$, measured $P_{limit} = 14.80\text{dBm}$). Following procedure detailed in Section 6.1.7 and Appendix B.2, and using the measurement setup shown in Figure 8-2(c) since LTE and Sub6 NR are sharing the same antenna port. The SAR exposure switch measurement is performed with the EUT in various SAR exposure scenarios, i.e., in SAR sub6NR only scenario (t = 10s ~ 125s), SARsub6NR + SARLTE scenario (t = 125s ~ 245s) and SARLTE only scenario (t > 245s).

Conducted Plot No.19

Plot 1: SARsub6NR only scenario (t = 0s ~ 120s), SARsub6NR + SARLTE scenario (t = 120s ~ 240s) and SARLTE only scenario (t > 240s).

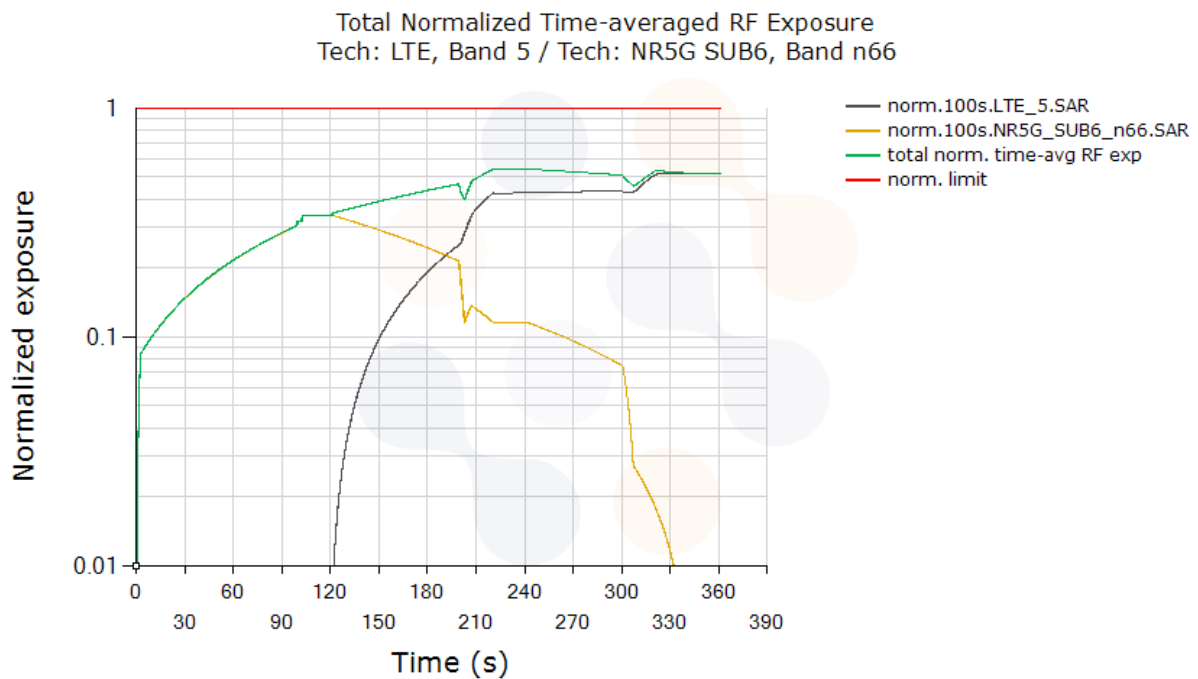

Conducted Plot No.20

Plot 2: All the conducted Tx power measurement results were converted into time-averaged normalized SAR values using Equation (7a), (7b) and (7c), and plotted below to demonstrate that the time-averaged normalized SAR versus time does not exceed the FCC limit of 1 unit. Equation (7a) is used to convert the LTE Tx power of device to obtain 100s-averaged normalized SAR in LTE B5 as shown in black curve. Similarly, equation (7b) is used to obtain 100s-averaged normalized SAR in Sub6 NR n66 as shown in orange curve. Equation (7c) is used to obtain total time-averaged normalized SAR as shown in green curve (i.e., sum of black and orange curves).

LTE and Sub6NR Instantaneous and Time-averaged TX Power
 Tech: LTE, Band 5 / Tech: NR5G SUB6, Band n66

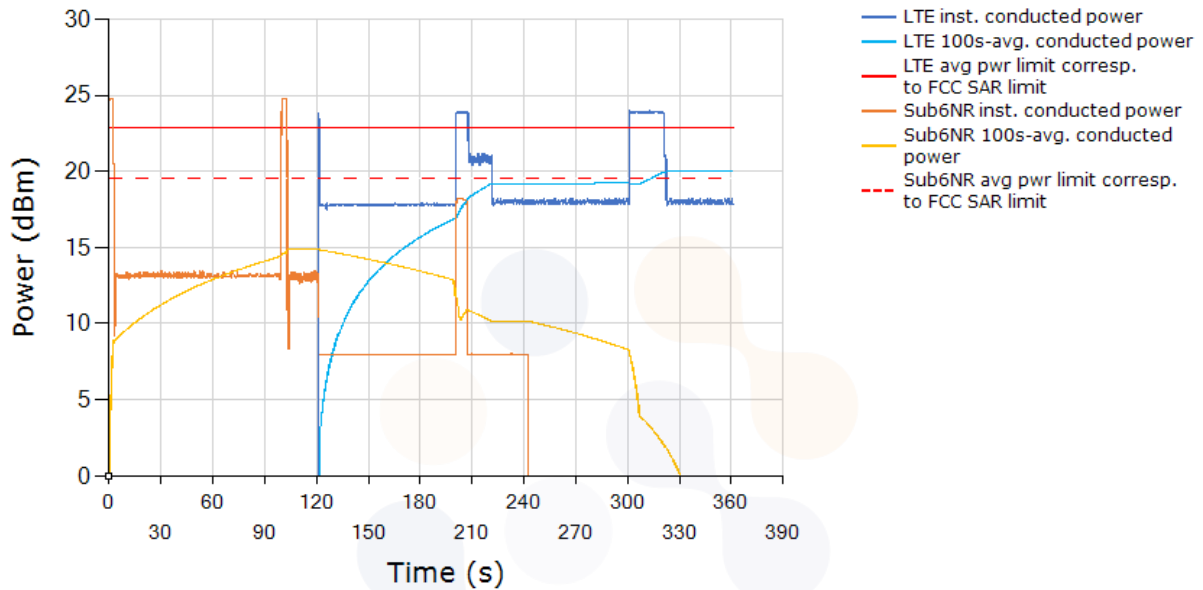

FCC normalized SAR Limit [W/kg]	1.0 W/kg
Max Norm. Total time-avg. 1g SAR (green curve)	0.543 W/kg
Validated	

Plot Notes:

Device starts predominantly in Sub6 NR SAR exposure scenario between 5s and 125s, and in LTE SAR + Sub6 NR SAR exposure scenario between 125s and 245s, and in predominantly in LTE SAR exposure scenario after t=245s. Here, Smart Transmit allocates a maximum of 100% of exposure margin (based on 3dB reserve margin setting) for Sub6 NR. This corresponds to a normalized 1gSAR exposure value = 100% * 0.537W/kg measured SAR at Sub6 NR $P_{limit} / 1.6W/kg$ limit = $0.341 \pm 1dB$ device related uncertainty (see orange curve between 5s~125s). For predominantly LTE SAR exposure scenario, maximum normalized 1gSAR exposure should correspond to 100% exposure margin = 0.999W/kg measured SAR at LTE $P_{limit} / 1.6W/kg$ limit = $0.516 \pm 1dB$ device related uncertainty (see black curve after t=245s). Additionally, in SAR exposure switch test, at all times the total time-averaged normalized RF exposure (green curve) should not exceed normalized SAR_design_target + 1dB device uncertainty. In this test, with a maximum normalized SAR of 0.543 being ≤ 0.794 (= $1/1.6 + 1dB$ device uncertainty), the above test result validated the continuity of power limiting in SAR exposure switch scenario.

9. Radiated SAR Test Results for Smart Transmit Feature Validatio

9.1 Dielectric Property Measurements

Dielectric Property Measurements Results:

SAR 4 Room

Freq. (MHz)	Limit/Measured		Permittivity (ρ)	Conductivity (σ)	Temp. (°C)
850.0	Recommended Limit		41.50 ± 5 %	0.92 ± 5 %	22 ± 2
			(39.43 ~ 43.58)	(0.87 ~ 0.97)	
	Measured	2023-05-24	42.40	0.927	20.73
1 750.0	Recommended Limit		40.07 ± 5 %	1.37 ± 5 %	22 ± 2
			(38.07 ~ 42.07)	(1.30 ~ 1.44)	
	Measured	2023-05-25	39.90	1.36	20.88
1 900.0	Recommended Limit		40.00 ± 5 %	1.40 ± 5 %	22 ± 2
			(38.00 ~ 42.00)	(1.33 ~ 1.47)	
	Measured	2023-05-25	39.20	1.42	20.85

9.2 SAR system check

Reference Target SAR Values

The reference SAR values can be obtained from the calibration certificate of system validation dipoles.

Verification Kit	Probe S/N	Cal. Date	Freq. (MHz)	Target SAR Values (W/kg)	
				1g / 10g	Head
D850V2	1030	2022.10.26	850.0	1g	10.90
				10g	7.03
D1750V2	1195	2022.10.26	1 750.0	1g	36.30
				10g	19.20
D1900V2	5d248	2022.10.20	1 900.0	1g	39.70
				10g	20.70

System Check Results

The 1g and 10g SAR measured with a reference dipole, using the required tissue-equivalent medium at the test frequency, must be within 10% of the manufacturer calibrated dipole SAR target. For more information, see the system validation plot in Appendix C.

SAR 4 Room



Verification Kit	Probe S/N	Frequency (MHz)	Tissue Type	Input Power (mW)	Date	Limit/Measured (Normalized to 1 W)
						Recommended Limit 1g (Normalized)
D850V2 SN: 1030	EX3DV4 SN: 7541	850.0	HSL	250	Measured	10.10 ± 10 % (9.09 ~ 11.11)
					2023-05-24	10.12
D1750V2 SN: 1195	EX3DV4 SN: 7541	1750.0	HSL	250	Measured	36.30 ± 10 % (32.67 ~ 39.93)
					2023-05-25	35.12
D1900V2 SN: 5d248	EX3DV4 SN: 7541	1900.0	HSL	250	Measured	39.70 ± 10 % (35.73 ~ 43.67)
					2023-05-25	40.80

9.3 Measurement setup

This measurement setup is similar to normal SAR measurements. The difference in SAR measurement setup for time averaging feature validation is that the callbox is signaling in close loop power control mode (instead of requesting maximum power in open loop control mode) and callbox is connected to the PC using GPIB so that the test script executed on PC can send GPIB commands to control the callbox's requested power over time (test sequence). The same test script used in conducted setup for time-varying Tx power measurements is also used in this section for running the test sequences during SAR measurements, and the recorded values from the disconnected power meter by the test script were discarded.

As mentioned in Section 3.4, for EUT to follow TPC command sent from the callbox wirelessly, the "path loss" between callbox antenna and the EUT needs to be very well calibrated. Since the SAR chamber is in uncontrolled environment, precautions must be taken to minimize the environmental influences on "path loss". Similarly, in the case of time-varying SAR measurements in Sub6 NR (with LTE as anchor), "path loss" between callbox antenna and the EUT needs to be carefully calibrated for both LTE link as well as for Sub6 NR link.

The EUT is placed in Worst-case position against ELI phantom as shown in A.3 & A.4 in Appendix A.

<p>Eurofins KCTL Co.,Ltd. 65, Sinwon-ro, Yeongtong-gu, Suwon-si, Gyeonggi-do, 16677, Korea TEL: 82-70-5008-1021 FAX: 82-505-299-8311 www.kctl.co.kr</p>	<p>Report No.: KR23-SPF0031-A Page (59) of (80)</p>	 
--	---	---

9.4 Radiated Time-varying Tx power measurement results

Following Section 3.4 procedure, time averaged SAR measurements are conducted using EX3DV4 probe at peak location of area scan over 500 seconds. cDASY6 system validation for SAR measurement is provided in Section 7.1, and the associated SPEAG certificates are attached in Appendix E(Probes) & F(Dipoles) in SAR part 1 report. SAR probe integration times depend on the communication signal being tested. Integration times used by SPEAG for their probe calibrations can be downloaded from here (integration time is listed on the bottom of the first page for each tech):

http://www.speag.com/assets/downloads/services/cs/UIDSummary_171205.pdf

Since the sampling rate used by cDASY6 for pointSAR measurements is not in user control, the number of points in 100s or 60s interval is determined from the scan duration setting in cDASY6 time-average pointSAR measurement by (100s or 60s / cDASY6_scan_duration * total number of pointSAR values recorded). Running average is performed over these number of points in excel spreadsheet to obtain 100s-/60s-averaged pointSAR.

Following Section 6-1, for each of selected technology/band (listed in Table 5-2):

1. With *Reserve_power_margin* set to 0 dB, area scan is performed at P_{limit} and time-averaged pointSAR measurements are conducted to determine the pointSAR at P_{limit} at peak location, denoted as $pointSAR_{P_{limit}}$.
2. With *Reserve_power_margin* set to actual (intended) value, two more time-averaged pointSAR measurements are performed at the same peak location for test sequences 1 and 2. To demonstrate compliance, all the pointSAR measurement results were converted into 1gSAR or 10gSAR values by using Equation (3a), rewritten below:

$$1g_or_10gSAR(t) = \frac{pointSAR(t)}{pointSAR_{P_{limit}}} * 1g_or_10gSAR_{P_{limit}} \quad (3a)$$

Where, $pointSAR(t)$, $pointSAR_{P_{limit}}$, and $1g_or_10gSAR_{P_{limit}}$ correspond to the measured instantaneous point SAR, measured point SAR at P_{limit} from above step 1 and 2, and measured 1gSAR or 10gSAR values at P_{limit} obtained from Part 1 report and listed in Table 5-2 in Section 5.1 of this report

9.4.1 WCDMA B2 (test case 1 in Table 7-2)

Radiated Plot No. 1

Test result for test sequence 1:

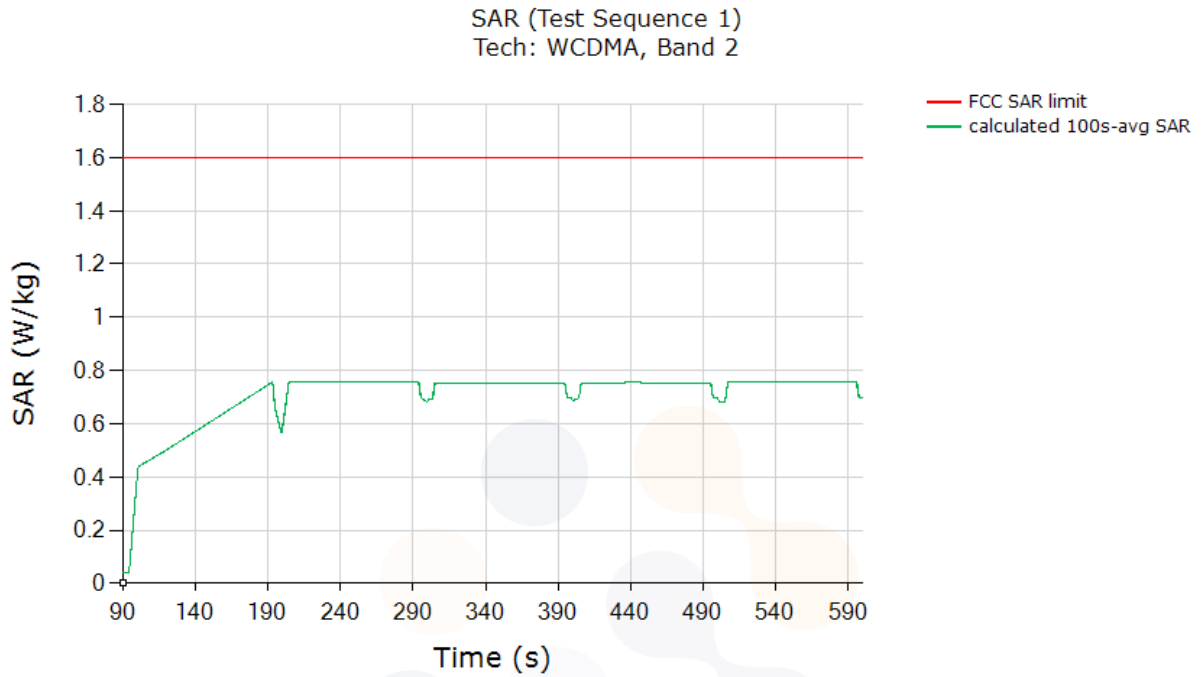

FCC 1g SAR Limit [W/kg]	1.6 W/kg
Max 100s-time averaged 1g SAR (green curve)	0.758 W/kg
Validated: Max time averaged SAR (green curve) is within 1dB device uncertainty of measured SAR at P_{limit} (last column in Table 7-2)	

Radiated Plot No. 2

Test result for test sequence 2:

SAR (Test Sequence 2)
 Tech: WCDMA, Band 2

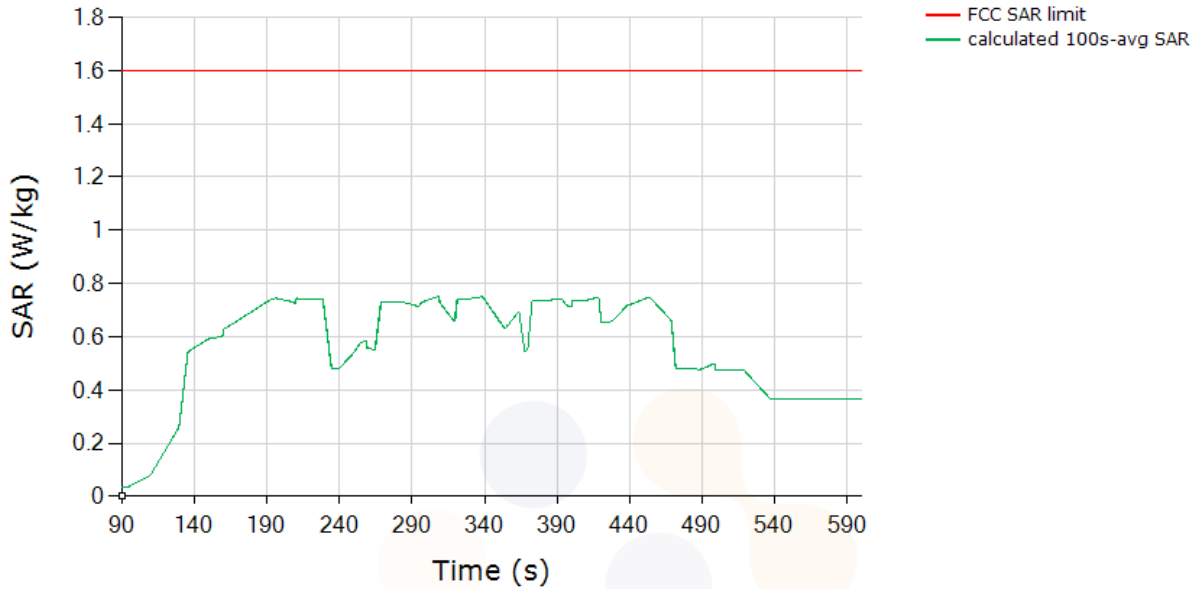

FCC 1g SAR Limit [W/kg]	1.6 W/kg
Max 100s-time averaged 1g SAR (green curve)	0.751 W/kg
Validated: Max time averaged SAR (green curve) is within 1dB device uncertainty of measured SAR at P_{limit} (last column in Table 7-2)	

9.4.2 WCDMA B5 (test case 1 in Table 7-2)

Radiated Plot No. 3

Test result for test sequence 1:

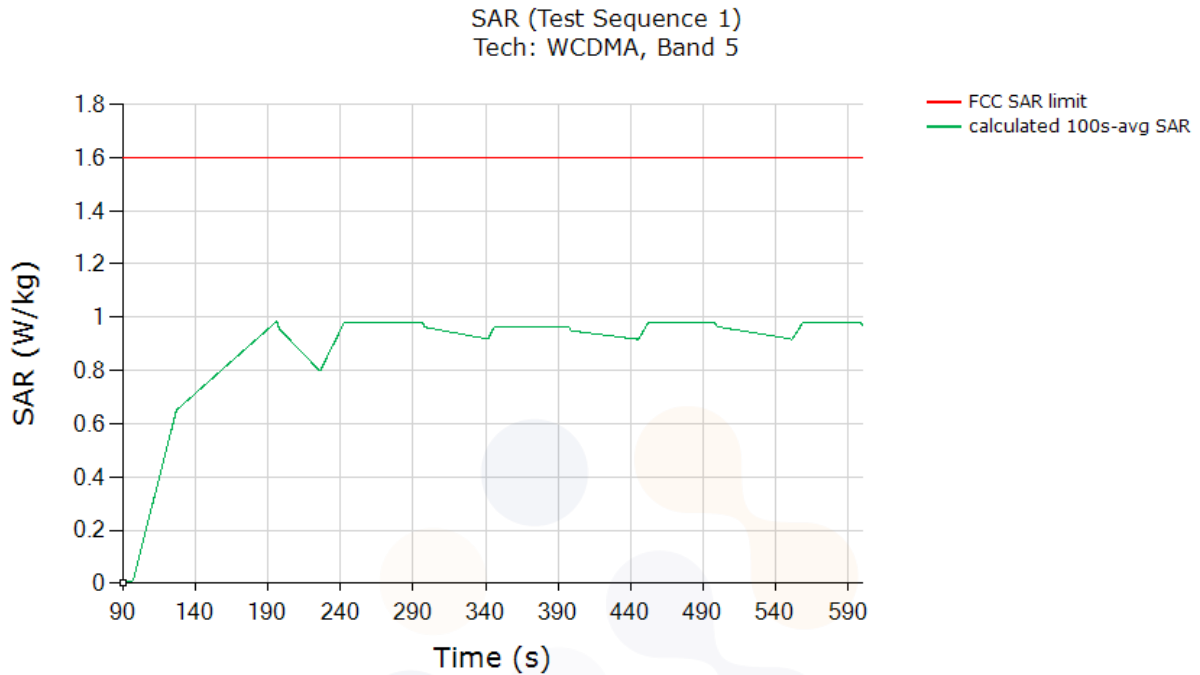

FCC 1g SAR Limit [W/kg]	1.6 W/kg
Max 100s-time averaged 1g SAR (green curve)	0.983 W/kg
Validated: Max time averaged SAR (green curve) is within 1dB device uncertainty of measured SAR at P_{limit} (last column in Table 7-2)	

Radiated Plot No. 4

Test result for test sequence 2:

SAR (Test Sequence 2)
 Tech: WCDMA, Band 5

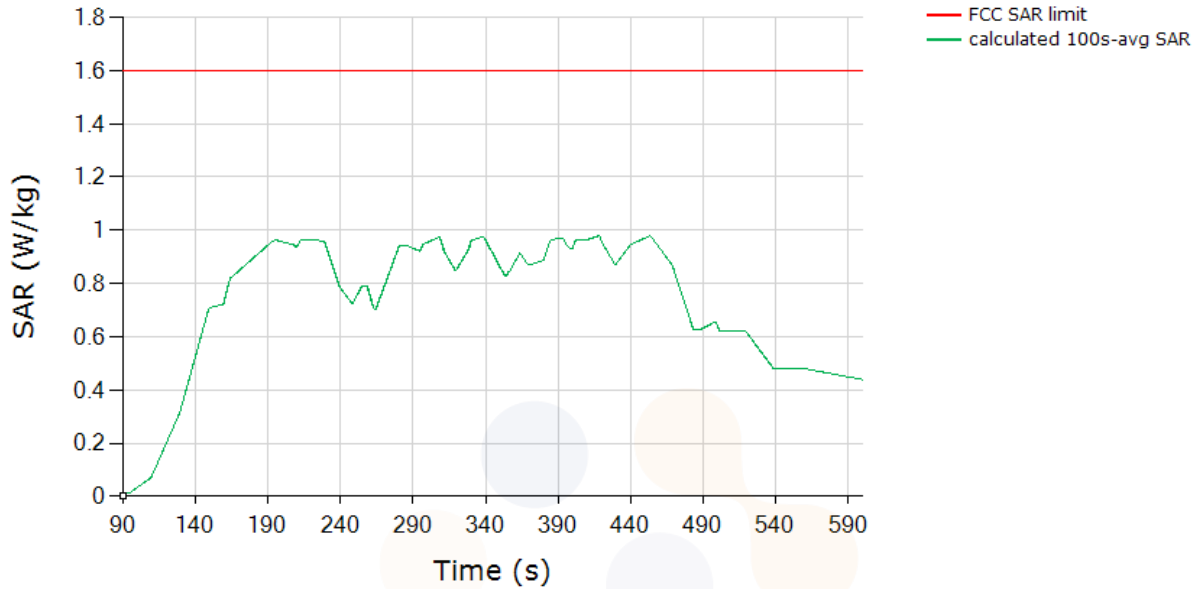

FCC 1g SAR Limit [W/kg]	1.6 W/kg
Max 100s-time averaged 1g SAR (green curve)	0.979 W/kg
Validated: Max time averaged SAR (green curve) is within 1dB device uncertainty of measured SAR at P_{limit} (last column in Table 7-2)	

9.4.3 LTE Band 5 (test case 2 in Table 7-2)

Radiated Plot No. 5

Test result for test sequence 1:

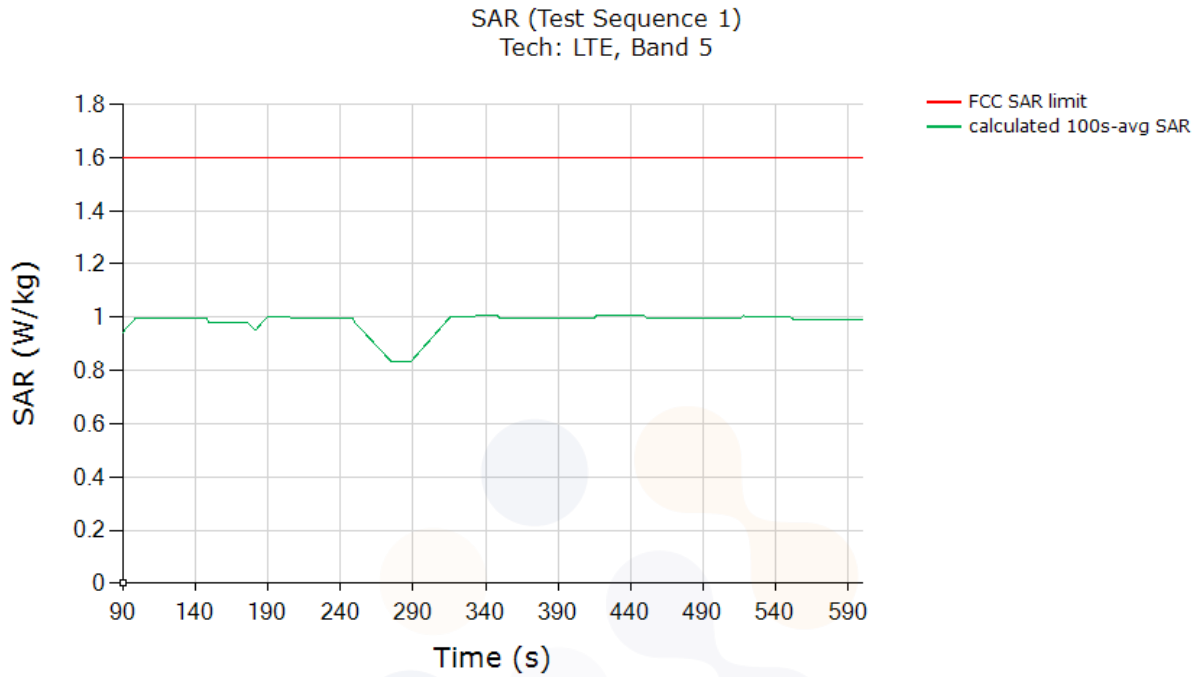

FCC 1g SAR Limit [W/kg]	1.6 W/kg
Max 100s-time averaged 1g SAR (green curve)	1.005 W/kg
Validated: Max time averaged SAR (green curve) is within 1dB device uncertainty of measured SAR at P_{limit} (last column in Table 7-2)	

Radiated Plot No. 6

Test result for test sequence 2:

SAR (Test Sequence 2)
 Tech: LTE, Band 5

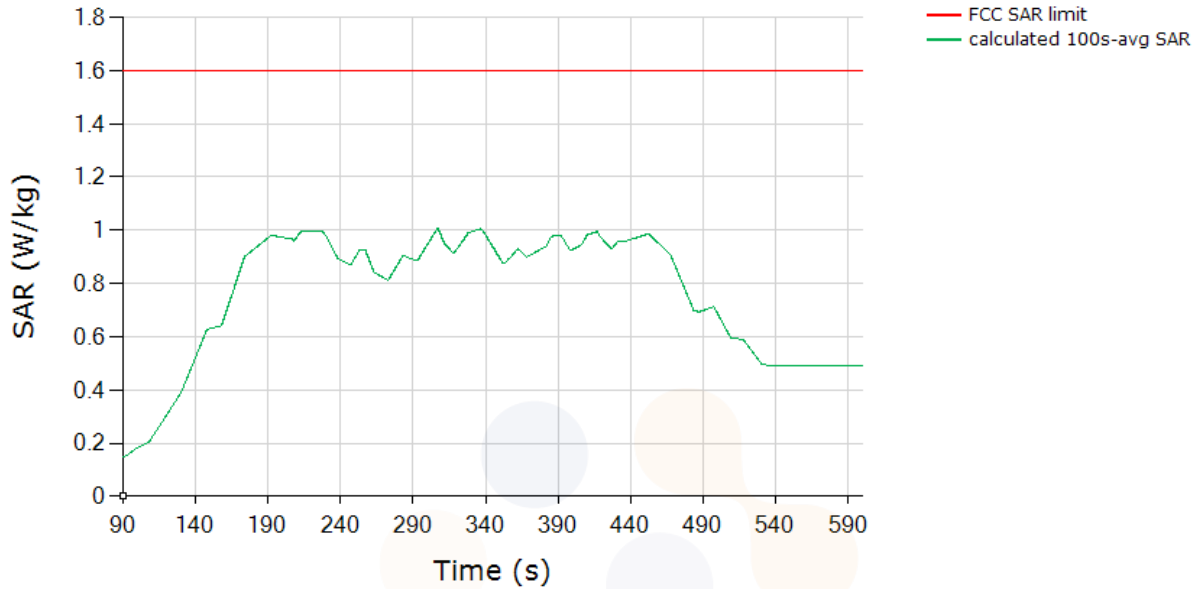

FCC 1g SAR Limit [W/kg]	1.6 W/kg
Max 100s-time averaged 1g SAR (green curve)	1.007 W/kg
Validated: Max time averaged SAR (green curve) is within 1dB device uncertainty of measured SAR at P_{limit} (last column in Table 7-2)	

9.4.4 LTE Band 66 (test case 2 in Table 7-2)

Radiated Plot No. 7

Test result for test sequence 1:

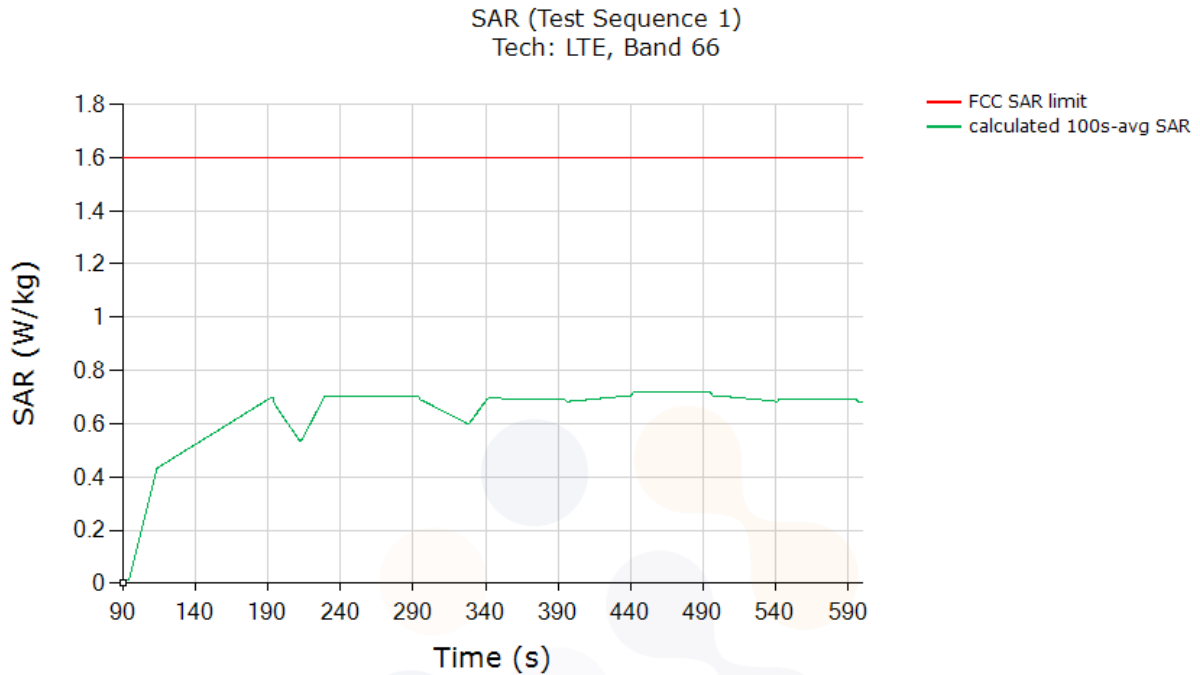

FCC 1g SAR Limit [W/kg]	1.6 W/kg
Max 100s-time averaged 1g SAR (green curve)	0.718 W/kg
Validated: Max time averaged SAR (green curve) is within 1dB device uncertainty of measured SAR at P_{limit} (last column in Table 7-2)	

Radiated Plot No. 8

Test result for test sequence 2:

SAR (Test Sequence 2)
 Tech: LTE, Band 66

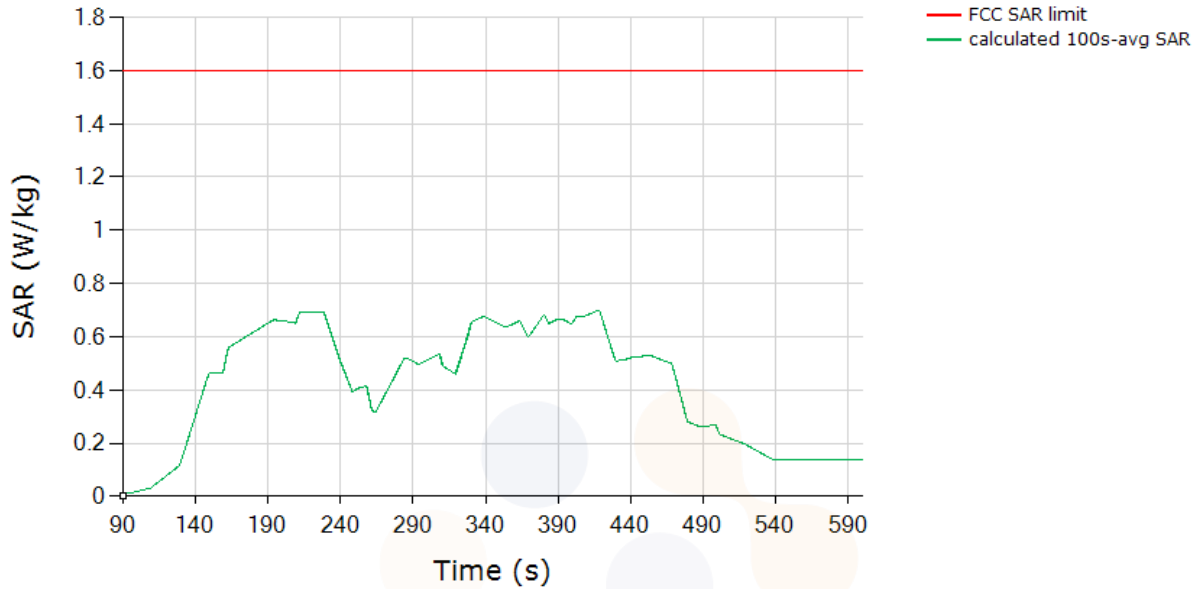

FCC 1g SAR Limit [W/kg]	1.6 W/kg
Max 100s-time averaged 1g SAR (green curve)	0.700 W/kg
Validated: Max time averaged SAR (green curve) is within 1dB device uncertainty of measured SAR at P_{limit} (last column in Table 7-2)	

9.4.5 Sub6 NR n5 (test case 3 in Table 7-2)

Radiated Plot No. 9

Test result for test sequence 1:

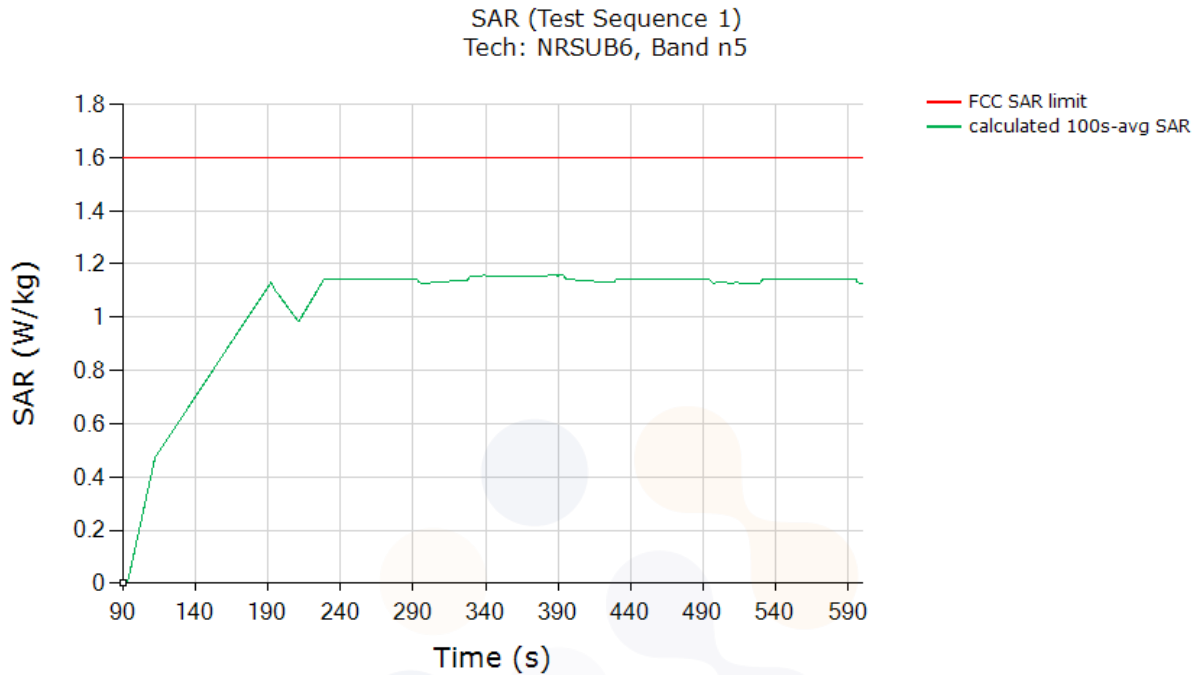

FCC 1g SAR Limit [W/kg]	1.6 W/kg
Max 100s-time averaged 1g SAR (green curve)	1.157 W/kg
Validated: Max time averaged SAR (green curve) is within 1dB device uncertainty of measured SAR at P_{limit} (last column in Table 7-2)	

Radiated Plot No. 10

Test result for test sequence 2:

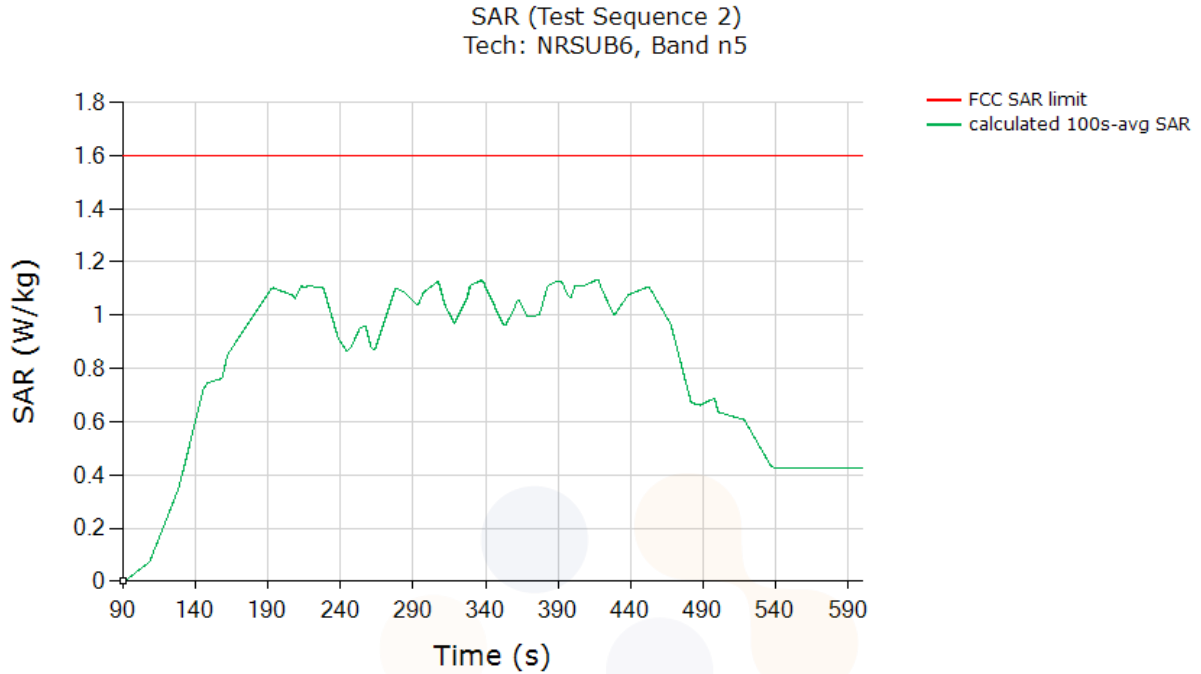

FCC 1g SAR Limit [W/kg]	1.6 W/kg
Max 100s-time averaged 1g SAR (green curve)	1.134 W/kg
Validated: Max time averaged SAR (green curve) is within 1dB device uncertainty of measured SAR at P_{limit} (last column in Table 7-2)	

9.4.6 Sub6 NR n66 (test case 3 in Table 7-2)

Radiated Plot No. 11

Test result for test sequence 1:

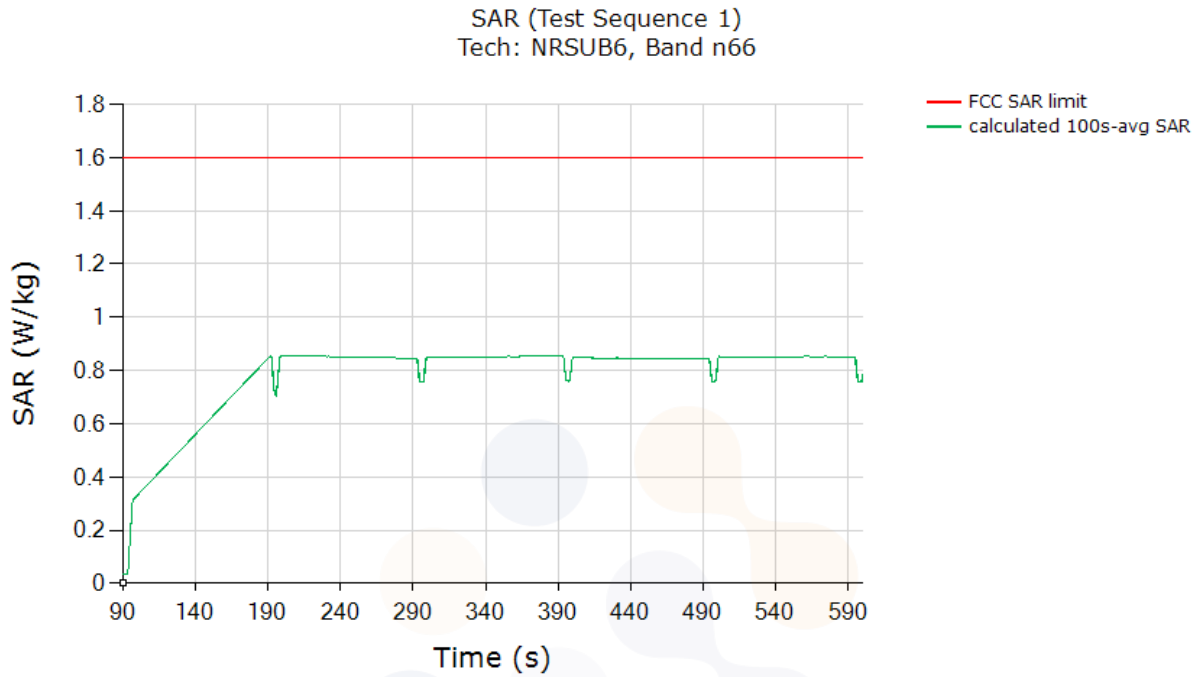

FCC 1g SAR Limit [W/kg]	1.6 W/kg
Max 100s-time averaged 1g SAR (green curve)	0.857 W/kg
Validated: Max time averaged SAR (green curve) is within 1dB device uncertainty of measured SAR at P_{limit} (last column in Table 7-2)	

Radiated Plot No. 12

Test result for test sequence 2:

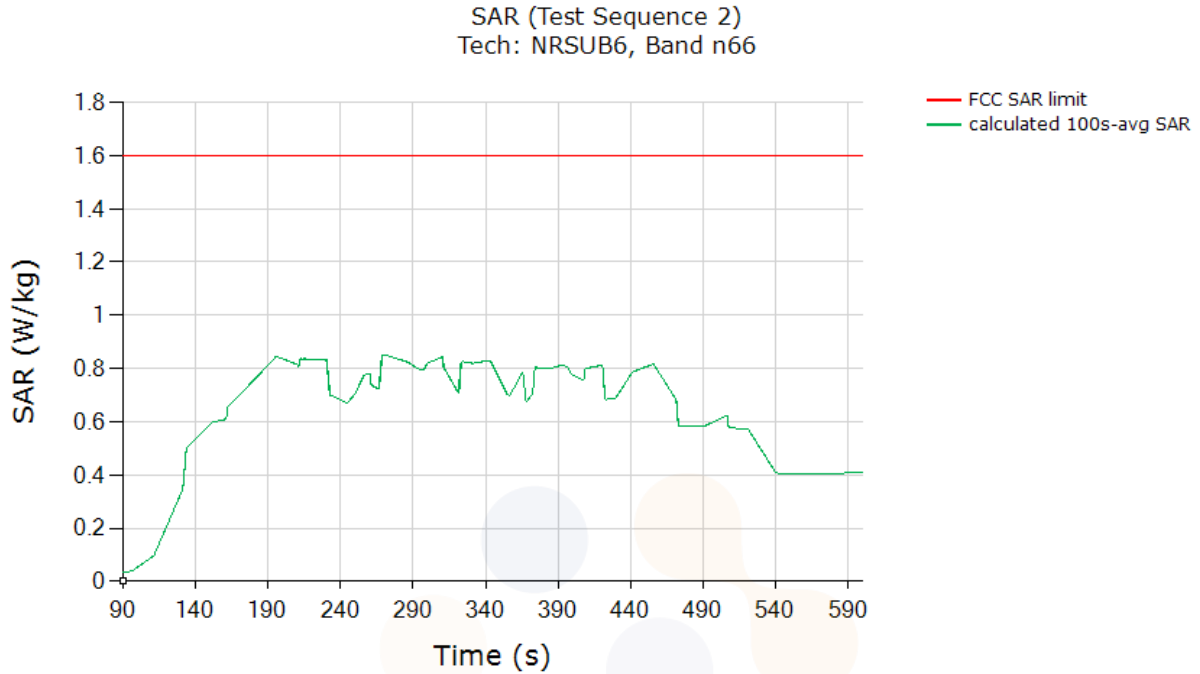



FCC 1g SAR Limit [W/kg]	1.6 W/kg
Max 100s-time averaged 1g SAR (green curve)	0.850 W/kg
Validated: Max time averaged SAR (green curve) is within 1dB device uncertainty of measured SAR at P_{limit} (last column in Table 7-2)	

10. Equipment list

Equipment	Model	Serial Number	Data of Calibration	Due date of next Calibration
Shield Room	-	8F - 4	-	-
DASY6 Robot	TX60 Lspeag	F/19/0007289/A/001	-	-
Phantom	2mm Oval Phantom ELI5	2098	-	-
Mounting Device	Laptop Holder	-	-	-
DAE	DAE4	1759	2022-11-07	2023-11-07
Probe	EX3DV4	7541	2022-07-22	2023-07-22
Dual Power Meter	E4419B	GB40202503	2022-11-21	2023-11-21
Power Sensor	E9301A	US39210857	2022-11-21	2023-11-21
Power Sensor	E9301A	US39212236	2022-11-21	2023-11-21
Attenuator	PE7005-10	2228-4	2022-12-15	2023-12-15
Attenuator	PE7005-10	2228-5	2022-12-15	2023-12-15
Attenuator	PE7005-10	2228-6	2022-12-15	2023-12-15
Dual Directional Coupler	778D	16059	2023-02-09	2024-02-09
Dual Directional Coupler	772D	2839A00719	2023-02-09	2024-02-09
Power Amplifier	AMP2027ADB	10005	2022-07-06	2023-07-06
Low Pass Filter	LA-15N	36543	2023-02-09	2024-02-09
Low Pass Filter	PE8721	2205	2022-12-14	2023-12-14
Dipole Validation Kits	D850V2	1030	2022-10-26	2024-10-26
Dipole Validation Kits	D1750V2	1195	2022-10-26	2024-10-26
Dipole Validation Kits	D1900V2	5d248	2022-10-20	2024-10-20
ENA Series Network Analyzer	E5071B	MY42403524	2023-02-09	2024-02-09
Dielectric Assessment Kit	DAK-3.5	1078	2022-05-30	2023-05-30
Dielectric Assessment Kit	DAK-12	1165	2022-06-13	2023-06-13
Humidity/Temp	MHB-382SD	46301	2023-02-14	2024-02-14
MXA SIGNAL ANALYZER	N9020A	MY520900024	2022-11-22	2023-11-22
Power Sensor	NRP8S	111503	2023-02-13	2024-02-13
Power Sensor	NRP8S	111504	2023-01-04	2024-01-04
Dual Directional Coupler	CS10-19-436/19	2243-1	2022-12-14	2023-12-14
Dual Directional Coupler	CS10-19-436/19	2243-2	2022-12-14	2023-12-14
Wideband Radio Communication Tester	CMW500	168683	2023-02-09	2024-02-09
Radio Communication Analyzer	MT8821C	6262170371	2022-11-03	2023-11-03
Radio Communication Test Station	MT8000A	6261987911	2022-08-10	2023-08-10

Notes:

1. Each equipment item is used solely within its respective calibration period.

<p>Eurofins KCTL Co.,Ltd. 65, Sinwon-ro, Yeongtong-gu, Suwon-si, Gyeonggi-do, 16677, Korea TEL: 82-70-5008-1021 FAX: 82-505-299-8311 www.kctl.co.kr</p>	<p>Report No.: KR23-SPF0031-A Page (73) of (80)</p>	<p> </p>
--	---	--

11. Conclusion

Qualcomm Smart Transmit feature employed in Samsung Notebook PC (FCC A3LRM520N935QNA) has been validated through the conducted/radiated power measurement (as demonstrated in Chapters 8),

As demonstrated in this report, the power limiting enforcement is effective and the total normalized time-averaged RF exposure does not exceed 1.0 for all the transmission scenarios described in Section 6.

Therefore, the EUT complies with FCC RF exposure requirement.

11.1 Measurement Conclusion

The SAR evaluation indicates that the DUT complies with the RF radiation exposure limits of the FCC and Innovation, Science, and Economic Development Canada, with respect to all parameters subject to this test. These measurements were taken to simulate the RF effects of RF exposure under worst-case conditions. Precise laboratory measures were taken to assure repeatability of the tests. The results and statements relate only to the item(s) tested.

Please note that the absorption and distribution of electromagnetic energy in the body are very complex phenomena that depend on the mass, shape, and size of the body, the orientation of the body with respect to the field vectors, and the electrical properties of both the body and the environment. Other variables that may play a substantial role in possible biological effects are those that characterize the environment (e.g. ambient temperature, air velocity, relative humidity, and body insulation) and those that characterize the individual (e.g. age, gender, activity level, debilitation, or disease). Because various factors may interact with one another to vary the specific biological outcome of an exposure to electromagnetic fields, any protection guide should consider maximal amplification of biological effects as a result of field-body interactions, environmental conditions, and physiological variables.



Appendix A. Test Sequences

1. Test sequence is generated based on below parameters of the EUT:

- a. Measured maximum power (P_{max})
- b. Measured Tx_power_at_SAR_design_target (P_{limit})
- c. Reserve_power_margin (dB)
 $P_{reserve}$ (dBm) = measured P_{limit} (dBm) – Reserve_power_margin (dB)
- d. SAR_time_window (100s for FCC)

2. Test Sequence 1 Waveform:

Based on the parameters above, the Test Sequence 1 is generated with one transition between high and low Tx powers. Here, high power = P_{max} ; low power = $P_{max}/2$, and the transition occurs after 80 seconds at high power P_{max} . As long as the power enforcement is taking into effective during one 100s/60s time window, the validation test with this defined test sequence 1 is valid, otherwise, select other radio configuration (band/DSI within the same technology group) having lower P_{limit} for this test. The Test sequence 1 waveform is shown below:

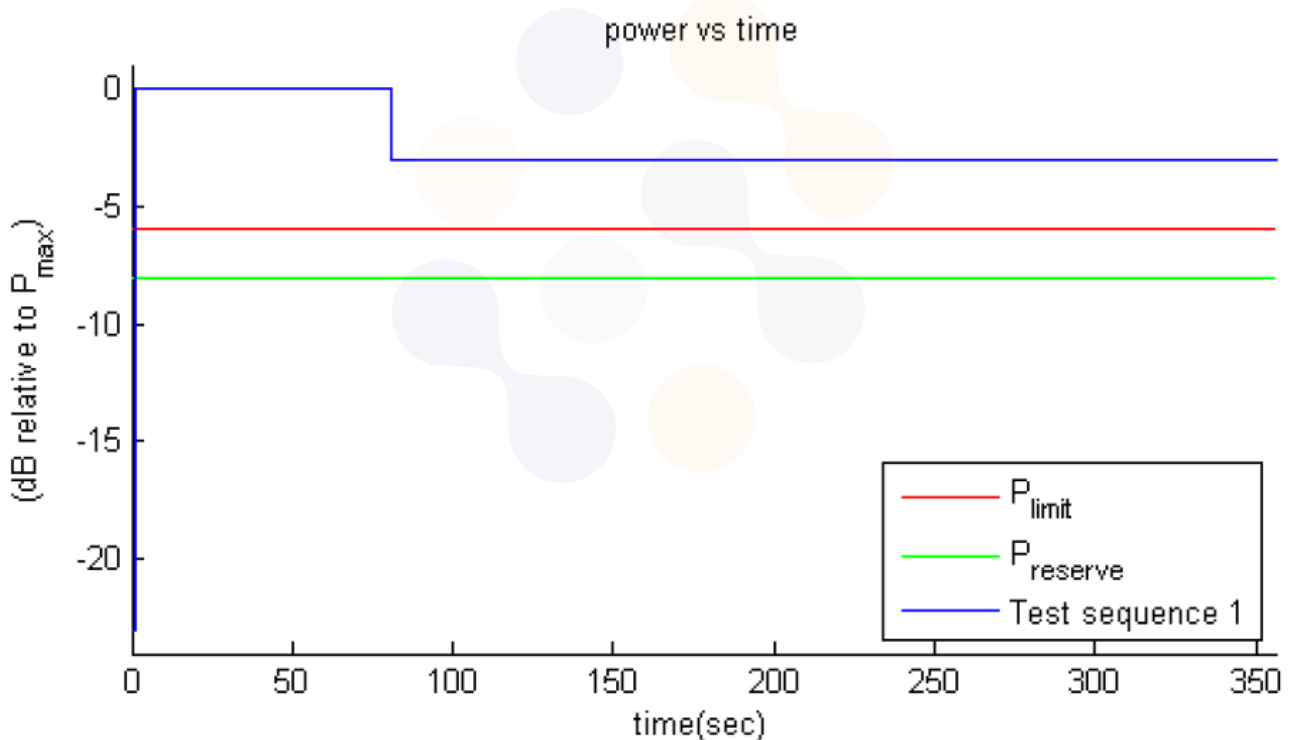

Figure 1 Test sequence 1 waveform

3. Test Sequence 2 Waveform:

Based on the parameters in A-1, the Test Sequence 2 is generated as described in Table A-1, which contains two 170 second-long sequences (yellow and green highlighted rows) that are mirrored around the center row of 20s, resulting in a total duration of 360 seconds:

Time duration (seconds)	dB relative to P_{limit} or $P_{reserve}$
15	$P_{reserve} - 2$
20	P_{limit}
20	$(P_{limit} + P_{max})/2$ averaged in mW and rounded to nearest 0.1 dB step
10	$P_{reserve} - 6$
20	P_{max}
15	P_{limit}
15	$P_{reserve} - 5$
20	P_{max}
10	$P_{reserve} - 3$
15	P_{limit}
10	$P_{reserve} - 4$
20	$(P_{limit} + P_{max})/2$ averaged in mW and rounded to nearest 0.1 dB step
10	$P_{reserve} - 4$
15	P_{limit}
10	$P_{reserve} - 3$
20	P_{max}
15	$P_{reserve} - 5$
15	P_{limit}
20	P_{max}
10	$P_{reserve} - 6$
20	$(P_{limit} + P_{max})/2$ averaged in mW and rounded to nearest 0.1 dB step
20	P_{limit}
15	$P_{reserve} - 2$

Table A-1 - Test Sequence 2 Waveform

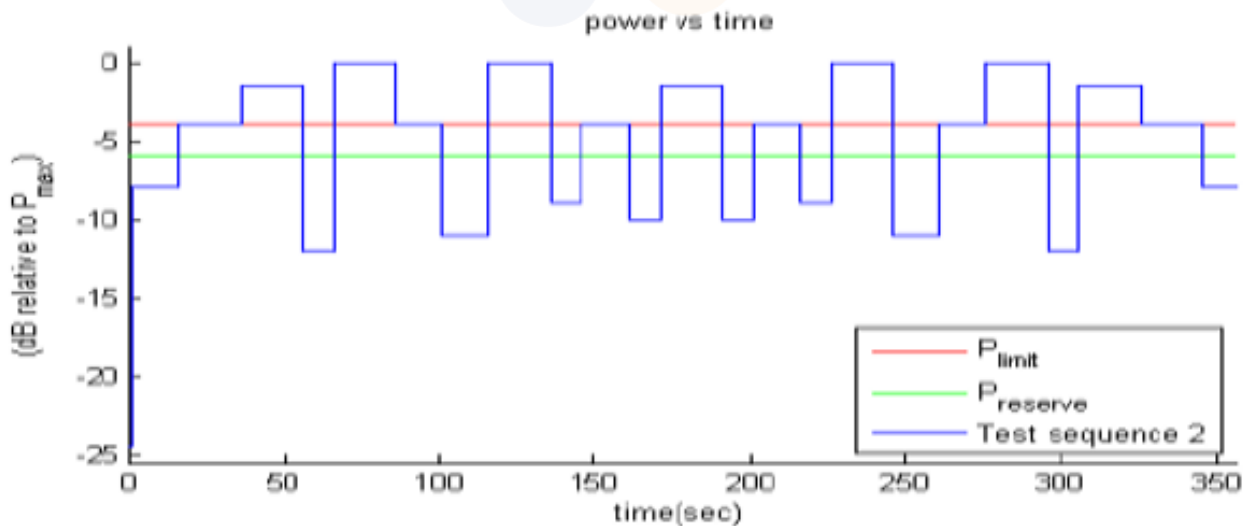



Figure 2 Test sequence 2 waveform

<p>Eurofins KCTL Co.,Ltd. 65, Sinwon-ro, Yeongtong-gu, Suwon-si, Gyeonggi-do, 16677, Korea TEL: 82-70-5008-1021 FAX: 82-505-299-8311 www.kctl.co.kr</p>	<p>Report No.: KR23-SPF0031-A Page (76) of (80)</p>	<p> </p>
--	---	--

Appendix B. Test Procedures for sub6 NR + LTE Radio

Appendix B provides the test procedures for validating Qualcomm Smart Transmit feature for LTE + Sub6 NR non-standalone (NSA) mode transmission scenario, where sub-6GHz LTE link acts as an anchor,

B.1 Time-varying Tx power test for sub6 NR in NSA mode

Follows Section 5.2.1 to select test configurations for time-varying test. This test is performed with two pre-defined test sequences (described in Section 5.1) applied to Sub6 NR (with LTE on all-down bits or low power for the entire test after establishing the LTE+Sub6 NR call with the callbox). Follow the test procedures described in Section 6.1.1 to demonstrate the effectiveness of power limiting enforcement and that the time averaged Tx power of Sub6 NR when converted into 1gSAR values does not exceed the regulatory limit at all times (see Eq. (1a) and (1b)). Sub6 NR response to test sequence1 and test sequence2 will be similar to other technologies (say, LTE), and are shown in Sections 8.3.3



<p style="text-align: center;">Eurofins KCTL Co.,Ltd. 65, Sinwon-ro, Yeongtong-gu, Suwon-si, Gyeonggi-do, 16677, Korea TEL: 82-70-5008-1021 FAX: 82-505-299-8311 www.kctl.co.kr</p>	<p style="text-align: center;">Report No.: KR23-SPF0031-A Page (77) of (80)</p>	
--	---	---

B.2 Switch in SAR exposure between LTE vs. Sub6 NR during transmission

This test is to demonstrate that Smart Transmit feature accurately accounts for switching in exposures among SAR for LTE radio only, SAR from both LTE radio and sub6 NR, and SAR from sub6 NR only scenarios, and ensures total time-averaged RF exposure compliance with FCC limit.

Test procedure:

1. Measure conducted Tx power corresponding to P_{limit} for LTE and sub6 NR in selected band. Test condition to measure conducted P_{limit} is:
 - Establish device in call with the callbox for LTE in desired band. Measure conducted Tx power corresponding to LTE P_{limit} with Smart Transmit enabled and Reserve_power_margin set to 0 dB, callbox set to request maximum power.
 - Repeat above step to measure conducted Tx power corresponding to Sub6 NR P_{limit} . If testing LTE+Sub6 NR in non-standalone mode, then establish LTE+Sub6 NR call with callbox and request all down bits for radio1 LTE. In this scenario, with callbox requesting maximum power from Sub6 NR, measured conducted Tx power corresponds to radio2 P_{limit} (as radio1 LTE is at all-down bits)

2. Set Reserve_power_margin to actual (intended) value with EUT setup for LTE + Sub6 NR call. First, establish LTE connection in all-up bits with the callbox, and then Sub6 NR connection is added with callbox requesting UE to transmit at maximum power in Sub6 NR. As soon as the Sub6 NR connection is established, request all-down bits on LTE link (otherwise, Sub6 NR will not have sufficient RF exposure margin to sustain the call with LTE in all-up bits). Continue LTE (all-down bits)+Sub6 NR transmission for more than one time-window duration to test predominantly Sub6 NR SAR exposure scenario (as SAR exposure is negligible from all-down bits in LTE). After at least one time-window, request LTE to go all-up bits to test LTE SAR and Sub6 NR SAR exposure scenario. After at least one more time-window, drop (or request all-down bits) Sub6 NR transmission to test predominantly LTE SAR exposure scenario. Continue the test for at least one more time-window. Record the conducted Tx powers for both LTE and Sub6 NR for the entire duration of this test.

3. Once the measurement is done, extract instantaneous Tx power versus time for both LTE and Sub6 NR links. Similar to technology/band switch test in Section 6.1.3, convert the conducted Tx power for both these 1, and then perform 100s running average to determine time-averaged 1gSAR versus time as illustrated in Figure 3-1. Note that here it is assumed both radios have Tx frequencies < 3GHz, otherwise, 60s running average should be performed for radios having Tx frequency between 3GHz and 6GHz.

4. Make one plot containing: (a) instantaneous Tx power versus time measured in Step 2.

5. Make another plot containing: (a) instantaneous 1gSAR versus time determined in Step 3, (b) computed time-averaged 1gSAR versus time determined in Step 3, and (c) corresponding regulatory 1gSARlimit of 1.6W/kg.

The validation criteria is, at all times, the time-averaged 1gSAR versus time shall not exceed the regulatory 1gSARlimit of 1.6W/kg.

Appendix C. System Validation Plot

Eurofins KCTL Co.,Ltd.

Measurement Report for D850V2 - SN1030, FRONT, D850, UID 0 -, Channel 50 (850.0MHz)

Device under Test Properties

Model, Manufacturer	Dimensions [mm]	Serial Number	DUT Type
D850V2, SPEAG	10.0 x 10.0 x 346.0	1030	Validation Dipole

Exposure Conditions

Phantom Section, TSL	Position, Test Distance [mm]	Band	Group, UID	Frequency [MHz], Channel Number	Conversion Factor	TSL Conductivity [S/m]	TSL Permittivity
Flat, HSL	FRONT, 10.00	D850	CW, 0--	850.0, 50	9.95	0.927	42.4

Hardware Setup

Phantom	TSL, Measured Date	Probe, Calibration Date	DAE, Calibration Date
ELI V8.0 (20deg probe tilt) - 2098	HBBL-600-10000 , 2023-May-24	EX3DV4 - SN7541, 2022-07-22	DAE4 Sn1759, 2022-11-07

Scan Setup

	Area Scan	Zoom Scan
Grid Extents [mm]	160.0 x 200.0	30.0 x 30.0 x 30.0
Grid Steps [mm]	10.0 x 10.0	6.0 x 6.0 x 1.5
Sensor Surface [mm]	3.0	1.4
Graded Grid	No	Yes
Grading Ratio	N/A	1.5
MAIA	N/A	N/A
Surface	VMS + 6p	VMS + 6p
Detection		
Scan Method	Measured	Measured

Measurement Results

	Area Scan	Zoom Scan
Date	2023-05-24	2023-05-24
psSAR1g [W/kg]	2.52	2.53
psSAR8g [W/kg]	1.75	1.75
psSAR10g [W/kg]	1.66	1.66
psAPD (1.0cm2, sq) [W/m2]		N/A
psAPD (4.0cm2, sq) [W/m2]		N/A
Power Drift [dB]		-0.04
M2/M1 [%]		85.5
Dist 3dB Peak [mm]		21.3

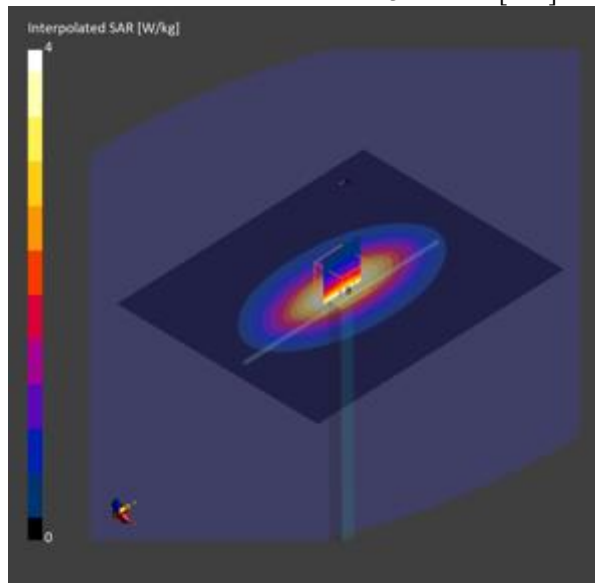

Eurofins KCTL Co.,Ltd.

Measurement Report for D1750V2 - SN1195, FRONT, D1750, UID 0 -, Channel 50 (1750.0MHz)

Device under Test Properties

Model, Manufacturer	Dimensions [mm]	Serial Number	DUT Type
D1750V2, SPEAG	10.0 x 10.0 x 302.0	1195	Validation Dipole

Exposure Conditions

Phantom Section, TSL	Position, Test Distance [mm]	Band	Group, UID	Frequency [MHz], Channel Number	Conversion Factor	TSL Conductivity [S/m]	TSL Permittivity
Flat, HSL	FRONT, 10.00	D1750	CW, 0--	1750.0, 50	8.83	1.36	39.9

Hardware Setup

Phantom	TSL, Measured Date	Probe, Calibration Date	DAE, Calibration Date
ELI V8.0 (20deg probe tilt) - 2098	HBBL-600-10000 , 2023-May-25	EX3DV4 - SN7541, 2022-07-22	DAE4 Sn1759, 2022-11-07

Scan Setup

	Area Scan	Zoom Scan
Grid Extents [mm]	160.0 x 200.0	30.0 x 30.0 x 30.0
Grid Steps [mm]	10.0 x 10.0	6.0 x 6.0 x 1.5
Sensor Surface [mm]	3.0	1.4
Graded Grid	No	Yes
Grading Ratio	N/A	1.5
MAIA	N/A	N/A
Surface	VMS + 6p	VMS + 6p
Detection		
Scan Method	Measured	Measured

Measurement Results

	Area Scan	Zoom Scan
Date	2023-05-25	2023-05-25
psSAR1g [W/kg]	8.73	8.78
psSAR8g [W/kg]	5.07	5.05
psSAR10g [W/kg]	4.67	4.65
psAPD (1.0cm ² , sq) [W/m ²]		N/A
psAPD (4.0cm ² , sq) [W/m ²]		N/A
Power Drift [dB]		-0.00
M2/M1 [%]		80.6
Dist 3dB Peak [mm]		10.3

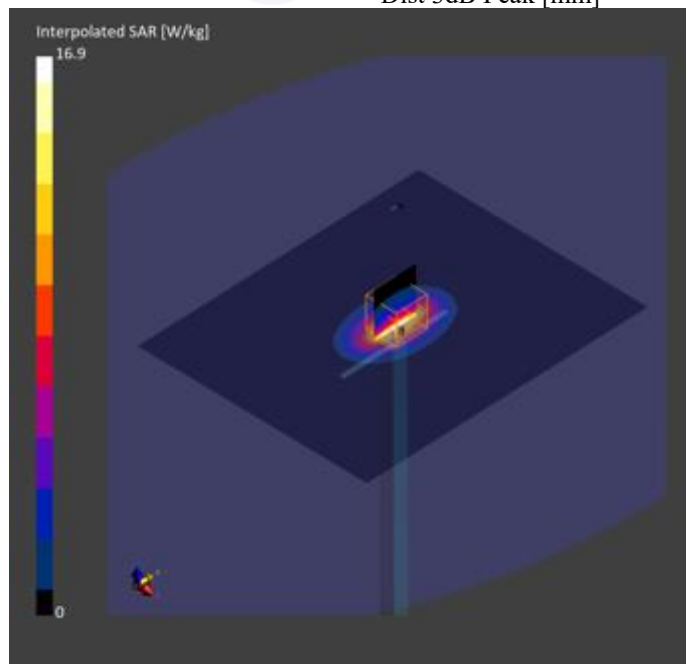

Eurofins KCTL Co.,Ltd.

Measurement Report for D1900V2 - SN5d248, FRONT, D1900, UID 0 -, Channel 50 (1900.0MHz)

Device under Test Properties

Model, Manufacturer	Dimensions [mm]	Serial Number	DUT Type
D1900V2, SPEAG	10.0 x 10.0 x 300.0	5d248	Validation Dipole

Exposure Conditions

Phantom Section, TSL	Position, Test Distance [mm]	Band	Group, UID	Frequency [MHz], Channel Number	Conversion Factor	TSL Conductivity [S/m]	TSL Permittivity
Flat, HSL	FRONT, 10.00	D1900	CW, 0--	1900.0, 50	8.33	1.42	39.2

Hardware Setup

Phantom	TSL, Measured Date	Probe, Calibration Date	DAE, Calibration Date
ELI V8.0 (20deg probe tilt) - 2098	HBBL-600-10000 , 2023-May-25	EX3DV4 - SN7541, 2022-07-22	DAE4 Sn1759, 2022-11-07

Scan Setup

	Area Scan	Zoom Scan
Grid Extents [mm]	210.0 x 270.0	30.0 x 30.0 x 30.0
Grid Steps [mm]	15.0 x 15.0	6.0 x 6.0 x 1.5
Sensor Surface [mm]	3.0	1.4
Graded Grid	No	Yes
Grading Ratio	N/A	1.5
MAIA	N/A	N/A
Surface	VMS + 6p	VMS + 6p
Detection		
Scan Method	Measured	Measured

Measurement Results

	Area Scan	Zoom Scan
Date	2023-05-25	2023-05-25
psSAR1g [W/kg]	10.2	10.2
psSAR8g [W/kg]	5.81	5.79
psSAR10g [W/kg]	5.31	5.33
psAPD (1.0cm2, sq) [W/m2]		N/A
psAPD (4.0cm2, sq) [W/m2]		N/A
Power Drift [dB]		0.01
M2/M1 [%]		81.4
Dist 3dB Peak [mm]		9.9

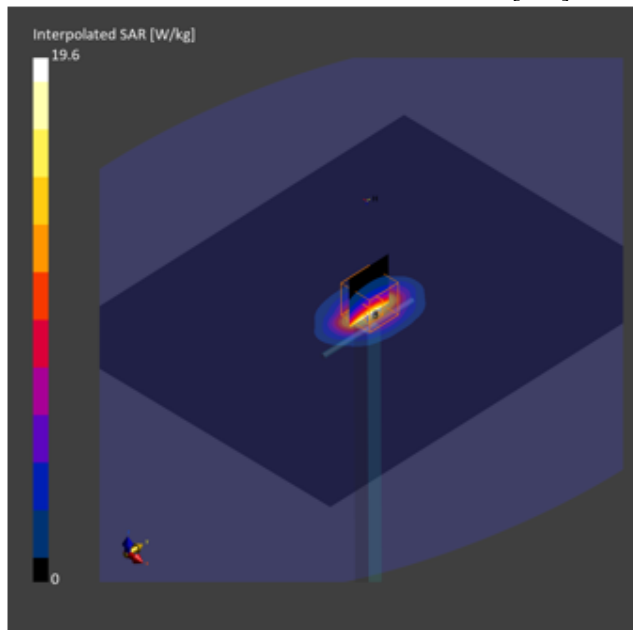

End of test report