



CTK Co., Ltd.
(Ho-dong), 113, Yejik-ro, Cheoin-gu,
Yongin-si, Gyeonggi-do, Korea
Tel: +82-31-339-9970
Fax: +82-31-624-9501

Report No.:
CTK-2017-01618-2
Page (251) / (282)
Pages

Band 2, BW 10MHz, Single carrier, 2TX

QPSK



16QAM

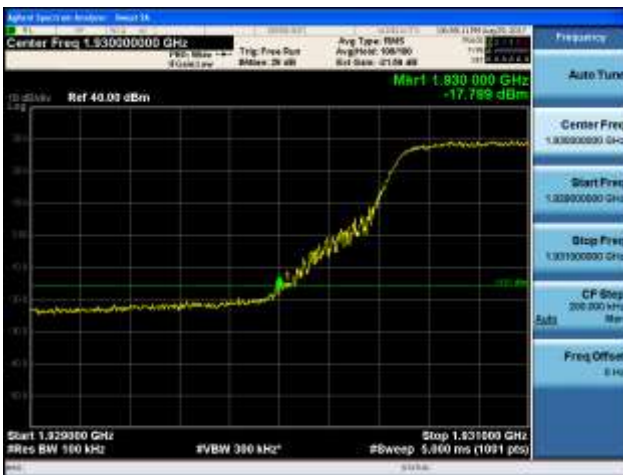



CTK Co., Ltd.
 (Ho-dong), 113, Yejik-ro, Cheoin-gu,
 Yongin-si, Gyeonggi-do, Korea
 Tel: +82-31-339-9970
 Fax: +82-31-624-9501

Report No.:
 CTK-2017-01618-2
 Page (252) / (282)
 Pages

64QAM

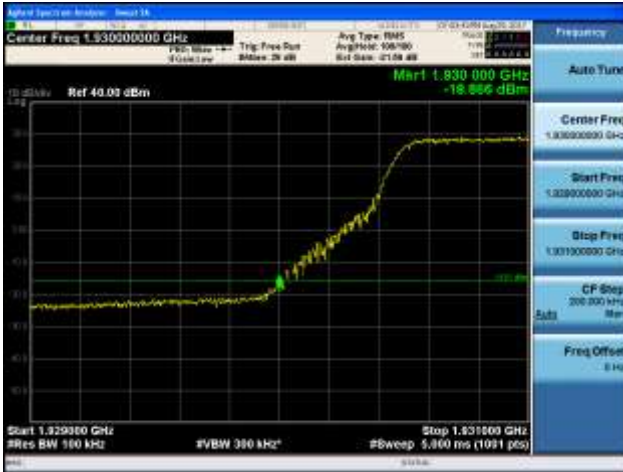

256QAM





CTK Co., Ltd.
 (Ho-dong), 113, Yejik-ro, Cheoin-gu,
 Yongin-si, Gyeonggi-do, Korea
 Tel: +82-31-339-9970
 Fax: +82-31-624-9501

Report No.:
 CTK-2017-01618-2
 Page (253) / (282)
 Pages

Band 2, BW 10MHz, Single carrier, 4TX

QPSK



16QAM





CTK Co., Ltd.
(Ho-dong), 113, Yejik-ro, Cheoin-gu,
Yongin-si, Gyeonggi-do, Korea
Tel: +82-31-339-9970
Fax: +82-31-624-9501

Report No.:
CTK-2017-01618-2
Page (254) / (282)
Pages

64QAM



256QAM





CTK Co., Ltd.
(Ho-dong), 113, Yejik-ro, Cheoin-gu,
Yongin-si, Gyeonggi-do, Korea
Tel: +82-31-339-9970
Fax: +82-31-624-9501

Report No.:
CTK-2017-01618-2
Page (255) / (282)
Pages

Band 2, BW 20MHz, Single carrier, 2TX

QPSK



16QAM

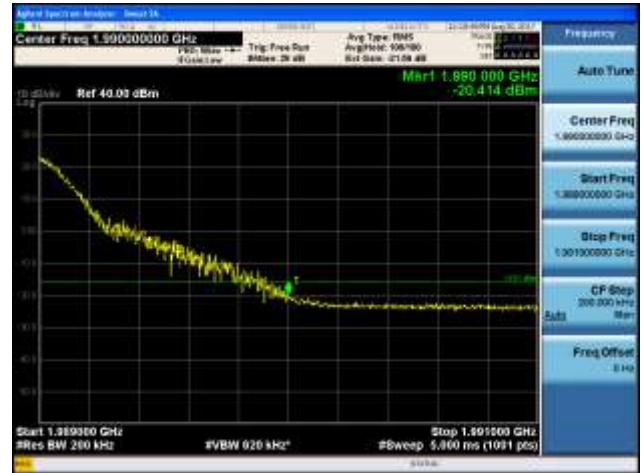



CTK Co., Ltd.
(Ho-dong), 113, Yejik-ro, Cheoin-gu,
Yongin-si, Gyeonggi-do, Korea
Tel: +82-31-339-9970
Fax: +82-31-624-9501

Report No.:
CTK-2017-01618-2
Page (256) / (282)
Pages

64QAM

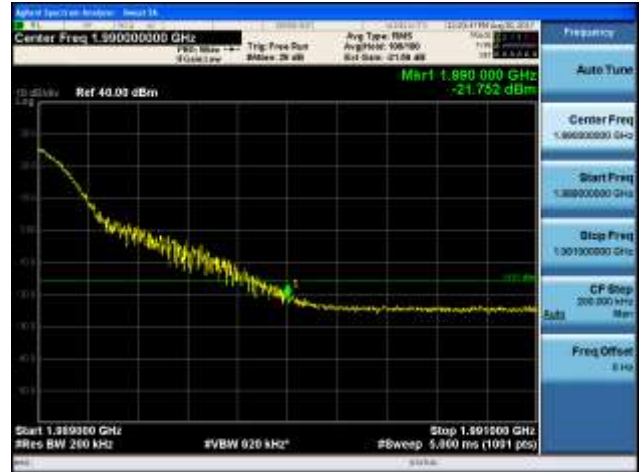

256QAM

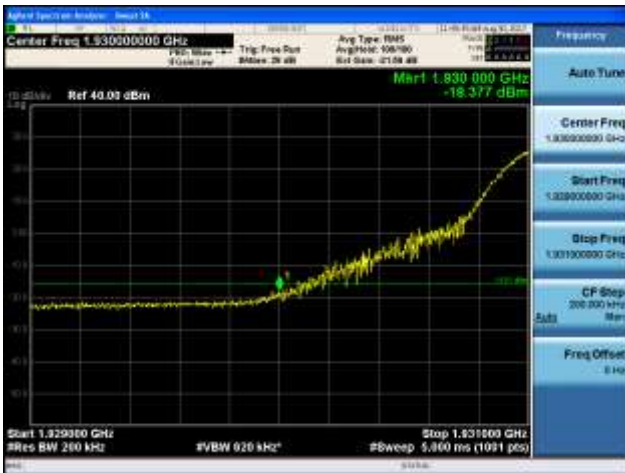



Band 2, BW 20MHz, Single carrier, 4TX

QPSK



16QAM

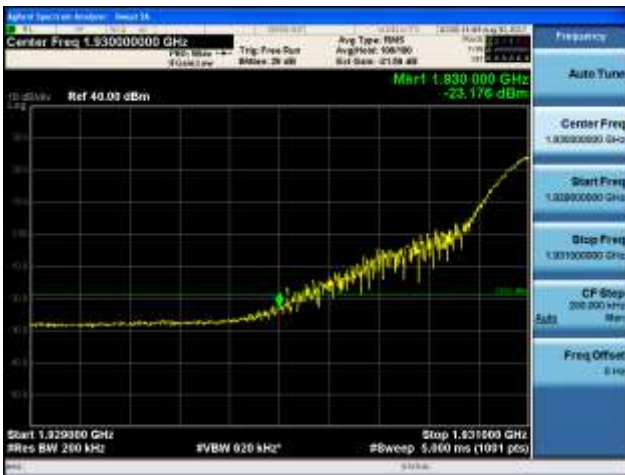



CTK Co., Ltd.
(Ho-dong), 113, Yejik-ro, Cheoin-gu,
Yongin-si, Gyeonggi-do, Korea
Tel: +82-31-339-9970
Fax: +82-31-624-9501

Report No.:
CTK-2017-01618-2
Page (258) / (282)
Pages

64QAM



256QAM



Band 2, BW 5MHz + BW 10MHz, Multi carrier(Contiguous), 2TX

QPSK



16QAM





CTK Co., Ltd.
(Ho-dong), 113, Yejik-ro, Cheoin-gu,
Yongin-si, Gyeonggi-do, Korea
Tel: +82-31-339-9970
Fax: +82-31-624-9501

Report No.:
CTK-2017-01618-2
Page (260) / (282)
Pages

64QAM

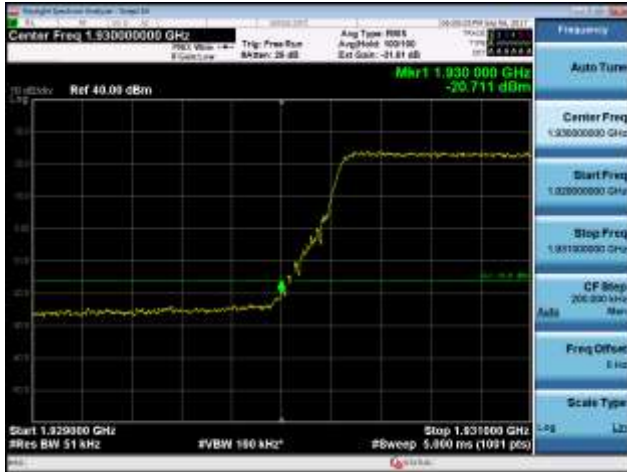

256QAM

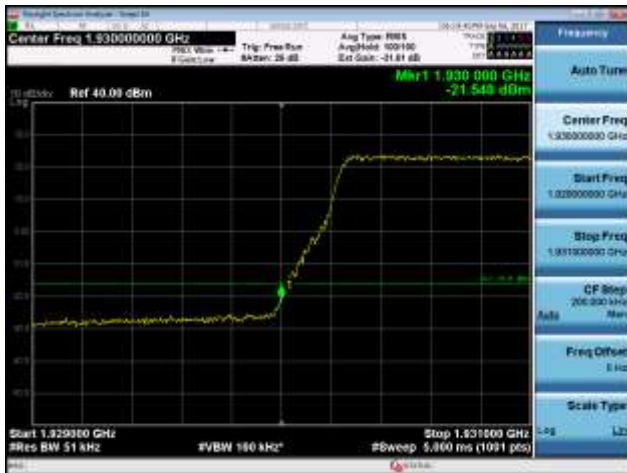



CTK Co., Ltd.
(Ho-dong), 113, Yejik-ro, Cheoin-gu,
Yongin-si, Gyeonggi-do, Korea
Tel: +82-31-339-9970
Fax: +82-31-624-9501

Report No.:
CTK-2017-01618-2
Page (261) / (282)
Pages

Band 2, BW 5MHz + BW 10MHz, Multi carrier(Contiguous), 4TX

QPSK



16QAM

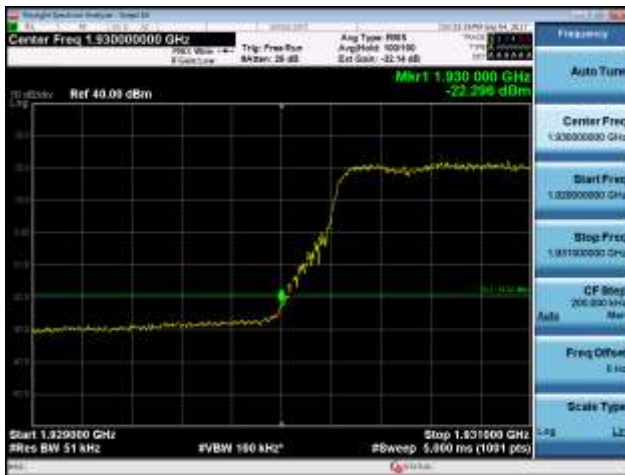



CTK Co., Ltd.
(Ho-dong), 113, Yejik-ro, Cheoin-gu,
Yongin-si, Gyeonggi-do, Korea
Tel: +82-31-339-9970
Fax: +82-31-624-9501

Report No.:
CTK-2017-01618-2
Page (262) / (282)
Pages

64QAM

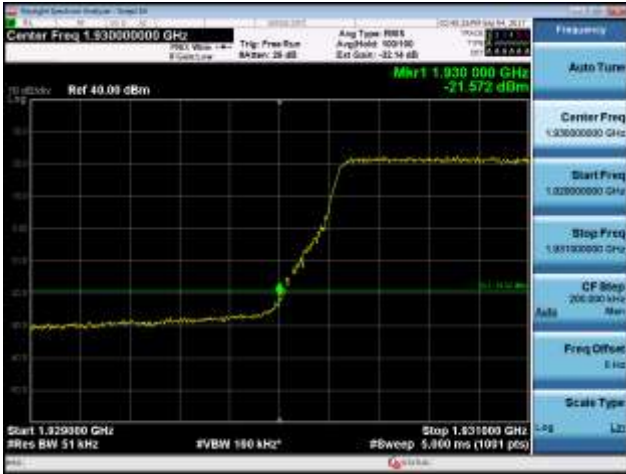

256QAM



Band 2, BW 10MHz + BW 10MHz, Multi carrier(Contiguous), 2TX

QPSK

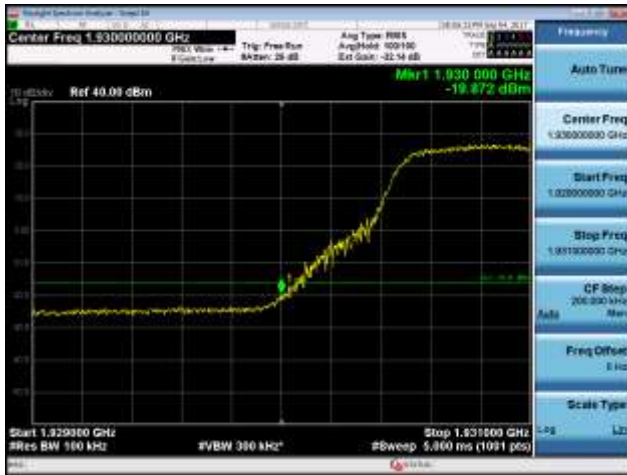

16QAM

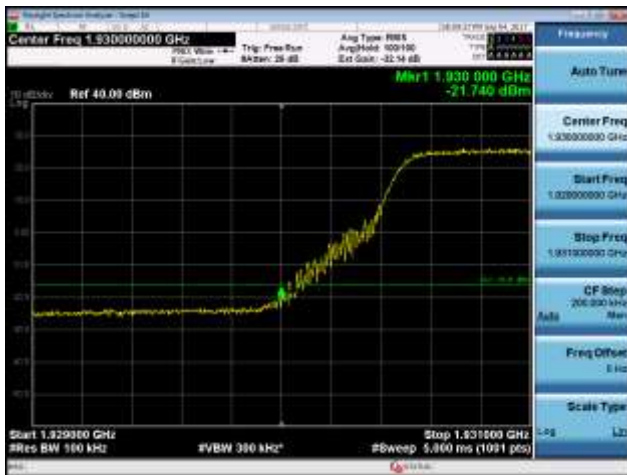



CTK Co., Ltd.
(Ho-dong), 113, Yejik-ro, Cheoin-gu,
Yongin-si, Gyeonggi-do, Korea
Tel: +82-31-339-9970
Fax: +82-31-624-9501

Report No.:
CTK-2017-01618-2
Page (264) / (282)
Pages

64QAM

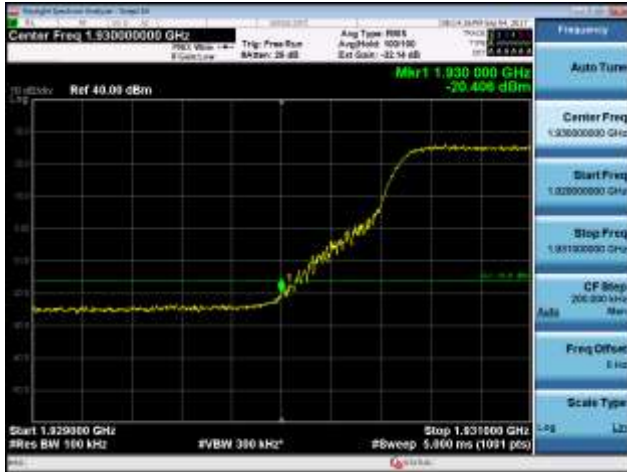

256QAM

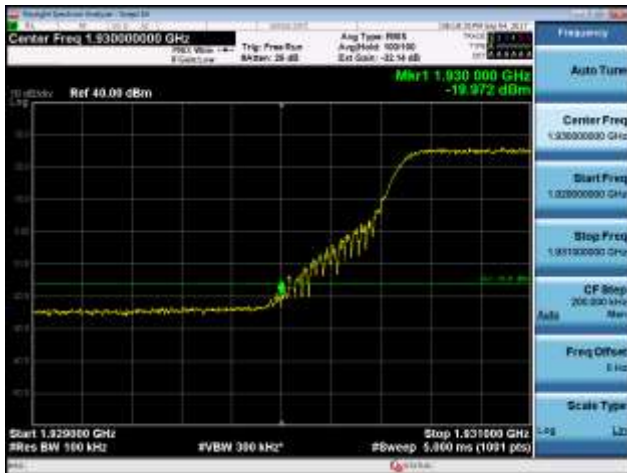



CTK Co., Ltd.
(Ho-dong), 113, Yejik-ro, Cheoin-gu,
Yongin-si, Gyeonggi-do, Korea
Tel: +82-31-339-9970
Fax: +82-31-624-9501

Report No.:
CTK-2017-01618-2
Page (265) / (282)
Pages

Band 2, BW 10MHz + BW 10MHz, Multi carrier(Contiguous), 4TX

QPSK

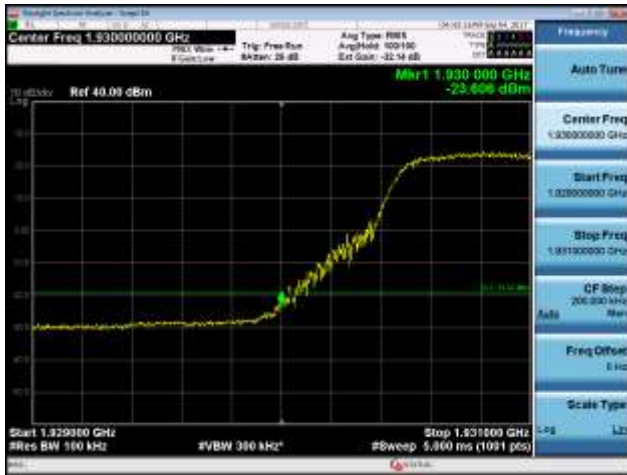

16QAM





CTK Co., Ltd.
(Ho-dong), 113, Yejik-ro, Cheoin-gu,
Yongin-si, Gyeonggi-do, Korea
Tel: +82-31-339-9970
Fax: +82-31-624-9501

Report No.:
CTK-2017-01618-2
Page (266) / (282)
Pages

64QAM

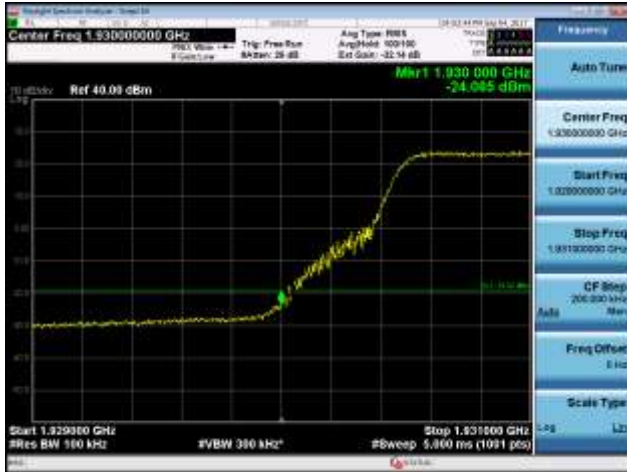

256QAM



Band 2, BW 10MHz + BW 5MHz, Multi carrier(Non-contiguous), 2TX

QPSK

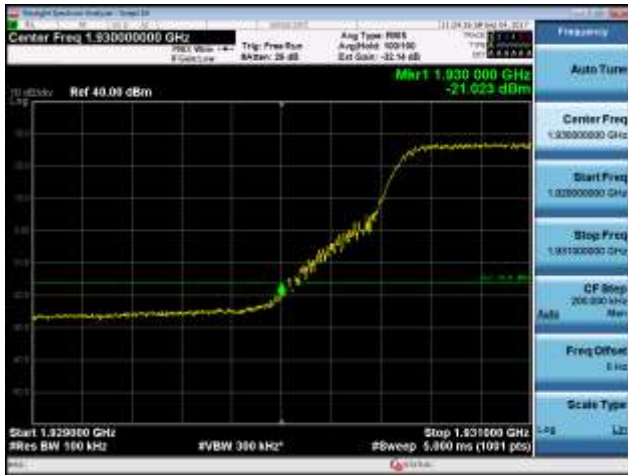

16QAM

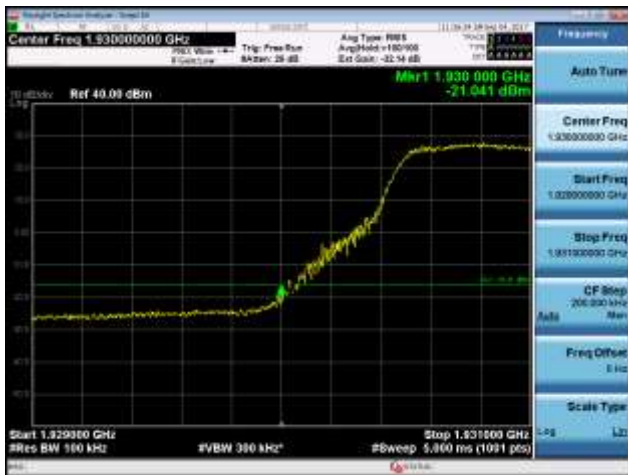



CTK Co., Ltd.
(Ho-dong), 113, Yejik-ro, Cheoin-gu,
Yongin-si, Gyeonggi-do, Korea
Tel: +82-31-339-9970
Fax: +82-31-624-9501

Report No.:
CTK-2017-01618-2
Page (268) / (282)
Pages

64QAM



256QAM

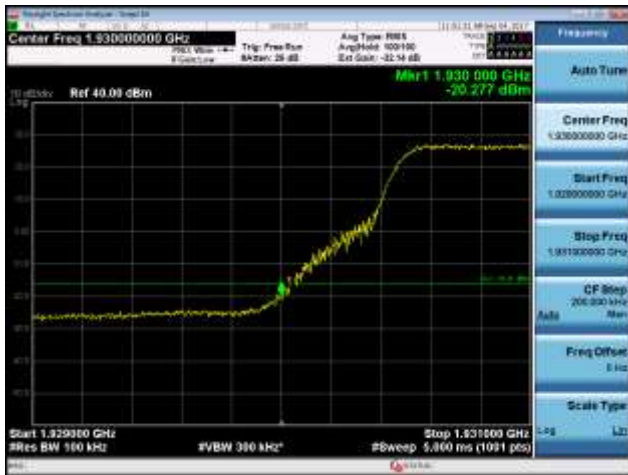



CTK Co., Ltd.
(Ho-dong), 113, Yejik-ro, Cheoin-gu,
Yongin-si, Gyeonggi-do, Korea
Tel: +82-31-339-9970
Fax: +82-31-624-9501

Report No.:
CTK-2017-01618-2
Page (270) / (282)
Pages

64QAM



256QAM





CTK Co., Ltd.
(Ho-dong), 113, Yejik-ro, Cheoin-gu,
Yongin-si, Gyeonggi-do, Korea
Tel: +82-31-339-9970
Fax: +82-31-624-9501

Report No.:
CTK-2017-01618-2
Page (271) / (282)
Pages

Band 2, BW 10MHz + BW 10MHz, Multi carrier(Non-contiguous), 2TX

QPSK

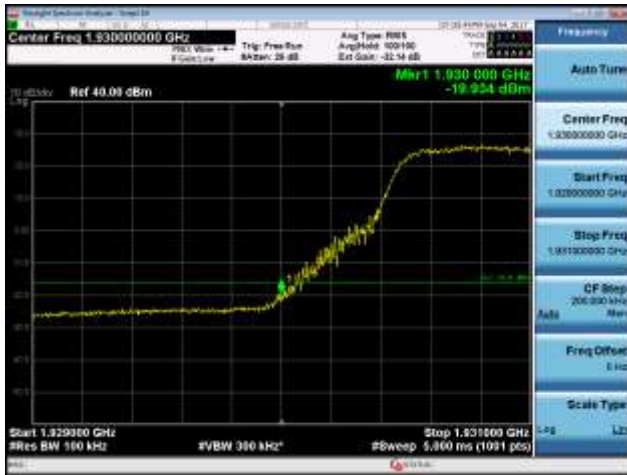

16QAM





CTK Co., Ltd.
(Ho-dong), 113, Yejik-ro, Cheoin-gu,
Yongin-si, Gyeonggi-do, Korea
Tel: +82-31-339-9970
Fax: +82-31-624-9501

Report No.:
CTK-2017-01618-2
Page (272) / (282)
Pages

64QAM

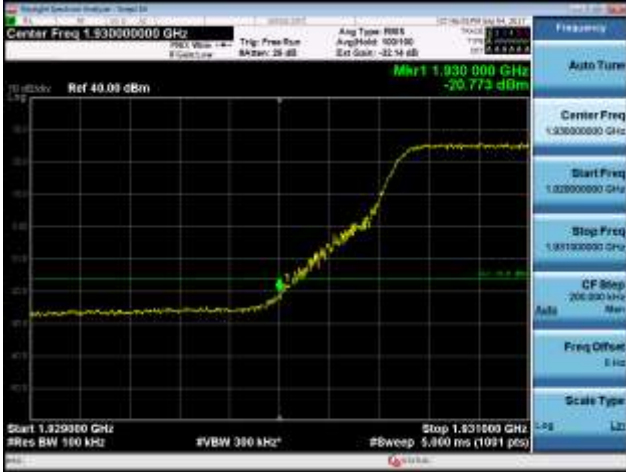

256QAM



Band 2, BW 10MHz + BW 10MHz, Multi carrier(Non-contiguous), 4TX

QPSK



16QAM





CTK Co., Ltd.
(Ho-dong), 113, Yejik-ro, Cheoin-gu,
Yongin-si, Gyeonggi-do, Korea
Tel: +82-31-339-9970
Fax: +82-31-624-9501

Report No.:
CTK-2017-01618-2
Page (274) / (282)
Pages

64QAM

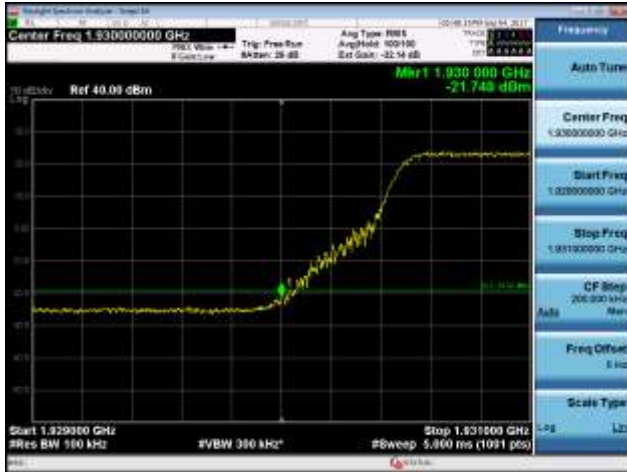

256QAM



	CTK Co., Ltd. (Ho-dong), 113, Yejik-ro, Cheoin-gu, Yongin-si, Gyeonggi-do, Korea Tel: +82-31-339-9970 Fax: +82-31-624-9501	Report No.: CTK-2017-01618-2 Page (275) / (282) Pages	
---	---	--	--

7. Radiated Spurious Emission

Test Requirements :

§ 2.1053 Measurements required : Field strength of spurious radiation.

(a) Measurements shall be made to detect spurious emissions that may be radiated directly from the cabinet, control circuits, power leads, or intermediate circuit elements under normal conditions of installation and operation. Curves or equivalent data shall be supplied showing the magnitude of each harmonic and other spurious emission. For this test, single sideband, independent sideband, and controlled carrier transmitters shall be modulated under the conditions specified in paragraph (c) of §2.1049, as appropriate. For equipment operating on frequencies below 890 MHz, an open field test is normally required, with the measuring instrument antenna located in the far-field at all test frequencies. In the event it is either impractical or impossible to make open field measurements (e.g. a broadcast transmitter installed in a building) measurements will be accepted of the equipment as installed. Such measurements must be accompanied by a description of the site where the measurements were made showing the location of any possible source of reflections which might distort the field strength measurements. Information submitted shall include the relative radiated power of each spurious emission with reference to the rated power output of the transmitter, assuming all emissions are radiated from halfwave dipole antennas.

(b) The measurements specified in paragraph (a) of this section shall be made for the following equipment:

- (1) Those in which the spurious emissions are required to be 60 dB or more below the mean power of the transmitter.
- (2) All equipment operating on frequencies higher than 25 MHz.
- (3) All equipment where the antenna is an integral part of, and attached directly to the transmitter.
- (4) Other types of equipment as required, when deemed necessary by the Commission.



CTK Co., Ltd.
(Ho-dong), 113, Yejik-ro, Cheoin-gu,
Yongin-si, Gyeonggi-do, Korea
Tel: +82-31-339-9970
Fax: +82-31-624-9501

Report No.:
CTK-2017-01618-2
Page (276) / (282)
Pages

§ 27.53 Emission limits :

For operations in the 746-758 MHz band and the 776-788 MHz band, the power of any emission outside the licensee's frequency band(s) of operation shall be attenuated below the transmitter power (P) within the licensed band(s) of operation, measured in watts, in accordance with the following:

(1) On any frequency outside the 746-758 MHz band, the power of any emission shall be attenuated outside the band below the transmitter power (P) by at least $43 + 10 \log (P)$;

$$46 \text{ dBm} - (43 + 10 \log(40)) = -13 \text{ dBm}, 47.78 \text{ dBm} - (43 + 10 \log(60)) = -13 \text{ dBm}$$

(2) On all frequencies between 763-775 MHz and 793-805 MHz, by a factor not less than $76 + 10 \log (P)$ dB in a 6.25 kHz band segment, for base and fixed stations;

$$46 \text{ dBm} - (76 + 10 \log(40)) = -46 \text{ dBm}, 47.78 \text{ dBm} - (76 + 10 \log(60)) = -46 \text{ dBm}$$

(3) Compliance with the provisions of paragraphs (1) of this section is based on the use of measurement instrumentation employing a resolution bandwidth of 100 kHz or greater. However, in the 100 kHz bands immediately outside and adjacent to the frequency block, a resolution bandwidth of at least 30 kHz may be employed;

(4) Compliance with the provisions of paragraphs (2) of this section is based on the use of measurement instrumentation such that the reading taken with any resolution bandwidth setting should be adjusted to indicate spectral energy in a 6.25 kHz segment.

For operations in the 746-758 MHz, 775-788 MHz, and 805-806 MHz bands, emissions in the band 1559-1610 MHz shall be limited to $-70 \text{ dBW/MHz}(-40 \text{ dBm/MHz})$ equivalent isotropically radiated power (EIRP) for wideband signals, and $-80 \text{ dBW}(-50 \text{ dBm})$ EIRP for discrete emissions of less than 700 Hz bandwidth. For the purpose of equipment authorization, a transmitter shall be tested with an antenna that is representative of the type that will be used with the equipment in normal operation.

Test Procedures :

The EUT was placed on a non-conductive rotating platform 1 meters high in a fully anechoic chamber. The radiated emission at the fundamental frequency was measured at 3 m with a test antenna. The maximum emission was recorded from analyzer power level (LVL) from the 360 degrees rotation of the turntable.

Effective Isotropic Radiated Power (EIRP) was measured by substitution method according to TIA/EIA-603-C.

The EUT was replaced by substitution antenna at same location, and then a known power from S.G. was applied into the dipole antenna through a Tx cable, and then recorded the maximum Analyzer reading through raised and lowered the test antenna.

The space loss (in dB) = S.G. - Tx Cable loss + Substitution antenna gain - Analyzer reading.

The spectrum was searched from 30 MHz to 10th harmonic.

Test Setup :

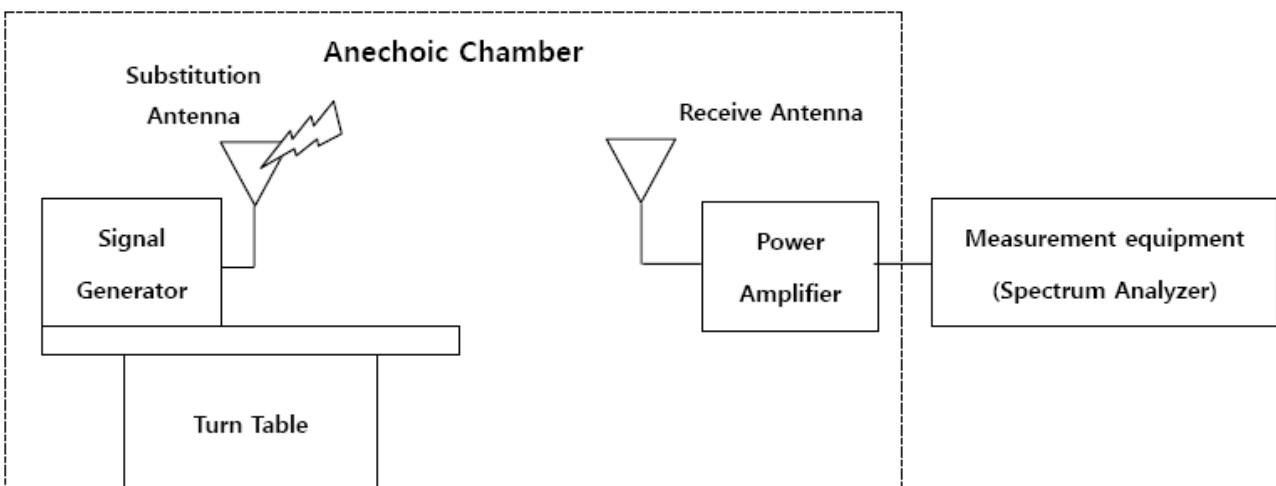
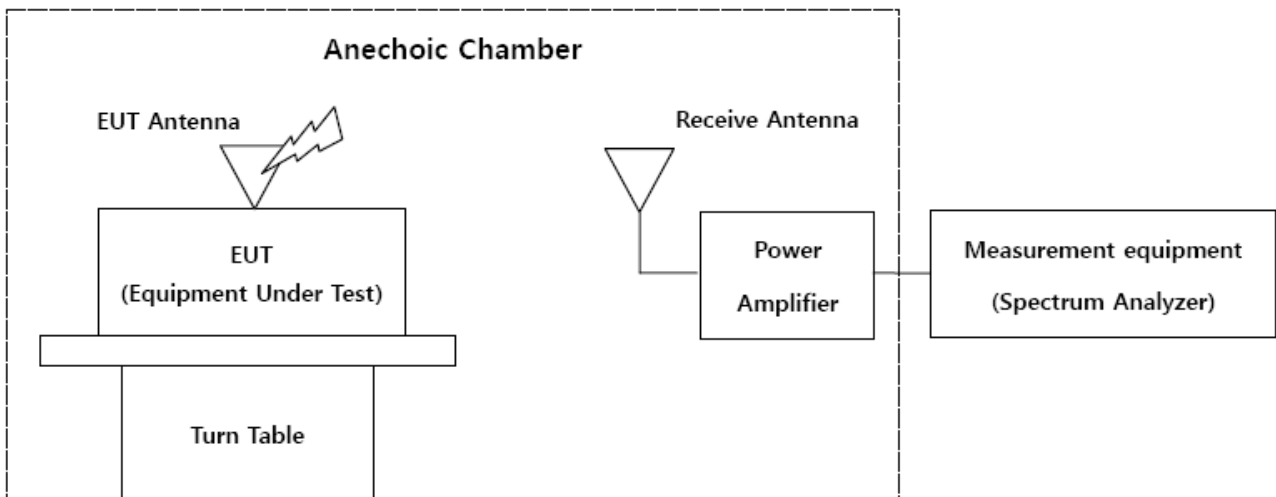

Test Results :

- * We have done all test case. Test datas were only the worst case.
- * In all test cases, the measurement results in the following measurement bands are similar.
 (30 MHz - 1 GHz, 18 GHz - 26.5 GHz)

[30 MHz - 1 GHz]

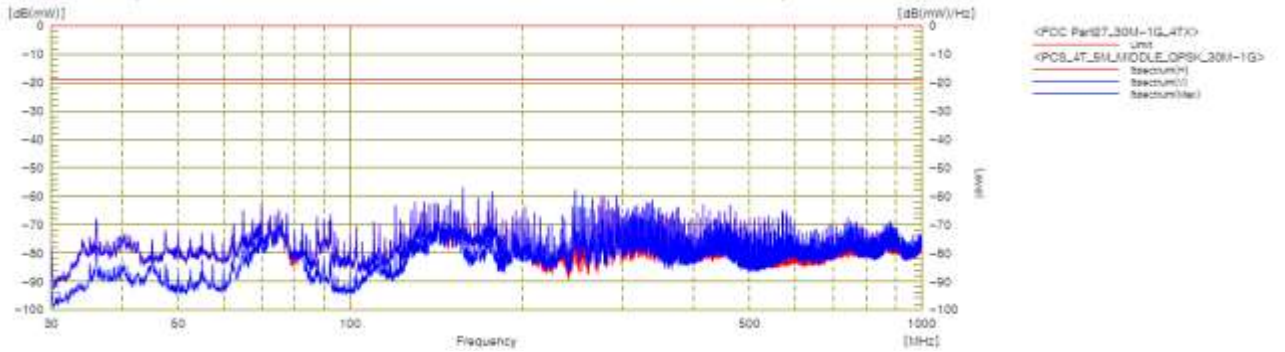

[18 GHz - 26.5 GHz]

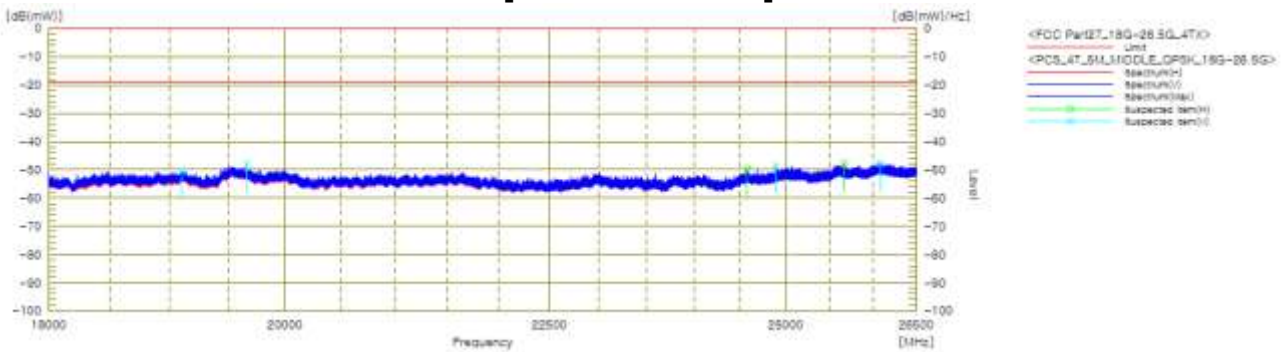



[1GHz - 18 GHz]

Band 2, BW 10MHz, Single carrier, 4TX

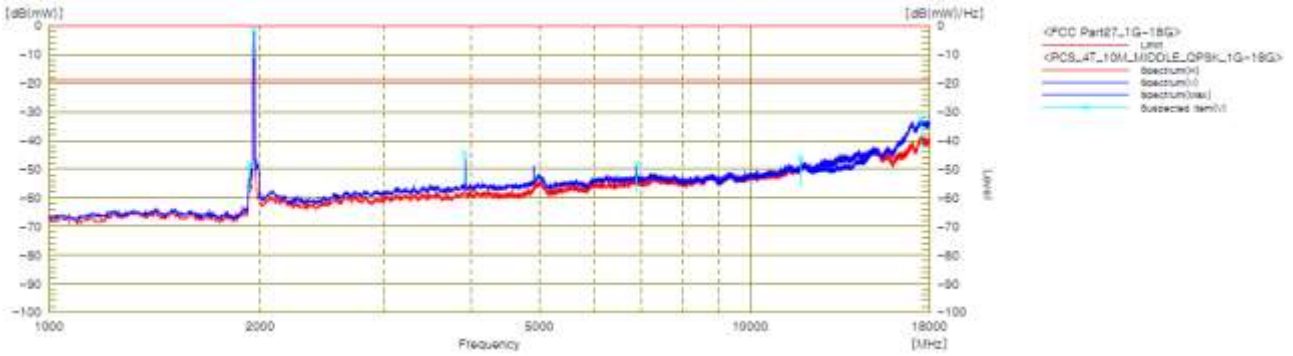

Band 2, BW 20MHz, Single carrier, 4TX

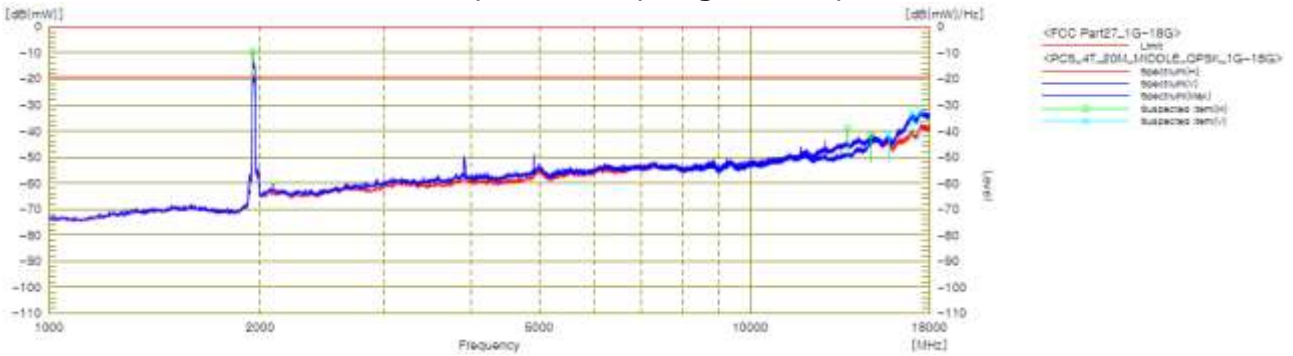

Band 2, BW 10MHz + BW 10 MHz, Single carrier, 4TX

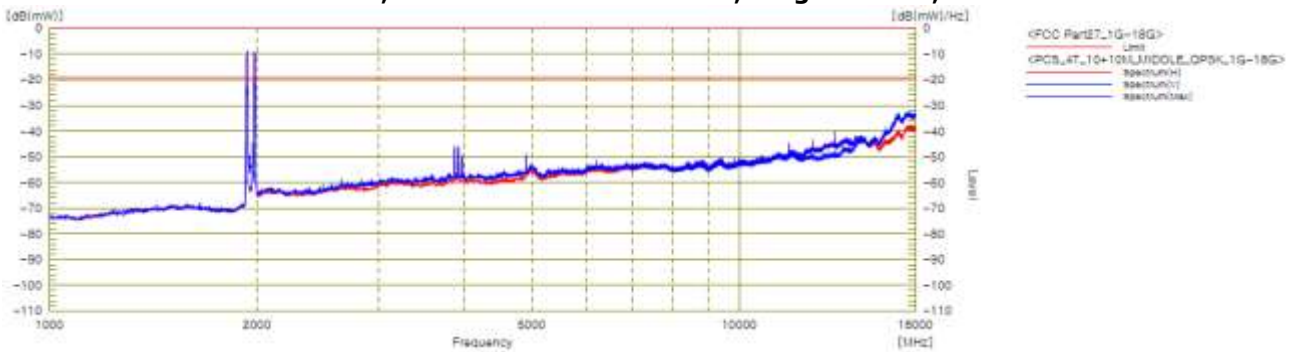

	CTK Co., Ltd. (Ho-dong), 113, Yejik-ro, Cheoin-gu, Yongin-si, Gyeonggi-do, Korea Tel: +82-31-339-9970 Fax: +82-31-624-9501	Report No.: CTK-2017-01618-2 Page (280) / (282) Pages	
---	---	--	--

8. Frequency Stability

Test Requirements :

§ 2.1055 Measurements required : Frequency stability.

- (a) The frequency stability shall be measured with variation of ambient temperature as follows:
- (1) From -30° to $+50^{\circ}$ centigrade for all equipment except that specified in paragraphs (a) (2) and (3) of this section.
 - (2) From -20° to $+50^{\circ}$ centigrade for equipment to be licensed for use in the Maritime Services under part 80 of this chapter, except for Class A, B, and S Emergency Position Indicating Radiobeacons (EPIRBS), and equipment to be licensed for use above 952 MHz at operational fixed stations in all services, stations in the Local Television Transmission Service and Point-to-Point Microwave Radio Service under part 21 of this chapter, equipment licensed for use aboard aircraft in the Aviation Services under part 87 of this chapter, and equipment authorized for use in the Family Radio Service under part 95 of this chapter.
 - (3) From 0° to $+50^{\circ}$ centigrade for equipment to be licensed for use in the Radio Broadcast Services under part 73 of this chapter.
- (b) The frequency stability shall be measured with variation of primary supply voltage as follows:
- (1) Vary primary supply voltage from 85 to 115 percent of the nominal value for other than hand carried battery equipment.

§ 27.54 Frequency stability

The frequency stability shall be sufficient to ensure that the fundamental emissions stay within the authorized bands of operation.

Test Procedures :

- (a) Device is placed at the oven room. The oven room could control the temperatures and humidity. Power warm up is at least 15 min and power applied should perform before recording frequency error.
- (b) The test voltage range is from minimum to maximum working voltage. Each step shall be record the frequency error rate.
- (c) The temperature range step is 10 degrees in this test items. All temperature levels shall be hold the $\pm 0.5^{\circ}\text{C}$ during the measurement testing. The each temperature step shall be at least 0.5 hours, consider the EUT could be test under the stability condition.



CTK Co., Ltd.
 (Ho-dong), 113, Yejik-ro, Cheoin-gu,
 Yongin-si, Gyeonggi-do, Korea
 Tel: +82-31-339-9970
 Fax: +82-31-624-9501

Report No.:
 CTK-2017-01618-2
 Page (281) / (282)
 Pages

Test Results :

**Test Data at output Antenna Port 7
 Band 2, BW 10MHz, Single carrier, 4TX**

Voltage (%)	Temperature (°C)	Frequency Error (Hz)	Frequency Error (ppm)
100	+20	-820.64	-0.41869
	-30	-820.93	-0.41884
	-20	-820.35	-0.41855
	-10	-821.47	-0.41912
	0	-820.69	-0.41872
	+10	-820.33	-0.41854
	+30	-820.18	-0.41846
	+40	-821.24	-0.41900
115	+20	-820.63	-0.41869
	+50	-821.56	-0.41916
85	+20	-820.47	-0.41861

Band 2, BW 20MHz, Single carrier, 4TX

Voltage (%)	Temperature (°C)	Frequency Error (Hz)	Frequency Error (ppm)
100	+20	-821.39	-0.41908
	-30	-822.07	-0.41942
	-20	-822.65	-0.41972
	-10	-822.14	-0.41946
	0	-822.75	-0.41977
	+10	-822.63	-0.41971
	+30	-822.69	-0.41974
	+40	-822.55	-0.41967
115	+50	-822.56	-0.41967
	+20	-821.65	-0.41921
85	+20	-821.63	-0.41920

Note:

The results of the frequency stability test shown above the frequency deviation measured values are very small and similar trend for each port, so attached data was only the port 7.



CTK Co., Ltd.
 (Ho-dong), 113, Yejik-ro, Cheoin-gu,
 Yongin-si, Gyeonggi-do, Korea
 Tel: +82-31-339-9970
 Fax: +82-31-624-9501

Report No.:
 CTK-2017-01618-2
 Page (282) / (282)
 Pages

APPENDIX A – Test Equipment Used For Tests

	Name of Equipment	Manufacturer	Model No.	Serial No.	Due Date
1	MXA Signal Analyzer	Agilent	N9020A	MY50510324	2018-02-03
2	EMI Test Receiver	R&S	ESCI7	100814	2017-11-01
3	MXA Signal Analyzer	Agilent	N9020A	MY48011598	2017-11-01
4	Bilog Antenna	Schaffner	CBL6111C	2551	2018-05-13
5	Biconical Antenna	SCHWARZBECK	VUBA 9117	9117-280	2018-11-11
6	6dB Attenuator	R&S	DNF	272.4110.50-1	2018-02-03
7	AMPLIFIER	SONOMA	310	291721	2018-02-02
8	Horn Antenna	ETS-Lindgren	3115	00078894	2017-09-02
9	Horn Antenna	ETS-Lindgren	3115	00078895	2019-04-25
10	Signal Generator	R&S	SMB100A	175528	2017-11-01
11	PREAMPLIFIER	Agilent	8449B	3008A02011	2017-12-01
12	Fixed Attenuator(30 dB, 300W)	BIRD	300-WA-MFN-30	0026689	2018-04-13
13	Fixed Attenuator(30 dB, 300W)	BIRD	300-WA-MFN-30	0026694	2018-03-07
14	Fixed Attenuator(30 dB, 300W)	BIRD	300-WA-MFN-30	0026760	2018-03-07
15	Fixed Attenuator(30 dB, 300W)	BIRD	300-WA-MFN-30	0026687	2018-03-07
16	Fixed Attenuator(30 dB, 300W)	BIRD	300-WA-MFN-30	0026743	2018-03-07
17	Fixed Attenuator(30 dB, 300W)	BIRD	300-WA-MFN-30	0026742	2018-03-07
18	Fixed Attenuator(30 dB, 300W)	BIRD	300-WA-MFN-30	0026683	2018-03-07
19	Fixed Attenuator(30 dB, 300W)	BIRD	300-WA-MFN-30	0403007	2018-04-30
20	Temp & Humidity Chamber	Kunpoong	JT-TH-556-2	9QE5-003	2018-02-02
21	DC POWER SUPPLY	Agilent	6674A	MY41001323	2018-03-27
22	System Power Supply	HP	6032A	3440A-10521	2018-02-02