

# **CERTIFICATION TEST REPORT**

## **CLASS II PERMISSIVE CHANGE**

**Report Number.** : 4790941139-FR1V1

**Applicant** : SAMSUNG ELECTRONICS CO., LTD.  
129 SAMSUNG-RO, YEONGTONG-GU, SUWON-SI,  
GYEONGGI-DO, 16677, KOREA

**Model** : RF4442d-13B

**FCC ID** : A3LRF4442D-13B

**EUT Description** : RRU (RF4442d)

**Test Standard(s)** : FCC 47 CFR PART 22

**Date Of Issue:**  
2023-08-28

**Prepared by:**  
UL KOREA, LTD.  
26th floor, 152, Teheran-ro, Gangnam-gu Seoul, 06236, Korea

Suwon Test Site: UL KOREA, LTD. Suwon Laboratory  
218 Maeyeong-ro, Yeongtong-gu,  
Suwon-si, Gyeonggi-do, 16675, Korea  
TEL: (031) 337-9902  
FAX: (031) 213-5433

Revision History

<u>Rev.</u>	<u>Issue Date</u>	<u>Revisions</u>	<u>Revised By</u>
V1	2023-08-28	Initial issue	Jaejin Lee

## TABLE OF CONTENTS

<b>1. ATTESTATION OF TEST RESULTS</b> .....	<b>4</b>
1.1. INTRODUCTION OF TEST DATA REUSE.....	5
1.2. DIFFERENCE.....	5
<b>2. TEST METHODOLOGY</b> .....	<b>5</b>
<b>3. FACILITIES AND ACCREDITATION</b> .....	<b>5</b>
<b>4. CALIBRATION AND UNCERTAINTY</b> .....	<b>6</b>
4.1. MEASURING INSTRUMENT CALIBRATION.....	6
4.2. SAMPLE CALCULATION.....	6
4.3. MEASUREMENT UNCERTAINTY.....	6
4.4. DECISION RULE.....	6
<b>5. EQUIPMENT UNDER TEST</b> .....	<b>7</b>
5.1. DESCRIPTION OF EUT.....	7
5.2. EUT INFORMATION.....	7
5.3. DESCRIPTION OF TEST.....	8
<b>6. TEST AND MEASUREMENT EQUIPMENT</b> .....	<b>10</b>
<b>7. SUMMARY TABLE</b> .....	<b>11</b>
<b>8. LIMITS AND CONDUCTED RESULTS</b> .....	<b>12</b>
8.1. RF OUTPUT POWER.....	12
8.1.1. RF OUTPUT POWER RESULTS.....	14
8.1.2. WORST PLOT OF RF OUTPUT POWER.....	18
8.1.3. PSD RESULTS.....	20
8.1.4. WORST PLOT OF PSD.....	24
8.2. PEAK TO AVERAGE RATIO (PAR).....	26
8.2.1. PEAK TO AVERAGE RATIO (PAR) RESULTS.....	27
8.2.2. WORST PLOT OF PEAK TO AVERAGE RATIO (PAR).....	29
8.3. OCCUPIED BANDWIDTH.....	31
8.3.1. OCCUPIED BANDWIDTH RESULTS.....	32
8.3.2. WORST PLOT OF OCCUPIED BANDWIDTH.....	35
8.4. OUT OF BAND EMISSIONS (BAND EDGE).....	37
8.4.1. OUT OF BAND EMISSIONS (BAND EDGE).....	40
8.4.2. WORST PLOT OF OUT OF BAND EMISSIONS (BAND EDGE).....	44
8.5. OUT OF BAND EMISSIONS (SPURIOUS).....	47
8.5.1. CONDUCTED SPURIOUS EMISSIONS RESULT.....	50
8.5.2. WORST PLOT OF OUT OF BAND EMISSIONS (SPURIOUS).....	54
8.6. FREQUENCY STABILITY.....	69
8.6.1. FREQUENCY STABILITY RESULTS.....	70
8.7. RADIATED EMISSIONS.....	71
8.7.1. SPURIOUS RADIATION RESULTS.....	73

# 1. ATTESTATION OF TEST RESULTS

**COMPANY NAME:** SAMSUNG ELECTRONICS CO., LTD.  
**EUT DESCRIPTION:** RRU (RF4442d)  
**MODEL NUMBER:** RF4442d-13B  
**SERIAL NUMBER:** S617640109  
**DATE TESTED:** 2023-08-03 ~ 2023-08-25

APPLICABLE STANDARDS	
STANDARD	TEST RESULTS
47 CFR Part 22	Complies

UL KOREA, LTD. tested the above equipment in accordance with the requirements set forth in the above standards. All indications of Pass/Fail in this report are opinions expressed by UL KOREA, LTD. based on interpretations and/or observations of test results. Measurement Uncertainties were not taken into account and are published for informational purposes only. The test results show that the equipment tested is capable of demonstrating compliance with the requirements as documented in this report.

**Note:** The results documented in this report apply only to the tested sample, under the conditions and modes of operation as described herein. This document may not be altered or revised in any way unless done so by UL KOREA, LTD. and all revisions are duly noted in the revisions section. Any alteration of this document not carried out by UL KOREA, LTD. will constitute fraud and shall nullify the document. This report must not be used by the client to claim product certification, approval, or endorsement by IAS, any agency of the Federal Government, or any agency of any government.

Approved & Released For  
UL KOREA, LTD. By:

Tested By:

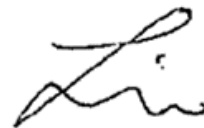

Seokhwan Hong  
Suwon Lab Engineer  
UL KOREA, LTD.

Jaejin Lee  
Suwon Lab Engineer  
UL KOREA, LTD.

## 1.1. INTRODUCTION OF TEST DATA REUSE

This report was referenced from the conducted data of FCC ID: A3LRF4442D-13A.(test report No.4790941135-FR1)

And the applicant takes full responsibility that the test data as referenced in this report represent compliance for this FCC ID.

## 1.2. DIFFERENCE

The FCC ID : A3LRF4442D-13A is powered by DC voltage source. For FCC ID : A3LRF4442D-13B is powered by AC voltage source which is only different power supply condition that no affect to RF parameters. This device has the same HW and SW capabilities with the device referenced except for power supply.

Reused data is only conducted data. Radiated test was performed.

## 2. TEST METHODOLOGY

The tests documented in this report were performed in accordance with following methods.

1. FCC CFR 47 Part 2.
2. FCC CFR 47 Part 22.
3. ANSI C63.26, 2015
4. KDB 971168 D01 Power Meas License Digital Systems v03r01
5. KDB 662911 D01 Multiple Transmitter Output v02r01

## 3. FACILITIES AND ACCREDITATION

The test sites and measurement facilities used to collect data are located at 218 Maeyeong-ro, Yeongtong-gu, Suwon-si, Gyeonggi-do, 16675, Korea. Line conducted emissions are measured only at the 218 address. The following table identifies which facilities were utilized for radiated emission measurements documented in this report. Specific facilities are also identified in the test results sections.

218 Maeyeong-ro	
<input type="checkbox"/>	Chamber 1
<input type="checkbox"/>	Chamber 2
<input type="checkbox"/>	Chamber 3
<input checked="" type="checkbox"/>	10m Chamber

UL KOREA, LTD. is accredited by IAS, Laboratory Code TL-637. The full scope of accreditation can be viewed at <https://www.iasonline.org/wp-content/uploads/2017/05/TL-637-cert-New.pdf>.

## 4. CALIBRATION AND UNCERTAINTY

### 4.1. MEASURING INSTRUMENT CALIBRATION

The measuring equipment utilized to perform the tests documented in this report has been calibrated in accordance with the manufacturer's recommendations, and is traceable to recognized national standards.

### 4.2. SAMPLE CALCULATION

Where relevant, the following sample calculation is provided:

$EIRP = \text{PSA reading with EUT worst orientation (dBm)} + \text{Path loss (dB)} - \text{cable loss (between the SG and substitution antenna)} + \text{Substitution Antenna Factor (dBi)}$

$ERP = \text{PSA reading with EUT worst orientation (dBm)} + \text{Path loss (dB)} - \text{cable loss (between the SG and substitution antenna)}$

(Path loss = Signal generator output – PSA reading with substitution antenna)

### 4.3. MEASUREMENT UNCERTAINTY

Where relevant, the following measurement uncertainty levels have been estimated for tests performed on the apparatus:

PARAMETER	UNCERTAINTY
Conducted Output Power	1.3 dB
Occupied Bandwidth	36 kHz
Conducted Spurious Emissions	1.3 dB
Radiated Disturbance, 30 MHz to 1 GHz	4.1 dB
Radiated Disturbance, >1 GHz	4.6 dB

Uncertainty figures are valid to a confidence level of 95%.

### 4.4. DECISION RULE

Decision rule for statement(s) of conformity is based on Procedure 2, Clause 4.4.3 in IEC Guide 115:2021.

## 5. EQUIPMENT UNDER TEST

### 5.1. DESCRIPTION OF EUT

The EUT is a RRU (RF4442d) Base Station .

### 5.2. EUT INFORMATION

<b>Power Supply</b>	120 Vac, 60 Hz				
<b>Frequency Range</b>	Band (n5) TX (Downlink): 869 MHz ~ 894 MHz				
	RX (Uplink) : 824 MHz ~ 849 MHz				
<b>Antenna port</b>	4TX/RX (Port 1, 2, 3, 4)				
<b>Power Configuration</b>	4TX : MAX 160 W / RU, 40 W / path				
<b>Supporting Channel BW</b>	LTE: 5/10 MHz NR: 5/10/15/20 MHz DSS: 10 MHz				
<b>Number of CCs</b>	Max 3CC				
<b>Operating mode</b>	LTE only : Max 3CC NR only : Max 2CC DSS only : Max 2CC LTE +NR : Max 3CC with up to NR 2CC LTE +DSS : Max 3CC with up to DSS 2CC LTE +DSS+ NR : 3CC ( LTE 1CC+ DSS 1CC + NR 1CC)				
<b>TX Output Power</b>	<b>Band</b>	<b>Carrier</b>	<b>Bandwidth</b>	<b>Max. Conducted Output Power (W)</b>	
				<b>QPSK</b>	<b>QAM</b>
	5G NR n5 (4TX)	1	20 MHz	38.34	38.35
	5G NR n5 + 5G NR n5 (4TX)	2	20 MHz + 5 MHz	36.45	37.56
	5G NR n5 + LTE B5 (4TX)	2	20 MHz + 5 MHz	37.22	37.76
<b>Emission Designator</b>	<b>Band</b>	<b>Carrier</b>	<b>Bandwidth</b>	<b>Emission Designator</b>	
				<b>QPSK</b>	<b>QAM</b>
	5G NR n5 (4TX)	1	20 MHz	18M9G7D	19M0W7D
	5G NR n5 + 5G NR n5 (4TX)	2	20 MHz + 5 MHz	24M1G7D	24M2W7D
	5G NR n5 + LTE B5 (4TX)	2	20 MHz + 5 MHz	24M2G7D	24M2W7D
<b>Modulation Type</b>	QPSK, 16QAM, 64QAM, 256QAM				
<b>Division Duplex</b>	FDD				
<b>Antenna Specification</b>	Antenna is not provided by manufacturer				

### 5.3. DESCRIPTION OF TEST

- The EUT was operated in a manner representative of the typical usage of the equipment.
- During all testing, system components were manipulated within the confines of typical usage to maximize each emission.
- All modulation types (QPSK, 16QAM, 64QAM, 256QAM) supported by the EUT have been tested.
- All mode of operation, supporting bandwidth and frequencies were investigated. The test plots shown in the following sections represent the worst case emissions.
- The dummy loads were connected to the RF output ports for radiated spurious emission testing.
- This test is for adding 5G NR single bandwidth 20MHz and accordingly multi carrier combinations.
- Single-carrier (Bandwith 20MHz) mode was all tested.
- Among the multi-carrier combinations, only worst case combinations have been tested in this test report to cover all multi-carrier combinations addressed in technical documents.
- Multi-carriers use a similar approach to check output power and the total power is equal to all multi-carrier bandwidth combinations.
- This device was tested at 100 % duty cycle.



**SETUP DIAGRAM FOR TESTS (CONDUCTED TEST SETUP)**

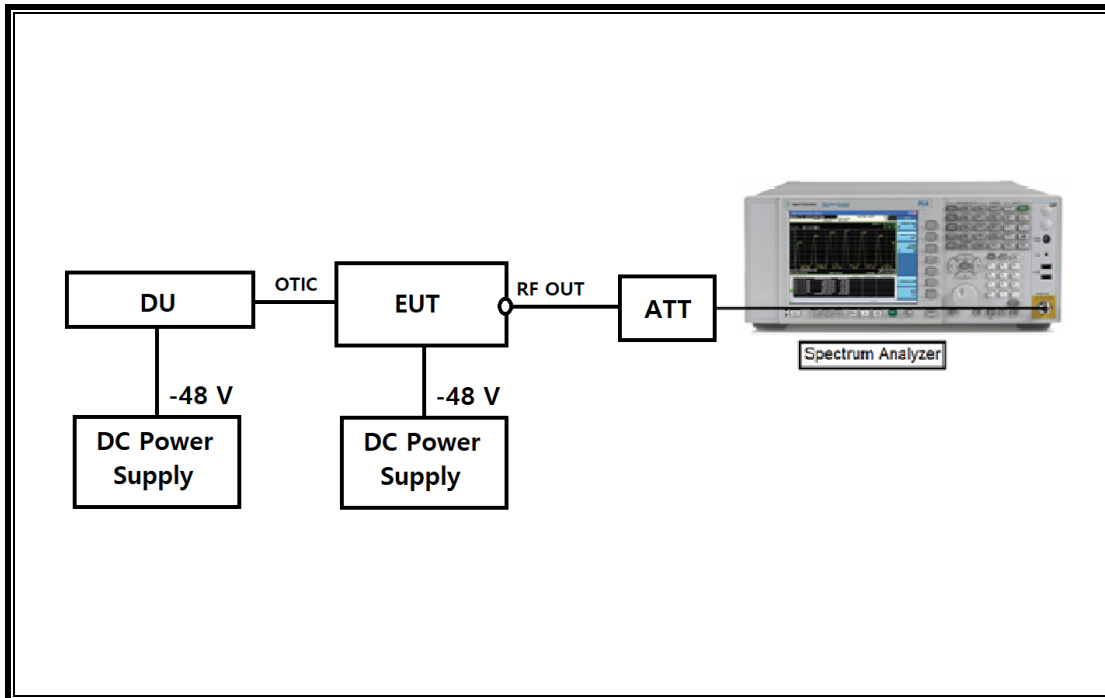

**SETUP DIAGRAM FOR TESTS (RADIATED TEST SETUP)**

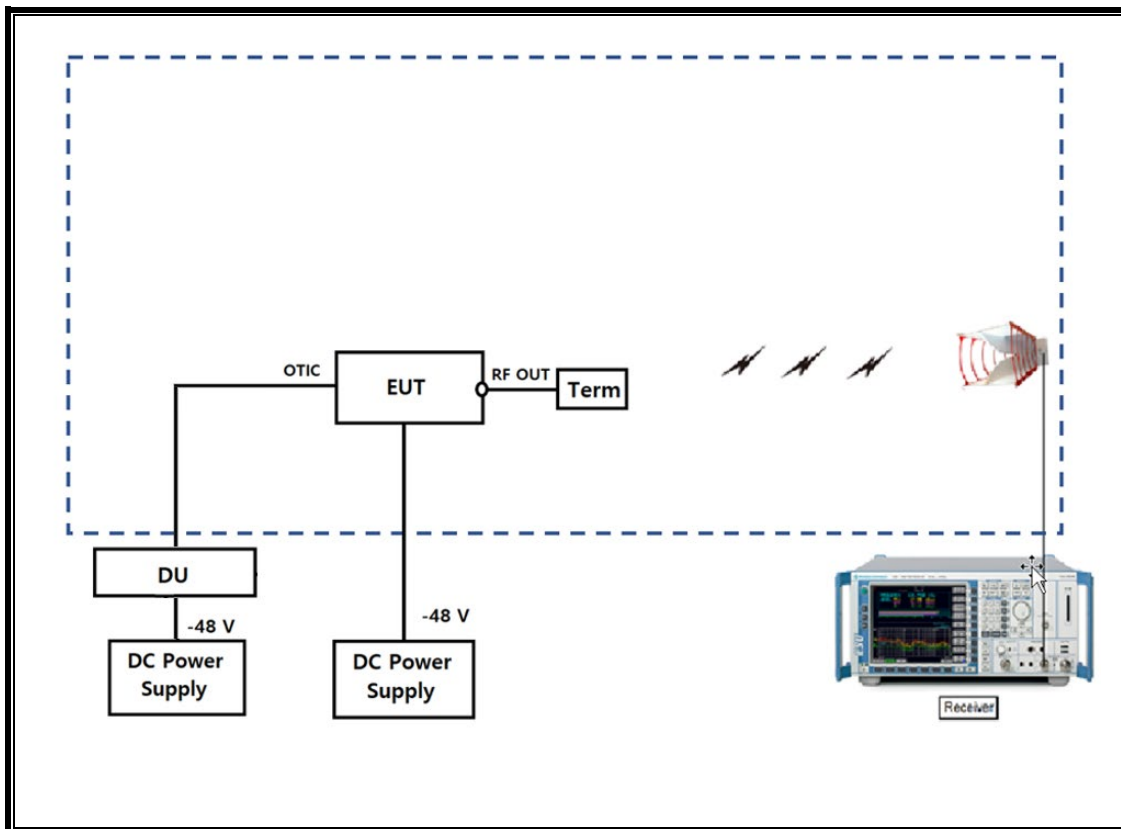

## 6. TEST AND MEASUREMENT EQUIPMENT

The following test and measurement equipment was utilized for the tests documented in this report:

Test Equipment List				
Description	Manufacturer	Model	S/N	Cal Due
Spectrum Analyzer	KEYSIGHT	N9030B	MY57143717	2024-07-24
DC Power Supply	KIKUSUI	PWR2001ML	AQ000860	2024-07-24
DC Power Supply	KIKUSUI	PWR2001ML	AX000660	2024-07-24
Walk in chamber	ENEX SCIENCE	EN-RC-2004-1K	EN20200711	2024-07-26
RF Switching Unit	TA Engineering	TA-018S-16	SW-1	N/A
ATTENUATOR	WEINSCHTEL	WA96-30-0303	1	2024-07-26
ATTENUATOR	WEINSCHTEL	WA96-30-0303	2	2024-07-26
ATTENUATOR	WEINSCHTEL	WA96-30-0303	3	2024-07-26
ATTENUATOR	WEINSCHTEL	WA96-30-0303	4	2024-07-26
ATTENUATOR	WEINSCHTEL	56-10	61105	2024-07-24
EMI Test Receiver	R&S	ESW44	101848	2024-07-26
Open Switch and Control Platform	R&S	OSP220	101456	N/A
TRILOG Broadband Antenna	SCHWARZBECK	VULB9163	1242	2024-11-16
Double-Ridged Guide Antenna	ETS Lindgren	3117	227048	2025-07-25
Pre-Amplifier	R&S	SCU08F2	100725	2024-07-26
Pre-Amplifier	R&S	SCU18F	100726	2024-07-25
Filter	MICRO-TRONICS	HPM50115-02	G003	2024-07-24
Temp and Humidity recorder	LUTRON	MHB-382SD	AJ.84563	2024-07-26

## 7. SUMMARY TABLE

FCC Part Section	Test Description	Test Condition	Test Result
§2.1046 §22.913	RF Output Power	Conducted	Complies
§22.913	Peak-to-Average Ratio (PAR)		Complies
§2.1049	Occupied Bandwidth		Complies
§2.1051 §22.917	Out of band emissions (Band Edge)		Complies
	Out of band emissions (Spurious)		Complies
§2.1055	Frequency Stability	Complies	
§2.1053 §22.917	Radiated Emissions	Radiated	Complies

## 8. LIMITS AND CONDUCTED RESULTS

### 8.1. RF OUTPUT POWER

#### RULE PART(S)

FCC : §2.1046, §22.913

#### LIMITS

§22.913

Licensees in the Cellular Radiotelephone Service are subject to the effective radiated power (ERP) limits and other requirements in this Section. See also § 22.169.

(a) Maximum ERP. The ERP of transmitters in the Cellular Radiotelephone Service must not exceed the limits in this section.

(1) Except as described in paragraphs (a)(2), (3), and (4) of this section, the ERP of base stations and repeaters must not exceed—

- (i) 500 watts per emission; or
- (ii) 400 watts/MHz (PSD) per sector.

(2) Except as described in paragraphs (a)(3) and (4) of this section, for systems operating in areas more than 72 kilometers (45 miles) from international borders that:

- (i) Are located in counties with population densities of 100 persons or fewer per square mile, based upon the most recently available population statistics from the Bureau of the Census; or
- (ii) Extend coverage into Unserved Area on a secondary basis (see § 22.949), the ERP of base transmitters and repeaters must not exceed—

- (A) 1000 watts per emission; or
- (B) 800 watts/MHz (PSD) per sector.

(3) Provided that they also comply with paragraphs (b) and (c) of this section, licensees are permitted to operate their base transmitters and repeaters with an ERP greater than 400 watts/MHz (PSD) per sector, up to a maximum ERP of 1000 watts/MHz (PSD) per sector unless they meet the conditions in paragraph (a)(4) of this section.

(4) Provided that they also comply with paragraphs (b) and (c) of this section, licensees of systems operating in areas more than 72 kilometers (45 miles) from international borders that:

- (i) Are located in counties with population densities of 100 persons or fewer per square mile, based upon the most recently available population statistics from the Bureau of the Census; or
- (ii) Extend coverage into Unserved Area on a secondary basis (see § 22.949), are permitted to operate base transmitters and repeaters with an ERP greater than 800 watts/MHz (PSD) per sector, up to a maximum of 2000 watts/MHz (PSD) per sector.

(5) The ERP of mobile transmitters and auxiliary test transmitters must not exceed 7 watts.

## **TEST PROCEDURE**

Section 5.2.4.4.1 of ANSI C63.26:

- a) Set span to  $2 \times$  to  $3 \times$  the OBW.
  - b) Set RBW = 1 % to 5 % of the OBW.
  - c) Set VBW  $\geq 3 \times$  RBW.
  - d) Set number of measurement points in sweep  $\geq 2 \times$  span / RBW.
  - e) Sweep time:
    - 1) Set = auto-couple, or
    - 2) Set  $\geq [10 \times (\text{number of points in sweep}) \times (\text{transmission symbol period})]$  for single sweep (automation-compatible) measurement.
  - f) Detector = power averaging (rms).
  - g) If the EUT can be configured to transmit continuously, then set the trigger to free run.
  - h) If the EUT cannot be configured to transmit continuously, then use a sweep trigger with the level set to enable triggering only on full power bursts and configure the EUT to transmit at full power for the entire duration of each sweep. Verify that the sweep time is less than or equal to the transmission burst duration. Time gating can also be used under similar constraints (i.e., configured such that measurement data is collected only during active full-power transmissions).
  - i) Trace average at least 100 traces in power averaging (rms) mode if sweep is set to auto-couple. To accurately determine the average power over multiple symbols, it can be necessary to increase the number of traces to be averaged above 100 or, if using a manually configured sweep time, increase the sweep time.
  - j) Compute the power by integrating the spectrum across the OBW of the signal using the instrument's band or channel power measurement function, with the band/channel limits set equal to the OBW band edges. If the instrument does not have a band or channel power function, then sum the spectrum levels (in linear power units) at intervals equal to the RBW extending across the entire OBW of the spectrum.
- Sum of results (dBm) =  $10 \log\{10^{(\text{ANT1 (dBm)}/10)} + 10^{(\text{ANT2 (dBm)}/10)} + \dots + 10^{(\text{ANT}_N \text{ (dBm)}/10)}\}$

## **RESULTS**

See the following pages.

### 8.1.1. RF OUTPUT POWER RESULTS

**5G NR n5 20 MHz (1 Carrier) – 4TX**

ANT	Modulation	CH	Frequency (MHz)	Output Power @ ANT	
				Measured value (dBm)	Result (W)
1	QPSK	L	879	39.89	9.74
		M	881.5	39.84	9.64
		H	884	<b>39.93</b>	<b>9.85</b>
	16QAM	L	879	39.84	9.65
		M	881.5	39.85	9.65
		H	884	39.86	9.68
	64QAM	L	879	39.81	9.56
		M	881.5	<b>39.90</b>	<b>9.77</b>
		H	884	39.89	9.76
	256QAM	L	879	39.82	9.60
		M	881.5	39.83	9.61
		H	884	39.82	9.60
2	QPSK	L	879	39.58	9.07
		M	881.5	39.52	8.95
		H	884	39.76	9.47
	16QAM	L	879	39.68	9.30
		M	881.5	39.66	9.25
		H	884	39.76	9.46
	64QAM	L	879	39.64	9.20
		M	881.5	39.68	9.29
		H	884	39.73	9.39
	256QAM	L	879	39.73	9.40
		M	881.5	39.68	9.28
		H	884	39.74	9.41
3	QPSK	L	879	39.67	9.27
		M	881.5	39.69	9.31
		H	884	39.79	9.52
	16QAM	L	879	39.66	9.25
		M	881.5	39.52	8.96
		H	884	39.68	9.29
	64QAM	L	879	39.64	9.20
		M	881.5	39.69	9.32
		H	884	39.76	9.47
	256QAM	L	879	39.69	9.32
		M	881.5	39.88	9.73
		H	884	39.84	9.63

ANT	Modulation	CH	Frequency (MHz)	Output Power @ ANT	
				Measured value (dBm)	Result (W)
4	QPSK	L	879	39.77	9.49
		M	881.5	39.74	9.41
		H	884	39.78	9.51
	16QAM	L	879	39.71	9.36
		M	881.5	39.82	9.58
		H	884	39.85	9.67
	64QAM	L	879	39.74	9.41
		M	881.5	39.81	9.58
		H	884	39.83	9.62
	256QAM	L	879	39.75	9.43
		M	881.5	39.88	9.72
		H	884	39.83	9.62

CH	Frequency (MHz)	Sum of Output Power (W)			
		@ ANT ALL			
		QPSK	16QAM	64QAM	256QAM
L	879	37.58	37.55	37.37	37.74
M	881.5	37.31	37.45	37.95	<b>38.35</b>
H	884	38.34	38.10	38.24	38.26

Modulation	Maximum Sum of Output Power	
	@ ANT ALL	
	W	dBm
G7D	38.34	45.84
W7D	38.35	45.84

**5G NR n5 20 MHz 1C + 5G NR n5 5 MHz 1C (2 Carrier) – 4TX – Contiguous**

ANT	Modulation	CH	Frequency (MHz)	Output Power @ ANT	
				Measured value (dBm)	Result (W)
1	QPSK	M	879 + 891.5	39.55	9.02
	16QAM	M	879 + 891.5	39.77	9.49
	64QAM	M	879 + 891.5	<b>39.80</b>	<b>9.55</b>
	256QAM	M	879 + 891.5	39.69	9.31
2	QPSK	M	879 + 891.5	39.57	9.06
	16QAM	M	879 + 891.5	39.62	9.16
	64QAM	M	879 + 891.5	39.60	9.12
	256QAM	M	879 + 891.5	39.54	8.99
3	QPSK	M	879 + 891.5	39.57	9.06
	16QAM	M	879 + 891.5	39.71	9.34
	64QAM	M	879 + 891.5	39.74	9.42
	256QAM	M	879 + 891.5	39.75	9.44
4	QPSK	M	879 + 891.5	<b>39.69</b>	<b>9.31</b>
	16QAM	M	879 + 891.5	39.66	9.24
	64QAM	M	879 + 891.5	39.76	9.47
	256QAM	M	879 + 891.5	39.68	9.29

CH	Frequency (MHz)	Sum of Output Power (W) @ ANT ALL			
		QPSK	16QAM	64QAM	256QAM
M	879 + 891.5	36.45	37.23	<b>37.56</b>	37.03

Modulation	Maximum Sum of Output Power @ ANT ALL	
	W	dBm
G7D	36.45	45.62
W7D	37.56	45.75



**5G NR n5 20 MHz 1C + LTE B5 5 MHz 1C (2 Carrier) – 4TX - Contiguous**

ANT	Modulation	CH	Frequency (MHz)	Output Power @ ANT	
				Measured value (dBm)	Result (W)
1	QPSK	M	879 + 891.5	39.69	9.31
	16QAM	M	879 + 891.5	39.70	9.34
	64QAM	M	879 + 891.5	39.71	9.35
	256QAM	M	879 + 891.5	39.81	9.57
2	QPSK	M	879 + 891.5	39.52	8.95
	16QAM	M	879 + 891.5	39.60	9.12
	64QAM	M	879 + 891.5	39.62	9.15
	256QAM	M	879 + 891.5	39.63	9.18
3	QPSK	M	879 + 891.5	<b>39.79</b>	<b>9.52</b>
	16QAM	M	879 + 891.5	39.85	9.65
	64QAM	M	879 + 891.5	<b>39.86</b>	<b>9.69</b>
	256QAM	M	879 + 891.5	39.77	9.47
4	QPSK	M	879 + 891.5	39.75	9.43
	16QAM	M	879 + 891.5	39.84	9.63
	64QAM	M	879 + 891.5	39.81	9.57
	256QAM	M	879 + 891.5	39.76	9.47

CH	Frequency (MHz)	Sum of Output Power (W)			
		@ ANT ALL			
		QPSK	16QAM	64QAM	256QAM
M	879 + 891.5	37.22	37.75	37.76	37.69

Modulation	Maximum Sum of Output Power	
	@ ANT ALL	
	W	dBm
G7D	37.22	45.71
W7D	37.76	45.77

### 8.1.2. WORST PLOT OF RF OUTPUT POWER

#### 5G NR n5 20 MHz (1 Carrier) – 4TX

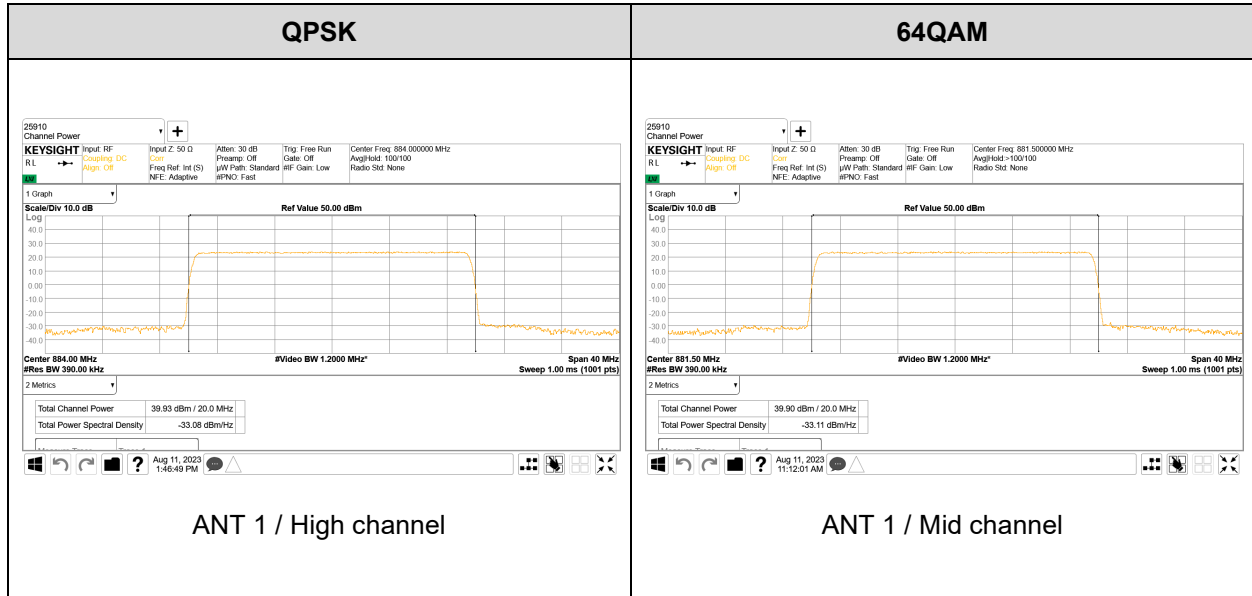

#### 5G NR n5 20 MHz 1C + 5G NR n5 5 MHz 1C (2 Carrier) – 4TX – Contiguous

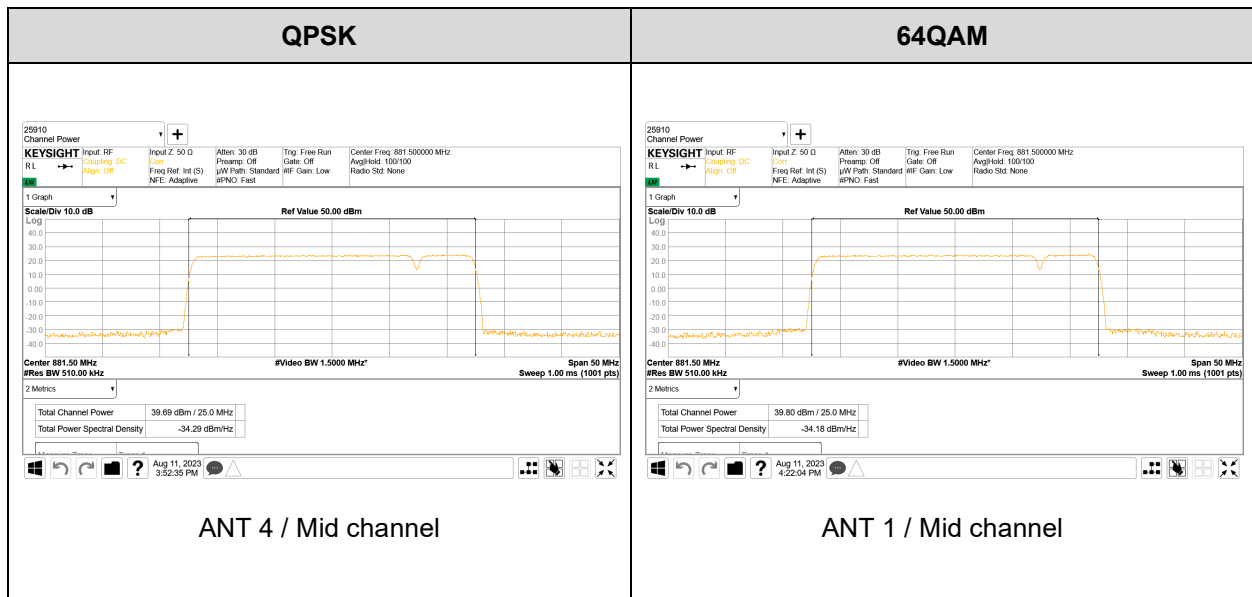

**5G NR n5 20 MHz 1C + LTE B5 5 MHz 1C (2 Carrier) – 4TX - Contiguous**

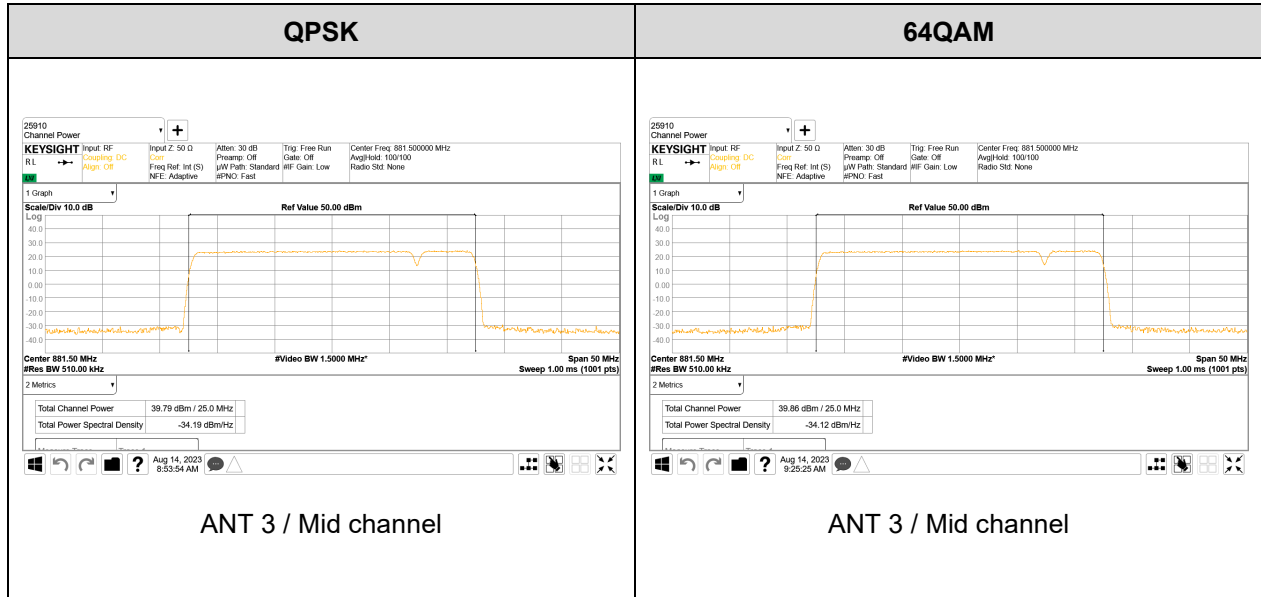

### 8.1.3. PSD RESULTS

#### 5G NR n5 20 MHz (1 Carrier) – 4TX

ANT	Modulation	CH	Frequency (MHz)	PSD @ ANT	
				Measured value (dBm/MHz)	Result (W/MHz)
1	QPSK	L	879	<b>27.88</b>	<b>0.61</b>
		M	881.5	27.64	0.58
		H	884	27.75	0.60
	16QAM	L	879	29.34	0.86
		M	881.5	29.21	0.83
		H	884	29.35	0.86
	64QAM	L	879	27.67	0.58
		M	881.5	27.74	0.59
		H	884	27.67	0.58
	256QAM	L	879	27.68	0.59
		M	881.5	27.65	0.58
		H	884	27.62	0.58
2	QPSK	L	879	27.60	0.58
		M	881.5	27.32	0.54
		H	884	27.63	0.58
	16QAM	L	879	29.32	0.86
		M	881.5	29.18	0.83
		H	884	29.21	0.83
	64QAM	L	879	27.60	0.58
		M	881.5	27.52	0.56
		H	884	27.63	0.58
	256QAM	L	879	27.61	0.58
		M	881.5	27.56	0.57
		H	884	27.62	0.58
3	QPSK	L	879	27.57	0.57
		M	881.5	27.52	0.56
		H	884	27.54	0.57
	16QAM	L	879	<b>29.40</b>	<b>0.87</b>
		M	881.5	29.00	0.79
		H	884	29.15	0.82
	64QAM	L	879	27.53	0.57
		M	881.5	27.52	0.56
		H	884	27.57	0.57
	256QAM	L	879	27.63	0.58
		M	881.5	27.68	0.59
		H	884	27.67	0.58

ANT	Modulation	CH	Frequency (MHz)	PSD @ ANT	
				Measured value (dBm/MHz)	Result (W/MHz)
4	QPSK	L	879	27.78	0.60
		M	881.5	27.55	0.57
		H	884	27.59	0.57
	16QAM	L	879	29.26	0.84
		M	881.5	29.34	0.86
		H	884	29.30	0.85
	64QAM	L	879	27.68	0.59
		M	881.5	27.70	0.59
		H	884	27.64	0.58
	256QAM	L	879	27.58	0.57
		M	881.5	27.78	0.60
		H	884	27.62	0.58

CH	Frequency (MHz)	Sum of PSD (W/MHz)			
		@ ANT ALL			
		QPSK	16QAM	64QAM	256QAM
L	879	2.36	<b>3.43</b>	2.31	2.32
M	881.5	2.25	3.31	2.31	2.34
H	884	2.32	3.37	2.32	2.32

**5G NR n5 20 MHz 1C + 5G NR n5 5 MHz 1C (2 Carrier) – 4TX – Contiguous**

ANT	Modulation	CH	Frequency (MHz)	PSD @ ANT	
				Measured value (dBm/MHz)	Result (W/MHz)
1	QPSK	M	879 + 891.5	26.66	0.46
	16QAM	M	879 + 891.5	<b>28.37</b>	<b>0.69</b>
	64QAM	M	879 + 891.5	26.90	0.49
	256QAM	M	879 + 891.5	26.81	0.48
2	QPSK	M	879 + 891.5	26.81	0.48
	16QAM	M	879 + 891.5	28.34	0.68
	64QAM	M	879 + 891.5	26.70	0.47
	256QAM	M	879 + 891.5	26.72	0.47
3	QPSK	M	879 + 891.5	26.69	0.47
	16QAM	M	879 + 891.5	28.33	0.68
	64QAM	M	879 + 891.5	26.90	0.49
	256QAM	M	879 + 891.5	26.85	0.48
4	QPSK	M	879 + 891.5	<b>26.83</b>	<b>0.48</b>
	16QAM	M	879 + 891.5	28.35	0.68
	64QAM	M	879 + 891.5	26.91	0.49
	256QAM	M	879 + 891.5	26.81	0.48

CH	Frequency (MHz)	Sum of PSD (W/MHz) @ ANT ALL			
		QPSK	16QAM	64QAM	256QAM
M	879 + 891.5	1.89	<b>2.73</b>	1.94	1.91

**5G NR n5 20 MHz 1C + LTE B5 5 MHz 1C (2 Carrier) – 4TX - Contiguous**

ANT	Modulation	CH	Frequency (MHz)	PSD @ ANT	
				Measured value (dBm/MHz)	Result (W/MHz)
1	QPSK	M	879 + 891.5	26.85	0.48
	16QAM	M	879 + 891.5	28.34	0.68
	64QAM	M	879 + 891.5	26.84	0.48
	256QAM	M	879 + 891.5	27.02	0.50
2	QPSK	M	879 + 891.5	26.62	0.46
	16QAM	M	879 + 891.5	28.25	0.67
	64QAM	M	879 + 891.5	26.82	0.48
	256QAM	M	879 + 891.5	26.73	0.47
3	QPSK	M	879 + 891.5	26.83	0.48
	16QAM	M	879 + 891.5	28.37	0.69
	64QAM	M	879 + 891.5	26.99	0.50
	256QAM	M	879 + 891.5	26.94	0.49
4	QPSK	M	879 + 891.5	<b>26.86</b>	<b>0.49</b>
	16QAM	M	879 + 891.5	<b>28.47</b>	<b>0.70</b>
	64QAM	M	879 + 891.5	26.83	0.48
	256QAM	M	879 + 891.5	26.86	0.48

CH	Frequency (MHz)	Sum of PSD (W/MHz) @ ANT ALL			
		QPSK	16QAM	64QAM	256QAM
M	879 + 891.5	1.91	<b>2.74</b>	1.95	1.95

### 8.1.4. WORST PLOT OF PSD

#### 5G NR n5 20 MHz (1 Carrier) – 4TX

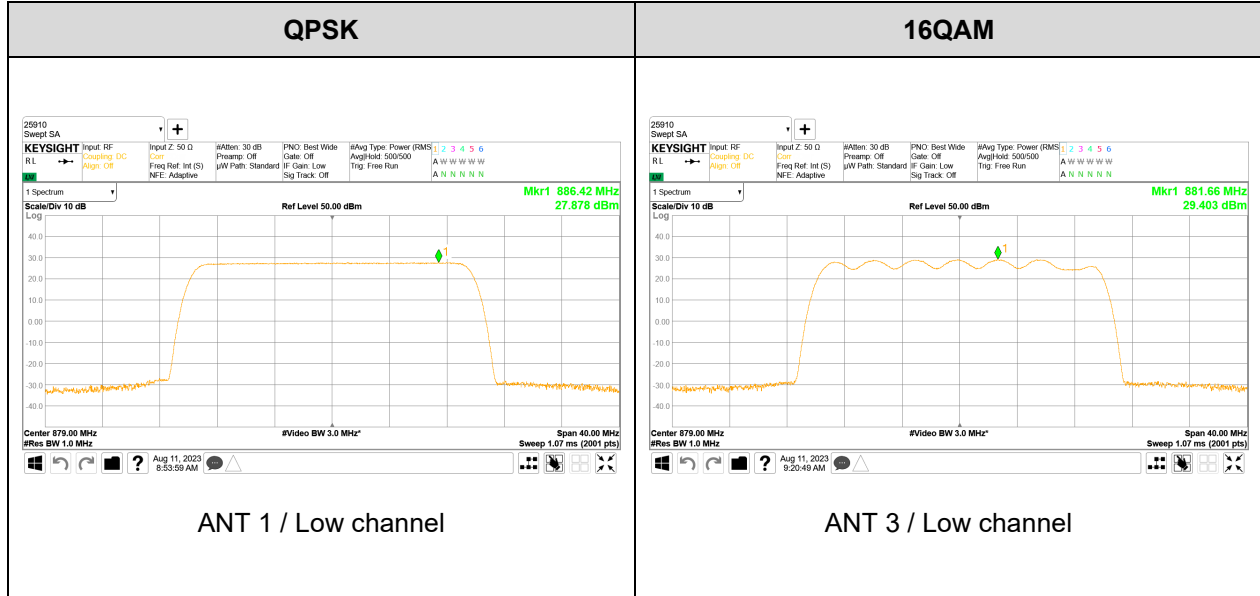

#### 5G NR n5 20 MHz 1C + 5G NR n5 5 MHz 1C (2 Carrier) – 4TX – Contiguous

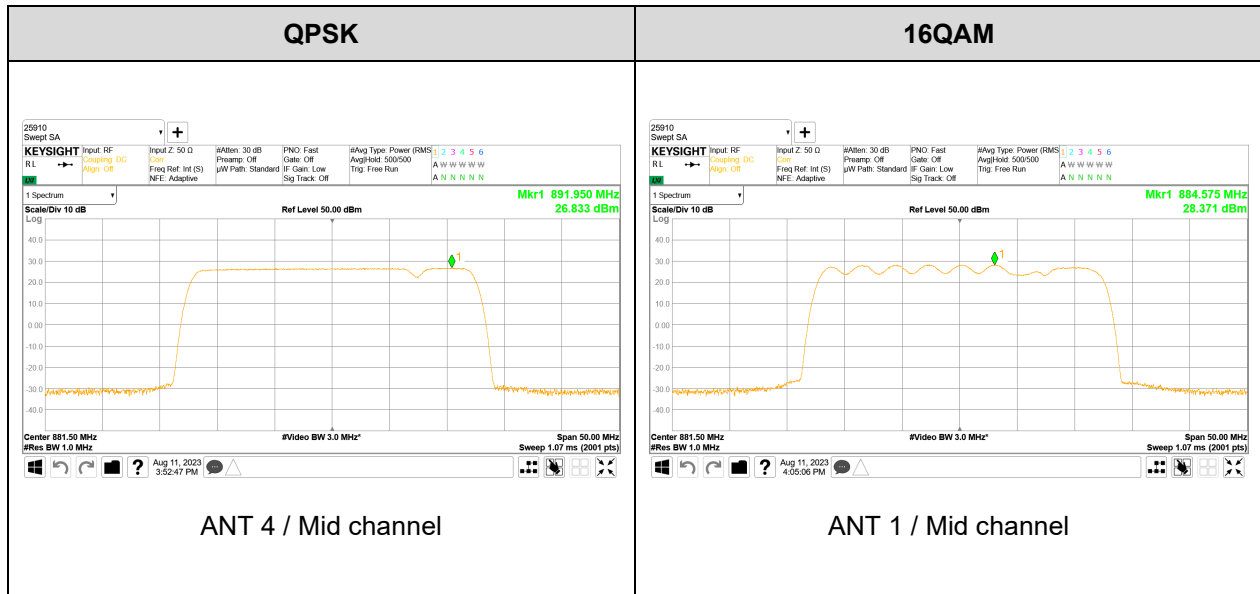



**5G NR n5 20 MHz 1C + LTE B5 5 MHz 1C (2 Carrier) – 4TX - Contiguous**

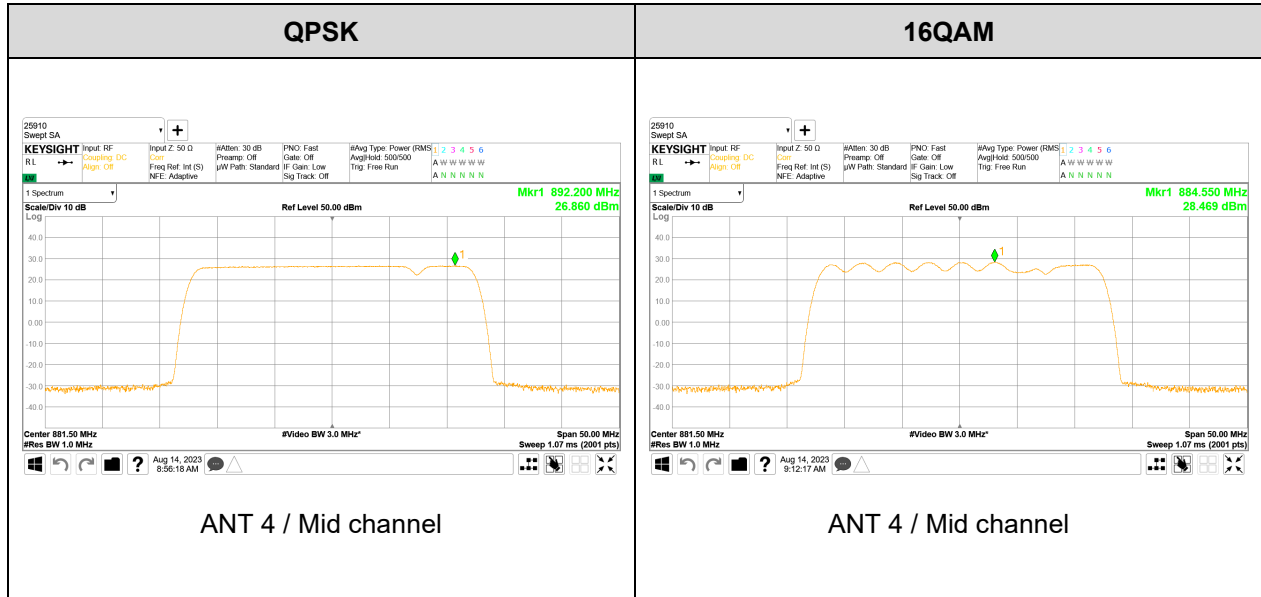

## 8.2. PEAK TO AVERAGE RATIO (PAR)

### RULE PART(S)

FCC : §22.913

### LIMITS

§22.913

(d) Measurement of the ERP of Cellular base transmitters and repeaters must be made using an average power measurement technique. The peak-to-average ratio (PAR) of the transmission must not exceed 13 dB.

### TEST PROCEDURE

The measurement is performed in accordance with Section 5.2.3.4 of ANSI C63.26.

The following guidelines are offered for performing a CCDF measurement.

- a) Set resolution/measurement bandwidth MV OBW or specified reference bandwidth.
- b) Set the number of counts to a value that stabilizes the measured CCDF curve.
- c) Set the measurement interval as follows:
  - 1) For continuous transmissions, set to the greater of  $[10 \times (\text{number of points in sweep}) \times (\text{transmission symbol period})]$  or 1 ms.
  - 2) For burst transmissions, employ an external trigger that is synchronized with the EUT burst timing sequence, or use the internal burst trigger with a trigger level that allows the burst to stabilize. Set the measurement interval to a time that is less than or equal to the burst duration.
  - 3) If there are several carriers in a single antenna port, the peak power shall be determined for each individual carrier (by disabling the other carriers while measuring the required carrier) and the total peak power calculated from the sum of the individual carrier peak powers.
- d) Record the maximum PAPR level associated with a probability of 0.1 %.
- e) The peak power level is calculated from the sum of the PAPR value from step d) to the measured average power.

### RESULTS

See the following pages.

### 8.2.1. PEAK TO AVERAGE RATIO (PAR) RESULTS

#### 5G NR n5 20 MHz (1 Carrier) – 4TX

ANT	Modulation	CH	Frequency (MHz)	PAR (dB)
1	QPSK	M	881.5	8.13
	16QAM	M	881.5	8.13
	64QAM	M	881.5	8.18
	256QAM	M	881.5	8.22
2	QPSK	M	881.5	8.11
	16QAM	M	881.5	8.14
	64QAM	M	881.5	8.15
	256QAM	M	881.5	8.20
3	QPSK	M	881.5	8.13
	16QAM	M	881.5	8.20
	64QAM	M	881.5	8.18
	256QAM	M	881.5	8.21
4	QPSK	M	881.5	<b>8.13</b>
	16QAM	M	881.5	8.16
	64QAM	M	881.5	8.16
	256QAM	M	881.5	<b>8.22</b>

#### 5G NR n5 20 MHz 1C + 5G NR n5 5 MHz 1C (2 Carrier) – 4TX – Contiguous

ANT	Modulation	CH	Frequency (MHz)	PAR (dB)
1	QPSK	M	879 + 891.5	8.20
	16QAM	M	879 + 891.5	8.17
	64QAM	M	879 + 891.5	8.23
	256QAM	M	879 + 891.5	8.23
2	QPSK	M	879 + 891.5	8.18
	16QAM	M	879 + 891.5	8.17
	64QAM	M	879 + 891.5	8.20
	256QAM	M	879 + 891.5	8.21
3	QPSK	M	879 + 891.5	8.18
	16QAM	M	879 + 891.5	8.17
	64QAM	M	879 + 891.5	<b>8.24</b>
	256QAM	M	879 + 891.5	8.20
4	QPSK	M	879 + 891.5	<b>8.21</b>
	16QAM	M	879 + 891.5	8.15
	64QAM	M	879 + 891.5	8.20
	256QAM	M	879 + 891.5	8.21

**5G NR n5 20 MHz 1C + LTE B5 5 MHz 1C (2 Carrier) – 4TX - Contiguous**

ANT	Modulation	CH	Frequency (MHz)	PAR (dB)
1	QPSK	M	879 + 891.5	8.16
	16QAM	M	879 + 891.5	8.14
	64QAM	M	879 + 891.5	8.19
	256QAM	M	879 + 891.5	8.19
2	QPSK	M	879 + 891.5	8.16
	16QAM	M	879 + 891.5	8.22
	64QAM	M	879 + 891.5	8.15
	256QAM	M	879 + 891.5	8.17
3	QPSK	M	879 + 891.5	8.17
	16QAM	M	879 + 891.5	8.18
	64QAM	M	879 + 891.5	8.16
	256QAM	M	879 + 891.5	<b>8.25</b>
4	QPSK	M	879 + 891.5	<b>8.21</b>
	16QAM	M	879 + 891.5	8.22
	64QAM	M	879 + 891.5	8.20
	256QAM	M	879 + 891.5	8.19

## 8.2.2. WORST PLOT OF PEAK TO AVERAGE RATIO (PAR)

### 5G NR n5 20 MHz (1 Carrier) – 4TX

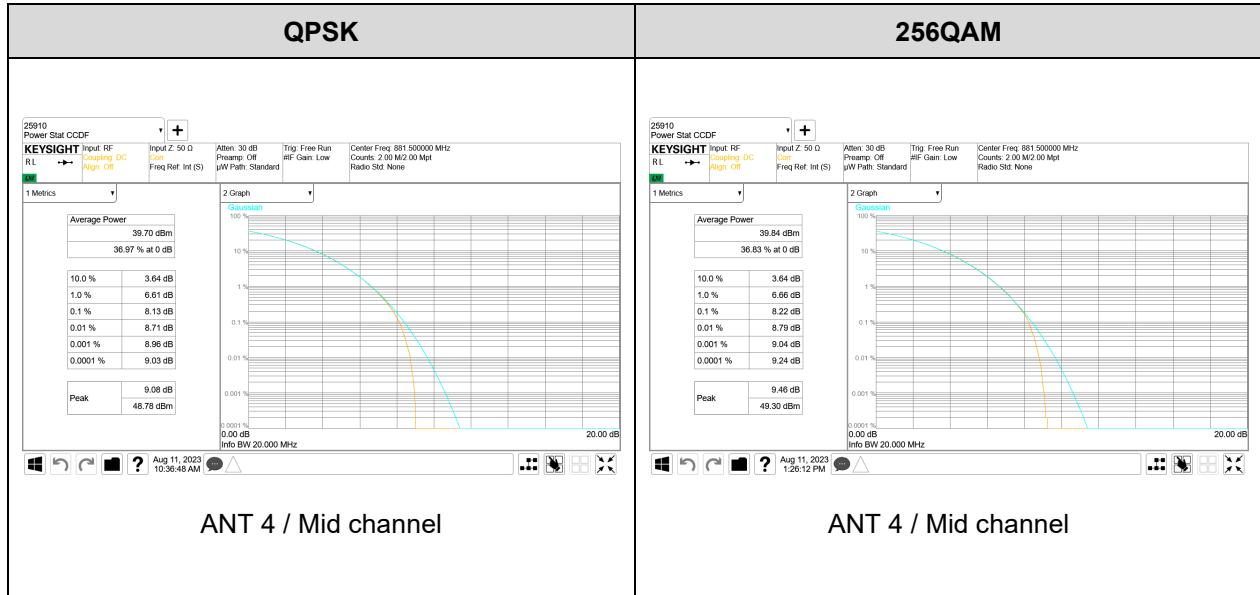

### 5G NR n5 20 MHz 1C + 5G NR n5 5 MHz 1C (2 Carrier) – 4TX – Contiguous

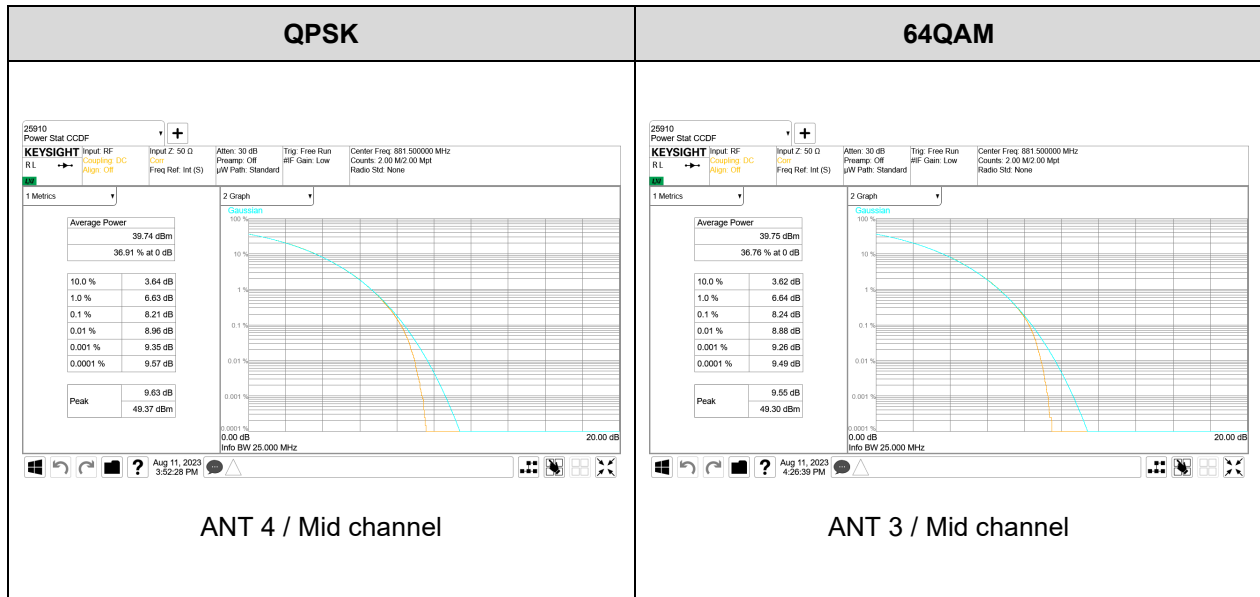

**5G NR n5 20 MHz 1C + LTE B5 5 MHz 1C (2 Carrier) – 4TX - Contiguous**

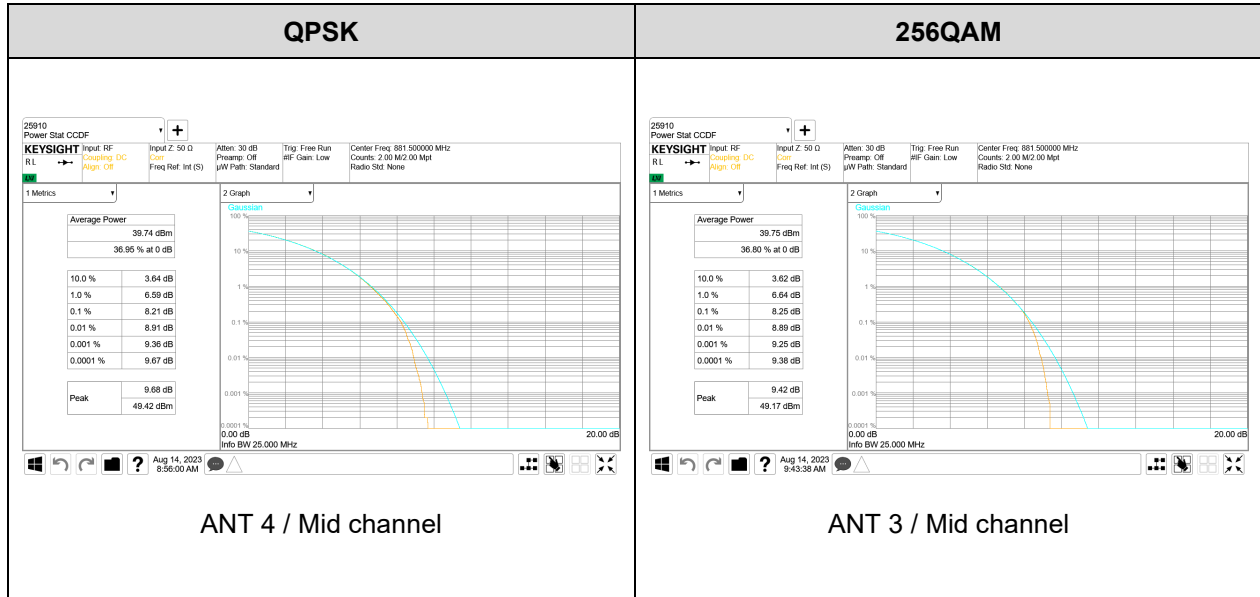

### **8.3. OCCUPIED BANDWIDTH**

#### **RULE PART(S)**

FCC : §2.1049

#### **LIMITS**

For reporting purposes only

#### **TEST PROCEDURE**

The transmitter output was connected to a calibrated coaxial cable and attenuator, the other end of which was connected to a spectrum analyzer. The occupied bandwidth was measured with the spectrum analyzer at the low, middle and high channel in each band. The occupied bandwidth was also measured and recorded.

(Section 5.4.3 and 5.4.4 of ANSI C63.26)

#### **RESULTS**

See the following pages.

### 8.3.1. OCCUPIED BANDWIDTH RESULTS

#### 5G NR n5 20 MHz (1 Carrier) – 4TX

ANT	Modulation	CH	Frequency (MHz)	Occupied Bandwidth (MHz)
1	QPSK	L	879	18.941
		M	881.5	18.937
		H	884	18.936
	16QAM	L	879	19.019
		M	881.5	19.025
		H	884	19.022
	64QAM	L	879	18.942
		M	881.5	18.954
		H	884	18.953
	256QAM	L	879	18.964
		M	881.5	18.985
		H	884	18.999
2	QPSK	L	879	18.940
		M	881.5	<b>18.948</b>
		H	884	18.932
	16QAM	L	879	19.017
		M	881.5	19.026
		H	884	18.999
	64QAM	L	879	18.934
		M	881.5	18.940
		H	884	18.961
	256QAM	L	879	18.993
		M	881.5	18.952
		H	884	18.985
3	QPSK	L	879	18.931
		M	881.5	18.938
		H	884	18.944
	16QAM	L	879	19.013
		M	881.5	<b>19.037</b>
		H	884	19.022
	64QAM	L	879	18.966
		M	881.5	18.980
		H	884	18.945
	256QAM	L	879	18.977
		M	881.5	19.006
		H	884	18.955



ANT	Modulation	CH	Frequency (MHz)	Occupied Bandwidth (MHz)
4	QPSK	L	879	18.921
		M	881.5	18.940
		H	884	18.939
	16QAM	L	879	19.022
		M	881.5	19.030
		H	884	19.005
	64QAM	L	879	18.943
		M	881.5	18.977
		H	884	18.943
	256QAM	L	879	18.975
		M	881.5	18.980
		H	884	18.972

**5G NR n5 20 MHz 1C + 5G NR n5 5 MHz 1C (2 Carrier) – 4TX – Contiguous**

ANT	Modulation	CH	Frequency (MHz)	Occupied Bandwidth (MHz)
1	QPSK	M	879 + 891.5	24.103
	16QAM	M	879 + 891.5	24.184
	64QAM	M	879 + 891.5	<b>24.193</b>
	256QAM	M	879 + 891.5	24.112
2	QPSK	M	879 + 891.5	24.127
	16QAM	M	879 + 891.5	24.155
	64QAM	M	879 + 891.5	24.149
	256QAM	M	879 + 891.5	24.086
3	QPSK	M	879 + 891.5	<b>24.141</b>
	16QAM	M	879 + 891.5	24.178
	64QAM	M	879 + 891.5	24.105
	256QAM	M	879 + 891.5	24.069
4	QPSK	M	879 + 891.5	24.103
	16QAM	M	879 + 891.5	24.148
	64QAM	M	879 + 891.5	24.121
	256QAM	M	879 + 891.5	24.089

**5G NR n5 20 MHz 1C + LTE B5 5 MHz 1C (2 Carrier) – 4TX - Contiguous**

ANT	Modulation	CH	Frequency (MHz)	Occupied Bandwidth (MHz)
1	QPSK	M	879 + 891.5	<b>24.212</b>
	16QAM	M	879 + 891.5	24.197
	64QAM	M	879 + 891.5	24.112
	256QAM	M	879 + 891.5	24.165
2	QPSK	M	879 + 891.5	24.210
	16QAM	M	879 + 891.5	24.163
	64QAM	M	879 + 891.5	24.121
	256QAM	M	879 + 891.5	24.143
3	QPSK	M	879 + 891.5	24.162
	16QAM	M	879 + 891.5	24.187
	64QAM	M	879 + 891.5	24.128
	256QAM	M	879 + 891.5	24.168
4	QPSK	M	879 + 891.5	24.132
	16QAM	M	879 + 891.5	<b>24.205</b>
	64QAM	M	879 + 891.5	24.118
	256QAM	M	879 + 891.5	24.152

### 8.3.2. WORST PLOT OF OCCUPIED BANDWIDTH

#### 5G NR n5 20 MHz (1 Carrier) – 4TX

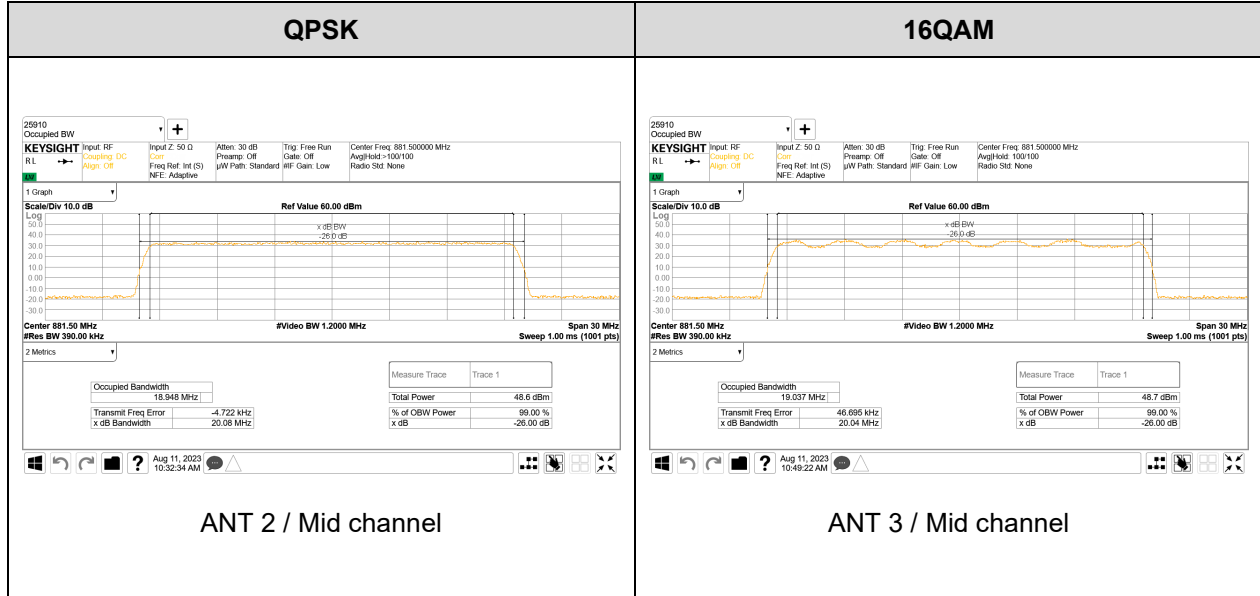

#### 5G NR n5 20 MHz 1C + 5G NR n5 5 MHz 1C (2 Carrier) – 4TX – Contiguous

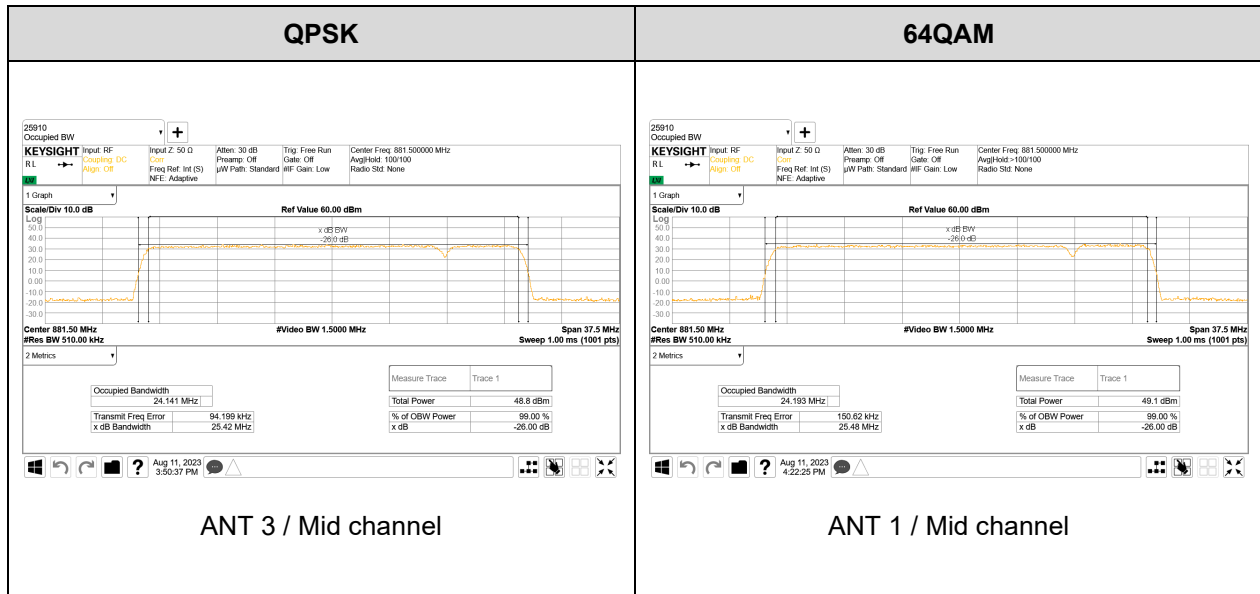

**5G NR n5 20 MHz 1C + LTE B5 5 MHz 1C (2 Carrier) – 4TX - Contiguous**

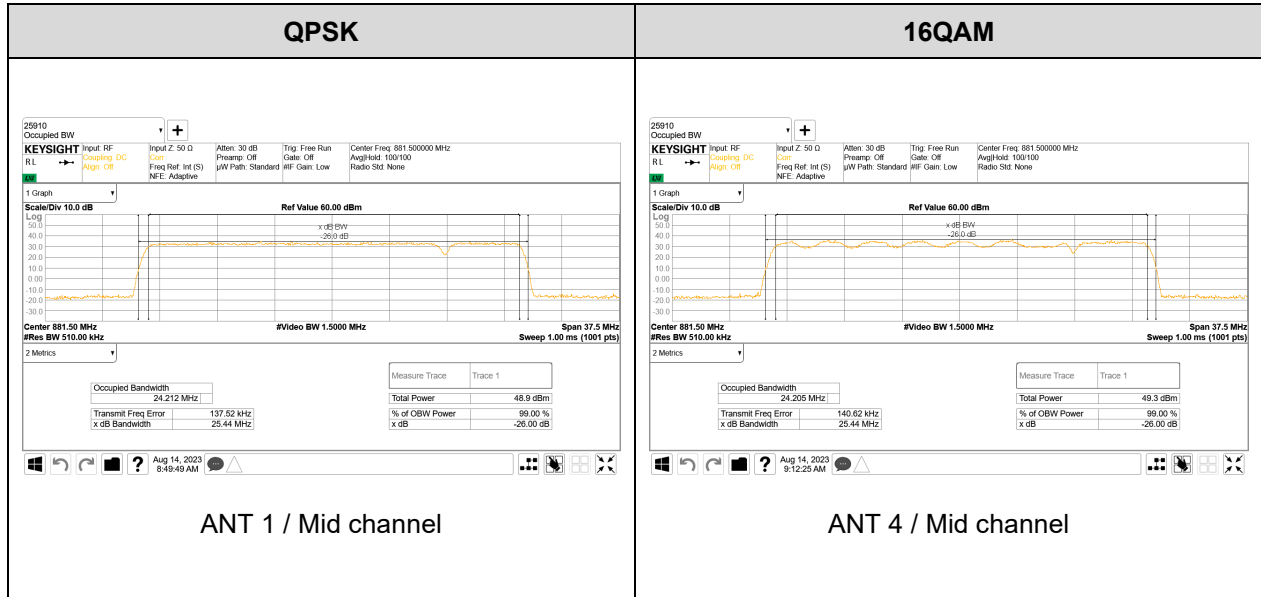

## 8.4. OUT OF BAND EMISSIONS (BAND EDGE)

### RULE PART(S)

FCC : §2.1051 §22.917

### LIMITS

§22.917

The rules in this section govern the spectral characteristics of emissions in the Cellular Radiotelephone Service.

(a) Out of band emissions. The power of any emission outside of the authorized operating frequency ranges must be attenuated below the transmitting power (P) by a factor of at least  $43 + 10 \log(P)$  dB.

(b) Measurement procedure. Compliance with these rules is based on the use of measurement instrumentation employing a reference bandwidth as follows:

(1) In the spectrum below 1 GHz, instrumentation should employ a reference bandwidth of 100 kHz or greater. In the 1 MHz bands immediately outside and adjacent to the frequency block, a resolution bandwidth of at least one percent of the emission bandwidth of the fundamental emission of the transmitter may be employed. A narrower resolution bandwidth is permitted in all cases to improve measurement accuracy, provided that the measured power is integrated over the full required reference bandwidth (i.e., 100 kHz or 1 percent of emission bandwidth, as specified). The emission bandwidth is defined as the width of the signal between two points, one below the carrier center frequency and one above the carrier center frequency, outside of which all emissions are attenuated at least 26 dB below the transmitter power.

(2) In the spectrum above 1 GHz, instrumentation should employ a reference bandwidth of 1 MHz.

(c) Alternative out of band emission limit. Licensees in this service may establish an alternative out of band emission limit to be used at specified band edge(s) in specified geographical areas, in lieu of that set forth in this section, pursuant to a private contractual arrangement of all affected licensees and applicants. In this event, each party to such contract shall maintain a copy of the contract in their station files and disclose it to prospective assignees or transferees and, upon request, to the FCC.

(d) Interference caused by out of band emissions. If any emission from a transmitter operating in this service results in interference to users of another radio service, the FCC may require a greater attenuation of that emission than specified in this section.

## **TEST PROCEDURE**

Section 5.7.3 of ANSI C63.26:

### **Out-of-band unwanted emissions measurements**

- a) Set the spectrum analyzer center frequency to the block, band, or channel edge frequency.
- b) Set the span wide enough to capture the fundamental emission closest to the authorized block or band edge, and to include all modulation products that spill into the immediately adjacent frequency band. In some cases, it may be possible to set the center frequency and span so as to encompass the fundamental emission and the unwanted out-of-band (band-edge) emissions on either side of the authorized block, band, or channel. This can be accomplished with a single (slow) sweep, if adequate overload protection and sufficient dynamic range can be maintained.
- c) Set the number of points in sweep  $\geq 2 \times \text{span} / \text{RBW}$ .
- d) Sweep time should be auto for peak detection. For rms detection the sweep time should be set as follows:
  - 1) If the device can be configured to transmit continuously (duty cycle  $\geq 98\%$ ), set the (sweep time)  $> (\text{number of points in sweep}) \times (\text{symbol period})$  (e.g., by a factor of  $10 \times \text{symbol period} \times \text{number of points}$ ). Increasing the sweep time (i.e., slowing the sweep speed) will allow for averaging over multiple symbols
  - 2) If the device cannot transmit continuously (duty cycle  $< 98\%$ ), a gated sweep shall be used when possible (i.e., gate triggered such that the analyzer only sweeps when the device is transmitting at full power), set the sweep time  $> (\text{number of points in sweep}) \times (\text{symbol period})$  but the sweep time shall always be maintained at a value that is less than or equal to the minimum transmission time.
  - 3) If the device cannot be configured to transmit continuously (duty cycle  $< 98\%$ ) and a freerunning sweep must be used, set the sweep time so that the averaging is performed over multiple on/off cycles by setting the sweep time  $> (\text{number of points in sweep}) \times (\text{transmitter period})$  (i.e., the transmit on-time + the off-time). The spectrum analyzer readings shall subsequently be corrected by  $[10 \log (1/\text{duty cycle})]$ . This assumes that the transmission period and duty cycle is relatively constant (duty cycle variation  $\leq \pm 2\%$ ).
  - 4) If the device cannot be configured to transmit continuously and a free-running sweep must be used, and if the transmissions exhibit a non-constant duty cycle (duty cycle variations  $> \pm 2\%$ ), set the sweep time so that the averaging is performed over the on-period by setting the sweep time  $> (\text{symbol period}) \times (\text{number of points})$ , while also maintaining the sweep time  $< (\text{transmitter on-time})$ . The trace mode shall be set to max hold, since not every display point will be averaged only over just the on-time. Thus, multiple sweeps (e.g., 100) in maximum hold are necessary to ensure that the maximum power is measured.

**NOTE:**

1) For all frequencies below 869 MHz and above 894 MHz, correction has been added to the limit for each port according to KDB 662911 D01 v02r01.

- 4TX MIMO correction:  $10 \log(N_{\text{ANT}}) = 10 \log(4) = 6.02 \text{ dB}$

- 4TX MIMO Limit :  $-13 \text{ dBm} - 6.02 \text{ dB} = -19.02 \text{ dBm}$

**RESULTS**

See the following pages.

**8.4.1. OUT OF BAND EMISSIONS (BAND EDGE)**

**5G NR n5 20 MHz (1 Carrier) – 4TX**

ANT	Modulation	CH	Frequency (MHz)	BE	dBm
1	QPSK	L	879	L	-37.17
				H	-41.05
	16QAM	L	879	L	-37.34
				H	-39.43
	64QAM	L	879	L	-36.64
				H	-39.38
	256QAM	L	879	L	-36.51
				H	-39.52
2	QPSK	L	879	L	-36.64
				H	-39.23
	16QAM	L	879	L	-36.68
				H	-39.88
	64QAM	L	879	L	-36.09
				H	-39.60
	256QAM	L	879	L	<b>-36.08</b>
				H	-39.75
3	QPSK	L	879	L	-38.03
				H	-39.40
	16QAM	L	879	L	-37.65
				H	-39.97
	64QAM	L	879	L	-37.93
				H	-40.13
	256QAM	L	879	L	-37.92
				H	-40.22
4	QPSK	L	879	L	-36.67
				H	-39.73
	16QAM	L	879	L	-36.35
				H	-40.56
	64QAM	L	879	L	-36.36
				H	-39.95
	256QAM	L	879	L	-36.51
				H	-40.35



ANT	Modulation	CH	Frequency (MHz)	BE	dBm
1	QPSK	H	884	L	-39.05
				H	<b>-35.46</b>
	16QAM	H	884	L	-39.51
				H	-37.42
	64QAM	H	884	L	-39.41
				H	-36.24
	256QAM	H	884	L	-39.49
				H	-36.97
2	QPSK	H	884	L	-39.34
				H	-37.13
	16QAM	H	884	L	-39.62
				H	-38.04
	64QAM	H	884	L	-39.34
				H	-36.67
	256QAM	H	884	L	-39.43
				H	-37.21
3	QPSK	H	884	L	-39.87
				H	-37.23
	16QAM	H	884	L	-37.90
				H	-37.46
	64QAM	H	884	L	-39.85
				H	-37.42
	256QAM	H	884	L	-39.86
				H	-36.81
4	QPSK	H	884	L	-40.03
				H	-37.76
	16QAM	H	884	L	-39.83
				H	-37.91
	64QAM	H	884	L	-39.82
				H	-37.07
	256QAM	H	884	L	-39.38
				H	-37.09

**5G NR n5 20 MHz 1C + 5G NR n5 5 MHz 1C (2 Carrier) – 4TX – Contiguous**

ANT	Modulation	CH	Frequency (MHz)	BE	dBm
1	QPSK	M	879 + 891.5	L	<b>-36.71</b>
				H	-38.42
	16QAM	M	879 + 891.5	L	-36.97
				H	-37.50
	64QAM	M	879 + 891.5	L	-37.24
				H	-37.56
	256QAM	M	879 + 891.5	L	-36.92
				H	<b>-35.95</b>
2	QPSK	M	879 + 891.5	L	-37.42
				H	-38.35
	16QAM	M	879 + 891.5	L	-37.13
				H	-37.98
	64QAM	M	879 + 891.5	L	-37.21
				H	-38.64
	256QAM	M	879 + 891.5	L	-37.19
				H	-38.25
3	QPSK	M	879 + 891.5	L	-38.51
				H	-38.62
	16QAM	M	879 + 891.5	L	-37.96
				H	-37.65
	64QAM	M	879 + 891.5	L	-37.93
				H	-38.29
	256QAM	M	879 + 891.5	L	-38.49
				H	-38.31
4	QPSK	M	879 + 891.5	L	-37.30
				H	-39.24
	16QAM	M	879 + 891.5	L	-37.43
				H	-38.79
	64QAM	M	879 + 891.5	L	-37.25
				H	-38.33
	256QAM	M	879 + 891.5	L	-37.70
				H	-38.61

**5G NR n5 20 MHz 1C + LTE B5 5 MHz 1C (2 Carrier) – 4TX - Contiguous**

ANT	Modulation	CH	Frequency (MHz)	BE	dBm
1	QPSK	M	879 + 891.5	L	-37.25
				H	-37.46
	16QAM	M	879 + 891.5	L	-37.84
				H	<b>-36.44</b>
	64QAM	M	879 + 891.5	L	-37.13
				H	-37.18
	256QAM	M	879 + 891.5	L	-37.12
				H	-37.22
2	QPSK	M	879 + 891.5	L	-37.26
				H	-39.22
	16QAM	M	879 + 891.5	L	-37.85
				H	-38.03
	64QAM	M	879 + 891.5	L	<b>-36.75</b>
				H	-37.80
	256QAM	M	879 + 891.5	L	-37.34
				H	-38.21
3	QPSK	M	879 + 891.5	L	-37.83
				H	-37.62
	16QAM	M	879 + 891.5	L	-38.52
				H	-37.28
	64QAM	M	879 + 891.5	L	-38.35
				H	-37.47
	256QAM	M	879 + 891.5	L	-38.06
				H	-37.80
4	QPSK	M	879 + 891.5	L	-37.31
				H	-38.71
	16QAM	M	879 + 891.5	L	-37.76
				H	-38.19
	64QAM	M	879 + 891.5	L	-37.46
				H	-38.62
	256QAM	M	879 + 891.5	L	-37.51
				H	-38.34

### 8.4.2. WORST PLOT OF OUT OF BAND EMISSIONS (BAND EDGE)

#### 5G NR n5 20 MHz (1 Carrier) – 4TX

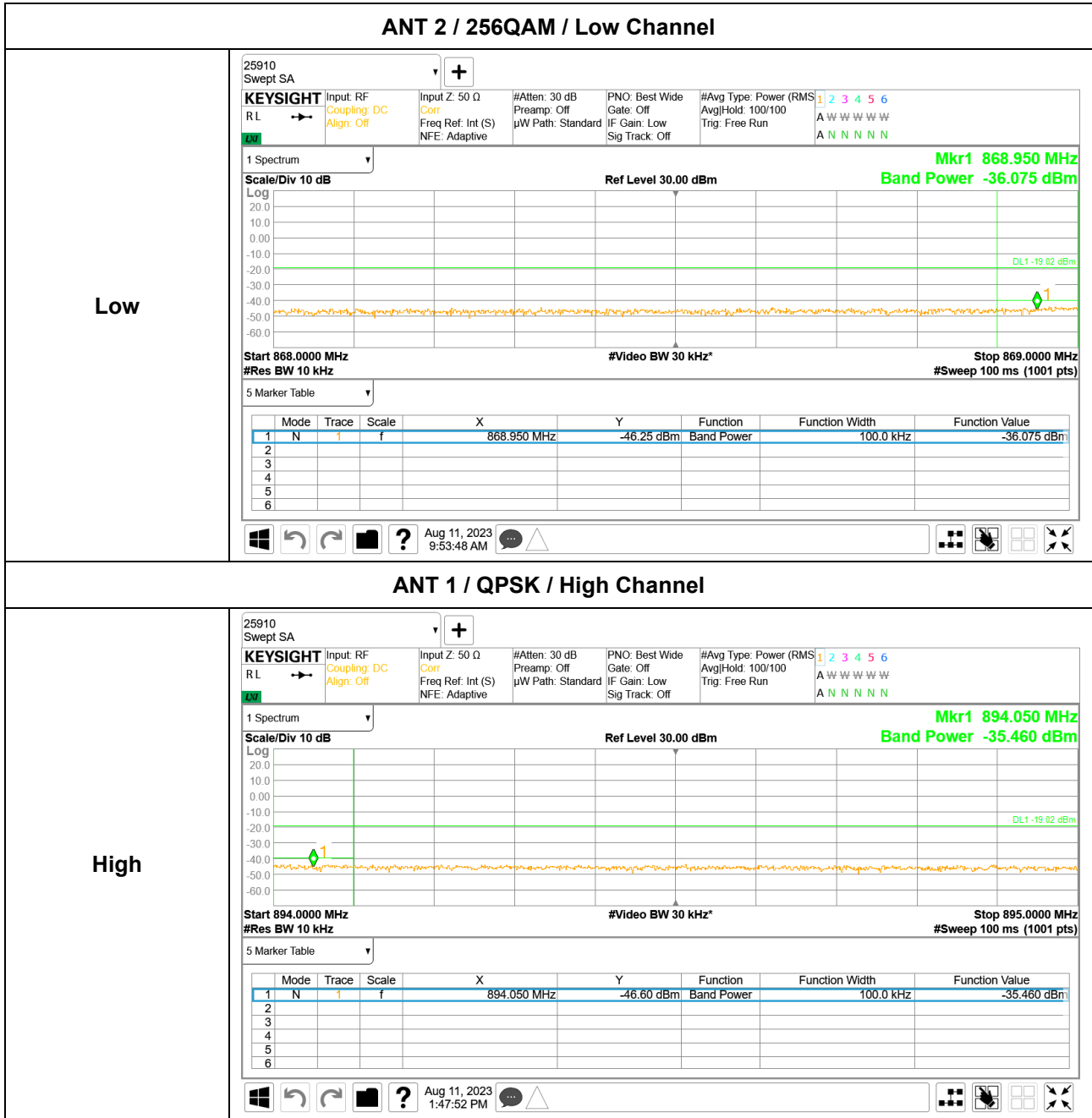

**5G NR n5 20 MHz 1C + 5G NR n5 5 MHz 1C (2 Carrier) – 4TX – Contiguous**

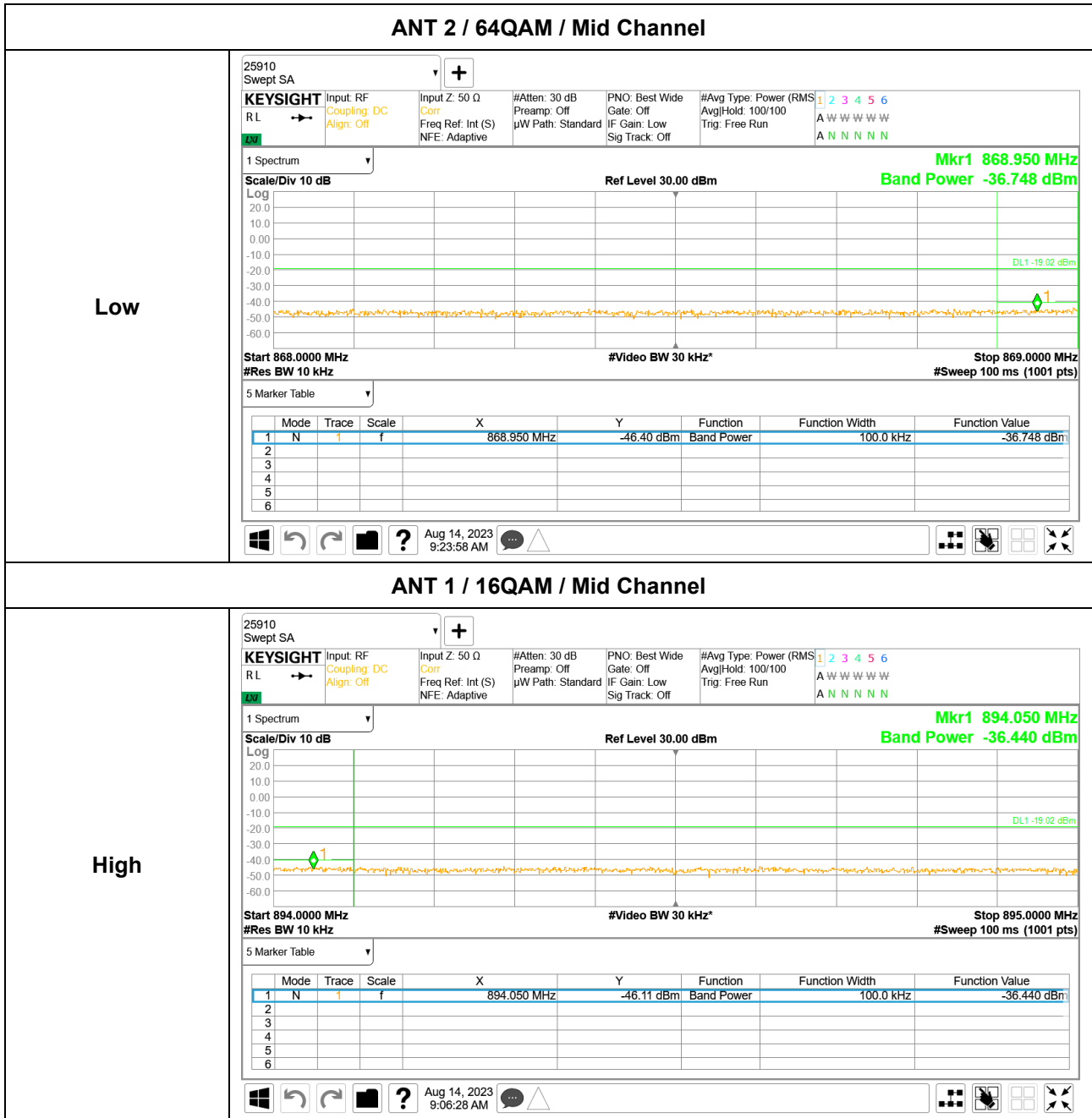

**5G NR n5 20 MHz 1C + LTE B5 5 MHz 1C (2 Carrier) – 4TX - Contiguous**

**ANT 1 / 16QAM / Mid Channel**

High

25910 Swept SA +  
**KEYSIGHT** Input: RF Coupling: DC Input Z: 50 Ω #Atten: 30 dB PNO: Best Wide #Avg Type: Power (RMS) 1 2 3 4 5 6  
 R.L. → Align: Off Corr Freq Ref: Int (S) Preamp: Off Gate: Off Avg/Hold: 100/100 A W W W W W  
 NFE: Adaptive μW Path: Standard IF Gain: Low Trng: Free Run A N N N N N  
 Sig Track: Off

1 Spectrum Mkr1 894.050 MHz  
 Scale/Div 10 dB Ref Level 30.00 dBm  
Band Power -36.440 dBm

Start 894.000 MHz Stop 895.000 MHz  
 #Res BW 10 kHz #Video BW 30 kHz\* #Sweep 100 ms (1001 pts)

5 Marker Table

Mode	Trace	Scale	X	Y	Function	Function Width	Function Value
1	N	f	894.050 MHz	-46.11 dBm	Band Power	100.0 kHz	-36.440 dBm
2							
3							
4							
5							
6							

Aug 14, 2023 9:06:28 AM

## 8.5. OUT OF BAND EMISSIONS (SPURIOUS)

### RULE PART(S)

FCC : §2.1051 §22.917

### LIMITS

§22.917

The rules in this section govern the spectral characteristics of emissions in the Cellular Radiotelephone Service.

(a) Out of band emissions. The power of any emission outside of the authorized operating frequency ranges must be attenuated below the transmitting power (P) by a factor of at least  $43 + 10 \log(P)$  dB.

(b) Measurement procedure. Compliance with these rules is based on the use of measurement instrumentation employing a reference bandwidth as follows:

(1) In the spectrum below 1 GHz, instrumentation should employ a reference bandwidth of 100 kHz or greater. In the 1 MHz bands immediately outside and adjacent to the frequency block, a resolution bandwidth of at least one percent of the emission bandwidth of the fundamental emission of the transmitter may be employed. A narrower resolution bandwidth is permitted in all cases to improve measurement accuracy, provided that the measured power is integrated over the full required reference bandwidth (i.e., 100 kHz or 1 percent of emission bandwidth, as specified). The emission bandwidth is defined as the width of the signal between two points, one below the carrier center frequency and one above the carrier center frequency, outside of which all emissions are attenuated at least 26 dB below the transmitter power.

(2) In the spectrum above 1 GHz, instrumentation should employ a reference bandwidth of 1 MHz.

(c) Alternative out of band emission limit. Licensees in this service may establish an alternative out of band emission limit to be used at specified band edge(s) in specified geographical areas, in lieu of that set forth in this section, pursuant to a private contractual arrangement of all affected licensees and applicants. In this event, each party to such contract shall maintain a copy of the contract in their station files and disclose it to prospective assignees or transferees and, upon request, to the FCC.

(d) Interference caused by out of band emissions. If any emission from a transmitter operating in this service results in interference to users of another radio service, the FCC may require a greater attenuation of that emission than specified in this section.

## **TEST PROCEDURE**

Section 5.7.4 of ANSI C63.26:

### **Spurious unwanted emission measurements**

- a) Set the spectrum analyzer start frequency to the lowest frequency generated by the EUT, without going below 9 kHz, and the stop frequency to the lower frequency covered by the measurements previously performed in 5.7.3. As an alternative, the stop frequency can be set to the value specified in 5.1.1, depending on the EUT operating range, if the resulting plot can clearly demonstrate compliance for all frequencies not addressed by the out-of-band emissions measurements performed as per 5.7.3.
- b) When using an average power (rms) detector, ensure that the number of points in the sweep  $\geq 2 \times (\text{span} / \text{RBW})$ . This may require that the measurement range defined by the start and stop frequencies be subdivided, depending on the spectrum analyzer capabilities. This requirement does not apply to peak-detected power measurements. When average power is specified by the applicable regulation, a peak-detector can be utilized for preliminary measurements to accommodate wider frequency spans. Any emissions found in the preliminary measurement to exceed the applicable limit(s) shall be further examined using a power averaging (rms) detector with the minimum number of measurement points as defined above.
- c) The sweep time should be set to auto-couple for performing peak-detector measurements. For measurements that use a power averaging (rms) detector, the sweep time shall be set as described for out-of-band emissions measurements in item d) of 5.7.3.
- d) Identify and measure the highest spurious emission levels in each frequency range. It is not necessary to re-measure the out-of-band emissions as a part of this test. Record the frequencies and amplitudes corresponding to the measured emissions and capture the data plots.
- e) Repeat step b) through step d) for the upper spurious emission frequency range if not already captured by a wide span measurement performed as per the alternative provided in step a). The upper frequency for this measurement is defined in 5.1.1 as a function of the EUT operating range.
- f) Compare the results with the corresponding limit in the applicable regulation.
- g) The test report shall include the data plots of the measuring instrument display and the measured data.



**NOTE:**

1) In 9 kHz to 30 MHz frequency range, RBW narrower than reference bandwidth(100 kHz) is used.  
So following correction factor is applied.

$$\text{Formula: } 10 \log [(reference\ bandwidth)/(resolution\ bandwidth)]$$

a) 9 kHz to 150 kHz applied 1 kHz RBW:  $10 \log (100 \text{ kHz} / 1 \text{ kHz}) = 20 \text{ dB}$

b) 150 kHz to 30 MHz applied 10 kHz RBW:  $10 \log (100 \text{ kHz} / 10 \text{ kHz}) = 10 \text{ dB}$

2) For all frequencies below 869 MHz and above 894 MHz, correction has been added to the limit for each port according to KDB 662911 D01 v02r01.

- 4TX MIMO correction:  $10 \log(N_{ANT}) = 10 \log(4) = 6.02 \text{ dB}$

- 4TX MIMO Limit :  $-13 \text{ dBm} - 6.02 \text{ dB} = -19.02 \text{ dBm}$

**RESULTS**

See the following pages.

### 8.5.1. CONDUCTED SPURIOUS EMISSIONS RESULT

#### 5G NR n5 20 MHz (1 Carrier) – 4TX

ANT	Modulation	CH	Result (dBm)				
			9 kHz ~ 150 kHz	150 kHz ~ 30 MHz	30 MHz ~ 868 MHz	895 MHz ~ 1 GHz	1 GHz ~ 10 GHz
1	QPSK	L	-49.30	-57.71	-38.93	-41.06	-28.82
		M	-48.31	-57.02	-40.66	-39.83	-28.30
		H	<b>-44.40</b>	-56.02	-38.73	<b>-37.39</b>	-28.58
	16QAM	L	-49.56	-56.62	-38.95	-41.85	-28.47
		M	-48.12	-56.60	-38.32	-41.46	-28.56
		H	-47.92	-57.14	-40.40	-39.26	-28.31
	64QAM	L	-50.06	-57.47	-37.74	-42.05	-27.84
		M	-48.51	-57.04	-38.50	-39.15	-28.25
		H	-47.23	-56.98	-41.58	-39.27	-27.89
	256QAM	L	-49.52	-56.98	-37.51	-41.18	-28.20
		M	-43.68	<b>-55.60</b>	-39.50	-38.83	-28.71
		H	-49.10	-57.07	-39.90	<b>-38.22</b>	-28.16
2	QPSK	L	-49.26	-57.73	<b>-38.70</b>	-43.92	-28.16
		M	-49.12	-57.36	-41.45	-40.84	-28.16
		H	-44.72	-56.43	-40.88	-38.76	-28.06
	16QAM	L	-49.93	-56.59	-38.54	-43.75	-27.99
		M	-49.56	-57.15	-40.95	-42.04	-28.10
		H	-49.17	-57.36	-40.87	-40.54	-28.04
	64QAM	L	-48.80	-57.62	<b>-37.21</b>	-42.82	-27.79
		M	-49.58	-58.24	-41.17	-40.25	-28.23
		H	-47.42	-57.81	-40.51	-40.11	-27.79
	256QAM	L	-49.22	-57.57	-37.78	-42.76	-28.21
		M	-43.48	-56.58	-40.80	-40.27	-27.91
		H	-49.66	-56.82	-39.12	-39.04	-28.19

ANT	Modulation	CH	Result (dBm)				
			9 kHz ~ 150 kHz	150 kHz ~ 30 MHz	30 MHz ~ 868 MHz	895 MHz ~ 1 GHz	1 GHz ~ 10 GHz
3	QPSK	L	-49.74	-57.18	-39.67	-42.85	<b>-27.18</b>
		M	-48.26	-56.47	-41.29	-41.35	-27.32
		H	-45.26	-56.09	-41.62	-40.65	-28.18
	16QAM	L	-50.02	-56.68	-41.11	-43.68	-28.12
		M	-48.94	-56.23	-41.10	-42.38	-27.91
		H	-49.46	-56.40	-42.23	-41.08	<b>-27.39</b>
	64QAM	L	-48.30	-57.16	-40.98	-43.08	-27.40
		M	-49.96	-55.87	-40.55	-41.05	-28.07
		H	-49.24	-56.79	-41.96	-40.72	-28.49
	256QAM	L	-49.23	-57.38	-39.60	-42.30	-27.85
		M	-43.68	-56.26	-38.63	-41.31	-28.36
		H	-48.27	-56.68	-40.70	-40.61	-27.65
4	QPSK	L	-49.73	-57.02	-38.85	-42.94	-28.69
		M	-48.92	<b>-55.62</b>	-41.24	-41.81	-27.99
		H	-48.59	-57.07	-41.01	-40.69	-28.27
	16QAM	L	-49.21	-56.07	-38.35	-43.32	-28.22
		M	-49.28	-56.29	-41.51	-43.10	-27.96
		H	-48.52	-56.20	-40.93	-40.28	-28.44
	64QAM	L	-49.60	-56.48	-38.48	-41.68	-28.55
		M	-49.41	-57.05	-41.34	-41.07	-28.50
		H	-48.40	-57.36	-41.22	-38.98	-28.52
	256QAM	L	-49.26	-57.54	-38.42	-43.27	-28.69
		M	<b>-43.30</b>	-55.78	-39.98	-41.52	-28.38
		H	-48.66	-57.18	-40.93	-39.05	-28.69

**5G NR n5 20 MHz 1C + 5G NR n5 5 MHz 1C (2 Carrier) – 4TX – Contiguous**

ANT	Modulation	CH	Result (dBm)				
			9 kHz ~ 150 kHz	150 kHz ~ 30 MHz	30 MHz ~ 868 MHz	895 MHz ~ 1 GHz	1 GHz ~ 10 GHz
1	QPSK	M	-44.88	<b>-56.28</b>	<b>-38.40</b>	-40.81	-28.65
	16QAM	M	-46.29	-57.34	<b>-37.24</b>	<b>-38.56</b>	-28.14
	64QAM	M	-48.70	<b>-56.77</b>	-38.27	-39.23	-28.25
	256QAM	M	-47.64	-57.36	-38.07	-38.60	-28.48
2	QPSK	M	<b>-43.95</b>	-57.21	-38.95	<b>-40.61</b>	<b>-28.29</b>
	16QAM	M	<b>-46.25</b>	-57.71	-38.41	-40.09	-28.27
	64QAM	M	-48.67	-57.71	-38.26	-41.51	-28.34
	256QAM	M	-48.96	-57.81	-39.46	-40.25	<b>-27.61</b>
3	QPSK	M	-44.93	-57.06	-40.28	-41.22	-28.51
	16QAM	M	-46.72	-56.97	-40.34	-39.81	-27.92
	64QAM	M	-47.94	-57.86	-39.92	-39.94	-27.95
	256QAM	M	-48.37	-57.07	-40.60	-39.75	-27.95
4	QPSK	M	-44.73	-57.06	-38.68	-41.34	-28.51
	16QAM	M	-48.41	-57.00	-38.57	-40.91	-28.80
	64QAM	M	-48.35	-57.39	-38.03	-40.79	-27.84
	256QAM	M	-47.20	-57.40	-38.93	-40.36	-28.75

**5G NR n5 20 MHz 1C + LTE B5 5 MHz 1C (2 Carrier) – 4TX - Contiguous**

ANT	Modulation	CH	Result (dBm)				
			9 kHz ~ 150 kHz	150 kHz ~ 30 MHz	30 MHz ~ 868 MHz	895 MHz ~ 1 GHz	1 GHz ~ 10 GHz
1	QPSK	M	-42.39	<b>-55.46</b>	<b>-38.28</b>	<b>-39.14</b>	-28.40
	16QAM	M	-42.47	-56.52	<b>-37.09</b>	-38.08	-27.75
	64QAM	M	-42.93	-56.27	-38.06	-38.07	-28.40
	256QAM	M	-42.79	-56.35	-38.60	-40.06	-28.39
2	QPSK	M	-43.06	-56.48	-39.06	-41.38	-28.60
	16QAM	M	-42.58	-57.05	-39.45	-40.23	-27.98
	64QAM	M	<b>-42.23</b>	-56.88	-38.64	-40.29	-28.37
	256QAM	M	-42.44	-57.18	-38.74	-40.19	-27.80
3	QPSK	M	-42.81	-56.04	-39.94	-39.37	<b>-27.42</b>
	16QAM	M	-43.26	-56.69	-41.17	-39.48	<b>-27.04</b>
	64QAM	M	-42.74	-56.35	-38.83	<b>-36.07</b>	-28.08
	256QAM	M	-42.59	-56.74	-40.62	-38.32	-27.65
4	QPSK	M	<b>-42.33</b>	-56.82	-39.45	-40.87	-27.98
	16QAM	M	-43.16	-56.69	-38.35	-40.68	-28.51
	64QAM	M	-42.82	-56.24	-38.80	-41.60	-28.24
	256QAM	M	-43.45	<b>-55.97</b>	-38.86	-40.65	-28.81

### 8.5.2. WORST PLOT OF OUT OF BAND EMISSIONS (SPURIOUS)

#### 5G NR n5 20 MHz (1 Carrier) – 4TX

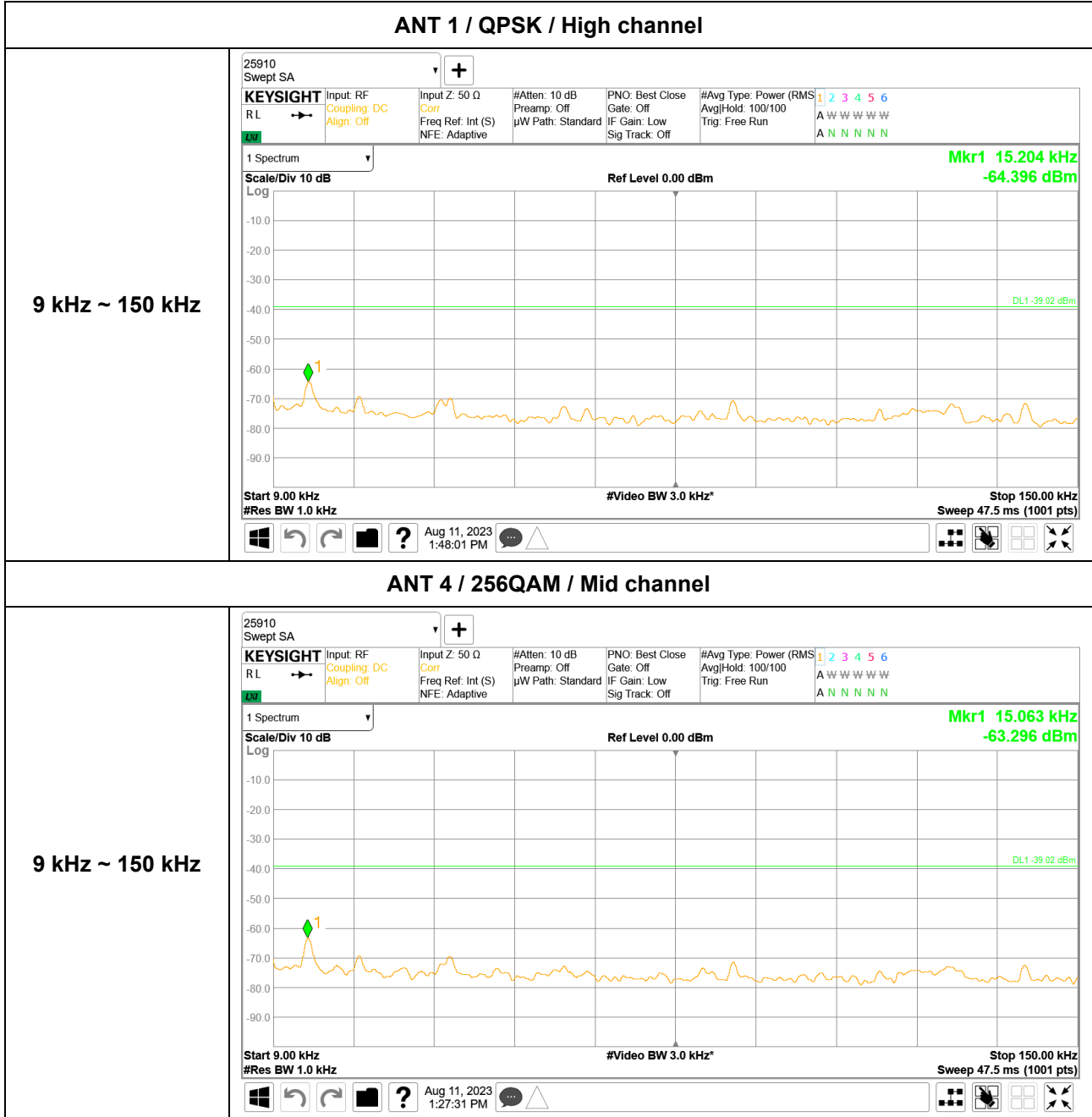

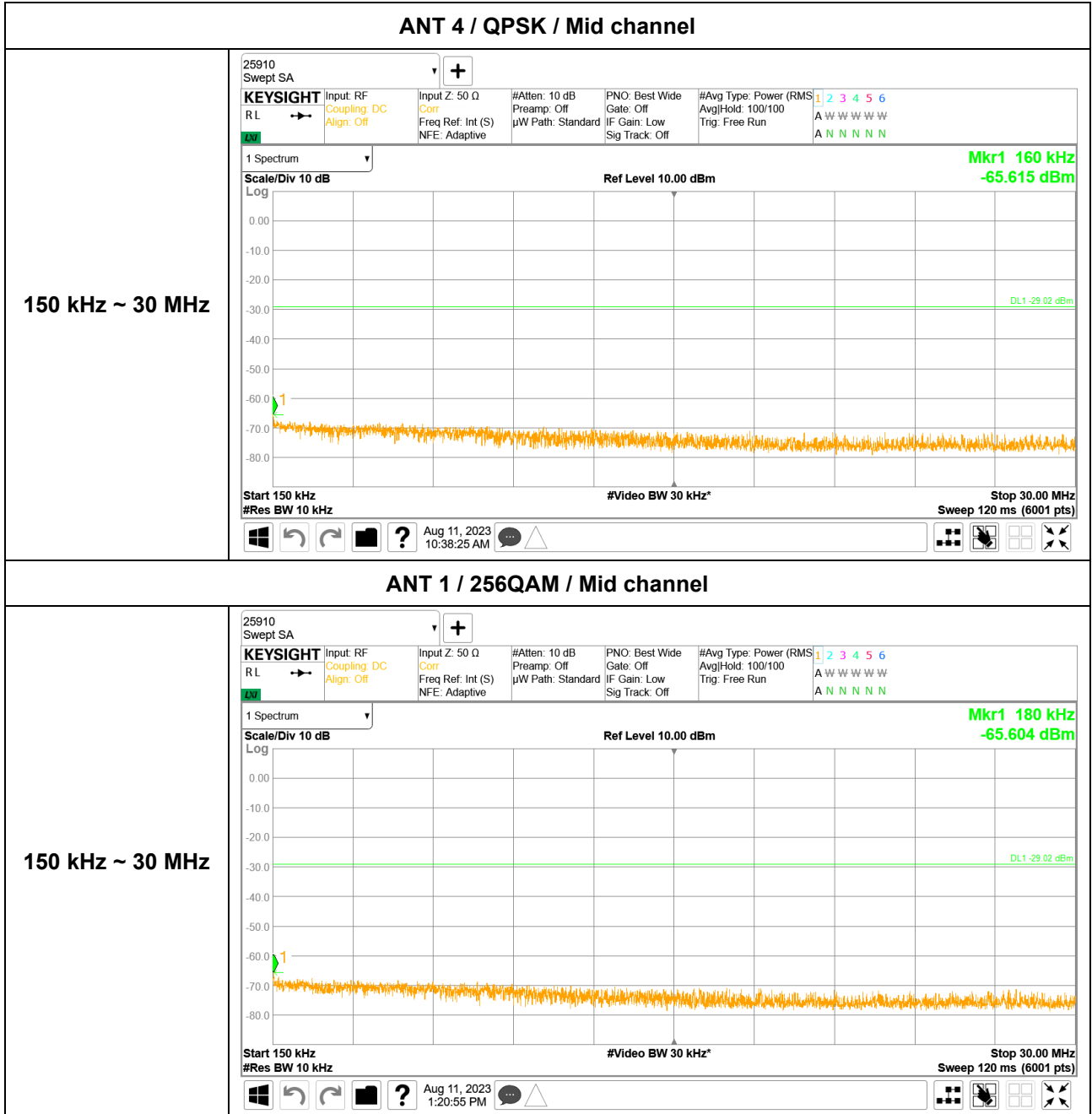

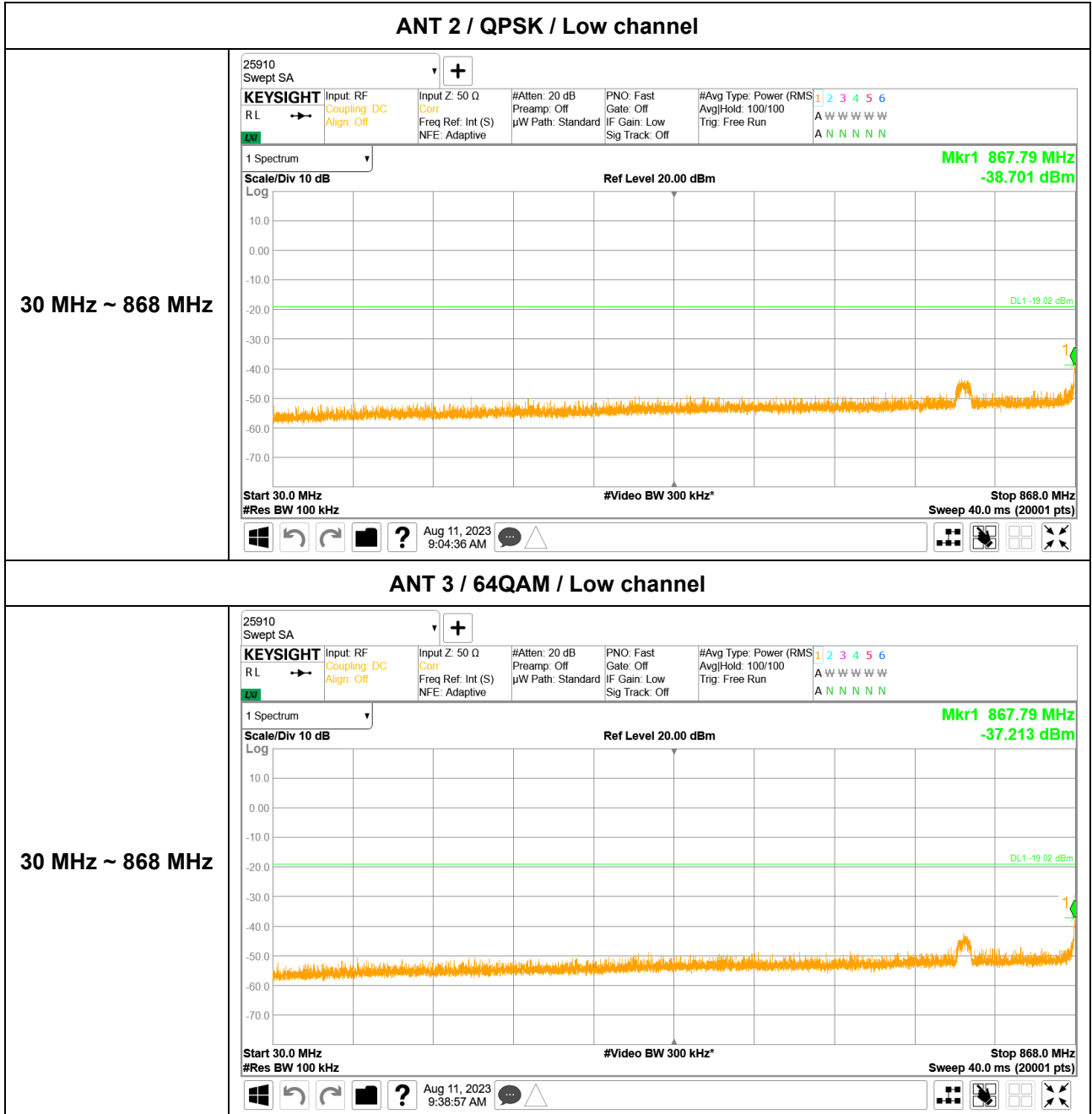



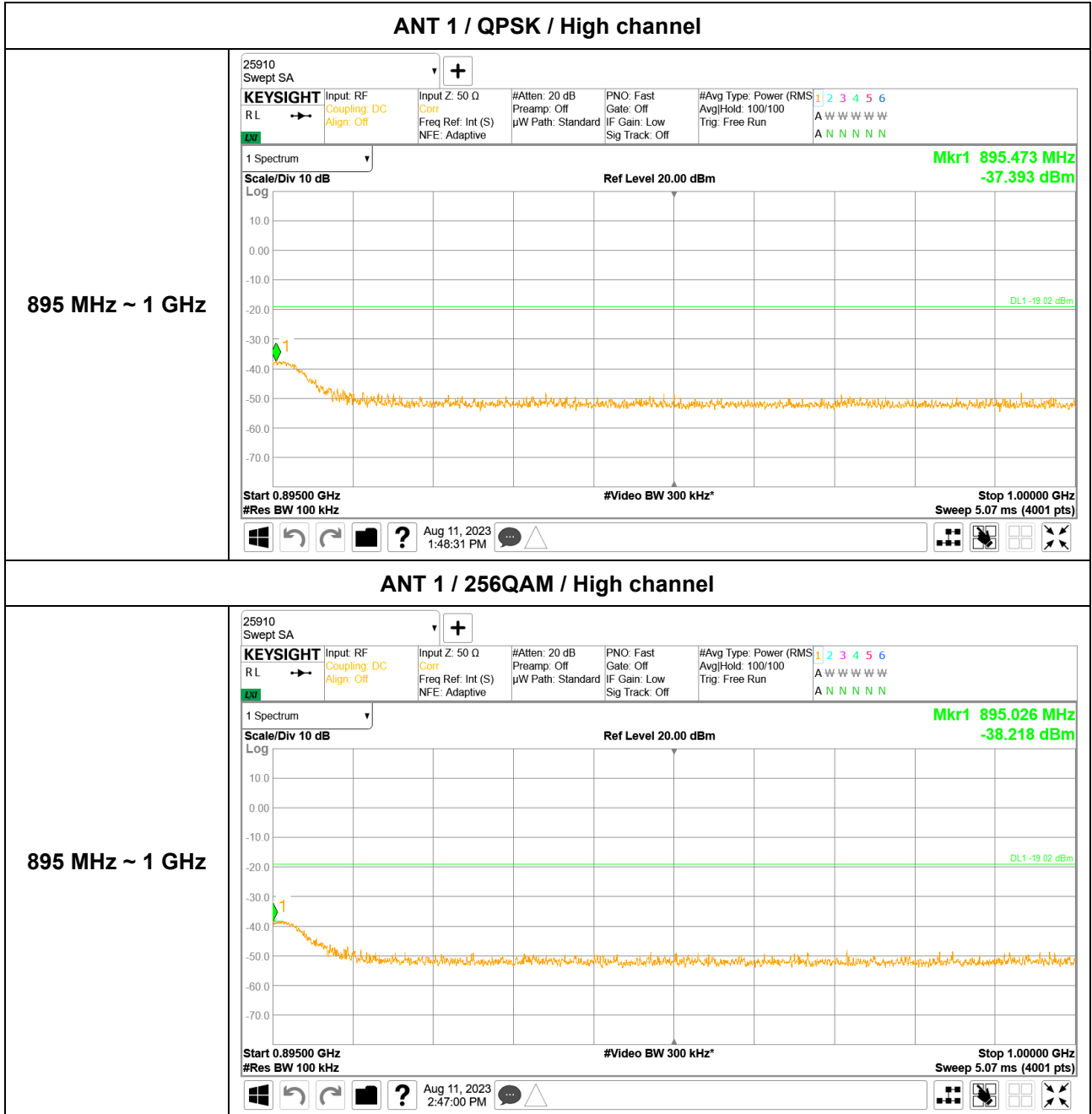

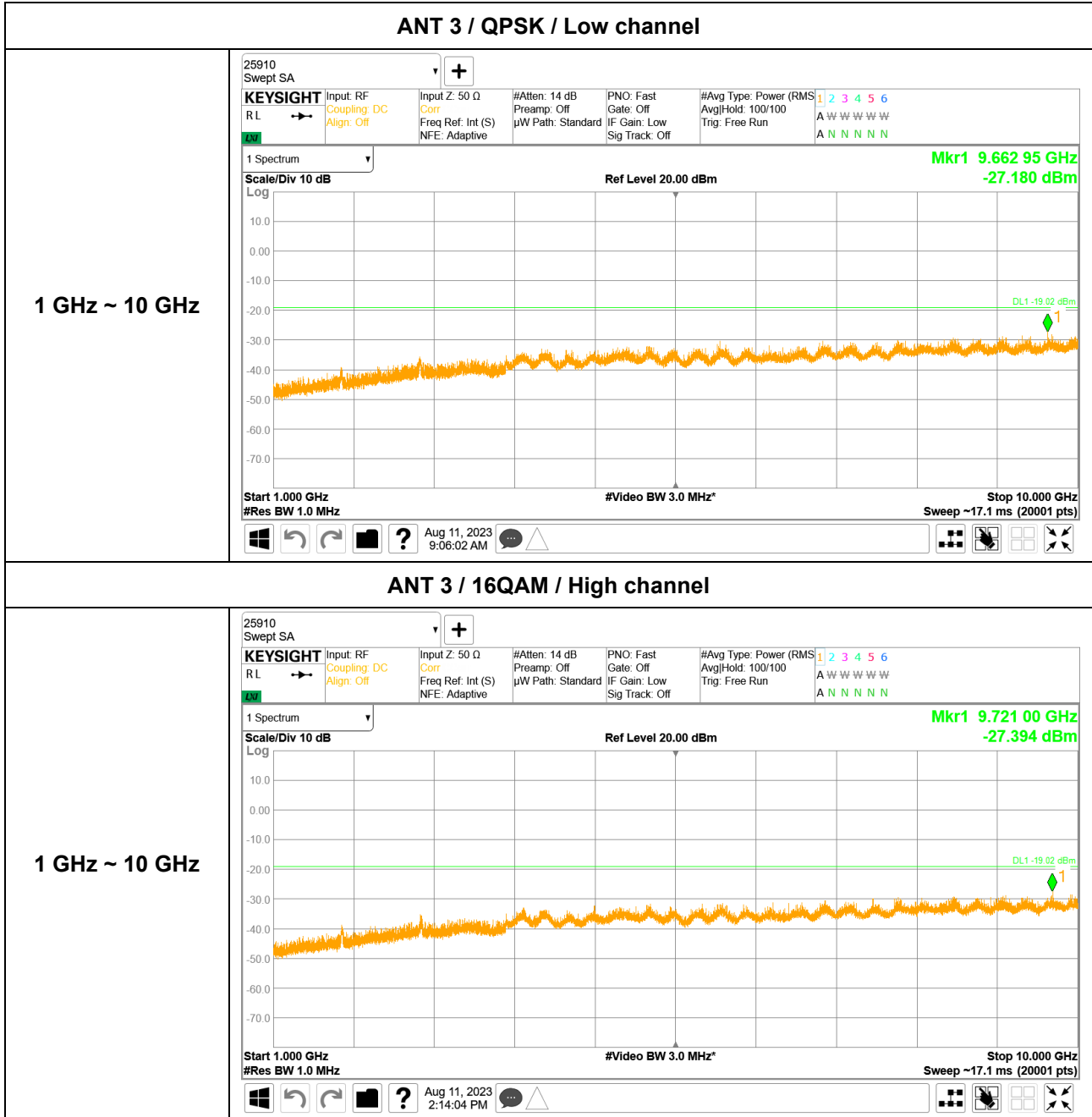

**5G NR n5 20 MHz 1C + 5G NR n5 5 MHz 1C (2 Carrier) – 4TX – Contiguous**



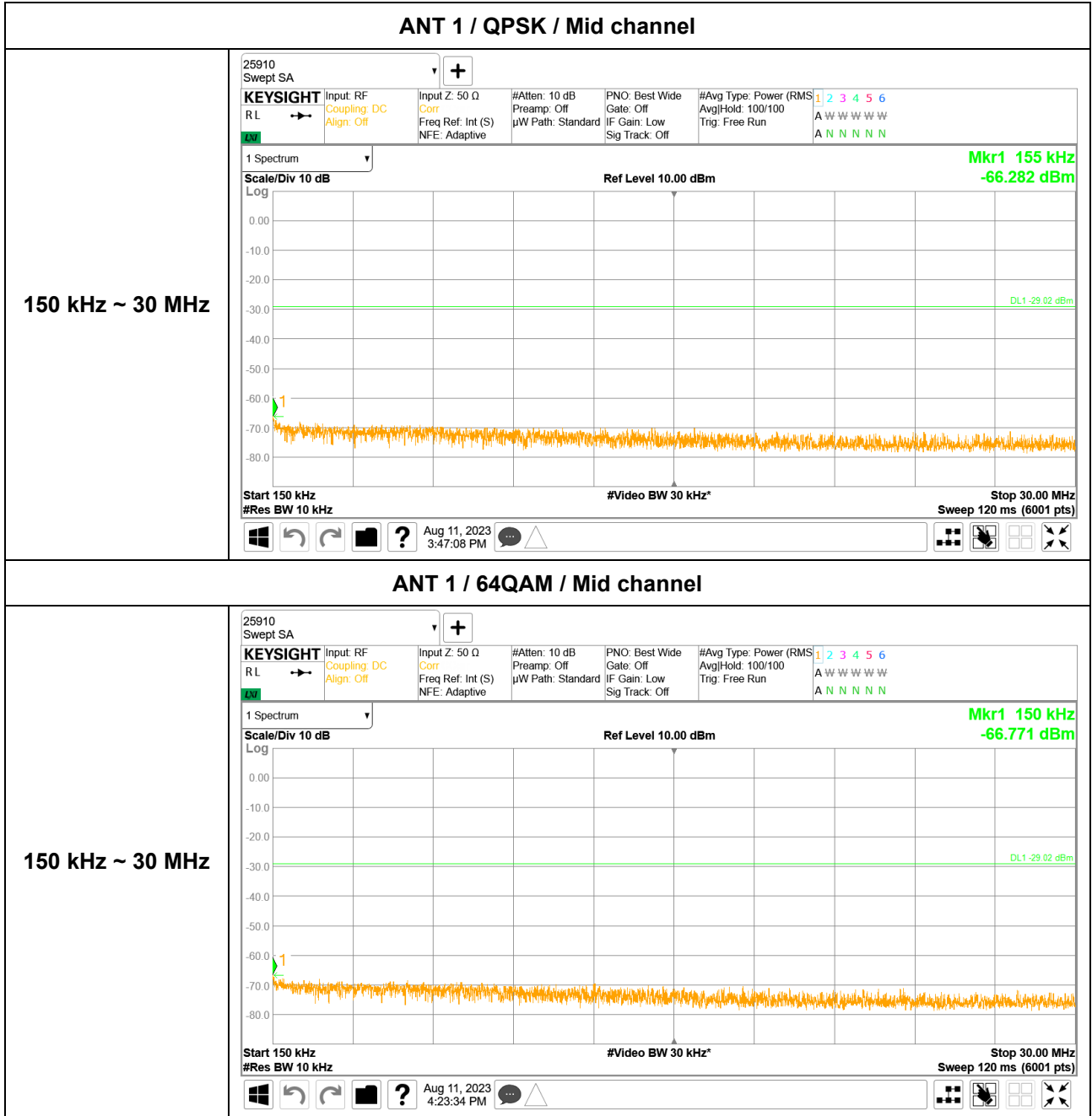

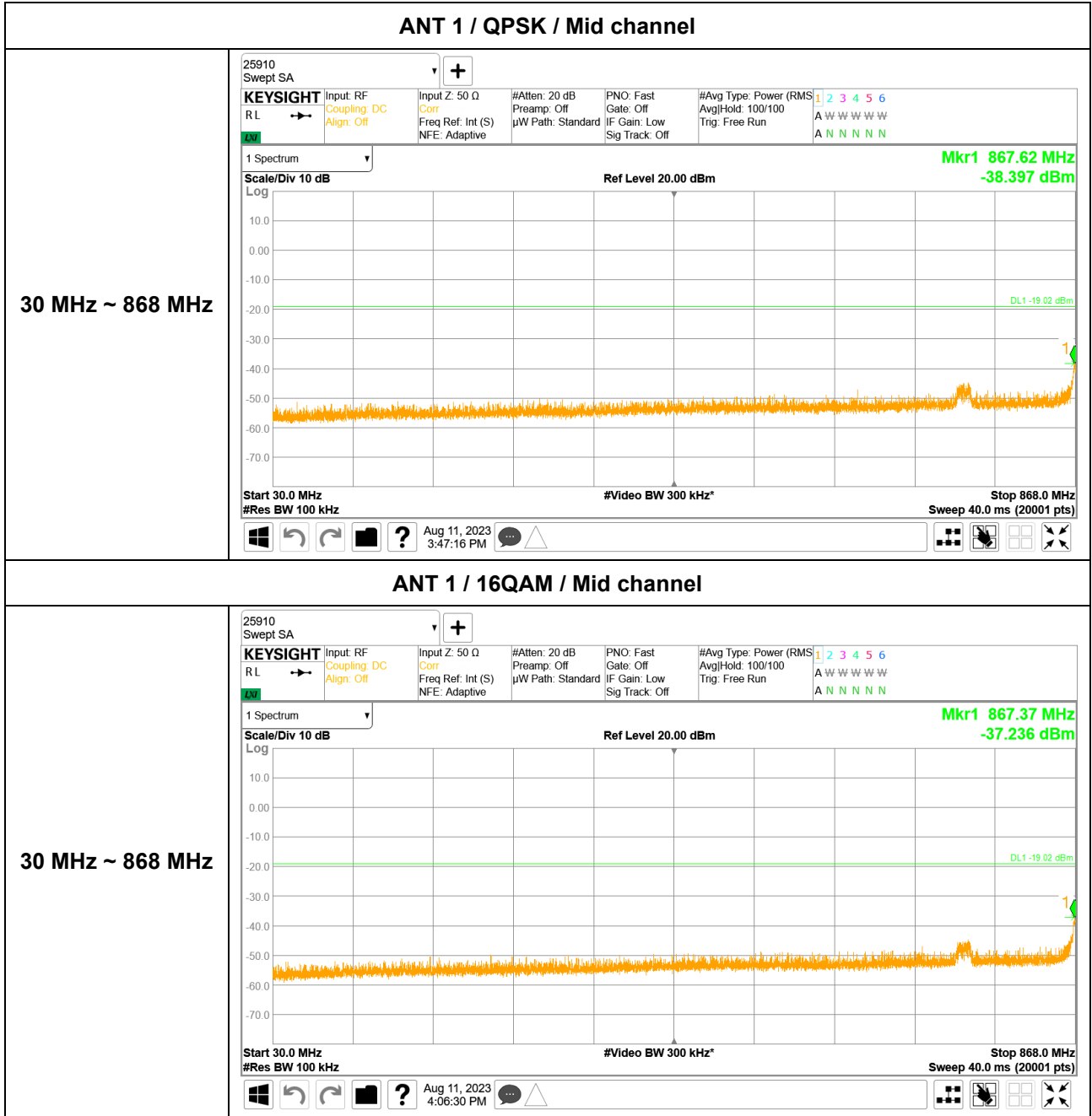



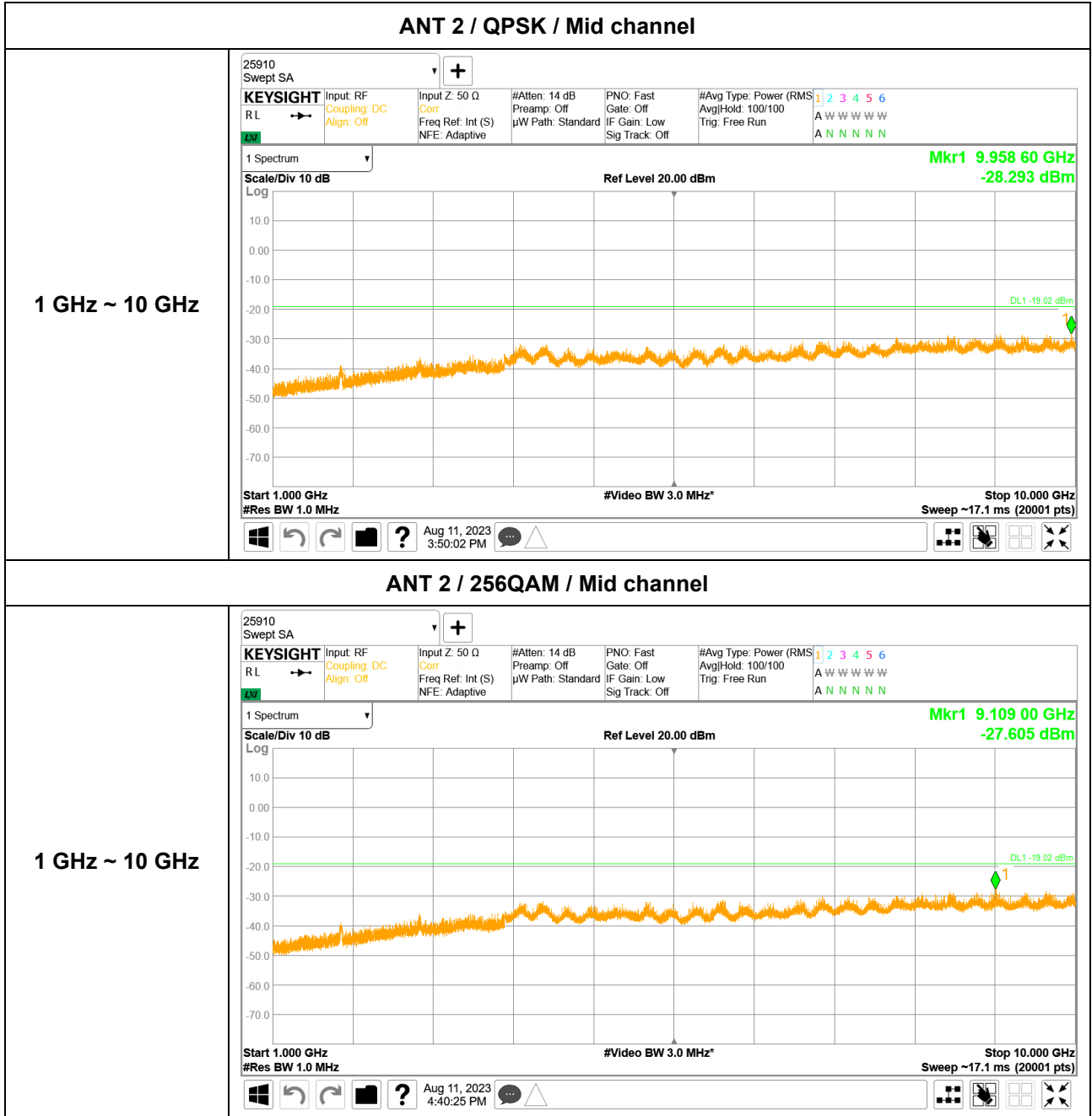

**5G NR n5 20 MHz 1C + LTE B5 5 MHz 1C (2 Carrier) – 4TX - Contiguous**







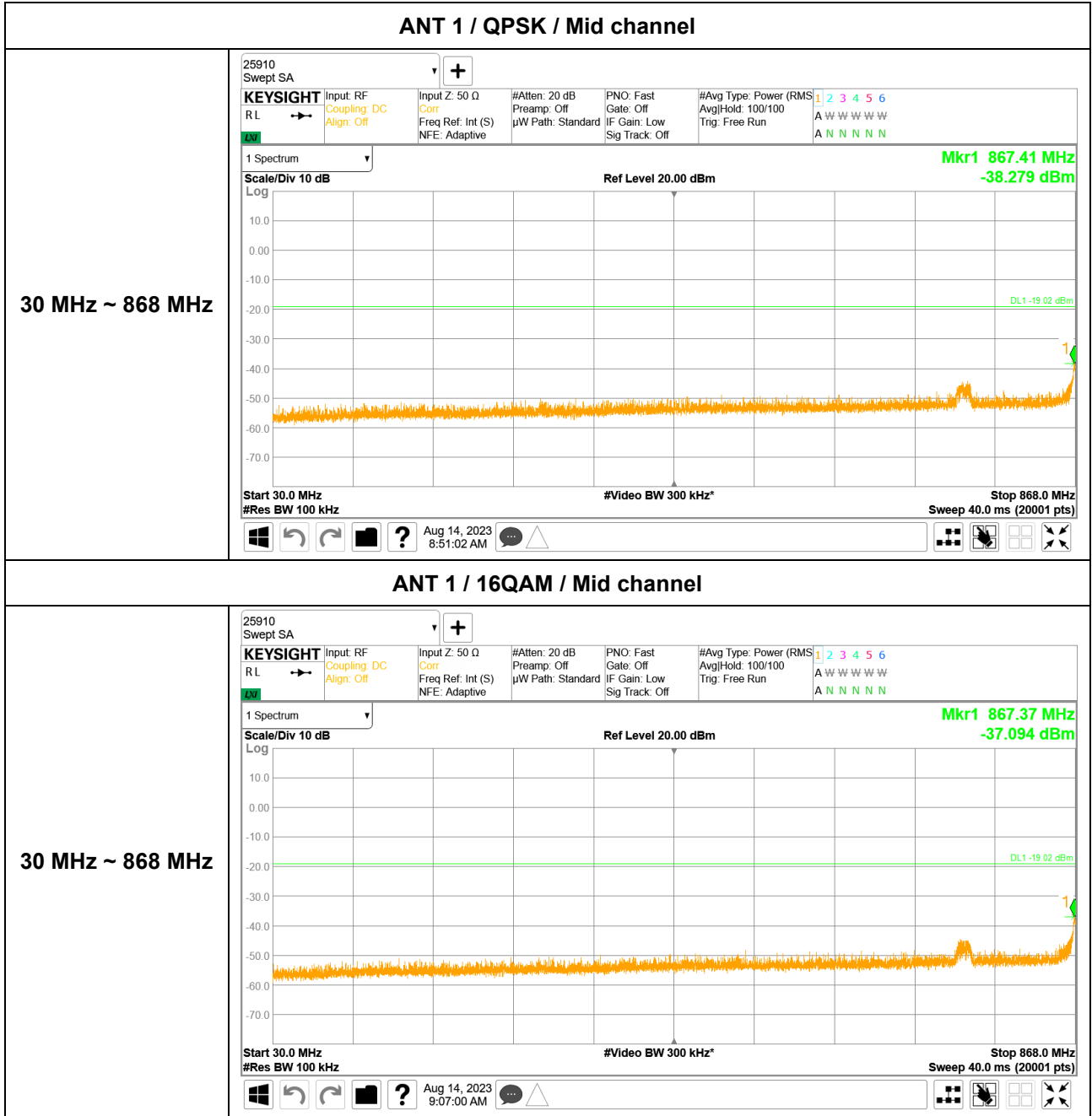

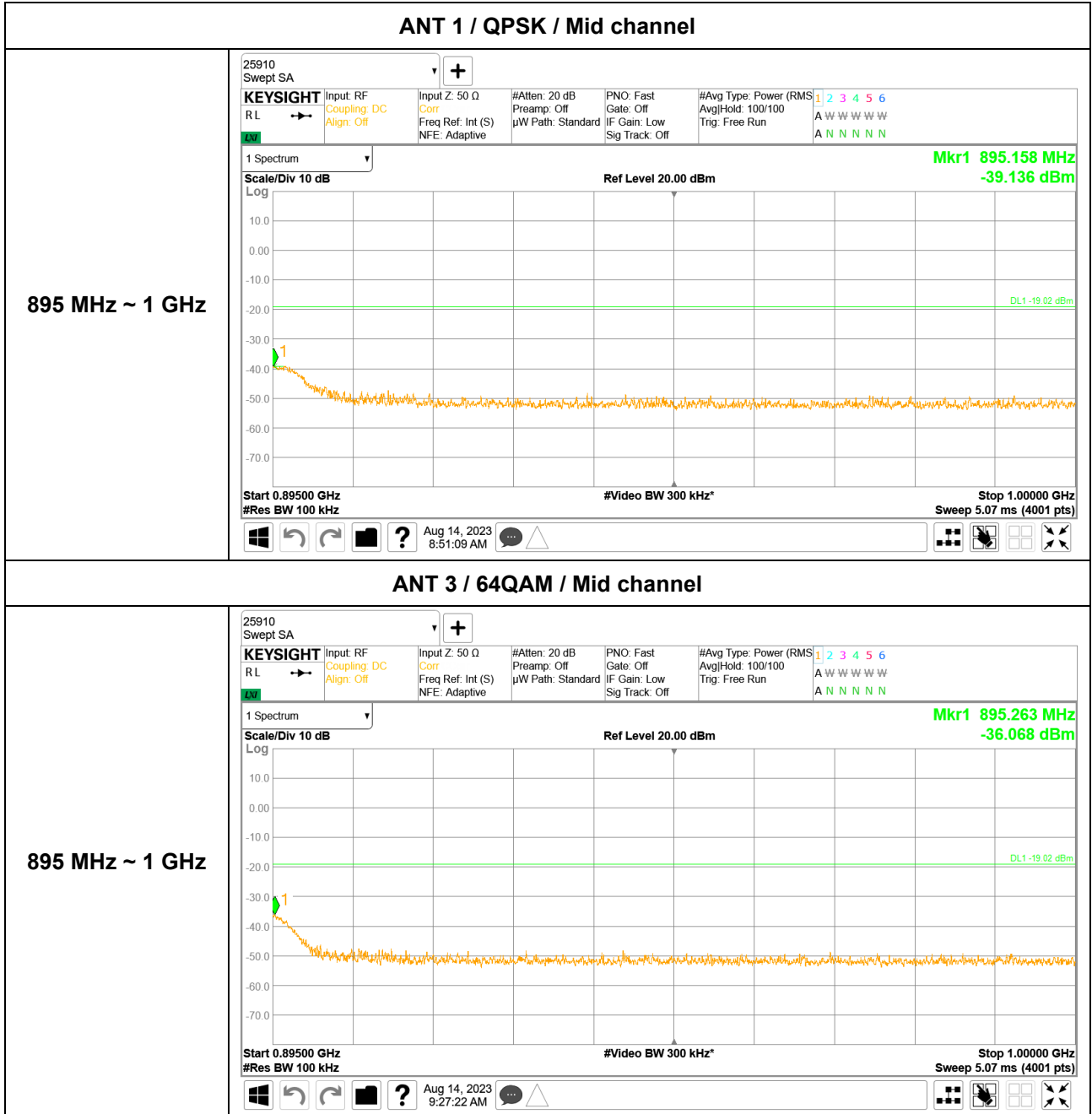

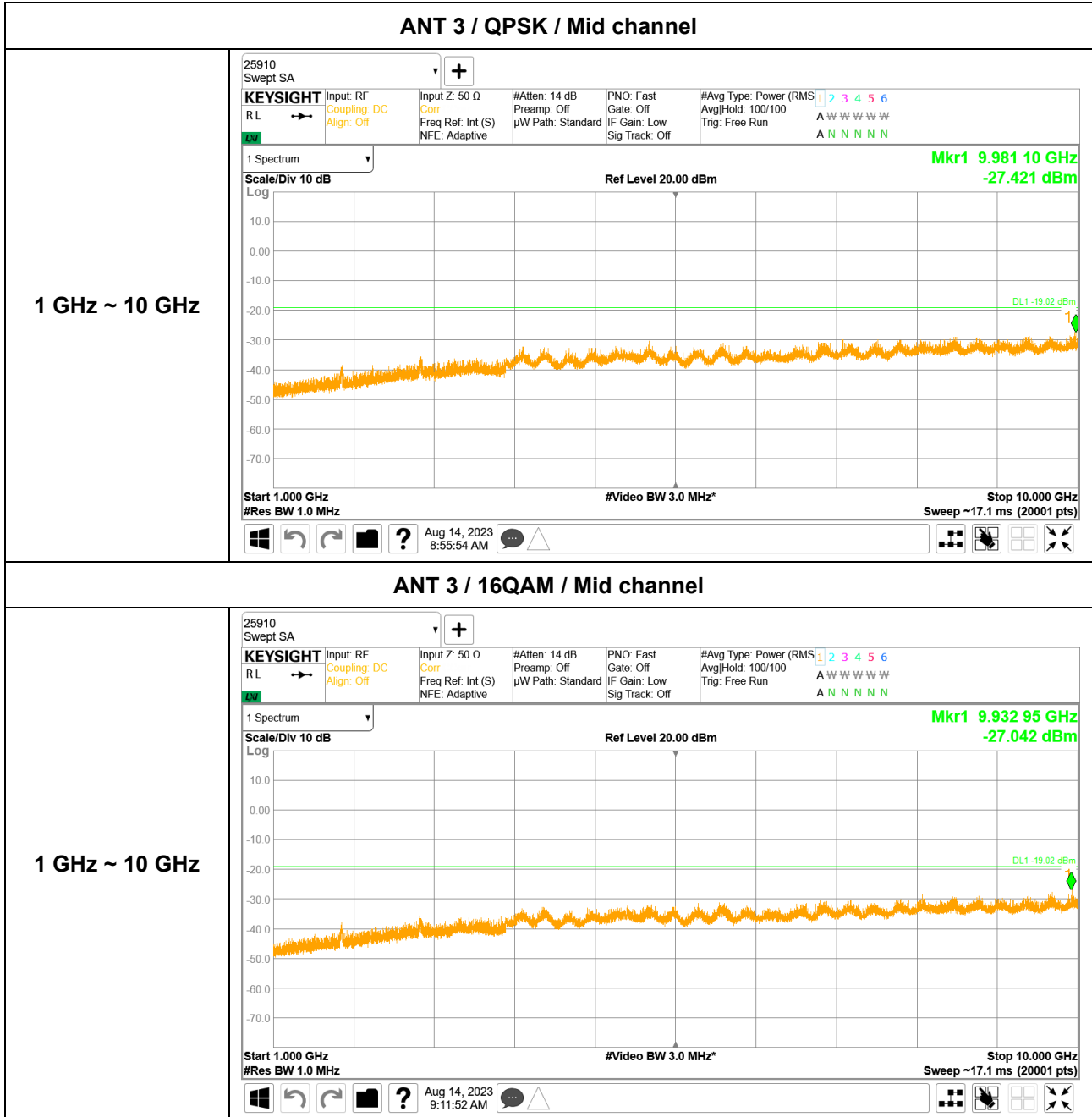

## 8.6. FREQUENCY STABILITY

### RULE PART(S)

FCC: §2.1055

### LIMITS

(a) The frequency stability shall be measured with variation of ambient temperature as follows:

- (1) From  $-30^{\circ}$  to  $+50^{\circ}$  centigrade for all equipment except that specified in paragraphs (a) (2) and (3) of this section.

### TEST PROCEDURE

According to the section 5.6.3, 5.6.4, 5.6.5 of ANSI C63.26

### RESULTS

See the following pages.

### 8.6.1. FREQUENCY STABILITY RESULTS

**5G NR n5 20 MHz (1 Carrier)**

Reference Frequency : 881.5 MHz @ 20°C				
Power Supply [Vdc]	Environment Temperature [°C]	Frequency Deviation Measured with Time Elapse		
		Frequency [Hz]	Deviation [Hz]	Delta [ppm]
-48.00	+ 50	881 530 089.498	-4.626	-0.0052
	+ 40	881 530 086.125	-1.253	-0.0014
	+ 30	881 530 085.244	-0.372	-0.0004
	<b>+ 20</b>	<b>881 530 084.872</b>	<b>0.000</b>	<b>0.0000</b>
	+ 10	881 530 083.942	0.930	0.0011
	0	881 530 083.470	1.402	0.0016
	-10	881 530 078.044	6.828	0.0077
	-20	881 530 080.107	4.765	0.0054
	-30	881 530 080.168	4.704	0.0053
-55.20	+ 20	881 530 089.644	-4.772	-0.0054
-40.80	+ 20	881 530 084.229	0.643	0.0007

Note: The test results of the frequency stability shown above table are result for ANT 1.  
 The results of all ports are similar, and the worst of them has been reported.

## 8.7. RADIATED EMISSIONS

### RULE PART(S)

FCC : §2.1053, §22.917

### LIMIT

§22.917

The rules in this section govern the spectral characteristics of emissions in the Cellular Radiotelephone Service.

(a) Out of band emissions. The power of any emission outside of the authorized operating frequency ranges must be attenuated below the transmitting power (P) by a factor of at least  $43 + 10 \log(P)$  dB.

(b) Measurement procedure. Compliance with these rules is based on the use of measurement instrumentation employing a reference bandwidth as follows:

(1) In the spectrum below 1 GHz, instrumentation should employ a reference bandwidth of 100 kHz or greater. In the 1 MHz bands immediately outside and adjacent to the frequency block, a resolution bandwidth of at least one percent of the emission bandwidth of the fundamental emission of the transmitter may be employed. A narrower resolution bandwidth is permitted in all cases to improve measurement accuracy, provided that the measured power is integrated over the full required reference bandwidth (i.e., 100 kHz or 1 percent of emission bandwidth, as specified). The emission bandwidth is defined as the width of the signal between two points, one below the carrier center frequency and one above the carrier center frequency, outside of which all emissions are attenuated at least 26 dB below the transmitter power.

(2) In the spectrum above 1 GHz, instrumentation should employ a reference bandwidth of 1 MHz.

(c) Alternative out of band emission limit. Licensees in this service may establish an alternative out of band emission limit to be used at specified band edge(s) in specified geographical areas, in lieu of that set forth in this section, pursuant to a private contractual arrangement of all affected licensees and applicants. In this event, each party to such contract shall maintain a copy of the contract in their station files and disclose it to prospective assignees or transferees and, upon request, to the FCC.

(d) Interference caused by out of band emissions. If any emission from a transmitter operating in this service results in interference to users of another radio service, the FCC may require a greater attenuation of that emission than specified in this section.

## **TEST PROCEDURE**

According to the section 5.5.4.2 of ANSI C63.26:

- a) Place the EUT in the center of the turntable. The EUT shall be configured to transmit into the standard non-radiating load (for measuring radiated spurious emissions), connected with cables of minimal length unless specified otherwise. If the EUT uses an adjustable antenna, the antenna shall be positioned to the length that produces the worst case emission at the fundamental operating frequency.
- b) Each emission under consideration shall be evaluated:
  - 1) Raise and lower the measurement antenna in accordance 5.5.2, as necessary to enable detection of the maximum emission amplitude relative to measurement antenna height.
  - 2) Rotate the EUT through 360° to determine the maximum emission level relative to the axial position.
  - 3) Return the turntable to the azimuth where the highest emission amplitude level was observed.
  - 4) Vary the measurement antenna height again through 1 m to 4 m again to find the height associated with the maximum emission amplitude.
  - 5) Record the measured emission amplitude level and frequency using the appropriate RBW.
- c) Repeat step b) for each emission frequency with the measurement antenna oriented in both the horizontal and vertical polarizations to determine the orientation that gives the maximum emissions amplitude.
- d) ~ j) Omitted
- k) Provide the complete measurement results as a part of the test report.

Note1. All transmitting ports were terminated.

Note2. The results of the Radiated Emission test are measured at the max.output power (for conducted data), and data values are attached only in the worst case.

Note3. For all radiated emissions, any emission outside of the operating frequency bands was not exceed the limit.

Note4. The amplitude of spurious emissions which are attenuated more than 20 dB below the permissible values was not recorded. (ANSI C63.26, clause 5.1.1., c)

## **RESULTS**

See the following pages.



### 8.7.1. SPURIOUS RADIATION RESULTS

#### 5G NR n5 20 MHz 256QAM (1 Carrier) – 4TX

CH	Frequency	Measured Level (dBuV/m)	Ant. Factor (dB/m)	Cable Loss (dB)	Amp Gain (dB)	Pol.	Result	
							dBuV/m	dBm
No critical peak emissions were found.								

Note.

Data Result (dBm) = Measured Level + Ant. Factor + [Filter + Cable loss - Amp gain] - 95.2

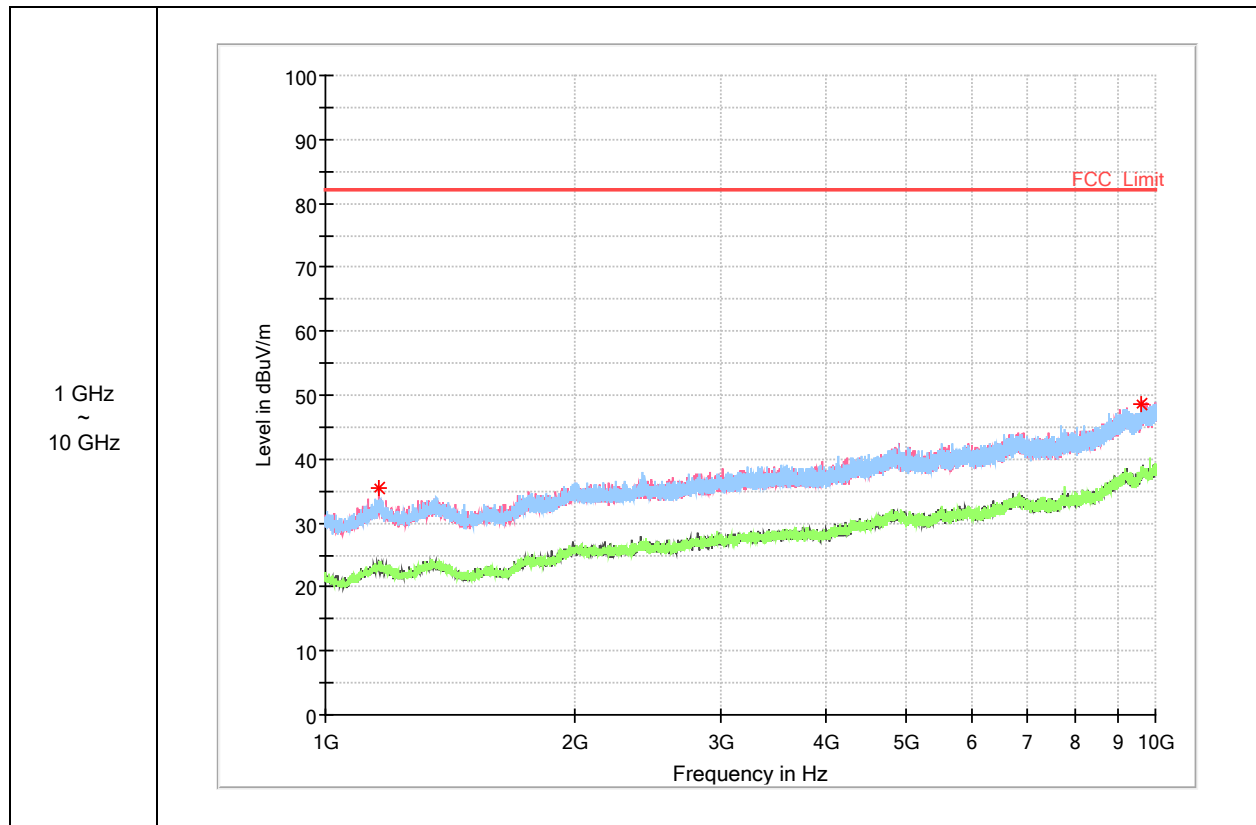

Note. Only the worst case plot for Radiated Spurious Emissions.

## END OF TEST REPORT