

Regulatory WLAN Antenna Information (Template)

Platform information							
Brand	ODM	*****Platform model name	Platform type (ex: regular NB, convertible PC, AIO...etc)	*SAR minimum separation (mm)			
Samsung	Samsung	NP340XNA	Note - PC				
*****Please fill in exact product model name and make sure the model name is visible on product cover or any parts for end users recognize for authority inspection. Product model name in antenna spec should be aligned with product model names on system photo label (only for NCC antenna submission).							
Antenna information				Peak gain w/ cable loss (dBi)			
Vendor	Type	Antenna Part number (WIFI0 & WIFI1)		2.4GHz	5.2GHz	5.5GHz	5.8GHz
Galtronics	F-PCB	02112226-07522		-3.12	-7.46	-7.16	-7.30
				6.1GHz	6.5GHz	6.7GHz	7.0GHz
				-8.02	-8.01	-8.02	-8.05

- Regular NB: Minimum antenna-to-body (from antenna bottom to the bottom of the device)
- Tablet / Convertible PC: Minimum antenna-to-edge (5 sides of the device)

Antenna Sample / Antenna Data Requirements for worldwide regulatory approval

Section	Description of Required OEM / ODM Antenna Information	US / IC	EU	Japan	Taiwan	S.Korea
1A	Part Number for Antenna only	Required	Required	Required	Required	Required
1B	Antenna Manufacturer Name	Required	Required	Required	Required	Required
1C	Description of Antenna Type	Required	N/A	N/A	N/A	N/A
1D	Part number of Antenna Assembly / cable impedance, length & diameter.	Required	Desired	Desired	Desired	Desired
1E	Tx1, Tx2 & Tx3 antenna (Peak Gain W/ cable loss) *	Required	Required	Required	Required	Required
	1E OR 1F, 1G, 1H					
1F	Tx1, Tx2 & Tx3 antenna (Peak Gain only) *	Required	Required	Required	Required	Required
1G	VSWR of cable including connector	Required	Required	Required	Required	Required
1H	Tx1, Tx2 & Tx3 antenna (Cable loss W/ connector) *	Required	Required	Required	Required	Required
2	Dimensioned Photographs and Drawings of Tx1, Tx2, and Tx3 (or Rx3) antennas	Required	Required	Required	Required	Required
3	Radiation patterns of antennas loaded in the host platform.	Required	Desired	Required	N/A	Required
4	Platform model name / number - correlated to antenna manufacturer and antenna part number	Required	Required	Desired	Required	Desired
5	Photograph(s) or Drawings showing location of antennas in platform. (S. Korea requires photographs of antennas for approval submission). Taiwan requires pictures of each antenna type shown in the system.	Required	Required	Desired	Required (Photos)	Required (Photos)
6	Mech. drawings / photos with dimensions of antenna locations and distance from end-user (For evaluation of SAR testing requirement).	Required	N/A	N/A	N/A	N/A
7	Photograph(s) or Drawings showing the location of all antennas (WLAN, other) and distance between those transmitting antennas. Information will be used to evaluate whether co-location testing is required.	Required	N/A	N/A	N/A	N/A
8	Local representative contact information for LMA/ PARS process.	Required	N/A	N/A	N/A	N/A

1. Applicable test methods

This test report is prepared for P4 16” Bassoon(Z8LB) antenna testing under a Full Anechoic Chamber.

1-1. Return Loss & VSWR Test

The VSWR measurement of antennas assembled into a fully operating NP340XNA is measured on the Network Analyzer. The handset is set up with a 50 Ohm coaxial cable connected to the 50 Ohm point. Calibration is done at the end of the 50 Ohm coaxial cable is connected to a network analyzer. The handset is positioned on a non-conductive JIG for free space measurements.

1-2. Radiation Pattern Test

Antennas tested for Gain and Efficiency must be assembled into the enclosure and tested in the fully assembled and operating NP340XNA. The antenna is tested in free space in the anechoic chamber. The radiation patterns are measured and the center of transmit and receive bands.

1-3. Test Method (manufacturing)

All measurements are done with NP340XNA fully assembled. Measure in consideration of the customer’s usage environment. Use of fully shielded chamber environment to prevent any noise-induced errors. Typically, the electrical properties of the antenna are measured using a jig that can hold the set.

2. Test & System Description

a. Test setup

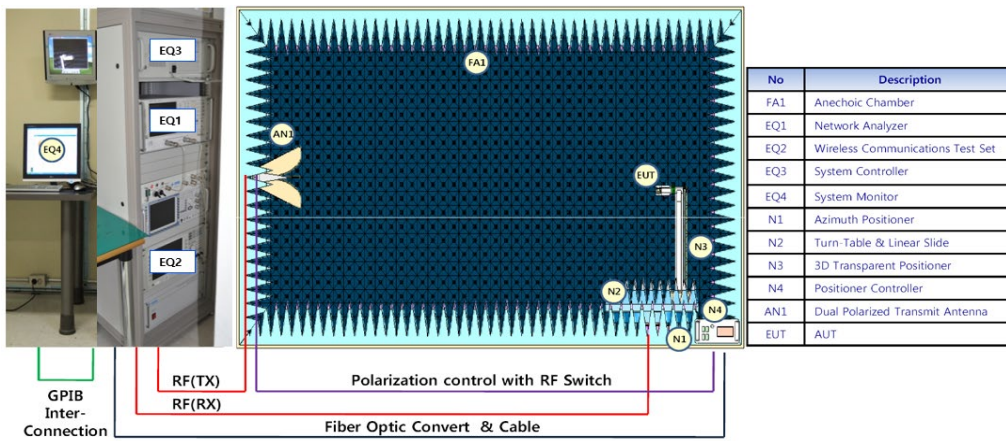

b. Equipment list

Device	Type	Serial No	Manufacturer
BLUETOOTH TESTER	TC-3000A	3000A5A0261	
WIRELESS COMMUNICATIONS TEST SET	8960	GB44300408	AGILENT
WIMAX COMMUNICATION TESTER	CMW270	100399	ROHDE&SCHWARZ
RADIO COMMUNICATION ANALYZER	MT8820C	6201274520	Anritsu
ENA SERIES NETWORK ANALYZER	N5230A	MY45000186	AGILENT

Equipment cal. Date	Date of calibration	Tester signature	S / W
2022-02-11	2022-10-12		VWM21

3. Setup photo

Please refer to Appendix_Antenna specification 1-1. WiFi0, WiFi1 Setup photo.

Antenna Information

Section 1. Antenna Assembly Specifications

1A Antenna Part Number	1B Manufacture	1C Antenna Type	1D Cable Assembly Part Number and Information	1E *Peak Gain W/ Cable loss (dBi)	1F Peak Gain w/o Cable Loss (dBi)	1G VSWR	1H Cable Loss (dBi)
(P/N: 02112226-07522) Tx1/ Rx1 Antenna (Wifi0)	Galtronics	PIFA	50 ohm Coaxial length: 196.9mm diameter: 0.81mm	1575MHz -2.98 dBi (peak)	1575MHz -2.58 dBi (peak)	1575MHz 2.38 max	1575MHz 0.40 dBi (peak)
				2400-2500MHz -3.12 dBi (peak)	2400-2500MHz -2.54 dBi (peak)	2400-2500MHz 2.38 max	2400-2500MHz 0.58 dBi (peak)
				5150-5350MHz - 7.46 dBi (peak)	5150-5350MHz - 6.45 dBi (peak)	5150-5350MHz 2.26 max	5150-5350MHz 1.01 dBi (peak)
				5470-5725MHz - 7.16 dBi (peak)	5470-5725MHz - 6.12 dBi (peak)	5470-5725MHz 2.38 max	5470-5725MHz 1.04 dBi (peak)
				5785-5850MHz - 7.30 dBi (peak)	5785-5850MHz - 6.22 dBi (peak)	5725-5850MHz 2.05 max	5785-5850MHz 1.08 dBi (peak)
				5955-6415MHz -8.02 dBi (peak)	5955-6415MHz -6.89 dBi (peak)	5955-6415MHz 1.92 max	5955-6415MHz 1.13 dBi (peak)
				6435-6515MHz -8.01 dBi (peak)	6435-6515MHz -6.76 dBi (peak)	6435-6515MHz 1.65 max	6435-6515MHz 1.25 dBi (peak)
				6535-6875MHz -8.02 dBi (peak)	6535-6875MHz -6.72 dBi (peak)	6535-6875MHz 2.02 max	6535-6875MHz 1.30 dBi (peak)
				6895-7115MHz -8.05 dBi (peak)	6895-7115MHz -6.67 dBi (peak)	6895-7115MHz 2.19 max	6895-7115MHz 1.38 dBi (peak)
(P/N: 02112226-07522) Tx1/ Rx1 Antenna (Wifi1)	Galtronics	PIFA	50 ohm Coaxial length: 140.9mm diameter: 1.13mm	2400-2500MHz -3.04 dBi (peak)	2400-2500MHz -2.56 dBi (peak)	2400-2500MHz 2.13 max	2400-2500MHz 0.48 dBi (peak)
				5150-5350MHz -6.79 dBi (peak)	5150-5350MHz -6.08 dBi (peak)	5150-5350MHz 1.74 max	5150-5350MHz 0.71 dBi (peak)
				5470-5725MHz -6.99 dBi (peak)	5470-5725MHz -6.26 dBi (peak)	5470-5725MHz 1.58 max	5470-5725MHz 0.73 dBi (peak)
				5785-5850MHz -6.89 dBi (peak)	5785-5850MHz -6.13 dBi (peak)	5725-5850MHz 1.58 max	5785-5850MHz 0.76 dBi (peak)
				5955-6415MHz -8.02 dBi (peak)	5955-6415MHz -6.89 dBi (peak)	5955-6415MHz 1.72 max	5955-6415MHz 1.13 dBi (peak)
				6435-6515MHz -8.12 dBi (peak)	6435-6515MHz -6.87 dBi (peak)	6435-6515MHz 1.84 max	6435-6515MHz 1.25 dBi (peak)
				6535-6875MHz -8.06 dBi (peak)	6535-6875MHz -6.76 dBi (peak)	6535-6875MHz 1.72 max	6535-6875MHz 1.30 dBi (peak)
				6895-7115MHz -8.15 dBi (peak)	6895-7115MHz -6.77 dBi (peak)	6895-7115MHz 2.96 max	6895-7115MHz 1.38 dBi (peak)

- Antenna Peak Gain required being test in system basis.
- 1E frame contend absolutely peak antenna gain include H/V

Antenna Peak Gain Table:

	WIFI0		WIFI1	
Frequency (MHz)	Peak	Avg	Peak	Avg
	(dBi)	(dBi)	(dBi)	(dBi)
2400	-3.77	-4.88	-3.51	-4.61
2450	-3.12	-4.57	-3.04	-4.3
2500	-4.53	-5.01	-3.99	-4.81
5150	-7.46	-8.11	-6.79	-7.61
5250	-7.52	-8.31	-7.11	-8.08
5350	-7.63	-8.5	-7.23	-8.21
5470	-7.54	-8.33	-7.29	-8.26
5600	-7.37	-8.25	-7.08	-8.01
5725	-7.16	-8.01	-6.99	-7.99
5785	-7.3	-8.09	-6.89	-7.92
5850	-7.45	-8.29	-7.13	-8.1

	WIFI0		WIFI1	
Frequency (MHz)	Peak	Avg	Peak	Avg
	(dBi)	(dBi)	(dBi)	(dBi)
5955 MHz	-8.02	-9.94	-8.18	-10.02
6415 MHz	-8.14	-9.88	-8.02	-9.88
6435 MHz	-8.01	-9.92	-8.12	-10.14
6515 MHz	-8.03	-9.87	-8.14	-10.16
6535 MHz	-8.05	-9.78	-8.15	-9.95
6875 MHz	-8.02	-10.01	-8.06	-10.11
6895 MHz	-8.05	-10.11	-8.15	-10.34
7115 MHz	-8.18	-10.12	-8.15	-10.24

WiFi1,2 Antenna Drawing:

Please refer to Appendix_Antenna specification **1-2. WiFi0,1 Antenna Drawing.**

WiFi1,2 Antenna Photo (Front/Back):

Please refer to Appendix_Antenna specification **1-3. WiFi0,1 Antenna Photo (Front/Back).**

Note: antenna photo should include L type ruler

Section 3. Radiation characteristics of antennae Loaded in Host Platform

2400-2500MHz radiation characteristic

WiFi Main antenna: 2400 ~ 2500MHz

WiFi

1575MHz~2500MHz

<Horizontal>

No.	Freq.	Gain [dBi]
1	1575.000	
2	2400.000	
3	2450.000	
4	2500.000	

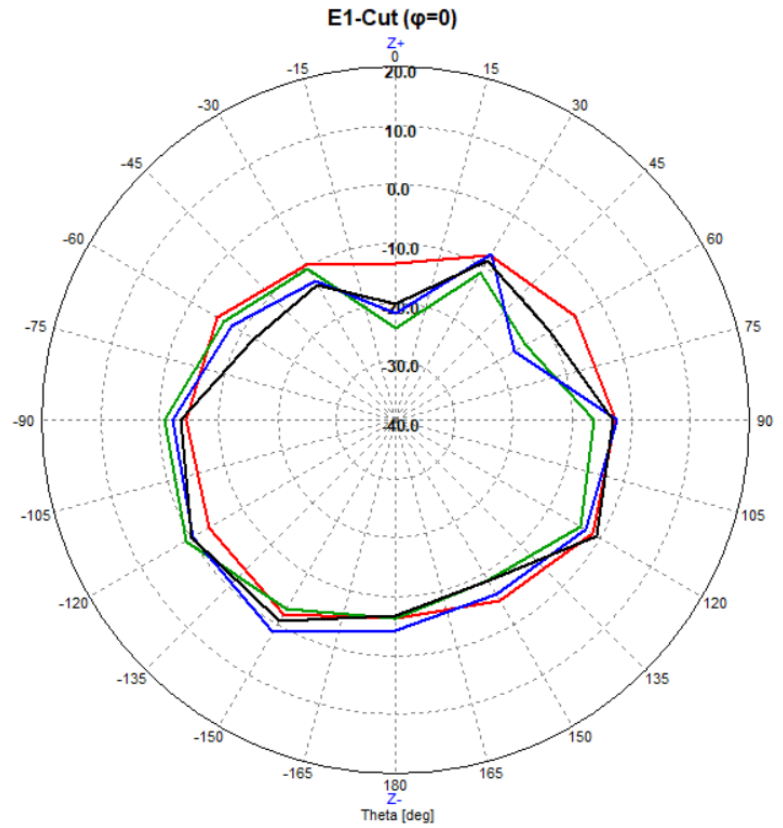

	PEAK [dBi]	AVERAGE [dBi]
1575 MHz	-2.58	-4.35
2400 MHz	-2.78	-4.70
2450 MHz	-2.65	-4.52
2500 MHz	-2.58	-4.32

<Vertical>

No.	Freq.	Gain [dBi]
1	1575.000	
2	2400.000	
3	2450.000	
4	2500.000	

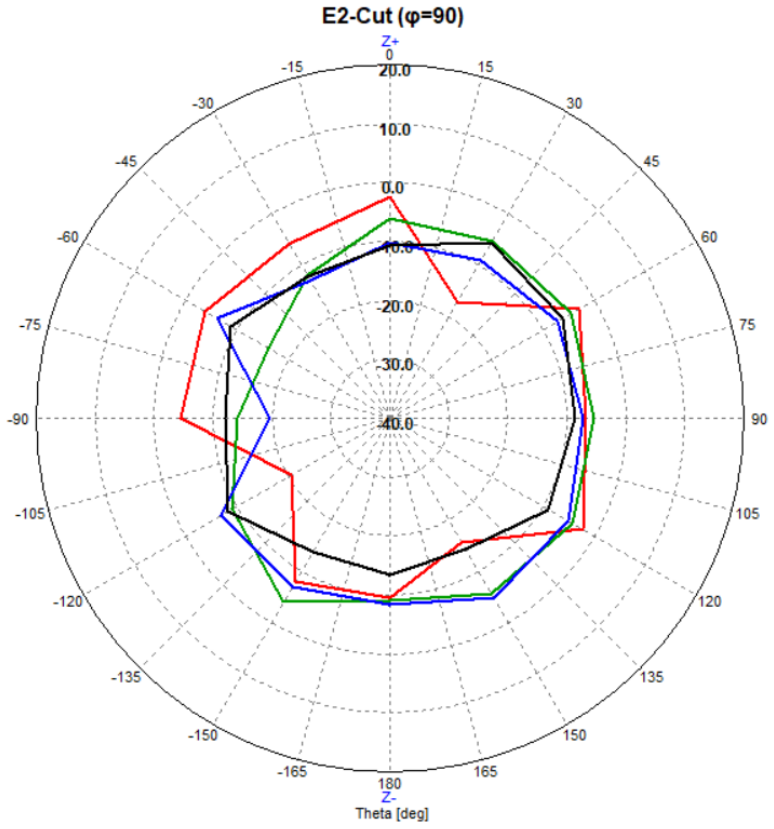

	PEAK [dBi]	AVERAGE [dBi]
1575 MHz	-2.64	-4.80
2400 MHz	-2.62	-3.87
2450 MHz	-2.58	-3.52
2500 MHz	-2.54	-3.57

<H-cut>

No.	Freq.	Gain [dBi]
1	1575.000	
2	2400.000	
3	2450.000	
4	2500.000	

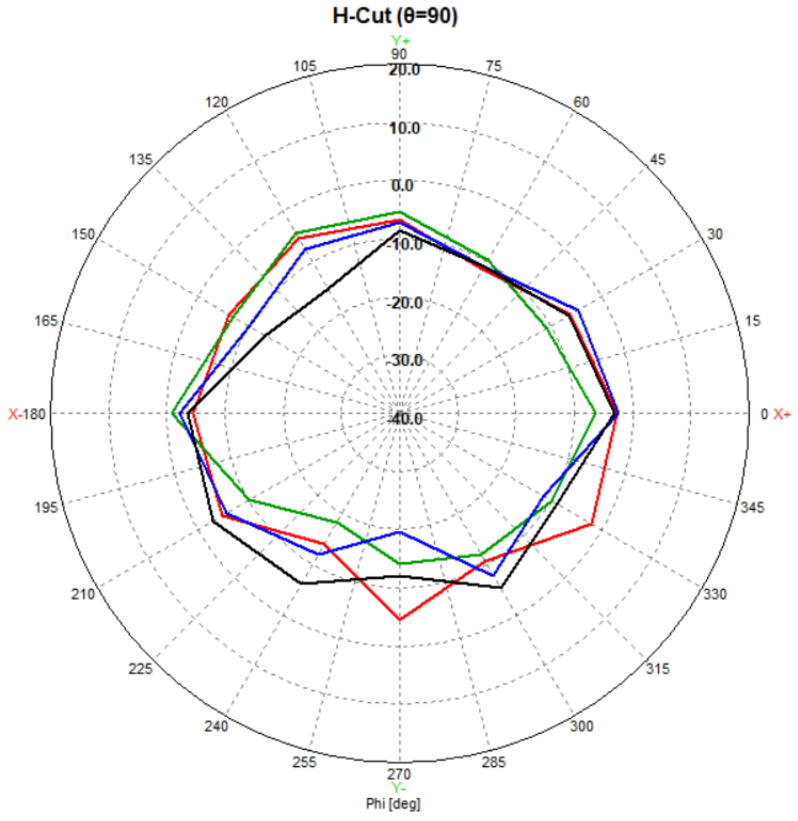

	PEAK [dBi]	AVERAGE [dBi]
1575 MHz	-2.99	-3.45
2400 MHz	-3.24	-4.80
2450 MHz	-3.22	-4.42
2500 MHz	-3.47	-4.54

5150MHz~5850MHz
<Horizontal>

No.	Freq.	Gain [dBi]
5	5150.000	
6	5250.000	
7	5350.000	
8	5470.000	
9	5600.000	
10	5725.000	
11	5785.000	
12	5850.000	

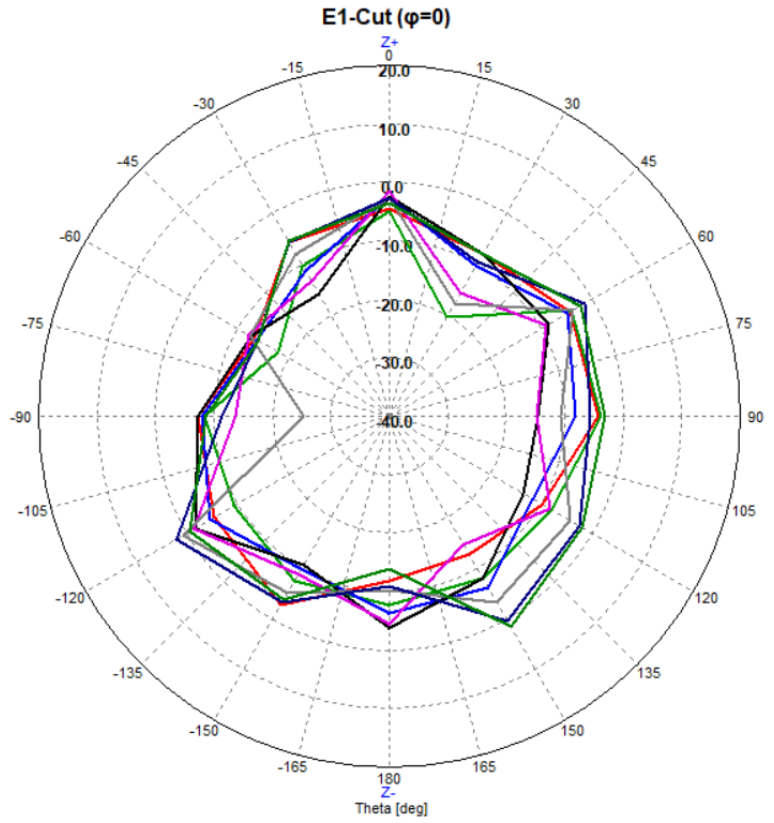

	PEAK [dBi]	AVERAGE [dBi]
5150 MHz	-7.03	-8.16
5250 MHz	-6.83	-7.95
5350 MHz	-6.63	-7.39
5470 MHz	-6.53	-7.55
5600 MHz	-6.43	-7.30
5725 MHz	-6.12	-7.38
5785 MHz	-6.22	-7.33
5850 MHz	-6.33	-7.16

<Vertical>

No.	Freq.	Gain [dBi]
5	5150.000	
6	5250.000	
7	5350.000	
8	5470.000	
9	5600.000	
10	5725.000	
11	5785.000	
12	5850.000	

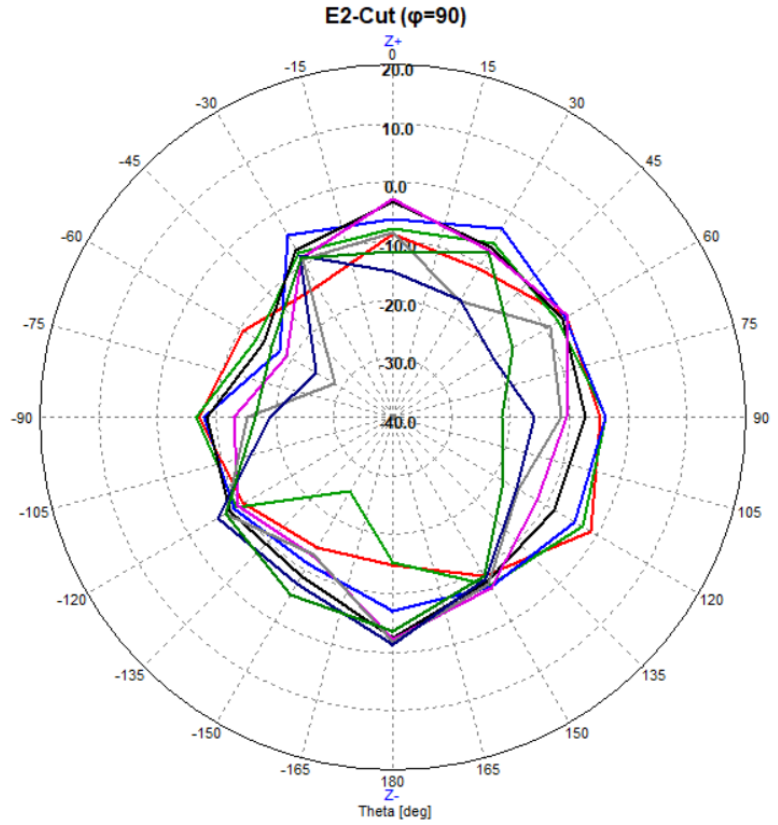

	PEAK [dBi]	AVERAGE [dBi]
5150 MHz	-7.13	-8.04
5250 MHz	-6.63	-7.56
5350 MHz	-6.68	-7.05
5470 MHz	-6.57	-7.62
5600 MHz	-6.66	-7.56
5725 MHz	-6.45	-7.60
5785 MHz	-6.37	-7.12
5850 MHz	-6.43	-7.36

<H-cut>

No.	Freq.	Gain [dBi]
5	5150.000	
6	5250.000	
7	5350.000	
8	5470.000	
9	5600.000	
10	5725.000	
11	5785.000	
12	5850.000	

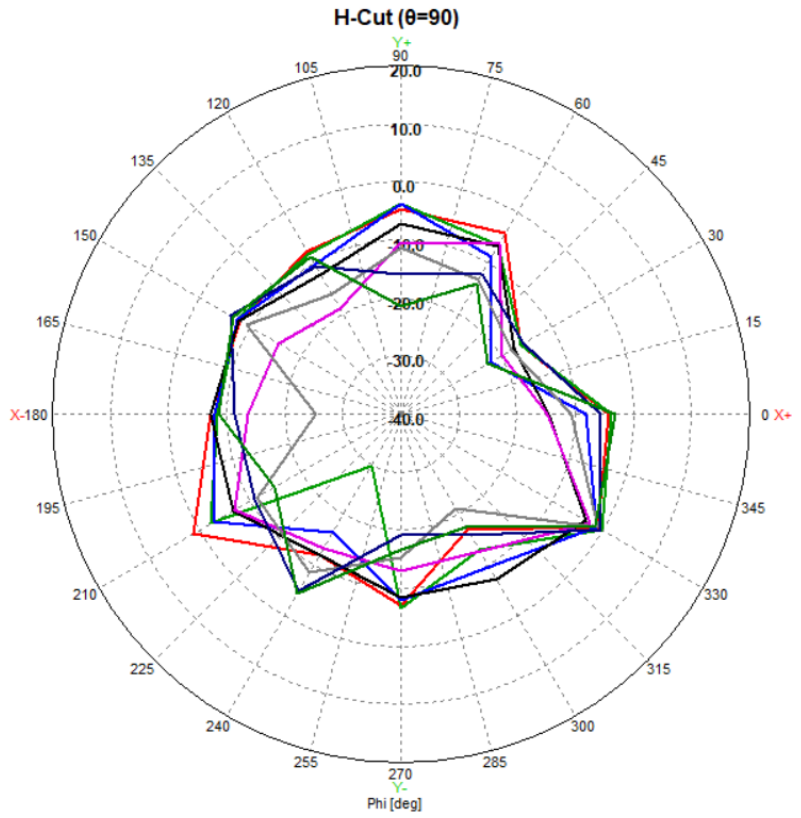

	PEAK [dBi]	AVERAGE [dBi]
5150 MHz	-6.63	-7.43
5250 MHz	-6.56	-7.28
5350 MHz	-6.45	-7.63
5470 MHz	-6.55	-7.55
5600 MHz	-6.37	-7.33
5725 MHz	-6.21	-7.55
5785 MHz	-6.31	-7.12
5850 MHz	-6.44	-7.40

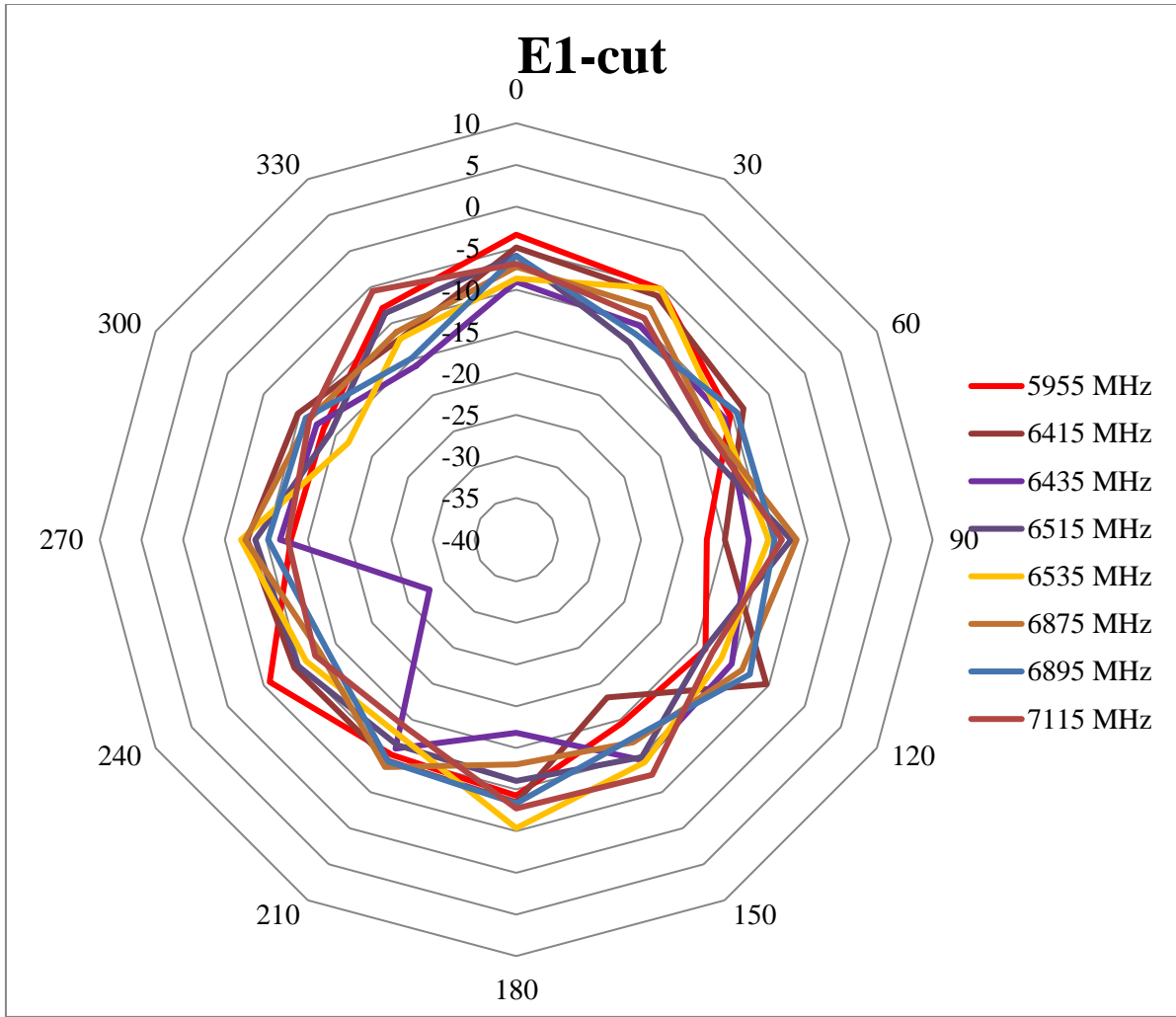

	PEAK [dBi]	AVERAGE [dBi]
5955 MHz	-7.39	-7.84
6415 MHz	-6.92	-7.95
6435 MHz	-9.03	-11.37
6515 MHz	-7.90	-9.36
6535 MHz	-6.20	-8.95
6875 MHz	-7.33	-9.11
6895 MHz	-7.92	-9.17
7115 MHz	-7.54	-8.99

<Vertical>

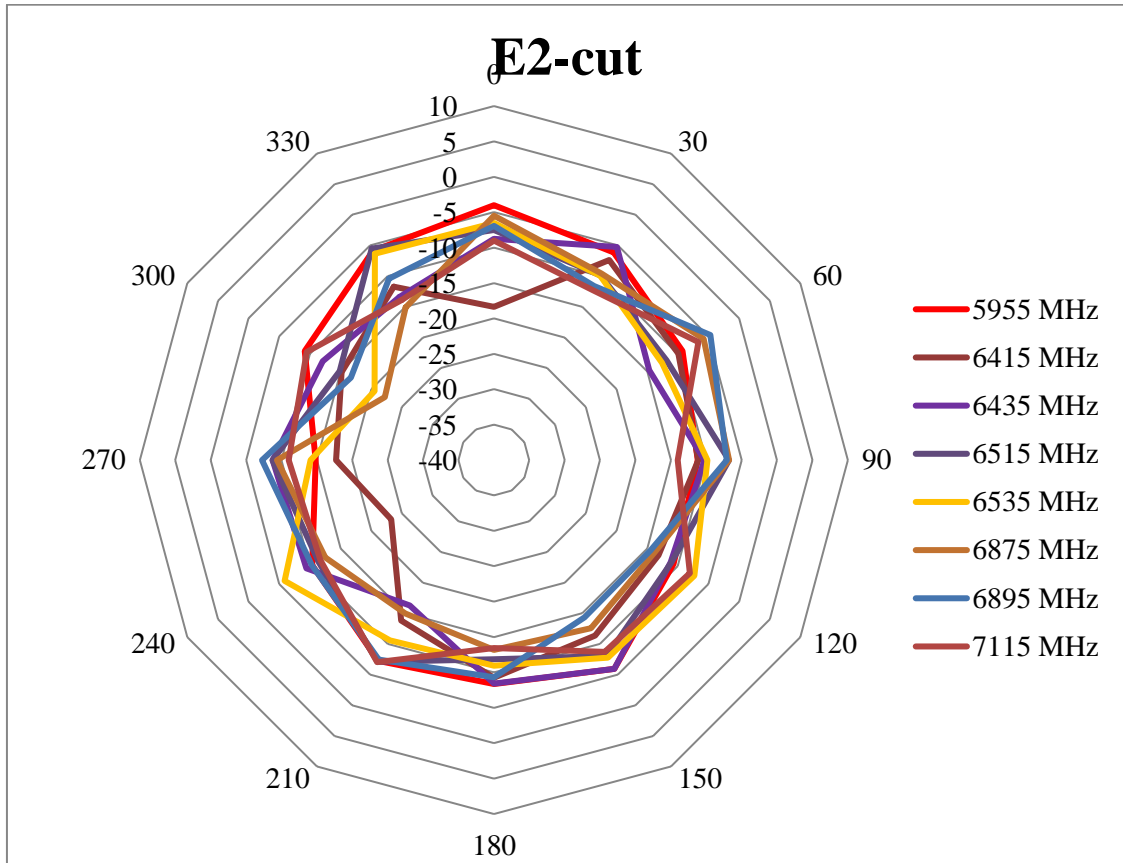

	PEAK [dBi]	AVERAGE [dBi]
5955 MHz	-6.01	-7.31
6415 MHz	-9.38	-12.15
6435 MHz	-7.26	-9.25
6515 MHz	-6.49	-8.71
6535 MHz	-6.87	-8.67
6875 MHz	-7.49	-9.28
6895 MHz	-6.70	-8.66
7115 MHz	-7.64	-9.67

<H-cut>

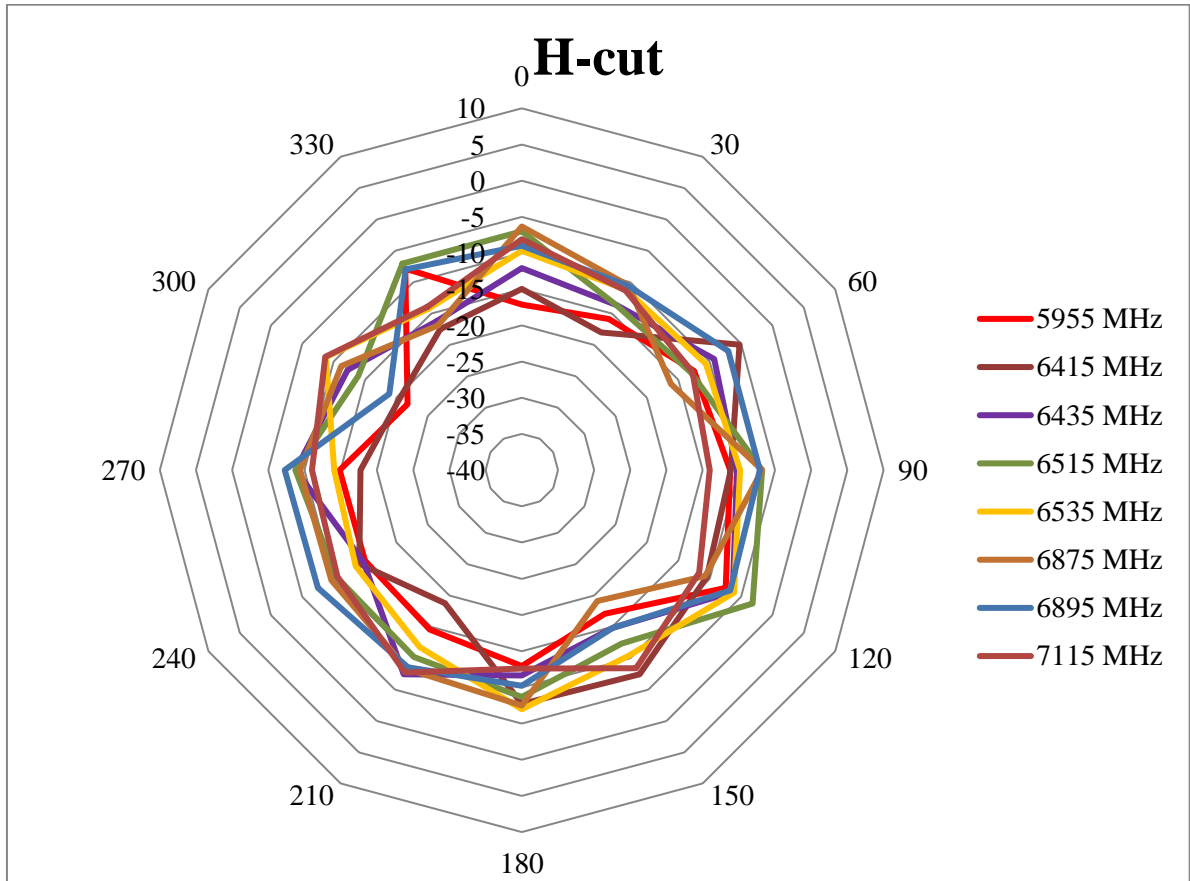

	PEAK [dBi]	AVERAGE [dBi]
5955 MHz	-9.45	-12.58
6415 MHz	-9.26	-11.18
6435 MHz	-9.32	-10.55
6515 MHz	-8.18	-8.28
6535 MHz	-8.14	-9.87
6875 MHz	-8.33	-9.29
6895 MHz	-7.76	-8.71
7115 MHz	-8.72	-10.15

WiFi1

2400MHz~2500MHz

<Horizontal>

No.	Freq.	Gain [dBi]
1	2400.000	
2	2450.000	
3	2500.000	

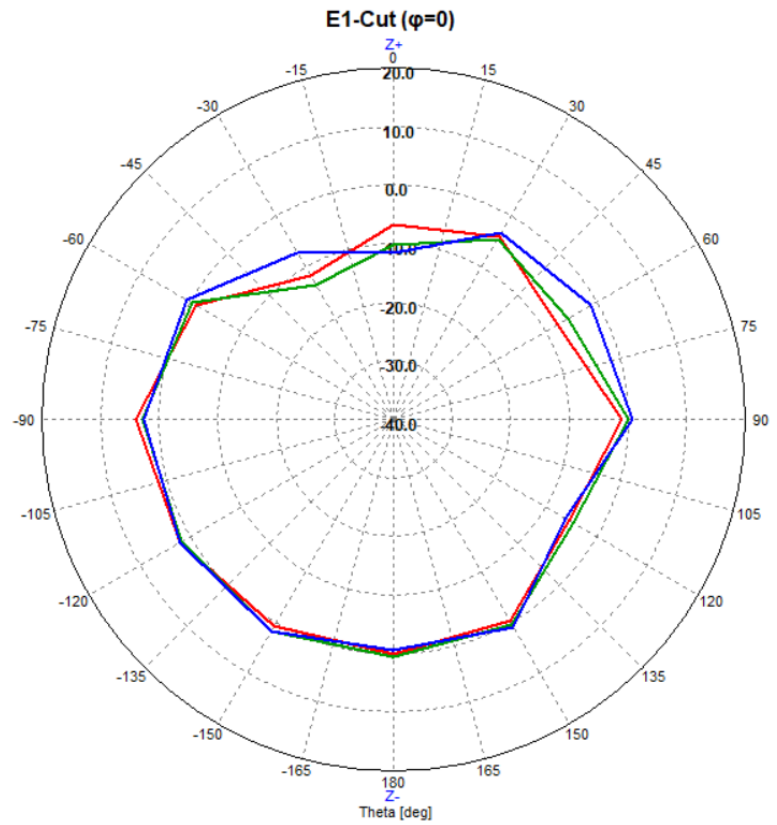

	PEAK [dBi]	AVERAGE [dBi]
2400 MHz	-3.05	-4.72
2450 MHz	-3.15	-4.79
2500 MHz	-2.96	-4.35

<Vertical>

No.	Freq.	Gain [dBi]
1	2400.000	
2	2450.000	
3	2500.000	

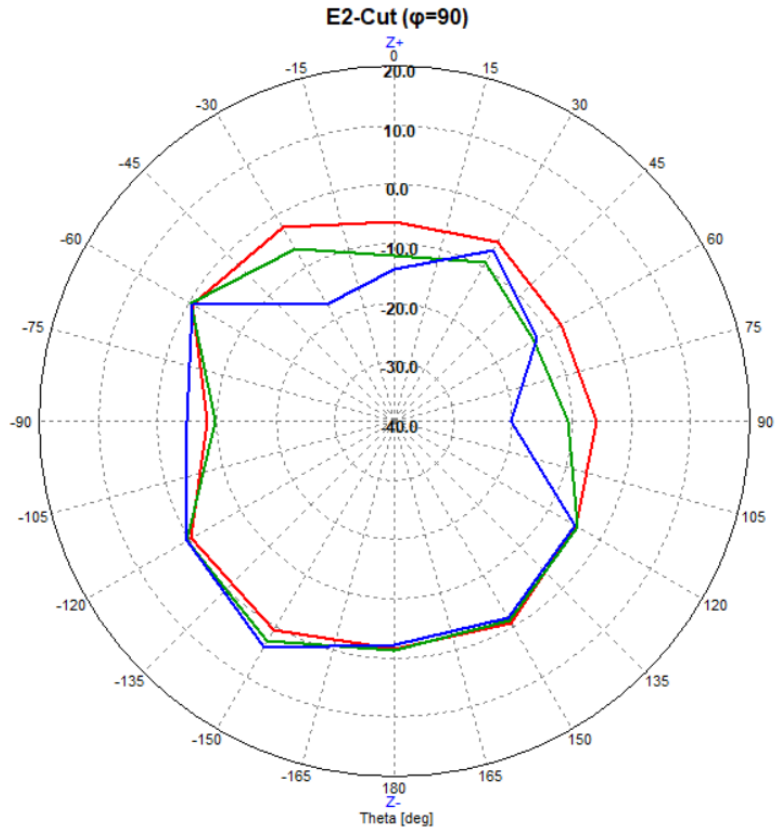

	PEAK [dBi]	AVERAGE [dBi]
2400 MHz	-2.85	-3.56
2450 MHz	-2.93	-3.65
2500 MHz	-2.63	-3.47

<H-cut>

No.	Freq.	Gain [dBi]
1	2400.000	
2	2450.000	
3	2500.000	

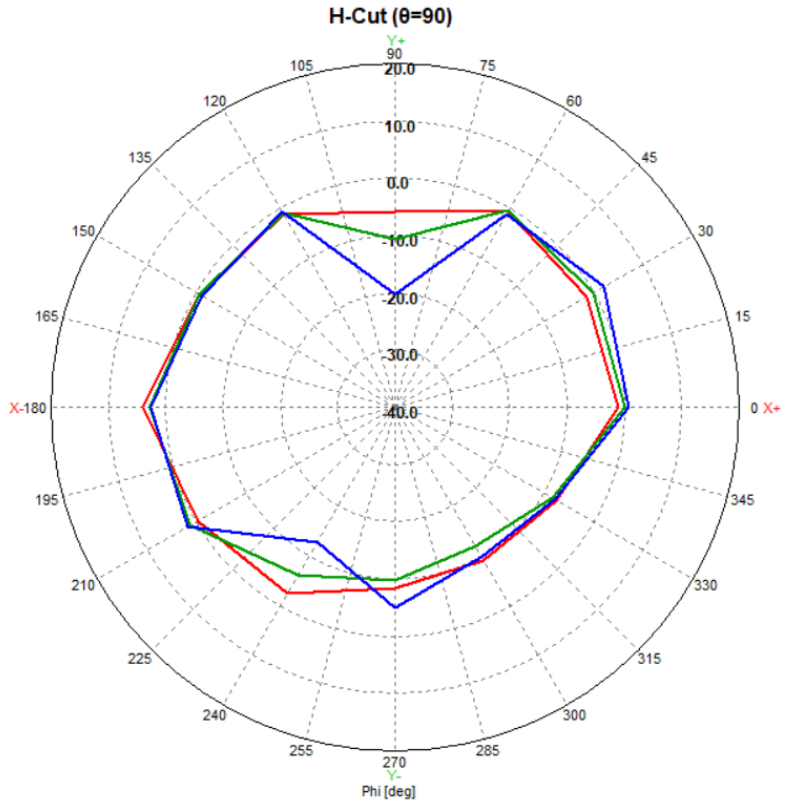

	PEAK [dBi]	AVERAGE [dBi]
2400 MHz	-2.77	-3.39
2450 MHz	-2.56	-3.46
2500 MHz	-2.87	-3.72

5150MHz~5850MHz
<Horizontal>

No.	Freq.	Gain [dBi]
4	5150.000	
5	5250.000	
6	5350.000	
7	5470.000	
8	5600.000	
9	5725.000	
10	5785.000	
11	5850.000	

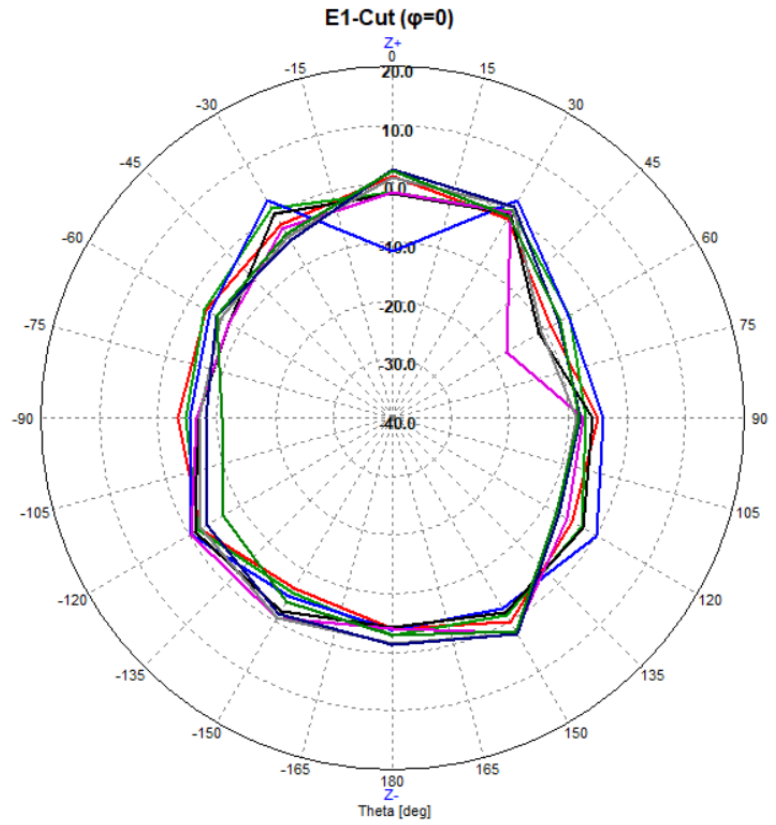

	PEAK [dBi]	AVERAGE [dBi]
5150 MHz	-6.12	-7.46
5250 MHz	-6.08	-7.12
5350 MHz	-6.20	-7.47
5470 MHz	-6.30	-7.65
5600 MHz	-6.31	-7.26
5725 MHz	-6.58	-7.67
5785 MHz	-6.60	-7.66
5850 MHz	-6.18	-7.58

<Vertical>

No.	Freq.	Gain [dBi]
4	5150.000	
5	5250.000	
6	5350.000	
7	5470.000	
8	5600.000	
9	5725.000	
10	5785.000	
11	5850.000	

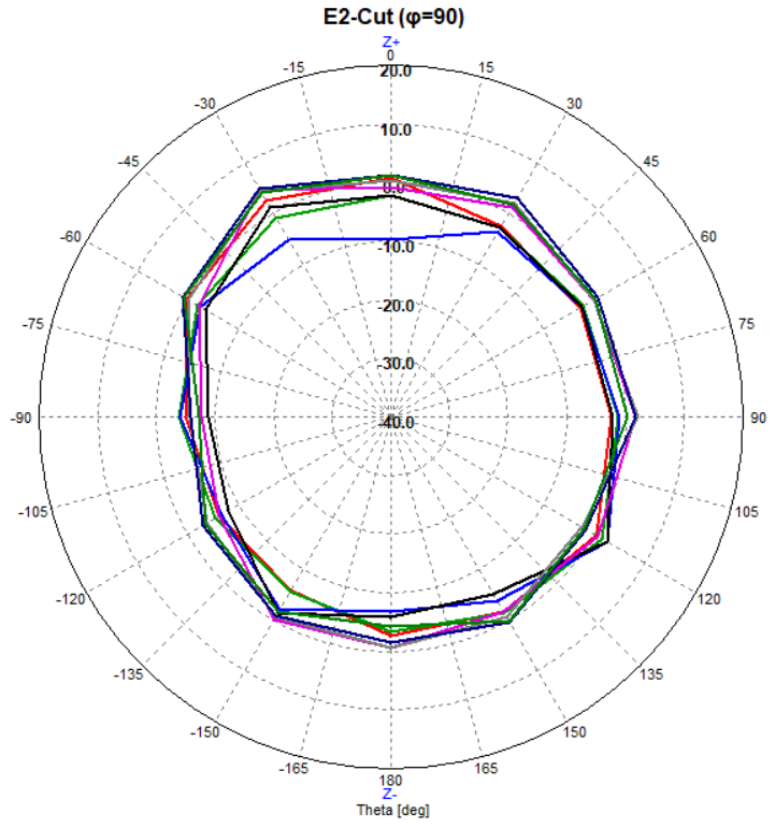

	PEAK [dBi]	AVERAGE [dBi]
5150 MHz	-6.31	-7.30
5250 MHz	-6.24	-7.27
5350 MHz	-6.29	-6.71
5470 MHz	-6.49	-7.06
5600 MHz	-6.37	-7.09
5725 MHz	-6.26	-7.37
5785 MHz	-6.13	-7.42
5850 MHz	-6.18	-7.02

<H-cut>

Io.	Freq.	Gain [dBi]
4	5150.000	
5	5250.000	
6	5350.000	
7	5470.000	
8	5600.000	
9	5725.000	
10	5785.000	
11	5850.000	

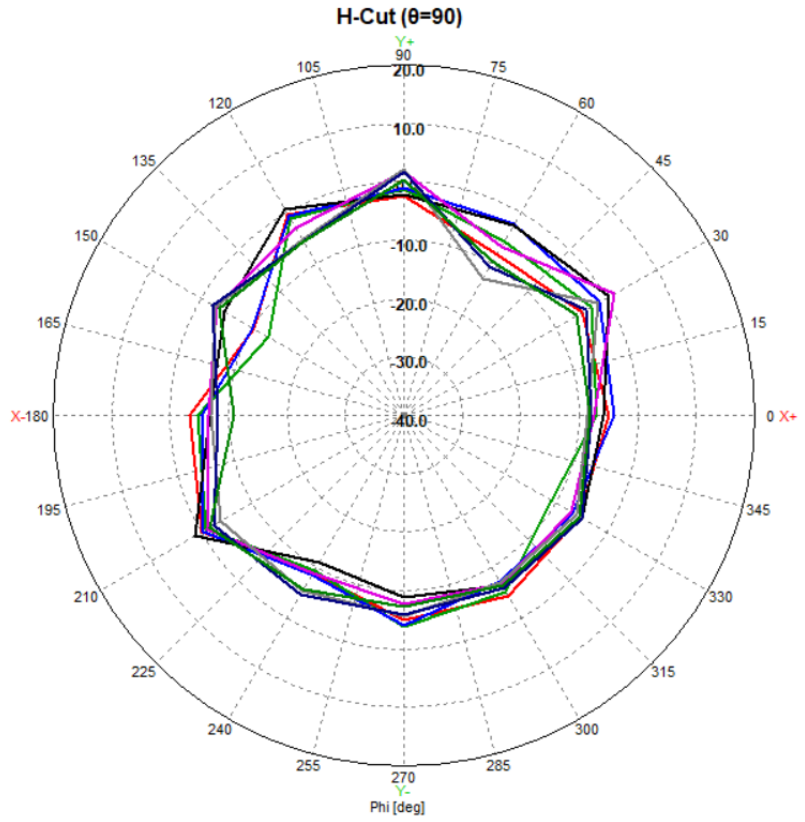

	PEAK [dBi]	AVERAGE [dBi]
5150 MHz	-6.22	-7.24
5250 MHz	-6.15	-7.33
5350 MHz	-6.37	-7.26
5470 MHz	-6.28	-7.30
5600 MHz	-6.51	-7.32
5725 MHz	-6.67	-7.25
5785 MHz	-6.27	-7.32
5850 MHz	-6.23	-7.38

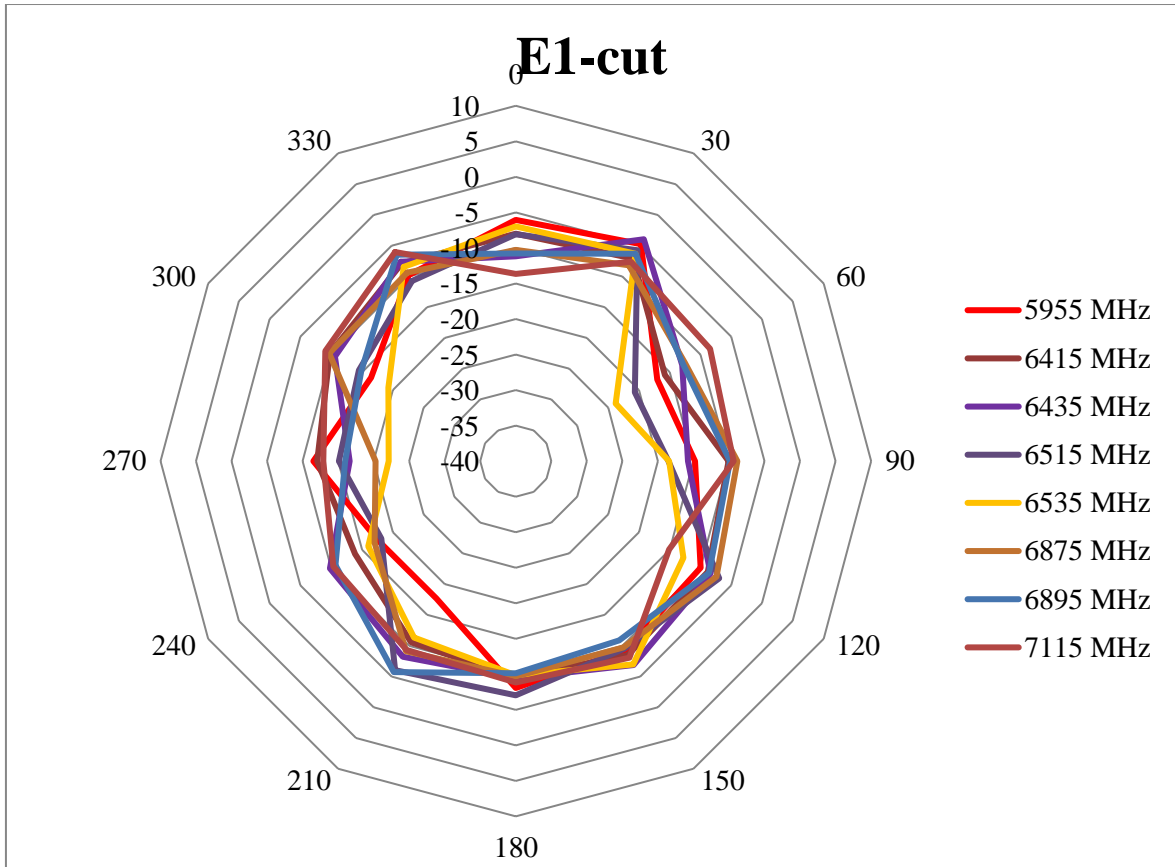

	PEAK [dBi]	AVERAGE [dBi]
5955 MHz	-7.75	-9.40
6415 MHz	-7.08	-9.43
6435 MHz	-7.96	-9.00
6515 MHz	-7.75	-9.30
6535 MHz	-8.30	-10.09
6875 MHz	-8.41	-10.01
6895 MHz	-7.70	-9.34
7115 MHz	-7.03	-9.46

<Vertical>

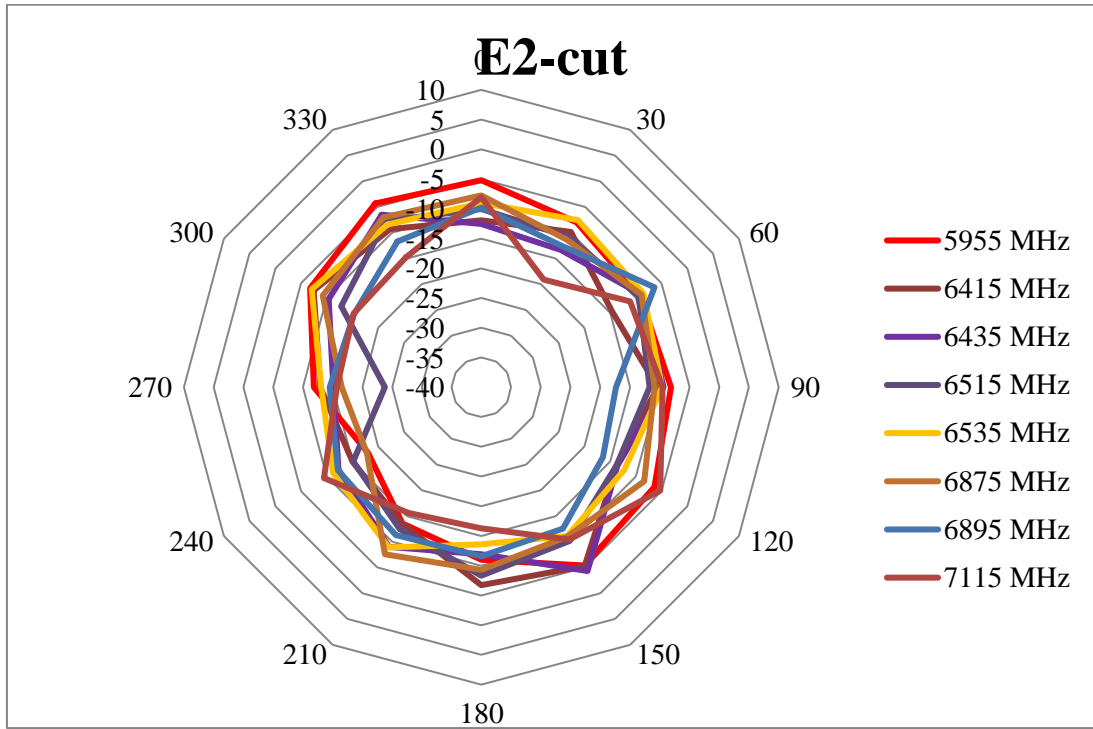

	PEAK [dBi]	AVERAGE [dBi]
5955 MHz	-6.35	-7.44
6415 MHz	-7.29	-9.89
6435 MHz	-7.33	-9.64
6515 MHz	-7.74	-10.89
6535 MHz	-7.06	-9.52
6875 MHz	-7.05	-9.39
6895 MHz	-7.38	-11.46
7115 MHz	-7.26	-10.50

<H-cut>

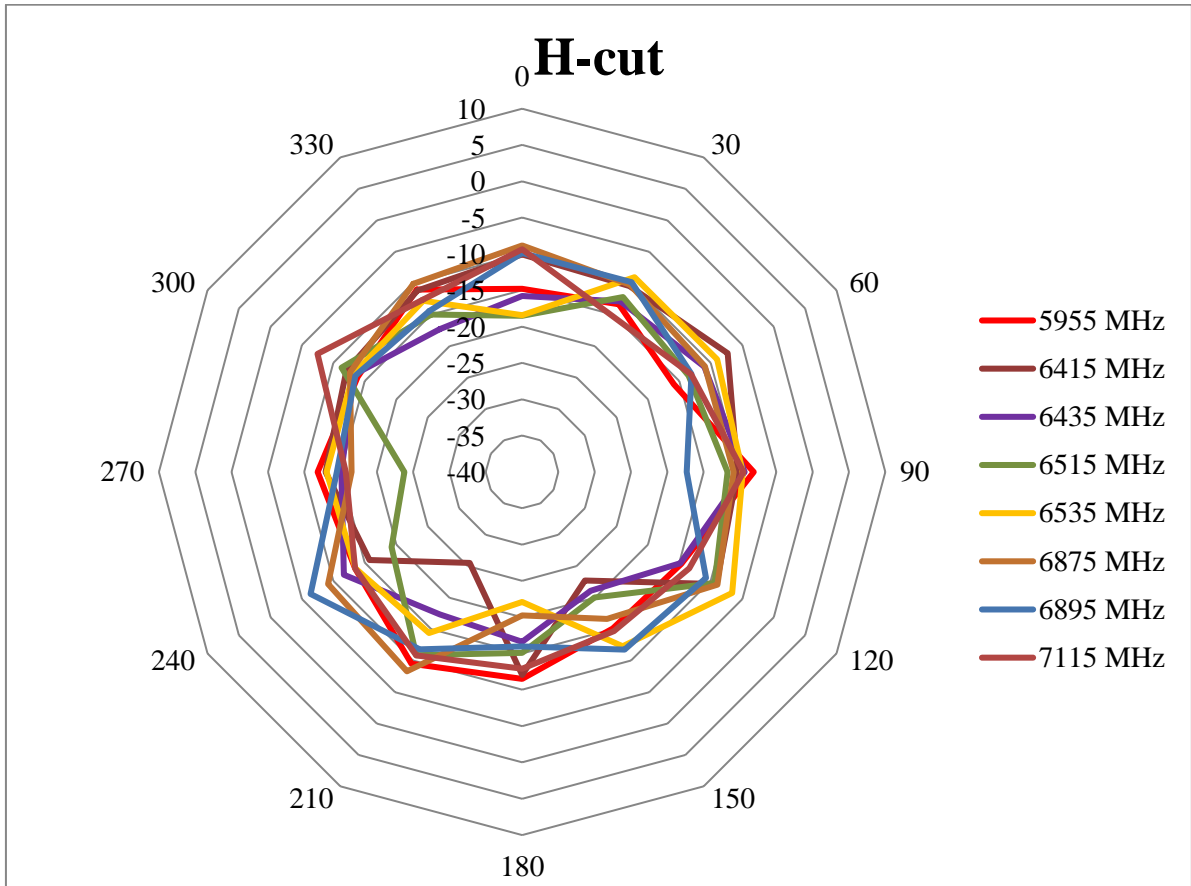

	PEAK [dBi]	AVERAGE [dBi]
5955 MHz	-8.11	-12.27
6415 MHz	-7.34	-11.26
6435 MHz	-9.37	-13.78
6515 MHz	-9.40	-13.66
6535 MHz	-6.63	-11.59
6875 MHz	-8.30	-10.64
6895 MHz	-7.37	-11.29
7115 MHz	-7.47	-11.41