

**SAMSUNG**

# USER MANUAL

---









MX-T40

# SAFETY INFORMATION

## SAFETY WARNINGS

TO REDUCE THE RISK OF ELECTRIC SHOCK, DO NOT REMOVE THE COVER (OR BACK). NO USER-SERVICEABLE PARTS ARE INSIDE. REFER SERVICING TO QUALIFIED SERVICE PERSONNEL.

Refer to the table below for an explanation of symbols which may be on your Samsung product.

	<div style="text-align: center; background-color: black; color: white; padding: 2px;"><b>CAUTION</b></div> <div style="text-align: center; border: 1px solid black; padding: 2px;"><b>RISK OF ELECTRIC SHOCK. DO NOT OPEN.</b></div>	
	<p>This symbol indicates that high voltage is present inside. It is dangerous to make any kind of contact with any internal part of this product.</p>	
	<p>This symbol indicates that this product comes with important literature concerning operation and maintenance.</p>	
	<p>Class II product : This symbol indicates that a safety connection to electrical earth (ground) is not required. If this symbol is not present on a product with a power cord, the product MUST have a reliable connection to protective earth (ground).</p>	
	<p>AC voltage : Rated voltage marked with this symbol is AC voltage.</p>	
	<p>DC voltage : Rated voltage marked with this symbol is DC voltage.</p>	
	<p>Caution. Consult Instructions for use : This symbol instructs the user to consult the user manual for further safety related information.</p>	

## WARNING

- To reduce the risk of fire or electric shock, do not expose this appliance to rain or moisture.
- This product contains chemicals known to the State of California to cause cancer and birth defects or other reproductive harm.

## CAUTION

- Do not expose this apparatus to dripping or splashing. Do not put objects filled with liquids, such as vases, on the apparatus.
- To turn this apparatus off completely, you must pull the power plug out of the wall socket. Consequently, the power plug must be easily and readily accessible at all times.

## FCC NOTE (for U.S.A):

### FCC Supplier's Declaration of Conformity

#### Responsible Party - U.S. Contact Information:

Samsung Electronics America, Inc.  
85 Challenger Road.  
Ridgefield Park, NJ 07660  
Phone: 1-800-SAMSUNG (726-7864)

#### FCC Compliance Statement :

This device complies with Part 15 of the FCC Rules. Operation is subject to the following two conditions:  
(1) This device may not cause harmful interference, and (2) this device must accept any interference received, including interference that may cause undesired operation.

### **FCC Caution :**

- Any changes or modifications not expressly approved by the party responsible for compliance could void the user's authority to operate this equipment.
- This product satisfies FCC regulations when shielded cables and connectors are used to connect the unit to other equipment. To prevent electromagnetic interference with electric appliances, such as radios and televisions, use shielded cables and connectors for connections.

### **Class B FCC Statement**

This equipment has been tested and found to comply with the limits for a Class B digital device, pursuant to Part 15 of the FCC Rules. These limits are designed to provide reasonable protection against harmful interference in a residential installation. This equipment generates, uses and can radiate radio frequency energy and, if not installed and used in accordance with the instructions, may cause harmful interference to radio communications. However, there is no guarantee that interference will not occur in a particular installation. If this equipment does cause harmful interference to radio or television reception, which can be determined by turning the equipment off and on, the user is encouraged to try to correct the interference by one of the following measures:

- Reorienting or relocating the receiving antenna.
- Increasing the separation between the equipment and receiver.
- Connecting the equipment to an outlet that is on a different circuit than the radio or TV.
- Consulting the dealer or an experienced radio/TV technician for help.

### **FCC Radiation Exposure Statement :**

This equipment complies with FCC radiation exposure limits set forth for an uncontrolled environment. This equipment should be installed and operated so there is at least 8 inches (20 cm) between the radiator and your body. This device and its antenna(s) must not be co-located or operated in conjunction with any other antenna or transmitter.

### **CALIFORNIA USA ONLY (Applicable for networking models only)**

This Perchlorate warning applies only to primary CR(Manganese Dioxide) Lithium coin cells in the product sold or distributed ONLY in California USA "Perchlorate Material - special handling may apply, See [www.dtsc.ca.gov/hazardouswaste/perchlorate](http://www.dtsc.ca.gov/hazardouswaste/perchlorate)."

Dispose unwanted electronics through an approved recycler. To find the nearest recycling location, go to our website:[www.samsung.com/recycling](http://www.samsung.com/recycling) Or call, 1-800-SAMSUNG

 **WARNING: Cancer and Reproductive Harm**  
- [www.P65Warnings.ca.gov](http://www.P65Warnings.ca.gov).

### **Important Safety Instructions**

Read these operating instructions carefully before using the unit. Follow all the safety instructions listed below. Keep these operating instructions handy for future reference.

1. Read these instructions.
2. Keep these Instructions.
3. Heed all warnings.
4. Follow all instructions.
5. Do not use this apparatus near water.
6. Clean only with dry cloth.
7. Do not block any ventilation openings.  
Install in accordance with the manufacturer's instructions.

8. Do not install near any heat sources such as radiators, heat registers, stoves, or other apparatus (including amplifiers) that produce heat.
9. Do not defeat the safety purpose of the polarized or grounding-type plug. A polarized plug has two blades with one wider than the other. A grounding type plug has two blades and a third grounding prong. The wide blade or the third prong are provided for your safety. If the provided plug does not fit into your outlet, consult an electrician for replacement of the obsolete outlet.
10. Protect the power cord from being walked on or pinched particularly at plugs, convenience receptacles, and the point where they exit from the apparatus.
11. Only use attachments/accessories specified by the manufacturer.
12. Use only with the cart, stand, tripod, bracket, or table specified by the manufacturer, or sold with the apparatus. 

When a cart is used, use caution when moving the cart/apparatus combination to avoid injury from tip-over.
13. Unplug this apparatus during lightning storms or when unused for long periods of time.
14. Refer all servicing to qualified service personnel. Servicing is required when the apparatus has been damaged in any way, such as power-supply cord or plug is damaged, liquid has been spilled or objects have fallen into the apparatus, the apparatus has been exposed to rain or moisture, does not operate normally, or has been dropped.

## PRECAUTIONS

1. Ensure that the AC power supply in your house complies with the power requirements listed on the identification sticker located on the rear of your product. Install your product horizontally, on a suitable base (furniture), with enough space around it for ventilation (3~4 inches). Make sure the ventilation slots are not covered. Do not place the unit on amplifiers or other equipment which may become hot. This unit is designed for continuous use. To fully turn off the unit, disconnect the AC plug from the wall outlet. Unplug the unit if you intend to leave it unused for a long period of time.
2. During thunderstorms, disconnect the AC plug from the wall outlet. Voltage peaks due to lightning could damage the unit.
3. Do not expose the unit to direct sunlight or other heat sources. This could lead to overheating and cause the unit to malfunction.
4. Protect the product from moisture (i.e. vases), and excess heat (e.g. a fireplace) or equipment creating strong magnetic or electric fields. Unplug the power cable from the AC wall socket if the unit malfunctions. Your product is not intended for industrial use. It is for personal use only. Condensation may occur if your product has been stored in cold temperatures. If transporting the unit during the winter, wait approximately 2 hours until the unit has reached room temperature before using.
5. The battery used with this product contains chemicals that are harmful to the environment. Do not dispose of the battery in the general household trash. Do not expose the battery to excess heat, direct sunlight, or fire. Do not short circuit, disassemble, or overheat the battery. Danger of explosion if the battery is replaced incorrectly. Replace only with the same or equivalent type.

# ABOUT THIS MANUAL

The user manual has two parts: this simple paper USER MANUAL and a detailed FULL MANUAL you can download.



## **USER MANUAL**

See this manual for safety instructions, product installation, components, connections, and product specifications.



## **FULL MANUAL**

You can access the FULL MANUAL on Samsung's on-line customer support center by scanning the QR code on the left. To see the manual on your PC or mobile device, download the manual in document format from Samsung's website. (<https://www.samsung.com/us/support/downloads/>)

Design and specifications are subject to change without prior notice.

# CONTENTS

<b>01</b>	<b>Checking the Components</b>	<b>2</b>
	Inserting Batteries before using the Remote Control (AAA batteries X 2)	2
<b>02</b>	<b>Product Overview</b>	<b>3</b>
	Top Panel of the Party Audio	3
	Rear Panel of the Party Audio	4
<b>03</b>	<b>Connecting the Party Audio</b>	<b>5</b>
	Connecting Electrical Power	5
	How to use Audio Group	6
<b>04</b>	<b>Connecting an External Device</b>	<b>11</b>
	Connecting using an Analog Audio (AUX) Cable	11
	Connecting a mobile device via Bluetooth	12
<b>05</b>	<b>Connecting a USB Storage Device</b>	<b>15</b>
	Software Update	15
<b>06</b>	<b>Using the Remote Control</b>	<b>16</b>
	How to Use the Remote Control	16

<b>07</b>	<b>Troubleshooting</b>	<b>18</b>
<b>08</b>	<b>License</b>	<b>19</b>
<b>09</b>	<b>Open Source License Notice</b>	<b>19</b>
<b>10</b>	<b>Important Notes About Service</b>	<b>19</b>
<b>11</b>	<b>Specifications and Guide</b>	<b>20</b>
	Specifications	20

# 01 CHECKING THE COMPONENTS



Party Audio Main Unit

Remote Control (AH81-11472A) /  
Batteries

Power Cord  
(AH81-11474A)

- For more information about the power supply and power consumption, refer to the label attached to the product. (Label: Rear of the Party Audio Main Unit)
- To purchase additional components or optional cables, contact a Samsung Service Center or Samsung Customer Care.
- When moving the product, do not drag or pull the product from the ground. Lift the product when moving the product.

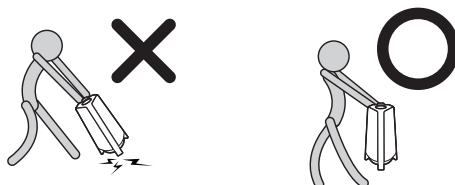

## Inserting Batteries before using the Remote Control (AAA batteries X 2)

Slide the battery cover in the direction of the arrow until it is completely removed. Insert 2 AAA batteries (1.5V) oriented so that their polarity is correct. Slide the battery cover back into position.

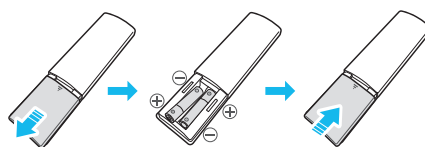





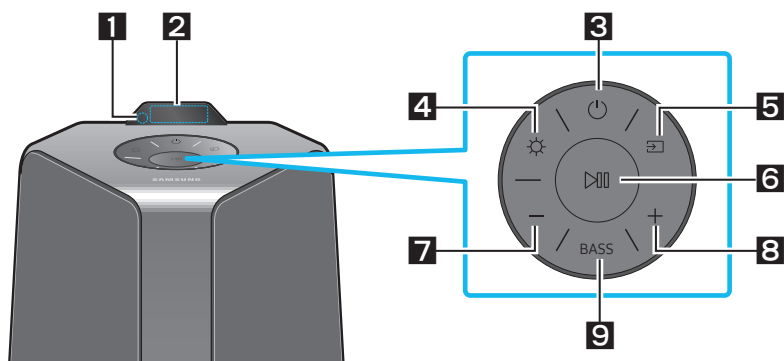

## 02 PRODUCT OVERVIEW

### Top Panel of the Party Audio



<b>1</b>	<b>Remote Sensor</b>	When operating the Party Audio system, please aim the front of the remote control at the remote sensor.
<b>2</b>	<b>Display Window</b>	Displays operating messages or current status of the Party Audio system.
<b>3</b>	<b>Power</b>	Turns the Party Audio on and off.
<b>4</b>	<b>Light</b>	Press the  ( <b>Light</b> ) button to turn the Lighting Mode on.
<b>5</b>	<b>Source</b>	Press to select a source connected to the Party Audio. Press and hold the  ( <b>Source</b> ) button for more than 5 seconds to enter the "BT PAIRING" mode.
<b>6</b>	<b>Play/Pause</b>	<ul style="list-style-type: none"> <li>• <b>Play/Pause</b> Press the  button to pause a music file temporarily. When you press the button again, the music file plays.</li> <li>• <b>Demo play</b> Press and hold the  button for more than 5 seconds to start the Demo play while the system is turned on. "DEMO" appears on the display and it plays demo music for 60 seconds.</li> </ul>
<b>7</b>	<b>Volume down</b>	Press the <b>— (Volume down)</b> button to lower the volume.
<b>8</b>	<b>Volume up</b>	Press the <b>+ (Volume up)</b> button to raise the volume.
<b>9</b>	<b>BASS</b>	Press the <b>BASS</b> button to use the powerful bass sound.

## Rear Panel of the Party Audio

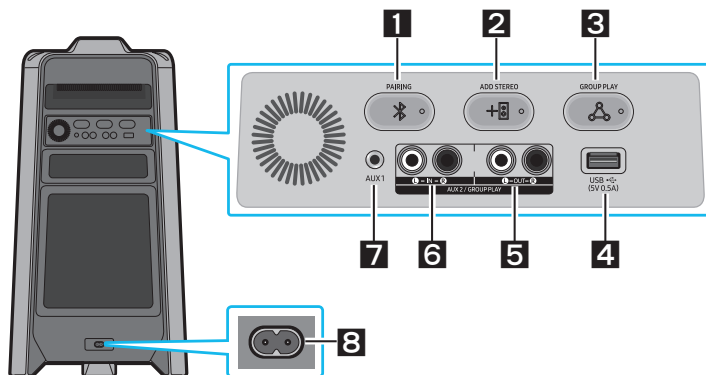

<b>1</b>	<b>Bluetooth PAIRING</b>	Press the <b>PAIRING</b> button to enter the "BT PAIRING" mode.
<b>2</b>	<b>ADD STEREO</b>	Press the <b>ADD STEREO</b> button to connect to another Party Audio wirelessly.
<b>3</b>	<b>GROUP PLAY</b>	Press the <b>GROUP PLAY</b> button to connect up to ten Party Audio systems wirelessly.
<b>4</b>	<b>USB</b>	Connect a USB device to the <b>USB</b> port on the main unit. <ul style="list-style-type: none"> <li>Press the <b>Source</b> button to select <b>USB</b>.</li> </ul>
<b>5</b>	<b>GROUP PLAY OUT Terminals</b>	Use an Audio Cable (not supplied) to connect <b>GROUP PLAY (OUT)</b> terminals on the main unit to Audio In on an external analog output device.
<b>6</b>	<b>AUX2/GROUP PLAY IN Terminals</b>	Use an Audio Cable (not supplied) to connect <b>AUX2 (IN)</b> terminals on the main unit to Audio Out on an external analog output device.
<b>7</b>	<b>AUX1</b>	Use an Audio (AUX) Cable (not supplied) to connect <b>AUX1</b> jack on the main unit to Audio Out on an external device.
<b>8</b>	<b>Power</b>	Connect the power cord to the <b>Power</b> jack and connect the other end of the power cord to a wall socket to supply electrical power to the Party Audio.

## 03 CONNECTING THE PARTY AUDIO

### Connecting Electrical Power

Use the power cord to connect the Party Audio to an electrical outlet in the following order:  
Connect the power cord to the Party Audio and then to a wall socket.

See the illustrations below.

- For more information about the required electrical power and power consumption, refer to the label attached to the product. (Label: Rear of the Party Audio)

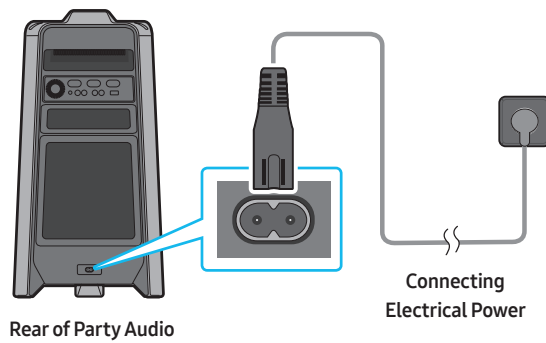

## How to use Audio Group

You can connect multiple audio systems in a group to create a party environment and produce higher sound output. Set one Party Audio as the host and any music played on it will be shared among any other Party Audio systems in the Audio group.

### Connecting the wired Group Play mode

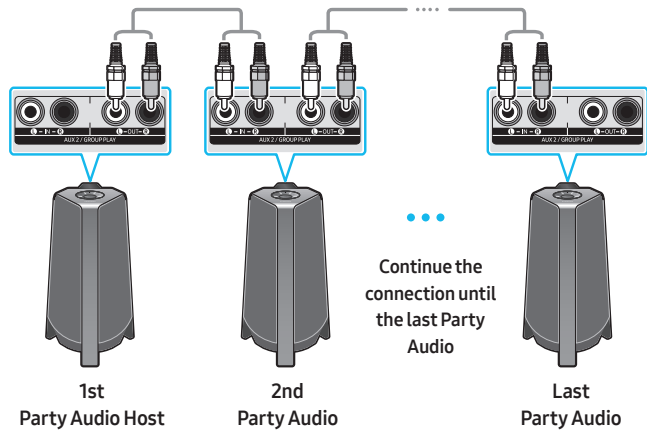

Set up Group Play by connecting all the systems using audio cables (not supplied). Use the **AUX** or **Source** button to change the source to **AUX2** for every Party Audio system except the 1st (or host) Party Audio system.

#### NOTES

- The 1st Party Audio Host can play music from any source.
- Depending on the length or characteristics of the cable, there may be a difference in operating distance.

## Connecting the wireless Group Play mode

You can connect up to ten Party Audio systems with the wireless Group Play function.

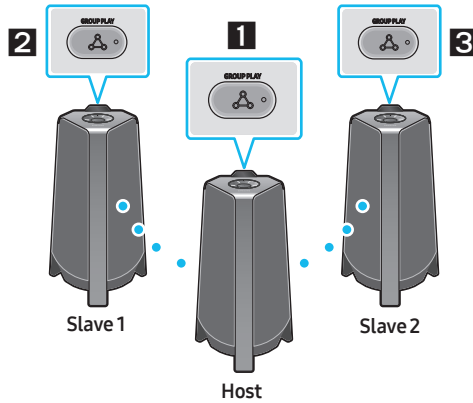

1. Press the **GROUP PLAY** button on the Host Party Audio system. The “**HOST**” message appears on the display of the host Party Audio and the LED blinks on the **GROUP PLAY** button.
2. Press the **GROUP PLAY** button on the 2nd Party Audio system (Slave 1). The “**GROUP PLAY CONNECTED**” message appears on the display and the **GROUP PLAY** button on both systems stops blinking.
3. Press the **GROUP PLAY** button on the 3rd Party Audio system (Slave 2). The “**GROUP PLAY CONNECTED**” message appears on the display and the **GROUP PLAY** button on the system stops blinking.
4. If you want to add more Party Audio systems, repeat step 3.
5. Play music on the Host Party Audio. Sound outputs from all the connected systems.

### NOTES

- The wireless Group Play connection is available for any Party Audio system.
- Environmental conditions or other factors with connected devices may have effect on playback quality.
- If the red LED is on the **GROUP PLAY** button, an error has occurred in the wireless Group Play connection. Try step 1 to step 5 again.
- The **ADD STEREO** button and **PAIRING** button on the slave Party Audio systems are not available while in wireless Group Play mode.
- The **ADD STEREO** button on the host Party Audio system is not available while in wireless Group Play mode.
- When adding a slave unit, if you press and hold **GROUP PLAY** on the slave, before the “**GROUP PLAY CONNECTED**” message appears, it will become the Host unit instead.

- All slave units must be connected one by one. For example, after Host is connected, press **GROUP PLAY** button on slave 1 to connect, and after slave 1 is connected, you should connect slave 2 and slave 3 one by one sequentially.
- While using Group Play, currently connected Bluetooth devices are disconnected and Bluetooth connection is disabled.
- Bluetooth devices can search and connect with the host Party Audio only.
- When in Group Play mode, the slaves cannot connect to a Bluetooth device.
- If you power off and then power on the Party Audio or select any source other than **BT** on a slave unit, in Group Play mode, the Group Play mode is disconnected.
- This product does not support aptX audio stream with Wireless Group Play mode.

### Disconnecting the wireless Group Play mode

1. Press and hold the **GROUP PLAY** button over 5 seconds (Host or Slaves) after Group Play is connected or press the **GROUP PLAY** button (Host or Slaves) before Group Play is connected.
  - “**OFF-GROUP PLAY**” appears on the display and the LED above the **GROUP PLAY** button is off.
2. If you select any source other than **BT** on the slave units or turn off the host Party Audio, the Group Play mode is disconnected.
  - If the disconnection is made from the host Party Audio, Group Play is disconnected.

### LED Indications

LED	STATE	Description
Green	Blink	Waiting for a wireless Group Play connection.
	Solid	The wireless Group Play connection was successful.
Red	Solid	There is an error with the wireless Group Play connection.

### NOTE

- In wireless connection, Playback quality can be unstable depending on Bluetooth environment. For better play, please keep the device in wired Group Play mode.

## Using the Stereo Group mode

You can enjoy stereo sound by connecting two Party Audio systems.

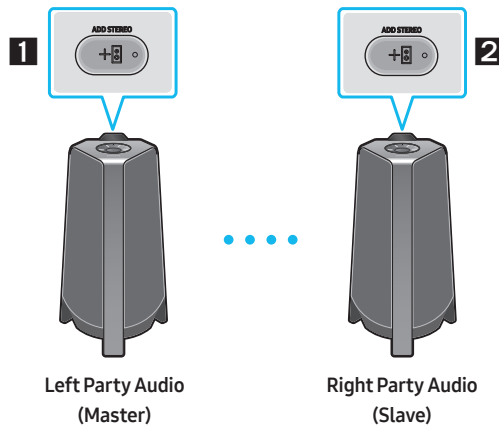

1. Press the **ADD STEREO** button on the left Party Audio system. The “**ADD STEREO**” message appears on the display and the LED blinks on the **ADD STEREO** button.
2. Press the **ADD STEREO** button on the right Party Audio system. The “**ADD STEREO**” message appears on the display and the LED blinks on the **ADD STEREO** button.
3. When the connection is made, The “**BT PAIRING**” message appears on the master Party Audio system and “**STEREO MODE**” appears on the slave Party Audio system.
  - The master Party Audio system outputs left channel sound and the slave Party Audio system outputs right channel sound. If you want to change the sound channels of Party Audio systems, press the **ADD STEREO** button on the current master Party Audio system.
4. Play music on the Party Audio. Sound outputs from both Party Audio systems.

### NOTES

- To use the Stereo Group mode, both Party Audio systems must be the same model.
- Environmental conditions or other factors with connected devices may have effect on playback quality.
- If the red LED is on the **ADD STEREO**, an error has occurred in the Stereo Group connection. Try step 1 and step 4 again.
- All the buttons except **ADD STEREO** button and **Power** on the slave Party Audio systems are disabled while in Stereo Group mode.
- The **GROUP PLAY** button on the host Party Audio system is not available while in Stereo Group mode.

- While in Stereo Group mode, currently connected Bluetooth devices are disconnected and Bluetooth connection is disabled.
- If you select any source other than **BT** or power cycle the master Party Audio, the Stereo Group mode is disconnected.
- This product does not support aptX audio stream with Wireless Group Play mode.
- If you try to connect a Bluetooth device while Stereo Group is connecting, the Stereo Group mode may fail.

### Disconnecting the Stereo Group mode

1. Press and hold the **ADD STEREO** button over 5 seconds (Master or Slave) after Stereo Group is connected or press the **ADD STEREO** button (Master or Slave) before Stereo Group is connected.
  - **"OFF-ADD STEREO"** appears on the display and the LED above the **ADD STEREO** button is off.
2. If you select any source other than **BT** on the slave units or the master Party Audio is turned off and then back on, the Stereo Group mode is disconnected.
  - If one of the Party Audio is disconnected from Stereo Group mode, another Party Audio is automatically disconnected.

### LED Indications

LED	STATE	Description
Green	Blink	Waiting for a Stereo Group connection.
	Solid	The Stereo Group connection is successful.
Red	Solid	There is an error with the Stereo Group connection.



## 04 CONNECTING AN EXTERNAL DEVICE

Connect to an external device via a wired or wireless network to play the external device's sound through the Party Audio.

### Connecting using an Analog Audio (AUX) Cable

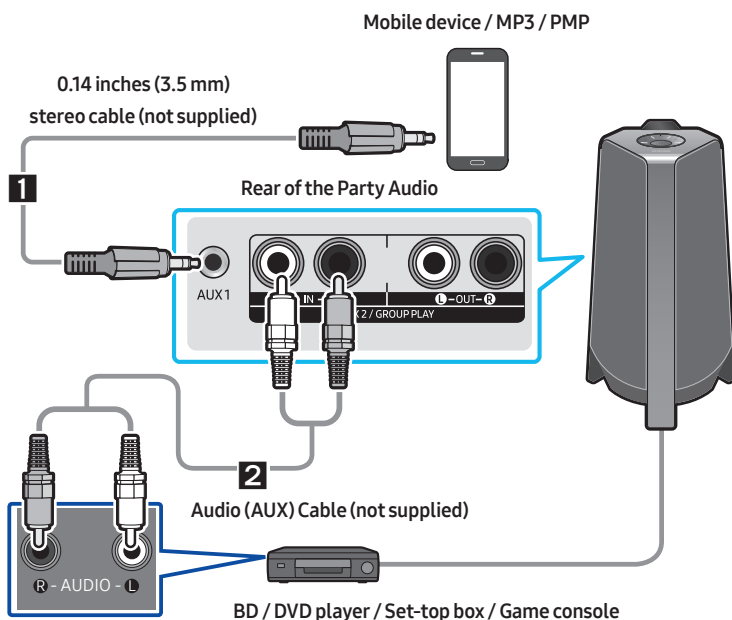

#### 1 0.14 inches (3.5 mm) stereo Cable (AUX1)

1. Connect **AUX1** jack on the main unit to the AUDIO OUT jack of the Source Device using an 0.14 inches (3.5 mm) stereo cable .
2. Select "**AUX1**" mode by pressing the  (**Source**) button on the top panel or on the remote control.
  - You can also select a source using **AUX** button on the remote control.

#### 2 Audio Cable (AUX2)

1. Connect **AUX2 (IN)** terminals on the main unit to the AUDIO OUT terminals of the Source Device using an audio cable .
2. Select "**AUX2**" mode by pressing the  (**Source**) button on the top panel or on the remote control.
  - You can also select a source using **AUX** button on the remote control.

## Connecting a mobile device via Bluetooth

When a mobile device is connected using Bluetooth, you can hear stereo sound without the hassle of cabling.

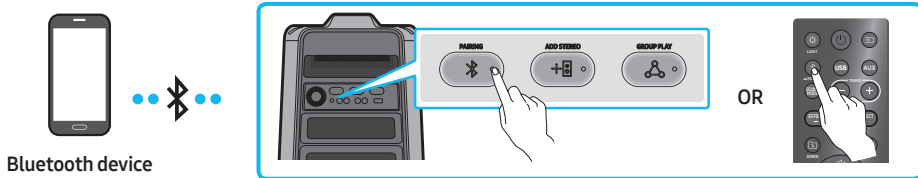

### The initial connection

1. Press and hold the **PAIRING** button on the remote control for more than 5 seconds to enter the "BT PAIRING" mode.  
**(OR)** Press the **PAIRING** button on the rear panel or press and hold the **SOURCE** button on the top panel for more than 5 seconds to enter the "BT PAIRING" mode.
2. On your device, select "[AV] Samsung Party T40" from the list that appears.
  - When the Party Audio is connected to the Bluetooth device, [Bluetooth Device Name] → "BT" appears in the front display.
3. Play music files from the device connected via Bluetooth through the Party Audio.

### If the device fails to connect

- If a previously connected Party Audio listing (e.g. "[AV] Samsung Party T40") appears in the list, delete it.
- Then repeat steps 1 and 2.

### What is the difference between BT READY and BT PAIRING?

- **BT READY** : In this mode, you can search for previously connected TVs or connect a previously connected mobile device to the Party Audio.
- **BT PAIRING** : In this mode, you can connect a new device to the Party Audio.  
(Press and hold the **PAIRING** button on the remote control or the **SOURCE** button on top of the Party Audio for more than 5 seconds to enter the "BT PAIRING" mode.)
  - You can also press the **PAIRING** button on the rear of the Party Audio to enter the "BT PAIRING" mode.

## Bluetooth Multi connection

The Party Audio can be connected to 2 Bluetooth devices at the same time.

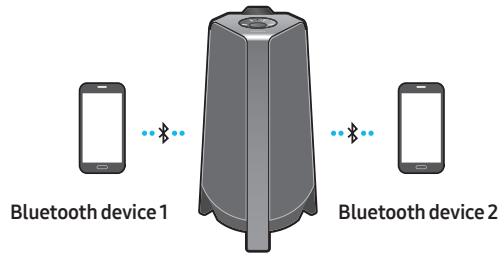

1. Connect the Party Audio to up to two Bluetooth devices. (See page 12)
2. If you attempt to connect a 3rd Bluetooth device, the 1st and 2nd devices will disconnect.
3. Play music from one of the connected Bluetooth devices while two devices are connected.

The other device will automatically pause.

- Depending on the device, and the content being played, playback may not be able to be automatically paused when switching from device to device.

### NOTES

- You can connect up to two Bluetooth devices at a time.
- If asked for a PIN code when connecting a Bluetooth device, enter <0000>.
- Environmental conditions or other factors with connected devices may have effect on playback quality.
- The Party Audio automatically turns off after 20 minutes with no command input in the ready state.
- The Party Audio may not perform Bluetooth search or connection correctly under the following circumstances:
  - If there is a strong electrical field around the Party Audio.
  - If several Bluetooth devices are simultaneously paired with the Party Audio.
  - If the Bluetooth device is turned off, not in place, or malfunctions.
- Electronic devices may cause radio interference. Devices that generate electromagnetic waves must be kept away from the Party Audio main unit - e.g., microwaves, wireless LAN devices, etc.
- When the Party Audio is connected to your TV by Bluetooth connection, the video on the TV and audio from the Party Audio may not be synchronized because the distance between the Party Audio and the TV is too far. It is recommended to move the Party Audio closer to your TV within 3.3 ft (1 meter).
- When the speaker is in the Bluetooth Multi connection mode, you will need to connect the other Bluetooth device and speaker within a few minutes (Approx. 1 minute). Otherwise Bluetooth Multi connection mode will be canceled.

- Bluetooth Multi connection may not be supported depending on the connected device's specifications.
- Removable/detachable Bluetooth devices (Ex:Dongle etc..) ,windows phone, laptops, TV, etc. do not support Bluetooth Multi connection.
- After Bluetooth Multi connection pairing, there may be a slight delay before music starts playing depending on the Bluetooth devices.
- If you move too far out of range from the Party Audio without first disconnecting your Bluetooth device, it may take a few minutes to connect other Bluetooth devices. If you turn the Party Audio off and back on, you can connect other Bluetooth devices without waiting.

## LED Indications

LED	STATE	Description
Blue	Fast Blink	BT PAIRING mode
	Blink	BT READY mode
	Solid	A Bluetooth device is connected.

## Using Bluetooth Power On

When the Party Audio is turned off, you can connect your smart device via a Bluetooth connection to turn it on.

1. Press and hold the **BASS** button on the remote control or on the top panel to set the Bluetooth Power On function on. "**ON-BLUETOOTH POWER**" appears on the display.
2. When the Party Audio is off, connect your smart device via Bluetooth. (For information on Bluetooth connections, refer to your smart device's manual.)
3. When the connection is complete, the Party Audio turns itself on automatically in Bluetooth mode.
  - Select the desired music to play from your smart device.

## NOTE

- Press and hold the **BASS** button for more than 5 seconds on the remote control or on the top panel to turn the Bluetooth Power On function on or off.

Each time you press the **BASS** button, the Party Audio displays :

**ON-BLUETOOTH POWER → OFF-BLUETOOTH POWER**

## 05 CONNECTING A USB STORAGE DEVICE

You can play music files located on USB storage device through the Party Audio.

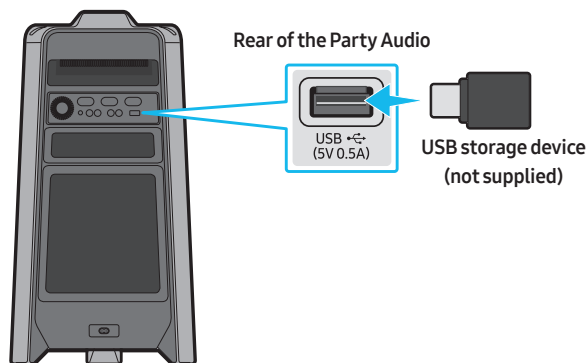

1. Connect a USB storage device to the USB jack on your Party Audio.
2. Press the  (**Source**) button on the top panel or on the remote control, and then select "**USB**".
  - You can also select a source using **USB** button on the remote control.
3. "**USB**" appears in the display screen.
4. Play music files from the USB storage device through the Party Audio.
  - The Party Audio automatically turns off (Auto Power Down) if USB device is not connected, playback stopped, or there is no input for more than 20 minutes.

### Software Update

**Samsung may offer updates for the Party Audio's system firmware in the future.**







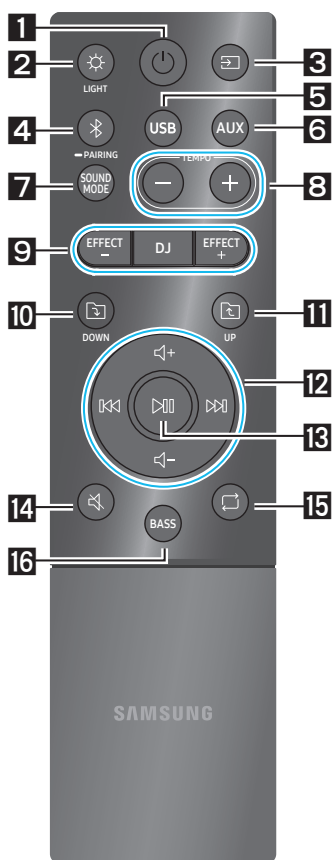

If an update is offered, you can update the firmware by connecting a USB device with the firmware update stored on it to the **USB** port on your Party Audio. For more information about how to download update files, go to the Samsung Electronics website at [www.samsung.com/us/support/](http://www.samsung.com/us/support/).

















Then, enter or select the model number of your Party Audio, select the Software & Apps option, and then Downloads. Note that the option names can vary.

# 06 USING THE REMOTE CONTROL

## How to Use the Remote Control



<p><b>1</b></p>  <p><b>Power</b></p>	<p>Turn the Party Audio on and off.</p>
<p><b>2</b></p>  <p><b>LIGHT</b></p>	<p>Press the  (<b>LIGHT</b>) button to turn the Lighting Mode on. Press the button repeatedly to cycle through the available light modes: <b>AMBIENT, PARTY, DANCE, THUNDERBOLT, STAR</b> or <b>OFF</b>.</p>
<p><b>3</b></p>  <p><b>Source</b></p>	<p>Press to select a source connected to the Party Audio. Press the button repeatedly to cycle through the available sources: <b>BT, USB, AUX1</b> or <b>AUX2</b>.</p>
<p><b>4</b></p>  <p><b>Bluetooth PAIRING</b></p>	<p>Press to select a source connected directly to "BT" mode. Press and hold the button for more than 5 seconds to enter the "BT PAIRING" mode.</p>
<p><b>5</b></p>  <p><b>USB</b></p>	<p>Press to select the <b>USB</b> source connected to the Party Audio.</p>
<p><b>6</b></p>  <p><b>AUX</b></p>	<p>Press to select the <b>AUX1</b> or <b>AUX2</b> sources connected to the Party Audio.</p>
<p><b>7</b></p>  <p><b>SOUND MODE</b></p>	<p>Press the button repeatedly to cycle through the available sound effects: <b>PARTY, STANDARD, HIPHOP, EDM, ROCK, LATIN, HOUSE</b> or <b>REGGAE</b>.</p>
<p><b>8</b></p>  <p><b>TEMPO +, -</b></p>	<p>Press the <b>TEMPO +</b> or <b>TEMPO -</b> buttons to change the tempo of the music up or down.</p> <ul style="list-style-type: none"> <li>This function only works in the <b>USB</b> mode.</li> </ul>

9	 <b>DJ</b>	<p>This function lets you turn on the DJ effect function.          Press the button repeatedly to cycle through the available DJ sound effects:  <b>NOISE, FILTER, CRUSH, CHORUS, WAHWAH</b> or <b>OFF</b>.</p>
	 <b>EFFECT +, -</b>	<p>Press the <b>EFFECT +</b> or <b>EFFECT -</b> buttons to change the level of the each DJ sound effect up or down.</p>
10	 <b>Folder DOWN</b>	<p>Press the  (<b>DOWN</b>) button to move to the next folder in the USB device.</p>
11	 <b>Folder UP</b>	<p>Press the  (<b>UP</b>) button to move to the previous folder in the USB device.</p>
12	 <b>Volume up, Volume down / Skip</b>	<ul style="list-style-type: none"> <li>• <b>Volume up, Volume down</b>              Press the + (<b>Volume up</b>) or - (<b>Volume down</b>) to adjust the volume level up or down.</li> <li>• <b>Music Skip</b>              Press the  button to select the next music file. Press the  button to select the previous music file.</li> </ul>
13	 <b>Play / Pause</b>	<p>Press the  button to pause a music file temporarily.          When you press the button again, the music file plays.</p>
14	 <b>Mute</b>	<p>Press the  (<b>Mute</b>) button to mute the sound.          Press it again to unmute the sound.</p>
15	 <b>Repeat</b>	<p>Press the  (<b>Repeat</b>) button to use the Repeat function in “USB” mode.          Press the button repeatedly to cycle through the available repeat functions:  <b>ONE, FOLDER, ALL, RANDOM</b> or <b>OFF</b>.</p>
16	 <b>BASS</b>	<p>Press the <b>BASS</b> button to use the powerful bass sound.</p>

# 07 TROUBLESHOOTING

Refer to the table below if this product does not function properly. If the problem you are experiencing is not listed below or if the instructions below do not help, turn off the product, disconnect the power cord, and contact Samsung Electronics at 1-800-SAMSUNG (1-800-726-7864).

## The unit will not turn on.

### Is the power cord plugged into the outlet?

- Connect the power plug to the outlet.

## A function does not work when the button is pressed.

### Is there static electricity in the air?

- Disconnect the power plug and connect it again.

## Sound dropouts occur in BT mode.

- See the Bluetooth connection sections on page 12.

## Sound is not produced.

### Is the Mute function on?

- Press the  (Mute) button to cancel the mute function.

### Is the volume set to minimum?

- Adjust the Volume.

## The remote control does not work.

### Are the batteries drained?

- Replace them with new batteries.

### Is the distance between the remote control and Party Audio main unit too far?

- Move the remote control closer to the Party Audio main unit.

## Stereo Group connection is not working.

### Is the system in wireless Group Play mode?

- Disconnect the wireless Group Play mode and try Stereo Group connection again.

## It cannot make a Bluetooth connection.

### Is the system connected to another system in wireless Group Play mode or Stereo Group mode?

- Try Bluetooth connection again after disconnecting the wireless Group Play or Stereo Group connection.

### Are the two Bluetooth devices already connected?

- Try Bluetooth connection again after disconnecting other Bluetooth connections.

## The PAIRING button is not working.

### Is the system in wireless Group Play mode or Stereo Group mode?

- Try again after disconnecting the wireless Group Play or Stereo Group connection.

## I want to switch the host system to the other in wireless Group Play or Stereo Group connection.

- Disconnect Group Play mode, press the Speaker which you want make to host first, and after it displays "HOST" message, connect the others one by one.
- With Stereo Group mode, host is fixed. You can not change others as host.

## I want to play AUX1 or AUX2 more than 8 hours without control input.

- Press and hold the  button for more than 5 seconds in **AUX1** or **AUX2** mode to disable Auto Power Down Function. Change from **ON-AUTO POWER DOWN** to **OFF-AUTO POWER DOWN**.



---

**I can't connect a slave to Group play.**

- After 1 hour, the host will block any additional slaves from being added. Press the **GROUP PLAY** button on host, after it display "**HOST**" message, the slave can be reconnected.

---

**It cannot make a "Wireless/Wired Group/Add Stereo/Bluetooth" connection.****Is the distance between systems too far?**

- It is recommended to make a "Wireless/Wired Group/Add Stereo/Bluetooth" pairing within 3.3 ft (1 meter) from the system.
  - The recommended operating distance between Party Audio systems is closer than 32.8 ft (10 meters).
- 

## 08 LICENSE

---



The Bluetooth® word mark and logos are registered trademarks owned by the Bluetooth SIG, Inc. and any use of such marks by Samsung Electronics Co., Ltd. is under license. Other trademarks and trade names are those of their respective owners.

---



Qualcomm aptX is a product of Qualcomm Technologies, Inc. and/or its subsidiaries. Qualcomm is a trademark of Qualcomm Incorporated, registered in the United States and other countries. aptX is a trademark of Qualcomm Technologies International, Ltd., registered in the United States and other countries.

---

## 09 OPEN SOURCE LICENSE NOTICE

To send inquiries and requests regarding open sources, contact Samsung via Email ([oss.request@samsung.com](mailto:oss.request@samsung.com)).

## 10 IMPORTANT NOTES ABOUT SERVICE

- Figures and illustrations in this User Manual are provided for reference only and may differ from actual product appearance.
- An administration fee may be charged if either:
  - a. An engineer is called out to your home at your request and there is no defect in the product.
  - b. You bring the unit to a repair center and there is no defect in the product.
- You will be advised of the amount of the administration fee before any work is done or a home visit is made.
- If you have a problem with this product, we strongly recommend you read the appropriate section of this manual, visit the Support page for your product at [www.samsung.com](http://www.samsung.com), or call Samsung Product Support (1-800-726-7864) to find an answer before you contact a service center for a repair.

# 11 SPECIFICATIONS AND GUIDE

## Specifications

Model Name		MX-T40
USB		5V/0.5A
Weight		15.0 lbs (6.8 kg)
Dimensions (W x H x D)		11.5 x 20.9 x 10.6 inches (291.5 x 530.5 x 268 mm)
Operating Temperature Range		+41°F to +95°F (+5°C to +35°C)
Operating Humidity Range		10 % ~ 75 %
AMPLIFIER Rated Output power	Tweeter	50W x 2, 8 ohm
	Woofers	100W x 2, 4 ohm

### NOTES

- Samsung Electronics Co., Ltd reserves the right to change the specifications without notice.
- Weight and dimensions are approximate.

## LIMITED WARRANTY TO ORIGINAL PURCHASER

This SAMSUNG brand product, as supplied and distributed by SAMSUNG and delivered new, in the original carton to the original consumer purchaser, is warranted by SAMSUNG against manufacturing defects in materials and workmanship for a limited warranty period of:

### **One (1) Year Parts and Labor\***

#### **(\*90 Days Parts and Labor for Commercial Use)**

This limited warranty begins on the original date of purchase, and is valid only on products purchased and used in the United States. To receive warranty service, the purchaser must contact SAMSUNG for problem determination and service procedures. Warranty service can only be performed by a SAMSUNG authorized service center. The original dated bill of sale must be presented upon request as proof of purchase to SAMSUNG or SAMSUNG's authorized service center. Transportation of the product to and from the service center is the responsibility of the purchaser.

SAMSUNG will repair or replace this product, at our option and at no charge as stipulated herein, with new or reconditioned parts or products if found to be defective during the limited warranty period specified above.

All replaced parts and products become the property of SAMSUNG and must be returned to SAMSUNG.

Replacement parts and products assume the remaining original warranty, or ninety (90) days, whichever is longer.

SAMSUNG's obligations with respect to software products distributed by SAMSUNG under the SAMSUNG brand name are set forth in the applicable end user license agreement. Non-SAMSUNG hardware and software products, if provided, are on an "AS IS" basis.

Non-SAMSUNG manufacturers, suppliers, publishers, and service providers may provide their own warranties.

This limited warranty covers manufacturing defects in materials and workmanship encountered in normal, and except to the extent otherwise expressly provided for in this statement, noncommercial use of this product, and shall not apply to the following, including, but not limited to: damage which occurs in shipment; delivery and installation; applications and uses for which this product was not intended; altered product or serial numbers; cosmetic damage or exterior finish; accidents, abuse, neglect, fire, water, lightning or other acts of nature; use of products, equipment, systems, utilities, services, parts, supplies, accessories, applications, installations, repairs, external wiring or connectors not supplied and authorized by SAMSUNG, or which damage this product or result in service problems; incorrect electrical line voltage, fluctuations and surges; customer adjustments and failure to follow operating instructions, cleaning, maintenance and environmental instructions that are covered and prescribed in the instruction book; product removal or reinstallation; reception problems and distortion related to noise, echo, interference or other signal transmission and delivery problems. SAMSUNG does not warrant uninterrupted or error-free operation of the product.

THERE ARE NO EXPRESS WARRANTIES OTHER THAN THOSE LISTED AND DESCRIBED ABOVE, AND NO WARRANTIES WHETHER EXPRESS OR IMPLIED, INCLUDING, BUT NOT LIMITED TO, ANY IMPLIED WARRANTIES OF MERCHANTABILITY OR FITNESS FOR A PARTICULAR PURPOSE, SHALL APPLY AFTER THE EXPRESS WARRANTY PERIODS STATED ABOVE, AND NO OTHER EXPRESS WARRANTY OR GUARANTY GIVEN BY ANY PERSON, FIRM OR CORPORATION WITH RESPECT TO THIS PRODUCT SHALL BE BINDING ON SAMSUNG. SAMSUNG SHALL NOT BE LIABLE FOR LOSS OF REVENUE OR PROFITS, FAILURE TO REALIZE SAVINGS OR OTHER BENEFITS, OR ANY OTHER SPECIAL, INCIDENTAL OR CONSEQUENTIAL DAMAGES CAUSED BY THE USE, MISUSE OR INABILITY TO USE THIS PRODUCT, REGARDLESS OF THE LEGAL THEORY ON WHICH THE CLAIM IS BASED, AND EVEN IF SAMSUNG HAS BEEN ADVISED OF THE POSSIBILITY OF SUCH DAMAGES. NOR SHALL RECOVERY OF ANY KIND AGAINST SAMSUNG BE GREATER IN AMOUNT THAN THE PURCHASE PRICE OF THE PRODUCT SOLD BY SAMSUNG AND CAUSING THE ALLEGED DAMAGE. WITHOUT LIMITING THE FOREGOING, PURCHASER ASSUMES ALL RISK AND LIABILITY FOR LOSS, DAMAGE OR INJURY TO PURCHASER AND PURCHASER'S PROPERTY AND TO OTHERS AND THEIR PROPERTY ARISING OUT OF THE USE, MISUSE OR INABILITY TO USE THIS PRODUCT SOLD BY SAMSUNG NOT CAUSED DIRECTLY BY THE NEGLIGENCE OF SAMSUNG. THIS LIMITED WARRANTY SHALL NOT EXTEND TO ANYONE OTHER THAN THE ORIGINAL PURCHASER OF THIS PRODUCT, IS NONTRANSFERABLE AND STATES YOUR EXCLUSIVE REMEDY.

Some states do not allow limitations on how long an implied warranty lasts, or the exclusion or limitation of incidental or consequential damages, so the above limitations or exclusions may not apply to you. This warranty gives you specific legal rights, and you may also have other rights which vary from state to state.

To obtain warranty service, please contact SAMSUNG customer care center.

The benefits of this Limited Warranty extend only to the original purchaser of Samsung products from an authorized Samsung reseller. THIS LIMITED WARRANTY SHALL NOT APPLY TO ANY SAMSUNG PRODUCTS PURCHASED FROM UNAUTHORIZED RESELLERS OR RETAILERS, EXCEPT IN STATES WHERE SUCH RESTRICTION MAY BE PROHIBITED. For a list of Samsung authorized retailers, please go to: [http://www.samsung.com/us/peaceofmind/authorized\\_resellers.html](http://www.samsung.com/us/peaceofmind/authorized_resellers.html)

SAMSUNG



Certification model only

QUESTIONS OR COMMENTS?

AREA	CALL	OR VISIT US ONLINE AT	WRITE
IN THE US	1-800-SAMSUNG (726-7864)	<a href="http://www.samsung.com/us/support">www.samsung.com/us/support</a>	Samsung Electronics America, Inc. 85 Challenger Road Ridgefield Park, NJ 07660

© 2020 Samsung Electronics Co., Ltd. All rights reserved.



72-WT40ZA-DFUB1-SS