

SAMSUNG

FULL MANUAL

HW-A40R

Imagine the possibilities

Thank you for purchasing this Samsung product.

To receive more complete service, please register
your product at www.samsung.com/register

SAFETY INFORMATION

- The following also applies to the Wireless Surround Speaker SET (SWA-8500).

SAFETY WARNINGS

TO REDUCE THE RISK OF ELECTRIC SHOCK, DO NOT REMOVE THE COVER (OR BACK). NO USER-SERVICEABLE PARTS ARE INSIDE. REFER SERVICING TO QUALIFIED SERVICE PERSONNEL.

Refer to the table below for an explanation of symbols which may be on your Samsung product.

	<p style="text-align: center;">CAUTION RISK OF ELECTRIC SHOCK. DO NOT OPEN.</p>	
	This symbol indicates that high voltage is present inside. It is dangerous to make any kind of contact with any internal part of this product.	
	This symbol indicates that this product has included important literature concerning operation and maintenance.	
	Class II product : This symbol indicates that it does not require a safety connection to electrical earth (ground). If this symbol is not present on a product with a power cord, the product MUST have a reliable connection to protective earth (ground).	
	AC voltage : This symbol indicates that the rated voltage marked with the symbol is AC voltage.	
	DC voltage : This symbol indicates that the rated voltage marked with the symbol is DC voltage.	
	Caution, Consult instructions for use : This symbol instructs the user to consult the user manual for further safety related information.	

WARNING

- To reduce the risk of fire or electric shock, do not expose this appliance to rain or moisture.
- To prevent injury, this apparatus must be securely attached to the floor/wall in accordance with the installation instructions.
- This product contains chemicals known to the State of California to cause cancer and birth defects or other reproductive harm.

CAUTION

- Do not expose this apparatus to dripping or splashing. Do not put objects filled with liquids, such as vases, on the apparatus.
- To turn this apparatus off completely, you must pull the power plug out of the wall socket. Consequently, the power plug must be easily and readily accessible at all times.

FCC NOTE (for U.S.A):

FCC Supplier's Declaration of Conformity

Product name: SoundBar
Model: HW-A40R
Responsible Party - U.S. Contact Information:

Samsung Electronics America, Inc.
 85 Challenger Road.
 Ridgefield Park, NJ 07660
 Phone: 1-800-SAMSUNG (726-7864)

FCC Compliance Statement :

This device complies with Part 15 of the FCC Rules. Operation is subject to the following two conditions:

- (1) This device may not cause harmful interference, and (2) this device must accept any interference received, including interference that may cause undesired operation.

FCC Caution :

- Any changes or modifications not expressly approved by the party responsible for compliance could void the user's authority to operate this equipment.
- This product satisfies FCC regulations when shielded cables and connectors are used to connect the unit to other equipment. To prevent electromagnetic interference with electric appliances, such as radios and televisions, use shielded cables and connectors for connections.

Class B FCC Statement

This equipment has been tested and found to comply with the limits for a Class B digital device, pursuant to Part 15 of the FCC Rules. These limits are designed to provide reasonable protection against harmful interference in a residential installation. This equipment generates, uses and can radiate radio frequency energy and, if not installed and used in accordance with the instructions, may cause harmful interference to radio communications. However, there is no guarantee that interference will not occur in a particular installation. If this equipment does cause harmful interference to radio or television reception, which can be determined by turning the equipment off and on, the user is encouraged to try to correct the interference by one of the following measures:

- Reorienting or relocating the receiving antenna.
- Increasing the separation between the equipment and receiver.
- Connecting the equipment to an outlet that is on a different circuit than the radio or TV.
- Consulting the dealer or an experienced radio/TV technician for help.

FCC Radiation Exposure Statement :

This equipment complies with FCC radiation exposure limits set forth for an uncontrolled environment. This equipment should be installed and operated so there is at least 8 inches (20 cm) between the radiator and your body. This device and its antenna(s) must not be co-located or operated in conjunction with any other antenna or transmitter.

CALIFORNIA USA ONLY (Applicable for networking models only.)

This Perchlorate warning applies only to primary CR(Manganese Dioxide) Lithium coin cells in the product sold or distributed ONLY in California USA "Perchlorate Material - special handling may apply, See www.dtsc.ca.gov/hazardouswaste/perchlorate."

Dispose unwanted electronics through an approved recycler. To find the nearest recycling location, go to our website:www.samsung.com/recycling Or call, 1-800-SAMSUNG

 WARNING: Cancer and Reproductive Harm - www.P65Warnings.ca.gov.

Important Safety Instructions

Read these operating instructions carefully before using the unit. Follow all the safety instructions listed below. Keep these operating instructions handy for future reference.

1. Read these instructions.
2. Keep these Instructions.
3. Heed all warnings.
4. Follow all instructions.
5. Do not use this apparatus near water.
6. Clean only with dry cloth.
7. Do not block any ventilation openings. Install in accordance with the manufacturer's instructions.

8. Do not install near any heat sources such as radiators, heat registers, stoves, or other apparatus (including amplifiers) that produce heat.
9. Do not defeat the safety purpose of the polarized or grounding-type plug.
A polarized plug has two blades with one wider than the other. A grounding type plug has two blades and a third grounding prong. The wide blade or the third prong are provided for your safety. If the provided plug does not fit into your outlet, consult an electrician for replacement of the obsolete outlet.
10. Protect the power cord from being walked on or pinched particularly at plugs, convenience receptacles, and the point where they exit from the apparatus.
11. Only use attachments/accessories specified by the manufacturer.
12. Use only with the cart, stand, tripod, bracket, or table specified by the manufacturer, or sold with the apparatus.
When a cart is used, use caution when moving the cart/apparatus combination to avoid injury from tip-over.
13. Unplug this apparatus during lightning storms or when unused for long periods of time.
14. Refer all servicing to qualified service personnel. Servicing is required when the apparatus has been damaged in any way, such as power-supply cord or plug is damaged, liquid has been spilled or objects have fallen into the apparatus, the apparatus has been exposed to rain or moisture, does not operate normally, or has been dropped.



PRECAUTIONS

1. Ensure that the AC power supply in your house complies with the power requirements listed on the identification sticker located on the bottom of your product. Install your product horizontally, on a suitable base (furniture), with enough space around it for ventilation (3~4 inches). Make sure the ventilation slots are not covered. Do not place the unit on amplifiers or other equipment which may become hot. This unit is designed for continuous use. To fully turn off the unit, disconnect the AC plug from the wall outlet. Unplug the unit if you intend to leave it unused for a long period of time.
2. During thunderstorms, disconnect the AC plug from the wall outlet. Voltage peaks due to lightning could damage the unit.
3. Do not expose the unit to direct sunlight or other heat sources. This could lead to overheating and cause the unit to malfunction.
4. Protect the product from moisture (i.e. vases), and excess heat (e.g. a fireplace) or equipment creating strong magnetic or electric fields. Unplug the power cable from the AC wall socket if the unit malfunctions. Your product is not intended for industrial use. It is for personal use only. Condensation may occur if your product has been stored in cold temperatures. If transporting the unit during the winter, wait approximately 2 hours until the unit has reached room temperature before using.
5. The battery used with this product contains chemicals that are harmful to the environment. Do not dispose of the battery in the general household trash. Do not expose the battery to excess heat, direct sunlight, or fire. Do not short circuit, disassemble, or overheat the battery.
CAUTION : Danger of explosion if the battery is replaced incorrectly. Replace only with the same or equivalent type.

ABOUT THIS MANUAL

The user manual has two parts: simple paper USER MANUAL and a detailed FULL MANUAL you can download.



USER MANUAL

See this manual for safety instructions, product installation, components, connections, and product specifications.



FULL MANUAL

You can access the FULL MANUAL on Samsung's on-line customer support center by scanning the QR code on the left. To see the manual on your PC or mobile device, download the manual in document format from Samsung's website. (<http://www.samsung.com/support>)

Design and specifications are subject to change without prior notice.

CONTENTS

01	Checking the Components	8
	Inserting battery (AAA) into the Remote Control	9
02	Product Overview	10
	Front / Right Side Panel of the Soundbar	10
	Bottom Panel of the Soundbar	11
03	The Remote Control	12
	Using the Hidden Buttons (Buttons with more than one function)	13
	Adjusting the Soundbar volume with a TV remote control	15
04	Connecting the Soundbar	16
	Connecting Electrical Power	16
	Connecting an SWA-8500 to your Soundbar	17
05	Connecting to a TV	20
	Connecting using an Optical Cable	20
	Connecting a TV or Bluetooth Device via Bluetooth	22
	Connecting a Soundbar to a mobile device via NFC function	23
06	Connecting an External Device	26
	Connecting using an Optical Cable	26
	Connecting using an Analog Audio (AUX) Cable	27

07	Connecting a USB Storage Device	28
	Setting Repeat Play Options	29
08	System Reset	31
09	Installing the Wall Mount (Optional)	32
	Installation Precautions	32
	Wall mount Components	32
10	Software Update	35
	Update Procedure	35
	When update fails	36
11	Troubleshooting	37
12	License	38
13	Open Source License Notice	38
14	Important Notes About Service	38
15	Specifications and Guide	39
	Specifications	39

01 CHECKING THE COMPONENTS

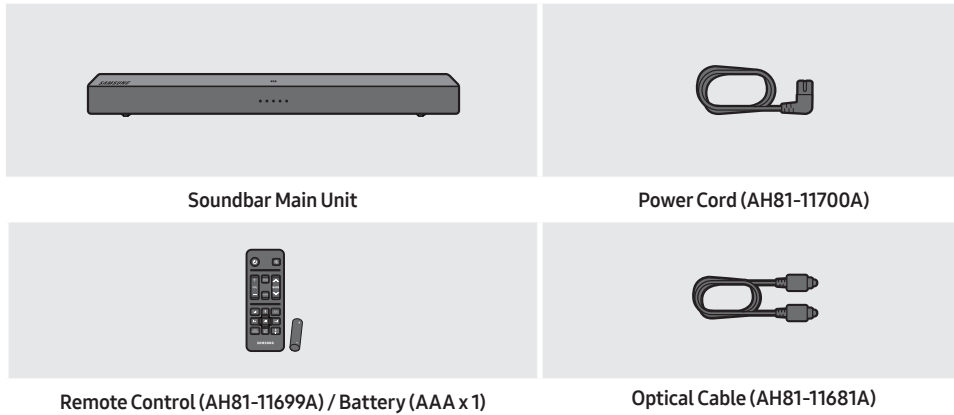

Wireless Surround Speaker SET (SWA-8500)

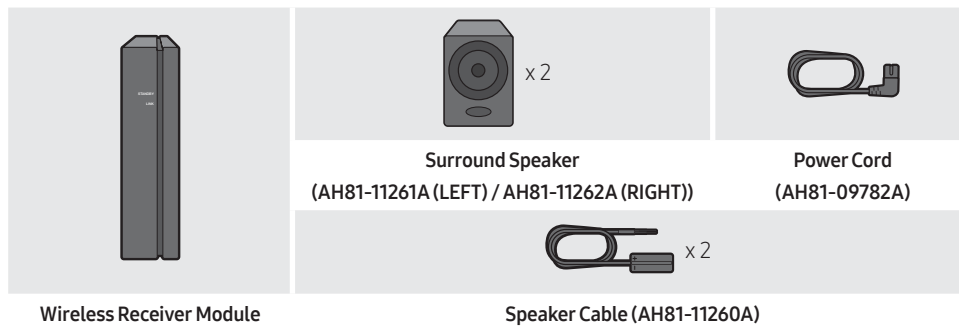

- User Manual / Warranty Card / Regulatory Guide (Not available in some locations).
- For more information about the power supply and power consumption, refer to the label attached to the product. (Label : Bottom of the Soundbar Main Unit)
- To purchase additional components or optional cables, contact a Samsung Service Center or Samsung Customer Care.
- The appearance of the accessories may differ slightly from the illustrations above.

Inserting battery (AAA) into the Remote Control

Match the polarity of the battery to the symbols on the battery compartment.

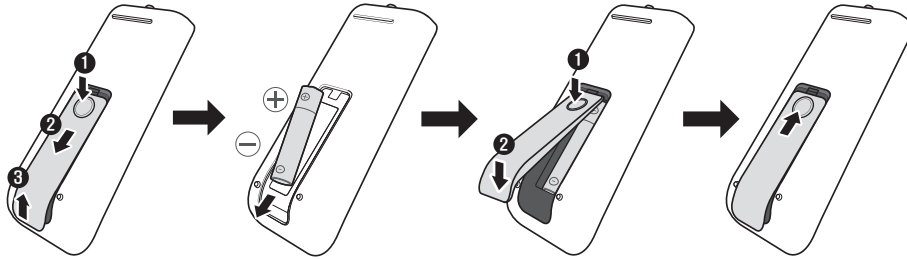

02 PRODUCT OVERVIEW

Front / Right Side Panel of the Soundbar

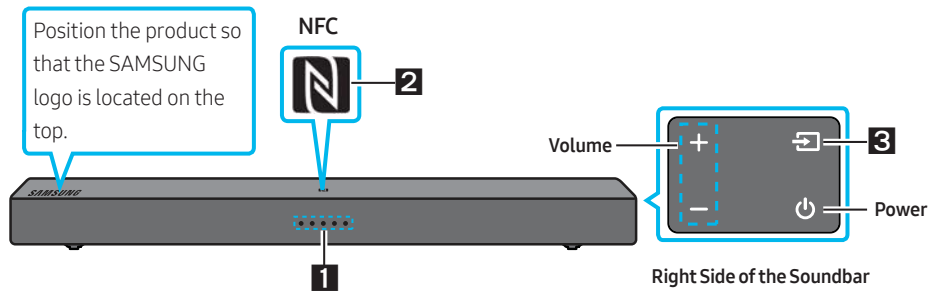

		The LED Indicator flashes, glows, or changes color depending on the Soundbar's current mode or status. The color of the LED indicator and the number of lights indicate the active mode as described below.			
		(W) White LED	(B) Blue LED	(R) Red LED	(G) Green LED
Mode	Remote control Button	LED indicator			
D.IN		(W) ○ ○ ○ ○ ○			
Bluetooth		(B) ○ ○ ○ ○ ○	Connected status		
		(B) ○ ○ ○ ○ ○	Slow-Blinking Disconnected status		
Bluetooth pairing		(B) ○ ○ ○ ○ ○	Fast-Blinking		
AUX		(W) (W) ○ ○ ○ ○			
USB		(W) (W) (W) ○ ○ ○			

2	NFC Logo	You can activate your Bluetooth connection by placing your phone in the NFC detection area of the Soundbar.
3	Source	Selects the source input mode. (D.IN / Bluetooth / AUX / USB) <ul style="list-style-type: none"> To turn on "Bluetooth pairing" mode, change the source to "Bluetooth" mode and then press and hold the  button for more than 5 seconds.

Bottom Panel of the Soundbar

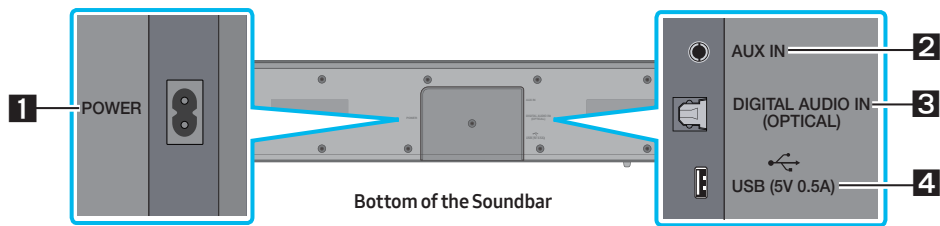

1	POWER	Connect the Soundbar's AC power cord.
2	AUX	Connect to the Analog output of an external device.
3	D.IN	Connect to the digital (optical) output of an external device.
4	USB	Connect a USB device here to play music files on the USB device through the Soundbar.





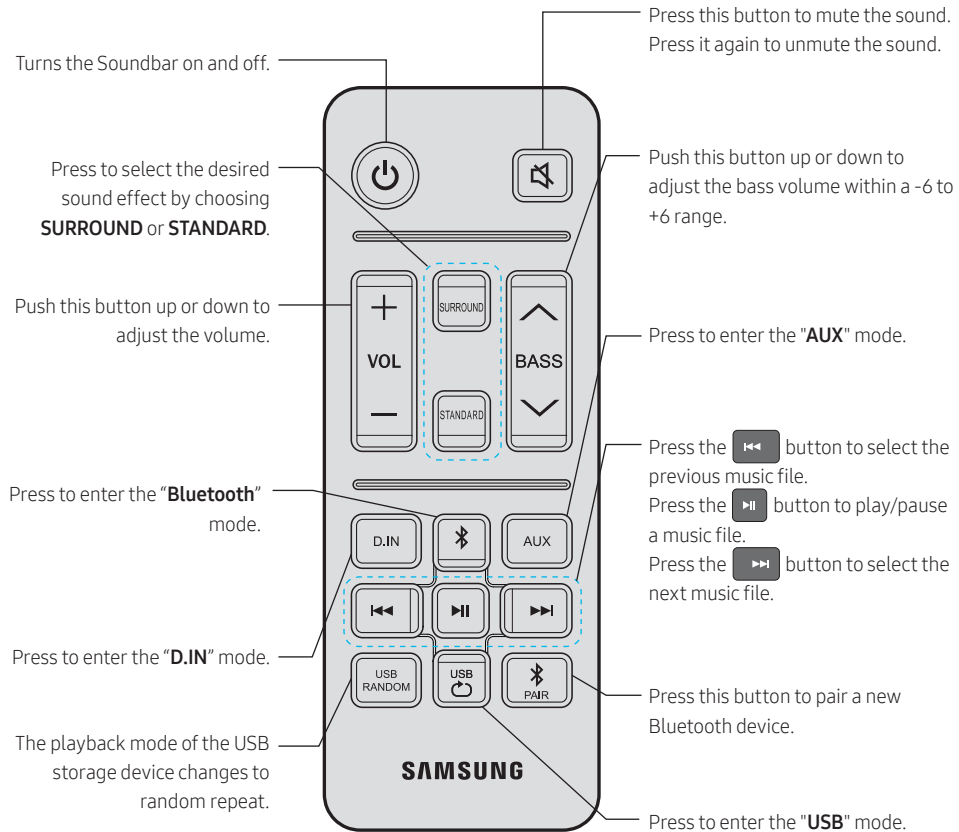

- When you plug in the AC cord, the power button will begin working in 4 to 6 seconds.
- When you turn on this unit, there will be a 4 to 5 second delay before it produces sound.
- If you want to enjoy sound only from the Soundbar, you must turn off the TV's speakers in the Audio Setup menu of your TV. Refer to the owner's manual supplied with your TV.
- When disconnecting the power cord from a wall outlet, pull the plug. Do not pull the cable.
- Do not connect this unit or other components to an AC outlet until all connections between components are complete.





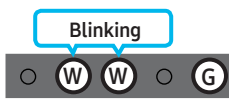
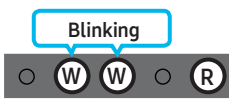
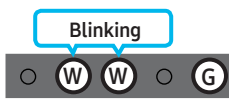
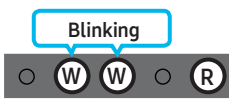
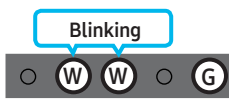
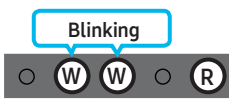

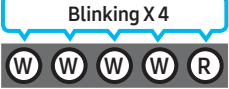



03 THE REMOTE CONTROL

- The images, buttons, and functions of the remote control may differ depending on the model.



Using the Hidden Buttons (Buttons with more than one function)

Hidden Button		How to Use the Remote Control		
Remote Control Button	Function			
	Auto Power Down On/Off (AUX mode)	<ul style="list-style-type: none"> - D.IN / Bluetooth / USB / AUX Mode : If there is no audio signal for 18 minutes. - If there is no KEY input for 8 hours when the Audio (AUX) Cable is connected. (Auto Power Down function can be turned off only in that case.) - To turn off Auto Power Down function, while in "AUX" mode, press and hold the  button for 5 seconds. <div style="border: 1px solid black; padding: 5px; margin-top: 10px;"> <p style="text-align: center;">LED indicator</p> <table style="width: 100%; text-align: center;"> <tr> <td style="width: 50%;">  <p>Auto Power Down On</p> </td> <td style="width: 50%;">  <p>Auto Power Down Off</p> </td> </tr> </table> </div>	 <p>Auto Power Down On</p>	 <p>Auto Power Down Off</p>
	 <p>Auto Power Down On</p>	 <p>Auto Power Down Off</p>		
Initialize (Standby)	<p>Press the  button for 5 seconds in the standby power off station to trigger the system initial function.</p> <ul style="list-style-type: none"> - This operation will not clear Bluetooth paired history. <div style="border: 1px solid black; padding: 5px; margin-top: 10px;"> <p style="text-align: center;">LED indicator</p> <p style="text-align: center;">Blinking X 4</p>  </div>			
	TV remote control On/Off (Standby)	For detailed information about TV remote control, please see "Adjusting the Soundbar volume with a TV remote control" on page 15.		
	TV Connect (Bluetooth mode)	For detailed information about TV Connect, please see "Disconnecting the Soundbar from the TV" on page 23.		

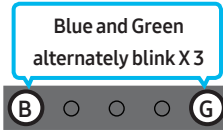
	Bluetooth Power On/Off	<p>Press the  button for 5 seconds in the power on station to trigger the Bluetooth Power On/Off function.</p> <div data-bbox="685 436 1269 617" style="border: 1px solid black; padding: 5px;"> <p style="text-align: center;">LED indicator</p> <table border="1" style="width: 100%; border-collapse: collapse;"> <tr> <td style="width: 50%; text-align: center;"> <div data-bbox="722 485 943 573">  </div> <p style="text-align: center;">Bluetooth Power On</p> </td> <td style="width: 50%; text-align: center;"> <div data-bbox="1008 485 1229 573">  </div> <p style="text-align: center;">Bluetooth Power Off</p> </td> </tr> </table> </div>	<div data-bbox="722 485 943 573">  </div> <p style="text-align: center;">Bluetooth Power On</p>	<div data-bbox="1008 485 1229 573">  </div> <p style="text-align: center;">Bluetooth Power Off</p>
<div data-bbox="722 485 943 573">  </div> <p style="text-align: center;">Bluetooth Power On</p>	<div data-bbox="1008 485 1229 573">  </div> <p style="text-align: center;">Bluetooth Power Off</p>			
	Auto Power Link On/Off	<p>For detailed information about Auto Power Link On/Off function, please see "Auto Power Link" on page 21.</p>		
	ID SET	<p>Press and hold the  button for 5 seconds to complete ID SET.</p> <div data-bbox="685 793 1279 1014" style="border: 1px solid black; padding: 5px;"> <p style="text-align: center;">LED indicator</p> <div data-bbox="868 842 1089 972" style="text-align: center;">  </div> <p style="text-align: center;">B → G → B → G → B → G</p> </div>		







Adjusting the Soundbar volume with a TV remote control

If you have a Samsung TV, you can adjust the Soundbar's volume using the IR remote control that came with your Samsung TV.

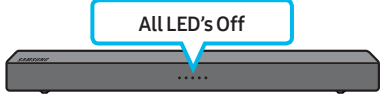
First use the TV menu to set the TV audio on your Samsung TV to external speakers, then use your Samsung remote to control the Soundbar's volume. For more information, see the TV's user manual.

The default mode for this function is control by a Samsung TV.

1. If your TV is not a Samsung TV and you want your TV's remote to control the Soundbar's volume, you can change the settings of this function by pressing and holding the **BASS**  button repeatedly. To have your TV's remote adjust the Soundbar's volume, follow Steps 1 through 3 below.
2. If you want to turn off this function completely, follow Steps 1 and 2.

	Mode	Remote control Button	LED indicator
1.	Turn off		
2.	"Off" mode		
3.	"All TV" mode		
4.	"Samsung TV" mode (Default mode)		

- Each time you press the **BASS**  button and hold it for 5 seconds, the mode switches in the following order: "Samsung TV" (Default mode) → "Off" → "All TV".
- The LED's blink for 3-4 seconds, then return to the standby power off mode.
- This function may not be available, depending on your TV's remote control.
- Manufacturers supporting this function: VIZIO, LG, Sony, Sharp, PHILIPS, PANASONIC, TOSHIBA, Hisense, RCA

04 CONNECTING THE SOUNDBAR

Connecting Electrical Power

- For information about the required electrical power and power consumption, refer to the label attached to the product. (Label : Bottom of the Soundbar Main Unit)

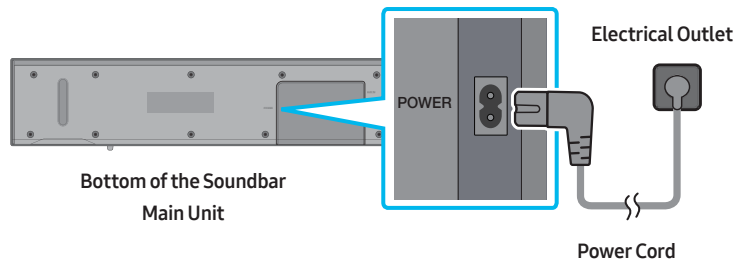

Connecting an SWA-8500 to your Soundbar

Expand to true wireless surround sound by connecting the Samsung Wireless Surround Speaker SET (SWA-8500) to your Soundbar.

1. Connect the Wireless Receiver Module to 2 Surround Speakers

Use the speaker cables to connect the two surround sound speakers to the Wireless Receiver Module.

- The speaker cables are color coded.

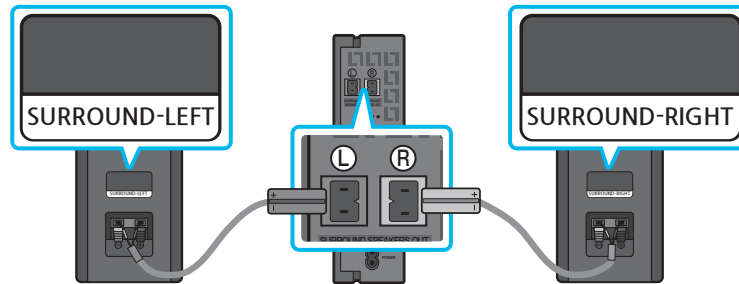

When connecting the speaker cables to the Wireless Receiver Module, follow these steps:

1. Insert the grey plug into the grey port on the Wireless Receiver.
2. Insert the blue plug into the blue port on the Wireless Receiver.

When connecting the speaker cables to the surround speakers, follow these steps:

1. Match the speaker cable connected to the grey port to the speaker with the grey label.
2. Match the speaker cable connected to the blue port to the speaker with the blue label.
3. Insert the red and black colored ends of each speaker cable into the red and black ports of the appropriate speaker.
 - The labels are on the backs of the speakers.

2. Check the standby status after plugging into an electrical outlet

The LINK LED indicator (blue LED) on the Wireless Receiver Module blinks. If the LED does not blink fast, press the **ID SET** button on the back of the Wireless Receiver Module with a pen tip for 5~6 seconds until the LINK LED indicator blinks fast (in Blue).

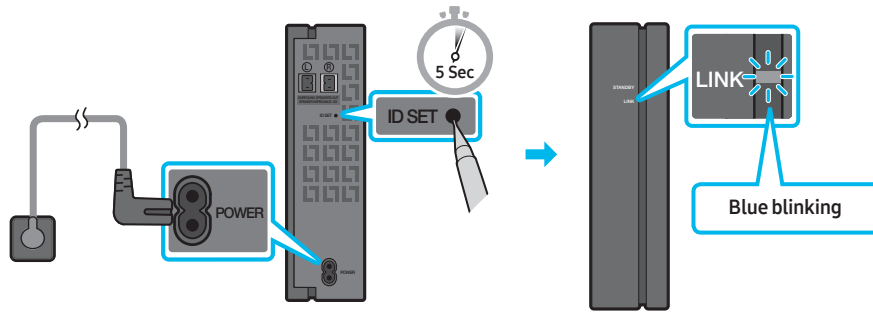

3. Configure "ID SET" using the Soundbar's remote control

Press and hold the **PAIR** button on the remote control for at least 5 seconds.

- The Soundbar will automatically power on when **ID SET** is complete.

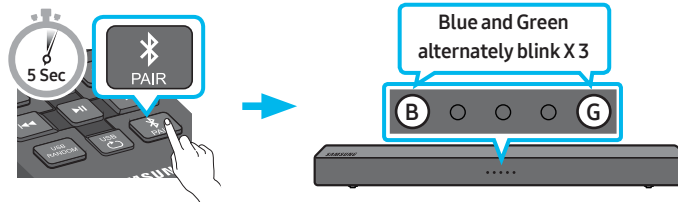

⚠ CAUTION

- If your Soundbar was playing music when it connects to the SWA-8500, you may hear some stuttering from the woofer as the connection finalizes.

4. Check if the LINK LED is solid blue (connection complete)

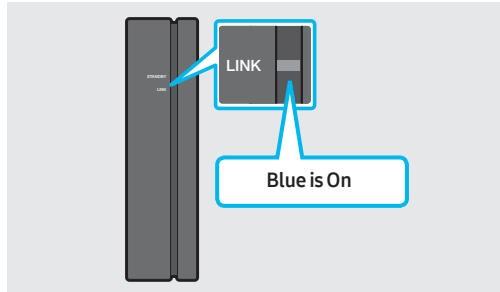

The LINK LED indicator stops blinking and glows a solid blue when a connection is established between the Soundbar and the Wireless Receiver Module.

5. If the SWA-8500 does not connect, take the necessary steps according to the LED Indicator's status

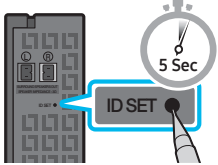
LED status			Action
LINK (Blue)	On	Connected with the Soundbar	-
	Blinking fast	Pairing mode	Check if the Soundbar is turned on Repeat steps 3 through 4.
	Blinking slowly	Disconnected	ID SET to change mode to Pairing mode
STANDBY (Red)	On	Connection failure	Check if the Soundbar is turned on <ol style="list-style-type: none"> 1. Press the ID SET button on the back of the Wireless Receiver Module with a pen tip for 5~6 seconds until the LINK LED indicator blinks (in Blue).  <ol style="list-style-type: none"> 2. Repeat steps 3 through 4.
			Others

05 CONNECTING TO A TV

Hear TV sound from your Soundbar through wired or wireless connections.

- When the Soundbar is connected to selected Samsung TVs, you can control the Soundbar using the TV's remote control.
 - This feature is supported by 2017 and later Samsung Smart TVs that support Bluetooth when you connect the Soundbar to the TV using an optical cable.
 - This function also allows you to use the TV menu to adjust the sound field and various settings as well as the volume and mute.

Connecting using an Optical Cable

Step 1. Connect an Optical Cable

Pre-connection Checklist

- When you use an optical cable and the terminals have covers, be sure to remove the covers.

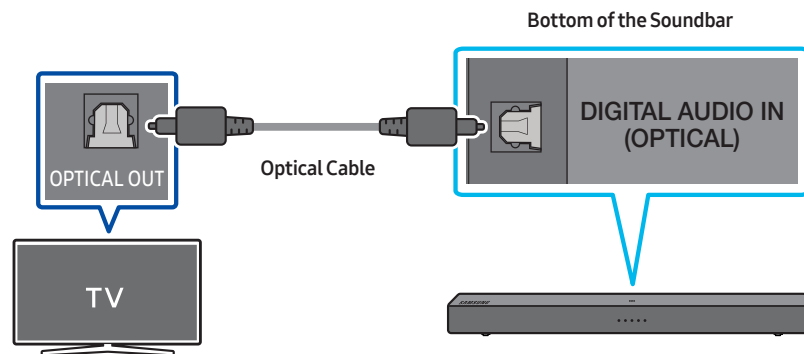

NOTE

- When the audio in a broadcast is encoded in Dolby Digital and the “Digital Output Audio Format” on your TV is set to PCM, we recommend that you change the setting to Dolby Digital. When the setting on the TV is changed, you will experience better sound quality. (The TV menu may use different words for Dolby Digital and PCM depending on the TV manufacturer.)

Step 2. Change the Soundbar's mode to D.IN

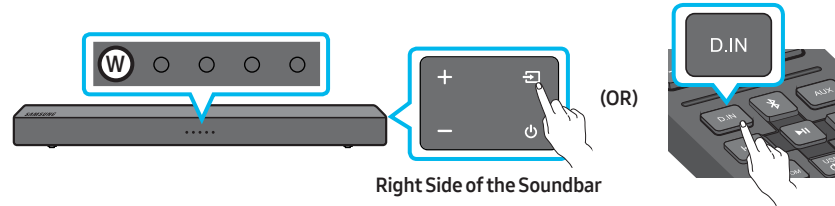









Auto Power Link

This Function automatically turns on the Soundbar when the TV is turned on if the Soundbar is connected to the TV by an Optical Cable.

Press and hold the  button on the remote control for more than 5 seconds to toggle this function.

- Auto Power Link is set to ON by default.
- Depending on the connected device, Auto Power Link may not function.

Mode	Remote control Button	LED indicator
OFF	 	 
ON	 	 

Connecting a TV or Bluetooth Device via Bluetooth

Step 1. Change the Soundbar mode to “Bluetooth Pairing”

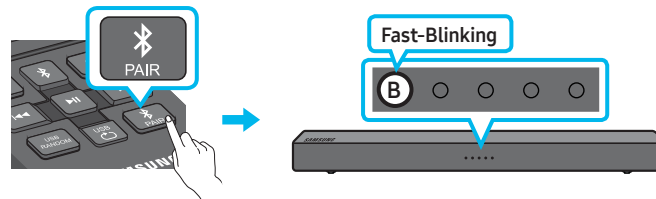

Step 2. Select the Soundbar in your TV's or Bluetooth device's Menu

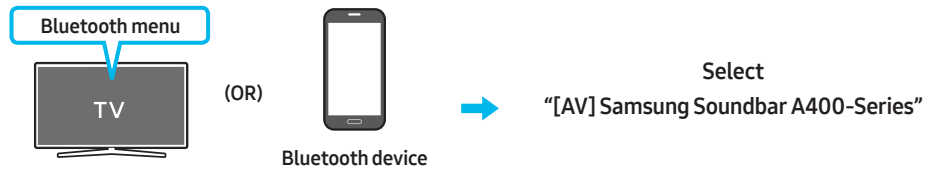

NOTE

- You cannot connect more than one TV or Bluetooth device at a time.

Step 3. Check the Soundbar's status

The blue LED should not be blinking once the Bluetooth connection is complete.

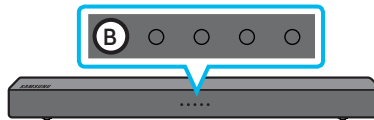





If the TV or device fails to connect

- If a previously connected Soundbar listing appears in the device list of your TV or Bluetooth device, delete it. (e.g. “[AV] Samsung Soundbar A400-Series”)
- Then repeat steps 1 through 3.

Disconnecting the Soundbar from the TV

Press the  button on the right side panel or on the remote control and switch to any mode but "Bluetooth".

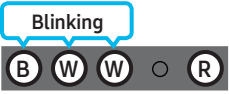
- Disconnecting takes time because the TV must receive a response from the Soundbar.
(The time required may differ, depending on the TV model.)
- To cancel the automatic Bluetooth connection between the Soundbar and TV, press and hold  button for 5 seconds in "Bluetooth Ready" mode. TV Connect is turned OFF.
- To turn TV Connect back on, press and hold the  button for 5 seconds with the Soundbar in "Bluetooth Ready" mode.
- TV Connect is set to ON by default.

Mode	Remote control Button	LED indicator
TV Connect-OFF		
TV Connect-ON		

Connecting a Soundbar to a mobile device via NFC function

Step 1. Place your mobile device in the NFC detection area on top of the Soundbar

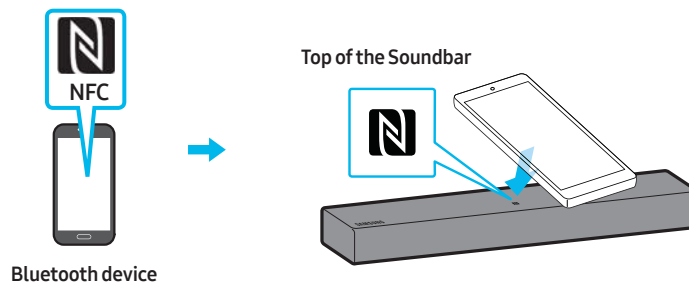

NOTES

- Make sure that your mobile device has the NFC function turned on and that the screen is active.
- Bluetooth connection is unavailable when NFC of the mobile device is in card emulation mode.

Step 2. Check the Soundbar's status

The blue LED should not be blinking once the Bluetooth connection is complete.

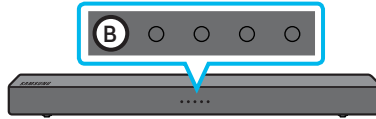

NOTES

- If asked for a PIN code when connecting a Bluetooth device, enter <0000>.
- The Soundbar automatically turns off after 18 minutes in the Ready state.
- The Soundbar may not perform Bluetooth search or connection correctly under the following circumstances:
 - If there is a strong electrical field around the Soundbar.
 - If several Bluetooth devices are simultaneously paired with the Soundbar.
 - If the Bluetooth device is turned off, not in place, or malfunctions.
- Electronic devices may cause radio interference. Devices that generate electromagnetic waves must be kept away from the Soundbar main unit - e.g., microwaves, wireless LAN devices, etc.
- The Soundbar supports SBC data (44.1kHz, 48kHz).
- Connect only to a Bluetooth device that supports the A2DP (AV) function.
- You cannot connect the Soundbar to a Bluetooth device that supports only the HF (Hands Free) function.
- Once you have paired the Soundbar to a Bluetooth device, selecting “[AV] Samsung Soundbar A400-Series” from the device’s scanned devices list will automatically change the Soundbar to “Bluetooth” mode.
 - Available only if the Soundbar is listed among the Bluetooth device’s paired devices.
(The Bluetooth device and the Soundbar must have been previously paired at least once.)
- The Soundbar cannot be paired to another Bluetooth device if already in Bluetooth mode and paired to a Bluetooth device.

Bluetooth Power On/Off

If a previously paired Bluetooth device tries to pair with the Soundbar when the Bluetooth Power function is on and the Soundbar is turned off, the Soundbar turns on automatically.

Press and hold the  button for more than 5 seconds in the power on station to trigger/shut off Bluetooth Power On function. For more information about Bluetooth Power On/Off, see page 14.

- Bluetooth Power function is set to On by default.

More About Bluetooth

Bluetooth is a technology that enables Bluetooth-compliant devices to interconnect easily with each other using a short wireless connection.

- A Bluetooth device may cause noise or malfunction, depending on usage, if:
 - A part of your body is in contact with the receiving/transmitting system of the Bluetooth device or the Soundbar.
 - It is subject to electrical variation from obstructions caused by a wall, corner, or office partition.
 - It is exposed to electrical interference from same frequency-band devices including medical equipment, microwave ovens, and wireless LANs.
- Pair the Soundbar with the Bluetooth device while they are close together.
- The further the distance between the Soundbar and Bluetooth device, the worse the quality is. If the distance exceeds the Bluetooth operational range, the connection is lost.
- In poor reception areas, the Bluetooth connection may not work properly.
- The Bluetooth connection only works when it is close to the unit. The connection will be automatically cut off if the Bluetooth device is out of range. Even within range, the sound quality may be degraded by obstacles such as walls or doors.
- This wireless device may cause electric interference during its operation.

06 CONNECTING AN EXTERNAL DEVICE

Connect to an external device via an optical cable or analog cable to play the external device's sound through the Soundbar.

Connecting using an Optical Cable

Step 1. Connect using an Optical Cable

BD / DVD player / Set-top box /
Game console

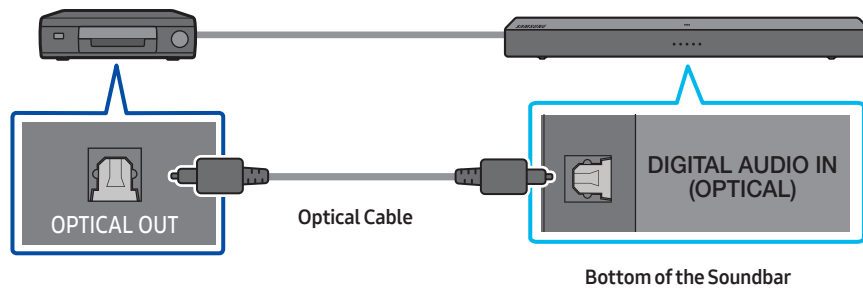

Step 2. Change the Soundbar's mode to D.IN

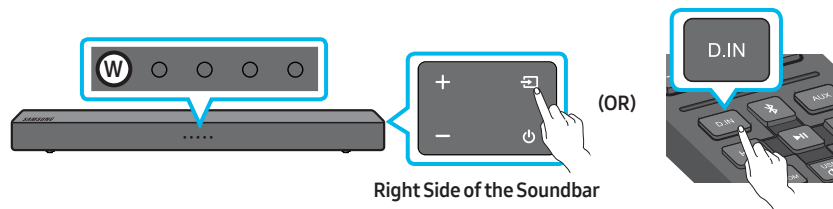

Connecting using an Analog Audio (AUX) Cable

Step 1. Connect using an Analog Audio (AUX) Cable

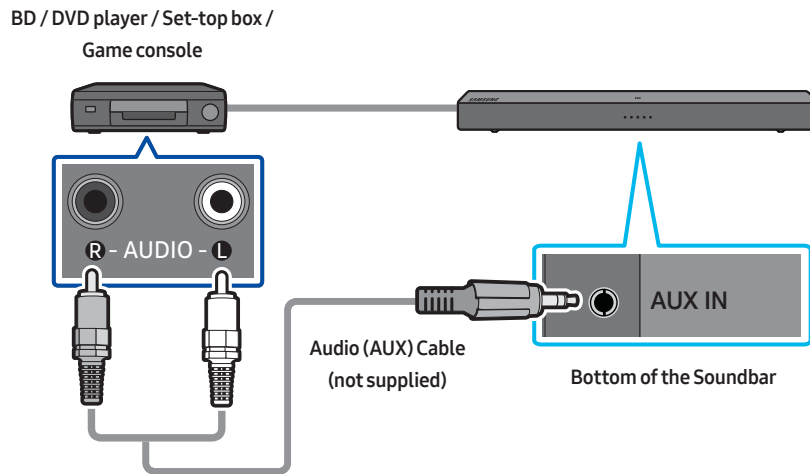

Step 2. Change the Soundbar's mode to AUX

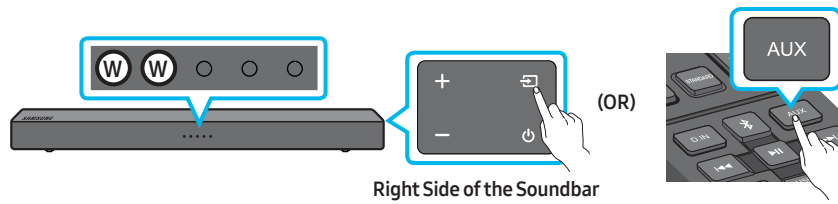

07 CONNECTING A USB STORAGE DEVICE

Step 1. Connect a USB Drive

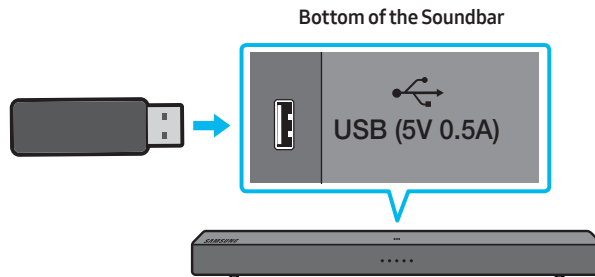

NOTE

- The Soundbar automatically turns off (Auto Power Off) if you do not connect a USB device to the Soundbar within 18 minutes.



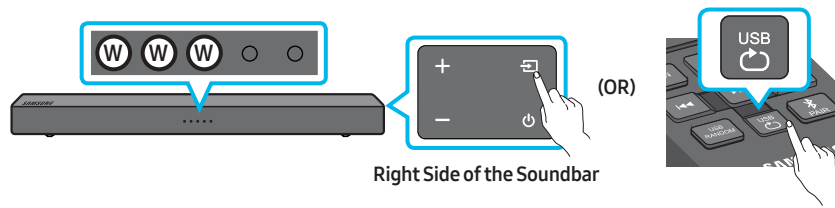

Step 2. Change the Soundbar's mode to USB



Setting Repeat Play Options

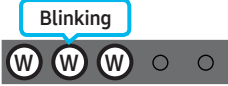

Repeat play

When the Soundbar is in “USB” mode, each time you press the  button the “USB” mode changes how it plays tracks in the following order: “Repeat - Off” > “Repeat - 1 song” > “Repeat - All songs”. See the table below for details.

Mode	Remote control Button	LED indicator
Repeat - Off		
Repeat - 1 song		
Repeat - All songs		

Repeat play at Random

When the Soundbar is in “USB” mode, once you press the  button, the “USB” mode changes how it plays tracks to “Repeat - Random”. See the table below for details.

Mode	Remote control Button	LED indicator
Repeat - Random		

File Format Type Compatibility list

Extension	Codec	Sampling Rate	Bitrate
*.mp3	MPEG 1 Layer2	32kHz ~ 48kHz	32kbps~320kbps
	MPEG 1 Layer3	32kHz ~ 48kHz	32kbps~320kbps
	MPEG 2 Layer3	16kHz ~ 24kHz	8kbps~160kbps
	MPEG 2.5 Layer3	8kHz ~ 12kHz	8kbps~160kbps
*.wma	WMA7/8/9/STD	8kHz ~ 48kHz	32kbps~320kbps
*.aac	AAC	8kHz ~ 96kHz	< 1728kbps
	AAC-LC		
	HE-AAC		
*.ogg	Vorbis codec	(8, 16, 22.05, 32, 44.1, 48)kHz	unsupport ogg: 1. block size 0 < 256, block size 0 > 1024 2. block size 1 < 512, block size 1 > 4096 3. codebook counter > 64 4. codebook entry > 640 5. floor counter > 2 6. floor type 0 7. residua counter > 2 8. dimension != 2 9. mapping counter > 2 10. mode counter > 2 11. residue type != channel number
*.flac	-	8kHz ~ 192kHz	< 5Mbps
*.wav	PCM/LPCM/IMA_ ADPCM/MPEG/MULAW	8kHz ~ 192kHz	< 5Mbps
*.AIFF	Compression type: alwa, ulaw, sowt	(8, 16, 22.05, 32, 44.1, 48, 96, 192)kHz ≤ 2 channels	< 5Mbps

- If there are too many folders (about 256) and files (about 999) stored on the USB device, it may take the Soundbar some time to access and play files.

08 SYSTEM RESET

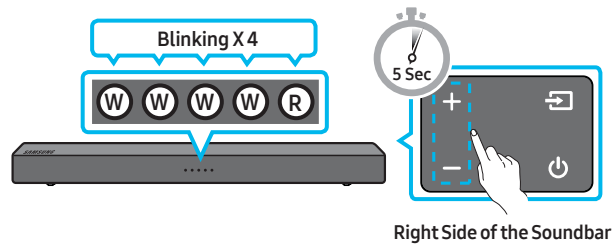

With the Soundbar on, press the **+ - (Volume)** buttons on the body at the same time for at least 5 seconds.

CAUTION

- All the settings of the Soundbar are reset. Be sure to perform this only when reset is required.

09 INSTALLING THE WALL MOUNT (OPTIONAL)

Installation Precautions

- Install on a vertical wall only.
- Do not install in a place with high temperature or humidity.
- Verify whether the wall is strong enough to support the product's weight. If not, reinforce the wall or choose another installation point.
- Purchase and use the fixing screws or anchors appropriate for the kind of wall you have (plaster board, iron board, wood, etc.).
If possible, fix the support screws into wall studs.
- Purchase wall mounting screws according to the type and thickness of the wall you want to mount the Soundbar on.
 - Diameter: M4
 - Length: 1.6 inches or longer recommended.
- Connect cables from the unit to external devices before you install the Soundbar on the wall.
- Make sure the unit is turned off and unplugged from the power source before you install it. Otherwise, it may cause an electric shock.

Wall mount Components

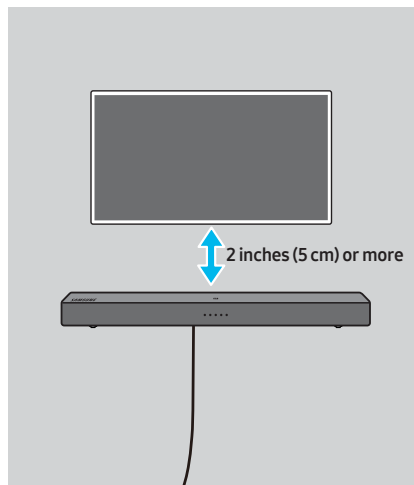

For Installation on Concrete Walls (not supplied)

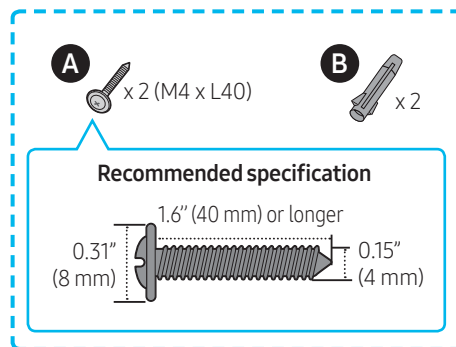

NOTE

- Installations on other types of walls will require different kinds of screws.

1.

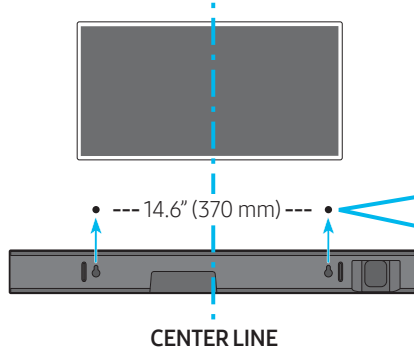

NOTES

- If your TV is installed on the wall, install the Soundbar 2 inches (5 cm) or more below your TV.
- Use a pencil to mark the holes' positions.



2.

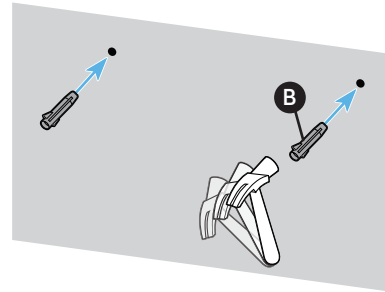
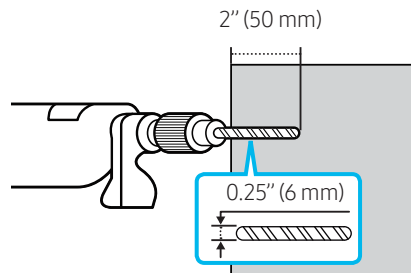

IMPORTANT NOTE

- The installation method shown here is for CONCRETE walls. Installation methods will vary depending on the wall type. For installation on dry wall, we strongly recommend you drill screw support holes into the underlying wood studs.

3.

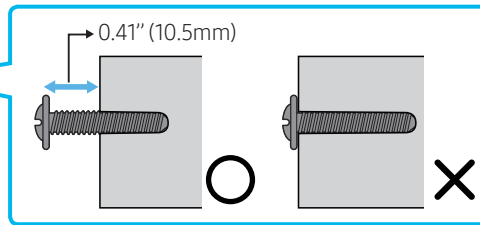
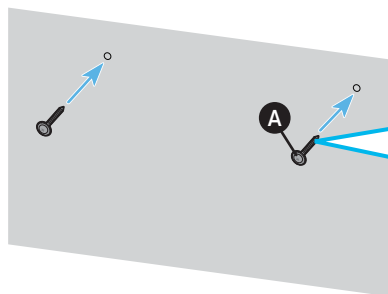

4.

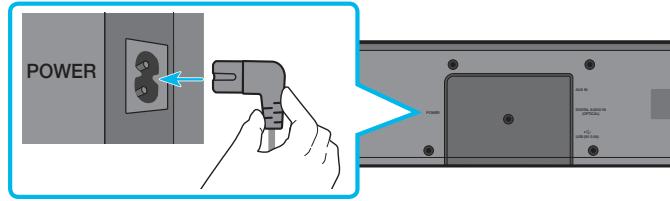

5.

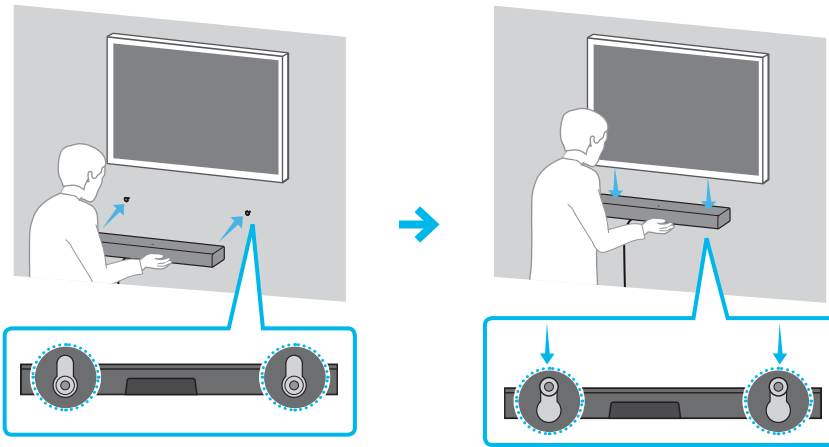

NOTE

- Supports for wall installation are built into the back of the Soundbar.

⚠ CAUTION

- Press the Soundbar down with sufficient force to fix it to the wall. If the Soundbar is not firmly fixed to the wall, it could be accidentally detached, resulting in personal injury.
- Do not bump into or strike the Soundbar (especially from the bottom). The impact could detach the Soundbar from the wall, resulting in personal injury.

10 SOFTWARE UPDATE

Samsung may offer updates for the Soundbar's system firmware in the future.

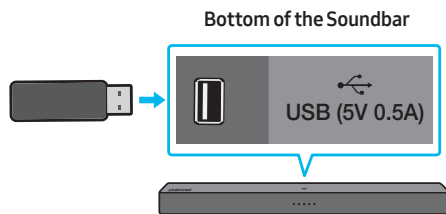

If an update is offered, you can update the firmware by connecting a USB device with the firmware update stored on it to the USB port on your Soundbar. For more information about how to download update files, go to the Samsung Electronics website at (www.samsung.com → Support).

Then, select the product type or enter the model number of your Soundbar, select the Software & Apps option, and then Downloads. Note that the option names can vary.

Update Procedure

Important: The update function erases all user settings. We recommend you write down your settings so that you can easily reset them after the update.

1. Connect a USB thumb drive to the USB port on your computer.

Important: Make sure there are no music files on the USB thumb drive. This may cause the firmware update to fail.

2. Go to <https://www.samsung.com/us/support/downloads/> on your computer → select Enter Model Number and enter the model of your Soundbar. Select manuals and downloads and download the latest software file.
3. Save the downloaded software to a USB stick and select "Extract Here" to unzip the folder.
4. Turn off the Soundbar and connect the USB stick containing the software update to the USB port.
5. Disconnect the power cord, reconnect it, and then turn on the Soundbar.
6. Turn on the Soundbar and select mode to USB. Within 3 minutes, 4 white LEDs on and update begins.
7. When the update complete, the Soundbar turns off. Press the  button on the remote control for 5 seconds. All LEDs blink 4 times and then the Soundbar turns on. The update is complete.
 - If the firmware fails to update, you can update the firmware again.
8. Restore your settings on the Soundbar.

When update fails

1. Turn off the Soundbar, disconnect and then reconnect the USB storage device that contains the update files to the Soundbar's USB port.
2. Disconnect the Soundbar's power cord, reconnect it, and then turn on the Soundbar.

NOTES

- The firmware update may not work properly if audio files supported by the Soundbar are stored in the USB storage device.
- Do not disconnect the power or remove the USB device while updates are being applied. The main unit will turn off automatically after completing the firmware update.
- After the update is completed, the user setup in the Soundbar is initialized so you can reset your settings. We recommend you write down your settings so that you can easily reset them after the update. If the software update fails, check if the USB stick is defective.
- Mac OS users should use MS-DOS (FAT) as the USB format.
- Updating via USB may not be available, depending on the USB storage device manufacturer.

11 TROUBLESHOOTING

Refer to the table below if this product does not function properly. If the problem you are experiencing is not listed below or if the instructions below do not help, turn off the product, disconnect the power cord, and contact Samsung Electronics at 1-800-SAMSUNG (1-800-726-7864).

In case the power is not turned on

- Check whether the power cord of the Soundbar is correctly inserted into the outlet.

In case the functions do not work properly

- After removing the power cord, insert it again.
- Remove the power cord from the external device and try again.
- If there is no signal, the Soundbar automatically turns off after a certain period of time. Turn on the power. (See page 13.)

In case the remote control does not work

- Operate the remote control noting the Soundbar closely.
- Replace the batteries with new ones.

In case the Soundbar sound is not output

- The volume of the Soundbar is too low or muted. Adjust the volume.
- When any external device (STB, Bluetooth device, mobile device, etc.) is connected, adjust the volume of the external device.
- For sound output of the TV, select Soundbar. (Samsung TV: Home (🏠) → Settings (⚙️) → Sound → Sound Output → Select Soundbar)
- The cable connection to the Soundbar may not be loose. Remove the cable and connect again.
- Remove the power cord completely, reconnect, and turn the power on.
- Reset the product and try again. (See page 35.)

In case Bluetooth connection is not possible

- Press the **PAIR** button to pair a new.
- If the Soundbar is connected to another device, disconnect that device first to switch the device.
- Reconnect it after removing the Bluetooth speaker list on the device to connect. (Samsung TV: Home (🏠) → Settings (⚙️) → Sound → Sound Output → Bluetooth Speaker List)
- Remove and reconnect the power plug, then try again.
- Reset the product and try again. (See page 35.)

In case Bluetooth sound breaking occurs

- Sounds may be breaking due to interference by radio frequency or electronic devices nearby. Keep such devices away from the Soundbar to avoid radio interference. Example: microwave ovens.
- Because the device to connect is far away from the Soundbar, sound breaking may occur. Move the device near the Soundbar.
- If a part of your body is in contact with the Bluetooth transceiver or the product is installed on metal furniture, sound breaking may occur. Check the installation environment and conditions for use.

In case the Soundbar is not turned on as soon as the TV is turned on

- When you turn off the Soundbar while watching TV, power synchronization with the TV is disabled. First turn off the TV.

12 LICENSE



Manufactured under license from Dolby Laboratories. Dolby, Dolby Audio and the double-D symbol are trademarks of Dolby Laboratories Licensing Corporation.



For DTS patents, see <http://patents.dts.com>. Manufactured under license from DTS Licensing Limited. DTS, the Symbol, DTS in combination with the Symbol, and DTS 2.0 Channel are registered trademarks or trademarks of DTS, Inc. in the United States and/or other countries. © DTS, Inc. All Rights Reserved.



The Bluetooth® word mark and logos are registered trademarks owned by the Bluetooth SIG, Inc. and any use of such marks by Samsung Electronics Co., Ltd. is under license. Other trademarks and trade names are those of their respective owners.

13 OPEN SOURCE LICENSE NOTICE

To send inquiries and requests for questions regarding open sources, contact Samsung Open Source (<http://opensource.samsung.com>)

14 IMPORTANT NOTES ABOUT SERVICE

- Figures and illustrations in this User Manual are provided for reference only and may differ from actual product appearance.
- An administration fee may be charged if either:
 - a. An engineer is called out to your home at your request and there is no defect in the product.
 - b. You bring the unit to a repair center and there is no defect in the product.
- You will be advised of the amount of the administration fee before any work is done or a home visit is made.
- If you have a problem with this product, we strongly recommend you read the appropriate section of this manual, visit the Support page for your product at www.samsung.com, or call Samsung Product Support (1-800-726-7864) to find an answer before you contact a service center for a repair.

15 SPECIFICATIONS AND GUIDE

Specifications

Model Name	HW-A40R
USB	5V/0.5A
Weight	4.4 lbs (2.0 kg)
Dimensions (W x H x D)	25.2 x 2.6 x 4.2 inches (641.0 x 65.0 x 107.0 mm)
Operating Temperature Range	+41°F to +95°F (+5°C to +35°C)
Operating Humidity Range	10 % ~ 75 %
Supported play formats (DTS 2.0 sound is played in DTS format.)	LPCM 2ch, Dolby Audio™ (supporting Dolby® Digital), DTS
Wireless Surround Speaker SET Name	SWA-8500
Weight	
Wireless Receiver Module	1.5 lbs (0.7 kg)
Surround Speaker	1.1 lbs (0.5 kg)
Dimensions (W x H x D)	
Wireless Receiver Module	2.0 x 7.9 x 5.2 inches (50.0 x 201.0 x 132.0 mm)
Surround Speaker	3.0 x 5.0 x 3.0 inches (76.0 x 127.0 x 76.0 mm)
Operating Temperature Range	+41°F to +95°F (+5°C to +35°C)
Operating Humidity Range	10 % ~ 75 %
Frequency range	20Hz-20kHz

NOTES

- Samsung Electronics Co., Ltd reserves the right to change the specifications without notice.
- Weight and dimensions are approximate.

LIMITED WARRANTY TO ORIGINAL PURCHASER

This SAMSUNG brand product, as supplied and distributed by SAMSUNG and delivered new, in the original carton to the original consumer purchaser, is warranted by SAMSUNG against manufacturing defects in materials and workmanship for a limited warranty period of:

One (1) Year Parts and Labor*

(*90 Days Parts and Labor for Commercial Use)

This limited warranty begins on the original date of purchase, and is valid only on products purchased and used in the United States. To receive warranty service, the purchaser must contact SAMSUNG for problem determination and service procedures. Warranty service can only be performed by a SAMSUNG authorized service center. The original dated bill of sale must be presented upon request as proof of purchase to SAMSUNG or SAMSUNG's authorized service center. Transportation of the product to and from the service center is the responsibility of the purchaser. SAMSUNG will repair or replace this product, at our option and at no charge as stipulated herein, with new or reconditioned parts or products if found to be defective during the limited warranty period specified above. All replaced parts and products become the property of SAMSUNG and must be returned to SAMSUNG. Replacement parts and products assume the remaining original warranty, or ninety (90) days, whichever is longer. SAMSUNG's obligations with respect to software products distributed by SAMSUNG under the SAMSUNG brand name are set forth in the applicable end user license agreement. Non-SAMSUNG hardware and software products, if provided, are on an "AS IS" basis.

Non-SAMSUNG manufacturers, suppliers, publishers, and service providers may provide their own warranties. This limited warranty covers manufacturing defects in materials and workmanship encountered in normal, and except to the extent otherwise expressly provided for in this statement, noncommercial use of this product, and shall not apply to the following, including, but not limited to: damage which occurs in shipment; delivery and installation; applications and uses for which this product was not intended; altered product or serial numbers; cosmetic damage or exterior finish; accidents, abuse, neglect, fire, water, lightning or other acts of nature; use of products, equipment, systems, utilities, services, parts, supplies, accessories, applications, installations, repairs, external wiring or connectors not supplied and authorized by SAMSUNG, or which damage this product or result in service problems; incorrect electrical line voltage, fluctuations and surges; customer adjustments and failure to follow operating instructions, cleaning, maintenance and environmental instructions that are covered and prescribed in the instruction book; product removal or reinstallation; reception problems and distortion related to noise, echo, interference or other signal transmission and delivery problems. SAMSUNG does not warrant uninterrupted or error-free operation of the product.

THERE ARE NO EXPRESS WARRANTIES OTHER THAN THOSE LISTED AND DESCRIBED ABOVE, AND NO WARRANTIES WHETHER EXPRESS OR IMPLIED, INCLUDING, BUT NOT LIMITED TO, ANY IMPLIED WARRANTIES OF MERCHANTABILITY OR FITNESS FOR A PARTICULAR PURPOSE, SHALL APPLY AFTER THE EXPRESS WARRANTY PERIODS STATED ABOVE, AND NO OTHER EXPRESS WARRANTY OR GUARANTY GIVEN BY ANY PERSON, FIRM OR CORPORATION WITH RESPECT TO THIS PRODUCT SHALL BE BINDING ON SAMSUNG. SAMSUNG SHALL NOT BE LIABLE FOR LOSS OF REVENUE OR PROFITS, FAILURE TO REALIZE SAVINGS OR OTHER BENEFITS, OR ANY OTHER SPECIAL, INCIDENTAL OR CONSEQUENTIAL DAMAGES CAUSED BY THE USE, MISUSE OR INABILITY TO USE THIS PRODUCT, REGARDLESS OF THE LEGAL THEORY ON WHICH THE CLAIM IS BASED, AND EVEN IF SAMSUNG HAS BEEN ADVISED OF THE POSSIBILITY OF SUCH DAMAGES. NOR SHALL RECOVERY OF ANY KIND AGAINST SAMSUNG BE GREATER IN AMOUNT THAN THE PURCHASE PRICE OF THE PRODUCT SOLD BY SAMSUNG AND CAUSING THE ALLEGED DAMAGE. WITHOUT LIMITING THE FOREGOING, PURCHASER ASSUMES ALL RISK AND LIABILITY FOR LOSS, DAMAGE OR INJURY TO PURCHASER AND PURCHASER'S PROPERTY AND TO OTHERS AND THEIR PROPERTY ARISING OUT OF THE USE, MISUSE OR INABILITY TO USE THIS PRODUCT SOLD BY SAMSUNG NOT CAUSED DIRECTLY BY THE NEGLIGENCE OF SAMSUNG. THIS LIMITED WARRANTY SHALL NOT EXTEND TO ANYONE OTHER THAN THE ORIGINAL PURCHASER OF THIS PRODUCT, IS NONTRANSFERABLE AND STATES YOUR EXCLUSIVE REMEDY.

Some states do not allow limitations on how long an implied warranty lasts, or the exclusion or limitation of incidental or consequential damages, so the above limitations or exclusions may not apply to you. This warranty gives you specific legal rights, and you may also have other rights which vary from state to state.

To obtain warranty service, please contact SAMSUNG customer care center.

The benefits of this Limited Warranty extend only to the original purchaser of Samsung products from an authorized Samsung reseller. THIS LIMITED WARRANTY SHALL NOT APPLY TO ANY SAMSUNG PRODUCTS PURCHASED FROM UNAUTHORIZED RESELLERS OR RETAILERS, EXCEPT IN STATES WHERE SUCH RESTRICTION MAY BE PROHIBITED. For a list of Samsung authorized retailers, please go to: http://www.samsung.com/us/peaceofmind/authorized_resellers.html.

SAMSUNG

QUESTIONS OR COMMENTS?

Country	Samsung Service Center 📞	Web Site	Address
IN THE US	1-800-SAMSUNG (726-7864)	www.samsung.com/us/support	Samsung Electronics America, Inc. 85 Challenger Road Ridgefield Park, NJ 07660

© 2021 Samsung Electronics Co., Ltd. All rights reserved.