

1 2 3 4 5 6 7

A

B

C

D

E

A

B

C

D

E

ALL POWER PINS

PIN NAME	VOLTAGE	TYPE	DESCRIPTION
VCCP_5D	+5.0V	RESUME	I/O
VCCP_3E	+3.3V	RESUME	CORE, 32KHZ OSC, USB I/O
UPSPUP	+3.3V	RESUME	WAKE EVENTS, SYSTEM POWER STATE
VCC_5A	+5.0V	NORMAL	5V TOLERANCE FOR PCI, SIO, X BUS, GAME PORT
VCC_F	+5.0V	NORMAL	IDE I/O
VCC_3B	+3.3V	NORMAL	CORE
VCC_3C	+3.3V	NORMAL	CORE, PCI I/O
VCC_G	+2.5V	NORMAL	CPU INTERFACE I/O

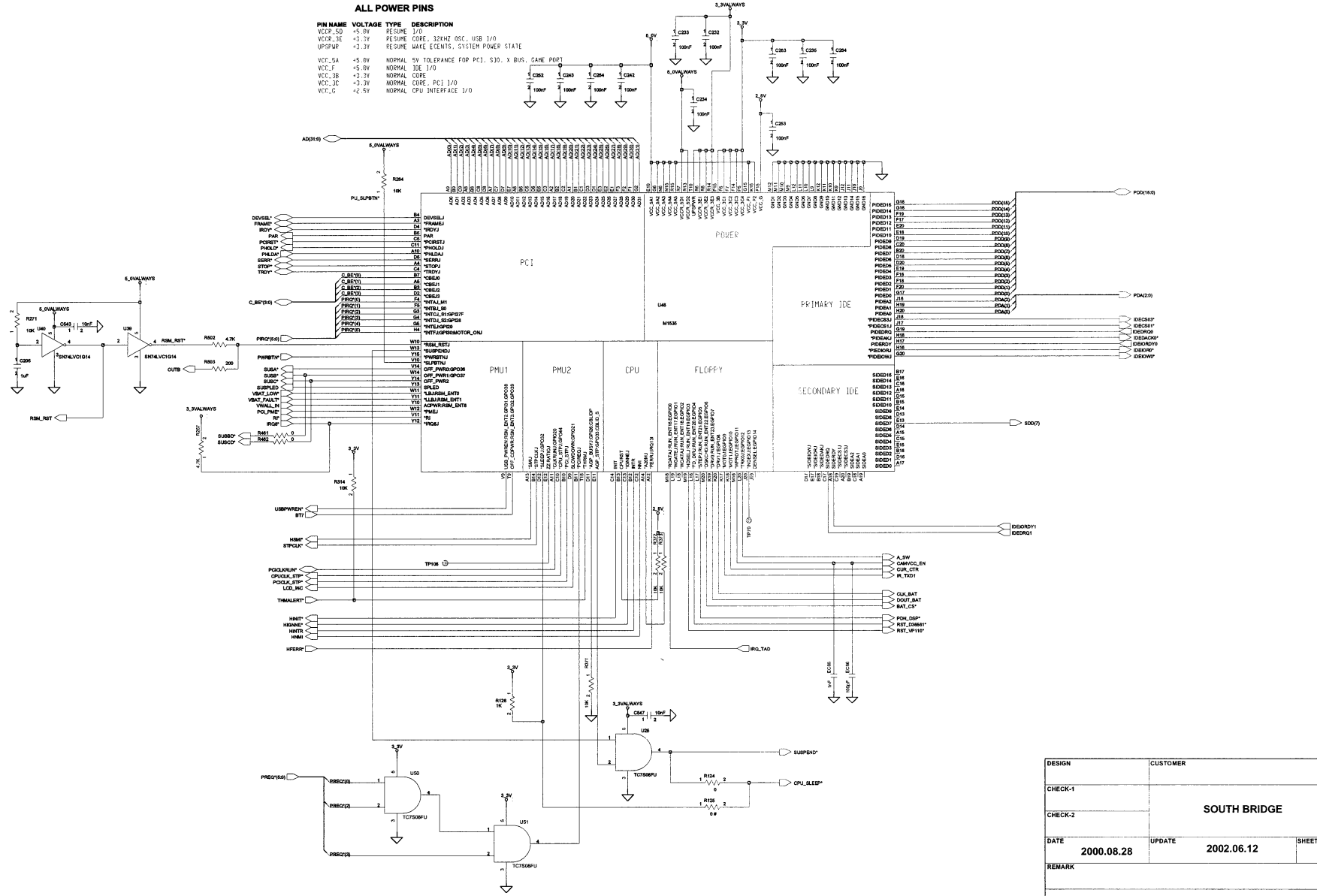

DESIGN	CUSTOMER		
CHECK-1	SOUTH BRIDGE		REV.
CHECK-2			
DATE	2000.08.28	UPDATE	2002.06.12
		SHEET	10
REMARK			
MOBIIS L T D.			

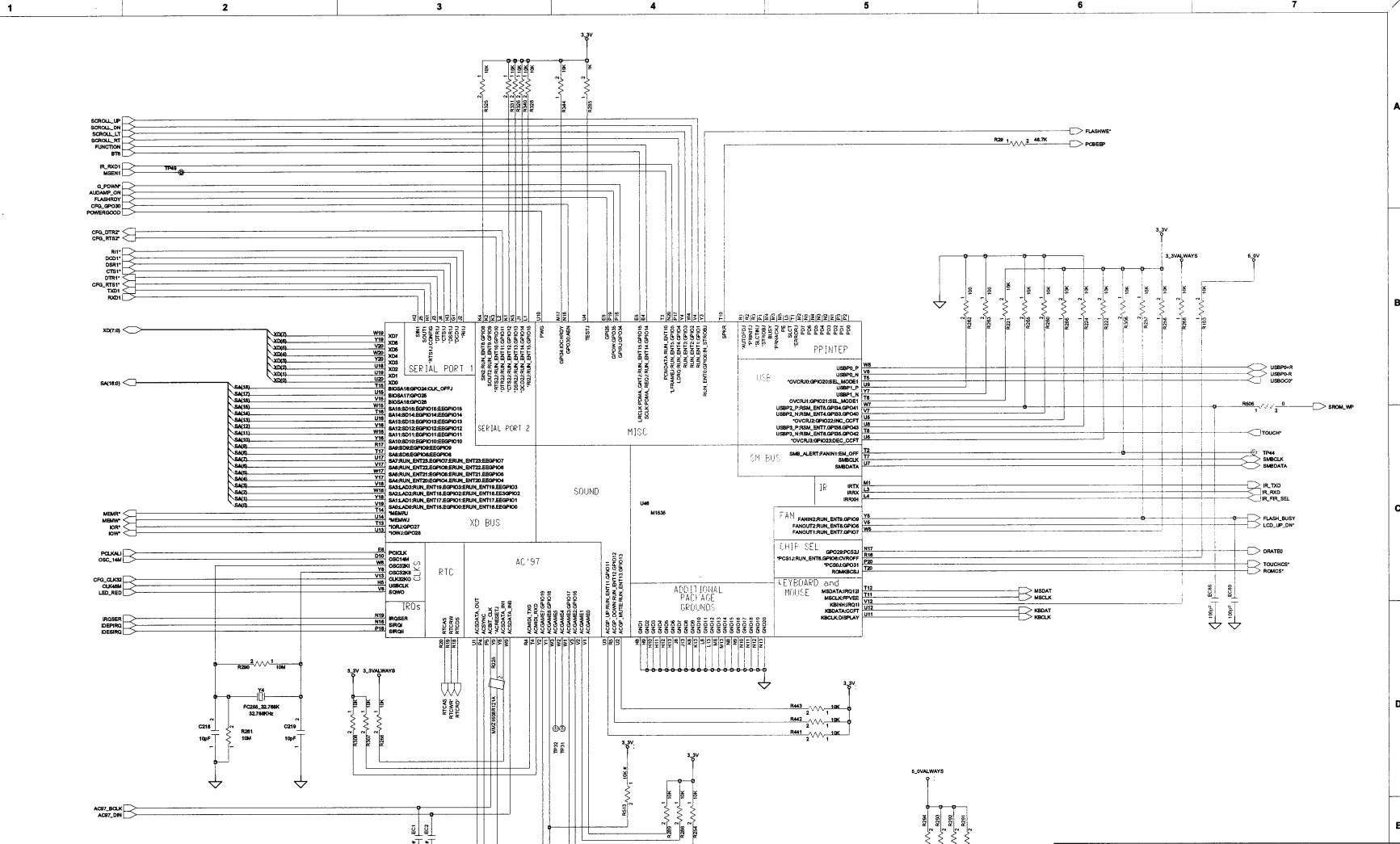

DESIGN	CUSTOMER		REV.
CHECK-1	SOUTH BRIDGE		
CHECK-2			
DATE	2000.08.28	2002.06.12	11
REMARK			
MOBIS L.T.D.			

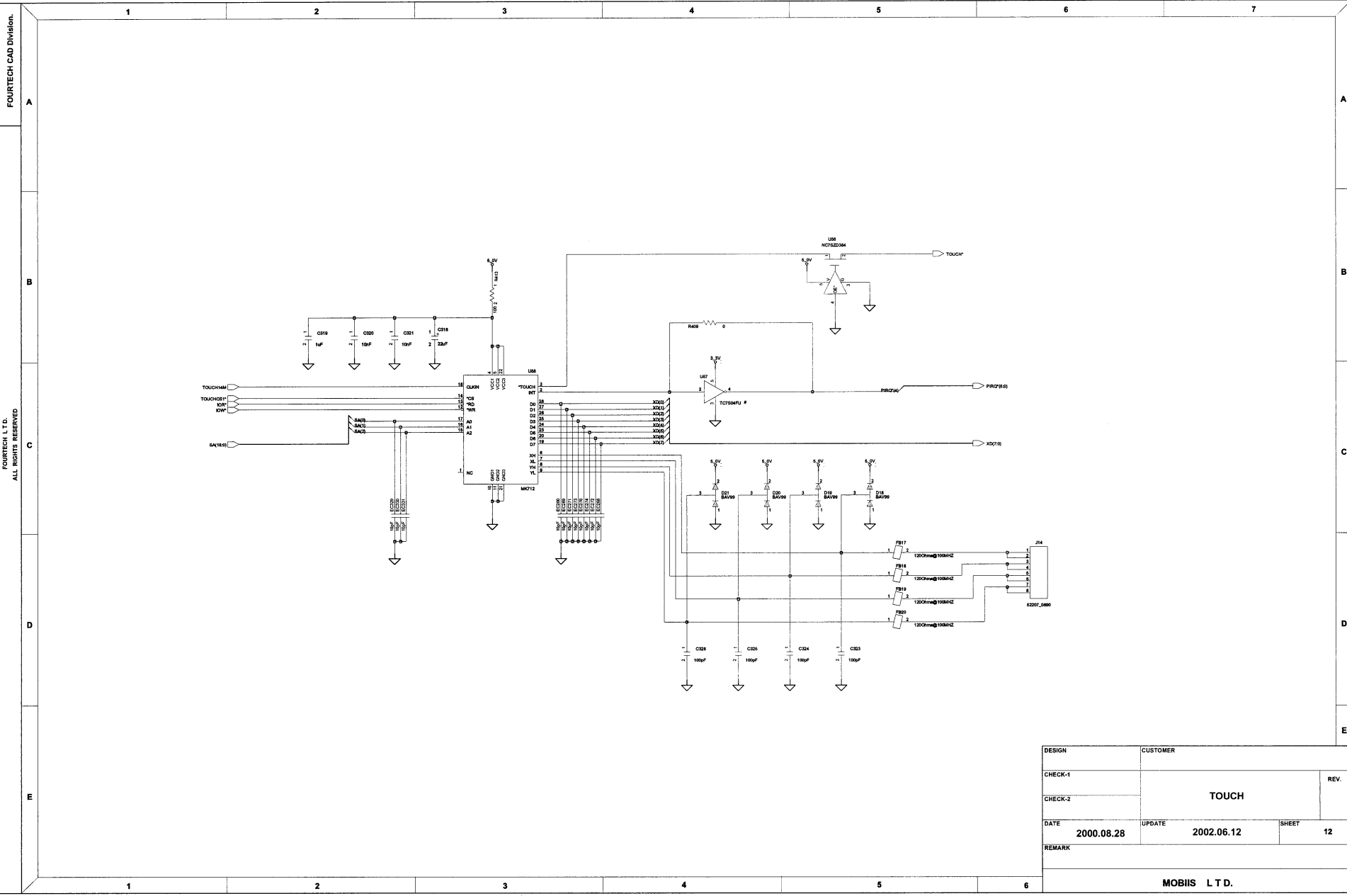

FOURTECH CAD DIVISION.

FOURTECH L.T.D.
ALL RIGHTS RESERVED

DESIGN	CUSTOMER		
CHECK-1			REV.
CHECK-2	TOUCH		
DATE	2000.08.28	UPDATE	2002.06.12
		SHEET	12
REMARK			
MOBIS L.T.D.			

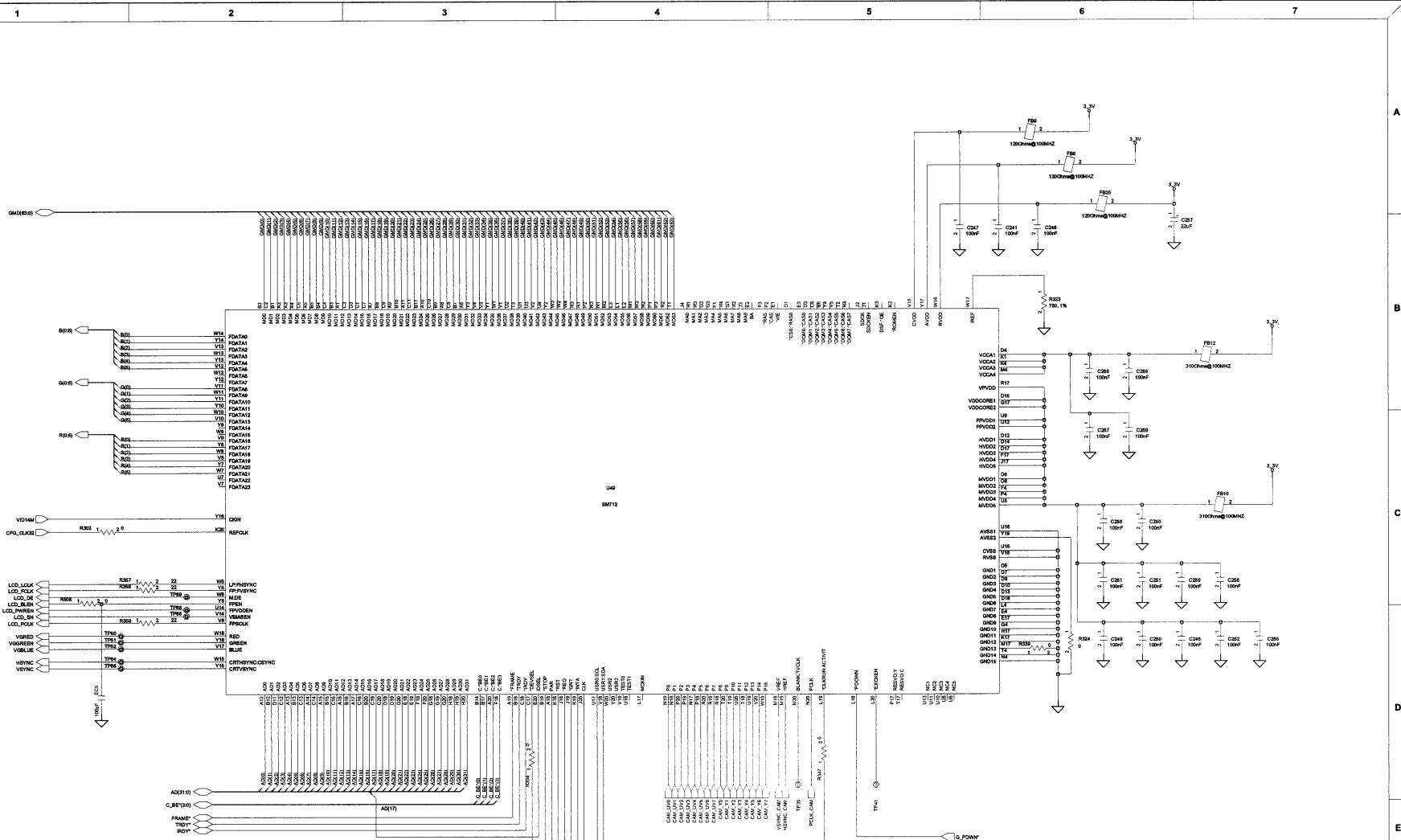

DESIGN	CUSTOMER		REV.
CHECK-1	GRAGHPICS CONTROLLER		
CHECK-2			
DATE	UPDATE		
2000.08.28	2002.06.12		13
REMARK			
MOBIS LTD.			

FOURTECH CAD DIVISION.

FOURTECH LTD. ALL RIGHTS RESERVED.

1 2 3 4 5 6 7

A

B

C

D

E

A

B

C

D

E

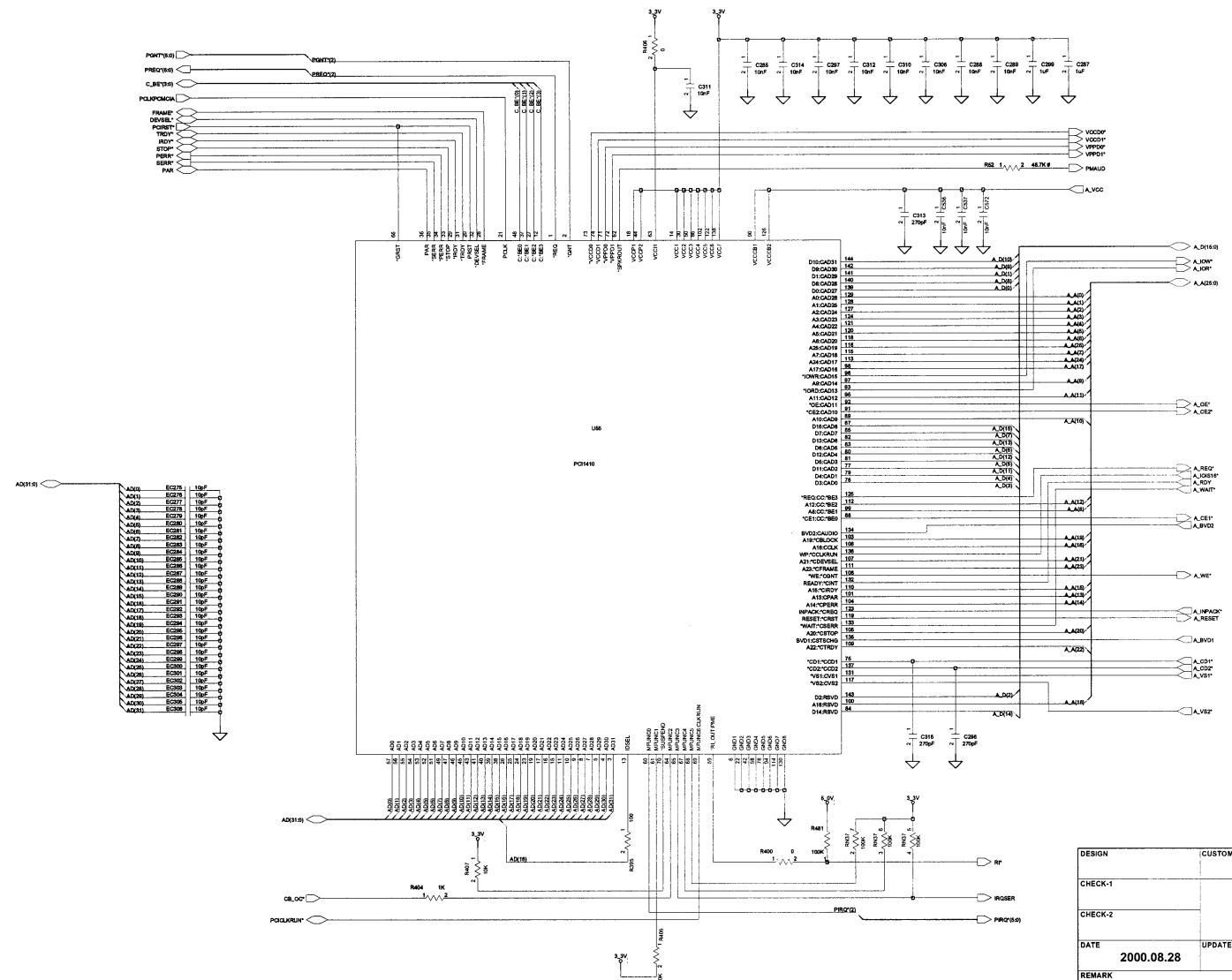

DESIGN	CUSTOMER		REV.
CHECK-1	PCMCIA CONTROLLER		
CHECK-2			
DATE	2000.08.28	UPDATE	2002.06.12
REMARK			SHEET 14
MOBIUS LTD.			

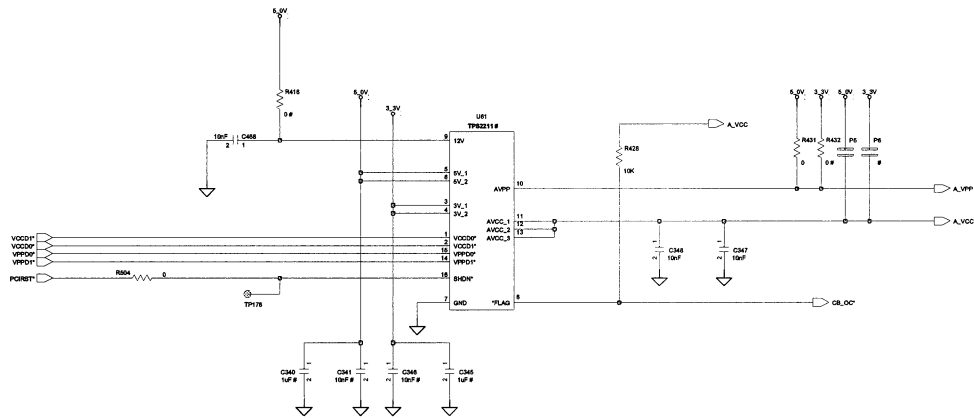

DESIGN	CUSTOMER	
CHECK-1	PCMCIA POWER SWITCH	REV.
CHECK-2		
DATE	UPDATE	SHEET
2000.08.28	2002.06.12	15
REMARK		
MOBIIS L.T.D.		

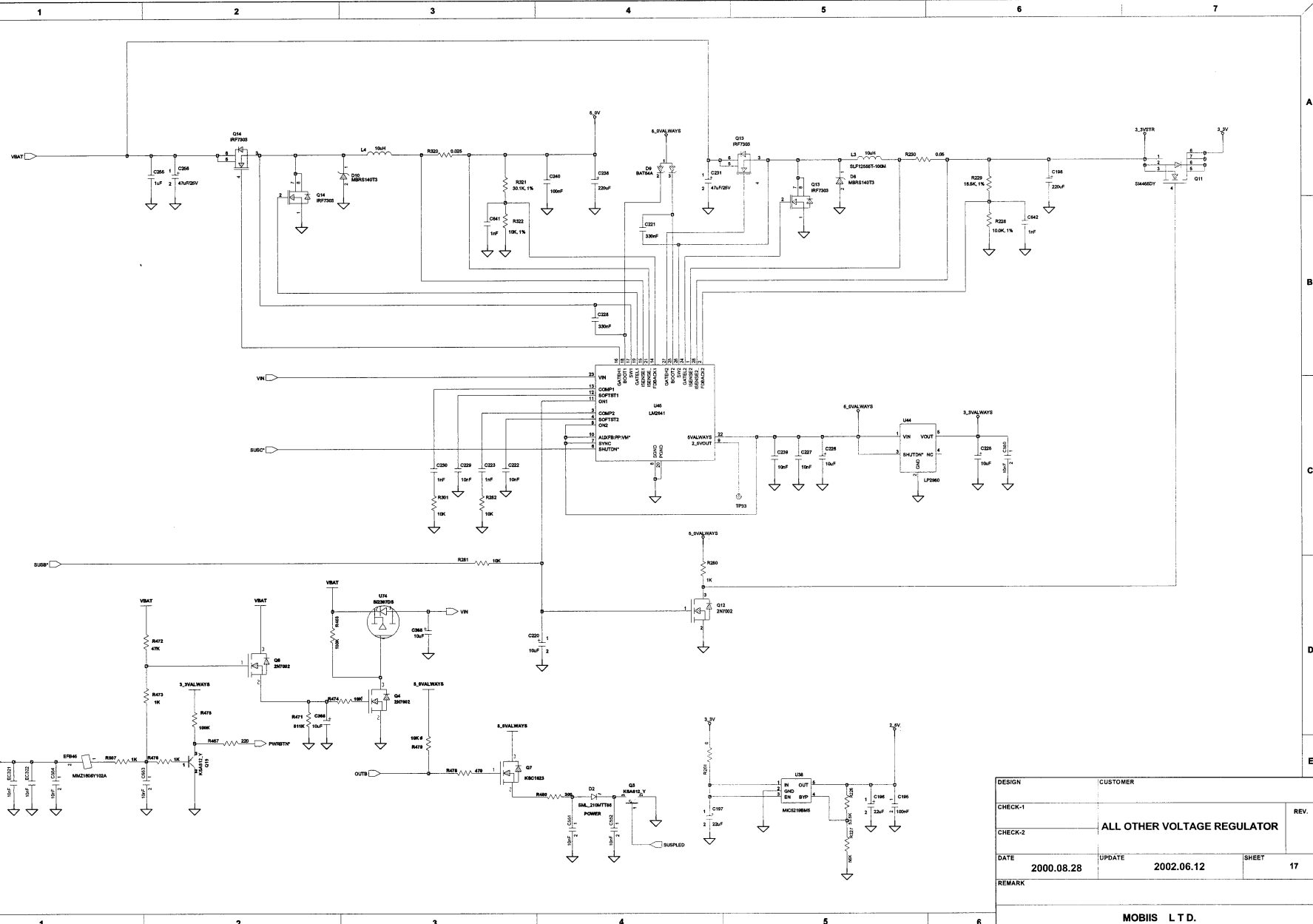

DESIGN	CUSTOMER		REV.
CHECK-1	ALL OTHER VOLTAGE REGULATOR		
CHECK-2			
DATE	UPDATE	SHEET	
2000.08.28	2002.06.12	17	
REMARK			
MOBIS L.T.D.			

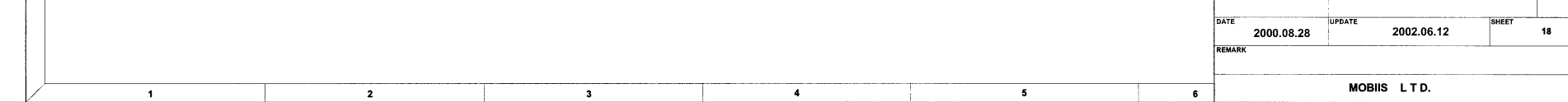
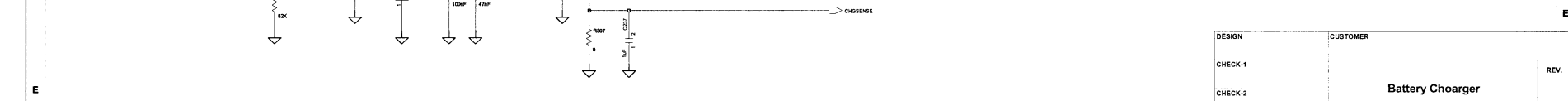
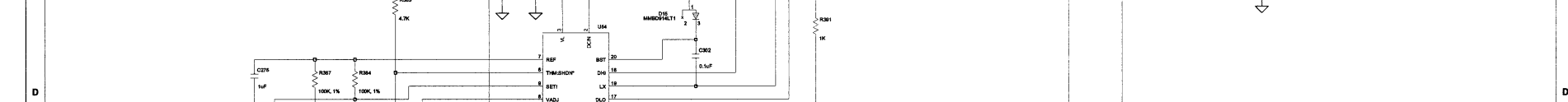
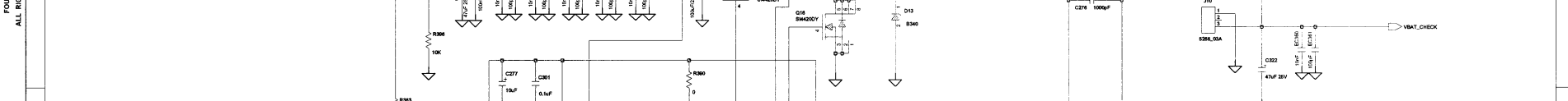
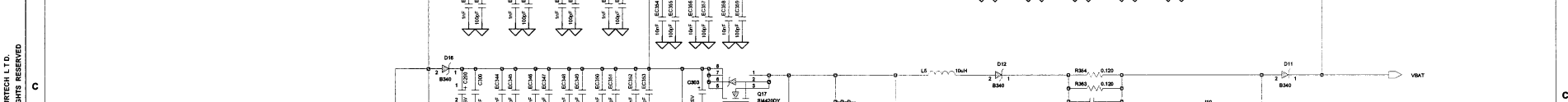
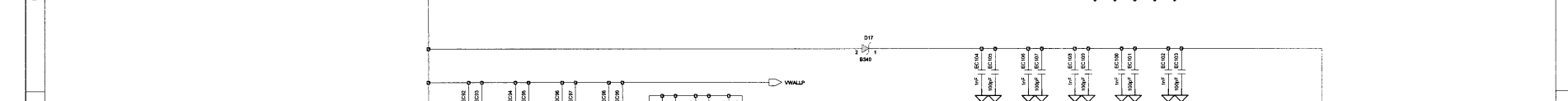

FOURTECH CAD Division.

FOURTECH LTD.
ALL RIGHTS RESERVED.

DESIGN	CUSTOMER		REV.
CHECK-1	Battery Charger		
CHECK-2			
DATE	UPDATE	SHEET	
2000.08.28	2002.06.12	18	
REMARK			

MOBIS L.T.D.

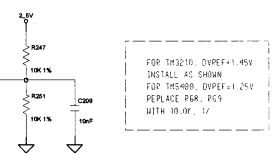
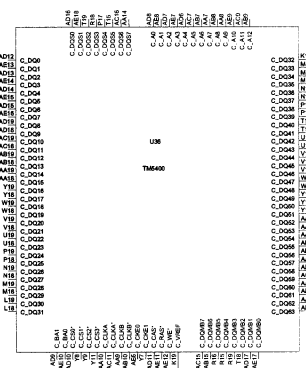

DESIGN	CUSTOMER	
CHECK-1	CPU DDR SDRAM	REV.
CHECK-2		
DATE	UPDATE	SHEET
2000.08.28	2002.10.01	2
REMARK		
MOBIS L.T.D.		

FOURTECH CAD DIVISION

FOURTECH LTD.
ALL RIGHTS RESERVED

1 2 3 4 5 6 7

A

B

C

D

E

A

B

C

D

E

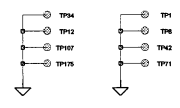
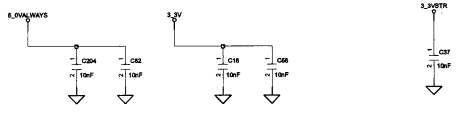
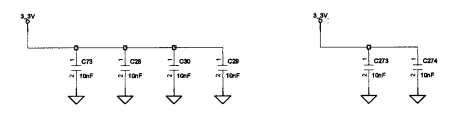
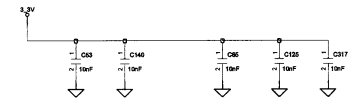
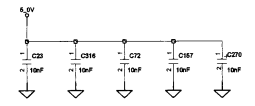

R33 5.1K 10K

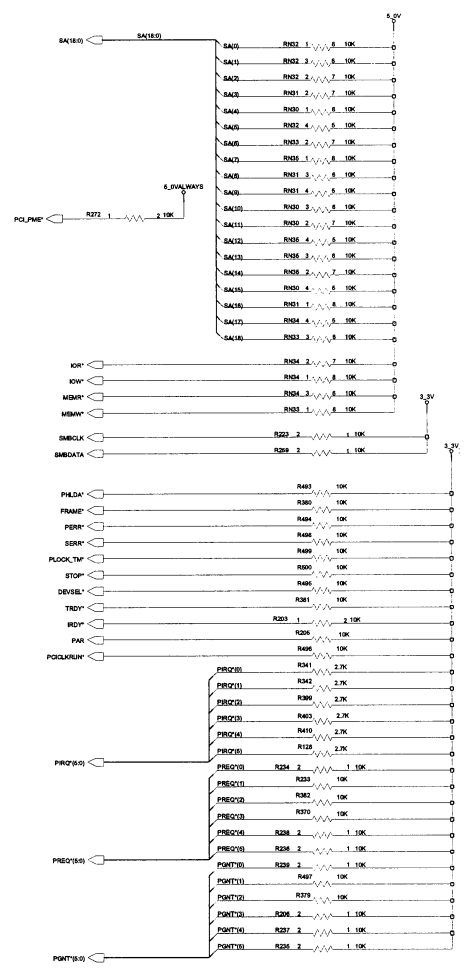

DESIGN	CUSTOMER		REV.
CHECK-1			
CHECK-2	DECOUPLING,PULL_UP, and SPARES		
DATE	UPDATE	SHEET	
2000.08.28	2002.06.12	20	
REMARK			
MOBIS LTD.			

1 2 3 4 5 6 7

1 2 3 4 5 6 7

A B C D E

INSTALL FOR SOFTWARE BRIGHTNESS CONTROL

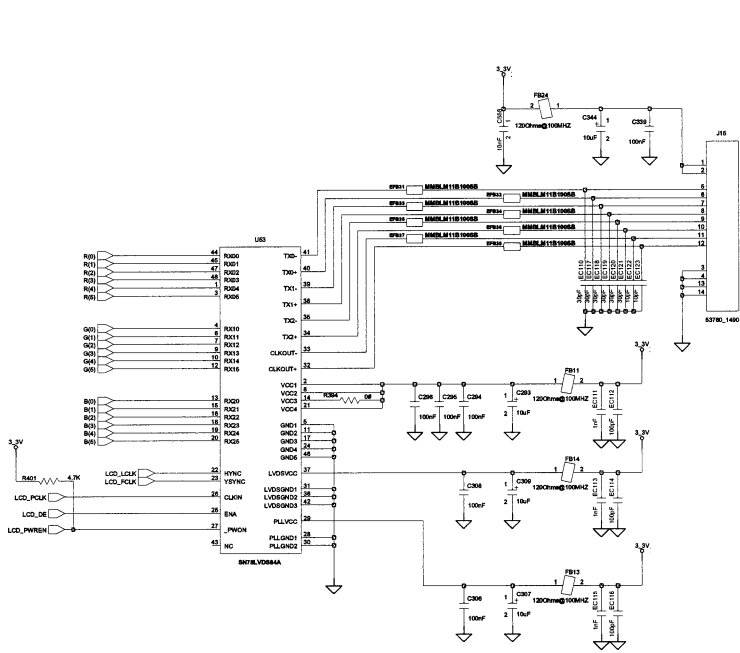
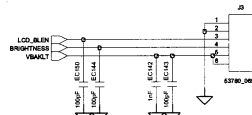
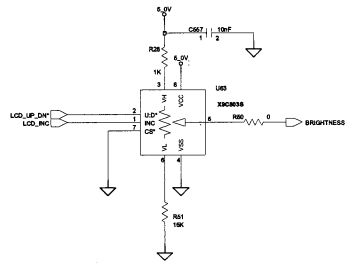

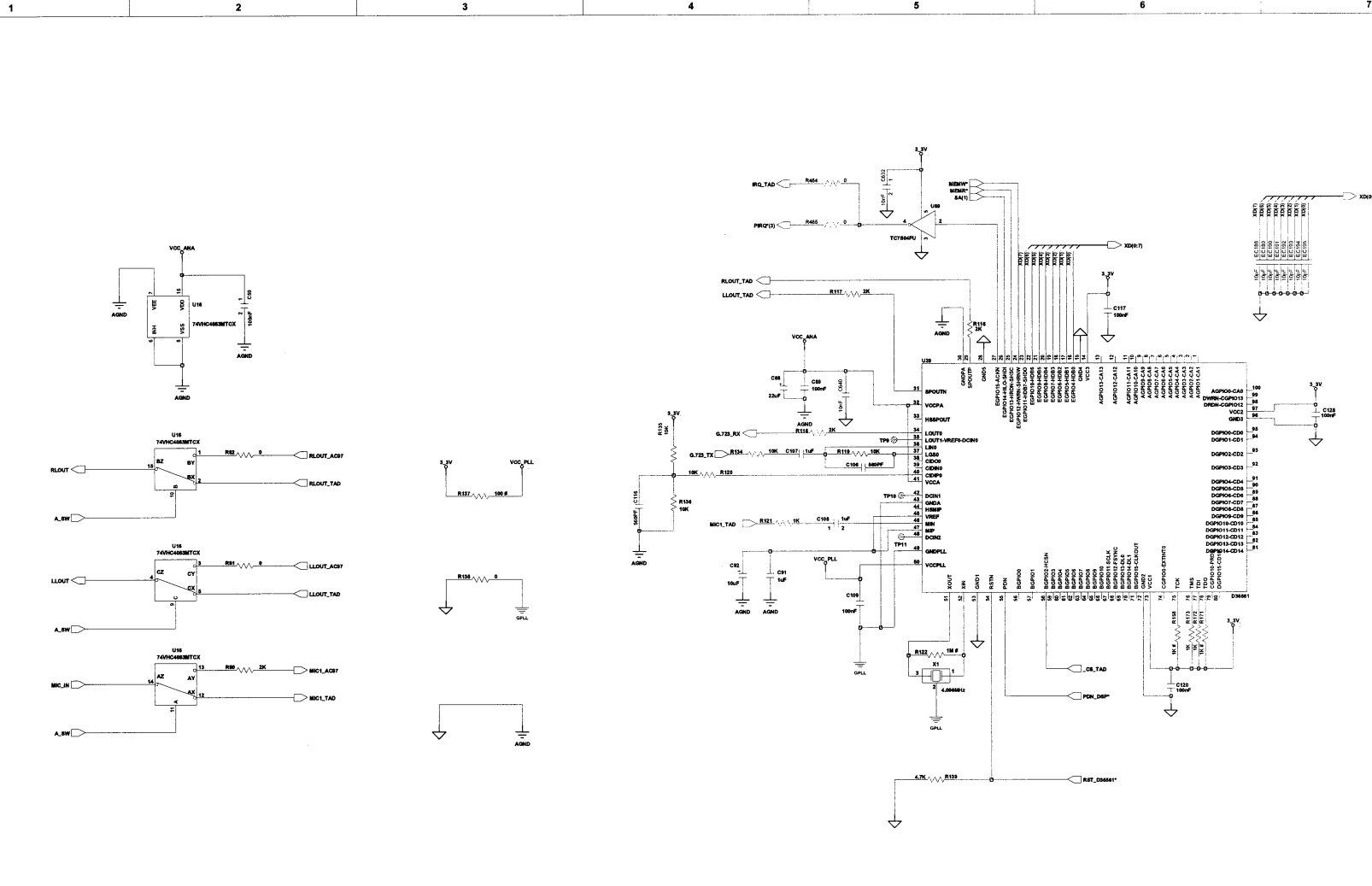

DESIGN		CUSTOMER	
CHECK-1			REV.
CHECK-2		D36561	
DATE	2000.08.28	UPDATE	2002.06.12
REMARK		SHEET	23
MOBIUS L T D.			

1 2 3 4 5 6 7

A

A

B

B

C

C

D

D

E

E

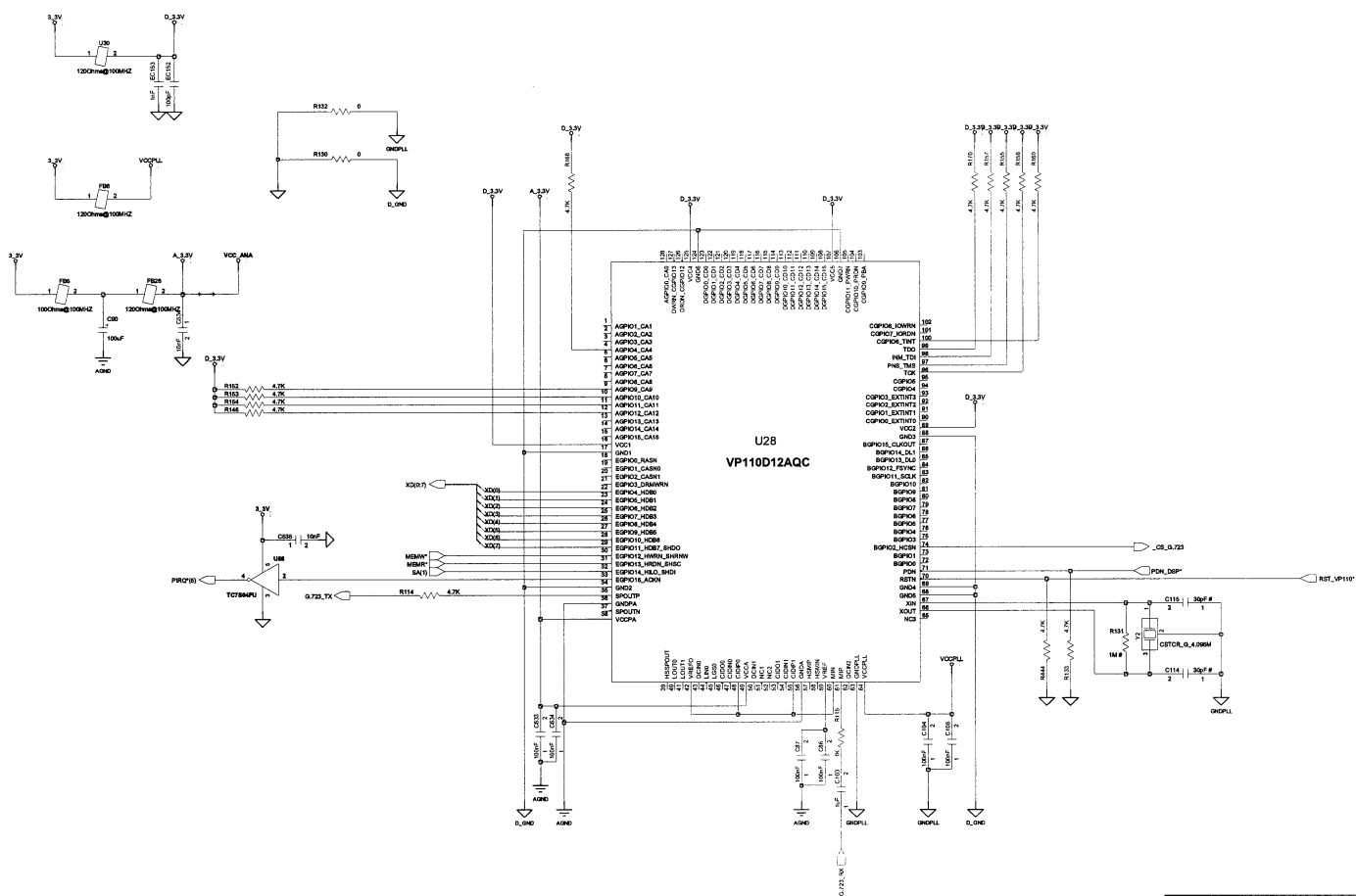

DESIGN	CUSTOMER		
CHECK-1			REV.
CHECK-2	VP110-G.723		
DATE	UPDATE	SHEET	
2000.08.28	2002.06.12	24	
REMARK			
MOBIIS L.T.D.			

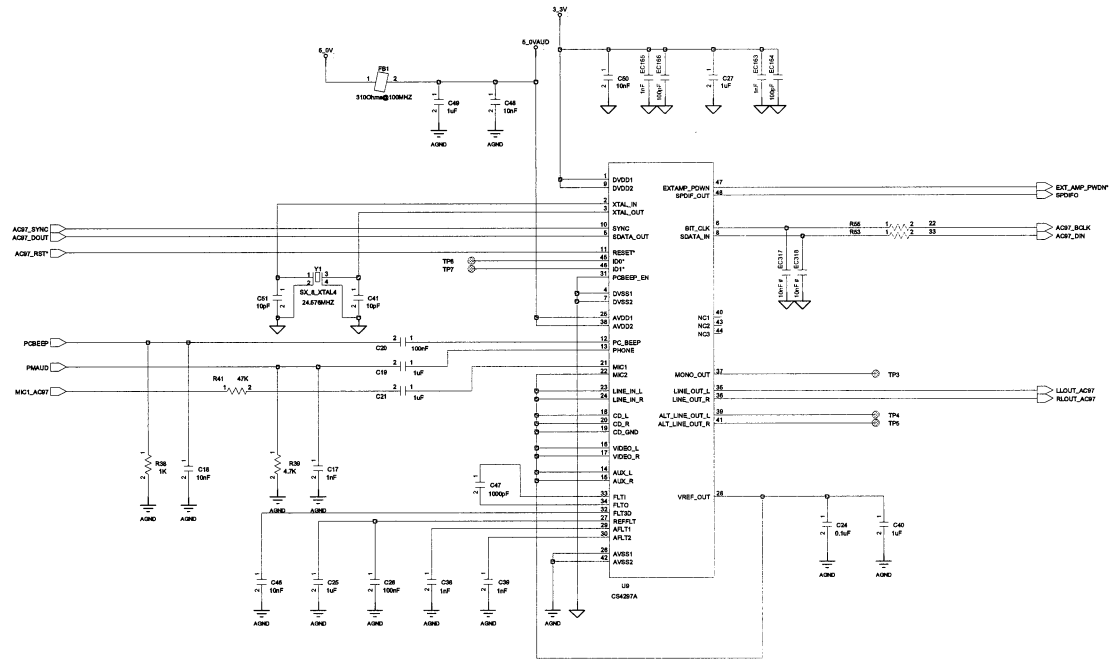

DESIGN		CUSTOMER	
CHECK-1		Audio (CS4297A)	REV.
CHECK-2			
DATE	2000.08.28	UPDATE	2002.06.12
		SHEET	25
REMARK			
MOBIIS L T D.			

1 2 3 4 5 6 7

A

A

B

B

C

C

D

D

E

E

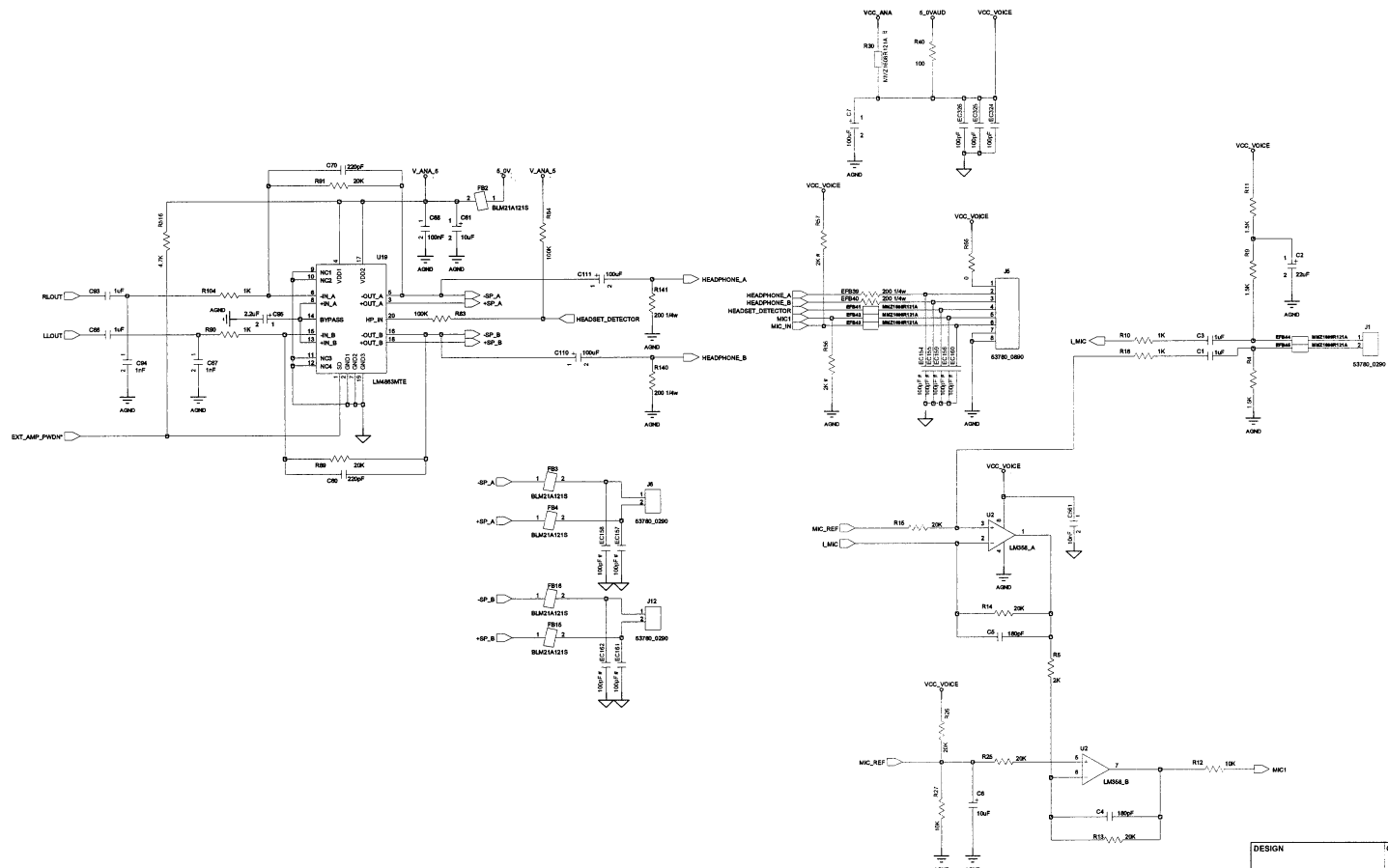

DESIGN	CUSTOMER	
CHECK-1	Audio Amp	REV.
CHECK-2		
DATE	UPDATE	SHEET
2000.08.28	2002.06.12	26
REMARK		
MOBIS L.T.D.		

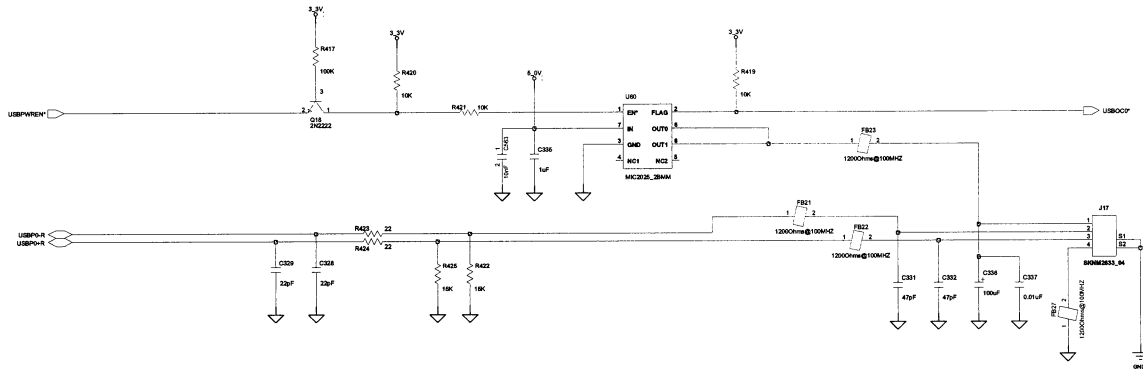

BUTTON AND LED CONNECTOR

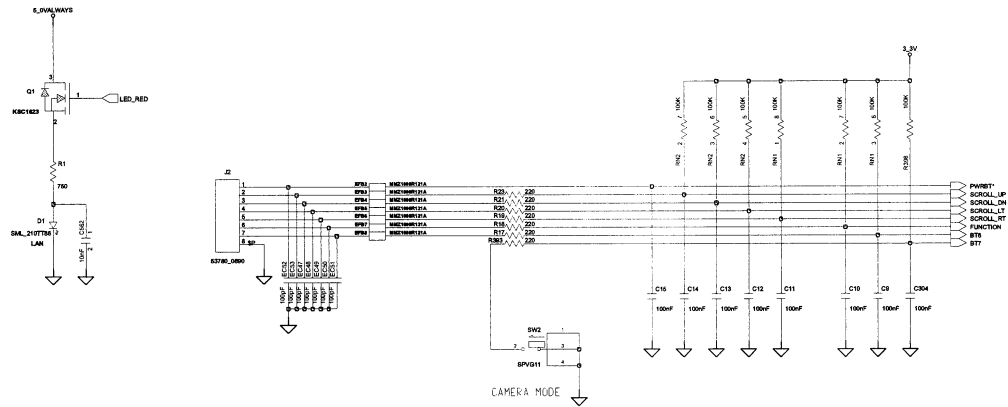

DESIGN	CUSTOMER	
CHECK-1	Key & LED USB Power	REV.
CHECK-2		
DATE	UPDATE	SHEET
2000.08.28	2002.06.12	27
REMARK		
MOBIIS L T D.		

1 2 3 4 5 6 7

A

B

C

D

E

A

B

C

D

E

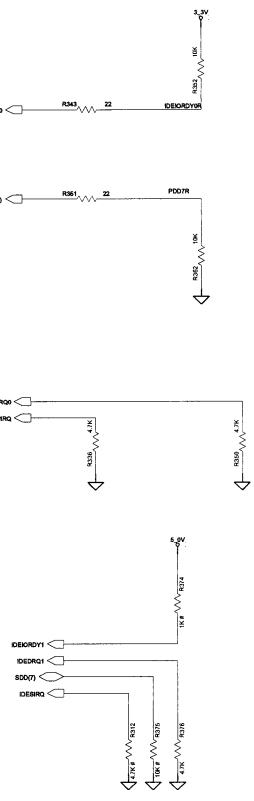
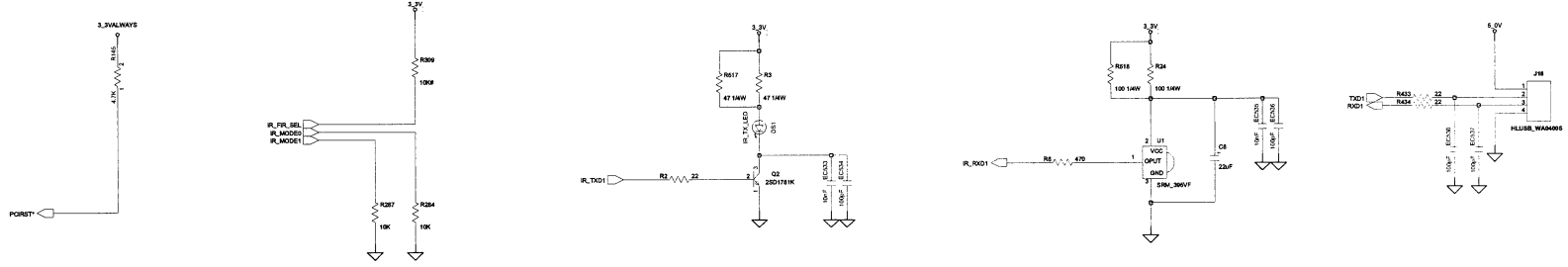

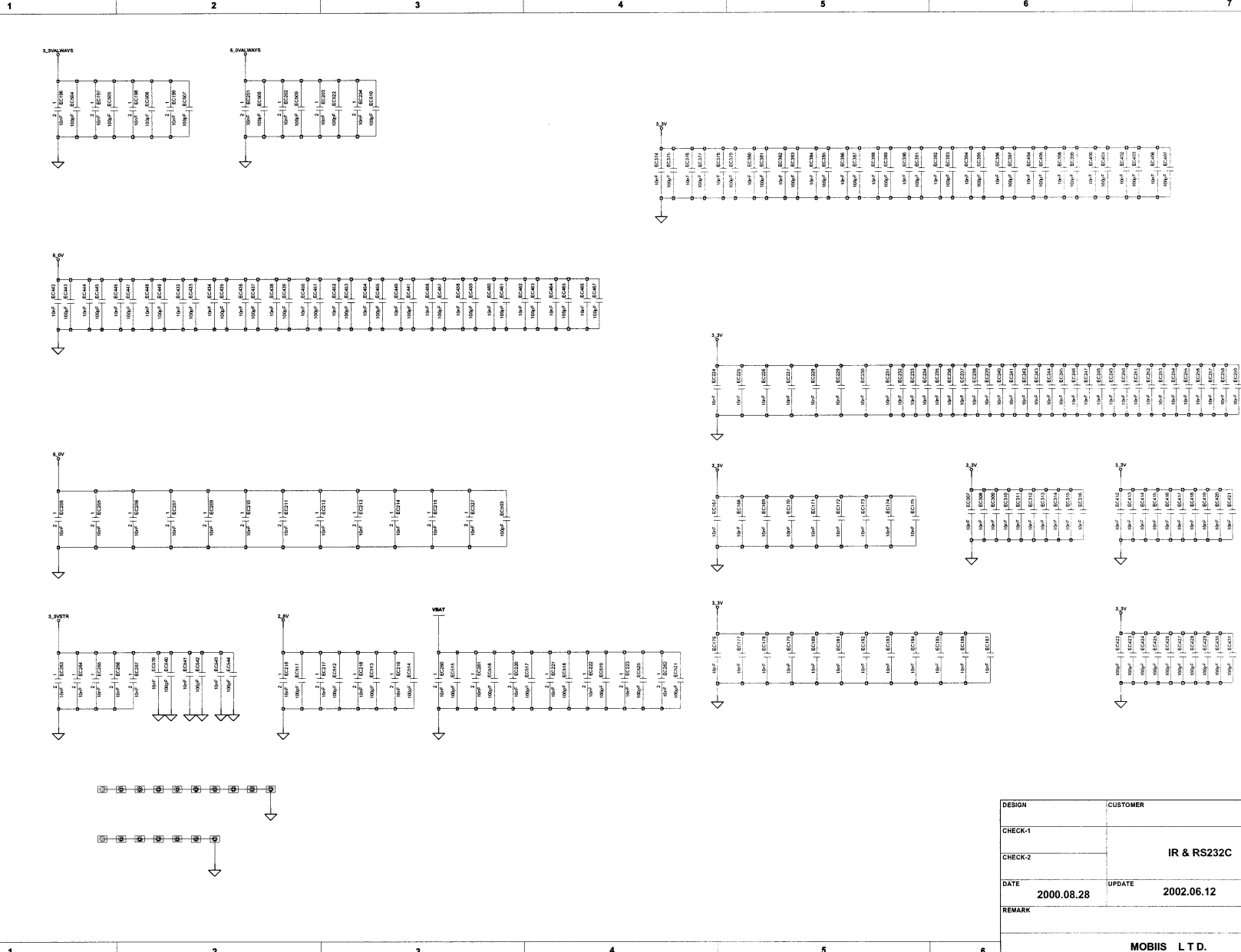

DESIGN	CUSTOMER		REV.
CHECK-1	IR & RS232C		
CHECK-2			
DATE	UPDATE	SHEET	
2000.08.28	2002.06.12	29	
REMARK			
MOBIS LTD.			

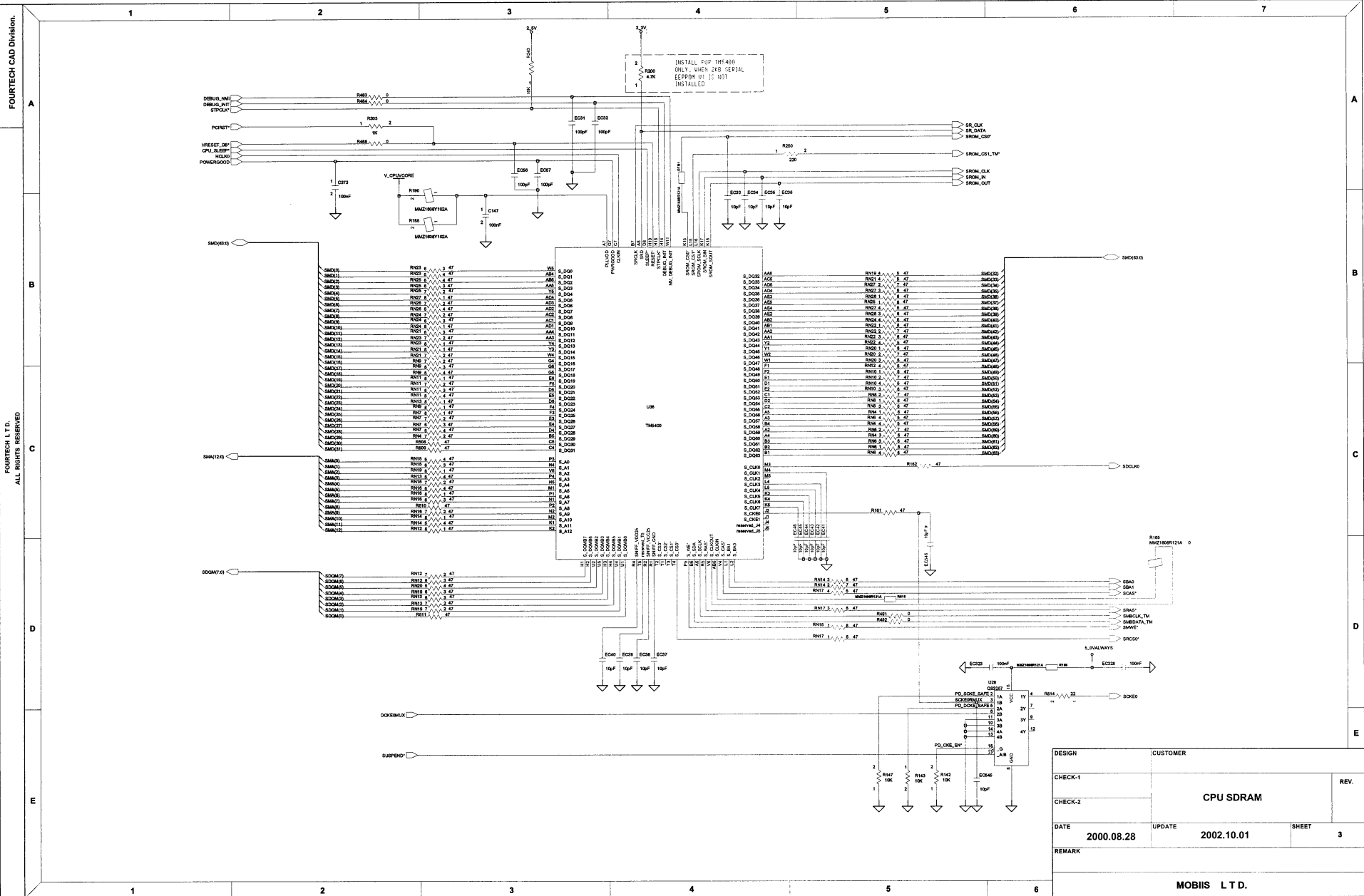

FOURTECH CAD DIVISION.

FOURTECH L.T.D.
ALL RIGHTS RESERVED

DESIGN	CUSTOMER		REV.
CHECK-1	CPU SDRAM		
CHECK-2			
DATE	2000.08.28	UPDATE	2002.10.01
		SHEET	3
REMARK			
MOBIS L.T.D.			