



# HCT CO., LTD.

## CERTIFICATE OF COMPLIANCE FCC Certification

<b>Applicant Name:</b> SAMSUNG Electronics Co., Ltd.	<b>Date of Issue:</b> November 13, 2013
<b>Address:</b> 129, Samsung-ro, Yeongtong-gu Suwon-si, Gyeonggi-do, 443-742 Rep. of Korea	<b>Test Site/Location:</b> 74, Seoicheon-ro 578beon-gil, Majang-myeon, Icheon-si, Gyeonggi-do, Korea
	<b>Report No.:</b> HCTR1311FR04
	<b>HCT FRN:</b> 0005866421

<b>FCC ID:</b>	<b>A3LGTS7580L</b>
<b>APPLICANT:</b>	<b>SAMSUNG Electronics Co., Ltd.</b>

<b>FCC Model(s):</b>	GT-S7580L
<b>EUT Type:</b>	Mobile Phone
<b>FCC Classification:</b>	Licensed Portable Transmitter Held to Ear (PCE)
<b>FCC Rule Part(s):</b>	§22, §24, §2
<b>Tx Frequency:</b>	824.20 - 848.80 MHz (GSM850) 826.40 - 846.60 MHz (WCDMA850) 1 850.20 - 1 909.80 MHz (GSM1900) 1 852.4 - 1 907.6 MHz (WCDMA1900)
<b>Rx Frequency:</b>	869.20 - 893.80 MHz (GSM850) 871.40 - 891.60 MHz (WCDMA850) 1 930.20 - 1 989.80 MHz (GSM1900) 1 932.4 - 1 987.6 MHz (WCDMA1900)
<b>Max. RF Output Power:</b>	0.340 W GSM850 (25.32 dBm) / 1.156 W GSM1900 (30.63 dBm) 0.138 W WCDMA850 (21.39 dBm) / 0.265 W WCDMA1900 (24.24 dBm)
<b>Emission Designator(s):</b>	247 KGXW (GSM850) 247 KGXW (GSM1900) 4M15F9W (WCDMA850) 4M15F9W (WCDMA1900)

The measurements shown in this report were made in accordance with the procedures specified in §2.947. I assume full responsibility for the accuracy and completeness of these measurements, and for the qualifications of all persons taking them.

HCT CO., LTD. Certifies that no party to this application has subject to a denial of Federal benefits that includes FCC benefits pursuant to section 5301 of the Anti-Drug Abuse Act of 1998, 21 U.S. C.853(a)

**Report prepared by**  
**: Kyung Soo Kang**  
**Test engineer of RF Team**

**Approved by**  
**: Chang Seok Choi**  
**Manager of RF Team**

This report only responds to the tested sample and may not be reproduced, except in full, without written approval of the HCT Co., Ltd.

FCC CERTIFICATION REPORT			<a href="http://www.hct.co.kr">www.hct.co.kr</a>
Test Report No. HCTR1311FR04	Date of Issue: November 13, 2013	EUT Type: Mobile Phone	FCC ID: A3LGTS7580

# Version

TEST REPORT NO.	DATE	DESCRIPTION
HCTR1311FR04	November 13, 2013	- First Approval Report

# Table of Contents

1. GENERAL INFORMATION .....		4
2. INTRODUCTION .....		5
2.1. EUT DESCRIPTION.....		5
2.2. MEASURING INSTRUMENT CALIBRATION.....		5
2.3. TEST FACILITY .....		5
3. DESCRIPTION OF TESTS .....		6
3.1 ERP/EIRP RADIATED POWER AND RADIATED SPURIOUS EMISSIONS.....		6
3.2 PEAK- TO- AVERAGE RATIO .....		7
3.3 OCCUPIED BANDWIDTH. ....		9
3.4 SPURIOUS AND HARMONIC EMISSIONS AT ANTENNA TERMINAL.....		10
3.5 FREQUENCY STABILITY / VARIATION OF AMBIENT TEMPERATURE .....		11
4. LIST OF TEST EQUIPMENT .....		12
5. SUMMARY OF TEST RESULTS .....		13
6. SAMPLE CALCULATION .....		14
7. TEST DATA .....		15
7.1 EFFECTIVE RADIATED POWER OUTPUT (GSM / WCDMA) .....		15
7.2 EQUIVALENT ISOTROPIC RADIATED POWER (GSM / WCDMA).....		16
7.3 RADIATED SPURIOUS EMISSIONS.....		17
7.3.1 RADIATED SPURIOUS EMISSIONS (GSM850) .....		17
7.3.2 RADIATED SPURIOUS EMISSIONS(GSM1900) .....		18
7.3.3 RADIATED SPURIOUS EMISSIONS (WCDMA850) .....		19
7.3.4 RADIATED SPURIOUS EMISSIONS (WCDMA1900).....		20
7.4 PEAK-TO-AVERAGE RATIO .....		21
7.5 OCCUPIED BANDWIDTH .....		22
7.6 CONDUCTED SPURIOUS EMISSIONS .....		23
7.6.1 BAND EDGE.....		23
7.7 FREQUENCY STABILITY / VARIATION OF AMBIENT TEMPERATURE .....		24
7.7.1 FREQUENCY STABILITY (GSM850) .....		24
7.7.2 FREQUENCY STABILITY (GSM1900) .....		25
7.7.3 FREQUENCY STABILITY (WCDMA850) .....		26
7.7.4 FREQUENCY STABILITY (WCDMA1900) .....		27
8. TEST PLOTS.....		28



# MEASUREMENT REPORT

## 1. GENERAL INFORMATION

**Applicant Name:** SAMSUNG Electronics Co., Ltd.  
**Address:** 129, Samsung-ro, Yeongtong-gu Suwon-si, Gyeonggi-do, 443-742 Rep. of Korea  
**FCC ID:** A3LGTS7580L  
**Application Type:** Certification  
**FCC Classification:** Licensed Portable Transmitter Held to Ear (PCE)  
**FCC Rule Part(s):** §22, §24, §2  
**EUT Type:** Mobile Phone  
**FCC Model(s):** GT-S7580L  
**Tx Frequency:** 824.20 - 848.80 MHz (GSM850)  
826.40 - 846.60 MHz (WCDMA850)  
1 850.20 - 1 909.80 MHz (GSM1900)  
1 852.4 - 1 907.6 MHz (WCDMA1900)  
**Rx Frequency:** 869.20 - 893.80 MHz (GSM850)  
871.40 - 891.60 MHz (WCDMA850)  
1 930.20 - 1 989.80 MHz (GSM1900)  
1 932.4 - 1 987.6 MHz (WCDMA1900)  
**Max. RF Output Power:** 0.340 W GSM850 (25.32 dBm) / 1.156 W GSM1900 (30.63 dBm)  
0.138 W WCDMA850 (21.39 dBm) / 0.265 W WCDMA1900 (24.24 dBm)  
**Emission Designator(s):** 247 KGXW (GSM850) 247 KGXW (GSM1900)  
4M15F9W (WCDMA850) 4M15F9W (WCDMA1900)  
**Date(s) of Tests:** November 04, 2013 ~ November 11, 2013  
**Antenna Specification** Manufacturer: GALTRONICS Co., Ltd.  
Antenna type: Internal Antenna  
Peak Gain: GSM850/WCDMA850 : -4.79 dBi  
GSM1900/WCDMA1900 : -1.49 dBi

### FCC CERTIFICATION REPORT

FCC CERTIFICATION REPORT			<a href="http://www.hct.co.kr">www.hct.co.kr</a>
Test Report No. HCTR1311FR04	Date of Issue: November 13, 2013	EUT Type: Mobile Phone	FCC ID: A3LGTS7580



## **2. INTRODUCTION**

### **2.1. EUT DESCRIPTION**

The SAMSUNG Electronics Co., Ltd. GT-S7580L Mobile Phone consists of GPRS Class33, GSM850, GSM1900, WCDMA850, WCDMA1900, HSDPA, HSUPA and HSPA+.

### **2.2. MEASURING INSTRUMENT CALIBRATION**

The measuring equipment, which was utilized in performing the tests documented herein, has been calibrated in accordance with the manufacturer's recommendations for utilizing calibration equipment, which is traceable to recognized national standards.

### **2.3. TEST FACILITY**

The Fully-anechoic chamber and conducted measurement facility used to collect the radiated data are located at the 74, Seoicheon-ro 578beon-gil, Majang-myeon, Icheon-si, Gyeonggi-do, Korea.

### 3. DESCRIPTION OF TESTS

#### 3.1 ERP/EIRP RADIATED POWER AND RADIATED SPURIOUS EMISSIONS

Note: ERP(Effective Radiated Power), EIRP(Effective Isotropic Radiated Power)

##### Test Procedure

Radiated emission measurements are performed in the Fully-anechoic chamber. The equipment under test is placed on a non-conductive table 3-meters away from the receive antenna in accordance with ANSI/TIA-603-C-2004 Clause 2.2.17. The turntable is rotated through 360 degrees, and the receiving antenna scans in order to determine the level of the maximized emission. The level and position of the maximized emission is recorded with the spectrum analyzer using a positive peak detector.

A half wave dipole is then substituted in place of the EUT. For emissions above 1GHz, a horn antenna is substituted in place of the EUT. The substitute antenna is driven by a signal generator and the previously recorded signal was duplicated.

The power is calculated by the following formula;

$$P_{d(dBm)} = P_{g(dBm)} - \text{cable loss (dB)} + \text{antenna gain (dB)}$$

Where:  $P_d$  is the dipole equivalent power and  $P_g$  is the generator output power into the substitution antenna.

The maximum EIRP is calculated by adding the forward power to the calibrated source plus its appropriate gain value. These steps are repeated with the receiving antenna in both vertical and horizontal polarization. the difference between the gain of the horn and an isotropic antenna are taken into consideration

##### Radiated spurious emissions

1. Frequency Range : 30 MHz ~ 10<sup>th</sup> Harmonics of highest channel fundamental frequency.
2. The EUT was setup to maximum output power. The 100 kHz RBW was used to scan from 30 MHz to 1 GHz. Also, the 1 MHz RBW was used to scan from 1 GHz to 10 GHz(GSM850/WCDMA850) or 20 GHz(GSM1900/WCDMA1900). The high, low and a middle channel were tested for out of band measurements.

FCC CERTIFICATION REPORT			<a href="http://www.hct.co.kr">www.hct.co.kr</a>
Test Report No. HCTR1311FR04	Date of Issue: November 13, 2013	EUT Type: Mobile Phone	FCC ID: A3LGTS7580



### 3.2 PEAK- TO- AVERAGE RATIO

#### Test Procedure

Peak to Average Power Ratio is tested in accordance with KDB971168 D01 Power Meas License Digital Systems v02r01, June 7, 2013, Section 5.7.

#### - Section 5.7.1 CCDF Procedure

- a) Set resolution/measurement bandwidth  $\geq$  signal's occupied bandwidth;
- b) Set the number of counts to a value that stabilizes the measured CCDF curve;
- c) Set the measurement interval as follows:
  - 1) for continuous transmissions, set to 1 ms,
  - 2) for burst transmissions, employ an external trigger that is synchronized with the EUT burst timing sequence, or use the internal burst trigger with a trigger level that allows the burst to stabilize and set the measurement interval to a time that is less than or equal to the burst duration.
- d) Record the maximum PAPR level associated with a probability of 0.1%.

#### - Section 5.7.2 Alternate Procedure

Use one of the procedures presented in 5.1 to measure the total peak power and record as  $P_{Pk}$ . Use one of the applicable procedures presented 5.2 to measure the total average power and record as  $P_{Avg}$ . Determine the P.A.R. from:  $P.A.R_{(dB)} = P_{Pk (dBm)} - P_{Avg (dBm)}$  ( $P_{Avg}$  = Average Power + Duty cycle Factor)

#### 5.1.1 Peak power measurements with a spectrum/signal analyzer or EMI receiver

The following procedure can be used to determine the total peak output power.

- a) Set the RBW  $\geq$  OBW.
- b) Set VBW  $\geq 3 \times$  RBW.
- c) Set span  $\geq 2 \times$  RBW
- d) Sweep time = auto couple.
- e) Detector = peak.
- f) Ensure that the number of measurement points  $\geq$  span/RBW.
- g) Trace mode = max hold.
- h) Allow trace to fully stabilize.
- i) Use the peak marker function to determine the peak amplitude level.

FCC CERTIFICATION REPORT			<a href="http://www.hct.co.kr">www.hct.co.kr</a>
Test Report No. HCTR1311FR04	Date of Issue: November 13, 2013	EUT Type: Mobile Phone	FCC ID: A3LGTS7580

**5.2.2 Procedures for use with a spectrum/signal analyzer when EUT cannot be configured to transmit continuously and sweep triggering/signal gating cannot be properly implemented**

If the EUT cannot be configured to transmit continuously (burst duty cycle < 98%), then one of the following procedures can be used. The selection of the applicable procedure will depend on the characteristics of the measured burst duty cycle.

Measure the burst duty cycle with a spectrum/signal analyzer or EMC receiver can be used in zero-span mode if the response time and spacing between bins on the sweep are sufficient to permit accurate measurement of the burst on/off time of the transmitted signal.

**5.2.2.2 Constant burst duty cycle**

If the measured burst duty cycle is constant (i.e., duty cycle variations are less than ± 2 percent), then:

- a) Set span to at least 1.5 times the OBW.
- b) Set RBW = 1-5% of the OBW, not to exceed 1 MHz.
- c) Set VBW ≥ 3 x RBW.
- d) Number of points in sweep ≥ 2 × span / RBW. (This gives bin-to-bin spacing ≤ RBW/2, so that narrowband signals are not lost between frequency bins.)
- e) Sweep time = auto.
- f) Detector = RMS (power averaging).
- g) Set sweep trigger to “free run”.
- h) Trace average at least 100 traces in power averaging (i.e., RMS) mode.
- i) Compute power by integrating the spectrum across the OBW of the signal using the instrument’s band power measurement function with band limits set equal to the OBW band edges. If the instrument does not have a band power function, sum the spectrum levels (in power units) at intervals equal to the RBW extending across the entire OBW of the spectrum.
- j) Add 10 log (1/x), where x is the duty cycle, to the measured power in order to compute the average power during the actual transmission times (because the measurement represents an average over both the on and off times of the transmission).

For example, add 10 log (1/0.25) = 6 dB if the duty cycle is a constant 25%.

FCC CERTIFICATION REPORT			<a href="http://www.hct.co.kr">www.hct.co.kr</a>
Test Report No. HCTR1311FR04	Date of Issue: November 13, 2013	EUT Type: Mobile Phone	FCC ID: A3LGTS7580

### 3.3 OCCUPIED BANDWIDTH.

Test set-up

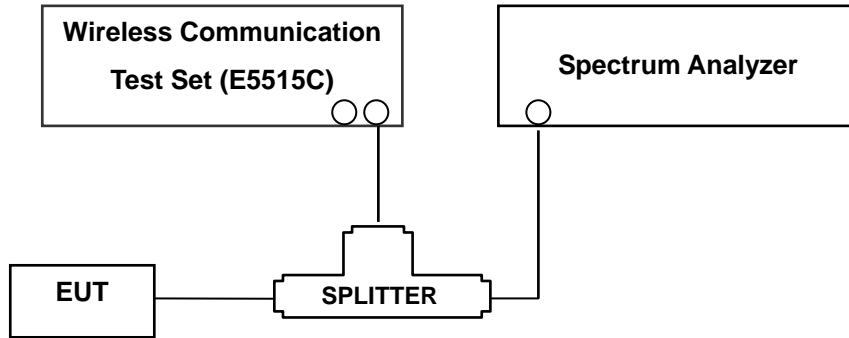

(Configuration of conducted Emission measurement)

The width of a frequency band such that, below the lower and above the upper frequency limits, the mean powers emitted are each equal to a specified percentage 0.5 % of the total mean power of a given emission.

Test Procedure

The EUT makes a call to the communication simulator. The power was measured with R&S Spectrum Analyzer. All measurements were done at 3 channels(low, middle and high operational range.)

The conducted occupied bandwidth used the power splitter via EUT RF power connector between simulation base station and spectrum analyzer.

The communication simulator station system controlled a EUT to export maximum output power under transmission mode and specific channel frequency. Use OBW measurement function of Spectrum analyzer to measure 99 % occupied bandwidth



### 3.4 SPURIOUS AND HARMONIC EMISSIONS AT ANTENNA TERMINAL.

#### Test Procedure

The level of the carrier and the various conducted spurious and harmonic frequencies is measured by means of a calibrated spectrum analyzer.

On any frequency outside a licensee’s frequency block, the power of any emission shall be attenuated below the transmitter power (P) by at least  $43 + 10 \log(P)$  dB. The RBW settings used in the testing are greater than 1 % of the occupied bw. The 1 MHz RBW was used to scan from 10 MHz to 10 GHz. (GSM1900 Mode: 10 MHz to 20 GHz). A display line was placed at – 13 dBm to show compliance. The high, lowest and a middle channel were tested for out of band measurements.

Measurements of all out of band are made on RBW = 1MHz and VBW  $\geq$  3 MHz in the worst case despite RBW = 100 kHz and VBW  $\geq$  300 kHz upon 1 GHz.

- RBW = 1 MHz
- VBW  $\geq$  3 MHz
- Detector = Peak
- Trace Mode = max hold
- Sweep time = auto
- Number of points in sweep  $\geq$  2 \* Span / RBW

- Band Edge Requirement : According to FCC 22.917 , 24.238(a) specified that power of any emission outside of The authorized operating frequency ranges must be attenuated below the transmitting power (P) by a factor of at least  $43 + 10 \log(P)$  dB. In the 1 MHz bands immediately outside and adjacent to the frequency block a resolution bandwidth of at least one percent of the emission bandwidth of the fundamental emission of the transmitter may be employed.

The EUT makes a call to the communication simulator. The power was measured with R&S Spectrum Analyzer. All measurements were done at 2 channels(low and high operational frequency range.)

The band edge measurement used the power splitter via EUT RF power connector between simulation base station and spectrum analyzer.

The center frequency of spectrum is the band edge frequency and span is 1MHz RB of the spectrum is 3KHz and VB of the spectrum is 3KHz (GSM)

The center frequency of spectrum is the band edge frequency and span is 5MHz RB of the spectrum is 100KHz and VB of the spectrum is 100KHz(WCDMA)

**NOTES:** The analyzer plot offsets were determined by below conditions.

- For GSM850 and WCDMA850, total offset 28.2 dBm  
= 20 dBm attenuator + 6 dBm Divider + 2.2 dBm RF cables.
- For GSM1900 and WCDMA1900, total offset 29.4 dB  
= 20 dBm attenuator + 6 dBm Divider + 3.4 dBm RF cables.

FCC CERTIFICATION REPORT			<a href="http://www.hct.co.kr">www.hct.co.kr</a>
Test Report No. HCTR1311FR04	Date of Issue: November 13, 2013	EUT Type: Mobile Phone	FCC ID: A3LGTS7580

### 3.5 FREQUENCY STABILITY / VARIATION OF AMBIENT TEMPERATURE

#### Test Set-up

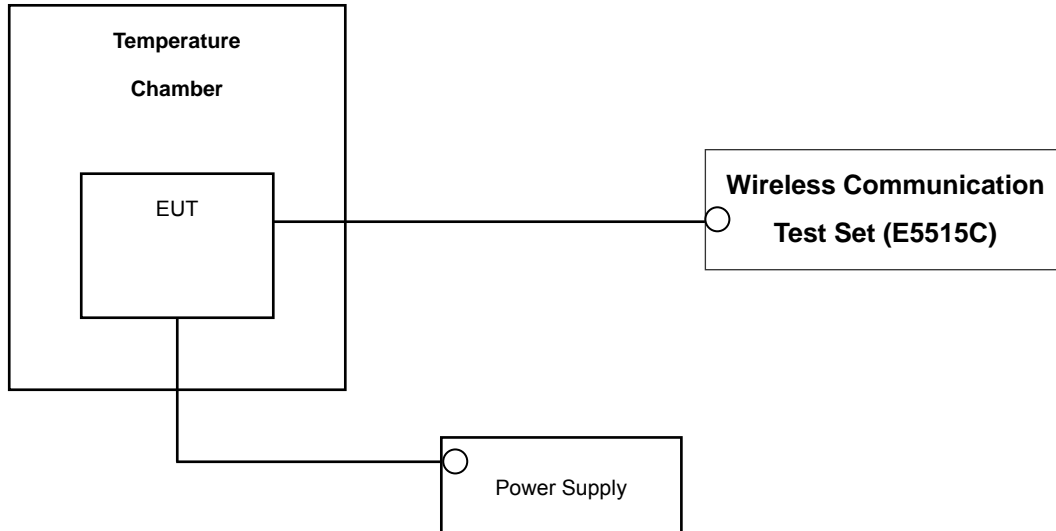

\* Nominal Operating Voltage

#### Test Procedure

The frequency stability of the transmitter is measured by:

- a.) **Temperature:** The temperature is varied from - 30 °C to + 50 °C using an environmental chamber.
- b.) **Primary Supply Voltage:** The primary supply voltage is varied from battery end point to 115 % of the voltage normally at the input to the device or at the power supply terminals if cables are not normally supplied.

Specification — the frequency stability shall be sufficient to ensure that the fundamental emission stays within the authorized frequency block. The frequency stability of the transmitter shall be maintained within  $\pm 0.00025\%$  ( $\pm 2.5$  ppm) of the center frequency.

#### Time Period and Procedure:

The carrier frequency of the transmitter is measured at room temperature (20°C to provide a reference).

1. The equipment is turned on in a “standby” condition for one minute before applying power to the transmitter. Measurement of the carrier frequency of the transmitter is made within one minute after applying power to the transmitter.
2. Frequency measurements are made at 10°C intervals ranging from -30°C to +50°C. A period of at least one half-hour is provided to allow stabilization of the equipment at each temperature level.

**NOTE: The EUT is tested down to the battery endpoint.**

FCC CERTIFICATION REPORT			<a href="http://www.hct.co.kr">www.hct.co.kr</a>
Test Report No. HCTR1311FR04	Date of Issue: November 13, 2013	EUT Type: Mobile Phone	FCC ID: A3LGTS7580

## 4. LIST OF TEST EQUIPMENT

Manufacture	Model/ Equipment	Serial Number	Calibration Interval	Calibration Due
Agilent	E9327A/ Power Sensor	MY4442009	Annual	04/16/2014
MITEQ	AMF-6D-001180-35-20P/AMP	1081666	Annual	09/12/2014
Wainwright	WHK1.2/15G-10EF/H.P.F	2	Annual	04/25/2014
Wainwright	WHK3.3/18G-10EF/H.P.F	1	Annual	04/25/2014
Hewlett Packard	11667B / Power Splitter	11275	Annual	05/13/2014
Digital	EP-3010/ Power Supply	3110117	Annual	10/29/2014
Schwarzbeck	UHAP/ Dipole Antenna	557	Biennial	03/05/2015
Schwarzbeck	UHAP/ Dipole Antenna	558	Biennial	05/03/2015
Korea Engineering	KR-1005L / Chamber	KRAB05063-3CH	Annual	10/30/2014
Schwarzbeck	BBHA 9120D/ Horn Antenna	147	Biennial	05/15/2014
Schwarzbeck	BBHA 9120D/ Horn Antenna	1151	Biennial	10/05/2015
Agilent	E4440A/Spectrum Analyzer	US45303008	Annual	04/25/2014
WEINSCHTEL	ATTENUATOR	BR0592	Annual	10/28/2014
REOHDE&SCHWARZ	FSV40/Spectrum Analyzer	1307.9002K40-100931-NK	Annual	06/10/2014
Agilent	8960 (E5515C)/ Base Station	GB44400269	Annual	02/14/2014

## 5. SUMMARY OF TEST RESULTS

FCC Part Section(s)	Test Description	Test Limit	Test Condition	Test Result
2.1049, 22.917(a), 24.238(a)	Occupied Bandwidth	N/A	CONDUCTED	PASS
2.1051, 22.917(a), 24.238(a)	Band Edge / Spurious and Harmonic Emissions at Antenna Terminal.	< 43 + 10log10 (P[Watts]) at Band Edge and for all out-of-band emissions		PASS
* 2.1046	Conducted Output Power	-		PASS
24.232(d)	Peak- to- Average Ratio	< 13 dB		PASS
2.1055, 22.355, 24.235	Frequency stability / variation of ambient temperature	< 2.5 ppm		PASS
22.913(a)(2) 24.232(c)	Effective Radiated Power	< 7 Watts max. ERP	RADIATED	PASS
	Equivalent Isotropic Radiated Power	< 2 Watts max. EIRP		PASS
2.1053, 22.917(a), 24.238(a)	Radiated Spurious and Harmonic Emissions	< 43 + 10log10 (P[Watts]) for all out-of band emissions		PASS

\*: See SAR Report

## 6. SAMPLE CALCULATION

### A. ERP Sample Calculation

Mode	Ch./ Freq.		Measured Level(dBm)	Substitute LEVEL(dBm)	Ant. Gain (dBd)	C.L	Pol.	ERP	
	channel	Freq.(MHz)						W	dBm
GSM850	128	824.20	-21.37	38.40	-10.61	0.95	H	0.483	26.84

**ERP = SubstituteLEVEL(dBm) + Ant. Gain – CL(Cable Loss)**

- 1) The EUT mounted on a non-conductive tunnable is 0.8 meter above test site ground level.
- 2) During the test , the turn table is rotated until the maximum signal is found.
- 3) Record the field strength meter's level.
- 4) Replace the EUT with dipole/Horn antenna that is connected to a calibrated signal generator.
- 5) Increase the signal generator output till the field strength meter's level is equal to the item (3).
- 6) The signal generator output level with Ant. Gain and cable loss are the rating of effective radiated power (**ERP**).

### B. Emission Designator

#### GSM Emission Designator

**Emission Designator = 249KGXW**

GSM BW = 249 kHz

G = Phase Modulation

X = Cases not otherwise covered

W = Combination (Audio/Data)

#### WCDMA Emission Designator

**Emission Designator = 4M17F9W**

WCDMA BW = 4.17 MHz

F = Frequency Modulation

9 = Composite Digital Info

W = Combination (Audio/Data)

## 7. TEST DATA

### 7.1 EFFECTIVE RADIATED POWER OUTPUT (GSM / WCDMA)

#### (GSM850 Mode)

Ch./ Freq.		Measured Level(dBm)	Substitute LEVEL (dBm)	Ant. Gain (dBd)	C.L	Pol.	ERP	
channel	Freq.(MHz)						W	dBm
128	824.20	-22.89	36.88	-10.61	0.95	V	0.340	25.32
190	836.60	-23.50	36.68	-10.54	0.96	V	0.330	25.18
251	848.80	-23.70	36.72	-10.47	1.10	V	0.327	25.15

#### (WCDMA850 Mode)

Ch./ Freq.		Measured Level(dBm)	Substitute LEVEL (dBm)	Ant. Gain (dBd)	C.L	Pol.	ERP	
channel	Freq.(MHz)						W	dBm
4132	826.40	-26.82	32.93	-10.59	0.95	V	0.138	21.39
4183	836.60	-30.89	29.29	-10.54	0.96	V	0.060	17.79
4233	846.60	-28.66	31.69	-10.48	1.11	V	0.102	20.10

Note: Standard batteries are the only options for this phone. And a peak detector is used.

#### NOTES:

##### Effective Radiated Power Output Measurements by Substitution Method

according to ANSI/TIA/EIA-603-C-2004, Aug. 17, 2004:

The EUT was placed on a non-conductive styrofoam resin table 3-meters from the receive antenna. Turntable rotation was adjusted for the highest reading on the receive spectrum analyzer. For CDMA, WCDMA, AMPS, GSM, and NADC TDMA signals, a peak detector is used, with  $RBW \geq OBW$ ,  $VBW \geq 3 \times RBW$ . A half-wave dipole was substituted in place of the EUT. This dipole antenna was driven by a signal generator and the level of the signal generator was adjusted to obtain the same receive spectrum analyzer reading. The conducted power at the terminals of the dipole is measured. The ERP is recorded.

This device was tested under all configurations and the highest power is reported in WCDMA mode with HSDPA Inactive at 12.2 kbps RMC and TPC bits all set to "1" and in GSM mode and using a Power Control Level of "0" in the PCS Band and "5" in the Cellular Band. This unit was tested with its standard battery. Also, we have done x, y, z planes in EUT and horizontal and vertical polarization in detecting antenna. The worst case of the EUT is y plane in GSM850 and WCDMA850 mode. Also worst case of detecting Antenna is vertical polarization in GSM850 and WCDMA850 mode.



## 7.2 EQUIVALENT ISOTROPIC RADIATED POWER (GSM / WCDMA)

### (GSM1900 Mode)

Ch./ Freq.		Measured Level(dBm)	Substitute LEVEL (dBm)	Ant. Gain (dBi)	C.L	Pol.	EIRP	
channel	Freq.(MHz)						W	dBm
512	1,850.20	-10.01	22.02	10.02	1.41	H	1.156	30.63
661	1,880.00	-10.82	21.49	10.04	1.45	H	1.019	30.08
810	1,909.80	-11.14	21.11	10.05	1.44	H	0.938	29.72

### (WCDMA1900 Mode)

Ch./ Freq.		Measured Level(dBm)	Substitute LEVEL (dBm)	Ant. Gain (dBi)	C.L	Pol.	EIRP	
channel	Freq.(MHz)						W	dBm
9262	1,852.40	-17.00	15.15	10.02	1.40	H	0.238	23.77
9400	1,880.00	-16.66	15.65	10.04	1.45	H	0.265	24.24
9538	1,907.60	-17.29	15.27	10.05	1.48	H	0.242	23.84

Note: Standard batteries are the only options for this phone. And a peak detector is used.

#### NOTES:

Equivalent Isotropic Radiated Power Measurements by Substitution Method  
according to ANSI/TIA/EIA-603-C-2004, Aug. 17, 2004:

The EUT was placed on a non-conductive styrofoam resin table 3-meters from the receive antenna. Turntable rotation was adjusted for the highest reading on the receive spectrum analyzer. For CDMA, WCDMA, AMPS, GSM, and NADC TDMA signals, a peak detector is used, with  $RBW \geq OBW$ ,  $VBW \geq 3 \times RBW$ . A Horn antenna was substituted in place of the EUT. This Horn antenna was driven by a signal generator and the level of the signal generator was adjusted to obtain the same receive spectrum analyzer reading. The conducted power at the terminals of the Horn antenna is measured. The difference between the gain of the horn and an isotropic antenna is taken into consideration and the EIRP is recorded.

This device was tested under all configurations and the highest power is reported in WCDMA mode with HSDPA Inactive at 12.2 kbps RMC and TPC bits all set to "1" and in GSM mode and using a Power Control Level of "0" in the PCS Band and "5" in the Cellular Band. This unit was tested with its standard battery. Also, we have done x, y, z planes in EUT and horizontal and vertical polarization in detecting antenna. The worst case of the EUT is x plane in GSM1900 and WCDMA1900 mode. Also worst case of detecting Antenna is in horizontal polarization in GSM1900 and WCDMA1900mode.

FCC CERTIFICATION REPORT			<a href="http://www.hct.co.kr">www.hct.co.kr</a>
Test Report No. HCTR1311FR04	Date of Issue: November 13, 2013	EUT Type: Mobile Phone	FCC ID: A3LGTS7580

### 7.3 RADIATED SPURIOUS EMISSIONS

#### 7.3.1 RADIATED SPURIOUS EMISSIONS (GSM850)

MEASURED OUTPUT POWER: 25.32 dBm = 0.340 W  
 MODULATION SIGNAL: GSM850  
 DISTANCE: 3 meters  
 LIMIT:  $43 + 10 \log_{10}(W) =$  38.32 dBc

Ch.	Freq.(MHz)	Measured Level [dBm]	Ant. Gain (dBd)	Substitute Level [dBm]	C.L	Pol.	ERP (dBm)	dBc
128 (824.2)	1,648.40	-43.32	7.05	-50.16	1.18	H	-44.29	69.61
	2,472.60	-40.56	7.90	-44.31	1.57	V	-37.98	63.30
	3,296.80	-48.28	9.91	-52.16	1.99	V	-44.24	69.56
190 (836.6)	1,673.20	-43.92	7.22	-50.92	1.20	H	-44.90	70.22
	2,509.80	-37.15	8.51	-40.94	1.65	H	-34.08	59.40
	3,346.40	-47.19	10.09	-51.58	2.00	V	-43.49	68.81
251 (848.8)	1,697.60	-45.52	7.34	-52.54	1.20	V	-46.40	71.72
	2,546.40	-37.11	8.61	-40.65	1.65	H	-33.69	59.01
	3,395.20	-46.32	10.22	-50.85	1.99	H	-42.62	67.94

- NOTES:**
1. Radiated Spurious Emission Measurements at 3 meters by Substitution Method according to ANSI/TIA/EIA-603-C-2004, Aug. 17, 2004:
  2. We are performed all frequency to 10<sup>th</sup> harmonics from 30 MHz. Measurements above show only up to 3 maximum emissions noted, or would be lesser if no specific emissions from the EUT are recorded (ie: margin > 20 dB from the applicable limit) and considered that's already beyond the background noise floor.
  3. we have done x, y, z planes in EUT and horizontal and vertical polarization in detecting antenna.



### 7.3.2 RADIATED SPURIOUS EMISSIONS(GSM1900)

MEASURED OUTPUT POWER: 30.63 dBm = 1.156 W  
 MODULATION SIGNAL: GSM1900  
 DISTANCE: 3 meters  
 LIMIT:  $43 + 10 \log_{10}(W) =$  43.63 dBc

Ch.	Freq.(MHz)	Measured Level [dBm]	Ant. Gain (dBi)	Substitute Level [dBm]	C.L	Pol.	EIRP (dBm)	dBc
512 (1850.2)	3,700.40	-37.14	12.27	-41.88	2.19	V	-31.80	62.43
	5,550.60	-54.85	13.40	-54.52	2.88	H	-44.00	74.63
	7,400.80	-58.70	11.37	-48.41	3.29	H	-40.33	70.96
661 (1880.0)	3,760.00	-41.17	12.31	-45.72	2.11	H	-35.52	66.15
	5,640.00	-54.86	13.41	-54.19	2.92	V	-43.70	74.33
	7,520.00	-57.37	11.55	-47.85	3.34	V	-39.64	70.27
810 (1909.8)	3,819.60	-47.03	12.37	-51.51	2.14	H	-41.28	71.91
	5,729.40	-53.88	13.42	-52.44	3.02	H	-42.04	72.67
	7,639.20	-57.08	11.70	-47.32	3.13	V	-38.75	69.38

- NOTES:**
1. Radiated Spurious Emission Measurements at 3 meters by Substitution Method according to ANSI/TIA/EIA-603-C-2004, Aug. 17, 2004:
  2. We are performed all frequency to 10<sup>th</sup> harmonics from 30 MHz. Measurements above show only up to 3 maximum emissions noted, or would be lesser if no specific emissions from the EUT are recorded (ie: margin > 20 dB from the applicable limit) and considered that's already beyond the background noise floor.
  3. we have done x, y, z planes in EUT and horizontal and vertical polarization in detecting antenna.



### 7.3.3 RADIATED SPURIOUS EMISSIONS (WCDMA850)

MEASURED OUTPUT POWER: 21.39 dBm = 0.138 W  
 MODULATION SIGNAL: WCDMA850  
 DISTANCE: 3 meters  
 LIMIT:  $43 + 10 \log_{10}(W) =$  34.39 dBc

Ch.	Freq.(MHz)	Measured Level [dBm]	Ant. Gain (dBd)	Substitute Level [dBm]	C.L	Pol.	ERP (dBm)	dBc
4,132 (826.4)	1,652.80	-37.45	7.11	-44.38	1.20	H	-38.47	59.86
	2,479.20	-57.73	8.40	-61.62	1.62	H	-54.84	76.23
	3,305.60	-56.78	9.95	-60.96	1.99	H	-53.00	74.39
4,183 (836.6)	1,673.20	-36.21	7.22	-43.21	1.20	H	-37.19	58.58
	2,509.80	-56.33	8.51	-60.12	1.65	H	-53.26	74.65
	3,346.40	-57.70	10.09	-62.09	2.00	H	-54.00	75.39
4,233 (846.6)	1,693.20	-32.13	7.34	-39.15	1.20	V	-33.01	54.40
	2,539.80	-57.79	8.58	-61.71	1.65	V	-54.78	76.17
	3,386.40	-57.52	10.19	-61.95	1.98	V	-53.74	75.13

- NOTES:**
1. Radiated Spurious Emission Measurements at 3 meters by Substitution Method according to ANSI/TIA/EIA-603-C-2004, Aug. 17, 2004:
  2. We are performed all frequency to 10<sup>th</sup> harmonics from 30 MHz. Measurements above show only up to 3 maximum emissions noted, or would be lesser if no specific emissions from the EUT are recorded (ie: margin > 20 dB from the applicable limit) and considered that's already beyond the background noise floor.
  3. we have done x, y, z planes in EUT and horizontal and vertical polarization in detecting antenna.

FCC CERTIFICATION REPORT			<a href="http://www.hct.co.kr">www.hct.co.kr</a>
Test Report No. HCTR1311FR04	Date of Issue: November 13, 2013	EUT Type: Mobile Phone	FCC ID: A3LGTS7580



### 7.3.4 RADIATED SPURIOUS EMISSIONS (WCDMA1900)

MEASURED OUTPUT POWER: 24.24 dBm = 0.265 W  
 MODULATION SIGNAL: WCDMA1900  
 DISTANCE: 3 meters  
 LIMIT:  $43 + 10 \log_{10}(W) =$  37.24 dBc

Ch.	Freq.(MHz)	Measured Level [dBm]	Ant. Gain (dBi)	Substitute Level [dBm]	C.L	Pol.	EIRP (dBm)	dBc
9262	3,704.80	-44.06	12.27	-48.80	2.19	H	-38.72	62.96
	5,557.20	-56.80	13.40	-56.47	2.88	H	-45.95	70.19
	7,409.60	-59.11	11.37	-48.82	3.29	H	-40.74	64.98
9400	3,760.00	-47.05	12.31	-51.60	2.11	H	-41.40	65.64
	5,640.00	-57.21	13.41	-56.54	2.92	V	-46.05	70.29
	7,520.00	-59.02	11.55	-49.50	3.34	H	-41.29	65.53
9538	3,815.20	-48.69	12.37	-53.17	2.14	H	-42.94	67.18
	5,722.80	-56.99	13.42	-55.55	3.02	H	-45.15	69.39
	7,630.40	-58.42	11.70	-48.66	3.13	H	-40.09	64.33

- NOTES:**
1. Radiated Spurious Emission Measurements at 3 meters by Substitution Method according to ANSI/TIA/EIA-603-C-2004, Aug. 17, 2004:
  2. We are performed all frequency to 10<sup>th</sup> harmonics from 30 MHz. Measurements above show only up to 3 maximum emissions noted, or would be lesser if no specific emissions from the EUT are recorded (ie: margin > 20 dB from the applicable limit) and considered that's already beyond the background noise floor.
  3. we have done x, y, z planes in EUT and horizontal and vertical polarization in detecting antenna.

FCC CERTIFICATION REPORT			<a href="http://www.hct.co.kr">www.hct.co.kr</a>
Test Report No. HCTR1311FR04	Date of Issue: November 13, 2013	EUT Type: Mobile Phone	FCC ID: A3LGTS7580

## 7.4 PEAK-TO-AVERAGE RATIO

Band	Ch.	Measured P <sub>PK</sub> (dBm)	Measured P <sub>Avg</sub> (dBm)	P <sub>Avg</sub> (Duty Cycle)			P.A.R. = P <sub>PK</sub> - P <sub>Avg</sub> (dB)	Limit (dB)	Pass / Fail
				Tx <sub>Total</sub> (ms)	Tx <sub>On</sub> (ms)	Factor (dB)			
GSM1900	661	30.10	20.73	4.6232	0.5507	9.240	0.130	13	Pass
WCDMA1900	9400	CCDF Procedure					3.24		

- Plots of the EUT's Peak- to- Average Ratio are shown Page 32 ~ 33, 36.

### NOTES:

Peak to Average Power Ratio was tested in accordance with KDB971168 D01 Power Meas License Digital Systems v02r01, June 7, 2013, Section 5.7.

Only GSM(include EDGE) Mode was tested by Section 5.7.2 Alternate Procedure

$P.A.R_{(dB)} = P_{PK (dBm)} - P_{Avg (dBm)}$  (P<sub>Avg</sub> = Average Power + Duty cycle Factor)

Duty cycle Factor =  $10 \log (1/x)$ ,  $x = Tx_{On} / Tx_{Total}$

## 7.5 OCCUPIED BANDWIDTH

Band	Channel	Frequency(MHz)	Data (GSM: kHz / WCDMA : MHz)
GSM850	128	824.20	244.1750
	190	836.60	246.5959
	251	848.80	246.6244
GSM1900	512	1,850.20	246.5573
	661	1,880.00	244.1585
	810	1,909.80	247.3356
WCDMA850	4132	826.40	4.1499
	4183	836.60	4.1418
	4233	846.60	4.1355
WCDMA1900	9262	1852.40	4.1469
	9400	1880.00	4.1319
	9538	1907.60	4.1526

- Plots of the EUT's Occupied Bandwidth are shown Page 29 ~ 31, 33 ~ 36.

## 7.6 CONDUCTED SPURIOUS EMISSIONS

Band	Channel	Frequency of Maximum Harmonic (GHz)	Maximum Data (dBm)
GSM850	128	4.983850	-27.77
	190	4.918740	-27.31
	251	4.810390	-27.31
GSM1900	512	6.979840	-23.09
	661	6.987320	-23.22
	810	6.987810	-23.92
WCDMA850	4132	4.976890	-27.86
	4183	4.904820	-27.45
	4233	4.795980	-27.77
WCDMA1900	9262	6.746540	-24.25
	9400	6.585520	-23.73
	9538	6.826800	-24.02

- Plots of the EUT's Conducted Spurious Emissions are shown Page 45 ~ 56.

### 7.6.1 BAND EDGE

- Plots of the EUT's Band Edge are shown Page 37 ~ 44.

## 7.7 FREQUENCY STABILITY / VARIATION OF AMBIENT TEMPERATURE

### 7.7.1 FREQUENCY STABILITY (GSM850)

OPERATING FREQUENCY: 836,600,000 Hz  
 CHANNEL: 190  
 REFERENCE VOLTAGE: 3.8 VDC  
 DEVIATION LIMIT: ± 0.000 25 % or 2.5 ppm

Voltage (%)	Power (VDC)	Temp. ( )	Frequency (Hz)	Frequency Error (Hz)	Deviation (%)	ppm
100%	3.800	+20(Ref)	836 599 981	0	0.000 000	0.000
100%		-30	836 600 002	20.91	0.000 002	0.025
100%		-20	836 599 959	-21.54	-0.000 003	-0.026
100%		-10	836 599 953	-28.05	-0.000 003	-0.034
100%		0	836 599 950	-30.29	-0.000 004	-0.036
100%		+10	836 599 955	-25.39	-0.000 003	-0.030
100%		+30	836 600 001	19.96	0.000 002	0.024
100%		+40	836 600 001	20.67	0.000 002	0.025
100%		+50	836 600 002	21.37	0.000 003	0.026
115%	4.370	+20	836 599 959	-22.14	-0.000 003	-0.026
85%	3.500	+20	836 600 002	21.55	0.000 003	0.026

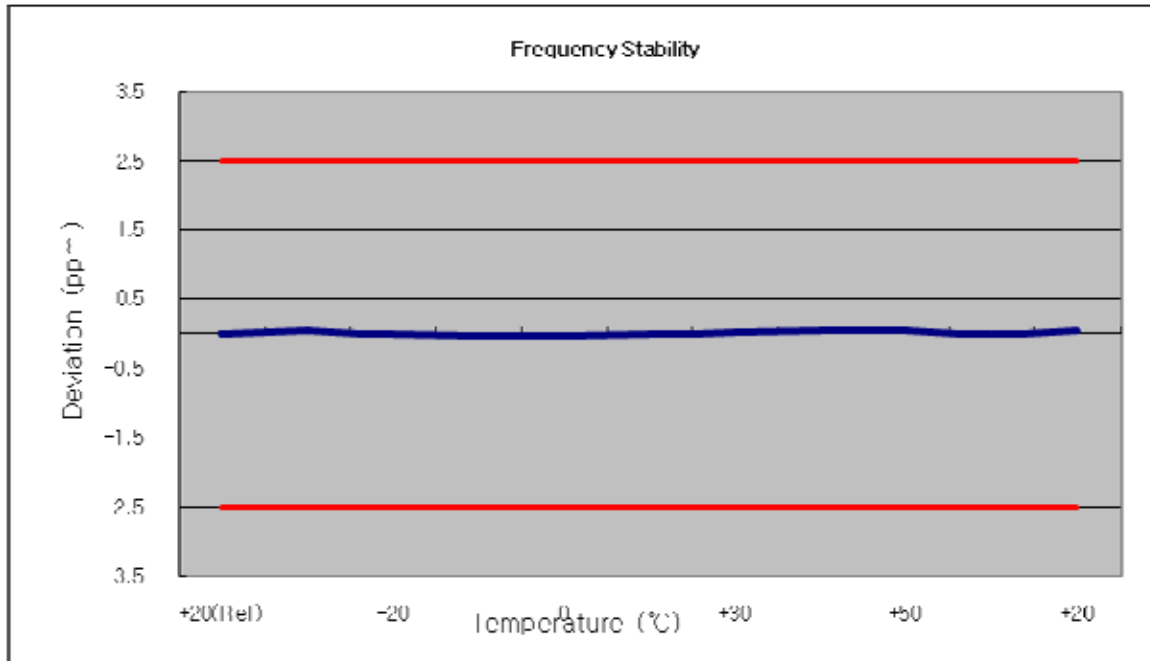

#### FCC CERTIFICATION REPORT

Test Report No. HCTR1311FR04	Date of Issue: November 13, 2013	EUT Type: Mobile Phone	<a href="http://www.hct.co.kr">www.hct.co.kr</a> FCC ID: A3LGTS7580
---------------------------------	-------------------------------------	---------------------------	---

### 7.7.2 FREQUENCY STABILITY (GSM1900)

OPERATING FREQUENCY: 1880,000,000 Hz  
 CHANNEL: 661  
 REFERENCE VOLTAGE: 3.8 VDC  
 DEVIATION LIMIT: ± 0.000 25 % or 2.5 ppm

Voltage (%)	Power (VDC)	Temp. ( )	Frequency (Hz)	Frequency Error (Hz)	Deviation (%)	ppm
100%	3.800	+20(Ref)	1880 000 037	0	0.000 000	0.000
100%		-30	1879 999 988	-48.78	-0.000 003	-0.026
100%		-20	1879 999 994	-42.74	-0.000 002	-0.023
100%		-10	1880 000 000	-36.44	-0.000 002	-0.019
100%		0	1879 999 994	-42.25	-0.000 002	-0.022
100%		+10	1879 999 992	-44.81	-0.000 002	-0.024
100%		+30	1879 999 990	-46.47	-0.000 002	-0.025
100%		+40	1879 999 997	-39.73	-0.000 002	-0.021
100%		+50	1879 999 999	-38.05	-0.000 002	-0.020
115%		4.370	+20	1879 999 989	-47.40	-0.000 003
85%	3.500	+20	1879 999 992	-44.45	-0.000 002	-0.024

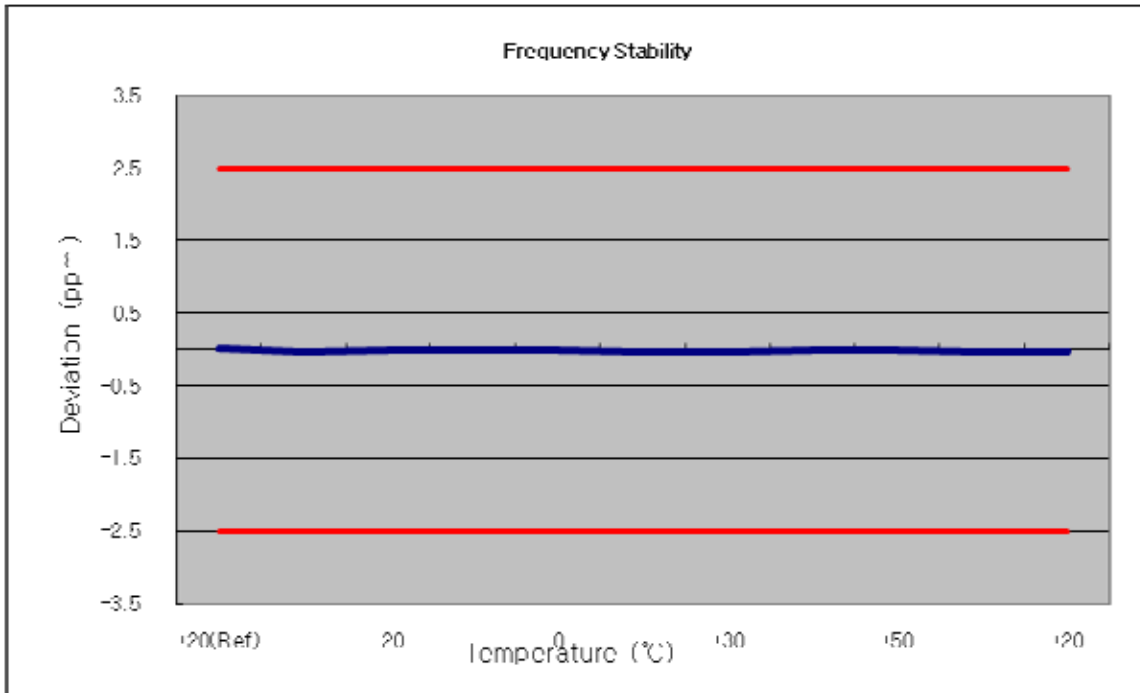

FCC CERTIFICATION REPORT

Test Report No. HCTR1311FR04	Date of Issue: November 13, 2013	EUT Type: Mobile Phone	<a href="http://www.hct.co.kr">www.hct.co.kr</a> FCC ID: A3LGTS7580
---------------------------------	-------------------------------------	---------------------------	---

### 7.7.3 FREQUENCY STABILITY (WCDMA850)

OPERATING FREQUENCY: 836,600,000 Hz  
 CHANNEL: 4183  
 REFERENCE VOLTAGE: 3.8 VDC  
 DEVIATION LIMIT: ± 0.000 25 % or 2.5 ppm

Voltage (%)	Power (VDC)	Temp. ( )	Frequency (Hz)	Frequency Error (Hz)	Deviation (%)	ppm
100%	3.800	+20(Ref)	836 600 004	0	0.000 000	0.000
100%		-30	836 599 994	-5.72	-0.000 001	-0.007
100%		-20	836 599 994	-5.91	-0.000 001	-0.007
100%		-10	836 599 995	-4.70	-0.000 001	-0.006
100%		0	836 599 995	-5.05	-0.000 001	-0.006
100%		+10	836 599 995	-4.69	-0.000 001	-0.006
100%		+30	836 599 994	-5.90	-0.000 001	-0.007
100%		+40	836 599 994	-6.38	-0.000 001	-0.008
100%		+50	836 599 993	-6.60	-0.000 001	-0.008
115%		4.370	+20	836 599 994	-6.09	-0.000 001
85%	3.500	+20	836 599 994	-5.80	-0.000 001	-0.007

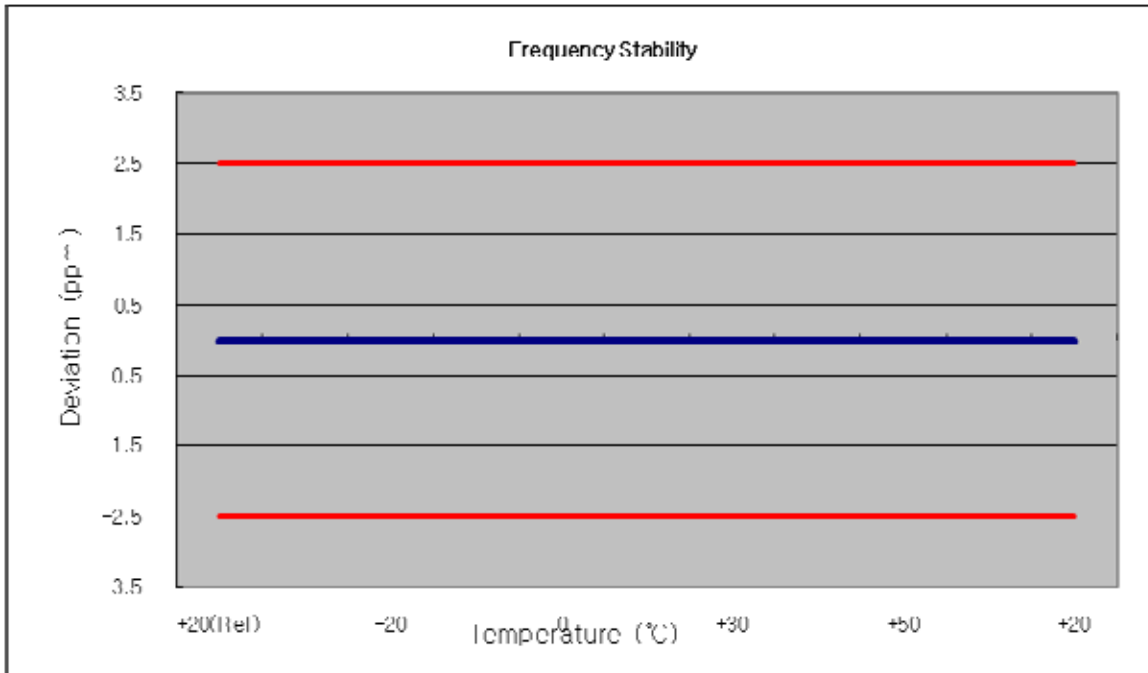

### 7.7.4 FREQUENCY STABILITY (WCDMA1900)

OPERATING FREQUENCY: 1,880,000,000 Hz  
 CHANNEL: 9400  
 REFERENCE VOLTAGE: 3.8 VDC  
 DEVIATION LIMIT: ± 0.000 25 % or 2.5 ppm

Voltage (%)	Power (VDC)	Temp. ( )	Frequency (Hz)	Frequency Error (Hz)	Deviation (%)	ppm
100%	3.800	+20(Ref)	1880 000 006	0	0.000 000	0.000
100%		-30	1879 999 993	-7.29	0.000 000	-0.004
100%		-20	1879 999 993	-6.79	0.000 000	-0.004
100%		-10	1879 999 994	-5.52	0.000 000	-0.003
100%		0	1879 999 995	-5.28	0.000 000	-0.003
100%		+10	1879 999 994	-6.03	0.000 000	-0.003
100%		+30	1879 999 991	-9.15	0.000 000	-0.005
100%		+40	1879 999 993	-6.87	0.000 000	-0.004
100%		+50	1879 999 992	-7.83	0.000 000	-0.004
115%		4.370	+20	1879 999 994	-5.93	0.000 000
85%	3.500	+20	1879 999 992	-7.54	0.000 000	-0.004

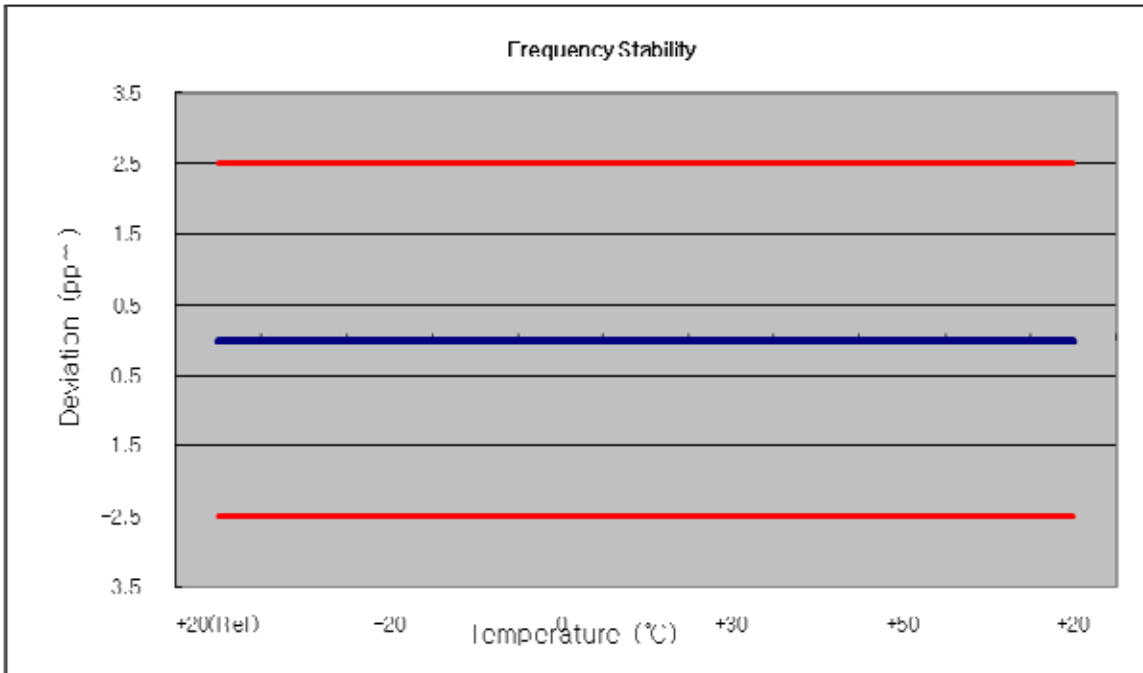



## 8. TEST PLOTS

<b>FCC CERTIFICATION REPORT</b>			<a href="http://www.hct.co.kr">www.hct.co.kr</a>
<b>Test Report No.</b> HCTR1311FR04	<b>Date of Issue:</b> November 13, 2013	<b>EUT Type:</b> Mobile Phone	<b>FCC ID:</b> A3LGTS7580

■ GSM850 MODE (128 CH.) Occupied Bandwidth

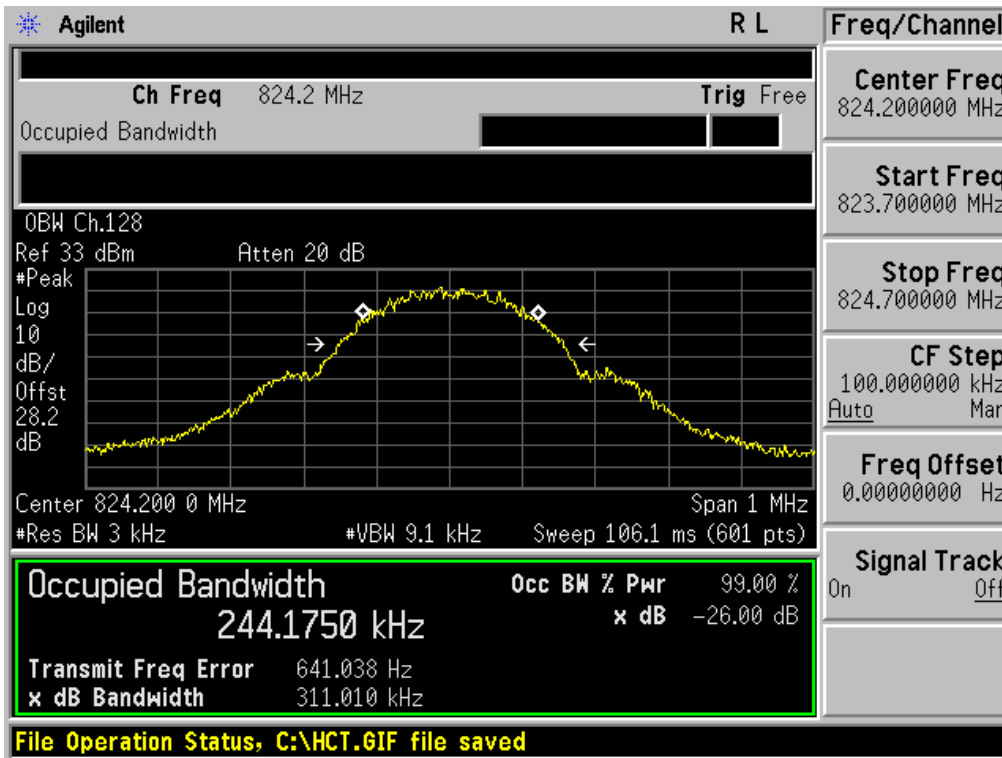

■ GSM850 MODE (190 CH.) Occupied Bandwidth

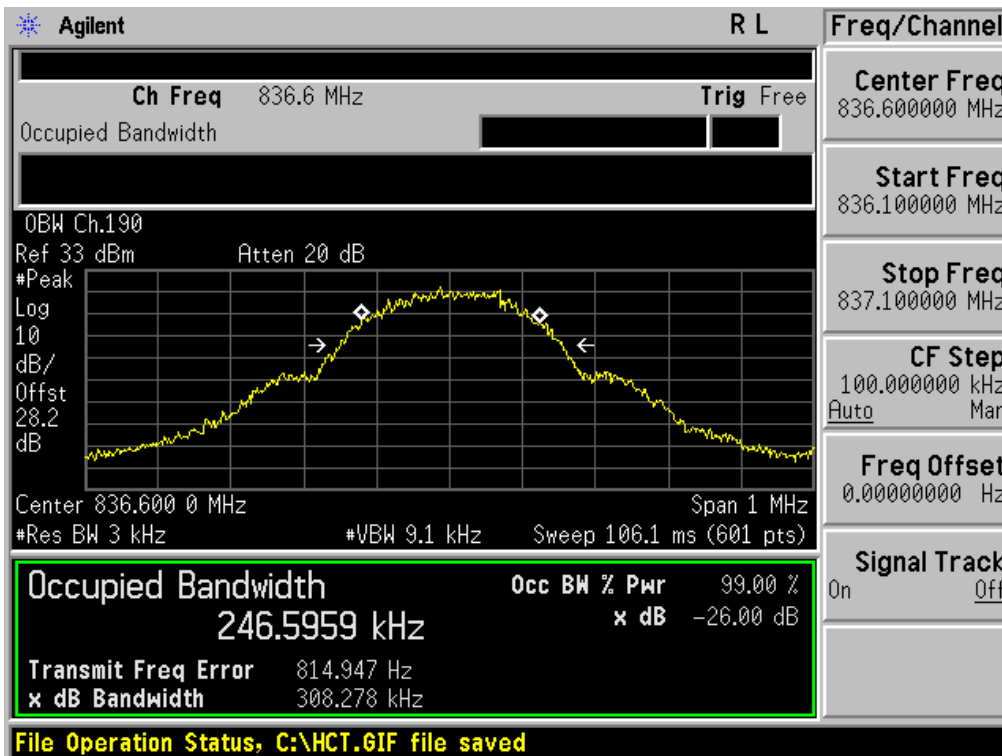

FCC CERTIFICATION REPORT

Test Report No. HCTR1311FR04	Date of Issue: November 13, 2013	EUT Type: Mobile Phone	<a href="http://www.hct.co.kr">www.hct.co.kr</a> FCC ID: A3LGTS7580
---------------------------------	-------------------------------------	---------------------------	---

■ GSM850 MODE (251 CH.) Occupied Bandwidth

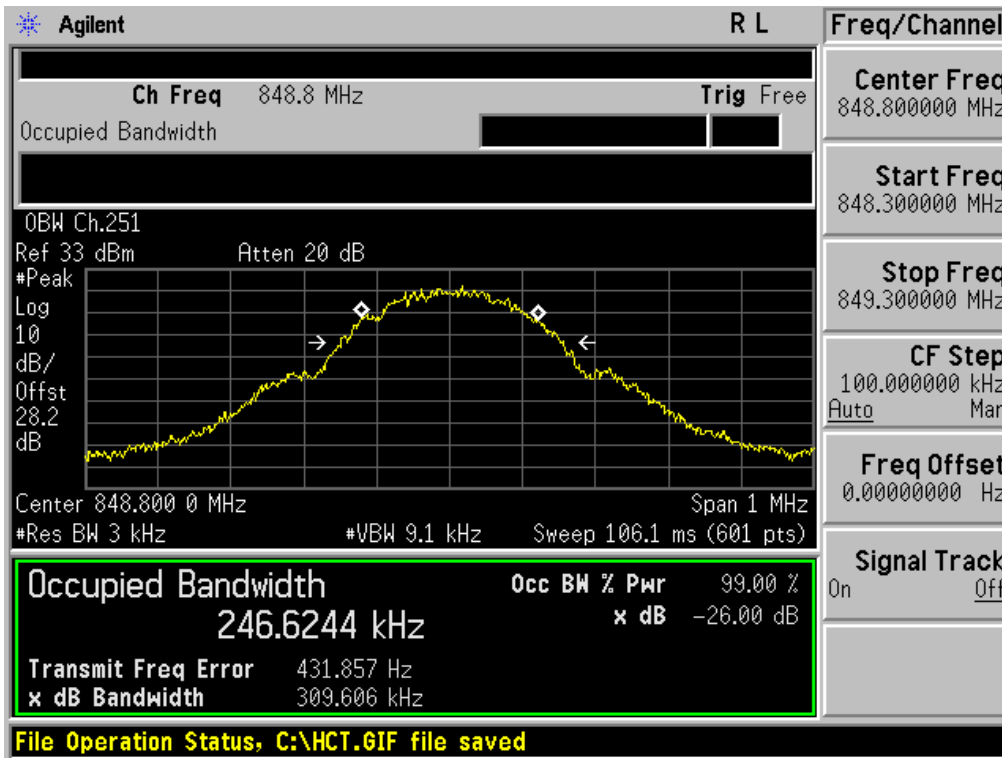

■ GSM1900 MODE (512 CH.) Occupied Bandwidth

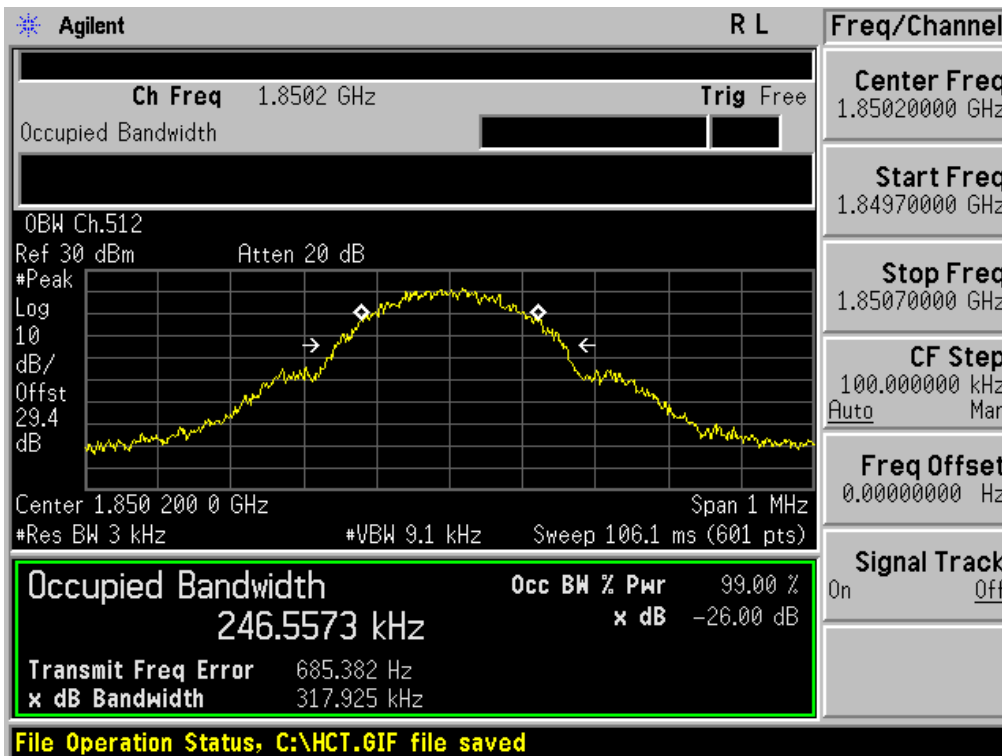

FCC CERTIFICATION REPORT

Test Report No. HCTR1311FR04	Date of Issue: November 13, 2013	EUT Type: Mobile Phone	<a href="http://www.hct.co.kr">www.hct.co.kr</a> FCC ID: A3LGTS7580
---------------------------------	-------------------------------------	---------------------------	---

■ GSM1900 MODE (661 CH.) Occupied Bandwidth

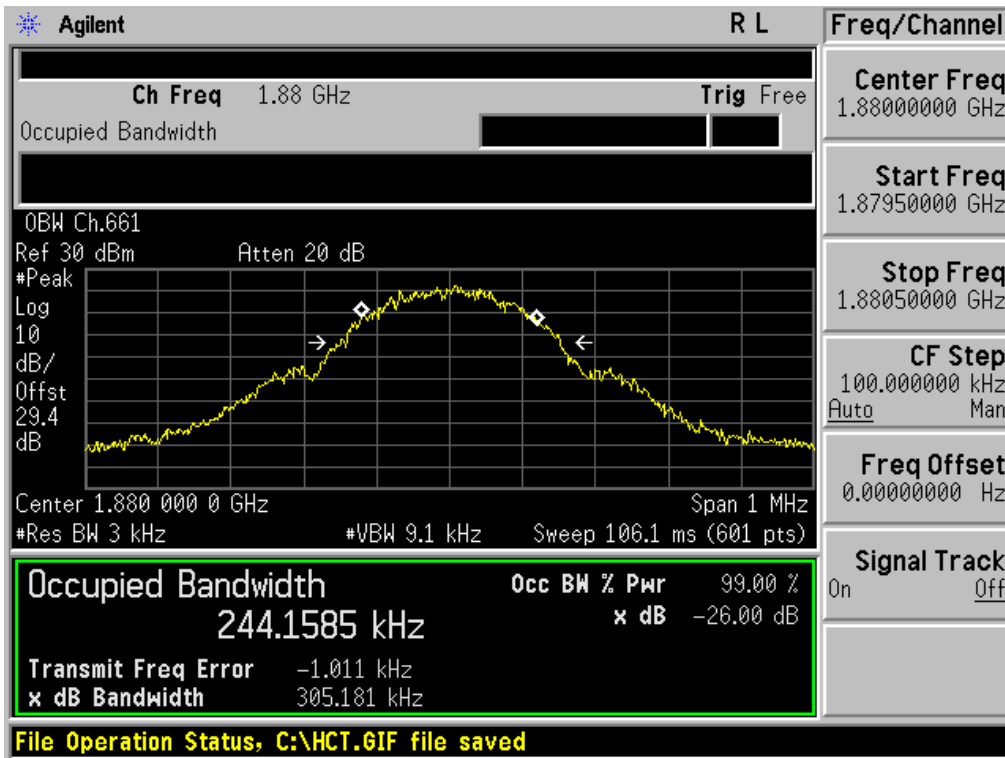

■ GSM1900 MODE (810 CH.) Occupied Bandwidth

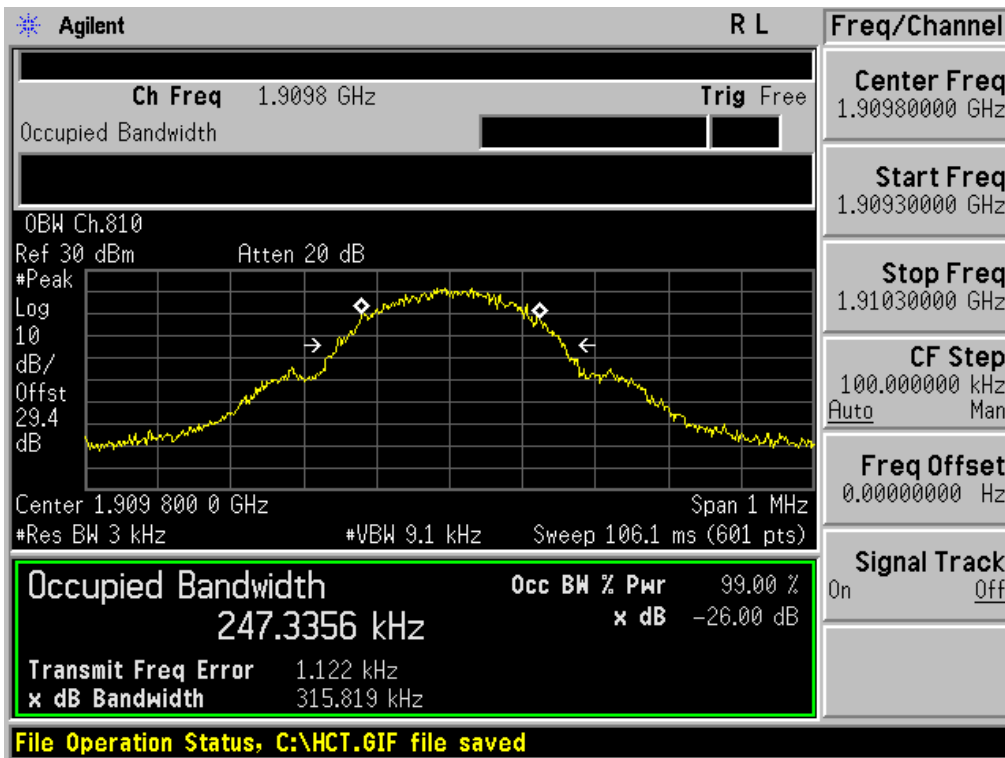

FCC CERTIFICATION REPORT

Test Report No. HCTR1311FR04	Date of Issue: November 13, 2013	EUT Type: Mobile Phone	<a href="http://www.hct.co.kr">www.hct.co.kr</a> FCC ID: A3LGTS7580
---------------------------------	-------------------------------------	---------------------------	---

■ GSM1900 MODE (661 CH.) Peak-to-Average Ratio  $P_{Pk}$



■ GSM1900 MODE (661 CH.) Peak-to-Average Ratio  $P_{Avg}$

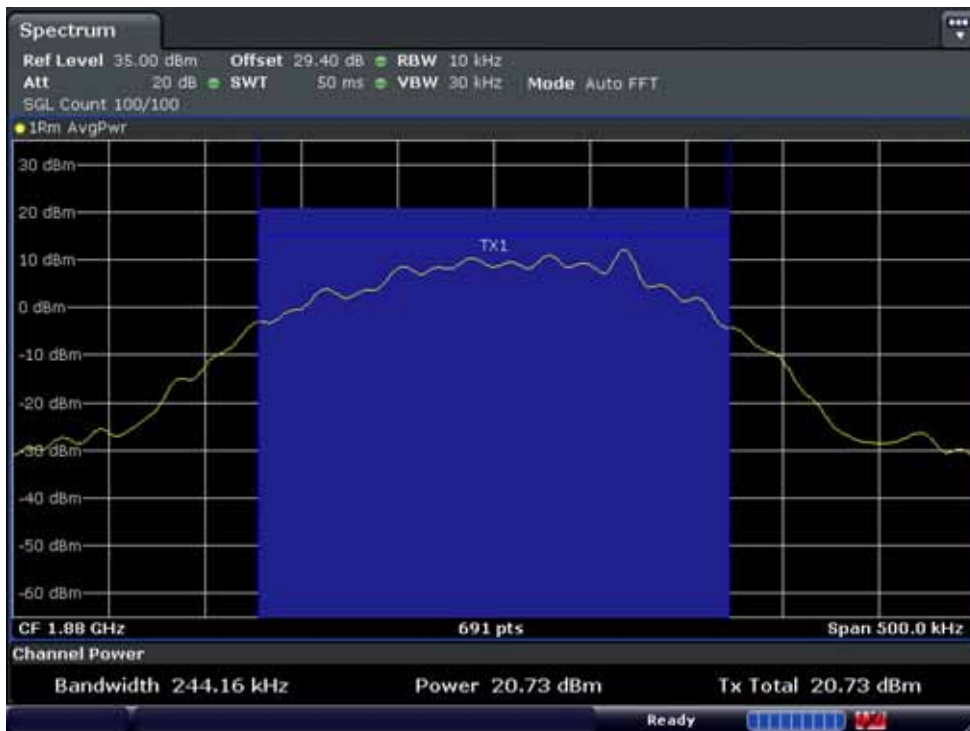

■ GSM1900 MODE (661 CH.) Peak-to-Average Ratio  $P_{Avg}$

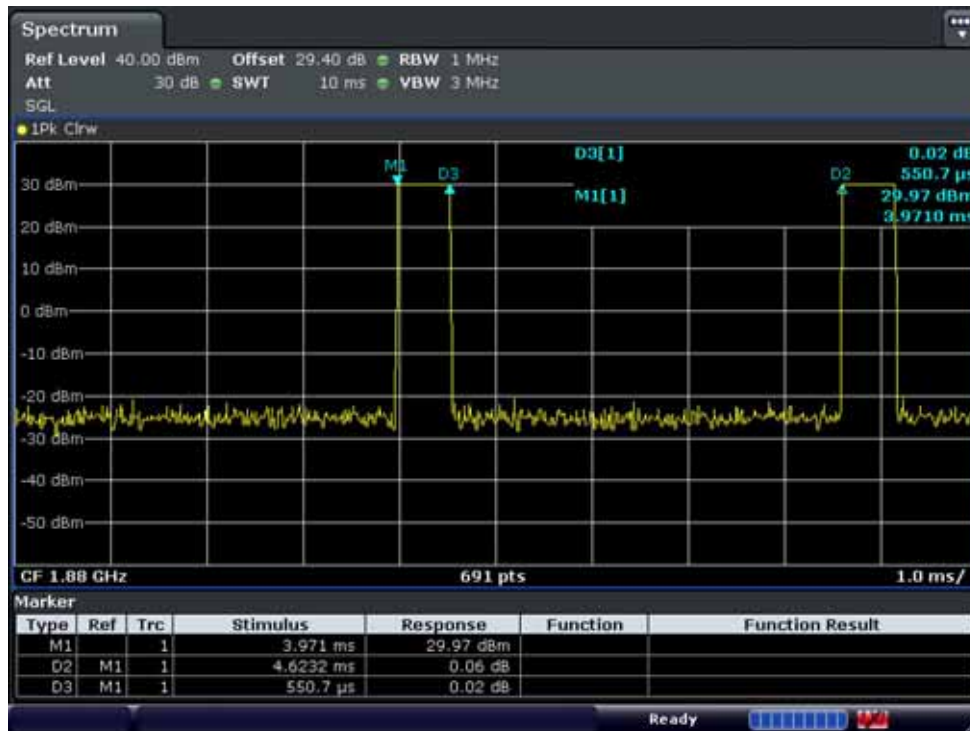

■ WCDMA850 MODE (4132 CH) Occupied Bandwidth

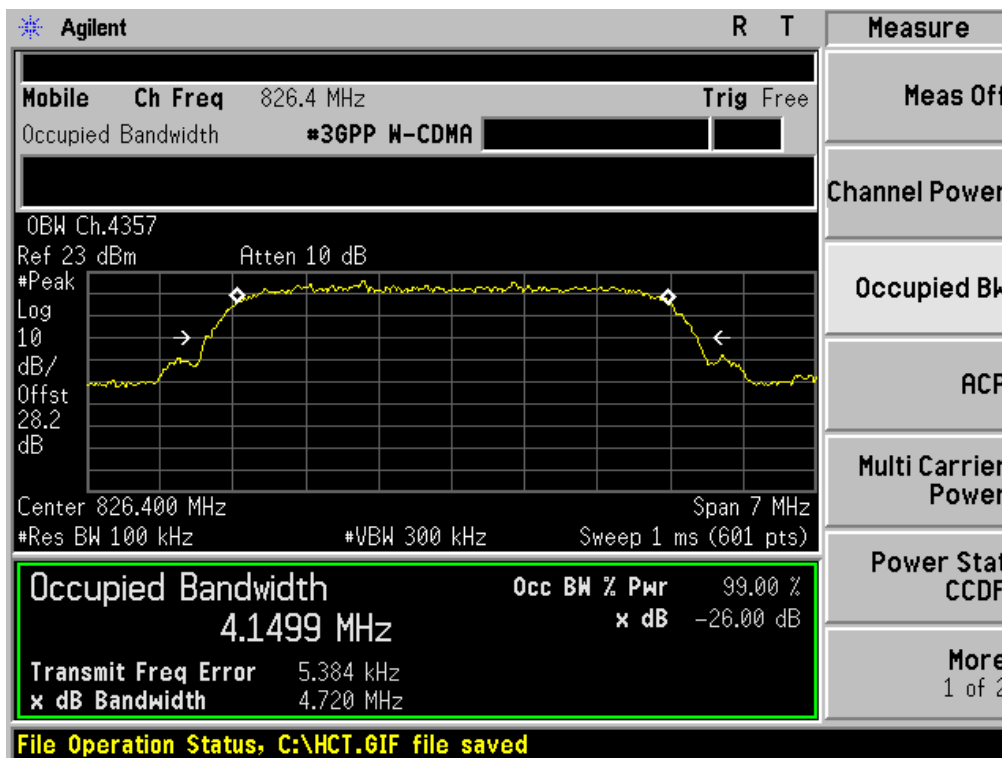

FCC CERTIFICATION REPORT

Test Report No. HCTR1311FR04	Date of Issue: November 13, 2013	EUT Type: Mobile Phone	<a href="http://www.hct.co.kr">www.hct.co.kr</a> FCC ID: A3LGTS7580
---------------------------------	-------------------------------------	---------------------------	---

■ WCDMA850 MODE (4183 CH.) Occupied Bandwidth

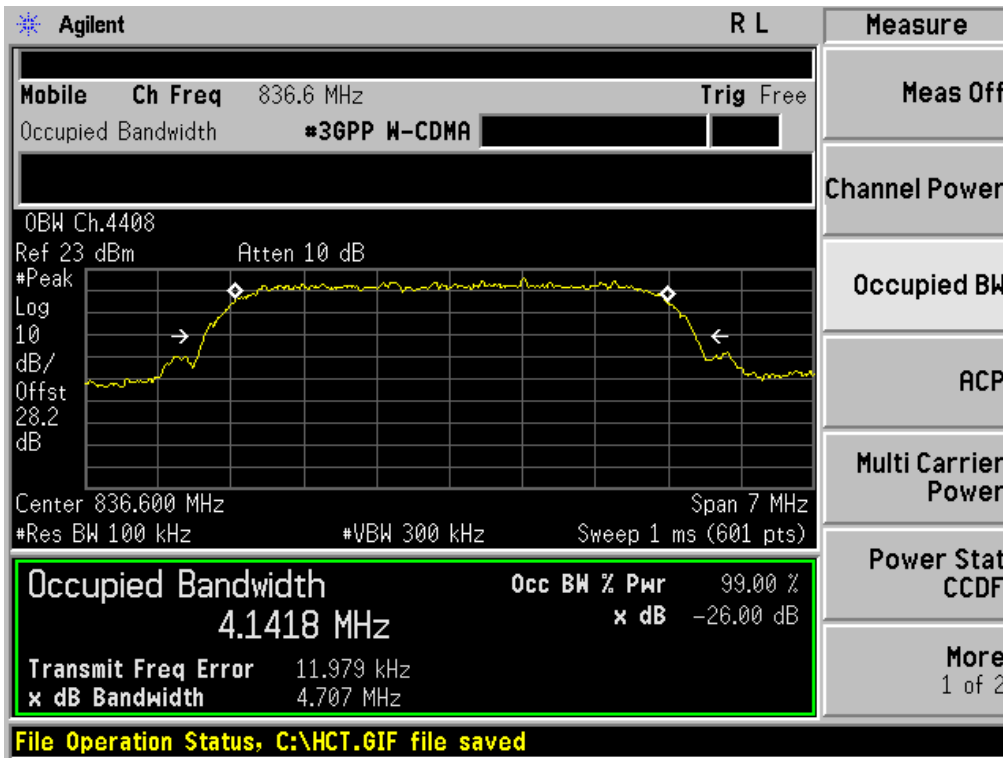

■ WCDMA850MODE (4233 CH.) Occupied Bandwidth

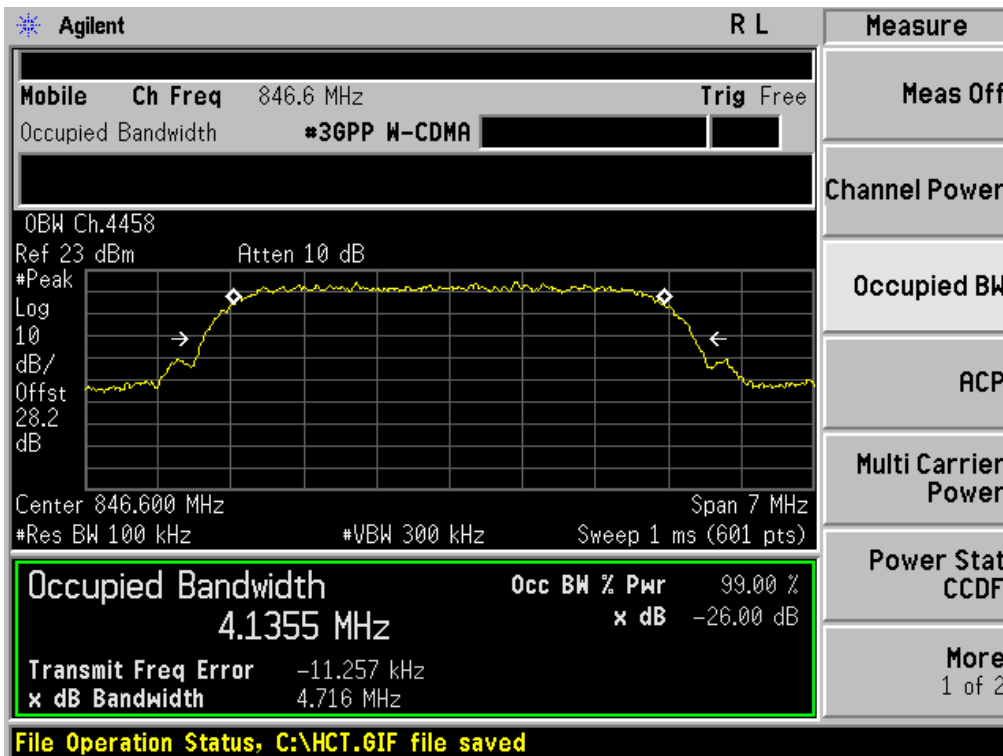

FCC CERTIFICATION REPORT

Test Report No. HCTR1311FR04	Date of Issue: November 13, 2013	EUT Type: Mobile Phone	<a href="http://www.hct.co.kr">www.hct.co.kr</a> FCC ID: A3LGTS7580
---------------------------------	-------------------------------------	---------------------------	---

■ WCDMA1900 MODE (9262 CH.) Occupied Bandwidth

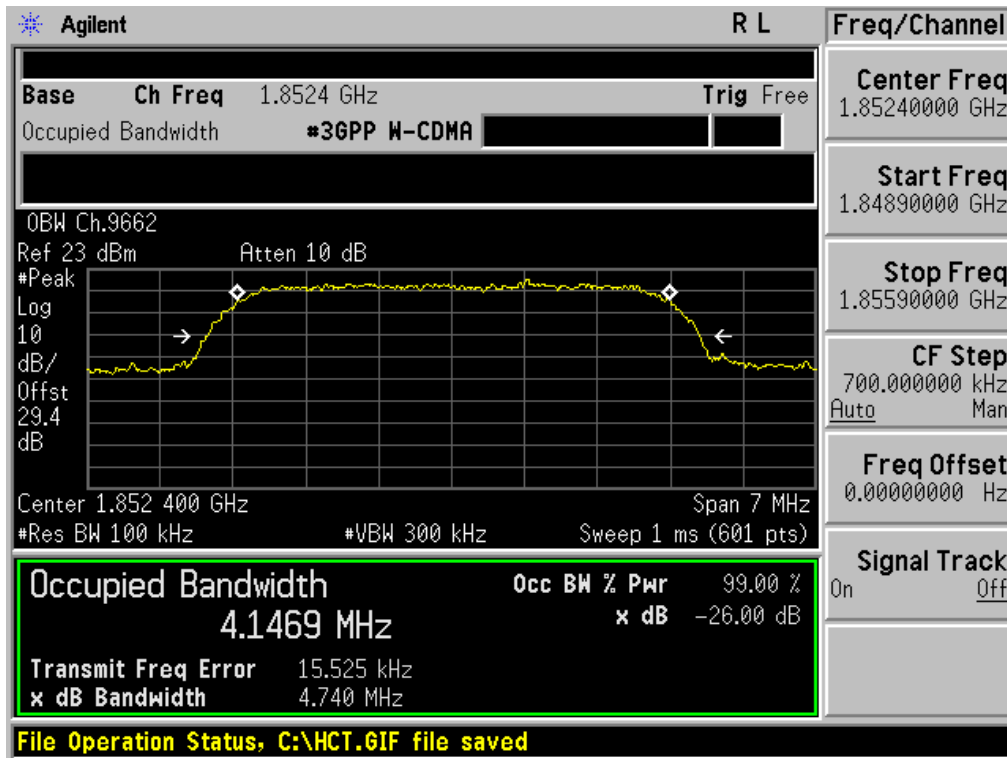

■ WCDMA1900 MODE (9400 CH.) Occupied Bandwidth

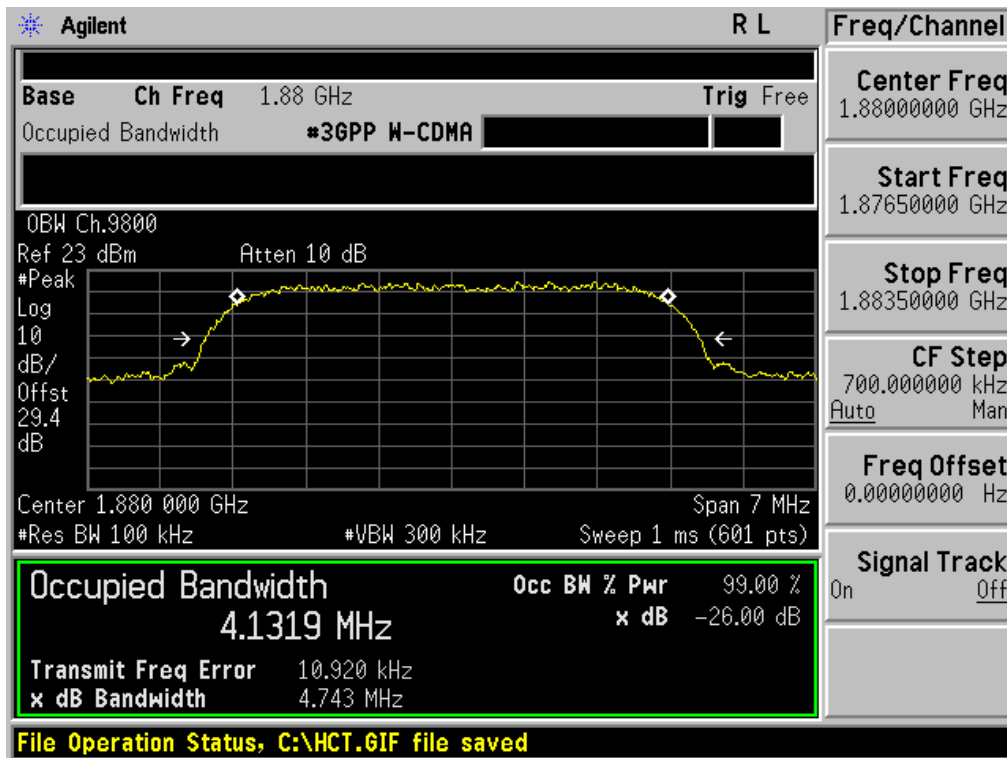

FCC CERTIFICATION REPORT

Test Report No. HCTR1311FR04	Date of Issue: November 13, 2013	EUT Type: Mobile Phone	<a href="http://www.hct.co.kr">www.hct.co.kr</a> FCC ID: A3LGTS7580
---------------------------------	-------------------------------------	---------------------------	---

■ WCDMA1900 MODE (9538 CH.) Occupied Bandwidth

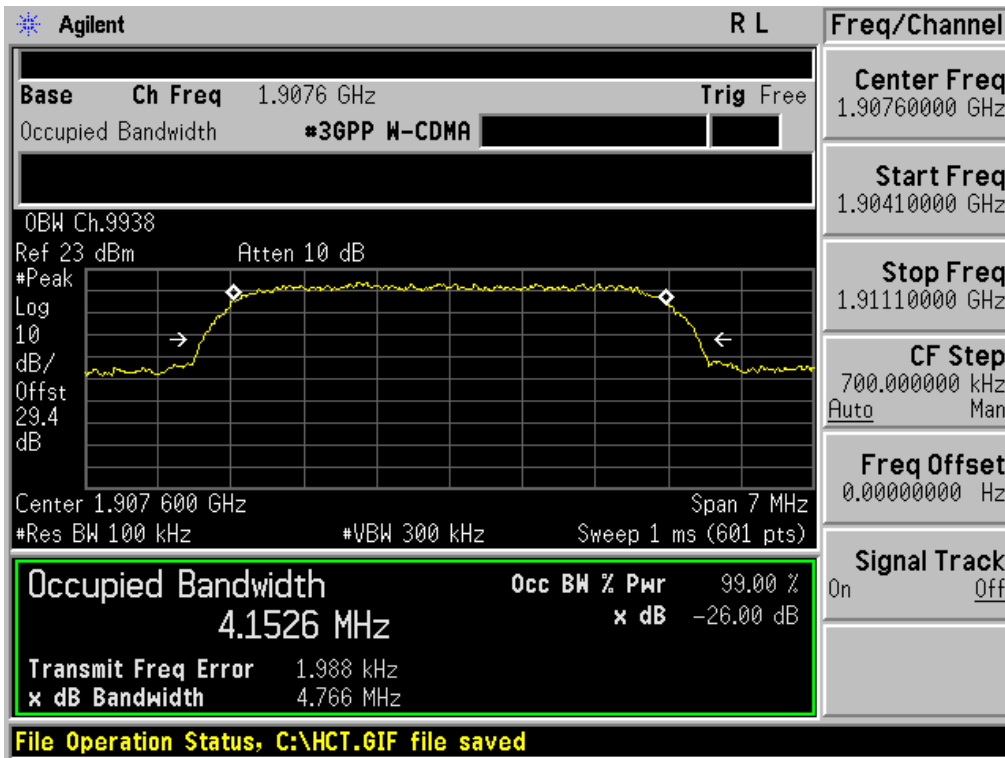

■ WCDMA1900 MODE (9400 CH.) Peak-to-Average Ratio

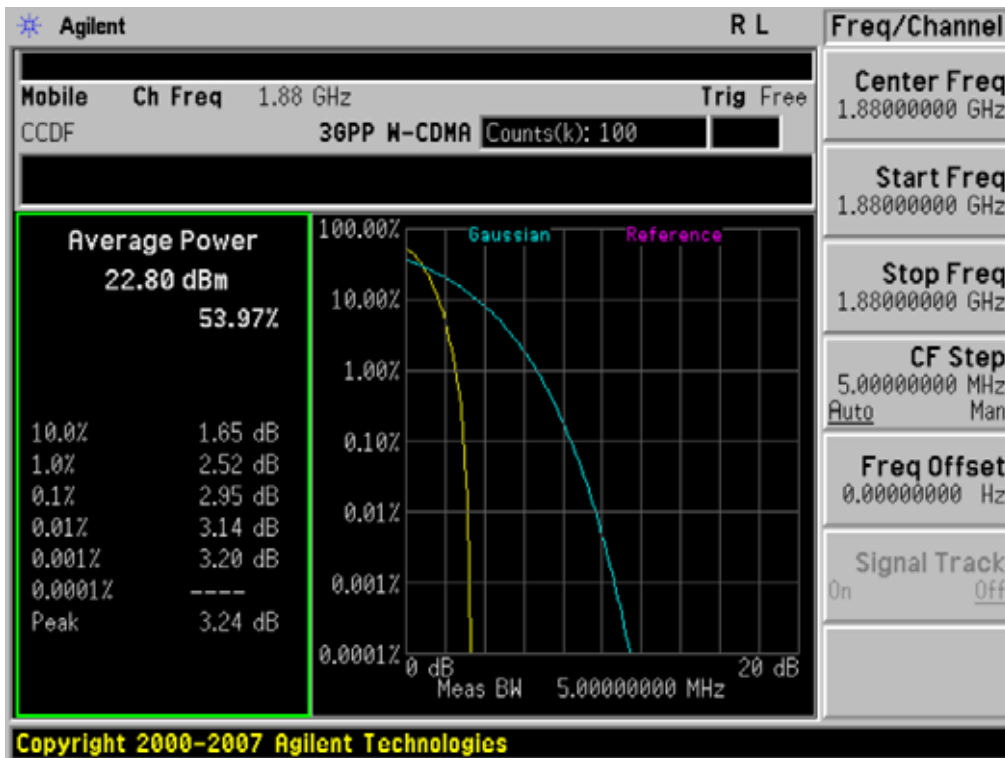

FCC CERTIFICATION REPORT

Test Report No. HCTR1311FR04	Date of Issue: November 13, 2013	EUT Type: Mobile Phone	<a href="http://www.hct.co.kr">www.hct.co.kr</a> FCC ID: A3LGTS7580
---------------------------------	-------------------------------------	---------------------------	---

■ GSM850 MODE (128 CH.) Block Edge 1

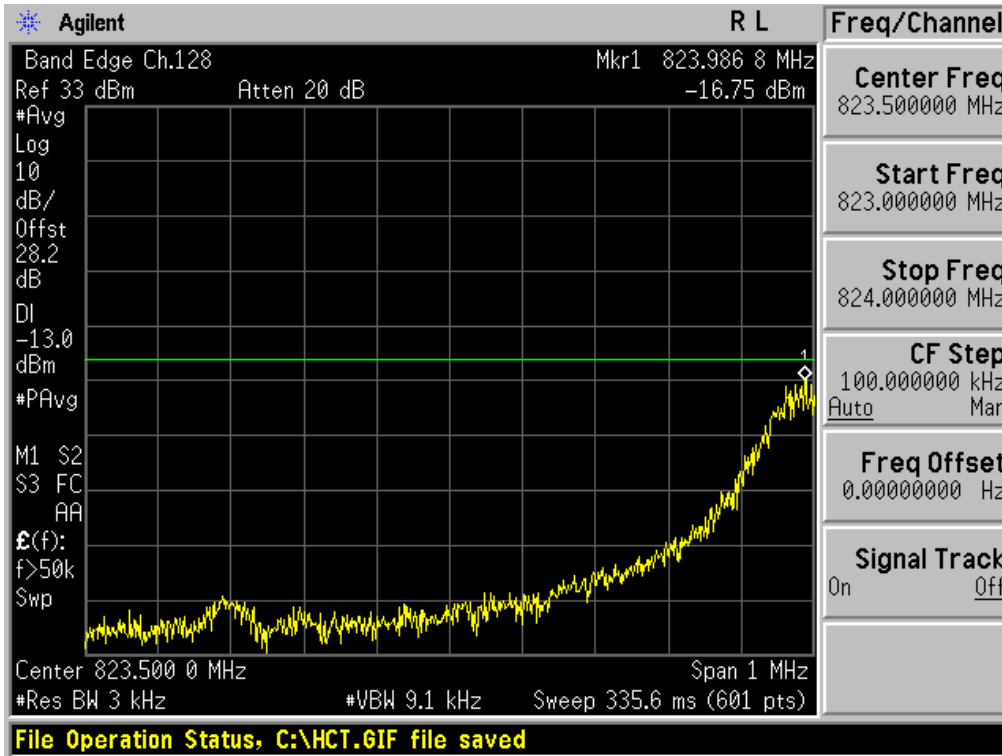

■ GSM850 MODE (128 CH.) Block Edge 2

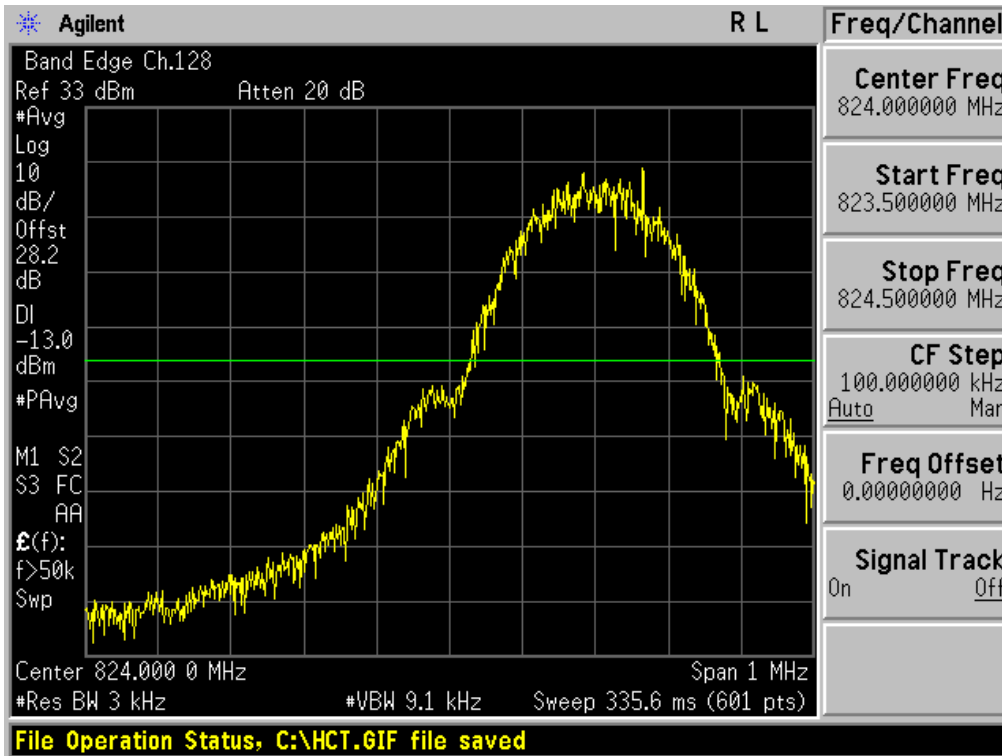

FCC CERTIFICATION REPORT

FCC CERTIFICATION REPORT			<a href="http://www.hct.co.kr">www.hct.co.kr</a>
Test Report No. HCTR1311FR04	Date of Issue: November 13, 2013	EUT Type: Mobile Phone	FCC ID: A3LGTS7580

■ GSM850 MODE (251 CH.) Block Edge 1

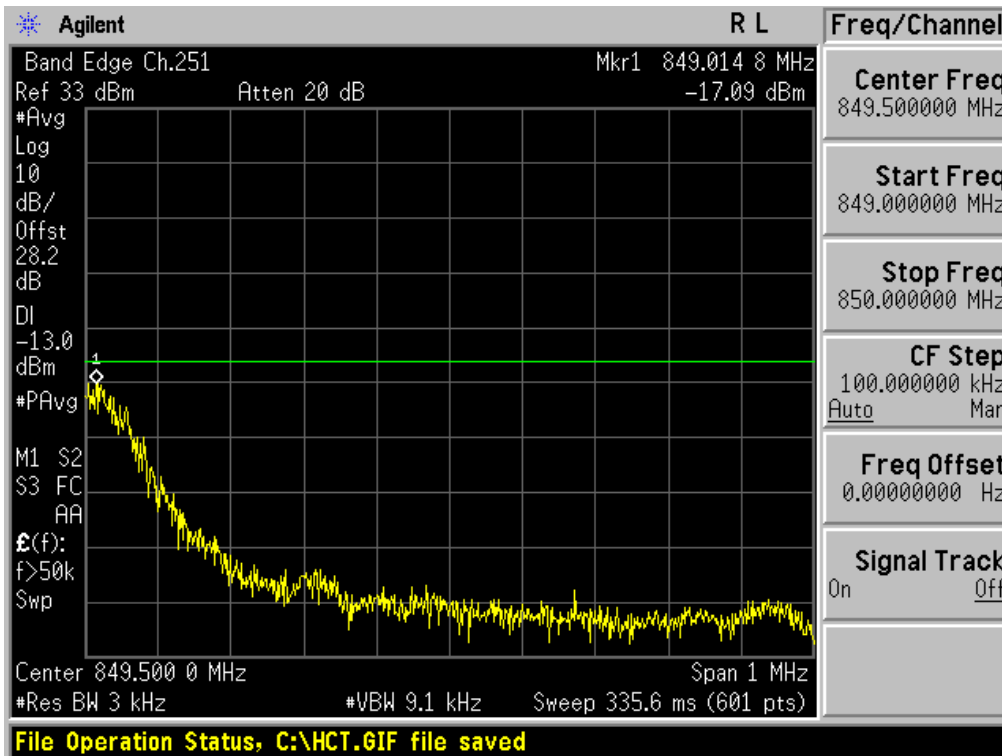

■ GSM850 MODE (251 CH.) Block Edge 2

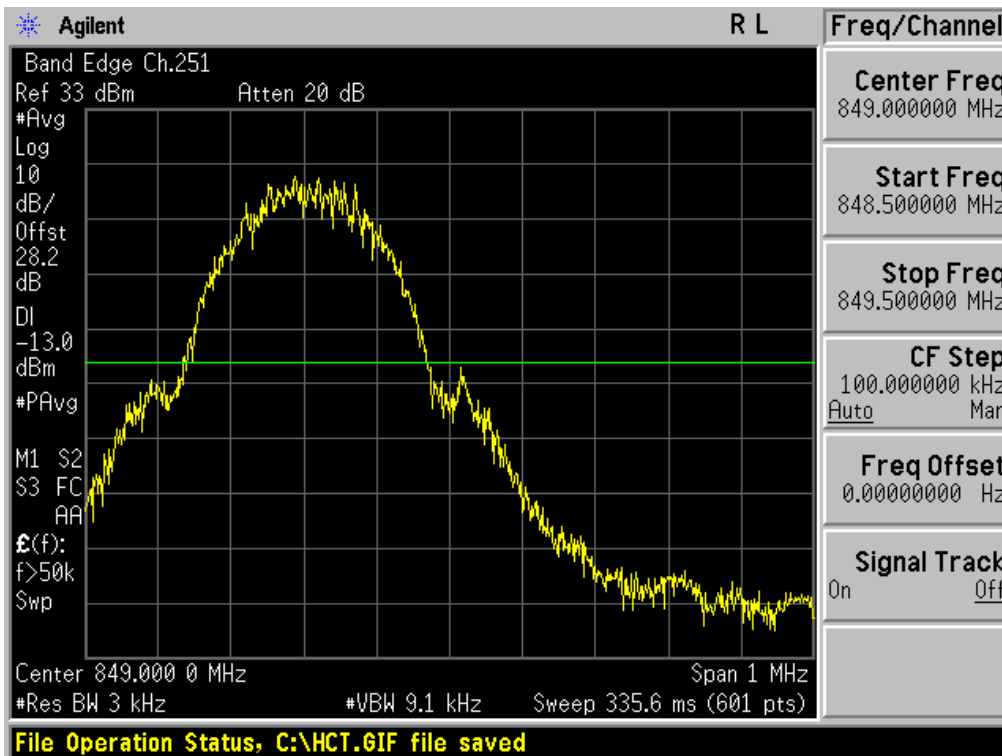

FCC CERTIFICATION REPORT

FCC CERTIFICATION REPORT			<a href="http://www.hct.co.kr">www.hct.co.kr</a>
Test Report No. HCTR1311FR04	Date of Issue: November 13, 2013	EUT Type: Mobile Phone	FCC ID: A3LGTS7580

■ GSM1900 MODE (512 CH.) Block Edge 1

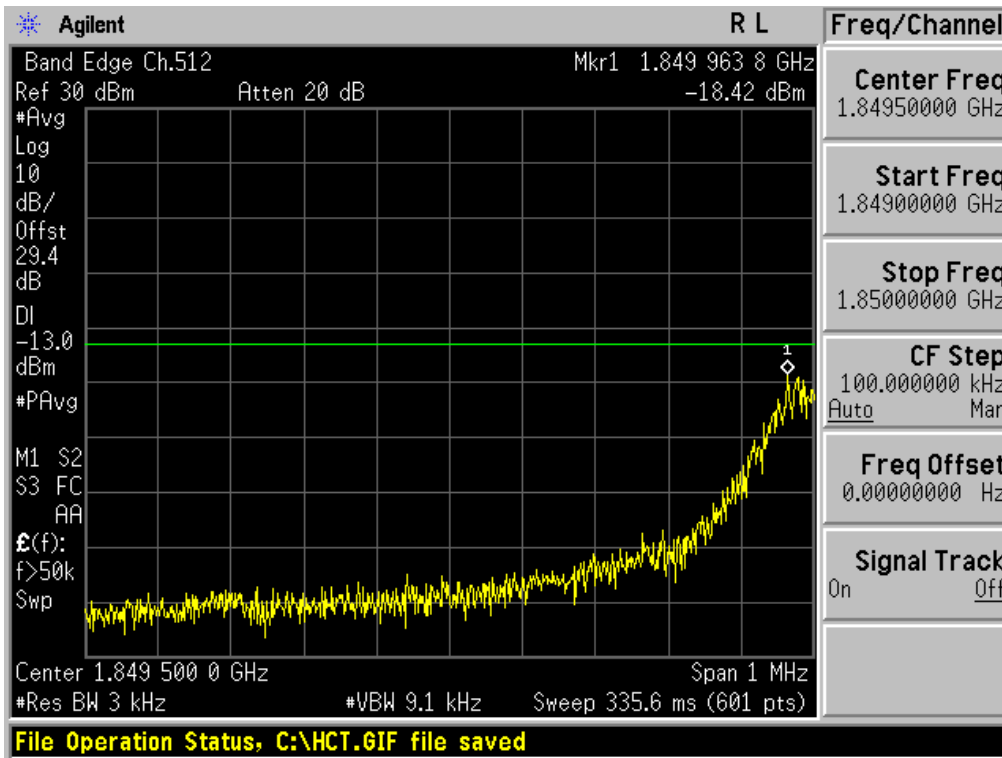

■ GSM1900 MODE (512 CH.) Block Edge 2

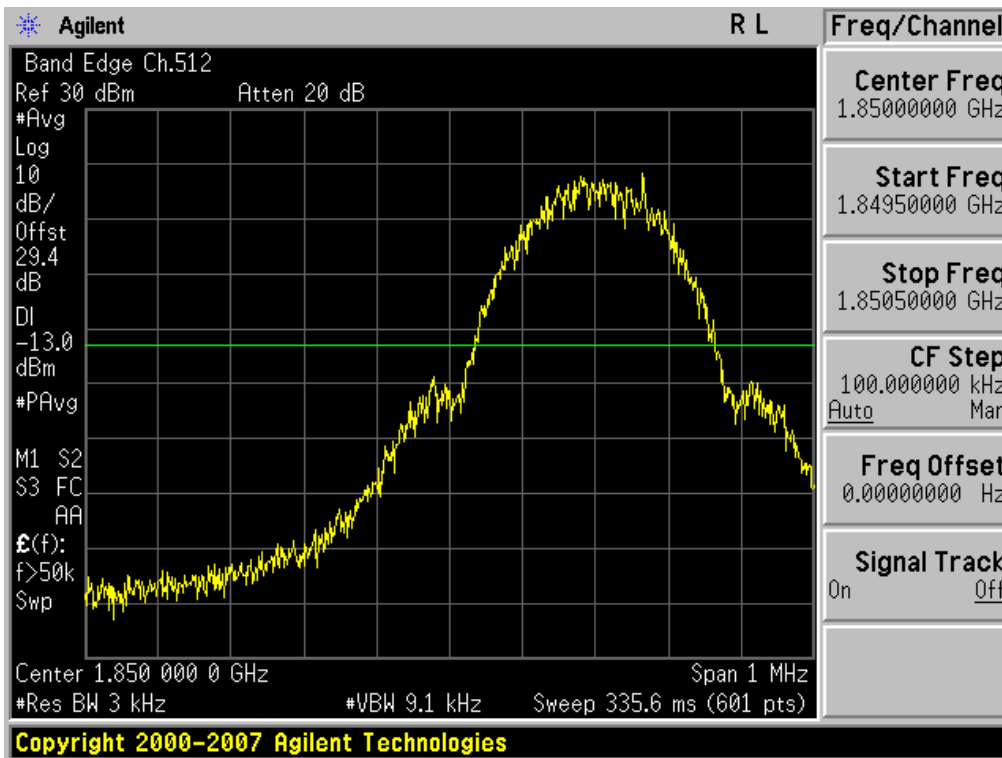

FCC CERTIFICATION REPORT

FCC CERTIFICATION REPORT			<a href="http://www.hct.co.kr">www.hct.co.kr</a>
Test Report No. HCTR1311FR04	Date of Issue: November 13, 2013	EUT Type: Mobile Phone	FCC ID: A3LGTS7580

■ GSM1900 MODE (810 CH.) Block Edge 1

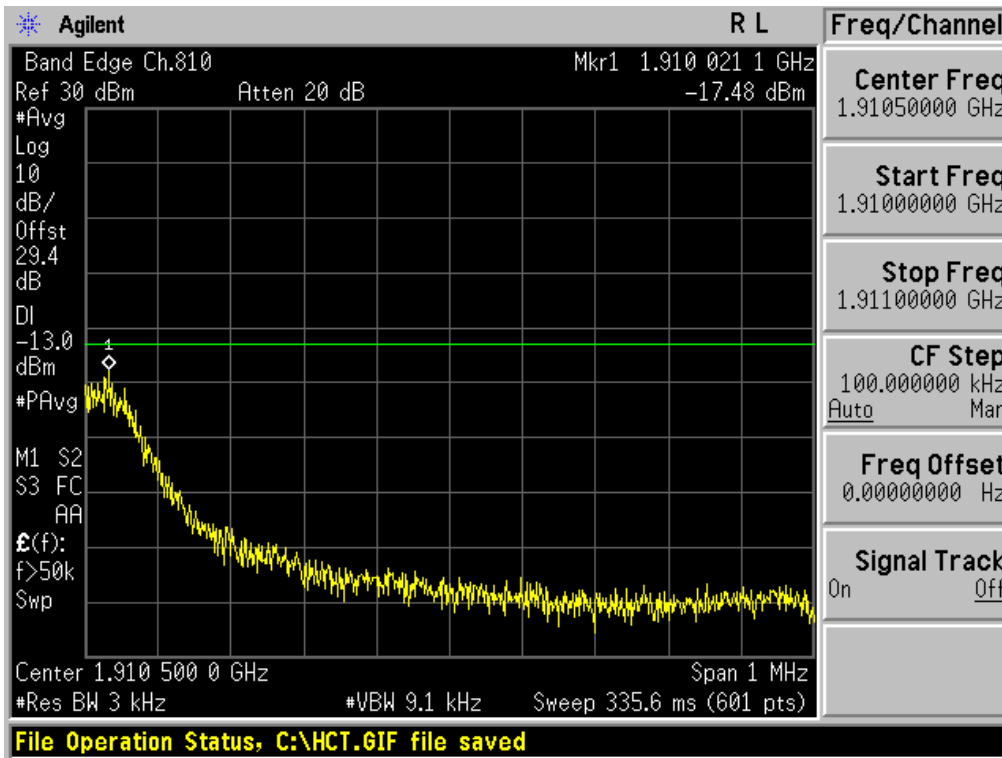

■ GSM1900 MODE (810 CH.) Block Edge 2

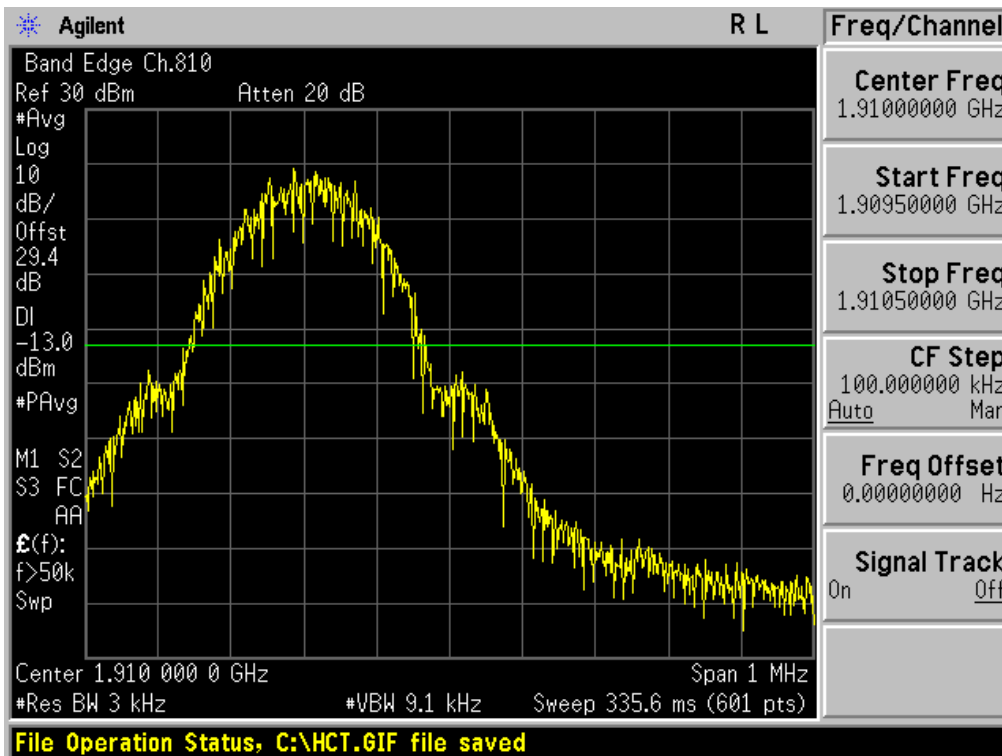

FCC CERTIFICATION REPORT

Test Report No. HCTR1311FR04	Date of Issue: November 13, 2013	EUT Type: Mobile Phone	<a href="http://www.hct.co.kr">www.hct.co.kr</a> FCC ID: A3LGTS7580
---------------------------------	-------------------------------------	---------------------------	---

■ WCDMA850 MODE (4132 CH.) Block Edge

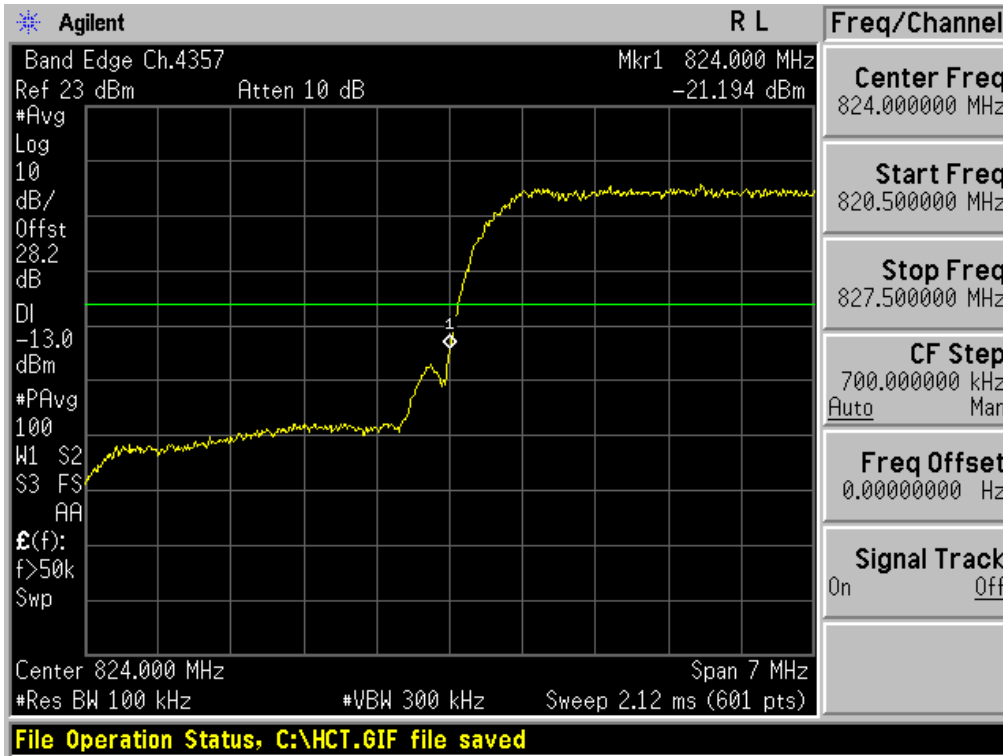

■ WCDMA850MODE (4233 CH.) Block Edge

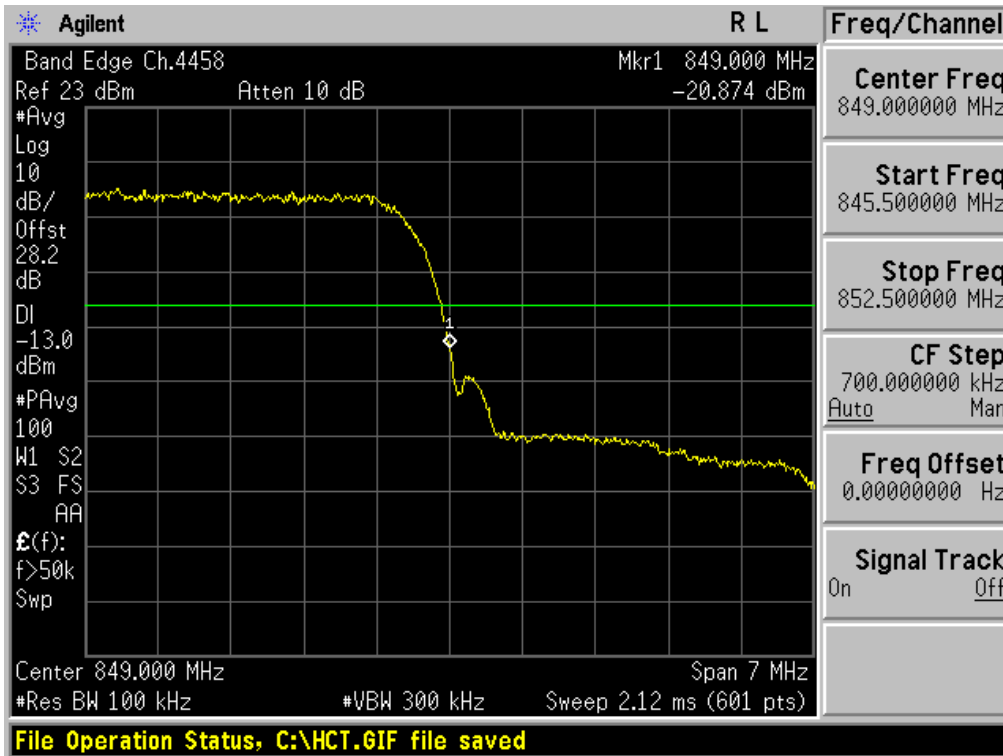

FCC CERTIFICATION REPORT

FCC CERTIFICATION REPORT			<a href="http://www.hct.co.kr">www.hct.co.kr</a>
Test Report No. HCTR1311FR04	Date of Issue: November 13, 2013	EUT Type: Mobile Phone	FCC ID: A3LGTS7580

■ WCDMA850 MODE (4132 CH.) – 4 MHz Span

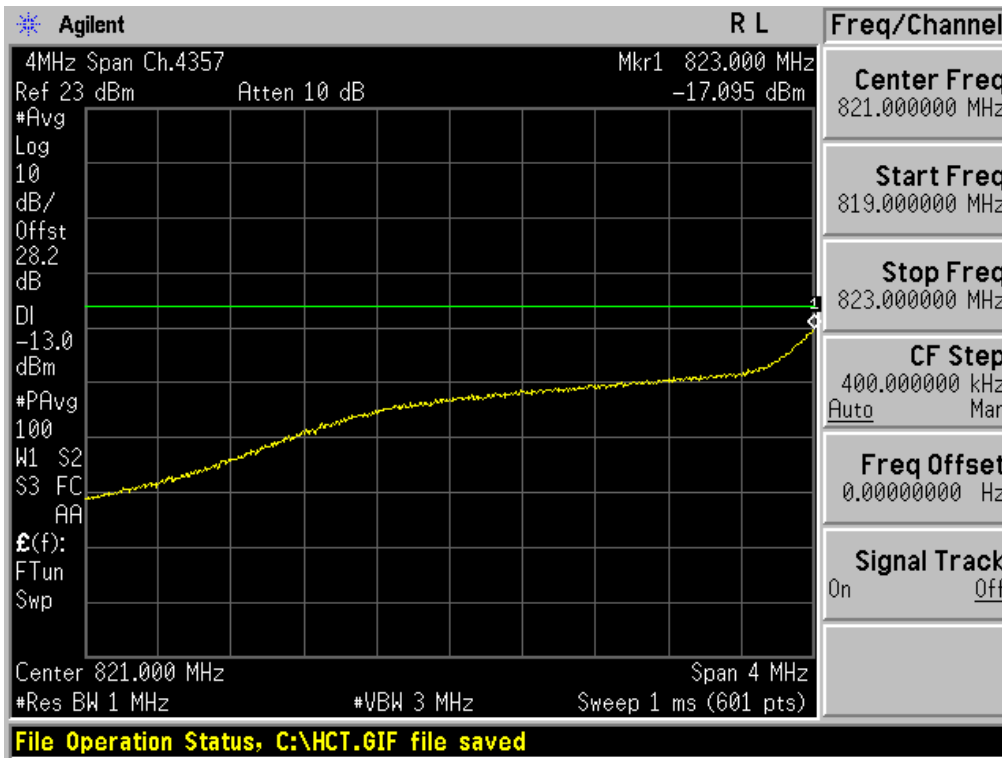

■ WCDMA850MODE (4233 CH.) – 4 MHz Span

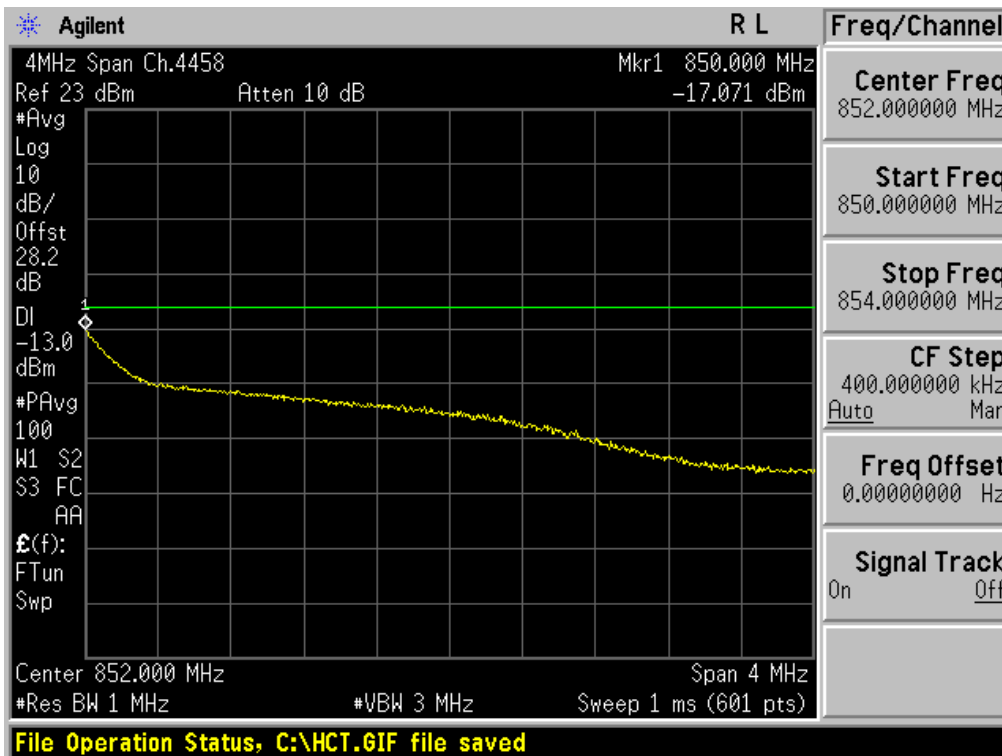

FCC CERTIFICATION REPORT

FCC CERTIFICATION REPORT			<a href="http://www.hct.co.kr">www.hct.co.kr</a>
Test Report No. HCTR1311FR04	Date of Issue: November 13, 2013	EUT Type: Mobile Phone	FCC ID: A3LGTS7580

■ WCDMA1900 MODE (9262 CH.) Block Edge

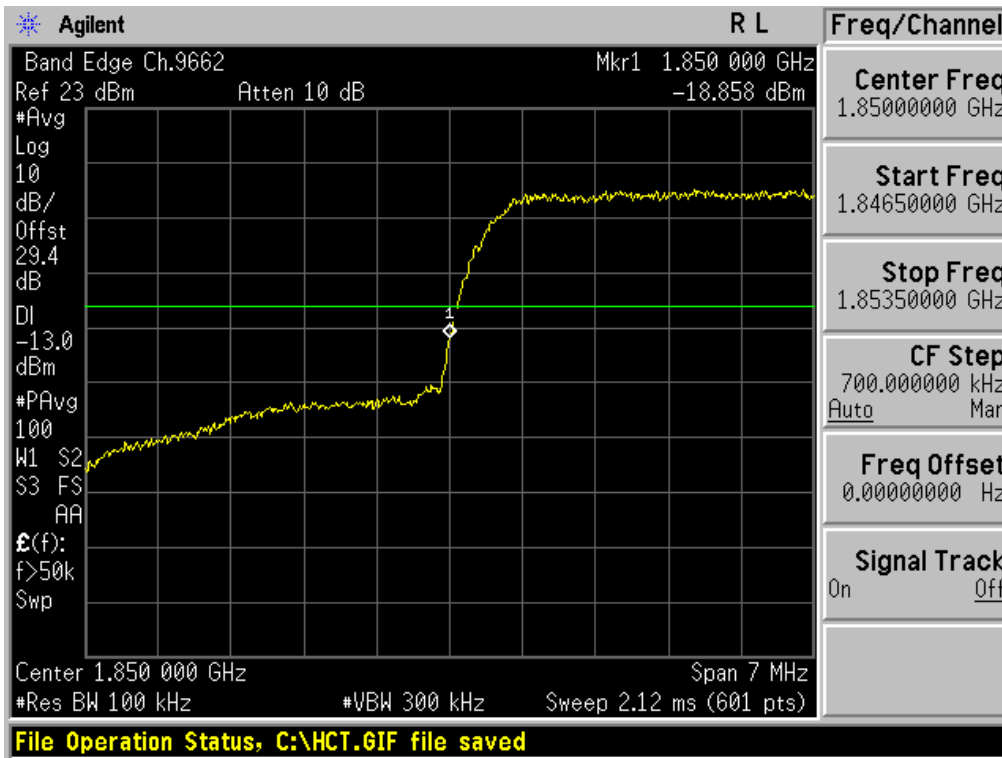

■ WCDMA1900 MODE (9538 CH.) Block Edge

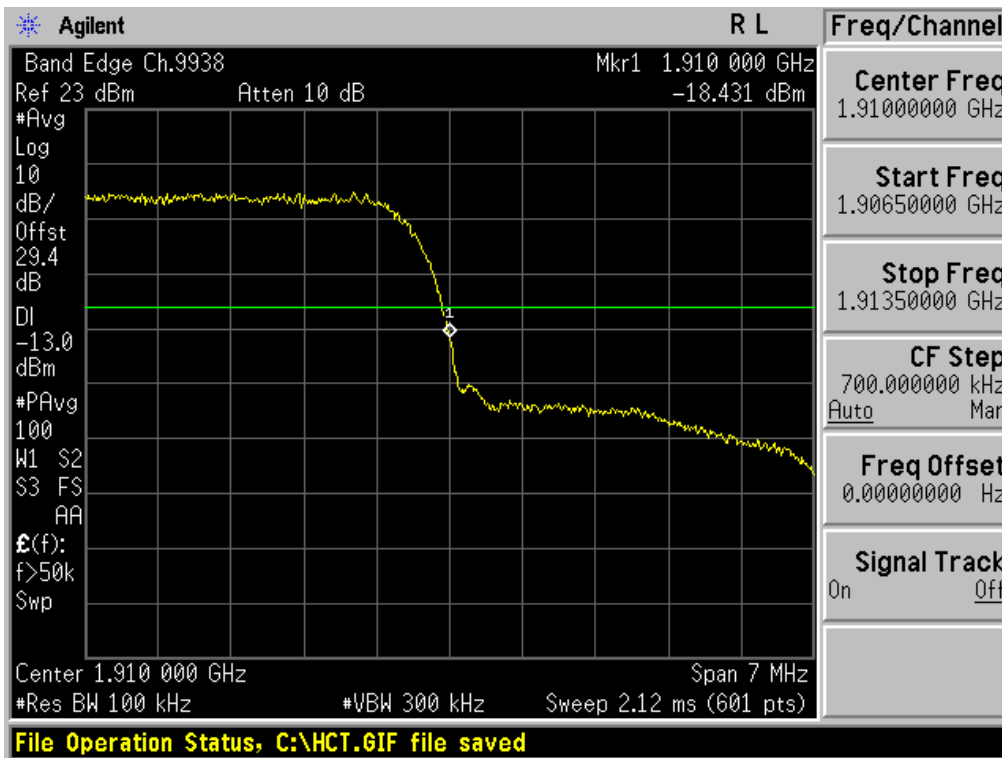

FCC CERTIFICATION REPORT

Test Report No. HCTR1311FR04	Date of Issue: November 13, 2013	EUT Type: Mobile Phone	<a href="http://www.hct.co.kr">www.hct.co.kr</a> FCC ID: A3LGTS7580
---------------------------------	-------------------------------------	---------------------------	---

■ WCDMA1900 MODE (9262 CH.) – 4 MHz Span

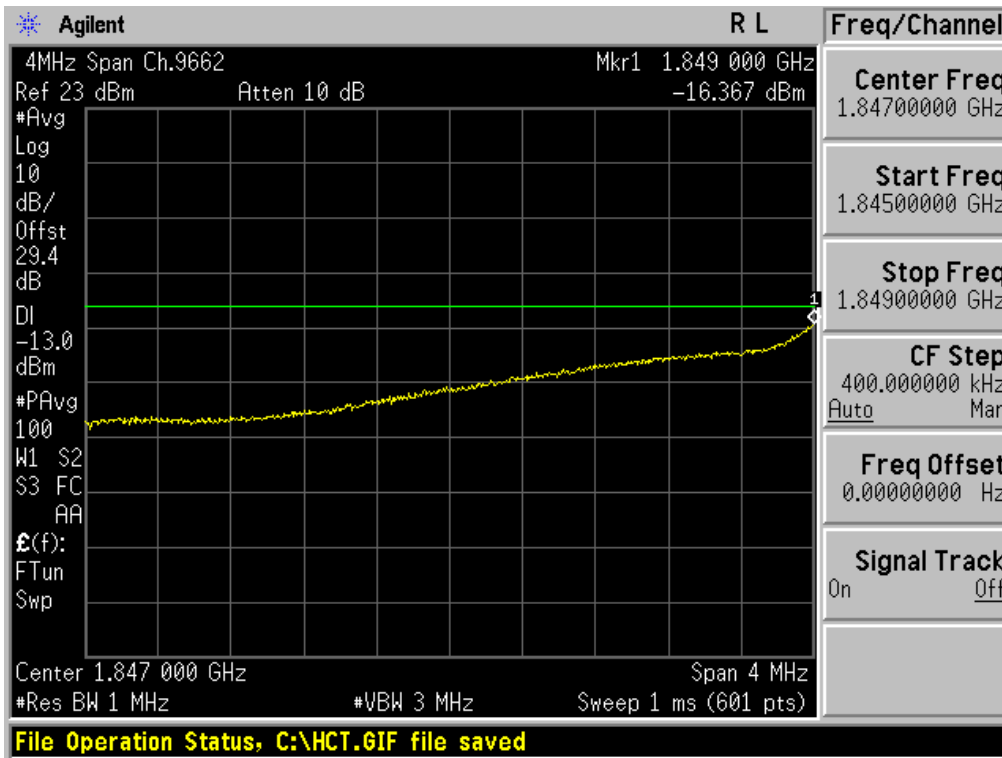

■ WCDMA1900 MODE (9538 CH.) – 4 MHz Span

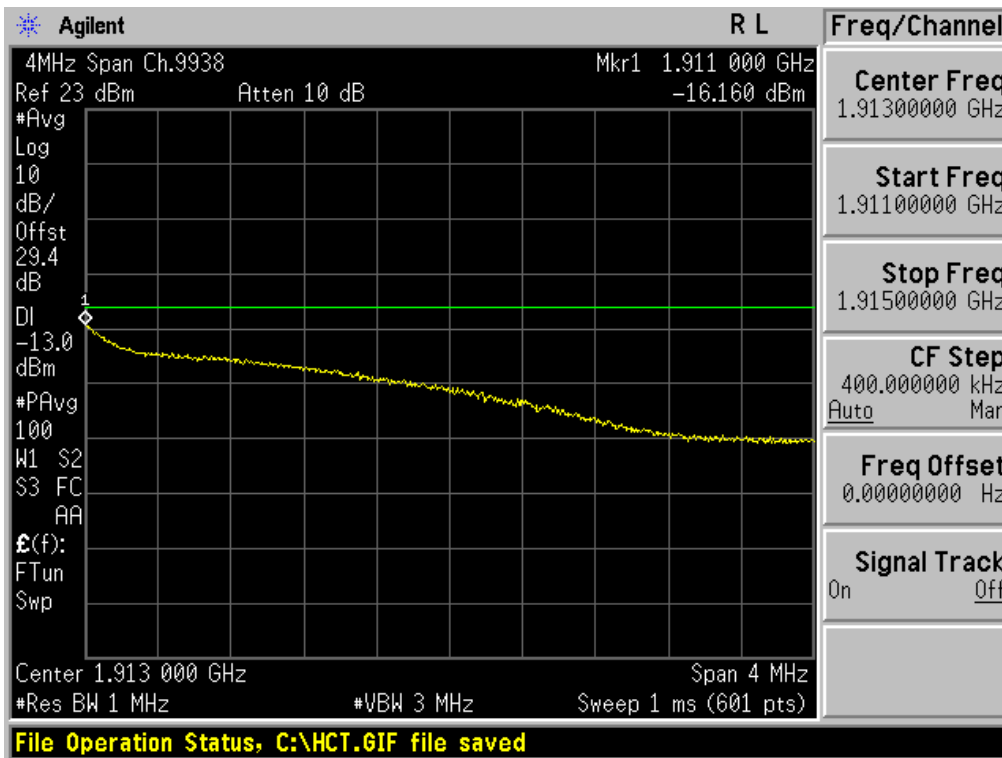

FCC CERTIFICATION REPORT

FCC CERTIFICATION REPORT			<a href="http://www.hct.co.kr">www.hct.co.kr</a>
Test Report No. HCTR1311FR04	Date of Issue: November 13, 2013	EUT Type: Mobile Phone	FCC ID: A3LGTS7580

■ GSM850 MODE (128 CH.) Conducted Spurious Emissions1

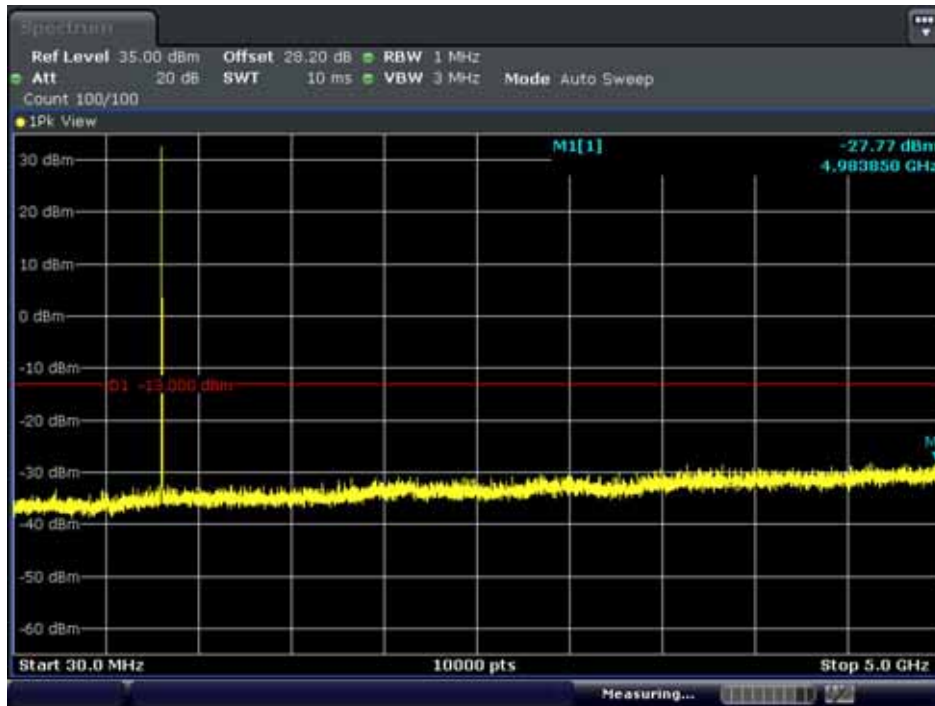

Date: 7.NOV.2013 03:53:46

■ GSM850 MODE (128 CH.) Conducted Spurious Emissions2

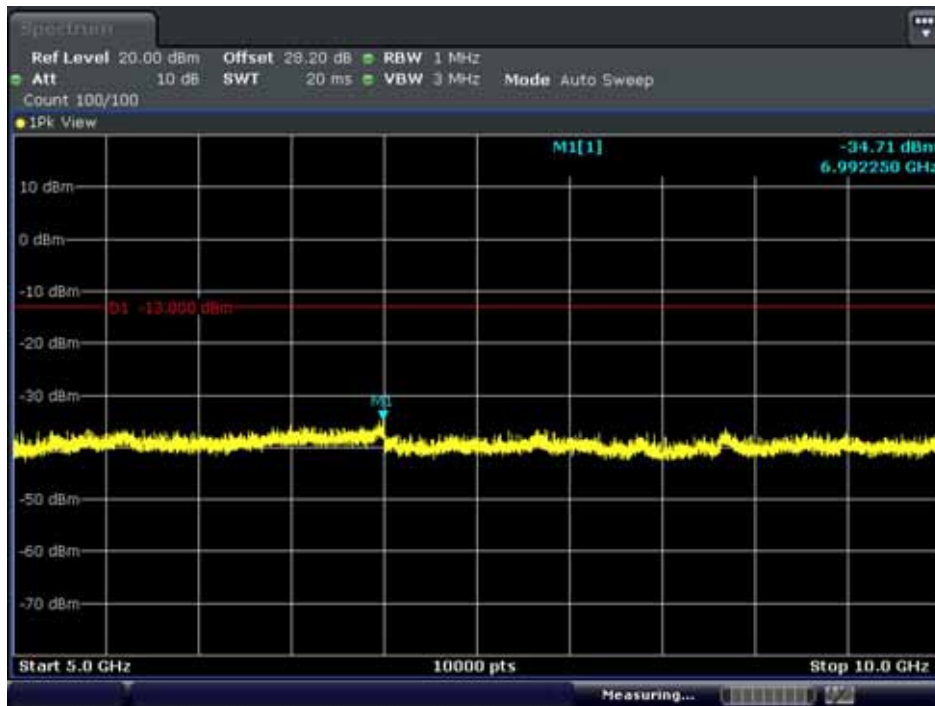

Date: 7.NOV.2013 03:54:03

FCC CERTIFICATION REPORT

Test Report No. HCTR1311FR04	Date of Issue: November 13, 2013	EUT Type: Mobile Phone	<a href="http://www.hct.co.kr">www.hct.co.kr</a> FCC ID: A3LGTS7580
---------------------------------	-------------------------------------	---------------------------	---

■ GSM850 MODE (190 CH.) Conducted Spurious Emissions1

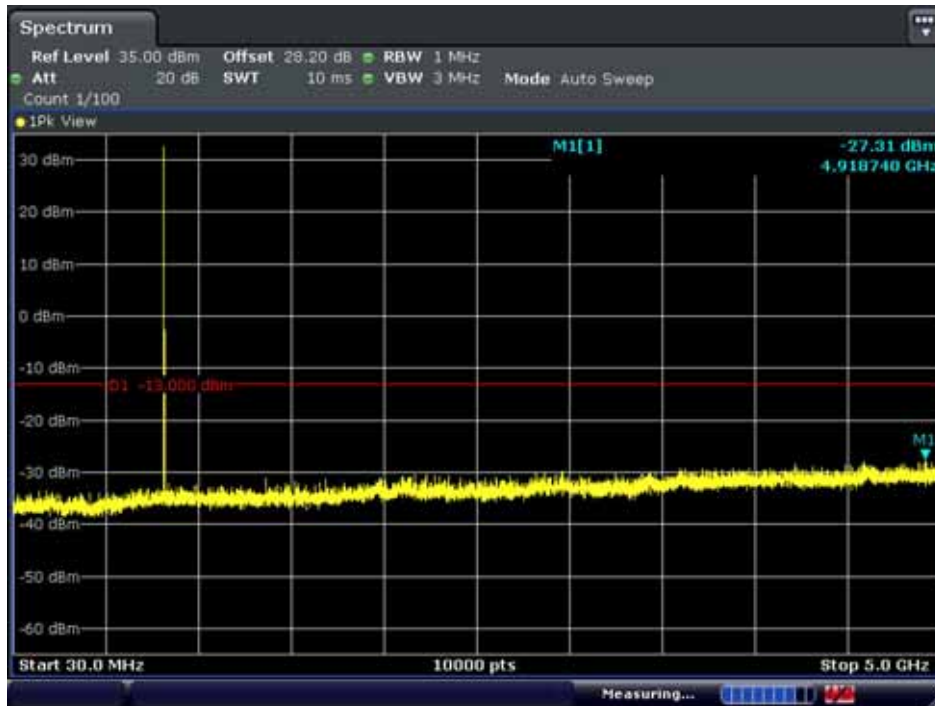

Date: 7.NOV.2013 03:54:16

■ GSM850 MODE (190 CH.) Conducted Spurious Emissions2

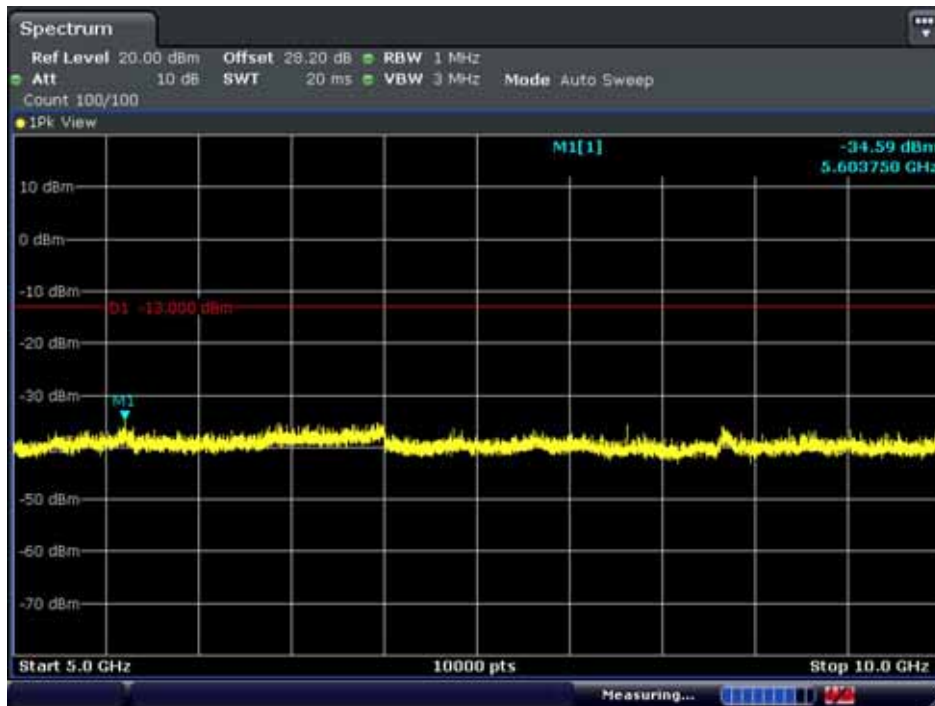

Date: 7.NOV.2013 03:54:33

FCC CERTIFICATION REPORT

FCC CERTIFICATION REPORT			<a href="http://www.hct.co.kr">www.hct.co.kr</a>
Test Report No. HCTR1311FR04	Date of Issue: November 13, 2013	EUT Type: Mobile Phone	FCC ID: A3LGTS7580

■ GSM850 MODE (251 CH.) Conducted Spurious Emissions1

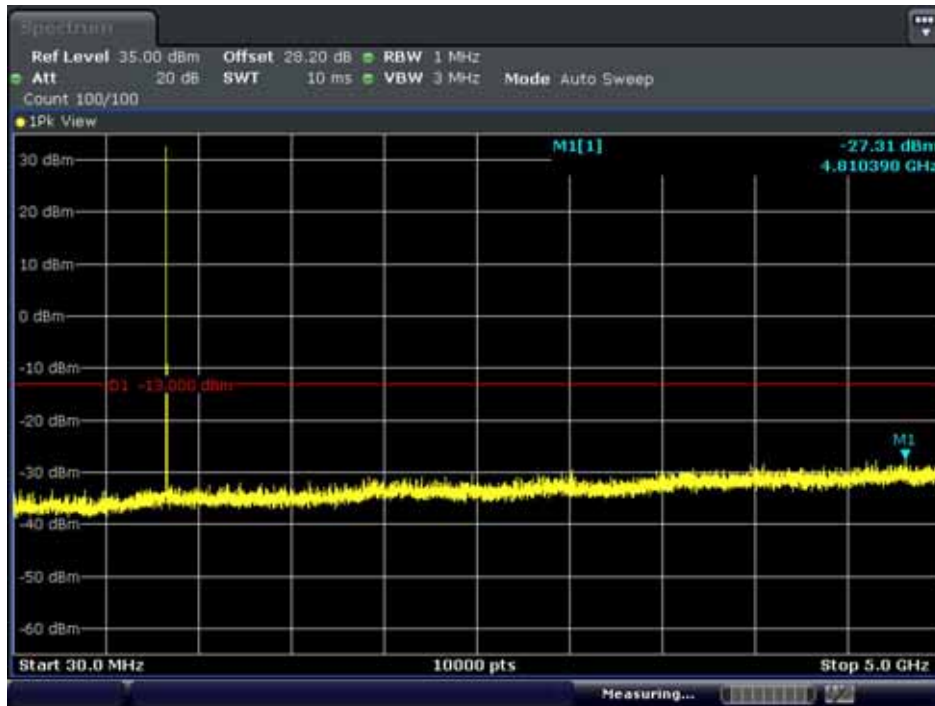

Date: 7.NOV.2013 03:54:47

■ GSM850 MODE (251 CH.) Conducted Spurious Emissions2

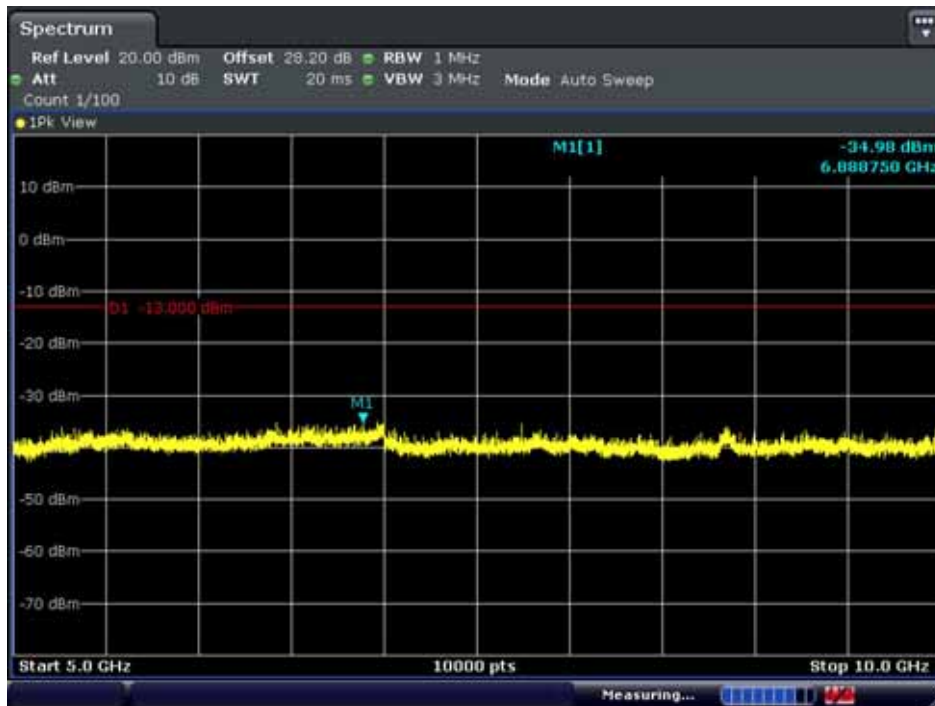

Date: 7.NOV.2013 03:55:03

FCC CERTIFICATION REPORT

FCC CERTIFICATION REPORT			<a href="http://www.hct.co.kr">www.hct.co.kr</a>
Test Report No. HCTR1311FR04	Date of Issue: November 13, 2013	EUT Type: Mobile Phone	FCC ID: A3LGTS7580

■ GSM1900 MODE (512 CH.) Conducted Spurious Emissions1

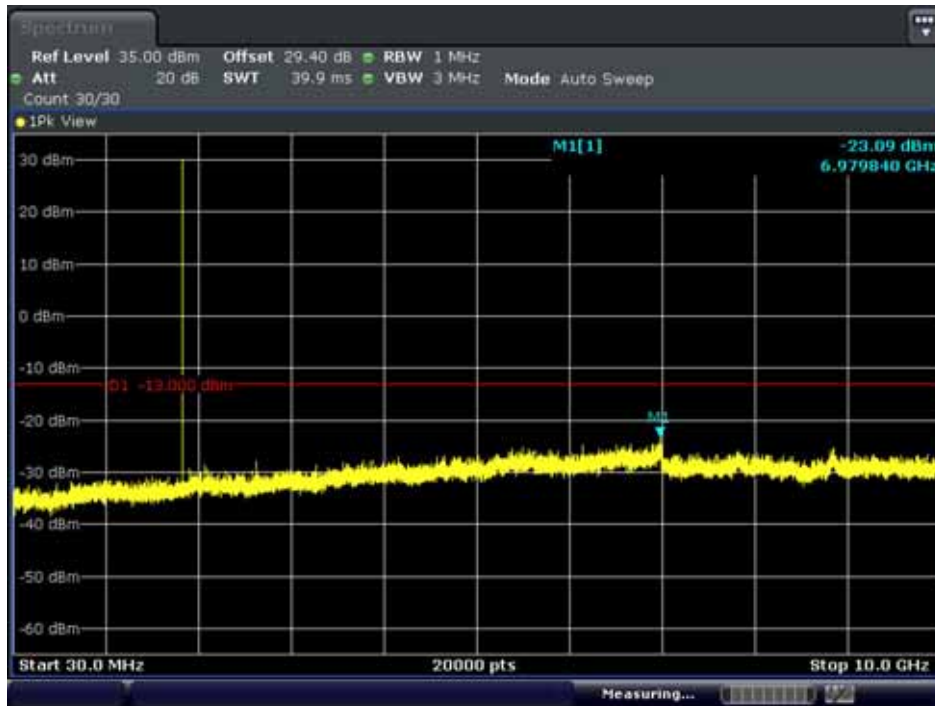

Date: 7.NOV.2013 03:55:33

■ GSM1900 MODE (512 CH.) Conducted Spurious Emissions2

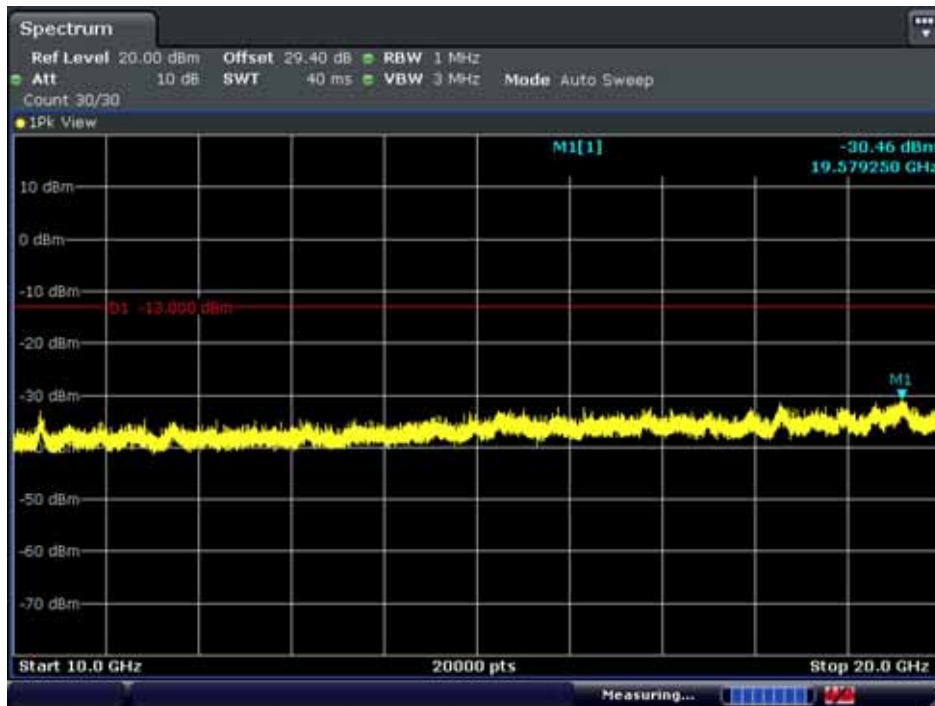

Date: 7.NOV.2013 03:55:48

FCC CERTIFICATION REPORT

FCC CERTIFICATION REPORT			<a href="http://www.hct.co.kr">www.hct.co.kr</a>
Test Report No. HCTR1311FR04	Date of Issue: November 13, 2013	EUT Type: Mobile Phone	FCC ID: A3LGTS7580

■ GSM1900 MODE (661 CH) Conducted Spurious Emissions1

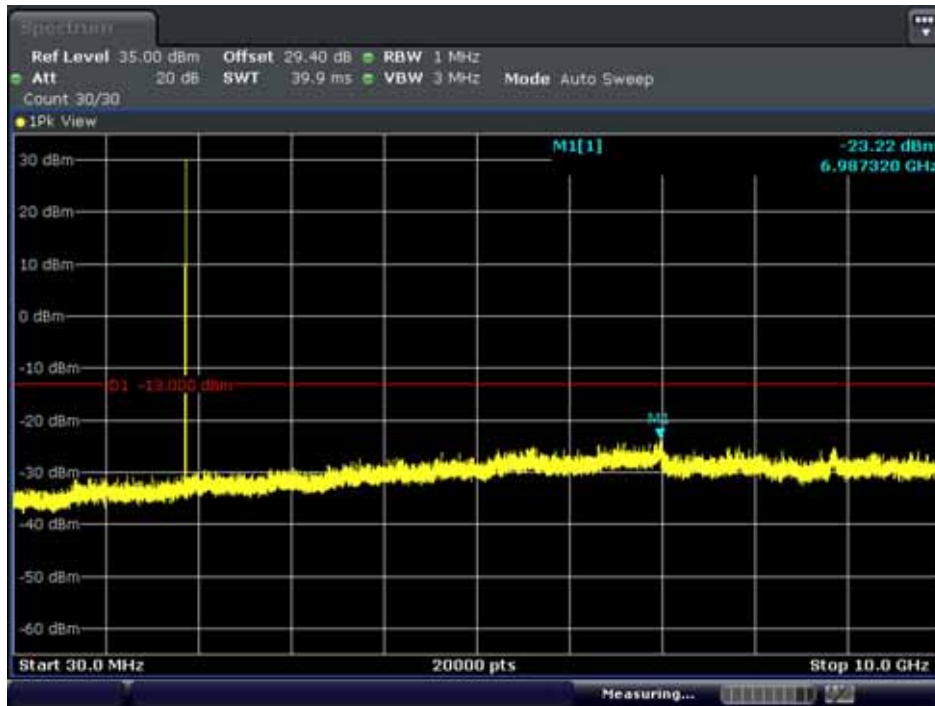

Date: 7.NOV.2013 03:56:06

■ GSM1900 MODE (661 CH.) Conducted Spurious Emissions2



Date: 7.NOV.2013 03:56:22

FCC CERTIFICATION REPORT

Test Report No. HCTR1311FR04	Date of Issue: November 13, 2013	EUT Type: Mobile Phone	<a href="http://www.hct.co.kr">www.hct.co.kr</a> FCC ID: A3LGTS7580
---------------------------------	-------------------------------------	---------------------------	---

■ GSM1900 MODE (810 CH.) Conducted Spurious Emissions1

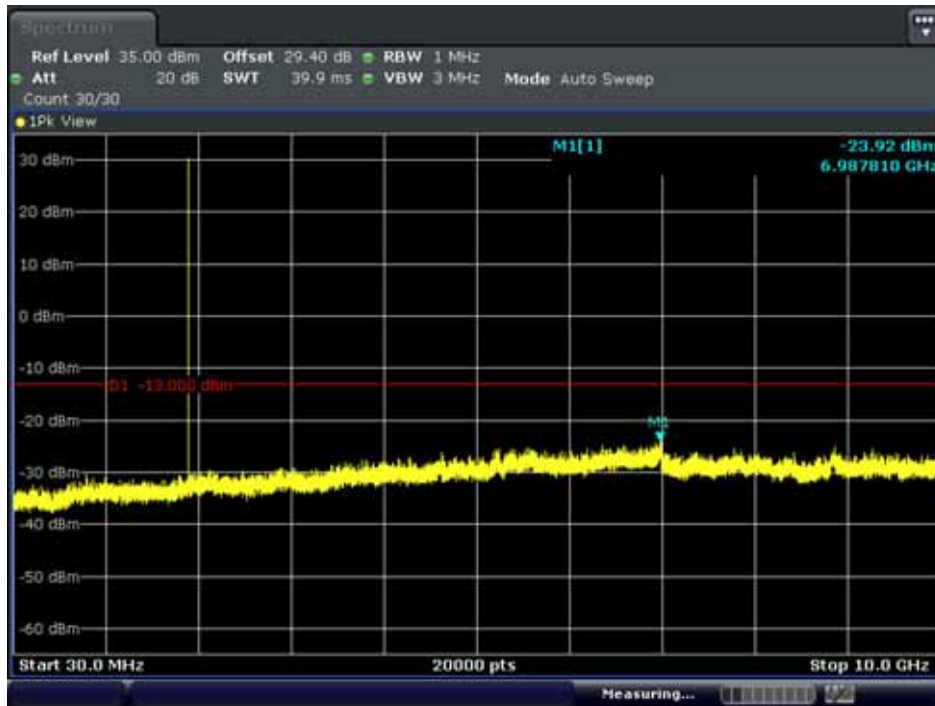

Date: 7.NOV.2013 03:56:39

■ GSM1900 MODE (810 CH.) Conducted Spurious Emissions2

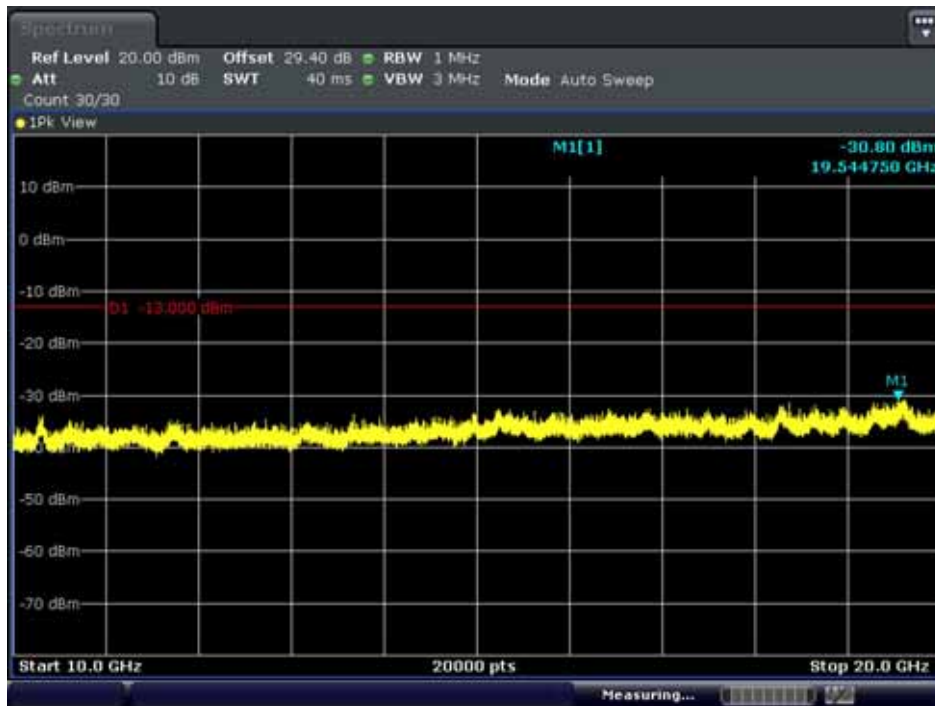

Date: 7.NOV.2013 03:56:54

FCC CERTIFICATION REPORT

FCC CERTIFICATION REPORT			<a href="http://www.hct.co.kr">www.hct.co.kr</a>
Test Report No. HCTR1311FR04	Date of Issue: November 13, 2013	EUT Type: Mobile Phone	FCC ID: A3LGTS7580

■ WCDMA850 MODE (4132 CH.) Conducted Spurious Emissions1

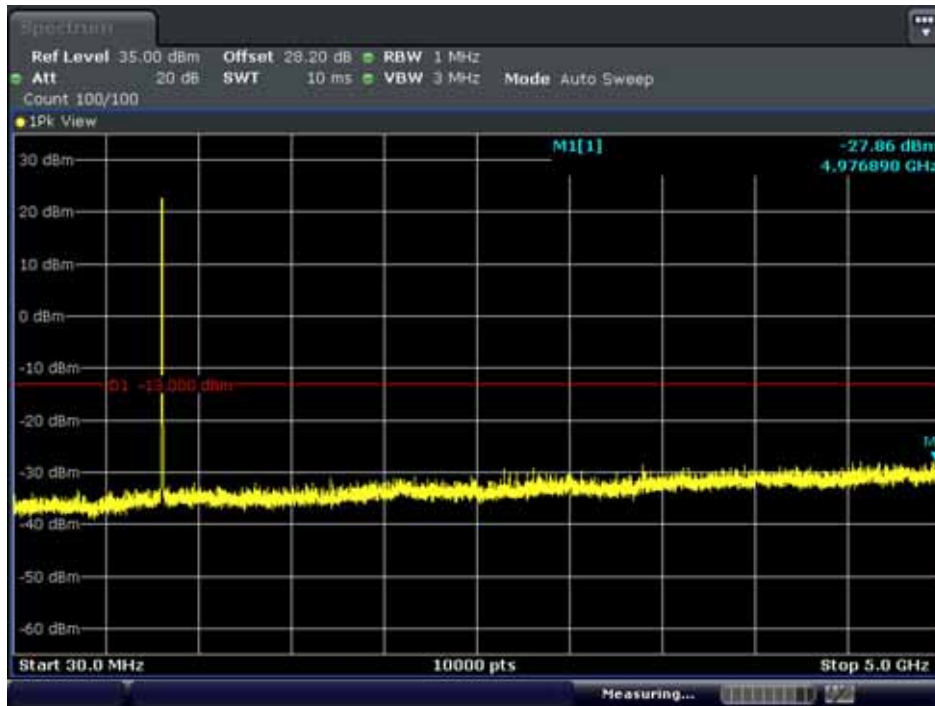

Date: 7.NOV.2013 03:51:35

■ WCDMA850 MODE (4132 CH.) Conducted Spurious Emissions2

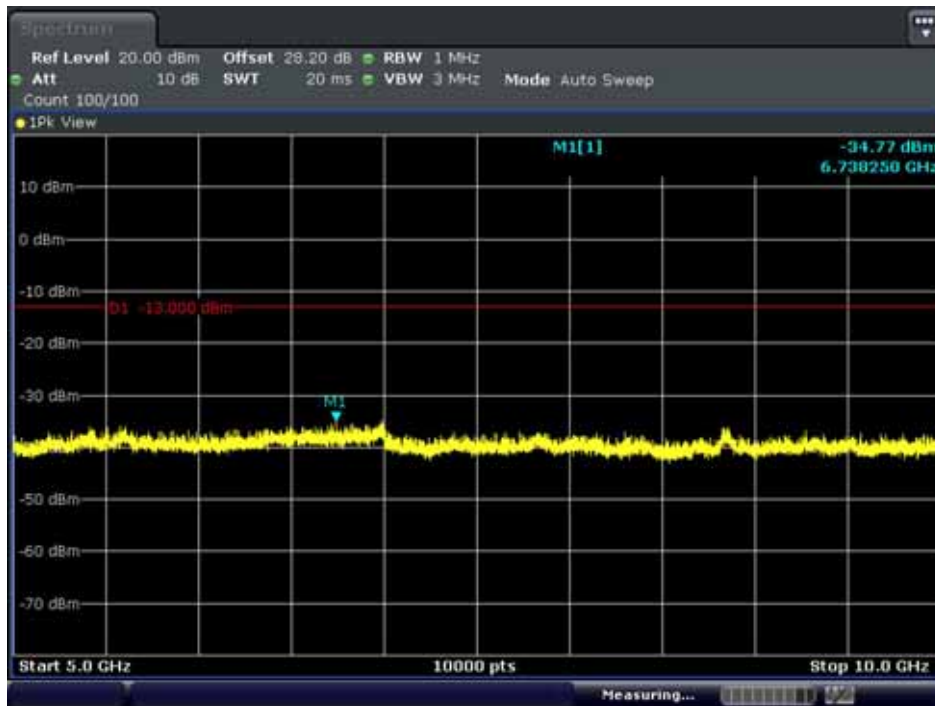

Date: 7.NOV.2013 03:51:52

FCC CERTIFICATION REPORT

FCC CERTIFICATION REPORT			<a href="http://www.hct.co.kr">www.hct.co.kr</a>
Test Report No. HCTR1311FR04	Date of Issue: November 13, 2013	EUT Type: Mobile Phone	FCC ID: A3LGTS7580

■ WCDMA850 MODE (4183 CH.) Conducted Spurious Emissions1

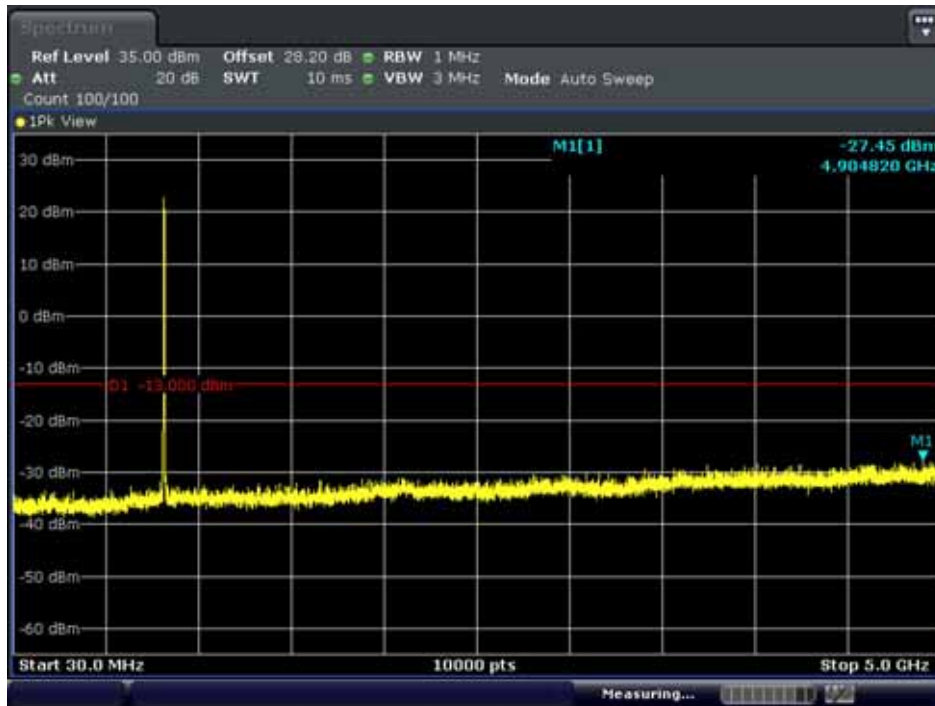

Date: 7.NOV.2013 03:52:05

■ WCDMA850 MODE (4183 CH.) Conducted Spurious Emissions2

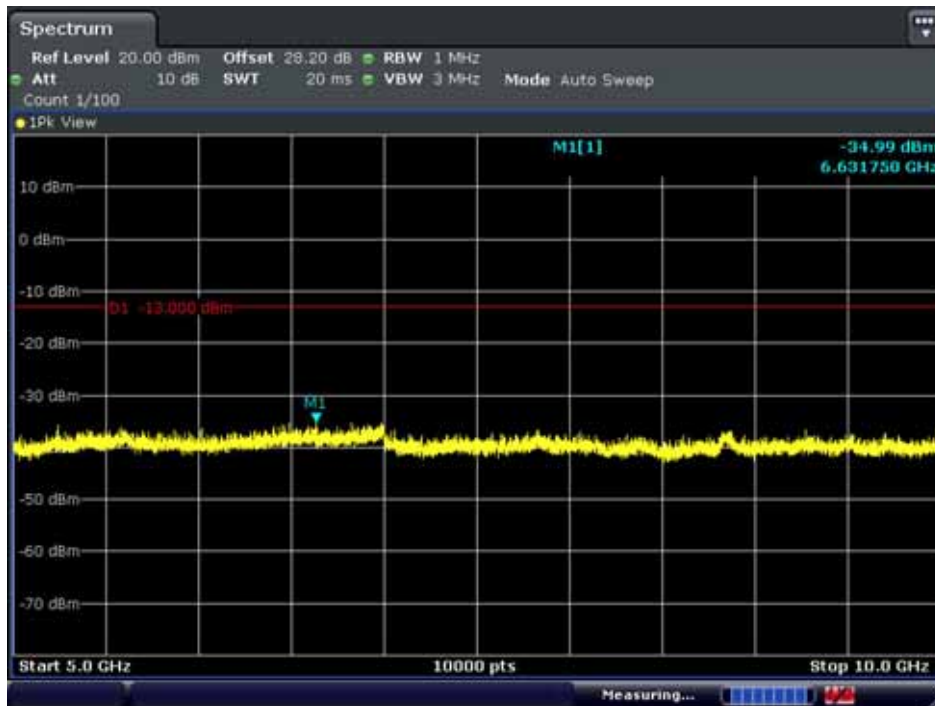

Date: 7.NOV.2013 03:52:22

FCC CERTIFICATION REPORT

FCC CERTIFICATION REPORT			<a href="http://www.hct.co.kr">www.hct.co.kr</a>
Test Report No. HCTR1311FR04	Date of Issue: November 13, 2013	EUT Type: Mobile Phone	FCC ID: A3LGTS7580

■ WCDMA850MODE (4233 CH.) Conducted Spurious Emissions1



Date: 7.NOV.2013 03:52:35

■ WCDMA850MODE (4233 CH.) Conducted Spurious Emissions2

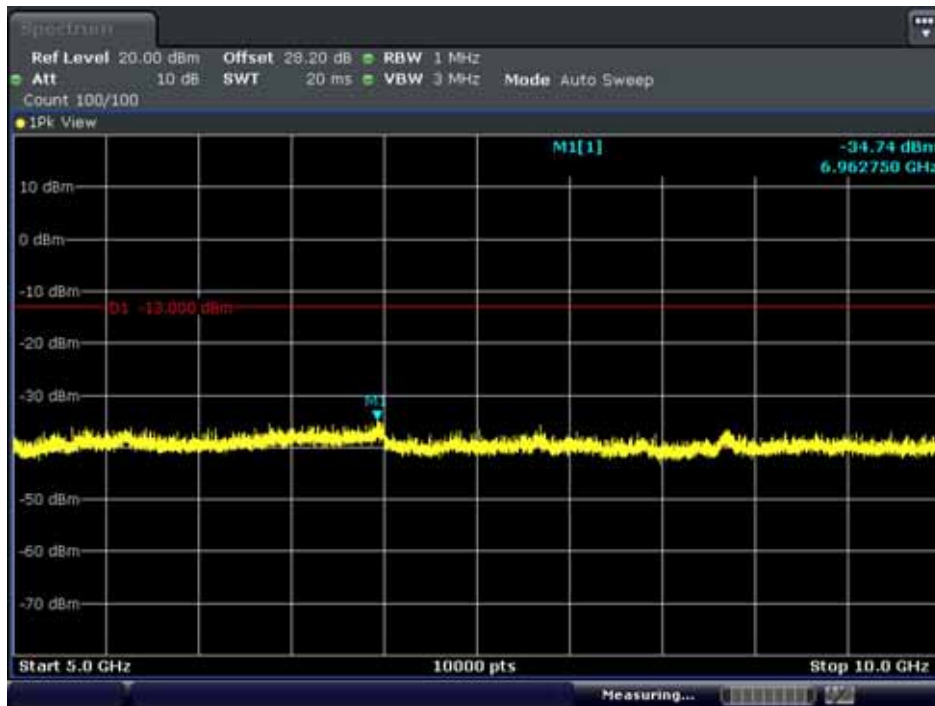

Date: 7.NOV.2013 03:52:52

FCC CERTIFICATION REPORT

Test Report No. HCTR1311FR04	Date of Issue: November 13, 2013	EUT Type: Mobile Phone	<a href="http://www.hct.co.kr">www.hct.co.kr</a> FCC ID: A3LGTS7580
---------------------------------	-------------------------------------	---------------------------	---

■ WCDMA1900 MODE (9262 CH.) Conducted Spurious Emissions1

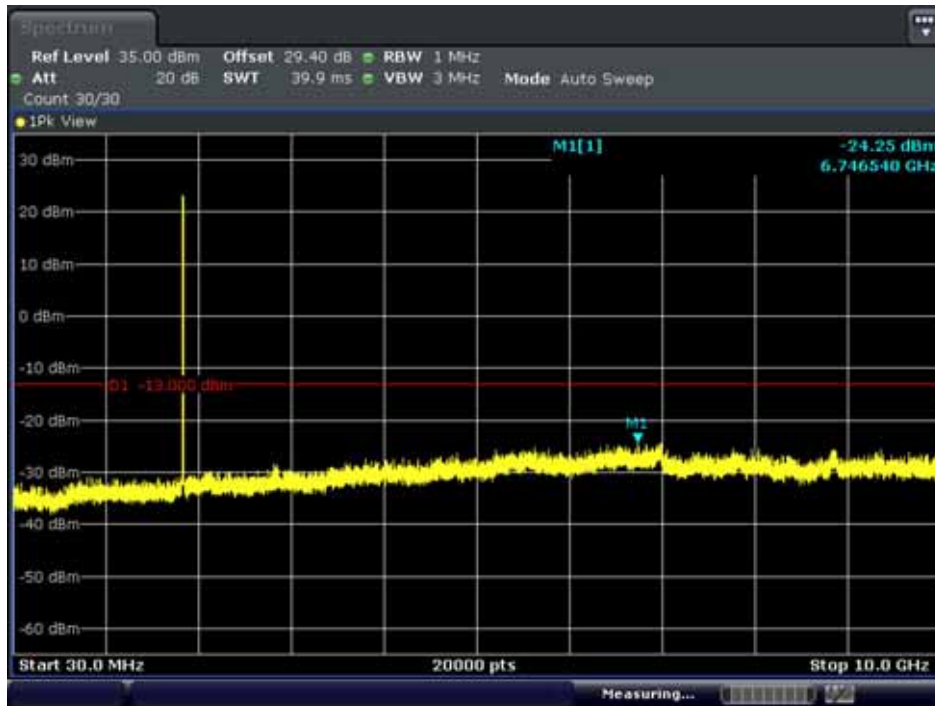

Date: 7.NOV.2013 03:49:16

■ WCDMA1900 MODE (9262 CH.) Conducted Spurious Emissions2

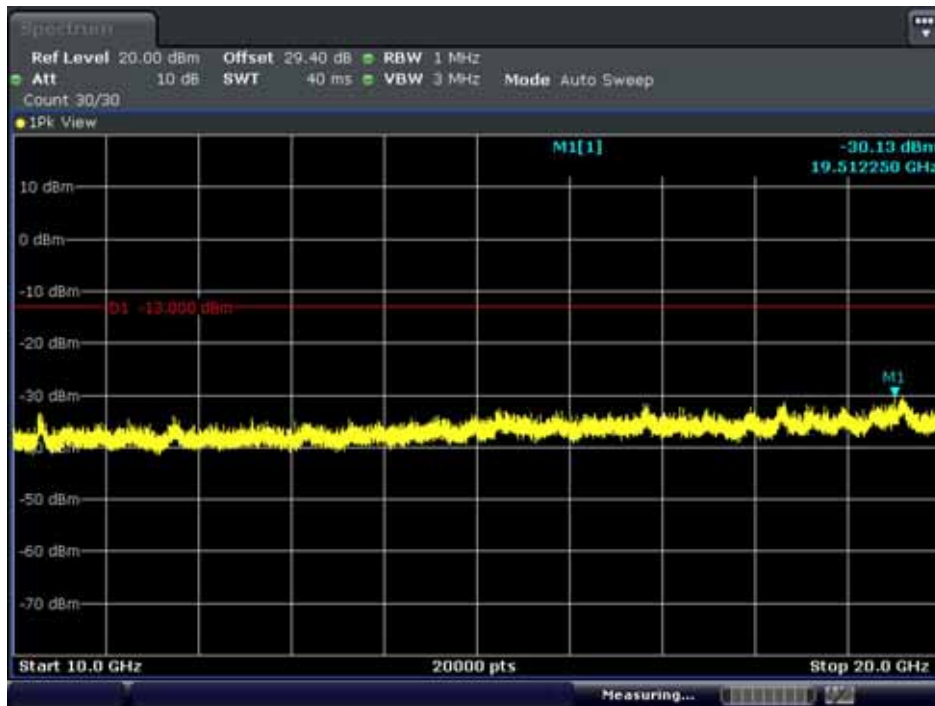

Date: 7.NOV.2013 03:49:32

FCC CERTIFICATION REPORT

Test Report No. HCTR1311FR04	Date of Issue: November 13, 2013	EUT Type: Mobile Phone	<a href="http://www.hct.co.kr">www.hct.co.kr</a> FCC ID: A3LGTS7580
---------------------------------	-------------------------------------	---------------------------	---

■ WCDMA1900 MODE (9400 CH.) Conducted Spurious Emissions1

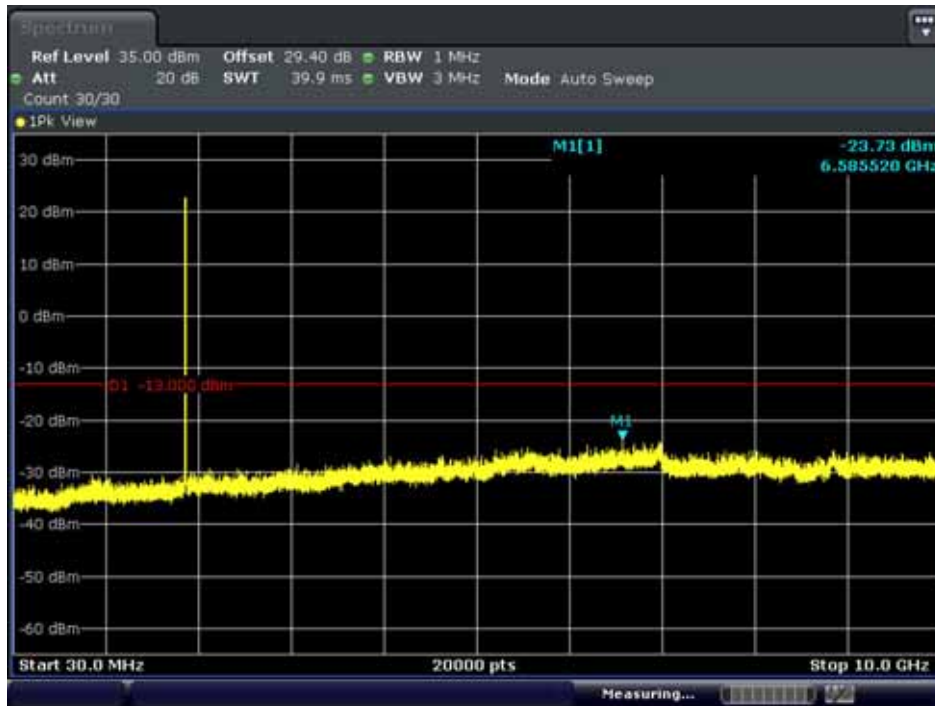

Date: 7.NOV.2013 03:49:48

■ WCDMA1900 MODE (9400 CH.) Conducted Spurious Emissions2

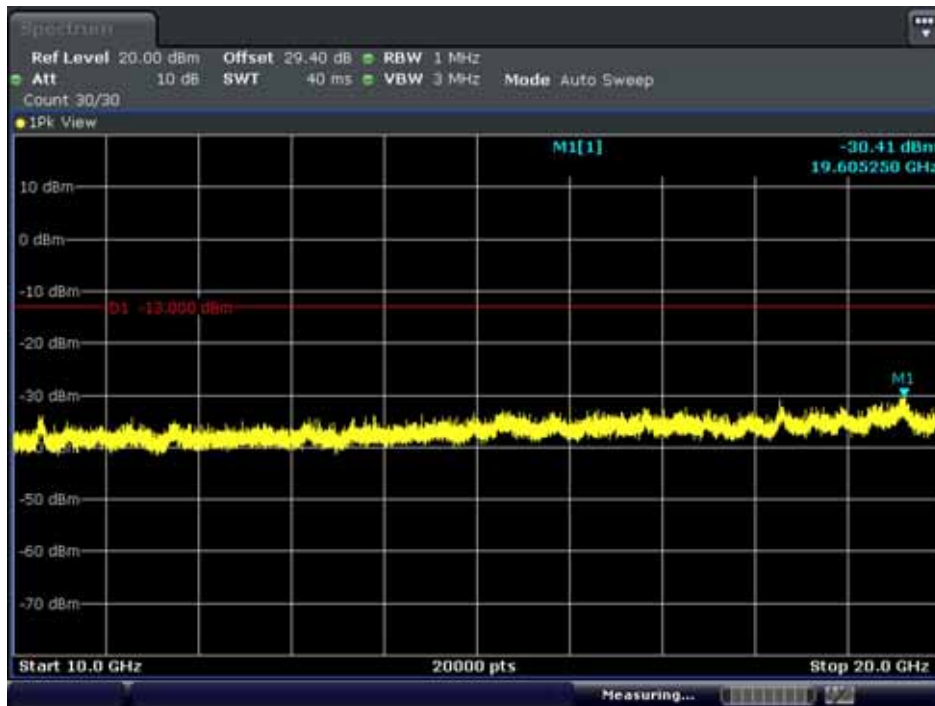

Date: 7.NOV.2013 03:50:04

FCC CERTIFICATION REPORT

Test Report No. HCTR1311FR04	Date of Issue: November 13, 2013	EUT Type: Mobile Phone	<a href="http://www.hct.co.kr">www.hct.co.kr</a> FCC ID: A3LGTS7580
---------------------------------	-------------------------------------	---------------------------	---

■ WCDMA1900 MODE (9538 CH.) Conducted Spurious Emissions1

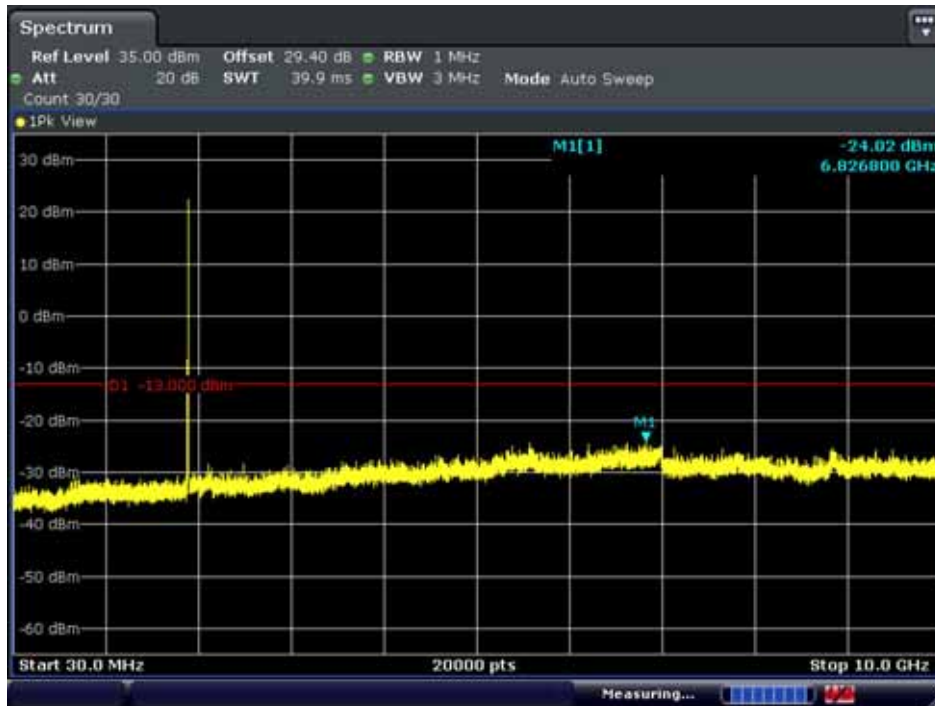

Date: 7,NOV,2013 03:50:22

■ WCDMA1900 MODE (9538 CH.) Conducted Spurious Emissions2

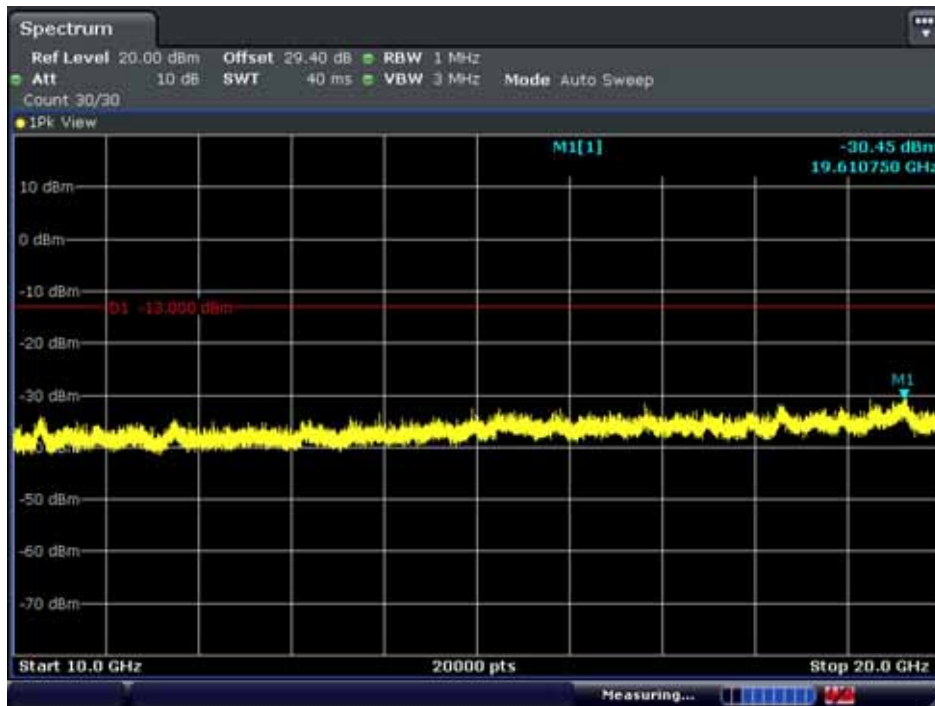

Date: 7,NOV,2013 03:50:37

FCC CERTIFICATION REPORT

FCC CERTIFICATION REPORT			<a href="http://www.hct.co.kr">www.hct.co.kr</a>
Test Report No. HCTR1311FR04	Date of Issue: November 13, 2013	EUT Type: Mobile Phone	FCC ID: A3LGTS7580