

HCT CO., LTD.

CERTIFICATE OF COMPLIANCE FCC Certification

| | |
|--------------------------------------------------------------------------------------------------|---------------------------------------------------------------------------------------------------------------------------|
| Applicant Name: SAMSUNG Electronics Co., Ltd. | Date of Issue: November 28, 2013 |
| Address: 129, Samsung-ro, Yeongtong-gu Suwon-si, Gyeonggi-do, 443-742 Rep. of Korea | Test Site/Location: HCT CO., LTD., 74, Seoicheon-ro 578beon-gil, Majang-myeon, Icheon-si, Gyeonggi-do, Korea |
| | Report No.: HCTR1311FR27 |
| | HCT FRN: 0005866421 |

FCC ID: A3LGTS7580E

APPLICANT: SAMSUNG Electronics Co., Ltd.

| | |
|--------------------------------|--------------------------------------------------------------------------------------------------------|
| FCC Model(s): | GT-S7580E |
| EUT Type: | Mobile Phone |
| FCC Classification: | Licensed Portable Transmitter Held to Ear (PCE) |
| FCC Rule Part(s): | §22, §24, §2 |
| Tx Frequency: | 824.20 - 848.80 MHz (GSM850) 1 850.20 - 1 909.80 MHz (GSM1900) 1 852.4 - 1 907.6 MHz (WCDMA1900) |
| Rx Frequency: | 869.20 - 893.80 MHz (GSM850) 1 930.20 - 1 989.80 MHz (GSM1900) 1 932.4 - 1 987.6 MHz (WCDMA1900) |
| Max. RF Output Power: | 0.379 W GSM850 (25.79 dBm) / 1.245 W GSM1900 (30.95 dBm) 0.294 W WCDMA1900 (24.68 dBm) |
| Emission Designator(s): | 244 KGXW (GSM850) 248 KGXW (GSM1900) 4M15F9W (WCDMA1900) |

The measurements shown in this report were made in accordance with the procedures specified in §2.947. I assume full responsibility for the accuracy and completeness of these measurements, and for the qualifications of all persons taking them.

HCT CO., LTD. Certifies that no party to this application has subject to a denial of Federal benefits that includes FCC benefits pursuant to section 5301 of the Anti-Drug Abuse Act of 1998, 21 U.S. C. 853(a)



Report prepared by
: Kyung Soo Kang
Test engineer of RF Team



Approved by
: Chang Seok Choi
Manager of RF Team

This report only responds to the tested sample and may not be reproduced, except in full, without written approval of the HCT Co., Ltd.

| FCC CERTIFICATION REPORT | | | www.hct.co.kr |
|---------------------------------|-------------------------------------|---------------------------|--------------------------------------------------|
| Test Report No. HCTR1311FR27 | Date of Issue: November 28, 2013 | EUT Type: Mobile Phone | FCC ID: A3LGTS7580E |

Version

| TEST REPORT NO. | DATE | DESCRIPTION |
|-----------------|-------------------|-------------------------|
| HCTR1311FR27 | November 28, 2013 | - First Approval Report |
| | | |
| | | |
| | | |
| | | |

Table of Contents

| | | |
|------------------------------------------------------------------|--|----|
| 1. GENERAL INFORMATION | | 4 |
| 2. INTRODUCTION | | 5 |
| 2.1. EUT DESCRIPTION..... | | 5 |
| 2.2. MEASURING INSTRUMENT CALIBRATION..... | | 5 |
| 2.3. TEST FACILITY | | 5 |
| 3. DESCRIPTION OF TESTS | | 6 |
| 3.1 ERP/EIRP RADIATED POWER AND RADIATED SPURIOUS EMISSIONS..... | | 6 |
| 3.2 PEAK- TO- AVERAGE RATIO | | 7 |
| 3.3 OCCUPIED BANDWIDTH. | | 9 |
| 3.4 SPURIOUS AND HARMONIC EMISSIONS AT ANTENNA TERMINAL..... | | 10 |
| 3.5 FREQUENCY STABILITY / VARIATION OF AMBIENT TEMPERATURE | | 11 |
| 4. LIST OF TEST EQUIPMENT | | 12 |
| 5. SUMMARY OF TEST RESULTS | | 13 |
| 6. SAMPLE CALCULATION | | 14 |
| 7. TEST DATA | | 15 |
| 7.1 EFFECTIVE RADIATED POWER OUTPUT (GSM)..... | | 15 |
| 7.2 EQUIVALENT ISOTROPIC RADIATED POWER (GSM / WCDMA)..... | | 16 |
| 7.3 RADIATED SPURIOUS EMISSIONS | | 17 |
| 7.3.1 RADIATED SPURIOUS EMISSIONS (GSM850) | | 17 |
| 7.3.2 RADIATED SPURIOUS EMISSIONS(GSM1900) | | 18 |
| 7.3.3 RADIATED SPURIOUS EMISSIONS (WCDMA1900)..... | | 19 |
| 7.4 PEAK-TO-AVERAGE RATIO | | 20 |
| 7.5 OCCUPIED BANDWIDTH | | 21 |
| 7.6 CONDUCTED SPURIOUS EMISSIONS | | 22 |
| 7.6.1 BAND EDGE..... | | 22 |
| 7.7 FREQUENCY STABILITY / VARIATION OF AMBIENT TEMPERATURE | | 23 |
| 7.7.1 FREQUENCY STABILITY (GSM850) | | 23 |
| 7.7.2 FREQUENCY STABILITY (GSM1900) | | 24 |
| 7.7.3 FREQUENCY STABILITY (WCDMA1900) | | 25 |
| 8. TEST PLOTS..... | | 26 |



MEASUREMENT REPORT

1. GENERAL INFORMATION

Applicant Name: SAMSUNG Electronics Co., Ltd.
Address: 129, Samsung-ro, Yeongtong-gu Suwon-si, Gyeonggi-do, 443-742 Rep. of Korea
FCC ID: A3LGTS7580E
Application Type: Certification
FCC Classification: Licensed Portable Transmitter Held to Ear (PCE)
FCC Rule Part(s): §22, §24, §2
EUT Type: Mobile Phone
FCC Model(s): GT-S7580E
Tx Frequency: 824.20 - 848.80 MHz (GSM850)
1 850.20 - 1 909.80 MHz (GSM1900)
1 852.4 - 1 907.6 MHz (WCDMA1900)
Rx Frequency: 869.20 - 893.80 MHz (GSM850)
1 930.20 - 1 989.80 MHz (GSM1900)
1 932.4 - 1 987.6 MHz (WCDMA1900)
Max. RF Output Power: 0.379 W GSM850 (25.79 dBm) / 1.245 W GSM1900 (30.95 dBm)
0.294 W WCDMA1900 (24.68 dBm)
Emission Designator(s): 244 KGXW (GSM850) 248 KGXW (GSM1900)
4M15F9W (WCDMA1900)
Date(s) of Tests: November 26, 2013 ~ November 28, 2013
Antenna Specification Manufacturer: GALTRONICS Co., Ltd.
Antenna type: Internal Antenna
Peak Gain: GSM850 : -4.79 dBi
GSM1900/WCDMA1900 : -1.49 dBi

| FCC CERTIFICATION REPORT | | | www.hct.co.kr |
|---------------------------------|-------------------------------------|---------------------------|--------------------------------------------------|
| Test Report No. HCTR1311FR27 | Date of Issue: November 28, 2013 | EUT Type: Mobile Phone | FCC ID: A3LGTS7580E |



2. INTRODUCTION

2.1. EUT DESCRIPTION

The SAMSUNG Electronics Co., Ltd. GT-S7580E Mobile Phone consists of GPRS Class33, GSM850, GSM1900, WCDMA1900, HSDPA HSUPA and HSPA+.

2.2. MEASURING INSTRUMENT CALIBRATION

The measuring equipment, which was utilized in performing the tests documented herein, has been calibrated in accordance with the manufacturer's recommendations for utilizing calibration equipment, which is traceable to recognized national standards.

2.3. TEST FACILITY

The Fully-anechoic chamber and conducted measurement facility used to collect the radiated data are located at the 74, Seoicheon-ro 578beon-gil, Majang-myeon, Icheon-si, Gyeonggi-do, Korea.

3. DESCRIPTION OF TESTS

3.1 ERP/EIRP RADIATED POWER AND RADIATED SPURIOUS EMISSIONS

Note: ERP(Effective Radiated Power), EIRP(Effective Isotropic Radiated Power)

Test Procedure

Radiated emission measurements are performed in the Fully-anechoic chamber. The equipment under test is placed on a non-conductive table 3-meters away from the receive antenna in accordance with ANSI/TIA-603-C-2004 Clause 2.2.17. The turntable is rotated through 360 degrees, and the receiving antenna scans in order to determine the level of the maximized emission. The level and position of the maximized emission is recorded with the spectrum analyzer using a positive peak detector.

A half wave dipole is then substituted in place of the EUT. For emissions above 1GHz, a horn antenna is substituted in place of the EUT. The substitute antenna is driven by a signal generator and the previously recorded signal was duplicated.

The power is calculated by the following formula;

$$P_{d(dBm)} = P_{g(dBm)} - \text{cable loss (dB)} + \text{antenna gain (dB)}$$

Where: P_d is the dipole equivalent power and P_g is the generator output power into the substitution antenna.

The maximum EIRP is calculated by adding the forward power to the calibrated source plus its appropriate gain value. These steps are repeated with the receiving antenna in both vertical and horizontal polarization. the difference between the gain of the horn and an isotropic antenna are taken into consideration

Radiated spurious emissions

1. Frequency Range : 30 MHz ~ 10th Harmonics of highest channel fundamental frequency.
2. The EUT was setup to maximum output power. The 100 kHz RBW was used to scan from 30 MHz to 1 GHz. Also, the 1 MHz RBW was used to scan from 1 GHz to 10 GHz(GSM850) or 20 GHz(GSM1900/WCDMA1900). The high, low and a middle channel were tested for out of band measurements.

| FCC CERTIFICATION REPORT | | | www.hct.co.kr |
|---------------------------------|-------------------------------------|---------------------------|--------------------------------------------------|
| Test Report No. HCTR1311FR27 | Date of Issue: November 28, 2013 | EUT Type: Mobile Phone | FCC ID: A3LGTS7580E |



3.2 PEAK- TO- AVERAGE RATIO

Test Procedure

Peak to Average Power Ratio is tested in accordance with KDB971168 D01 Power Meas License Digital Systems v02r01, June 7, 2013, Section 5.7.

- Section 5.7.1 CCDF Procedure

- a) Set resolution/measurement bandwidth \geq signal's occupied bandwidth;
- b) Set the number of counts to a value that stabilizes the measured CCDF curve;
- c) Set the measurement interval as follows:
 - 1) for continuous transmissions, set to 1 ms,
 - 2) for burst transmissions, employ an external trigger that is synchronized with the EUT burst timing sequence, or use the internal burst trigger with a trigger level that allows the burst to stabilize and set the measurement interval to a time that is less than or equal to the burst duration.
- d) Record the maximum PAPR level associated with a probability of 0.1%.

- Section 5.7.2 Alternate Procedure

Use one of the procedures presented in 5.1 to measure the total peak power and record as P_{Pk} . Use one of the applicable procedures presented 5.2 to measure the total average power and record as P_{Avg} . Determine the P.A.R. from: $P.A.R_{(dB)} = P_{Pk (dBm)} - P_{Avg (dBm)}$ (P_{Avg} = Average Power + Duty cycle Factor)

5.1.1 Peak power measurements with a spectrum/signal analyzer or EMI receiver

The following procedure can be used to determine the total peak output power.

- a) Set the RBW \geq OBW.
- b) Set VBW $\geq 3 \times$ RBW.
- c) Set span $\geq 2 \times$ RBW
- d) Sweep time = auto couple.
- e) Detector = peak.
- f) Ensure that the number of measurement points \geq span/RBW.
- g) Trace mode = max hold.
- h) Allow trace to fully stabilize.
- i) Use the peak marker function to determine the peak amplitude level.

| FCC CERTIFICATION REPORT | | | www.hct.co.kr |
|---------------------------------|-------------------------------------|---------------------------|--------------------------------------------------|
| Test Report No. HCTR1311FR27 | Date of Issue: November 28, 2013 | EUT Type: Mobile Phone | FCC ID: A3LGTS7580E |

5.2.2 Procedures for use with a spectrum/signal analyzer when EUT cannot be configured to transmit continuously and sweep triggering/signal gating cannot be properly implemented

If the EUT cannot be configured to transmit continuously (burst duty cycle < 98%), then one of the following procedures can be used. The selection of the applicable procedure will depend on the characteristics of the measured burst duty cycle.

Measure the burst duty cycle with a spectrum/signal analyzer or EMC receiver can be used in zero-span mode if the response time and spacing between bins on the sweep are sufficient to permit accurate measurement of the burst on/off time of the transmitted signal.

5.2.2.2 Constant burst duty cycle

If the measured burst duty cycle is constant (i.e., duty cycle variations are less than ± 2 percent), then:

- a) Set span to at least 1.5 times the OBW.
- b) Set RBW = 1-5% of the OBW, not to exceed 1 MHz.
- c) Set VBW $\geq 3 \times$ RBW.
- d) Number of points in sweep $\geq 2 \times$ span / RBW. (This gives bin-to-bin spacing \leq RBW/2, so that narrowband signals are not lost between frequency bins.)
- e) Sweep time = auto.
- f) Detector = RMS (power averaging).
- g) Set sweep trigger to "free run".
- h) Trace average at least 100 traces in power averaging (i.e., RMS) mode.
- i) Compute power by integrating the spectrum across the OBW of the signal using the instrument's band power measurement function with band limits set equal to the OBW band edges. If the instrument does not have a band power function, sum the spectrum levels (in power units) at intervals equal to the RBW extending across the entire OBW of the spectrum.
- j) Add $10 \log (1/x)$, where x is the duty cycle, to the measured power in order to compute the average power during the actual transmission times (because the measurement represents an average over both the on and off times of the transmission).

For example, add $10 \log (1/0.25) = 6$ dB if the duty cycle is a constant 25%.

| FCC CERTIFICATION REPORT | | | www.hct.co.kr |
|---------------------------------|-------------------------------------|---------------------------|--------------------------------------------------|
| Test Report No. HCTR1311FR27 | Date of Issue: November 28, 2013 | EUT Type: Mobile Phone | FCC ID: A3LGTS7580E |

3.3 OCCUPIED BANDWIDTH.

Test set-up

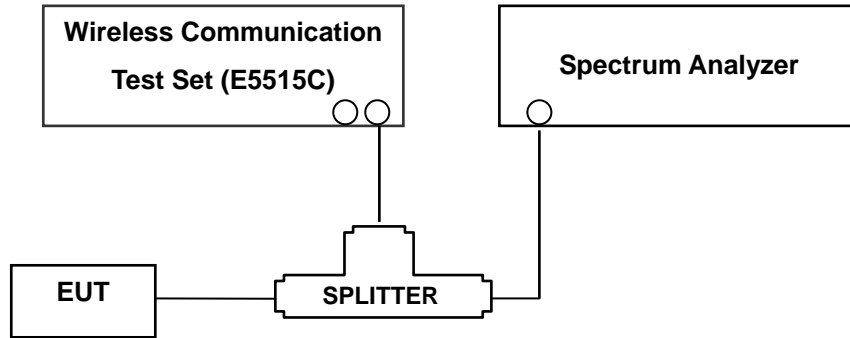

(Configuration of conducted Emission measurement)

The width of a frequency band such that, below the lower and above the upper frequency limits, the mean powers emitted are each equal to a specified percentage 0.5 % of the total mean power of a given emission.

Test Procedure

The EUT makes a call to the communication simulator. The power was measured with R&S Spectrum Analyzer. All measurements were done at 3 channels(low, middle and high operational range.)

The conducted occupied bandwidth used the power splitter via EUT RF power connector between simulation base station and spectrum analyzer.

The communication simulator station system controlled a EUT to export maximum output power under transmission mode and specific channel frequency. Use OBW measurement function of Spectrum analyzer to measure 99 % occupied bandwidth



3.4 SPURIOUS AND HARMONIC EMISSIONS AT ANTENNA TERMINAL.

Test Procedure

The level of the carrier and the various conducted spurious and harmonic frequencies is measured by means of a calibrated spectrum analyzer.

On any frequency outside a licensee’s frequency block, the power of any emission shall be attenuated below the transmitter power (P) by at least $43 + 10 \log(P)$ dB. The RBW settings used in the testing are greater than 1 % of the occupied bw. The 1 MHz RBW was used to scan from 10 MHz to 10 GHz. (GSM1900 Mode: 10 MHz to 20 GHz). A display line was placed at – 13 dBm to show compliance. The high, lowest and a middle channel were tested for out of band measurements.

Measurements of all out of band are made on RBW = 1MHz and VBW \geq 3 MHz in the worst case despite RBW = 100 kHz and VBW \geq 300 kHz upon 1 GHz.

- RBW = 1 MHz
- VBW \geq 3 MHz
- Detector = Peak
- Trace Mode = max hold
- Sweep time = auto
- Number of points in sweep $\geq 2 * \text{Span} / \text{RBW}$

- Band Edge Requirement : According to FCC 22.917 , 24.238(a) specified that power of any emission outside of The authorized operating frequency ranges must be attenuated below the transmitting power (P) by a factor of at least $43 + 10 \log(P)$ dB. In the 1 MHz bands immediately outside and adjacent to the frequency block a resolution bandwidth of at least one percent of the emission bandwidth of the fundamental emission of the transmitter may be employed.

The EUT makes a call to the communication simulator. The power was measured with R&S Spectrum Analyzer. All measurements were done at 2 channels(low and high operational frequency range.)

The band edge measurement used the power splitter via EUT RF power connector between simulation base station and spectrum analyzer.

The center frequency of spectrum is the band edge frequency and span is 1MHz RB of the spectrum is 3KHz and VB of the spectrum is 3KHz (GSM)

The center frequency of spectrum is the band edge frequency and span is 5MHz RB of the spectrum is 100KHz and VB of the spectrum is 100KHz(WCDMA)

NOTES: The analyzer plot offsets were determined by below conditions.

- For GSM850, total offset 27.5 dBm
= 20 dBm attenuator + 6 dBm Divider + 1.5 dBm RF cables.
- For GSM1900 and WCDMA1900, total offset 28 dB
= 20 dBm attenuator + 6 dBm Divider + 2.0 dBm RF cables.

| FCC CERTIFICATION REPORT | | | www.hct.co.kr |
|---------------------------------|-------------------------------------|---------------------------|--------------------------------------------------|
| Test Report No. HCTR1311FR27 | Date of Issue: November 28, 2013 | EUT Type: Mobile Phone | FCC ID: A3LGTS7580E |

3.5 FREQUENCY STABILITY / VARIATION OF AMBIENT TEMPERATURE

Test Set-up

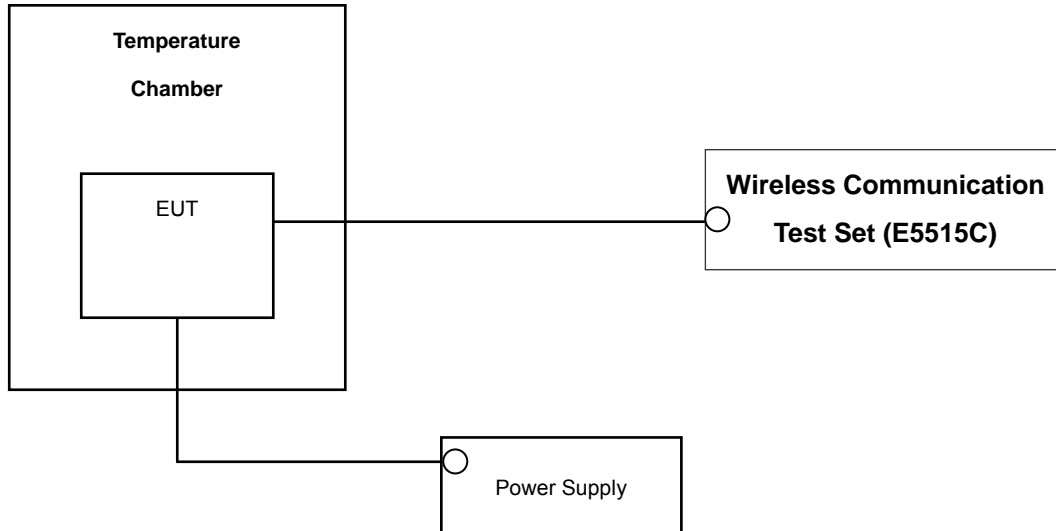

* Nominal Operating Voltage

Test Procedure

The frequency stability of the transmitter is measured by:

- a.) **Temperature:** The temperature is varied from - 30 °C to + 50 °C using an environmental chamber.
- b.) **Primary Supply Voltage:** The primary supply voltage is varied from battery end point to 115 % of the voltage normally at the input to the device or at the power supply terminals if cables are not normally supplied.

Specification — the frequency stability shall be sufficient to ensure that the fundamental emission stays within the authorized frequency block. The frequency stability of the transmitter shall be maintained within $\pm 0.00025\%$ (± 2.5 ppm) of the center frequency.

Time Period and Procedure:

The carrier frequency of the transmitter is measured at room temperature (20°C to provide a reference).

1. The equipment is turned on in a “standby” condition for one minute before applying power to the transmitter. Measurement of the carrier frequency of the transmitter is made within one minute after applying power to the transmitter.
2. Frequency measurements are made at 10°C intervals ranging from -30°C to +50°C. A period of at least one half-hour is provided to allow stabilization of the equipment at each temperature level.

NOTE: The EUT is tested down to the battery endpoint.

| FCC CERTIFICATION REPORT | | | www.hct.co.kr |
|---------------------------------|-------------------------------------|---------------------------|--------------------------------------------------|
| Test Report No. HCTR1311FR27 | Date of Issue: November 28, 2013 | EUT Type: Mobile Phone | FCC ID: A3LGTS7580E |

4. LIST OF TEST EQUIPMENT

| Manufacture | Model/ Equipment | Serial Number | Calibration Interval | Calibration Due |
|-------------------|-----------------------------|------------------------|----------------------|-----------------|
| Agilent | E9327A/ Power Sensor | MY4442009 | Annual | 04/16/2014 |
| MITEQ | AMF-6D-001180-35-20P/AMP | 1081666 | Annual | 09/12/2014 |
| Wainwright | WHK1.2/15G-10EF/H.P.F | 2 | Annual | 04/25/2014 |
| Wainwright | WHK3.3/18G-10EF/H.P.F | 1 | Annual | 04/25/2014 |
| Hewlett Packard | 11667B / Power Splitter | 11275 | Annual | 05/13/2014 |
| Digital | EP-3010/ Power Supply | 3110117 | Annual | 10/29/2014 |
| Schwarzbeck | UHAP/ Dipole Antenna | 557 | Biennial | 03/05/2015 |
| Schwarzbeck | UHAP/ Dipole Antenna | 558 | Biennial | 05/03/2015 |
| Korea Engineering | KR-1005L / Chamber | KRAB05063-3CH | Annual | 10/30/2014 |
| Schwarzbeck | BBHA 9120D/ Horn Antenna | 147 | Biennial | 05/15/2014 |
| Schwarzbeck | BBHA 9120D/ Horn Antenna | 1151 | Biennial | 10/05/2015 |
| Agilent | E4440A/Spectrum Analyzer | US45303008 | Annual | 04/25/2014 |
| WEINSCHTEL | ATTENUATOR | BR0592 | Annual | 10/28/2014 |
| REOHDE&SCHWARZ | FSV40/Spectrum Analyzer | 1307.9002K40-100931-NK | Annual | 06/10/2014 |
| Agilent | 8960 (E5515C)/ Base Station | GB44400269 | Annual | 02/14/2014 |

5. SUMMARY OF TEST RESULTS

| FCC Part Section(s) | Test Description | Test Limit | Test Condition | Test Result |
|---------------------------------|------------------------------------------------------------------------|--------------------------------------------------------------------------------|----------------|-------------|
| 2.1049, 22.917(a), 24.238(a) | Occupied Bandwidth | N/A | CONDUCTED | PASS |
| 2.1051, 22.917(a), 24.238(a) | Band Edge / Spurious and Harmonic Emissions at Antenna Terminal. | < 43 + 10log10 (P[Watts]) at Band Edge and for all out-of-band emissions | | PASS |
| * 2.1046 | Conducted Output Power | - | | PASS |
| 24.232(d) | Peak- to- Average Ratio | < 13 dB | | PASS |
| 2.1055, 22.355, 24.235 | Frequency stability / variation of ambient temperature | < 2.5 ppm | | PASS |
| 22.913(a)(2) 24.232(c) | Effective Radiated Power | < 7 Watts max. ERP | RADIATED | PASS |
| | Equivalent Isotropic Radiated Power | < 2 Watts max. EIRP | | PASS |
| 2.1053, 22.917(a), 24.238(a) | Radiated Spurious and Harmonic Emissions | < 43 + 10log10 (P[Watts]) for all out-of band emissions | | PASS |

*: See SAR Report

6. SAMPLE CALCULATION

A. ERP Sample Calculation

| Mode | Ch./ Freq. | | Measured Level(dBm) | Substitute LEVEL(dBm) | Ant. Gain (dBd) | C.L | Pol. | ERP | |
|--------|------------|------------|---------------------|-----------------------|-----------------|------|------|-------|-------|
| | channel | Freq.(MHz) | | | | | | W | dBm |
| GSM850 | 128 | 824.20 | -21.37 | 38.40 | -10.61 | 0.95 | H | 0.483 | 26.84 |

ERP = SubstituteLEVEL(dBm) + Ant. Gain – CL(Cable Loss)

- 1) The EUT mounted on a non-conductive tunnable is 0.8 meter above test site ground level.
- 2) During the test , the turn table is rotated until the maximum signal is found.
- 3) Record the field strength meter's level.
- 4) Replace the EUT with dipole/Horn antenna that is connected to a calibrated signal generator.
- 5) Increase the signal generator output till the field strength meter's level is equal to the item (3).
- 6) The signal generator output level with Ant. Gain and cable loss are the rating of effective radiated power (**ERP**).

B. Emission Designator

GSM Emission Designator

Emission Designator = 249KGXW

GSM BW = 249 kHz

G = Phase Modulation

X = Cases not otherwise covered

W = Combination (Audio/Data)

WCDMA Emission Designator

Emission Designator = 4M17F9W

WCDMA BW = 4.17 MHz

F = Frequency Modulation

9 = Composite Digital Info

W = Combination (Audio/Data)

7. TEST DATA

7.1 EFFECTIVE RADIATED POWER OUTPUT (GSM)

(GSM850 Mode)

| Ch./ Freq. | | Measured Level(dBm) | Substitute LEVEL (dBm) | Ant. Gain (dBd) | C.L | Pol. | ERP | |
|------------|------------|------------------------|---------------------------|--------------------|------|------|-------|-------|
| channel | Freq.(MHz) | | | | | | W | dBm |
| 128 | 824.20 | -22.61 | 37.16 | -10.61 | 0.95 | V | 0.363 | 25.60 |
| 190 | 836.60 | -22.96 | 37.22 | -10.54 | 0.96 | V | 0.373 | 25.72 |
| 251 | 848.80 | -23.06 | 37.36 | -10.47 | 1.10 | V | 0.379 | 25.79 |

Note: Standard batteries are the only options for this phone. And a peak detector is used.

NOTES:

Effective Radiated Power Output Measurements by Substitution Method
according to ANSI/TIA/EIA-603-C-2004, Aug. 17, 2004:

The EUT was placed on a non-conductive styrofoam resin table 3-meters from the receive antenna. Turntable rotation was adjusted for the highest reading on the receive spectrum analyzer. For CDMA, WCDMA, AMPS, GSM, and NADC TDMA signals, a peak detector is used, with $RBW \geq OBW$, $VBW \geq 3 \times RBW$. A half-wave dipole was substituted in place of the EUT. This dipole antenna was driven by a signal generator and the level of the signal generator was adjusted to obtain the same receive spectrum analyzer reading. The conducted power at the terminals of the dipole is measured. The ERP is recorded.

This device was tested under all configurations and the highest power is reported in WCDMA mode with HSDPA Inactive at 12.2 kbps RMC and TPC bits all set to "1" and in GSM mode and using a Power Control Level of "0" in the PCS Band and "5" in the Cellular Band. This unit was tested with its standard battery. Also, we have done x, y, z planes in EUT and horizontal and vertical polarization in detecting antenna. The worst case of the EUT is y plane in GSM850 mode. Also worst case of detecting Antenna is vertical polarization in GSM850 mode.



7.2 EQUIVALENT ISOTROPIC RADIATED POWER (GSM / WCDMA)

(GSM1900 Mode)

| Ch./ Freq. | | Measured Level(dBm) | Substitute LEVEL (dBm) | Ant. Gain (dBi) | C.L | Pol. | EIRP | |
|------------|------------|------------------------|---------------------------|--------------------|------|------|-------|-------|
| channel | Freq.(MHz) | | | | | | W | dBm |
| 512 | 1,850.20 | -9.69 | 22.34 | 10.02 | 1.41 | H | 1.245 | 30.95 |
| 661 | 1,880.00 | -10.78 | 21.53 | 10.04 | 1.45 | H | 1.028 | 30.12 |
| 810 | 1,909.80 | -11.09 | 21.16 | 10.05 | 1.44 | H | 0.948 | 29.77 |

(WCDMA1900 Mode)

| Ch./ Freq. | | Measured Level(dBm) | Substitute LEVEL (dBm) | Ant. Gain (dBi) | C.L | Pol. | EIRP | |
|------------|------------|------------------------|---------------------------|--------------------|------|------|-------|-------|
| channel | Freq.(MHz) | | | | | | W | dBm |
| 9262 | 1,852.40 | -16.09 | 16.06 | 10.02 | 1.40 | H | 0.294 | 24.68 |
| 9400 | 1,880.00 | -16.72 | 15.59 | 10.04 | 1.45 | H | 0.262 | 24.18 |
| 9538 | 1,907.60 | -17.24 | 15.32 | 10.05 | 1.48 | H | 0.245 | 23.89 |

Note: Standard batteries are the only options for this phone. And a peak detector is used.

NOTES:

Equivalent Isotropic Radiated Power Measurements by Substitution Method
according to ANSI/TIA/EIA-603-C-2004, Aug. 17, 2004:

The EUT was placed on a non-conductive styrofoam resin table 3-meters from the receive antenna. Turntable rotation was adjusted for the highest reading on the receive spectrum analyzer. For CDMA, WCDMA, AMPS, GSM, and NADC TDMA signals, a peak detector is used, with $RBW \geq OBW$, $VBW \geq 3 \times RBW$. A Horn antenna was substituted in place of the EUT. This Horn antenna was driven by a signal generator and the level of the signal generator was adjusted to obtain the same receive spectrum analyzer reading. The conducted power at the terminals of the Horn antenna is measured. The difference between the gain of the horn and an isotropic antenna is taken into consideration and the EIRP is recorded.

This device was tested under all configurations and the highest power is reported in WCDMA mode with HSDPA Inactive at 12.2 kbps RMC and TPC bits all set to "1" and in GSM mode and using a Power Control Level of "0" in the PCS Band and "5" in the Cellular Band. This unit was tested with its standard battery. Also, we have done x, y, z planes in EUT and horizontal and vertical polarization in detecting antenna. The worst case of the EUT is x plane in GSM1900 and WCDMA1900 mode. Also worst case of detecting Antenna is in horizontal polarization in GSM1900 and WCDMA1900 mode.

| FCC CERTIFICATION REPORT | | | www.hct.co.kr |
|---------------------------------|-------------------------------------|---------------------------|--------------------------------------------------|
| Test Report No. HCTR1311FR27 | Date of Issue: November 28, 2013 | EUT Type: Mobile Phone | FCC ID: A3LGTS7580E |

7.3 RADIATED SPURIOUS EMISSIONS

7.3.1 RADIATED SPURIOUS EMISSIONS (GSM850)

MEASURED OUTPUT POWER: 25.79 dBm = 0.379 W
 MODULATION SIGNAL: GSM850
 DISTANCE: 3 meters
 LIMIT: $43 + 10 \log_{10}(W) =$ 38.79 dBc

| Ch. | Freq.(MHz) | Measured Level [dBm] | Ant. Gain (dBd) | Substitute Level [dBm] | C.L | Pol. | ERP (dBm) | dBc |
|----------------|------------|-------------------------|--------------------|------------------------------|------|------|--------------|-------|
| 128 (824.2) | 1,648.40 | -43.37 | 7.05 | -50.21 | 1.18 | H | -44.34 | 70.13 |
| | 2,472.60 | -38.66 | 7.90 | -42.41 | 1.57 | V | -36.08 | 61.87 |
| | 3,296.80 | -49.45 | 9.91 | -53.33 | 1.99 | H | -45.41 | 71.20 |
| 190 (836.6) | 1,673.20 | -46.63 | 7.22 | -53.63 | 1.20 | H | -47.61 | 73.40 |
| | 2,509.80 | -36.83 | 8.51 | -40.62 | 1.65 | H | -33.76 | 59.55 |
| | 3,346.40 | -49.18 | 10.09 | -53.57 | 2.00 | V | -45.48 | 71.27 |
| 251 (848.8) | 1,697.60 | -47.13 | 7.34 | -54.15 | 1.20 | H | -48.01 | 73.80 |
| | 2,546.40 | -36.11 | 8.61 | -39.65 | 1.65 | H | -32.69 | 58.48 |
| | 3,395.20 | -48.86 | 10.22 | -53.39 | 1.99 | H | -45.16 | 70.95 |

- NOTES:**
1. Radiated Spurious Emission Measurements at 3 meters by Substitution Method according to ANSI/TIA/EIA-603-C-2004, Aug. 17, 2004:
 2. We are performed all frequency to 10th harmonics from 30 MHz. Measurements above show only up to 3 maximum emissions noted, or would be lesser if no specific emissions from the EUT are recorded (ie: margin > 20 dB from the applicable limit) and considered that's already beyond the background noise floor.
 3. we have done x, y, z planes in EUT and horizontal and vertical polarization in detecting antenna.



7.3.2 RADIATED SPURIOUS EMISSIONS(GSM1900)

MEASURED OUTPUT POWER: 30.95 dBm = 1.245 W
 MODULATION SIGNAL: GSM1900
 DISTANCE: 3 meters
 LIMIT: $43 + 10 \log_{10}(W) =$ 43.95 dBc

| Ch. | Freq.(MHz) | Measured Level [dBm] | Ant. Gain (dBi) | Substitute Level [dBm] | C.L | Pol. | EIRP (dBm) | dBc |
|-----------------|------------|-------------------------|--------------------|------------------------------|------|------|---------------|-------|
| 512 (1850.2) | 3,700.40 | -34.49 | 12.27 | -39.23 | 2.19 | V | -29.15 | 60.10 |
| | 5,550.60 | -56.23 | 13.40 | -55.90 | 2.88 | H | -45.38 | 76.33 |
| | 7,400.80 | -58.34 | 11.37 | -48.05 | 3.29 | V | -39.97 | 70.92 |
| 661 (1880.0) | 3,760.00 | -37.09 | 12.31 | -41.64 | 2.11 | V | -31.44 | 62.39 |
| | 5,640.00 | -56.95 | 13.41 | -56.28 | 2.92 | H | -45.79 | 76.74 |
| | 7,520.00 | -57.28 | 11.55 | -47.76 | 3.34 | H | -39.55 | 70.50 |
| 810 (1909.8) | 3,819.60 | -41.98 | 12.37 | -46.46 | 2.14 | H | -36.23 | 67.18 |
| | 5,729.40 | -54.74 | 13.42 | -53.30 | 3.02 | H | -42.90 | 73.85 |
| | 7,639.20 | -57.48 | 11.70 | -47.72 | 3.13 | H | -39.15 | 70.10 |

- NOTES:**
1. Radiated Spurious Emission Measurements at 3 meters by Substitution Method according to ANSI/TIA/EIA-603-C-2004, Aug. 17, 2004:
 2. We are performed all frequency to 10th harmonics from 30 MHz. Measurements above show only up to 3 maximum emissions noted, or would be lesser if no specific emissions from the EUT are recorded (ie: margin > 20 dB from the applicable limit) and considered that's already beyond the background noise floor.
 3. we have done x, y, z planes in EUT and horizontal and vertical polarization in detecting antenna.

| FCC CERTIFICATION REPORT | | | www.hct.co.kr |
|---------------------------------|-------------------------------------|---------------------------|--------------------------------------------------|
| Test Report No. HCTR1311FR27 | Date of Issue: November 28, 2013 | EUT Type: Mobile Phone | FCC ID: A3LGTS7580E |



7.3.3 RADIATED SPURIOUS EMISSIONS (WCDMA1900)

MEASURED OUTPUT POWER: 24.68 dBm = 0.294 W
 MODULATION SIGNAL: WCDMA1900
 DISTANCE: 3 meters
 LIMIT: $43 + 10 \log_{10}(W) =$ 37.68 dBc

| Ch. | Freq.(MHz) | Measured Level [dBm] | Ant. Gain (dBi) | Substitute Level [dBm] | C.L | Pol. | EIRP (dBm) | dBc |
|------|------------|-------------------------|--------------------|------------------------------|------|------|---------------|-------|
| 9262 | 3,704.80 | -47.75 | 12.27 | -52.49 | 2.19 | H | -42.41 | 67.09 |
| | 5,557.20 | -54.76 | 13.40 | -54.43 | 2.88 | H | -43.91 | 68.59 |
| | 7,409.60 | -58.20 | 11.37 | -47.91 | 3.29 | H | -39.83 | 64.51 |
| 9400 | 3,760.00 | -49.92 | 12.31 | -54.47 | 2.11 | V | -44.27 | 68.95 |
| | 5,640.00 | -56.37 | 13.41 | -55.70 | 2.92 | V | -45.21 | 69.89 |
| | 7,520.00 | -58.28 | 11.55 | -48.76 | 3.34 | H | -40.55 | 65.23 |
| 9538 | 3,815.20 | -50.94 | 12.37 | -55.42 | 2.14 | H | -45.19 | 69.87 |
| | 5,722.80 | -57.15 | 13.42 | -55.71 | 3.02 | V | -45.31 | 69.99 |
| | 7,630.40 | -57.40 | 11.70 | -47.64 | 3.13 | V | -39.07 | 63.75 |

- NOTES:**
1. Radiated Spurious Emission Measurements at 3 meters by Substitution Method according to ANSI/TIA/EIA-603-C-2004, Aug. 17, 2004:
 2. We are performed all frequency to 10th harmonics from 30 MHz. Measurements above show only up to 3 maximum emissions noted, or would be lesser if no specific emissions from the EUT are recorded (ie: margin > 20 dB from the applicable limit) and considered that's already beyond the background noise floor.
 3. we have done x, y, z planes in EUT and horizontal and vertical polarization in detecting antenna.

| FCC CERTIFICATION REPORT | | | www.hct.co.kr |
|---------------------------------|-------------------------------------|---------------------------|--------------------------------------------------|
| Test Report No. HCTR1311FR27 | Date of Issue: November 28, 2013 | EUT Type: Mobile Phone | FCC ID: A3LGTS7580E |

7.4 PEAK-TO-AVERAGE RATIO

| Band | Ch. | Measured P _{PK} (dBm) | Measured P _{Avg} (dBm) | P _{Avg} (Duty Cycle) | | | P.A.R. = P _{PK} - P _{Avg} (dB) | Limit (dB) | Pass / Fail |
|-----------|------|-----------------------------------|------------------------------------|-------------------------------|--------------------------|----------------|--------------------------------------------------------|---------------|----------------|
| | | | | Tx _{Total} (ms) | Tx _{On} (ms) | Factor (dB) | | | |
| GSM1900 | 661 | 29.97 | 20.46 | 4.6232 | 0.5507 | 9.24 | 0.27 | 13 | Pass |
| WCDMA1900 | 9400 | CCDF Procedure | | | | | 3.40 | | |

- Plots of the EUT's Peak- to- Average Ratio are shown Page 30 ~ 31, 33.

NOTES:

Peak to Average Power Ratio was tested in accordance with KDB971168 D01 Power Meas License Digital Systems v02r01, June 7, 2013, Section 5.7.

Only GSM(include EDGE) Mode was tested by Section 5.7.2 Alternate Procedure

$P.A.R_{(dB)} = P_{PK (dBm)} - P_{Avg (dBm)}$ (P_{Avg} = Average Power + Duty cycle Factor)

Duty cycle Factor = $10 \log (1/x)$, $x = Tx_{On} / Tx_{Total}$

7.5 OCCUPIED BANDWIDTH

| Band | Channel | Frequency(MHz) | Data (GSM: kHz / WCDMA : MHz) |
|-----------|---------|----------------|----------------------------------|
| GSM850 | 128 | 824.20 | 244.4828 |
| | 190 | 836.60 | 241.2323 |
| | 251 | 848.80 | 243.1522 |
| GSM1900 | 512 | 1,850.20 | 248.3340 |
| | 661 | 1,880.00 | 243.0251 |
| | 810 | 1,909.80 | 243.5267 |
| WCDMA1900 | 9262 | 1852.40 | 4.1467 |
| | 9400 | 1880.00 | 4.1429 |
| | 9538 | 1907.60 | 4.1432 |

- Plots of the EUT's Occupied Bandwidth are shown Page 27 ~ 29, 31 ~ 32.

7.6 CONDUCTED SPURIOUS EMISSIONS

| Band | Channel | Frequency of Maximum Harmonic (GHz) | Maximum Data (dBm) |
|-----------|---------|-------------------------------------|--------------------|
| GSM850 | 128 | 4.990810 | -28.58 |
| | 190 | 4.734850 | -28.17 |
| | 251 | 4.599670 | -27.67 |
| GSM1900 | 512 | 6.971360 | -25.72 |
| | 661 | 6.974850 | -24.10 |
| | 810 | 6.992300 | -25.27 |
| WCDMA1900 | 9262 | 6.997290 | -25.50 |
| | 9400 | 6.988810 | -25.07 |
| | 9538 | 6.998780 | -24.99 |

- Plots of the EUT's Conducted Spurious Emissions are shown Page 39 ~ 48.

7.6.1 BAND EDGE

- Plots of the EUT's Band Edge are shown Page 33 ~ 39.

7.7 FREQUENCY STABILITY / VARIATION OF AMBIENT TEMPERATURE

7.7.1 FREQUENCY STABILITY (GSM850)

OPERATING FREQUENCY: 836,600,000 Hz
 CHANNEL: 190
 REFERENCE VOLTAGE: 3.8 VDC
 DEVIATION LIMIT: ± 0.000 25 % or 2.5 ppm

| Voltage (%) | Power (VDC) | Temp. () | Frequency (Hz) | Frequency Error (Hz) | Deviation (%) | ppm |
|-------------|-------------|-----------|----------------|----------------------|---------------|-------|
| 100% | 3.800 | +20(Ref) | 836 599 965 | 0 | 0.000 000 | 0.000 |
| 100% | | -30 | 836 600 002 | 36.63 | 0.000 004 | 0.044 |
| 100% | | -20 | 836 599 999 | 34.02 | 0.000 004 | 0.041 |
| 100% | | -10 | 836 600 003 | 37.55 | 0.000 004 | 0.045 |
| 100% | | 0 | 836 599 998 | 32.69 | 0.000 004 | 0.039 |
| 100% | | +10 | 836 599 998 | 32.80 | 0.000 004 | 0.039 |
| 100% | | +30 | 836 599 997 | 31.95 | 0.000 004 | 0.038 |
| 100% | | +40 | 836 600 000 | 35.08 | 0.000 004 | 0.042 |
| 100% | | +50 | 836 600 000 | 35.13 | 0.000 004 | 0.042 |
| 115% | 4.370 | +20 | 836 600 000 | 34.64 | 0.000 004 | 0.041 |
| 85% | 3.500 | +20 | 836 599 999 | 33.92 | 0.000 004 | 0.041 |

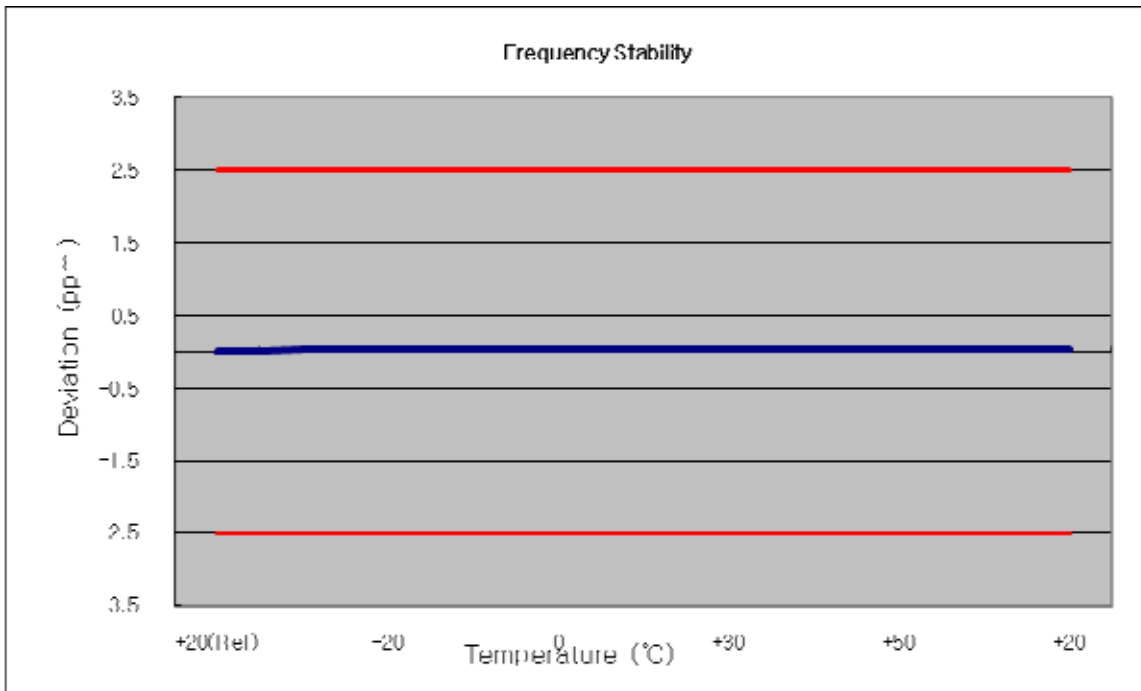

7.7.2 FREQUENCY STABILITY (GSM1900)

OPERATING FREQUENCY: 1880,000,000 Hz
 CHANNEL: 661
 REFERENCE VOLTAGE: 3.8 VDC
 DEVIATION LIMIT: ± 0.000 25 % or 2.5 ppm

| Voltage (%) | Power (VDC) | Temp. () | Frequency (Hz) | Frequency Error (Hz) | Deviation (%) | ppm |
|-------------|-------------|-----------|----------------|----------------------|---------------|-----------|
| 100% | 3.800 | +20(Ref) | 1879 999 948 | 0 | 0.000 000 | 0.000 |
| 100% | | -30 | 1880 000 005 | 56.63 | 0.000 003 | 0.030 |
| 100% | | -20 | 1880 000 004 | 55.60 | 0.000 003 | 0.030 |
| 100% | | -10 | 1880 000 003 | 55.05 | 0.000 003 | 0.029 |
| 100% | | 0 | 1880 000 001 | 52.65 | 0.000 003 | 0.028 |
| 100% | | +10 | 1880 000 001 | 52.68 | 0.000 003 | 0.028 |
| 100% | | +30 | 1880 000 002 | 53.76 | 0.000 003 | 0.029 |
| 100% | | +40 | 1879 999 998 | 49.22 | 0.000 003 | 0.026 |
| 100% | | +50 | 1880 000 002 | 53.20 | 0.000 003 | 0.028 |
| 115% | | 4.370 | +20 | 1880 000 000 | 52.09 | 0.000 003 |
| 85% | 3.500 | +20 | 1880 000 002 | 53.23 | 0.000 003 | 0.028 |

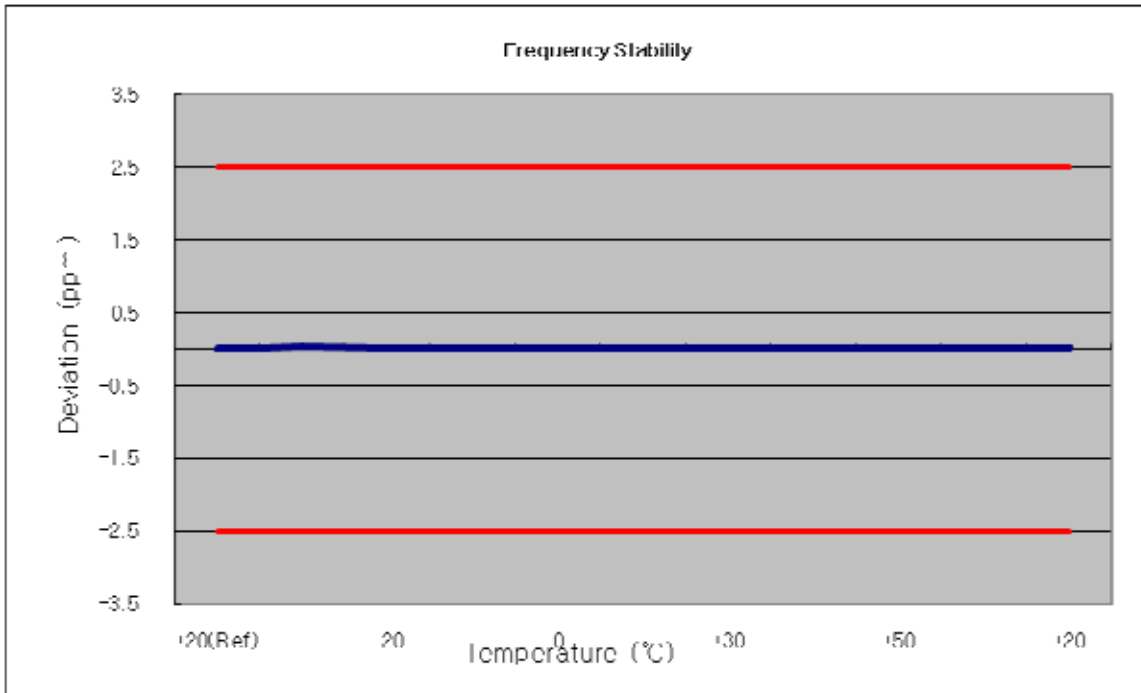

7.7.3 FREQUENCY STABILITY (WCDMA1900)

OPERATING FREQUENCY: 1,880,000,000 Hz
 CHANNEL: 9400
 REFERENCE VOLTAGE: 3.8 VDC
 DEVIATION LIMIT: ± 0.000 25 % or 2.5 ppm

| Voltage (%) | Power (VDC) | Temp. () | Frequency (Hz) | Frequency Error (Hz) | Deviation (%) | ppm |
|-------------|-------------|-----------|----------------|----------------------|---------------|--------|
| 100% | 3.800 | +20(Ref) | 1880 000 007 | 0 | 0.000 000 | 0.000 |
| 100% | | -30 | 1879 999 991 | -8.76 | 0.000 000 | -0.005 |
| 100% | | -20 | 1879 999 990 | -10.25 | -0.000 001 | -0.005 |
| 100% | | -10 | 1879 999 993 | -6.57 | 0.000 000 | -0.003 |
| 100% | | 0 | 1879 999 992 | -7.73 | 0.000 000 | -0.004 |
| 100% | | +10 | 1879 999 992 | -7.97 | 0.000 000 | -0.004 |
| 100% | | +30 | 1879 999 991 | -8.90 | 0.000 000 | -0.005 |
| 100% | | +40 | 1879 999 993 | -6.59 | 0.000 000 | -0.004 |
| 100% | | +50 | 1879 999 989 | -11.18 | -0.000 001 | -0.006 |
| 115% | 4.370 | +20 | 1879 999 993 | -7.49 | 0.000 000 | -0.004 |
| 85% | 3.500 | +20 | 1879 999 991 | -9.49 | -0.000 001 | -0.005 |

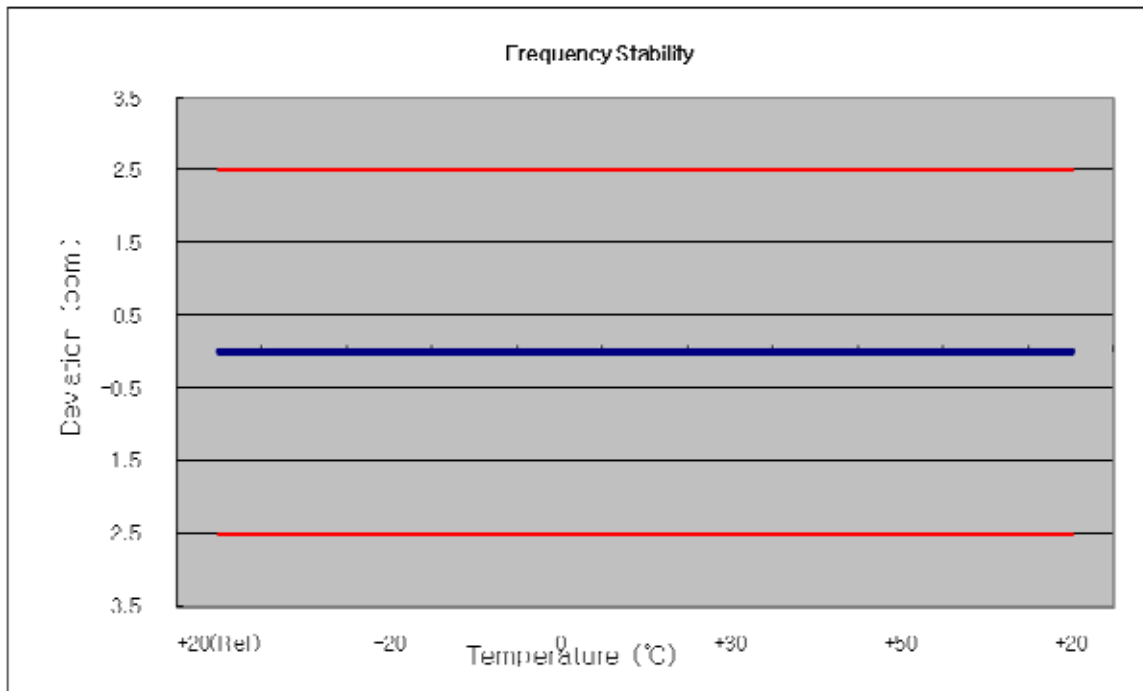

FCC CERTIFICATION REPORT

| | | | |
|---------------------------------|-------------------------------------|---------------------------|----------------------------------------------------------------------------|
| Test Report No. HCTR1311FR27 | Date of Issue: November 28, 2013 | EUT Type: Mobile Phone | www.hct.co.kr FCC ID: A3LGTS7580E |
|---------------------------------|-------------------------------------|---------------------------|----------------------------------------------------------------------------|



8. TEST PLOTS

| FCC CERTIFICATION REPORT | | | www.hct.co.kr |
|---------------------------------|-------------------------------------|---------------------------|--------------------------------------------------|
| Test Report No. HCTR1311FR27 | Date of Issue: November 28, 2013 | EUT Type: Mobile Phone | FCC ID: A3LGTS7580E |

■ GSM850 MODE (128 CH.) Occupied Bandwidth

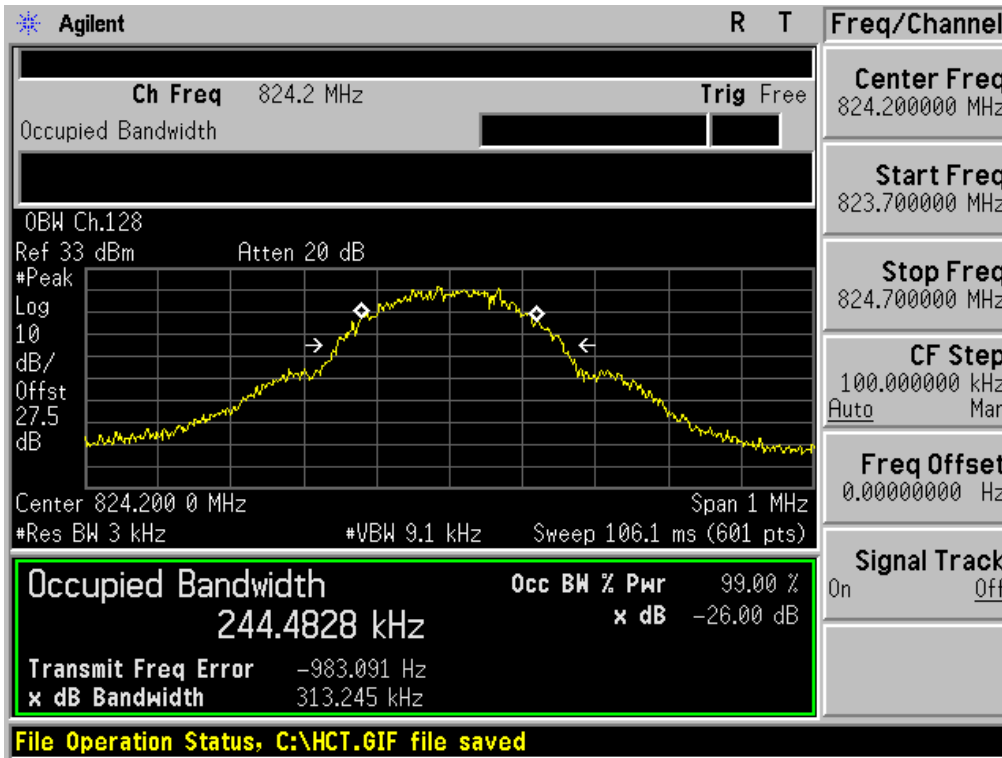

■ GSM850 MODE (190 CH.) Occupied Bandwidth

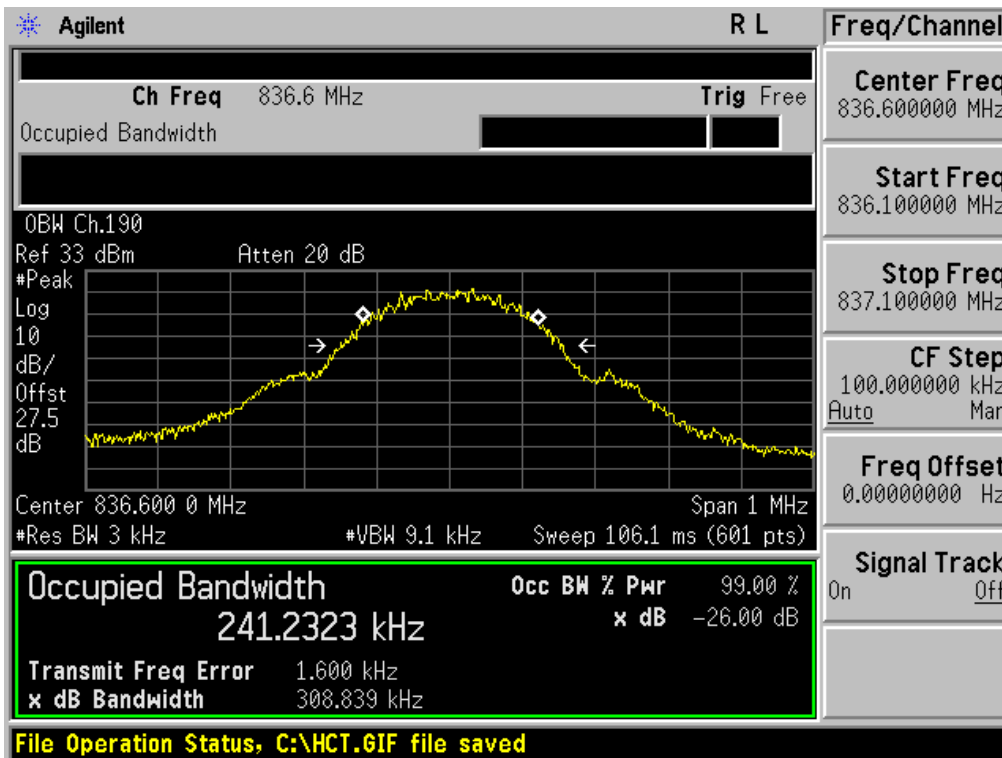

FCC CERTIFICATION REPORT

| | | | |
|---------------------------------|-------------------------------------|---------------------------|----------------------------------------------------------------------------|
| Test Report No. HCTR1311FR27 | Date of Issue: November 28, 2013 | EUT Type: Mobile Phone | www.hct.co.kr FCC ID: A3LGTS7580E |
|---------------------------------|-------------------------------------|---------------------------|----------------------------------------------------------------------------|

■ GSM850 MODE (251 CH.) Occupied Bandwidth

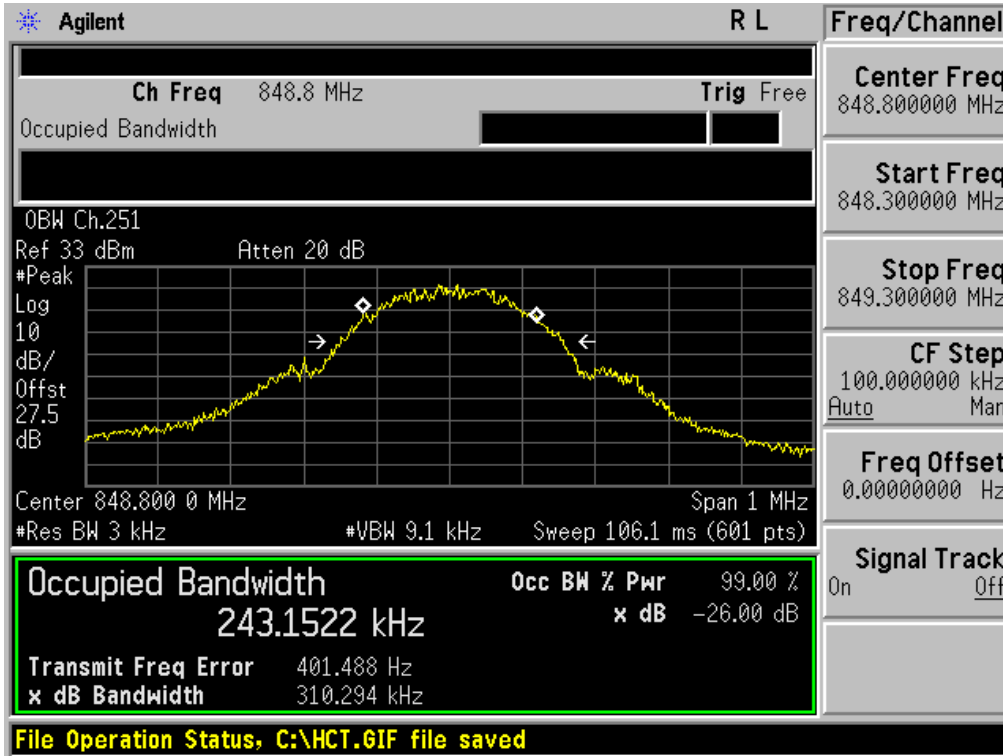

■ GSM1900 MODE (512 CH.) Occupied Bandwidth

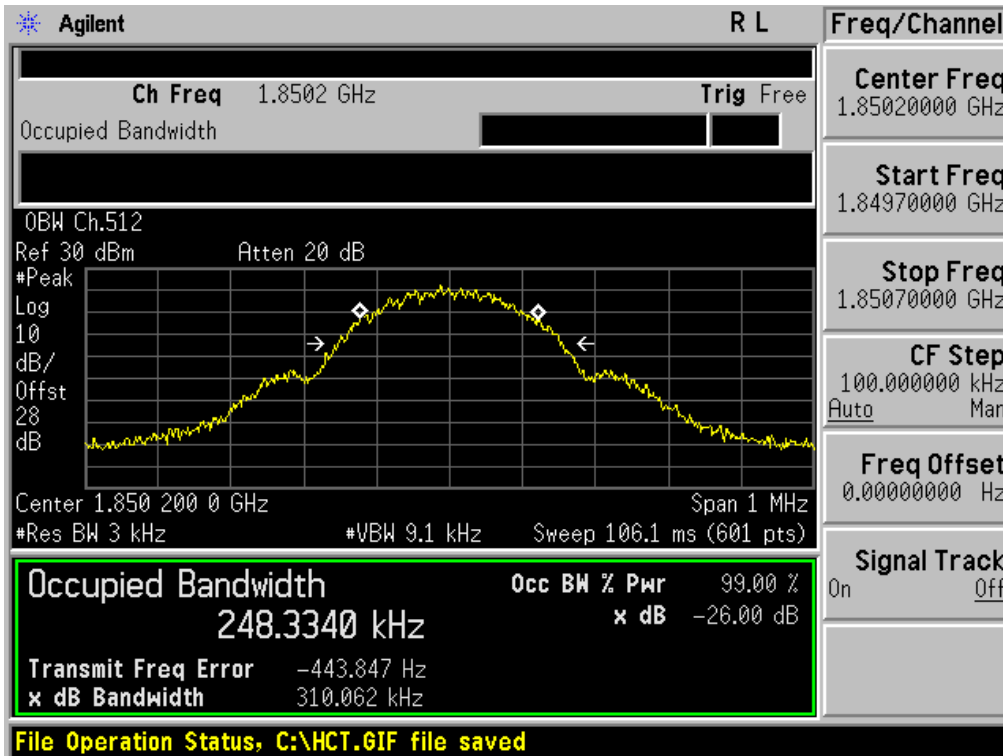

FCC CERTIFICATION REPORT

| | | | |
|---------------------------------|-------------------------------------|---------------------------|----------------------------------------------------------------------------|
| Test Report No. HCTR1311FR27 | Date of Issue: November 28, 2013 | EUT Type: Mobile Phone | www.hct.co.kr FCC ID: A3LGTS7580E |
|---------------------------------|-------------------------------------|---------------------------|----------------------------------------------------------------------------|

■ GSM1900 MODE (661 CH.) Occupied Bandwidth

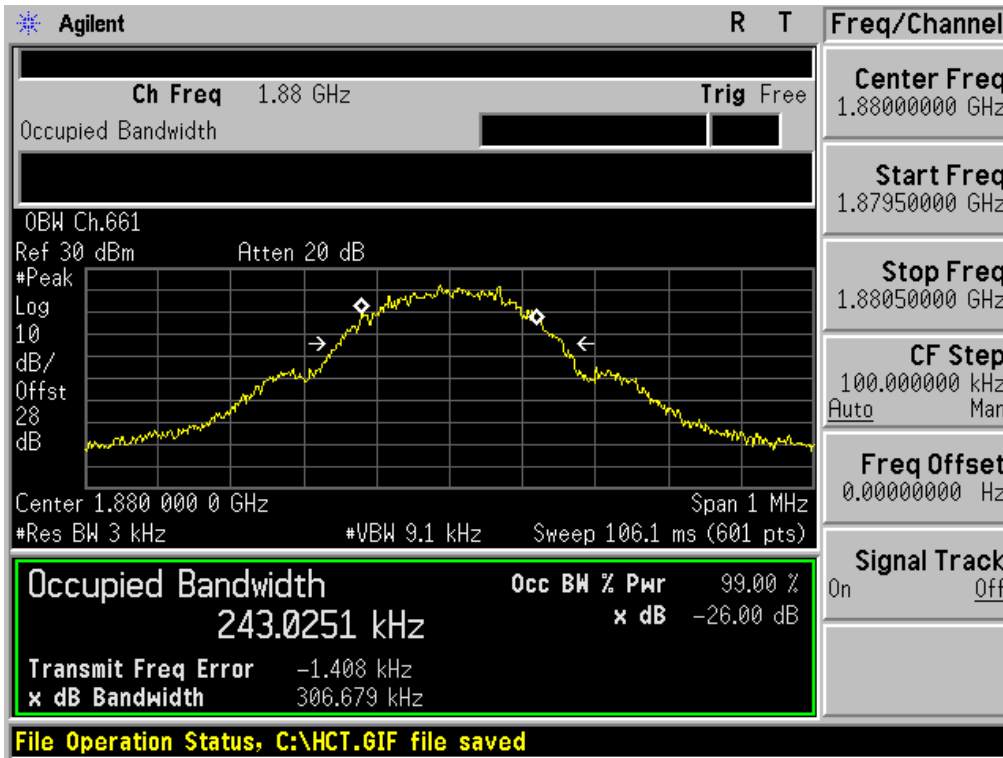

■ GSM1900 MODE (810 CH.) Occupied Bandwidth

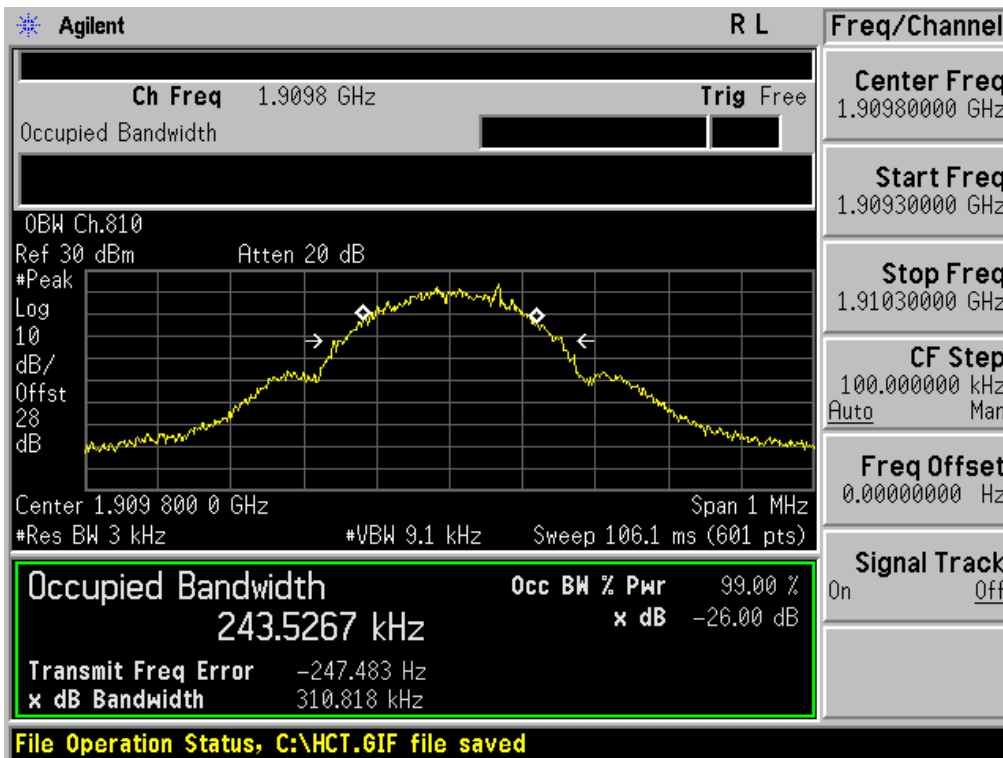

FCC CERTIFICATION REPORT

| | | | |
|---------------------------------|-------------------------------------|---------------------------|--------------------------------------------------|
| Test Report No. HCTR1311FR27 | Date of Issue: November 28, 2013 | EUT Type: Mobile Phone | www.hct.co.kr |
| | | | FCC ID: A3LGTS7580E |

■ GSM1900 MODE (661 CH.) Peak-to-Average Ratio P_{Pk}

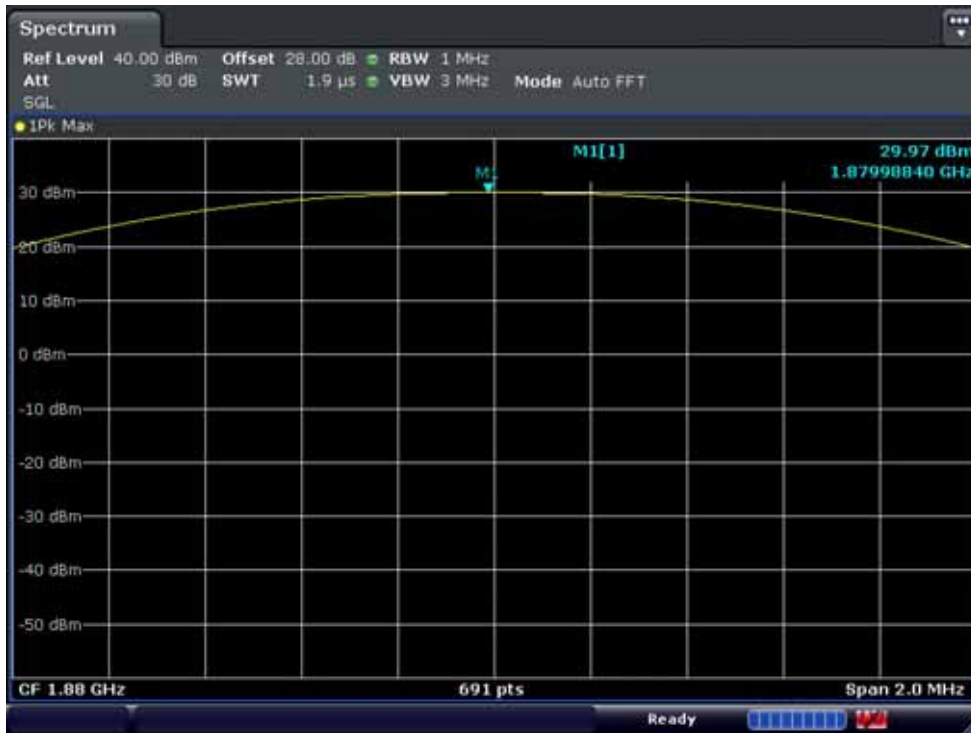

■ GSM1900 MODE (661 CH.) Peak-to-Average Ratio P_{Avg}

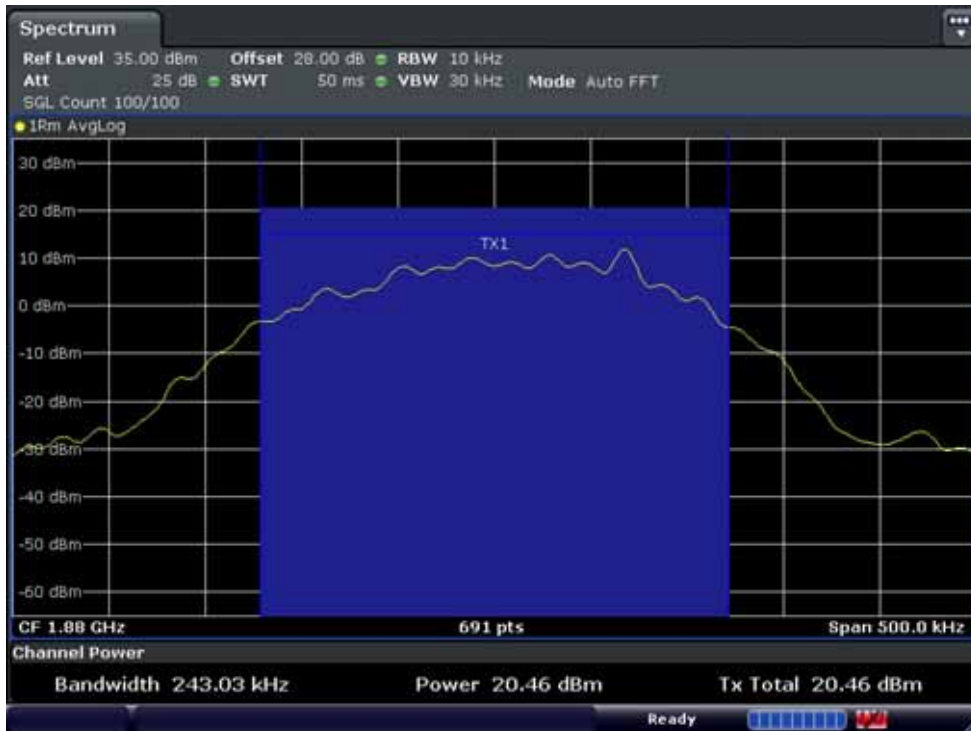

■ GSM1900 MODE (661 CH.) Peak-to-Average Ratio P_{Avg}



■ WCDMA1900 MODE (9262 CH.) Occupied Bandwidth

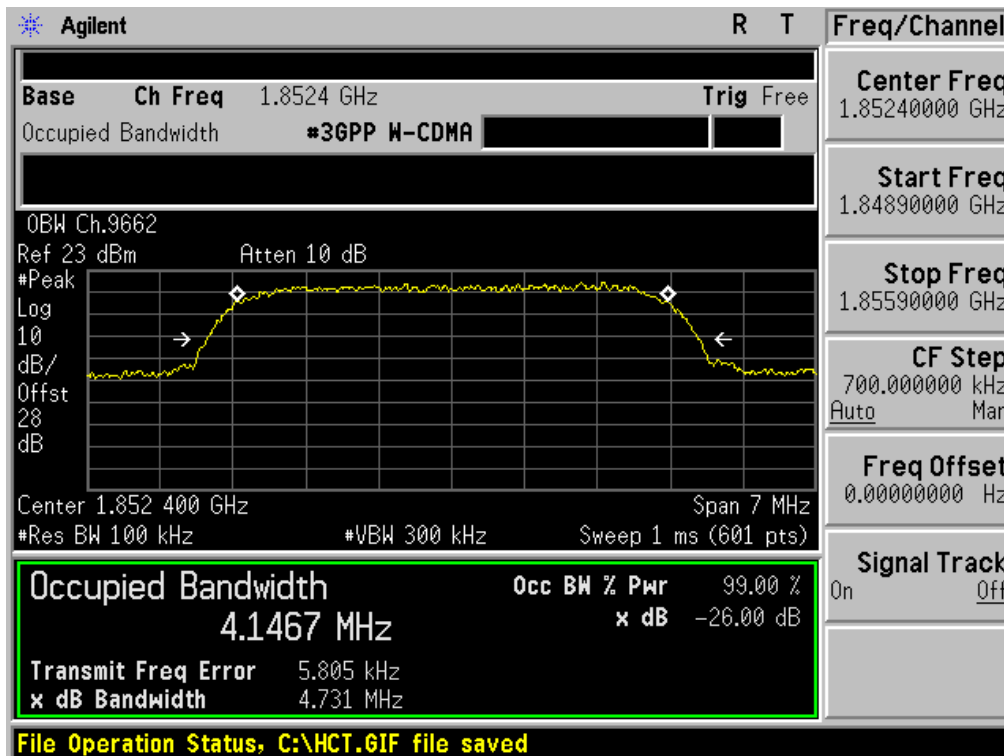

FCC CERTIFICATION REPORT

| | | | |
|---------------------------------|-------------------------------------|---------------------------|----------------------------------------------------------------------------|
| Test Report No. HCTR1311FR27 | Date of Issue: November 28, 2013 | EUT Type: Mobile Phone | www.hct.co.kr FCC ID: A3LGTS7580E |
|---------------------------------|-------------------------------------|---------------------------|----------------------------------------------------------------------------|

■ WCDMA1900 MODE (9400 CH.) Occupied Bandwidth

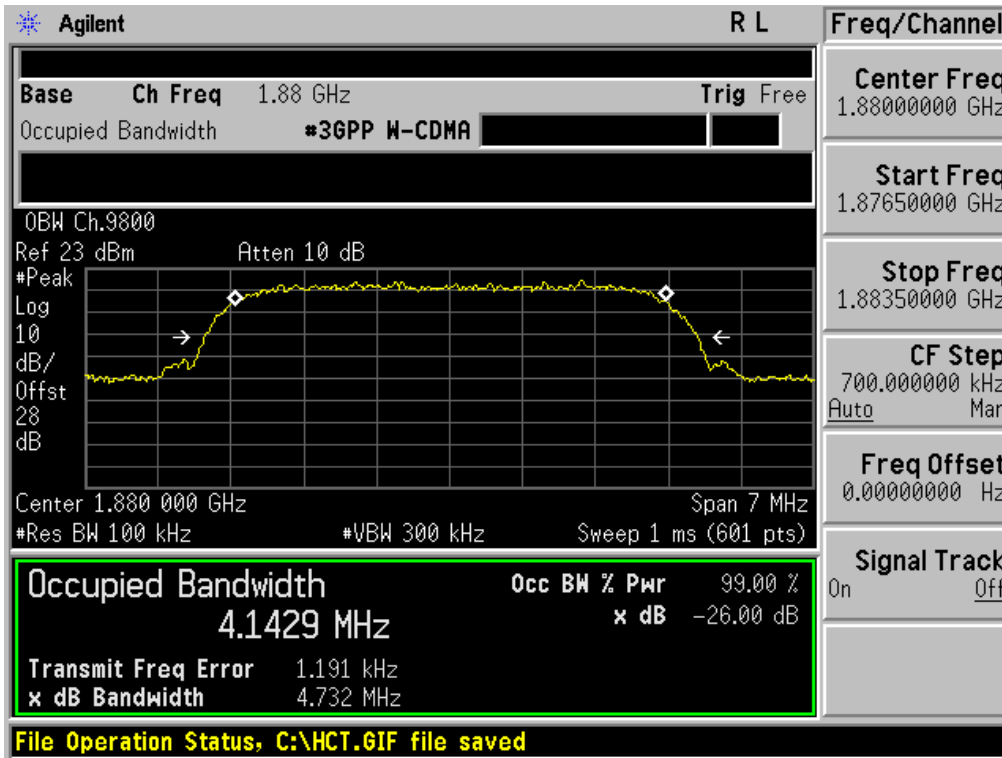

■ WCDMA1900 MODE (9538 CH.) Occupied Bandwidth

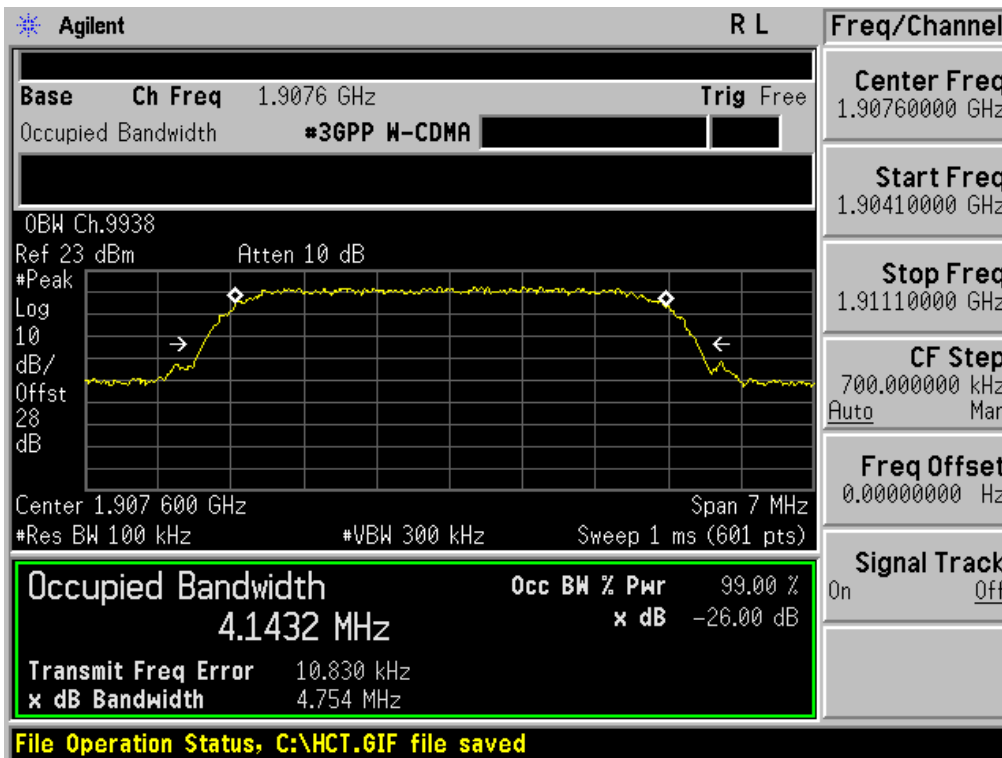

FCC CERTIFICATION REPORT

| | | | |
|---------------------------------|-------------------------------------|---------------------------|----------------------------------------------------------------------------|
| Test Report No. HCTR1311FR27 | Date of Issue: November 28, 2013 | EUT Type: Mobile Phone | www.hct.co.kr FCC ID: A3LGTS7580E |
|---------------------------------|-------------------------------------|---------------------------|----------------------------------------------------------------------------|

■ WCDMA1900 MODE (9400 CH.) Peak-to-Average Ratio

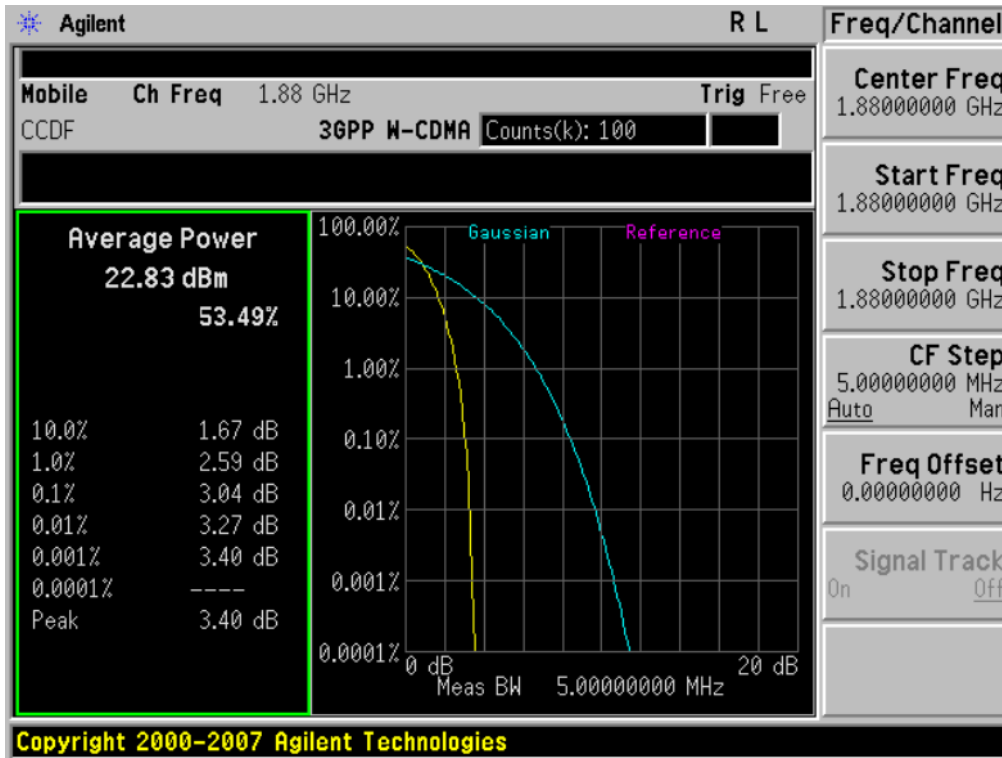

■ GSM850 MODE (128 CH.) Block Edge 1

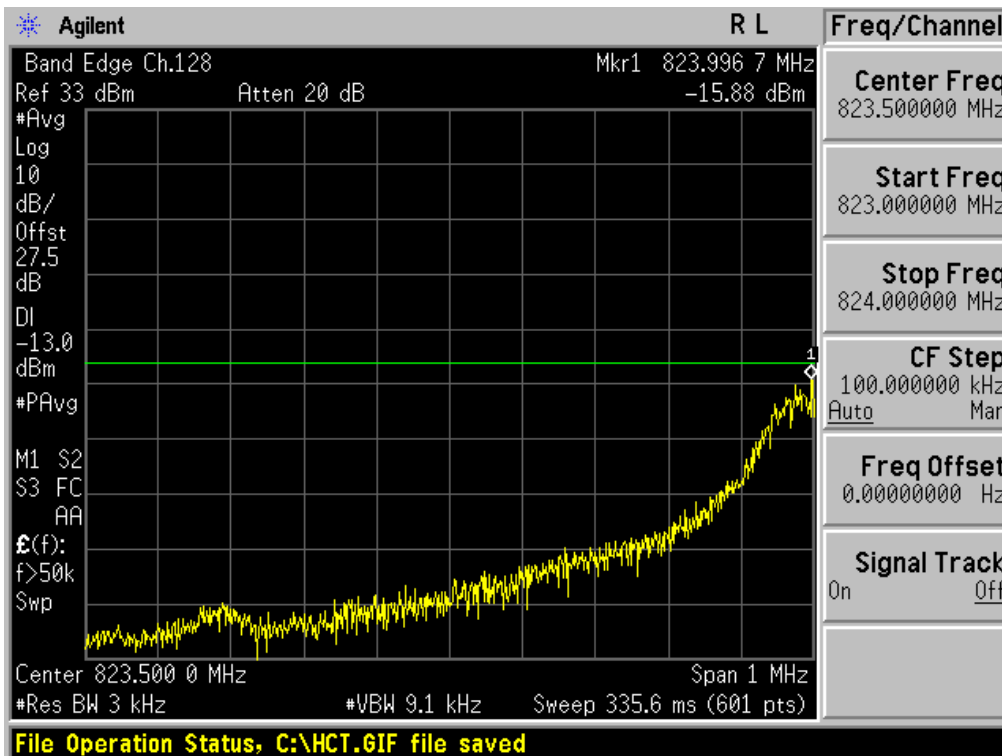

FCC CERTIFICATION REPORT

| | | | |
|---------------------------------|-------------------------------------|---------------------------|----------------------------------------------------------------------------|
| Test Report No. HCTR1311FR27 | Date of Issue: November 28, 2013 | EUT Type: Mobile Phone | www.hct.co.kr FCC ID: A3LGTS7580E |
|---------------------------------|-------------------------------------|---------------------------|----------------------------------------------------------------------------|

■ GSM850 MODE (128 CH.) Block Edge 2

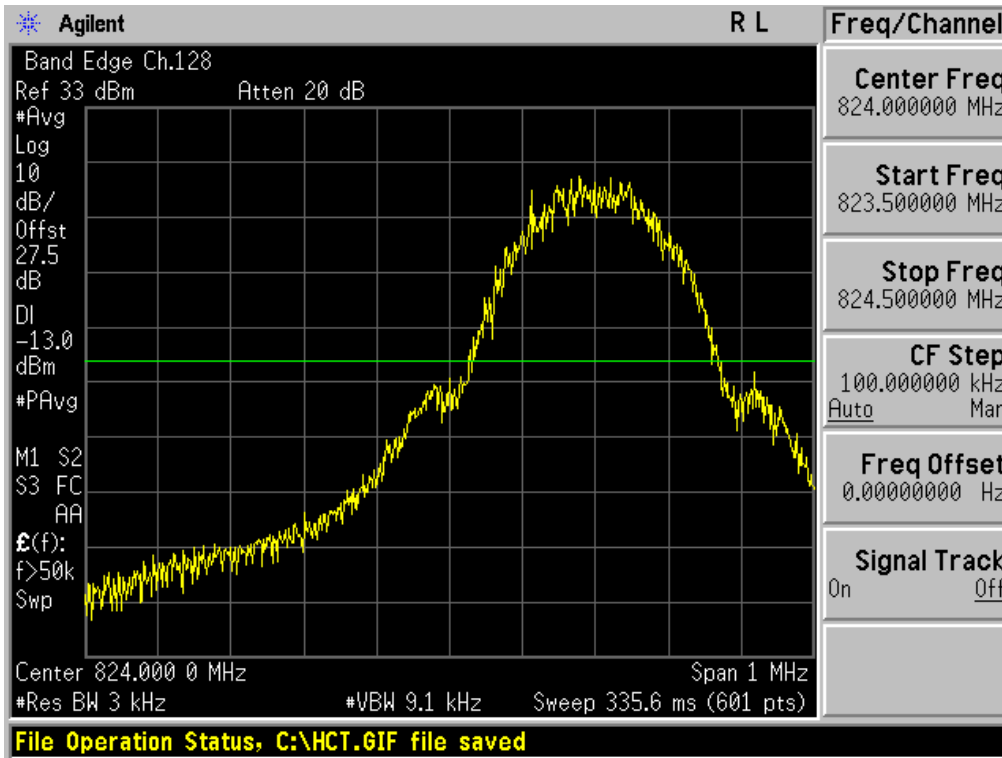

■ GSM850 MODE (251 CH.) Block Edge 1

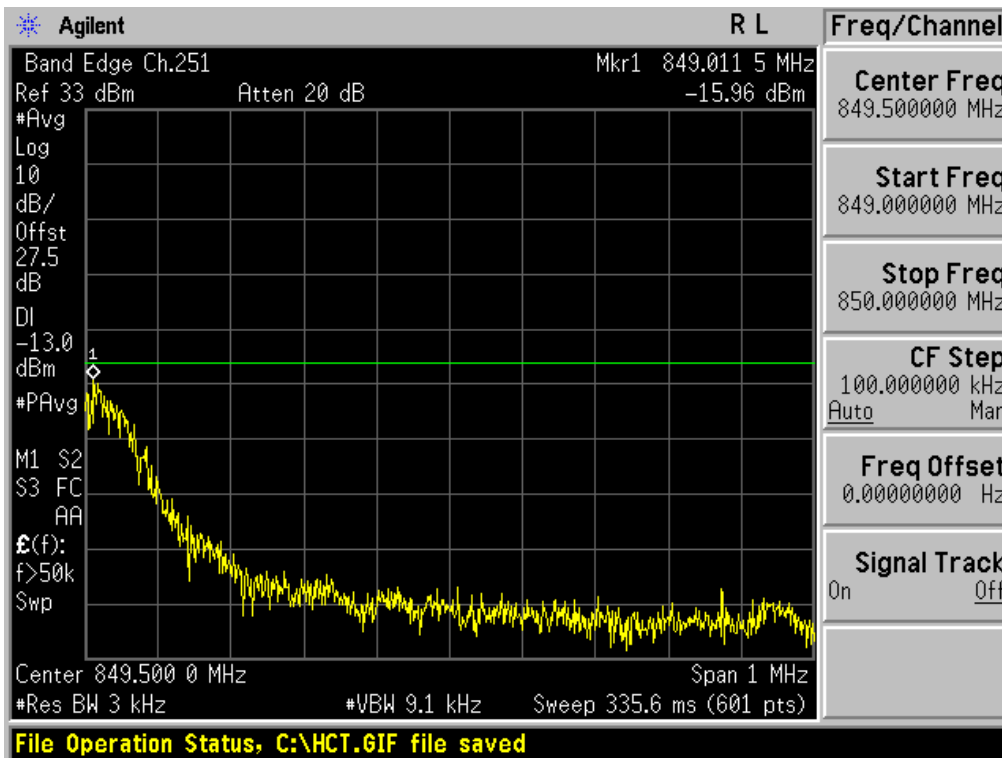

FCC CERTIFICATION REPORT

| | | | |
|---------------------------------|-------------------------------------|---------------------------|----------------------------------------------------------------------------|
| Test Report No. HCTR1311FR27 | Date of Issue: November 28, 2013 | EUT Type: Mobile Phone | www.hct.co.kr FCC ID: A3LGTS7580E |
|---------------------------------|-------------------------------------|---------------------------|----------------------------------------------------------------------------|

■ GSM850 MODE (251 CH.) Block Edge 2

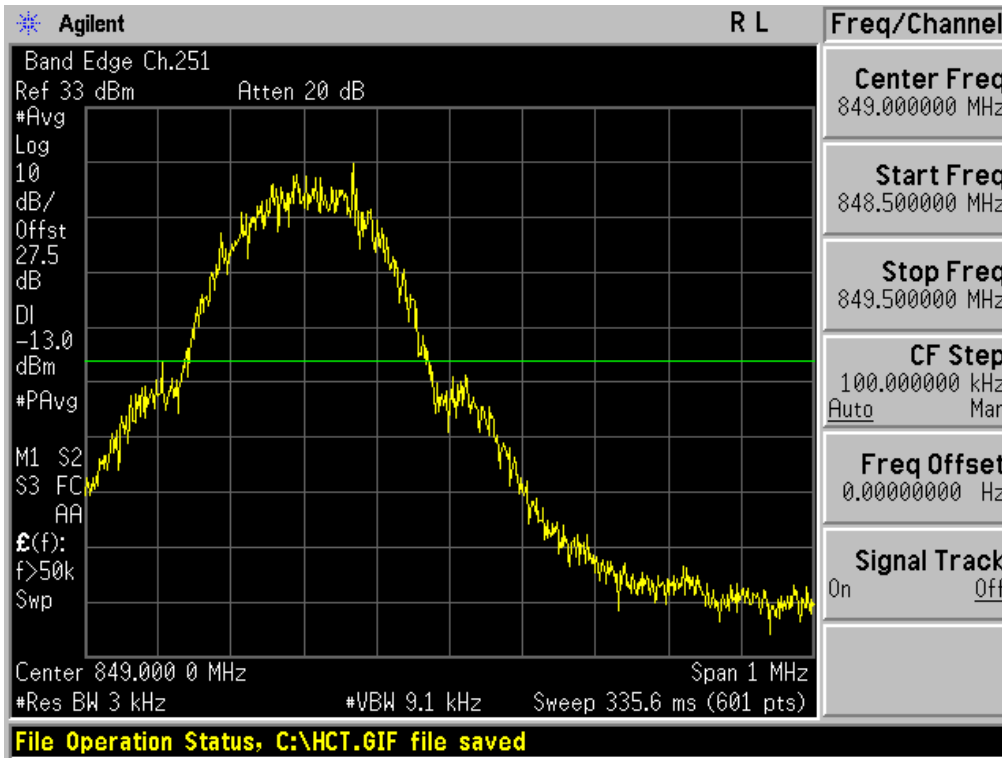

■ GSM1900 MODE (512 CH.) Block Edge 1

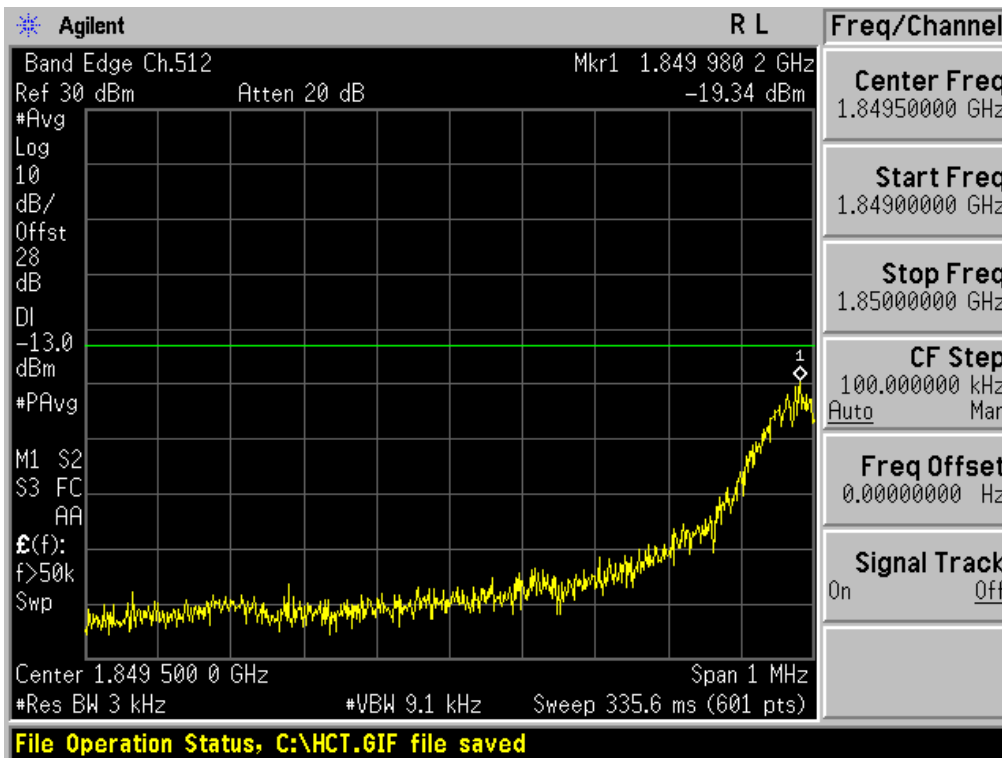

FCC CERTIFICATION REPORT

| | | | |
|---------------------------------|-------------------------------------|---------------------------|--------------------------------------------------|
| FCC CERTIFICATION REPORT | | | www.hct.co.kr |
| Test Report No. HCTR1311FR27 | Date of Issue: November 28, 2013 | EUT Type: Mobile Phone | FCC ID: A3LGTS7580E |

■ GSM1900 MODE (512 CH.) Block Edge 2

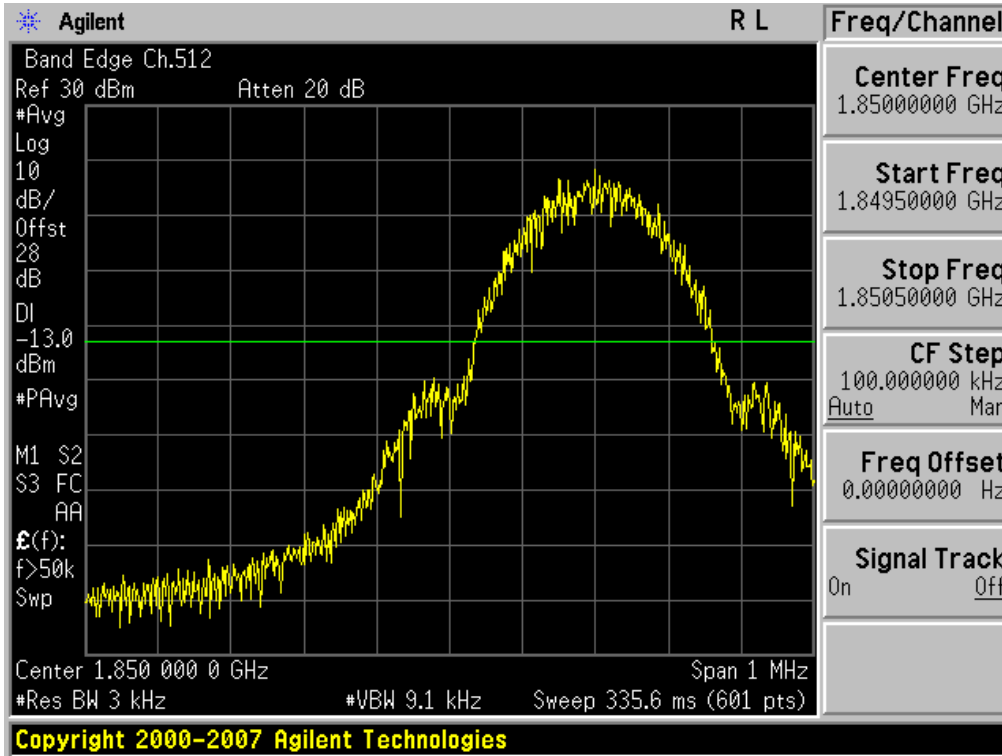

■ GSM1900 MODE (810 CH.) Block Edge 1

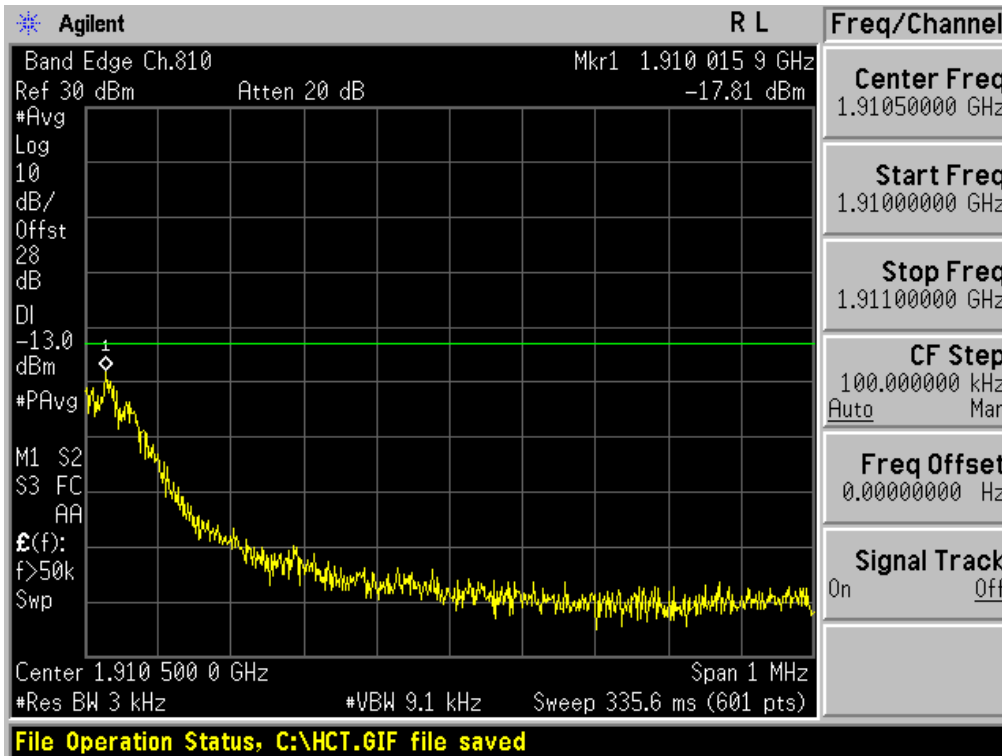

FCC CERTIFICATION REPORT

| | | | |
|---------------------------------|-------------------------------------|---------------------------|----------------------------------------------------------------------------|
| Test Report No. HCTR1311FR27 | Date of Issue: November 28, 2013 | EUT Type: Mobile Phone | www.hct.co.kr FCC ID: A3LGTS7580E |
|---------------------------------|-------------------------------------|---------------------------|----------------------------------------------------------------------------|

■ GSM1900 MODE (810 CH.) Block Edge 2

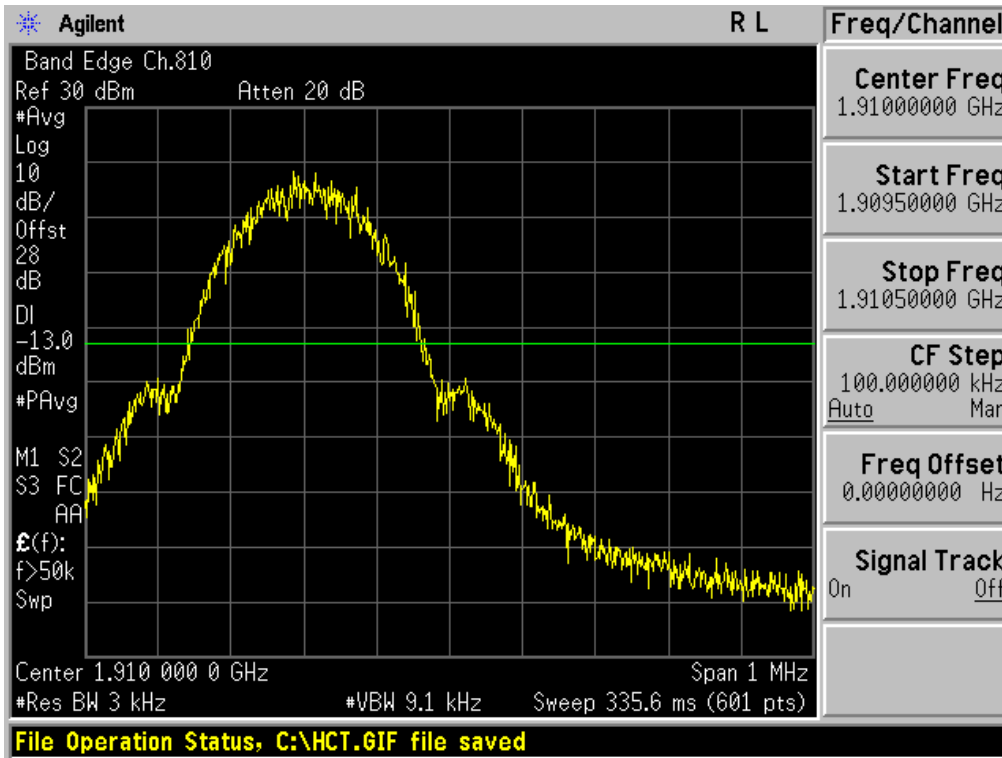

■ WCDMA1900 MODE (9262 CH.) Block Edge

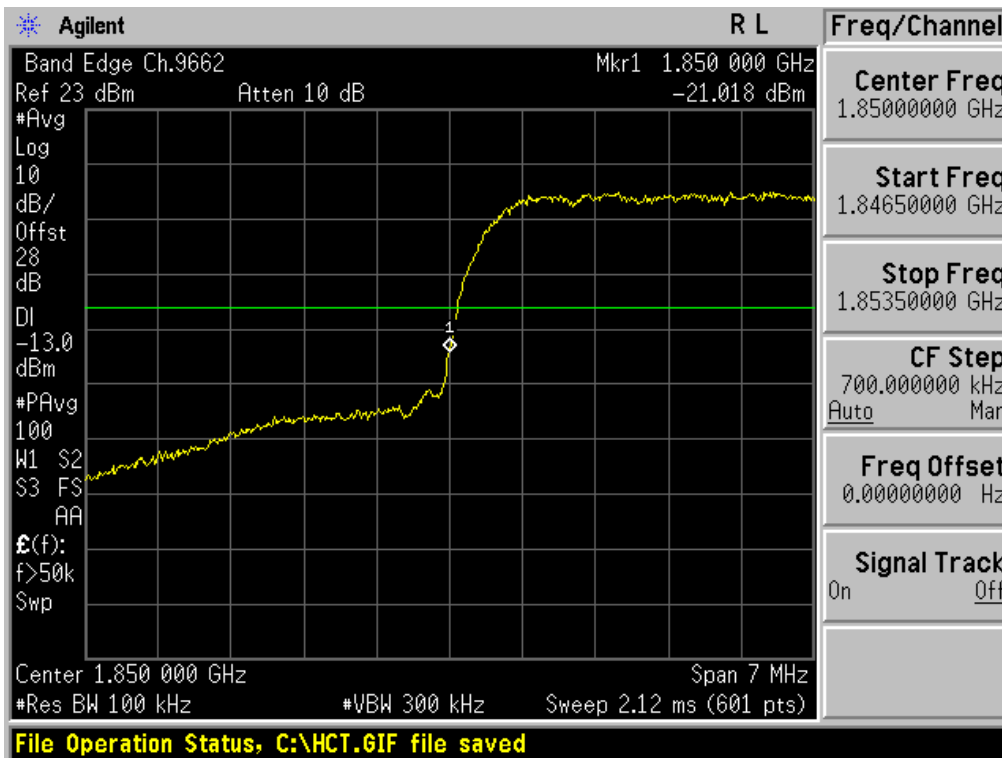

FCC CERTIFICATION REPORT

| | | | |
|---------------------------------|-------------------------------------|---------------------------|--------------------------------------------------|
| FCC CERTIFICATION REPORT | | | www.hct.co.kr |
| Test Report No. HCTR1311FR27 | Date of Issue: November 28, 2013 | EUT Type: Mobile Phone | FCC ID: A3LGTS7580E |

■ WCDMA1900 MODE (9538 CH.) Block Edge

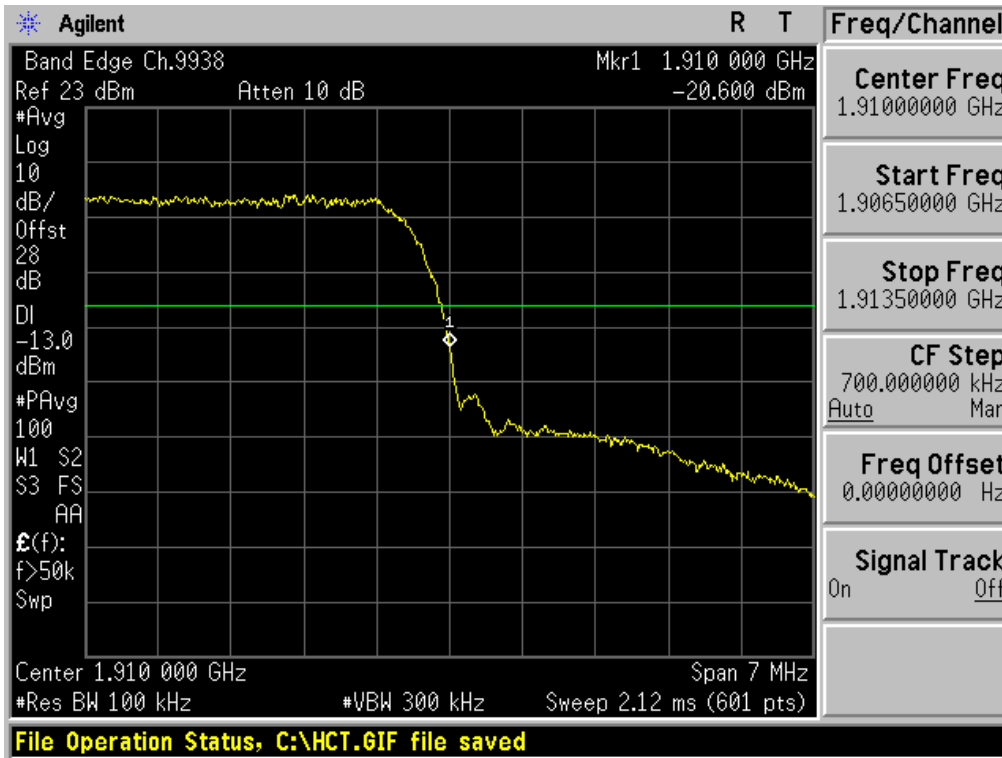

■ WCDMA1900 MODE (9262 CH.) – 4 MHz Span

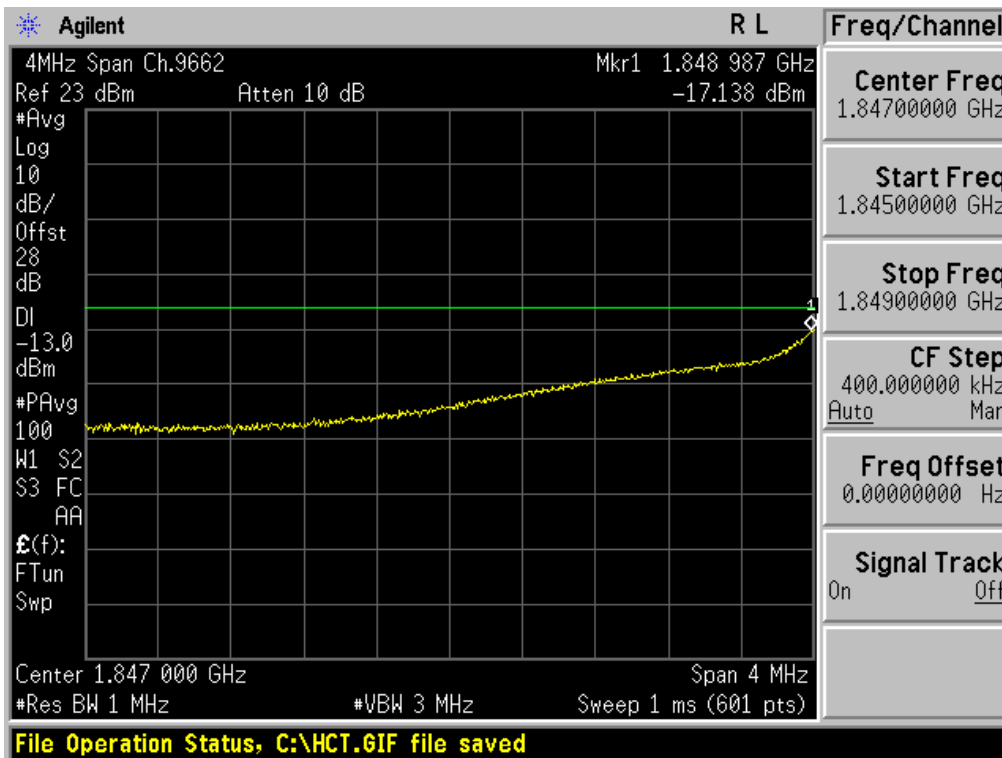

FCC CERTIFICATION REPORT

| | | | |
|---------------------------------|-------------------------------------|---------------------------|----------------------------------------------------------------------------|
| Test Report No. HCTR1311FR27 | Date of Issue: November 28, 2013 | EUT Type: Mobile Phone | www.hct.co.kr FCC ID: A3LGTS7580E |
|---------------------------------|-------------------------------------|---------------------------|----------------------------------------------------------------------------|

■ WCDMA1900 MODE (9538 CH.) – 4 MHz Span

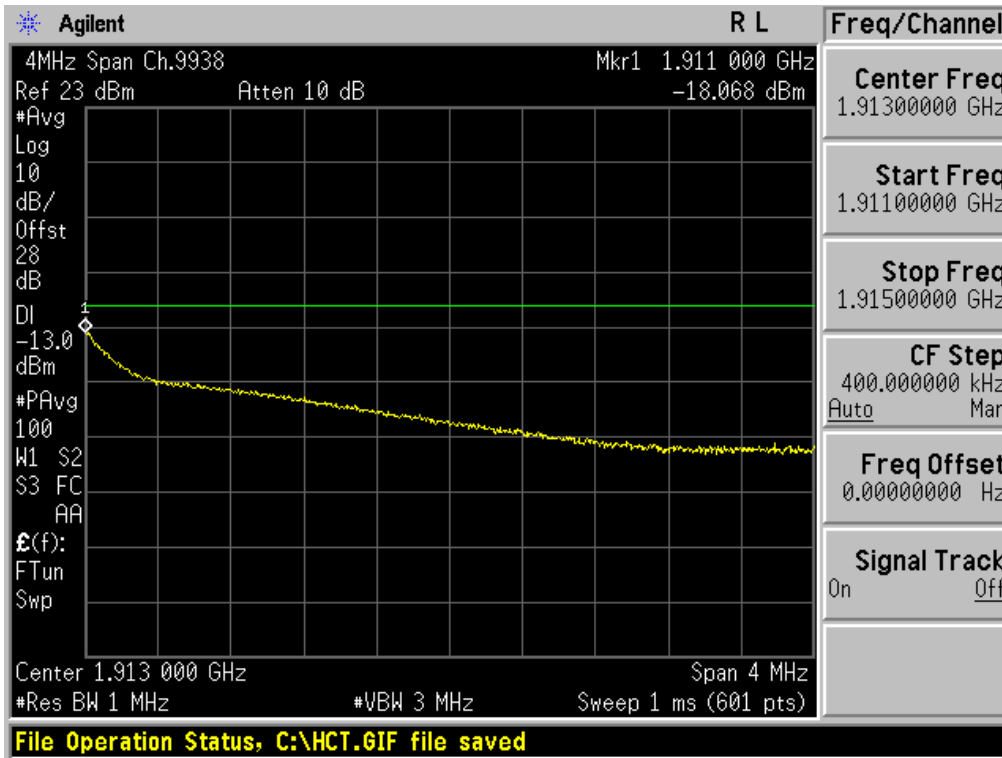

■ GSM850 MODE (128 CH.) Conducted Spurious Emissions1

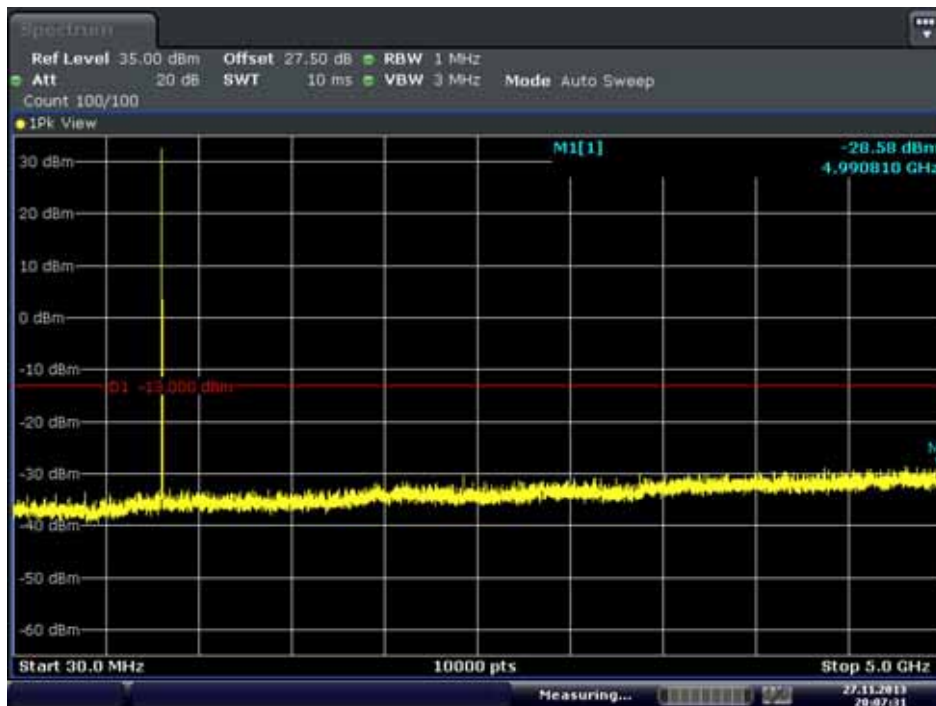

Date: 27.NOV.2013 20:07:32

| FCC CERTIFICATION REPORT | | | www.hct.co.kr |
|---------------------------------|-------------------------------------|---------------------------|--------------------------------------------------|
| Test Report No. HCTR1311FR27 | Date of Issue: November 28, 2013 | EUT Type: Mobile Phone | FCC ID: A3LGTS7580E |

■ GSM850 MODE (128 CH.) Conducted Spurious Emissions2

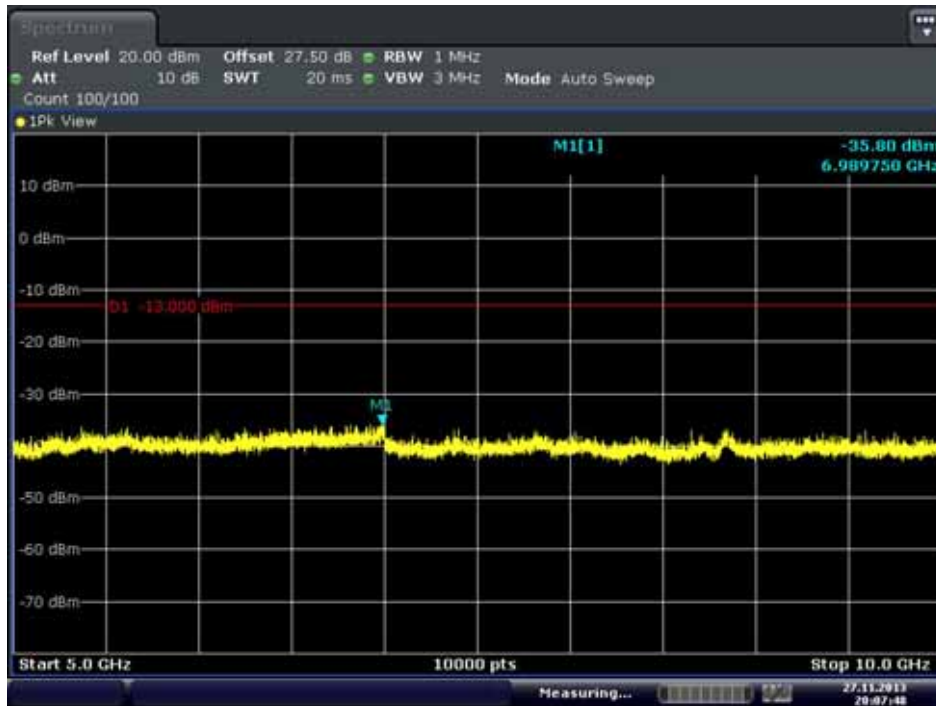

Date: 27.NOV.2013 20:07:45

■ GSM850 MODE (190 CH.) Conducted Spurious Emissions1

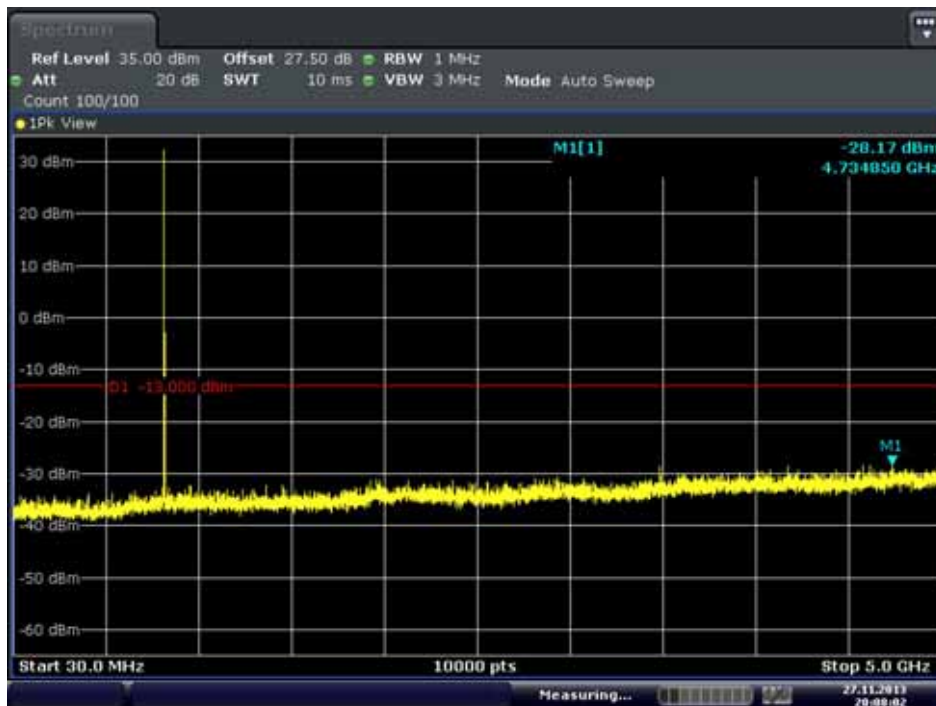

Date: 27.NOV.2013 20:08:03

FCC CERTIFICATION REPORT

| | | | |
|---------------------------------|-------------------------------------|---------------------------|--------------------------------------------------|
| FCC CERTIFICATION REPORT | | | www.hct.co.kr |
| Test Report No. HCTR1311FR27 | Date of Issue: November 28, 2013 | EUT Type: Mobile Phone | FCC ID: A3LGTS7580E |

■ GSM850 MODE (190 CH.) Conducted Spurious Emissions2

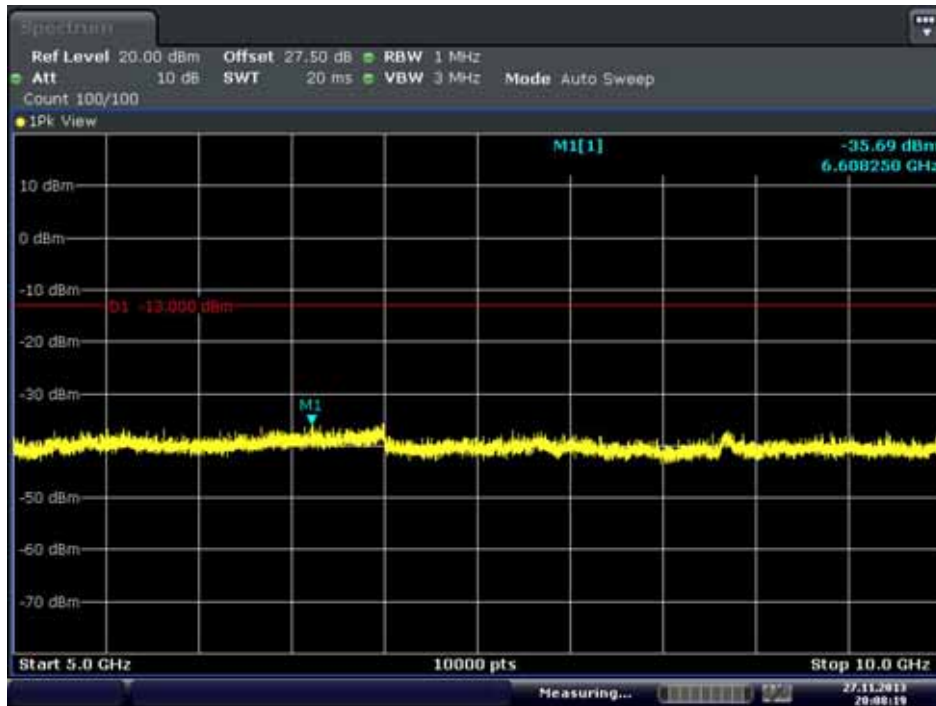

Date: 27.NOV.2013 20:08:20

■ GSM850 MODE (251 CH.) Conducted Spurious Emissions1

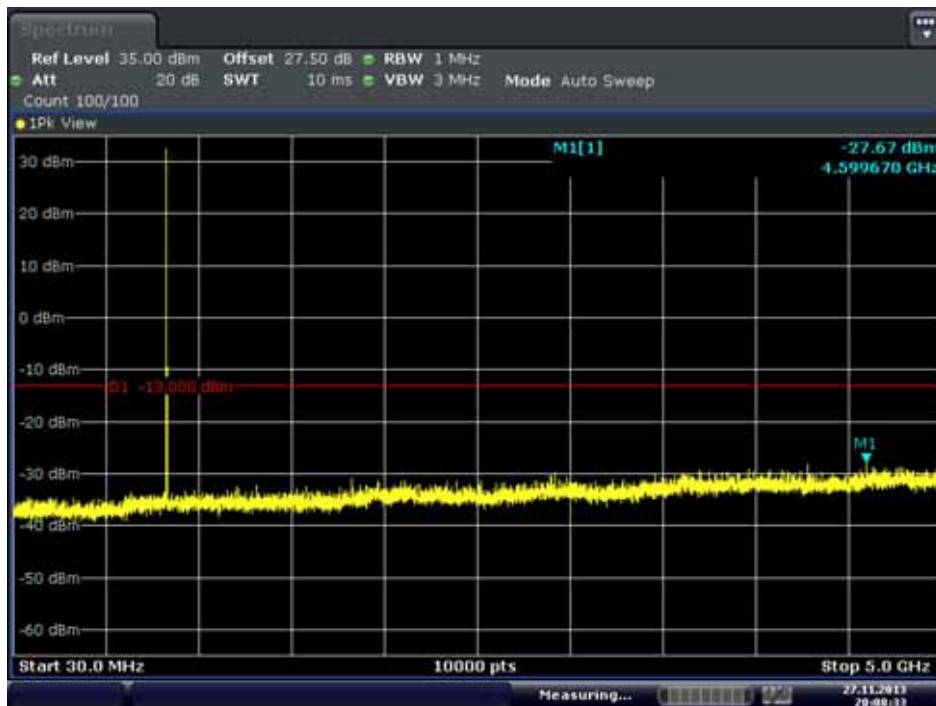

Date: 27.NOV.2013 20:08:34

FCC CERTIFICATION REPORT

| | | | |
|---------------------------------|-------------------------------------|---------------------------|--------------------------------------------------|
| FCC CERTIFICATION REPORT | | | www.hct.co.kr |
| Test Report No. HCTR1311FR27 | Date of Issue: November 28, 2013 | EUT Type: Mobile Phone | FCC ID: A3LGTS7580E |

■ GSM850 MODE (251 CH.) Conducted Spurious Emissions2

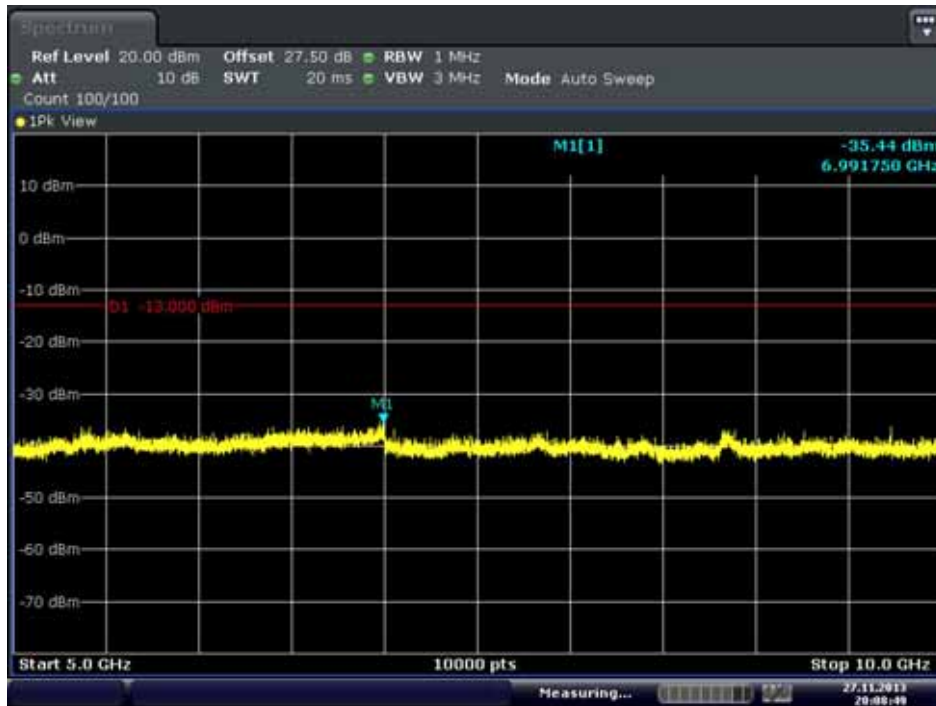

Date: 27.NOV.2013 20:08:50

■ GSM1900 MODE (512 CH.) Conducted Spurious Emissions1

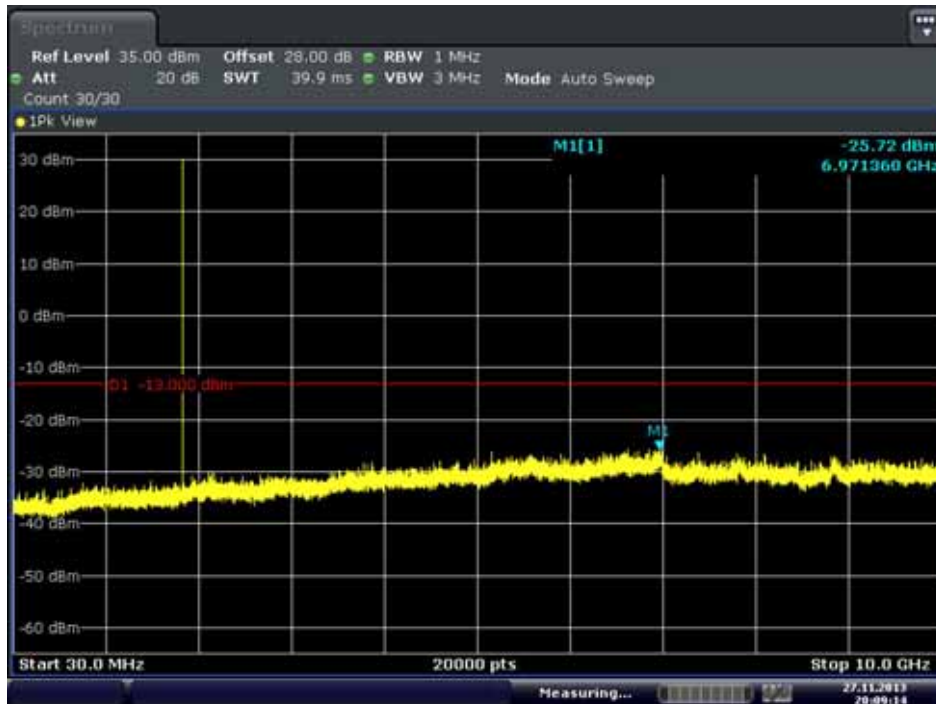

Date: 27.NOV.2013 20:09:15

FCC CERTIFICATION REPORT

| | | | |
|---------------------------------|-------------------------------------|---------------------------|--------------------------------------------------|
| FCC CERTIFICATION REPORT | | | www.hct.co.kr |
| Test Report No. HCTR1311FR27 | Date of Issue: November 28, 2013 | EUT Type: Mobile Phone | FCC ID: A3LGTS7580E |

■ GSM1900 MODE (512 CH.) Conducted Spurious Emissions2



Date: 27.NOV.2013 20:09:31

■ GSM1900 MODE (661 CH) Conducted Spurious Emissions1

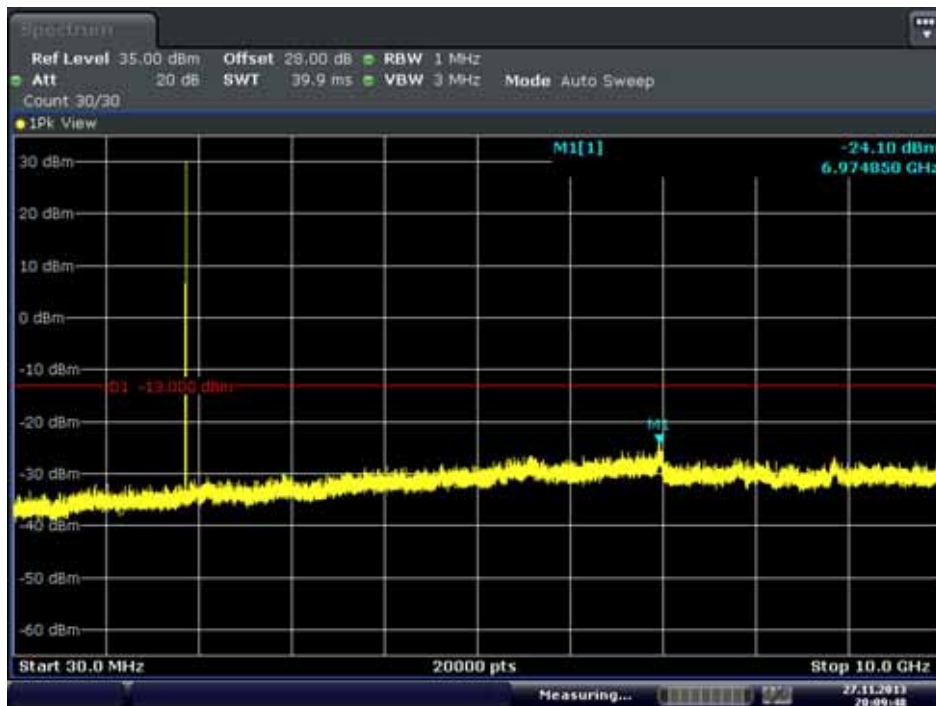

Date: 27.NOV.2013 20:09:45

FCC CERTIFICATION REPORT

| | | | |
|---------------------------------|-------------------------------------|---------------------------|--------------------------------------------------|
| FCC CERTIFICATION REPORT | | | www.hct.co.kr |
| Test Report No. HCTR1311FR27 | Date of Issue: November 28, 2013 | EUT Type: Mobile Phone | FCC ID: A3LGTS7580E |

■ GSM1900 MODE (661 CH.) Conducted Spurious Emissions2

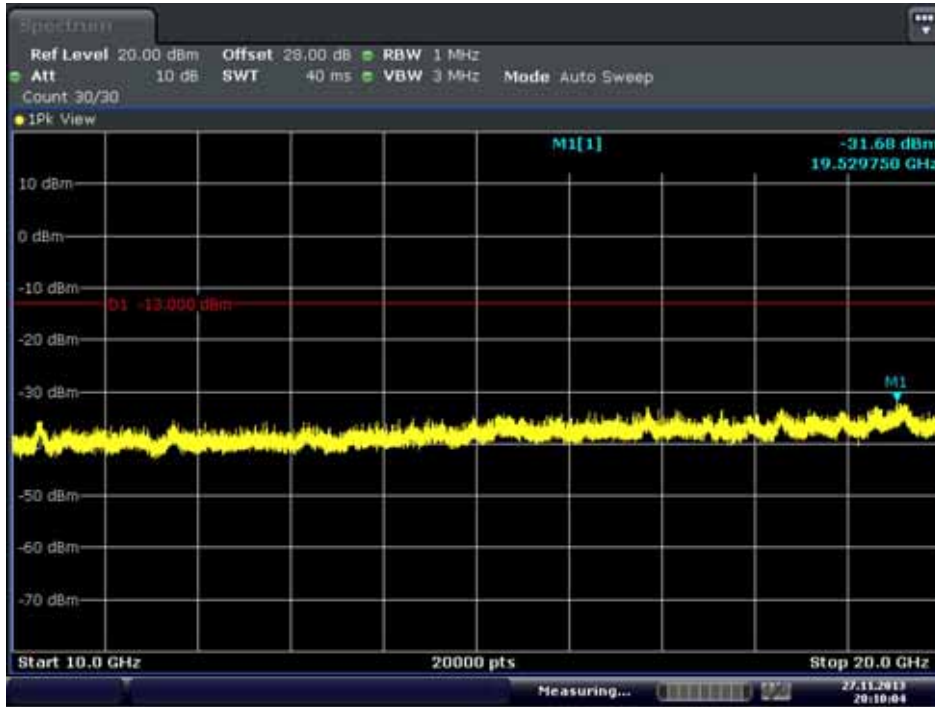

Date: 27.NOV.2013 20:10:05

■ GSM1900 MODE (810 CH.) Conducted Spurious Emissions1

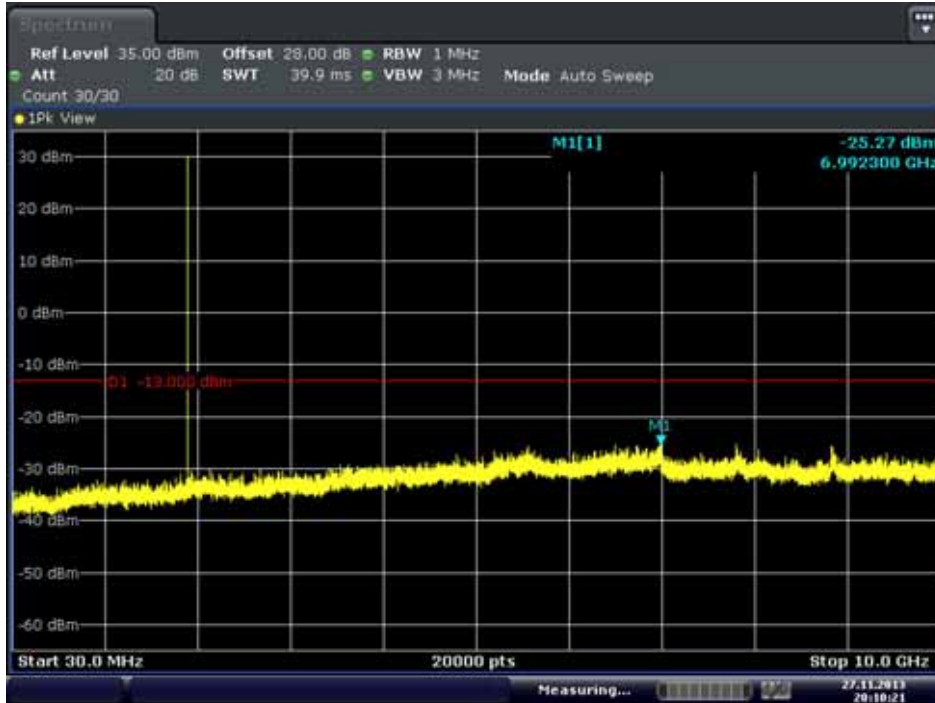

Date: 27.NOV.2013 20:10:22

FCC CERTIFICATION REPORT

| | | | |
|---------------------------------|-------------------------------------|---------------------------|--------------------------------------------------|
| FCC CERTIFICATION REPORT | | | www.hct.co.kr |
| Test Report No. HCTR1311FR27 | Date of Issue: November 28, 2013 | EUT Type: Mobile Phone | FCC ID: A3LGTS7580E |

■ GSM1900 MODE (810 CH.) Conducted Spurious Emissions2



Date: 27.NOV.2013 20:10:37

■ WCDMA1900 MODE (9262 CH.) Conducted Spurious Emissions1

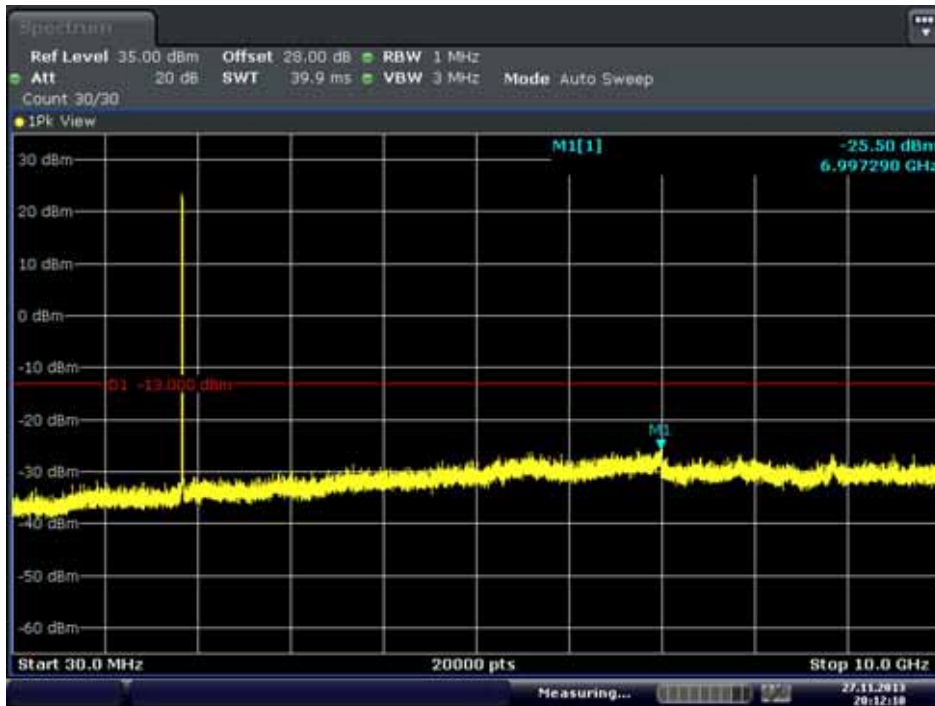

Date: 27.NOV.2013 20:12:11

FCC CERTIFICATION REPORT

| | | | |
|---------------------------------|-------------------------------------|---------------------------|--------------------------------------------------|
| FCC CERTIFICATION REPORT | | | www.hct.co.kr |
| Test Report No. HCTR1311FR27 | Date of Issue: November 28, 2013 | EUT Type: Mobile Phone | FCC ID: A3LGTS7580E |

■ WCDMA1900 MODE (9262 CH.) Conducted Spurious Emissions2

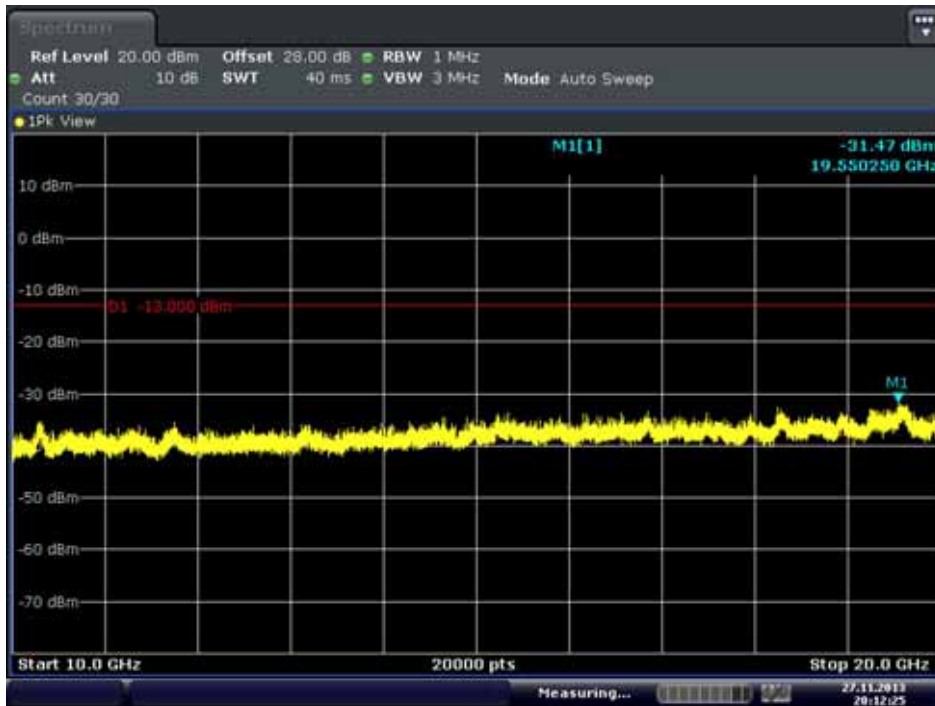

Date: 27.NOV.2013 20:12:26

■ WCDMA1900 MODE (9400 CH.) Conducted Spurious Emissions1

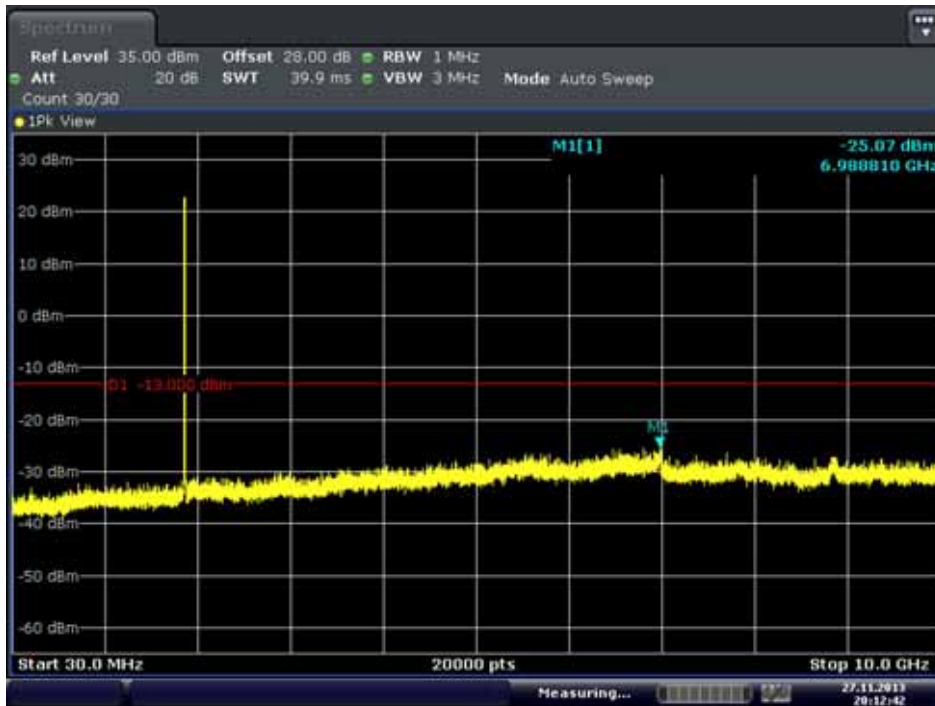

Date: 27.NOV.2013 20:12:43

FCC CERTIFICATION REPORT

| | | | |
|---------------------------------|-------------------------------------|---------------------------|--------------------------------------------------|
| FCC CERTIFICATION REPORT | | | www.hct.co.kr |
| Test Report No. HCTR1311FR27 | Date of Issue: November 28, 2013 | EUT Type: Mobile Phone | FCC ID: A3LGTS7580E |

■ WCDMA1900 MODE (9400 CH.) Conducted Spurious Emissions2

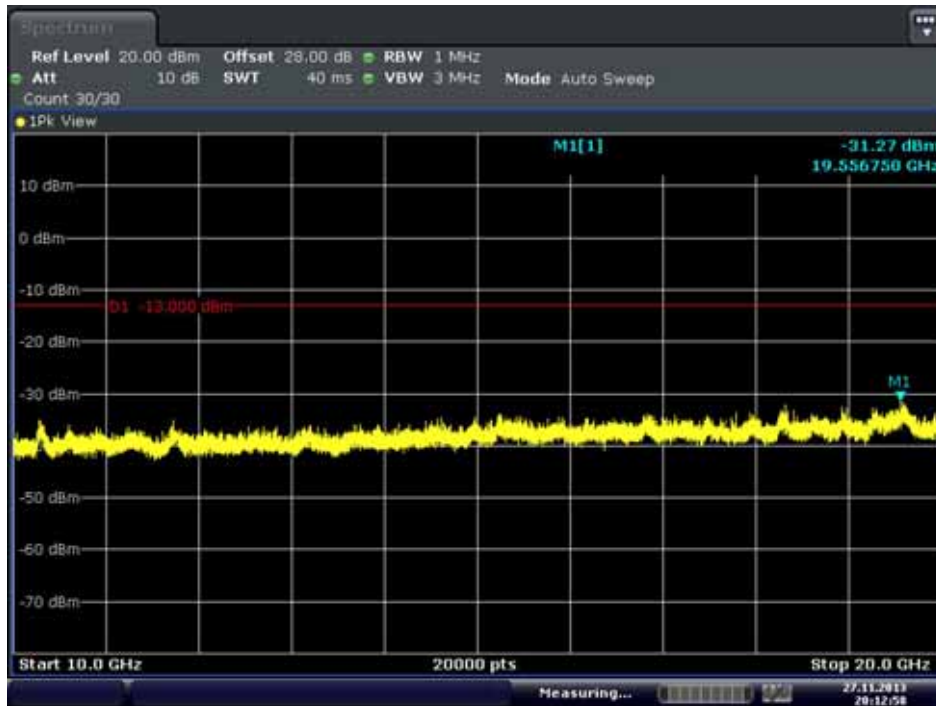

Date: 27.NOV.2013 20:12:58

■ WCDMA1900 MODE (9538 CH.) Conducted Spurious Emissions1

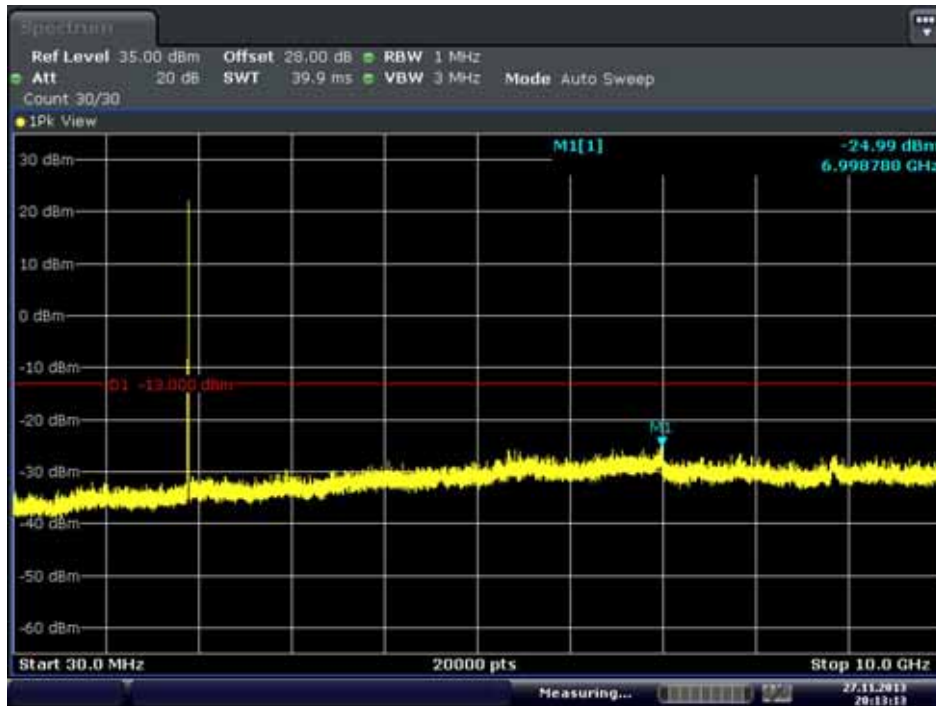

Date: 27.NOV.2013 20:13:14

FCC CERTIFICATION REPORT

| | | | |
|---------------------------------|-------------------------------------|---------------------------|--------------------------------------------------|
| FCC CERTIFICATION REPORT | | | www.hct.co.kr |
| Test Report No. HCTR1311FR27 | Date of Issue: November 28, 2013 | EUT Type: Mobile Phone | FCC ID: A3LGT57580E |

■ WCDMA1900 MODE (9538 CH.) Conducted Spurious Emissions2



Date: 27.NOV.2013 - 20:13:30

FCC CERTIFICATION REPORT

| | | | |
|---------------------------------|-------------------------------------|---------------------------|--------------------------------------------------|
| FCC CERTIFICATION REPORT | | | www.hct.co.kr |
| Test Report No. HCTR1311FR27 | Date of Issue: November 28, 2013 | EUT Type: Mobile Phone | FCC ID: A3LGTS7580E |