



SAMSUNG ELECTRONICS Co., Ltd.,
Regulatory Compliance Group
IT R&D Center
416 Maetan3-Dong,
Yeongtong-gu, Suwon city,
Gyeonggi-Do, Korea 443-742

FCC CFR47 PART 22 & 24 SUBPART CERTIFICATION REPORT

Model Tested : GT-S7562
FCC ID (Requested) : A3LGTS7562
Report No : FJ-219-R1
Job No : FJ-219
Date issued : Oct 4, 2012

- Abstract -

All measurement reported herein accordance with FCC Rules, 47CFR Part2,
Part22, Part24.

Prepared By

HK LEE – Test Engineer

Authorized By

WT JANG – Technical Manager



TABLE OF CONTENT

MEASUREMENT REPORT	Page
1. FCC CERTIFICATION INFORMATION	3
1.1. §2.1033 General Information	3
2. INTRODUCTION	4
2.1. General	4
3. MEASURING INSTRUMENT CALIBRATION	5
4. TEST EQUIPMENT LIST	6
5. DESCRIPTION OF TESTS	7
5.1. Effective Radiated Power / Equivalent Isotropic Radiated Power	7
5.2. Radiated Spurious & Harmonic Emission	8
5.3. Peak-Average Ratio	9
5.4. Occupied Bandwidth	10
5.5. Spurious and Harmonic Emission at Antenna Terminal	10
5.5.1. Occupied Bandwidth Emission Limits	10
5.5.2. Conducted Spurious Emission	12
5.6. Frequency Stability / Temperature Variation	13
6. TEST DATA	14
6.1. Effective Radiated Power (E.R.P.)	14
6.2. Equivalent Isotropic Radiated Power (E.I.R.P.)	15
6.3. GSM850 Radiated Spurious & Harmonic measurement	16
6.4. GSM1900 Radiated Spurious & Harmonic measurement	17
6.5. Frequency Stability	18
6.5.1. GSM850 Frequency Stability Table	18
6.5.2. GSM850 Frequency Stability Graph	19
6.5.3. GSM1900 Frequency Stability Table	21
6.5.4. GSM1900 Frequency Stability Graph	22
7. CONCLUSION	24
8. TEST PLOTS	25



MEASUREMENT REPORT

1. FCC Certification Information

The following information is in accordance with FCC Rules, 47CFR Part2, Subpart J, Sections 2.1033 – 2.1055.

1.1. §2.1033 General Information

- Applicant Name : SAMSUNG ELECTRONICS CO., LTD.
- Address : 416 Maetan3-Dong, Yeongtong-gu, Suwon City
Gyeonggi-Do, Korea 443-742
- FCC ID : A3LGTS7562
- Model : GT-S7562
- Quantity : Quantity production is planned
- Emission Designators : 247KGXW(GSM850)
249KGXW(GSM1900)
- Tx Freq. Range : 824.2 - 848.8MHz (GSM850)
1850.2MHz - 1909.8MHz (GSM1900)
- Rx Freq. Range : 869.2 - 893.8 MHz (GSM850)
1930.2MHz - 1989.8MHz (GSM1900)
- Max. Power Rating : 0.217 W ERP GSM850 (23.36 dBm)
1.045 W EIRP GSM1900 (30.19 dBm)
- FCC Classification(s) : PCS Licensed Portable Tx Held to Ear (PCE)
- Equipment (EUT) Type : Portable Handset
- Device Capabilities : 850/1900 GSM/GPRS Phone with Bluetooth, EDGE Rx
only and WLAN
- Frequency Tolerance : $\pm 0.00025\%$ (2.5ppm)
- FCC Rule Part(s) : §24(E), §22(H), §2.
- Dates of Test : August 8-9, 2012
- Place of Test : SAMSUNG Lab,
- Test Report S/N : FJ-219-R1

2. INTRODUCTION

2.1. General

These measurement test were conducted at **SAMSUNG ELECTRONICS CO., LTD(SUWON)**. The site address is 416 Maetan3-Dong, Yeongtong-gu, Suwon City, Gyeonggi-Do, Korea 443-742 The site have 1 Fully-anechoic chamber and measurement facility.

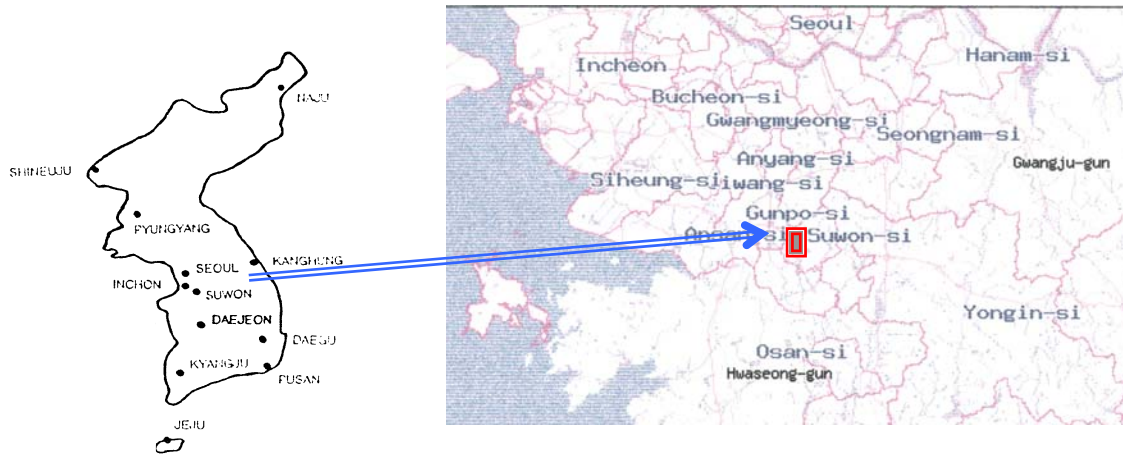

Figure1. Map of the Suwon City area.

Measurement Procedure

The radiated and spurious measurements were made Fully-anechoic chamber at a 3-meter test range (see Figure2). The equipment under testing was placed on the rotating device at the same height and at a distance of 3-meters from the receive antenna. The rotating device which can rotate horizontal axis was mounted on the turn unit to facilitate rotation around a vertical axis. The measurement was made for each horizontal/vertical position combination with receive antenna horizontally polarized. This measurement was repeated with receive antenna vertically polarized. The substitution antenna will replace the EUT antenna it the same position and in vertical polarization. The frequency of the signal generator shall be set to the frequencies that were measured on the EUT. The signal generator, output level, shall be adjusted until an equal or a known related level to what was measured from the EUT is obtained in the spectrum analyzer. This level was recorded. For readings above 1 GHz, the above procedure is repeated using horn antennas and the difference between the gain of the horn and an isotropic antenna are taken into consideration.



Figure2. Photograph of 3m Fully-Anechoic Chamber



3. MEASURING INSTRUMENT CALIBRATION

The measuring equipment, which was utilized in performing the tests documented herein, has been calibrated in accordance with the manufacturer's recommendations for utilizing calibration equipment, which is traceable to recognized national standards.



4. TEST EQUIPMENT LIST

Name Of Equipment	Model	Serial No.	Cal. Date	Due Date
Spectrum Analyzer	ESI26	836119/010	2011-10-25	2012-10-25
	E4440A(3Hz~26.5GHz)	MY46187454	2012-03-14	2013-03-14
	E4440A(3Hz~26.5GHz)	MY41000236	2012-04-26	2013-04-26
Signal Generator	SMR20	835197/030	2011-12-01	2012-12-01
Network Analyzer	8753E	JP38160590	2012-06-19	2013-06-19
Pre-Amplifier	8449B	3008A00691	2011-12-09	2012-12-09
Communication test set	E5515C	MY47510060	2012-03-05	2013-03-05
	E5515C	GB42360886	2012-08-20	2013-08-20
Controller	CO2000	CO2000/424	Not Required	Not Required
Turn Unit	CT0800	CT0800/057	Not Required	Not Required
Rotating Device	DE3600-RH-PR	DE3600-RH-PR/050	Not Required	Not Required
Antenna Master	MA4000	MA4000/204	Not Required	Not Required
Horn Antenna	HF906	100134	2012-08-13	2014-08-13
	BBHA9120	9120D-637	2011-09-14	2013-09-14
Dipole Antenna	UHA 9105	9105-2412	2011-09-09	2013-09-09
	UHA 9105	9105-2413	2012-07-20	2014-07-20
Receive Antenna	HL040	353255/019	2011-09-05	2013-09-05
Power Supply	E3640A	MY40003594	2012-06-19	2013-06-19
	E3640A	MY40003595	2012-05-16	2013-05-16
	E3632A	MY40022438	2012-03-02	2013-03-02
Divider	11636B	58456	2012-04-03	2013-04-03
	11636B	51942	2012-07-11	2013-07-11
	11636B	58459	2012-04-03	2013-04-03
	11636B	56918	2012-09-24	2013-09-24
High Pass Filter	WHK/3.0/18G-10SS	492	2012-04-09	2013-04-09
	WHK/3.5/18G-10SS	4	2012-04-09	2013-04-09
Environmental Chamber	SH-241	92000548	2011-11-14	2012-11-14
	SH-241	92000549	2011-11-14	2012-11-14
Shielded Fully Anechoic Chamber	CHAMBER	ANT0001	Not Required	Not Required

5. DESCRIPTION OF TESTS

5.1. Effective Radiated Power / Equivalent Isotropic Radiated Power

Test Set-up for the ERP/EIRP TEST

Effective Radiated Power Output and Equivalent Isotropic Radiated Power output Measurements by Substitution Method according to ANSI/TIA/EIA-603-C-2004

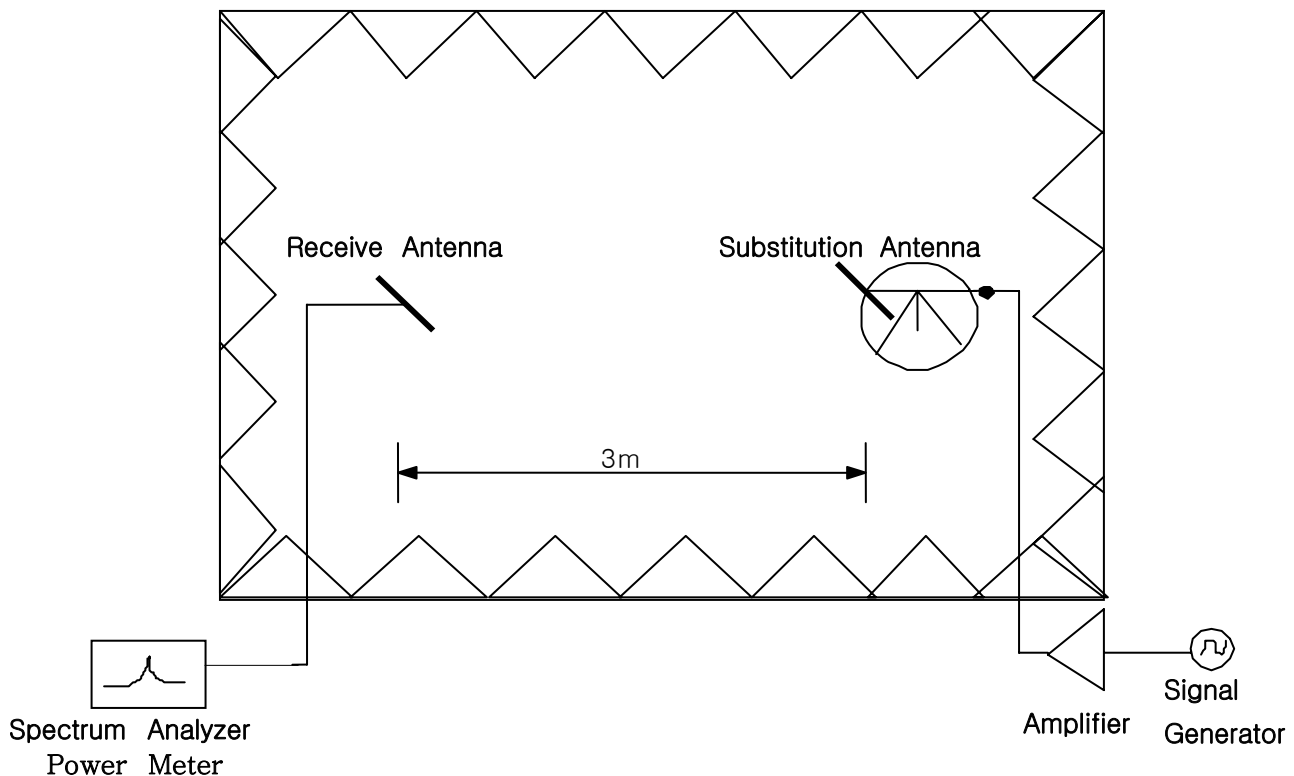

Figure 3. Diagram of ERP/EIRP test Set-up

The EUT was placed on the rotating device at 3-meters from the receive antenna and tested in 3 orthogonal planes. The turn unit and rotating device was adjusted for the highest reading on the receive spectrum analyzer. For GSM signals, an average detector is used, with RBW=VBW=3MHz, SPAN=10MHz. A half-wave dipole and Horn antenna was substituted in place of the EUT. This dipole antenna was driven by a signal generator and the level of the signal generator was adjusted to obtain the same receive spectrum analyzer reading. The conducted power at the terminals of dipole is measured. The ERP and EIRP are recorded. For readings above 1GHz, the above procedure is repeated using horn antennas and the difference between the gain of the horn and an isotropic or dipole antenna are taken into consideration.

5.2. Radiated Spurious & Harmonic Emission

Test Set-up for the Radiated Emission TEST

Radiated Spurious Emission Measurements by Substitution Method according to ANSI/TIA/EIA-603-C-2004

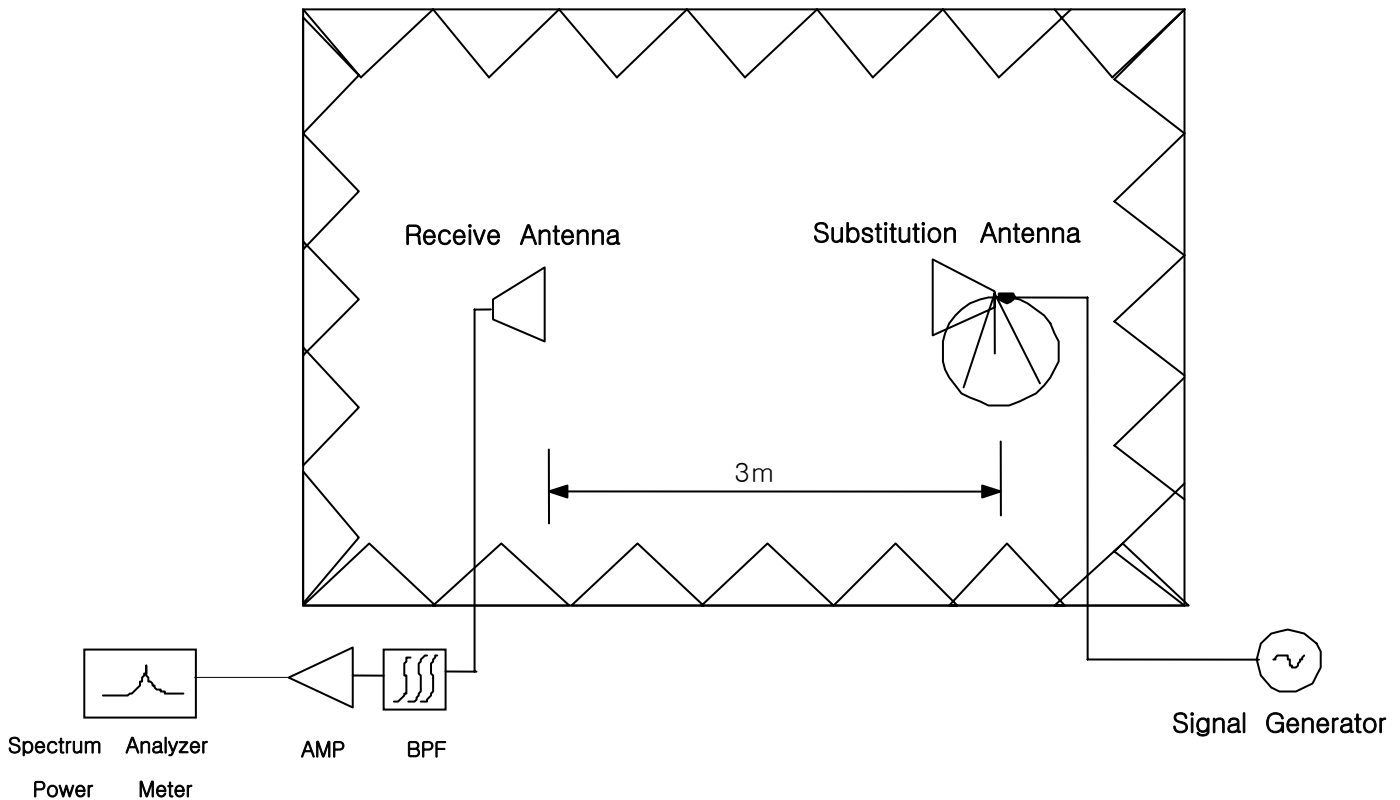

Figure 4. Diagram of Radiated Spurious & Harmonic test Set-up

The EUT was placed on the rotating device at 3-meters from the receive antenna and tested in 3 orthogonal planes. The turn unit and rotating device was adjusted for the highest reading on the receive spectrum analyzer. The Spectrum was investigated from 30MHz to the 10th Harmonic of the fundamental. A peak detector is used, with RBW=VBW=1MHz. The value that we could measure was only reported. A half-wave dipole was substituted in place of the EUT. This dipole antenna was driven by a signal generator and the level of the signal generator was adjusted to obtain the same receive spectrum analyzer reading. This spurious level is recorded. For readings above 1GHz, the above procedure is repeated using horn antennas and the difference between the gain of the horn and an isotropic or dipole antenna are taken into consideration.

SAMPLE CALCULATION

Example: Channel 661 , Second Harmonic(3760.00MHz)

The receive analyzer reading at 3meters with the EUT on the turntable was -81.0dBm . The gain of the substituted antenna is 8.1dBi . The signal generator connected to the substituted antenna terminals is adjusted to produce a reading of -81.0dBm of the receive analyzer. The loss of the cable between the signal generator and the terminals of the substituted antenna is 2.0dB at 3760.00MHz . So 6.1dB is added to the signal generator reading of -30.9dBm yielding -24.8dBm . The fundamental EIRP was 25.5dBm so this harmonic was $25.5\text{dBm} - (-24.8) = 50.3\text{dBc}$.

5.3. Peak-Average Ratio

A peak to average ratio measurement is performed at the conducted port of the EUT. An average and a peak trace are used on a spectrum analyzer to determine the largest deviation between the average and the peak power of the EUT in a given bandwidth.

※ RF Conduction Test set-up

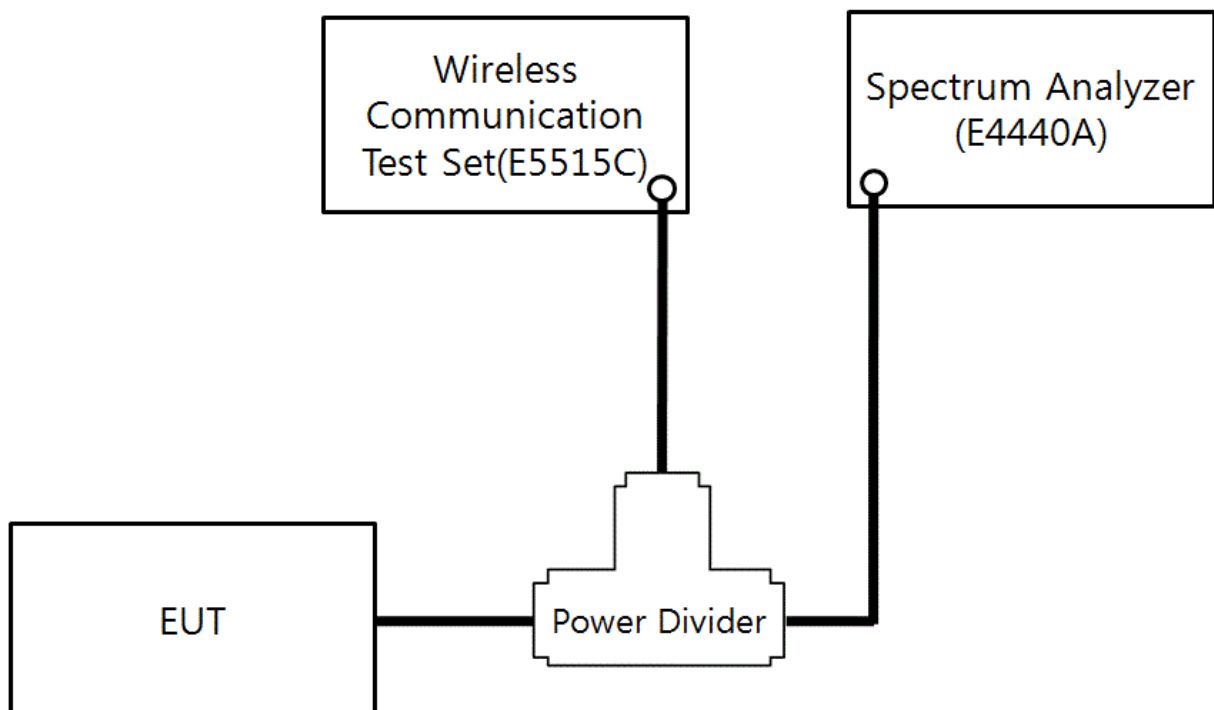

5.4.Occupied Bandwidth

Test Procedure

The occupied bandwidth, that is the frequency bandwidth such that, below its lower and above its upper frequency limits, the mean powers radiated are each equal to 0.5 percent of the total mean power radiated by a given emission shall be measured. The span of the analyzer shall be set to capture all products of the modulation process, including the emission skirts. The resolution and video bandwidth shall be set to as close to 1 percent of the selected span as is possible without being below 1 percent. Video averaging is not permitted. The trace data points are recovered and are directly summed in linear terms. The recovered amplitude data points, beginning at the lowest frequency, are placed in a running sum until 0.5 percent of the total is reached and that frequency recorded. The process is repeated for the highest frequency data points. This frequency is recorded, The span between the two recorded frequencies is the occupied bandwidth. These measurements were performed on Agilent E4440A Spectrum Analyzer, and use analyzer's bandwidth measurement function.

5.5. Spurious and Harmonic Emission at Antenna Terminal

5.5.1. Occupied Bandwidth Emission Limits

Part 24

- (a) On any frequency outside a licensee's frequency block, the power of any emission shall be attenuated below the transmitter power (P) by at least $43 + 10 \log(P)$ dB.
- (b) Compliance with these provisions is based on the use of measurement instrumentation employing a resolution bandwidth of 1 MHz or greater. However, in the 1MHz bands immediately outside and adjacent to the frequency block a resolution bandwidth of at least one percent of the emission bandwidth of the fundamental emission of the transmitter may be employed. The emission bandwidth is defined as the width of the signal between two points, one below the carrier center frequency and one above the carrier center frequency, outside of which all emission are attenuated at least 26 dB below the transmitter power.
- (c) When measuring the emission limits, the nominal carrier frequency shall be adjusted as close to the licensee's frequency block edges, both upper and lower, as the design permits.

Part 22

- (a) Out of band emissions. The power of any emission outside of the authorized operating frequency ranges must be attenuated below the transmitting power (P) by a factor of at least $43 + 10 \log(P)$ dB.
- (b) Measurement procedure. Compliance with these rules is based on the use of measurement instrumentation employing a resolution bandwidth of 100 kHz or greater. In the 1 MHz bands immediately outside and adjacent to the frequency block a resolution bandwidth of at least one percent of the emission bandwidth of the fundamental emission of the transmitter may be employed. A narrower resolution bandwidth is permitted in all cases to improve measurement accuracy provided the measured power is integrated over the full required measurement bandwidth (i.e. 100 kHz or 1 percent of emission bandwidth, as specified). The emission bandwidth is defined as the width of the signal between two points, one below the carrier center frequency and one above the carrier center frequency, outside of which all emissions are attenuated at least 26 dB below the transmitter power.

BLOCK	Freq. Range (MHz) Transmitter (Tx)	Freq. Range (MHz) Receiver (Rx)
A	1850 – 1865	1930 – 1945
B	1870 – 1885	1950 – 1965
C	1895 – 1910	1975 – 1990
D	1865 – 1870	1945 – 1950
E	1885 – 1890	1965 – 1970
F	1890 – 1895	1970 – 1975

Table 1. Broadband PCS Service Frequency Blocks

BLOCK	Freq. Range (MHz) Transmitter (Tx)	Freq. Range (MHz) Receiver (Rx)
A* Low + A	824 ~ 835	869 ~ 880
B	835 ~ 845	880 ~ 890
A* High	845 ~ 846.5	890 ~ 891.5
B*	846.5 ~ 849	891.5 ~ 894

Table 2. Cellular Service Frequency Blocks

5.5.2. Conducted Spurious Emission

Minimum standard:

On any frequency outside a license frequency block, the power of any emission shall be attenuated below the transmitter power(P) by at least $43+10\log(P)$ dB. Limit equivalent to -13dBm, calculation shown below.

$$43 + 10\log (0.217 \text{ W}) = 36.36 \text{ dB}$$

$$23.36 \text{ dBm} - 36.36 \text{ dB} = -13 \text{ dBm}$$

Compliance with the out-of-band emissions requirement is based on test being performed with an analyzer resolution bandwidth of 1MHz. However in the 1MHz band immediately outside and adjacent to the frequency block a resolution bandwidth of at least 1% of the fundamental emissions bandwidth may be employed.

Example)

In case of GSM : $0.01 * 273\text{KHz} = 2.73\text{KHz}$

A Resolution BW of 3KHz was used for measurement at the band edges.

Test Procedure:

The EUT was setup to maximum output power at its lowest channel. The Resolution BW of the analyzer is set to 1% of the emission bandwidth to show compliance with the -13dBm limit, in the 1MHz bands immediately outside and adjacent to the edge of the frequency block. The measurements are repeated for the EUT's highest channel. For the Out-of-Band measurements a 1MHz RBW was used to scan from 10MHz to 10GHz. (GSM1900 Mode : 10MHz to 20GHz). A display line was placed at -13dBm to show compliance. The high, lowest and a middle channel were tested for out of band measurements.

Plots are shown herein.

5.6. Frequency Stability / Temperature Variation

The frequency stability of the transmitter is measured by:

- a.) Temperature: The temperature is carried from -30°C to $+50^{\circ}\text{C}$ using an environmental chamber.
- b.) Primary Supply Voltage: The primary supply voltage is varied from 85% to 115% of the voltage normally at the input to the device or at the power supply terminals if cables are not normally supplied.

Specification- The frequency stability shall be sufficient to ensure that the fundamental emission stays within the authorized frequency block. The frequency stability of the transmitter shall be maintained within ± 0.00025 ($\pm 2.5\text{ppm}$) of the center frequency.

Time Period and Procedure:

1. The carrier frequency of the transmitter and the individual oscillators is measured at room temperature (25°C to 27°C to provide a reference).
2. The equipment is subjected to an overnight "soak" at -30°C without any power applied.
3. After the overnight "soak" at -30°C (Usually 14~16 hours), the equipment is turned on in a "standby" condition for one minute before applying power to the transmitter. Measurement of the carrier frequency of the transmitter and the individual oscillators is made within a three minute interval after applying to the transmitter.
4. Frequency measurements are made at 10°C interval up to room temperature. At least a period of one and one half-hour is provided to allow stabilization of the equipment at each temperature level.
5. Again the transmitter carrier frequency and the individual oscillators is measured at room temperature to begin measurement of the upper temperature levels.
6. Frequency measurements are at 10 intervals starting at -30°C up to $+50^{\circ}\text{C}$ allowing at least two hours at each temperature for stabilization. In all measurements the frequency is measured within three minutes after re-applying power to the transmitter.
7. The artificial load is mounted external to the temperature chamber.

NOTE : The EUT is tested down to the battery endpoint.

6. TEST DATA

6.1. Effective Radiated Power (E.R.P.)

Supply Voltage : 3.7VDC

Modulation : GSM850

■ Result

Frequency (MHz)	Tested level [dBm]	Substitute Level [dBm]	Antenna Gain [dBd]	Polarization [H/V]	ERP [dBm]	ERP [W]	Battery
824.20	-14.92	22.33	-1.95	H	20.38	0.109	Standard
836.60	-15.18	23.66	-1.72	H	21.94	0.156	Standard
848.80	-15.35	24.94	-1.58	H	23.36	0.217	Standard

NOTE : Standard batteries are the only battery options for this phone

- All modes of operation were investigated, and the worst-case results are reported.

Radiated measurements at 3 meters by Substitution Method



6.2. Equivalent Isotropic Radiated Power (E.I.R.P.)

Supply Voltage : 3.7VDC

Modulation : PCS 1900

■ Result

Frequency (MHz)	Tested level [dBm]	Substitute Level [dBm]	Antenna Gain [dBi]	Polarization [H/V]	EIRP [dBm]	EIRP [W]	Battery
1850.20	-21.26	18.12	10.16	V	28.28	0.673	Standard
1880.00	-20.03	20.03	10.16	V	30.19	1.045	Standard
1909.80	-21.06	18.74	10.16	V	28.90	0.776	Standard

NOTE : Standard batteries are the only battery options for this phone

- All modes of operation were investigated, and the worst-case results are reported.

Radiated measurements at 3 meters by Substitution Method

6.3. GSM850 Radiated Spurious & Harmonic measurement

Operating Frequency : 824.20 MHz(Low), 836.60MHz(Middle), 848.80MHz(High)

Measured Output Power : 23.36 dBm = 0.217 W

Modulation Signal : GSM850

Limit : $43 + 10\log_{10}(P) = 36.36$ dBc

Result(dBc) = Output Power(ERP, dBm) - Spurious Emission Level(dBm)

■ Result

Channel	Frequency (MHz)	Level @ Antenna Terminals (dBm)	Substitute Antenna Gain (dBd)	Spurious Emission level (dBm)	Result (dBc)	POL (H/V)
128	1648.40	-50.99	9.40	-41.59	64.95	V
	2472.60	-56.68	10.60	-46.08	69.44	V
	3296.80	-55.71	12.00	-43.71	67.07	H
	4121.00	-	-	-	-	-
	4945.20	-	-	-	-	-
	5769.40	-	-	-	-	-
190	1673.20	-51.59	9.40	-42.19	65.55	V
	2509.80	-57.45	10.60	-46.85	70.21	V
	3346.40	-54.96	12.00	-42.96	66.32	H
	4183.00	-	-	-	-	-
	5019.60	-	-	-	-	-
	5856.20	-	-	-	-	-
251	1697.60	-51.01	9.40	-41.61	64.97	H
	2546.40	-57.29	10.60	-46.69	70.05	H
	3395.20	-54.55	12.00	-42.55	65.91	H
	4244.00	-	-	-	-	-
	5092.80	-	-	-	-	-
	5941.60	-	-	-	-	-

NOTE :

1. "-" Indicates the spurious emission could not be detected due to noise limitations or ambients.
2. The spectrum is measured from 30MHz to the 10th harmonic and All modes of operation were investigated, and the worst-case results are reported..

Radiated Spurious Emission measurements at 3 meters by Substitution Method

6.4. GSM1900 Radiated Spurious & Harmonic measurement

Operating Frequency : 1850.2 MHz(Low), 1880.00 MHz(Middle), 1909.80 MHz(High)

Measured Output Power : 30.19 dBm = 1.045 W

Modulation Signal : GSM1900

Limit : $43 + 10\log_{10}(P) = 43.19$ dBc

■ Result

Channel	Frequency (MHz)	Level @ Antenna Terminals (dBm)	Substitute Antenna Gain (dBi)	Spurious Emission level (dBm)	Result (dBc)	POL (H/V)
512	3700.40	-50.48	12.60	-37.88	68.07	V
	5550.60	-45.81	12.50	-33.31	63.50	H
	7400.80	-41.66	11.50	-30.16	60.35	V
	9251.00	-	-	-	-	-
	11101.20	-	-	-	-	-
	12951.40	-	-	-	-	-
661	3760.00	-48.47	12.60	-35.87	66.06	H
	5640.00	-47.60	12.50	-35.10	65.29	H
	7520.00	-42.18	11.50	-30.68	60.87	V
	9400.00	-	-	-	-	-
	11280.00	-	-	-	-	-
	13160.00	-	-	-	-	-
810	3819.60	-49.05	12.60	-36.45	66.64	V
	5729.40	-46.63	12.50	-34.13	64.32	H
	7639.20	-43.12	11.50	-31.62	61.81	V
	9549.00	-	-	-	-	-
	11458.80	-	-	-	-	-
	13368.60	-	-	-	-	-

NOTE :

1. "-" Indicates the spurious emission could not be detected due to noise limitations or ambients.
2. The spectrum is measured from 30MHz to the 10th harmonic and All modes of operation were investigated, and the worst-case results are reported.

Radiated Spurious Emission measurements at 3 meters by Substitution Method

6.5. Frequency Stability

6.5.1. GSM850 Frequency Stability Table

Operating Frequency : 836,600,000 Hz

Channel : 190

Reference Voltage : 3.7VDC

Deviation Limit : $\pm 0.00025\%$ or 2.5ppm

Voltage (%)	Power (VDC)	Temp. (°C)	Frequency Error (Hz)	Frequency (Hz)	Deviation (%)	ppm
100%	3.70	+20(Ref)	14.20	836,600,014	0.000002	0.017
100%		-30	-22.30	836,599,978	-0.000003	-0.027
100%		-20	13.70	836,600,014	0.000002	0.016
100%		-10	39.40	836,600,039	0.000005	0.047
100%		0	-13.70	836,599,986	-0.000002	-0.016
100%		+10	20.70	836,600,021	0.000002	0.025
100%		+20	14.20	836,600,014	0.000002	0.017
100%		+30	39.40	836,600,039	0.000005	0.047
100%		+40	26.30	836,600,026	0.000003	0.031
100%		+50	14.00	836,600,014	0.000002	0.017
115%	4.26	+20	3.50	836,600,004	0.000000	0.004
Batt.Endpoint	3.35	+20	-22.20	836,599,978	-0.000003	-0.027

Note : The temperature is varied from -30 °C to +50 °C using an environmental chamber.

The EUT is tested down to the battery end point.

6.5.2. GSM850 Frequency Stability Graph

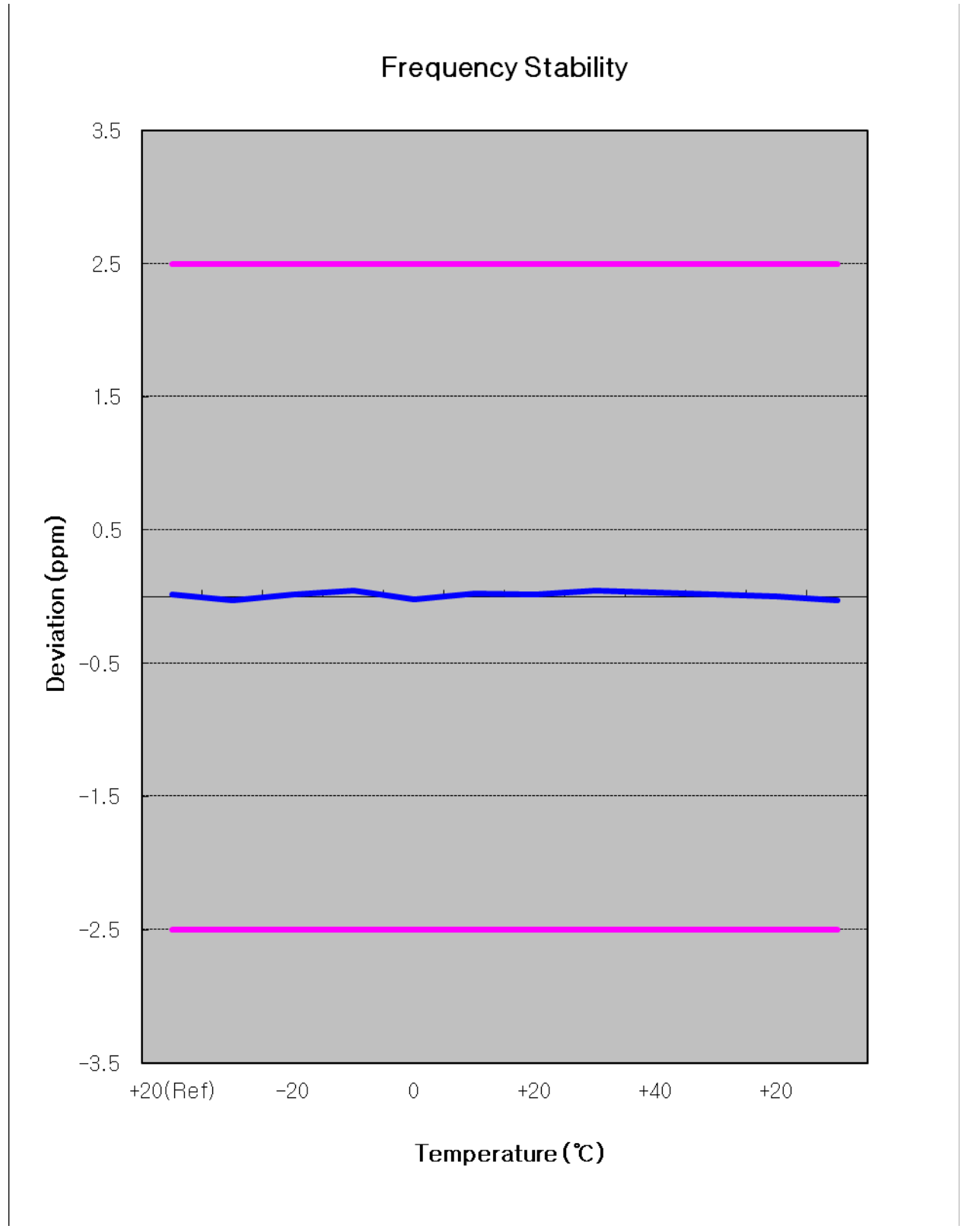

Zoom IN

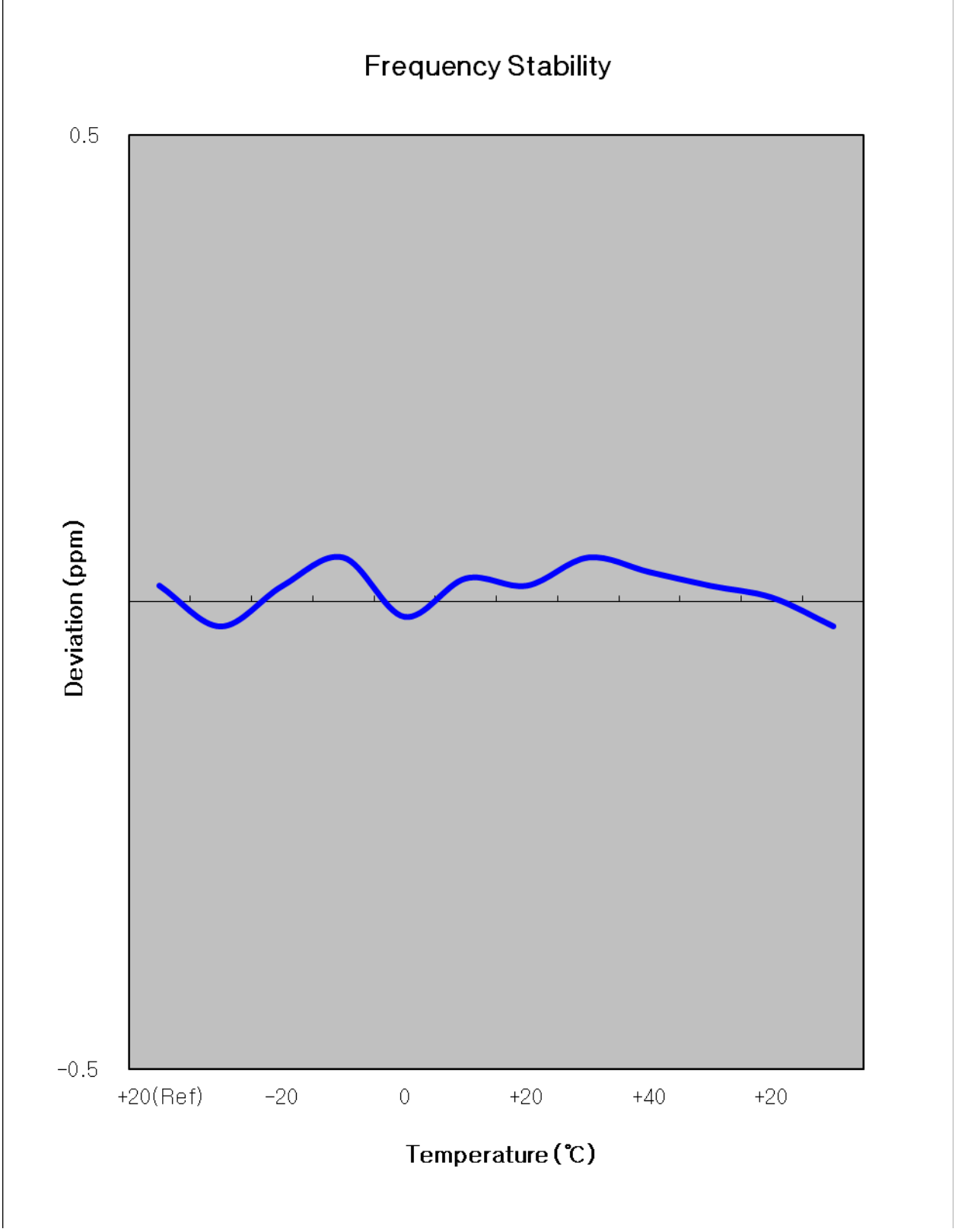

6.5.3. GSM1900 Frequency Stability Table

Operating Frequency : 1,880,000,000 Hz

Channel : 661

Reference Voltage : 3.7VDC

Deviation Limit : ± 0.00025 % or 2.5ppm

Voltage (%)	Power (VDC)	Temp. (°C)	Frequency Error (Hz)	Frequency (Hz)	Deviation (%)	ppm
100%	3.70	+20(Ref)	-48.70	1,879,999,951	-0.000003	-0.026
100%		-30	5.70	1,880,000,006	0.000000	0.003
100%		-20	-11.20	1,879,999,989	-0.000001	-0.006
100%		-10	18.40	1,880,000,018	0.000001	0.010
100%		0	-32.80	1,879,999,967	-0.000002	-0.017
100%		+10	7.00	1,880,000,007	0.000000	0.004
100%		+20	-48.70	1,879,999,951	-0.000003	-0.026
100%		+30	-41.10	1,879,999,959	-0.000002	-0.022
100%		+40	4.00	1,880,000,004	0.000000	0.002
100%		+50	-25.70	1,879,999,974	-0.000001	-0.014
115%		4.26	+20	-10.80	1,879,999,989	-0.000001
Batt.Endpoint	3.35	+20	37.30	1,880,000,037	0.000002	0.020

Note : The temperature is varied from -30 °C to +50 °C using an environmental chamber.

The EUT is tested down to the battery end point.

6.5.4. GSM1900 Frequency Stability Graph

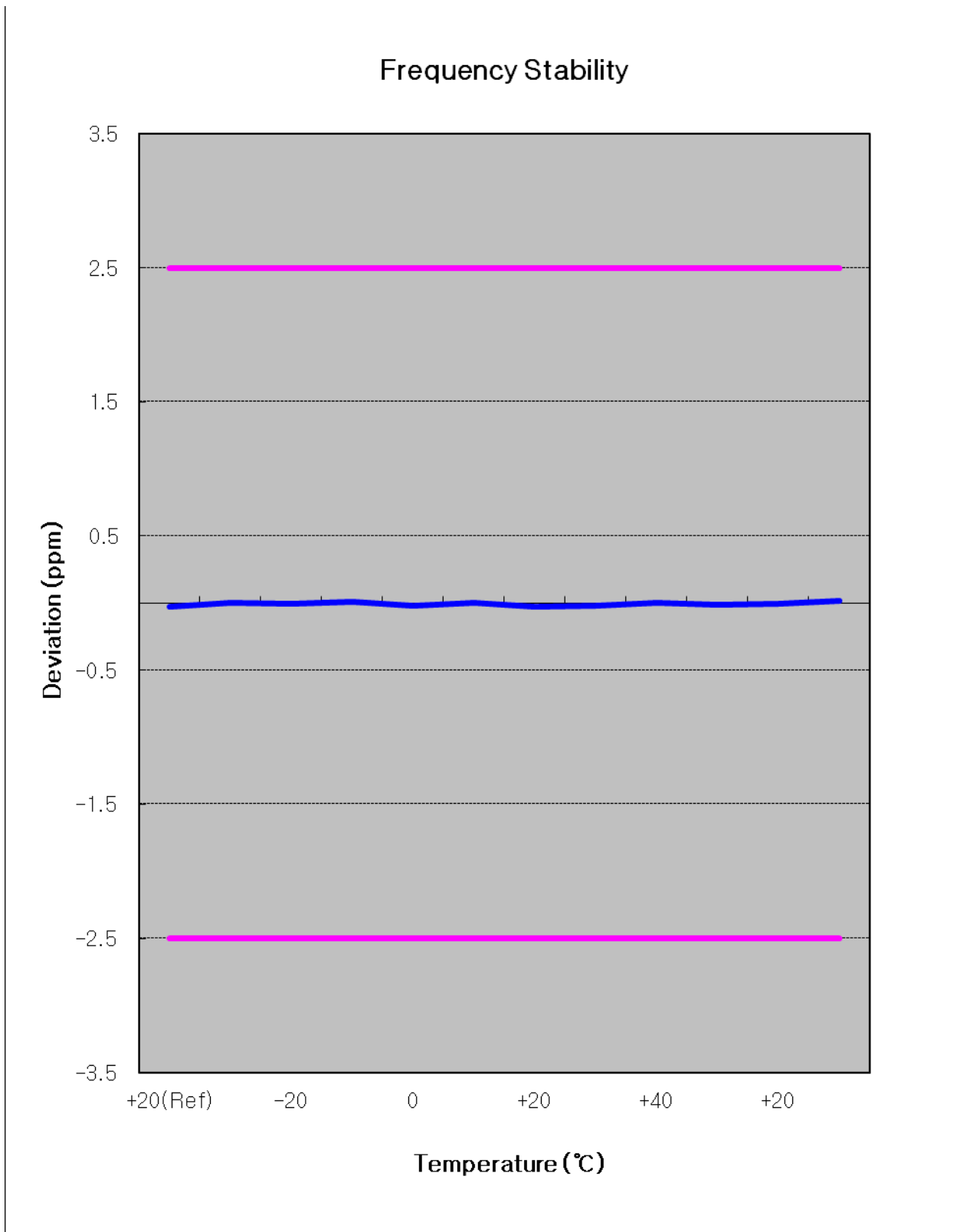

Zoom IN

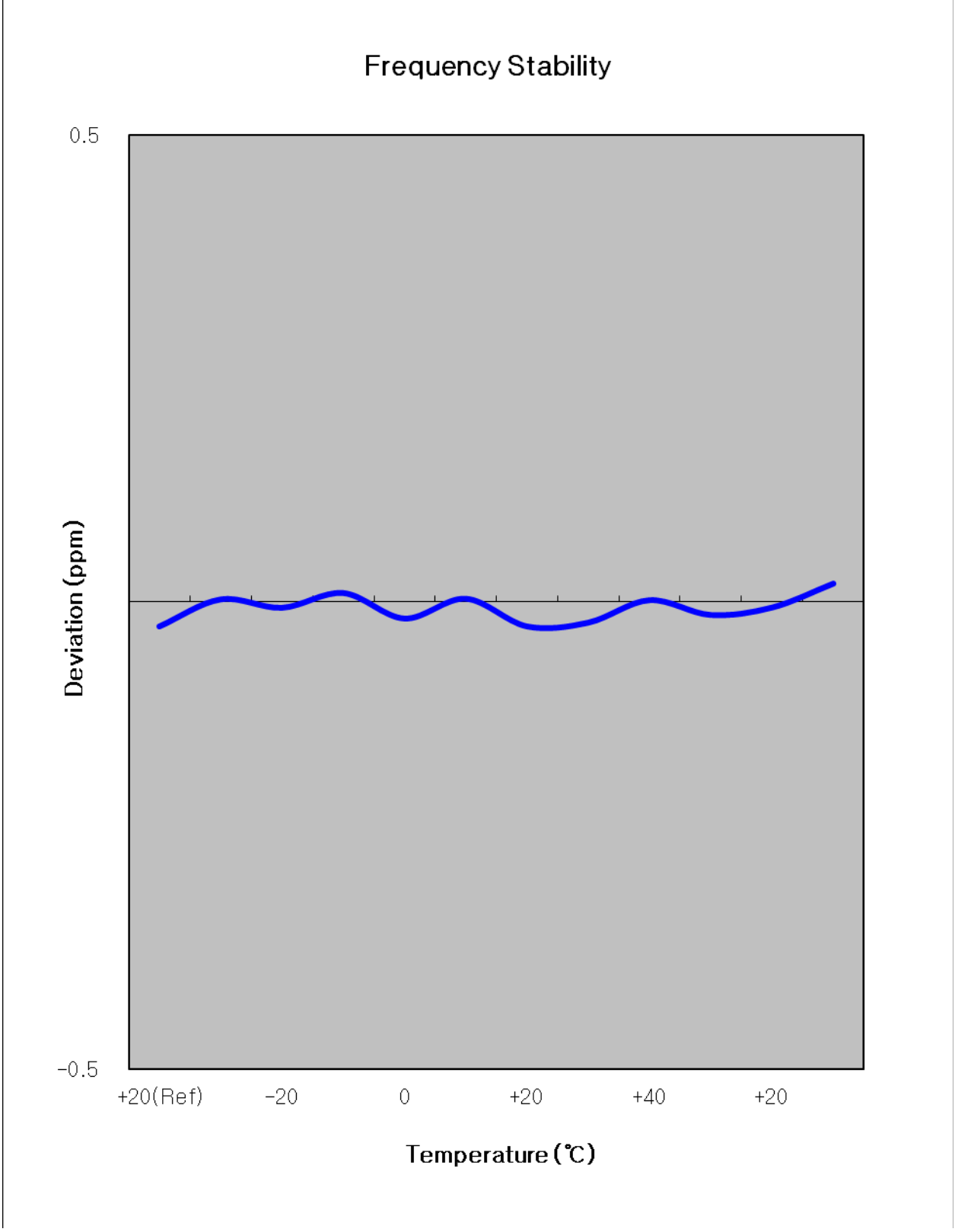



7. CONCLUSION

The data collected shows that the SAMSUNG Portable Handset
FCC ID : A3LGTS7562 complies with all the requirements of Parts 2,22,24 of the FCC Rules.

8. TEST PLOTS

※ For all frequencies, we measure Ref. offset every 1GHz. And we tested the plots with worst offset of all offset.

1. Spectrum Offset(dB) = Cable loss(dB) + Power divider(dB)
2. Ref Offset at 1880 MHz = 8.83dBm

Agilent

R T

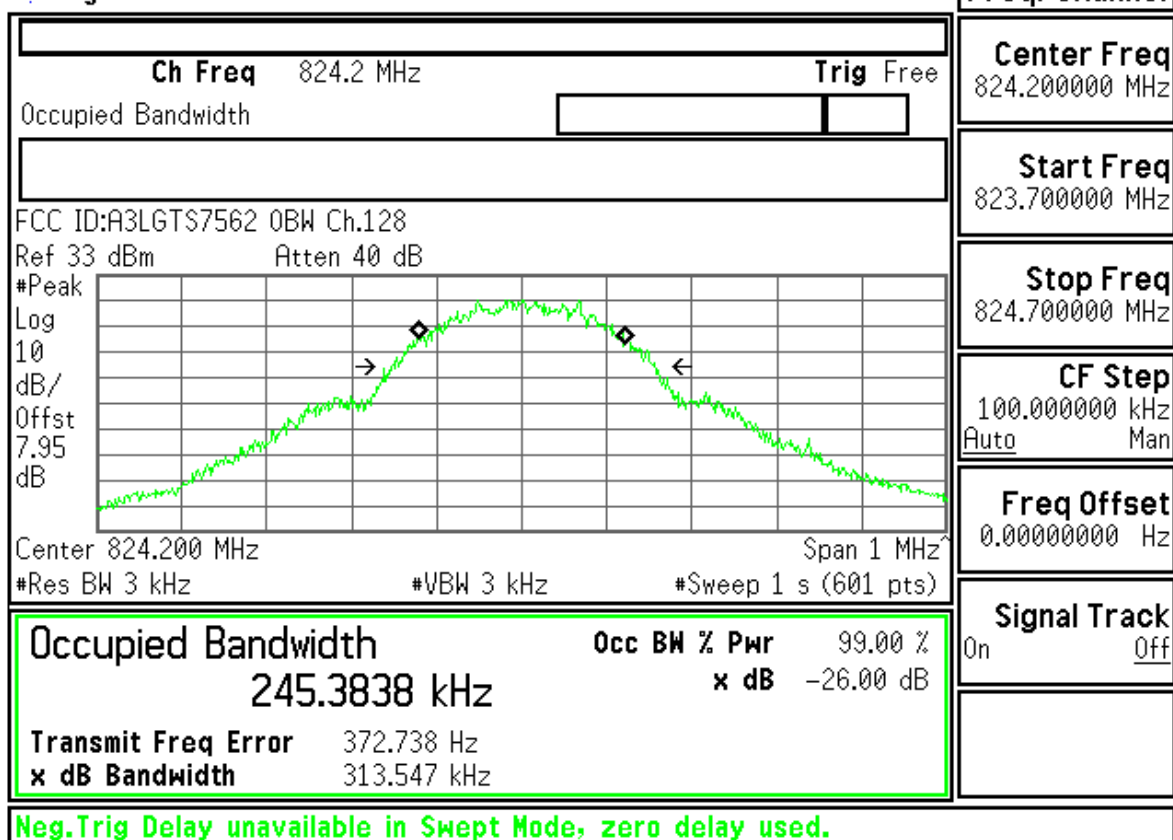

Freq/Channel
Center Freq 824.200000 MHz
Start Freq 823.700000 MHz
Stop Freq 824.700000 MHz
CF Step 100.000000 kHz Auto Man
Freq Offset 0.00000000 Hz
Signal Track On Off

Agilent

R T

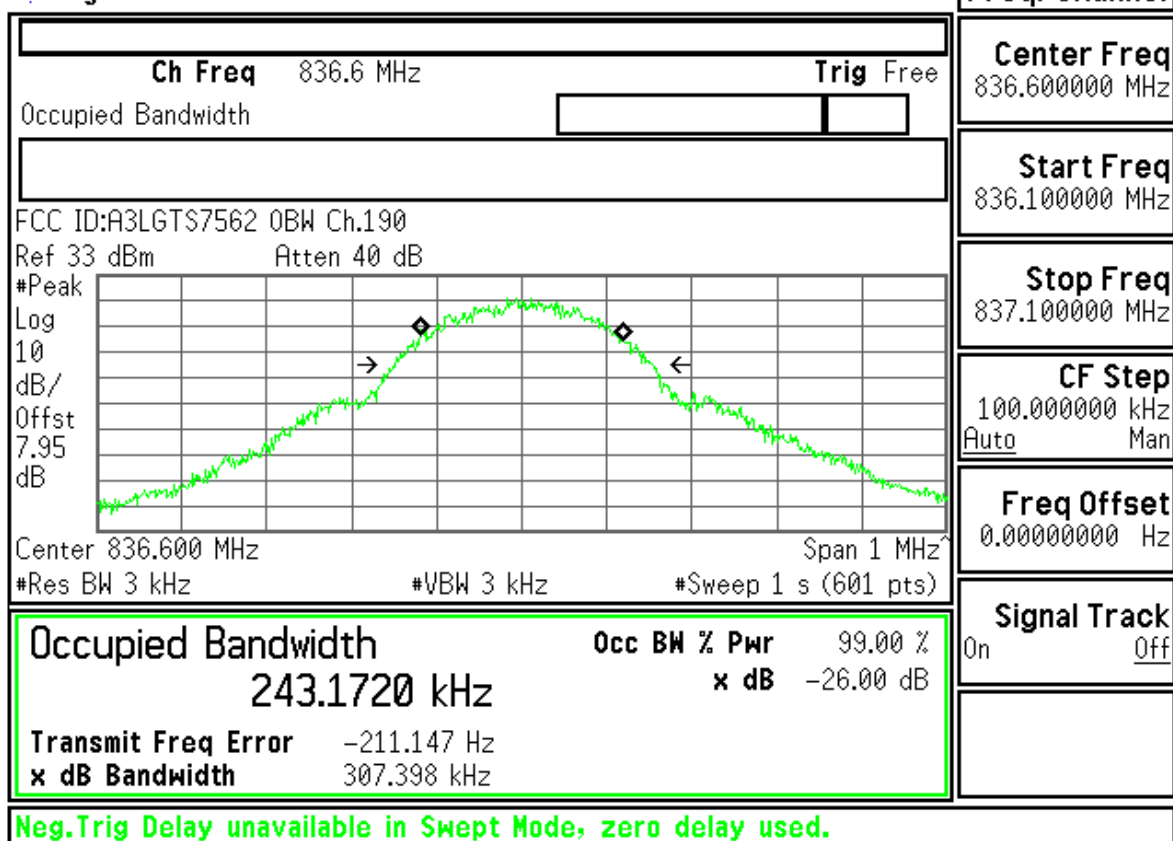

Freq/Channel
Center Freq 836.600000 MHz
Start Freq 836.100000 MHz
Stop Freq 837.100000 MHz
CF Step 100.000000 kHz Auto Man
Freq Offset 0.00000000 Hz
Signal Track On Off

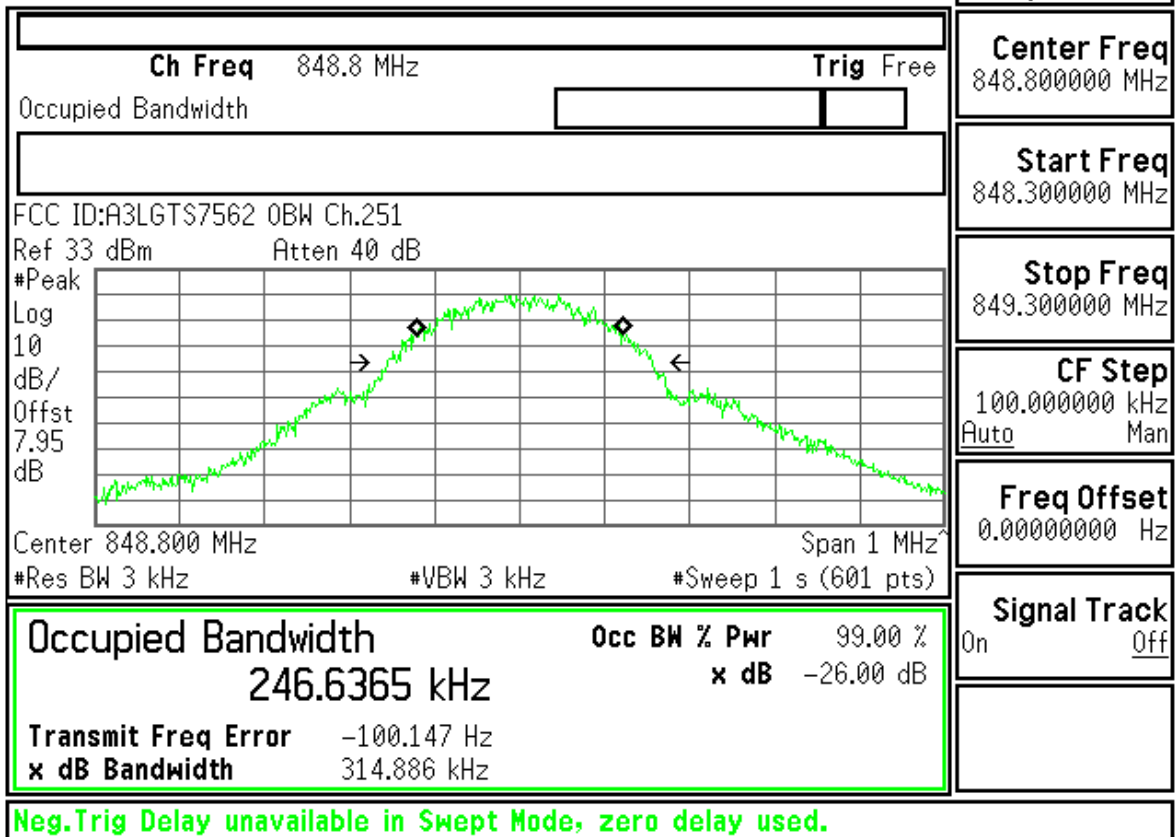

Measurement/Instrument Screen											
Control	Transmit Power							TCH Parms			
Transmit Power Setup								Downlink Traffic Power			
	BP	Avg	30.90	----	----	----	----	Traffic Band			
		SDev	0.00	----	----	----	----	GSM850			
	ECP	Avg	30.90	----	----	----	----	Traffic Channel			
		SDev	0.00	----	----	----	----	128			
	100 / 100							Single			
	Phase & Frequency Error										
			Peak Phase °		RMS Phase °		Frequency Hz		MS TX Level		
	Minimum		2.45		0.89		-23.78		5		
	Maximum		3.66		1.15		-12.09		Channel Mode Setup		
Average		2.95		1.01		-17.83		Return			
Pass/Fail		Pass		Pass		Pass					
100 / 100							Single				
Background		Active Cell Connected				Sys Type: GSM					
1 of 2				IntRef		Offset		R T		1 of 2	

Measurement/Instrument Screen											
Control	Transmit Power							TCH Parms			
Transmit Power Setup								Downlink Traffic Power			
	BP	Avg	30.84	----	----	----	----	Traffic Band			
		SDev	0.00	----	----	----	----	GSM850			
	ECP	Avg	30.84	----	----	----	----	Traffic Channel			
		SDev	0.00	----	----	----	----	190			
	100 / 100							Single			
	Phase & Frequency Error										
			Peak Phase °		RMS Phase °		Frequency Hz		MS TX Level		
	Minimum		2.04		0.81		-22.43		5		
	Maximum		3.16		1.04		-11.85		Channel Mode Setup		
Average		2.53		0.92		-16.83		Return			
Pass/Fail		Pass		Pass		Pass					
100 / 100							Single				
Background		Active Cell Connected				Sys Type: GSM					
1 of 2				IntRef		Offset		R T		1 of 2	

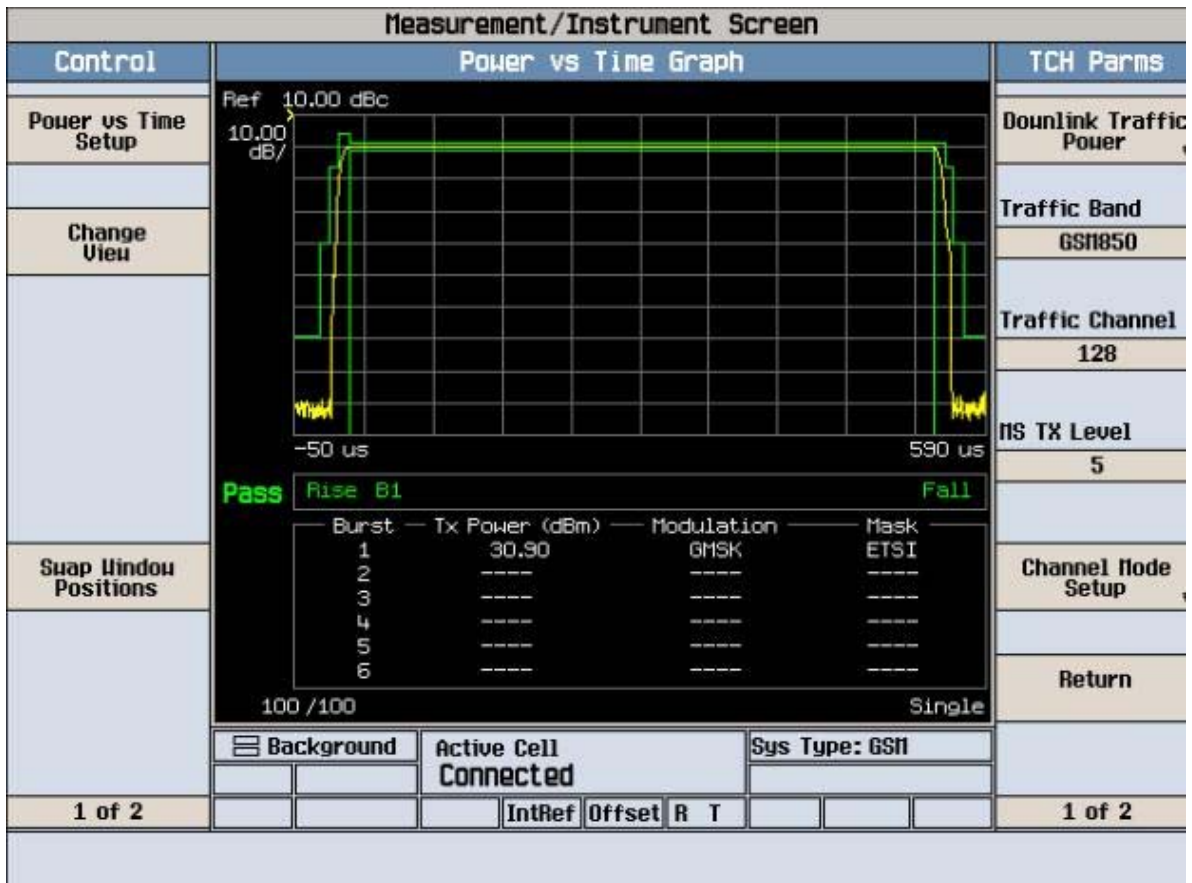
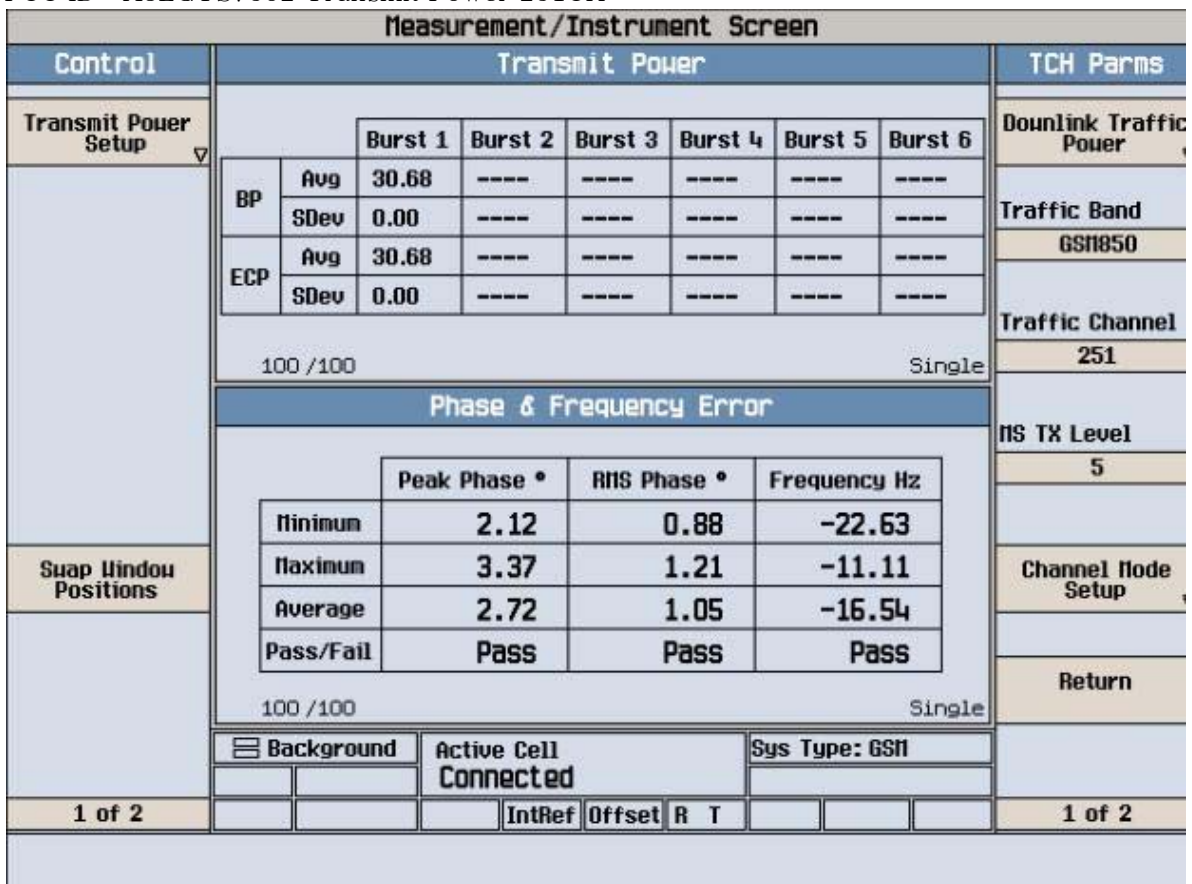

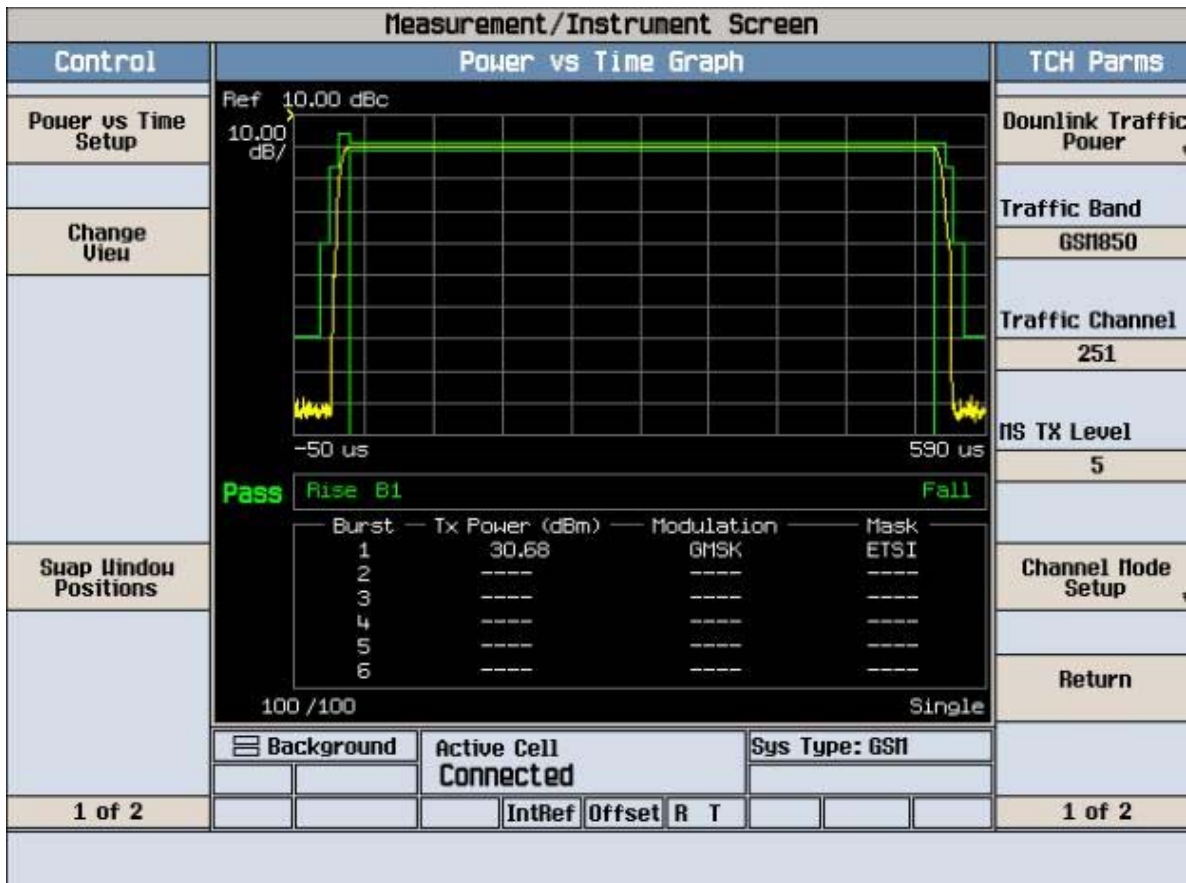
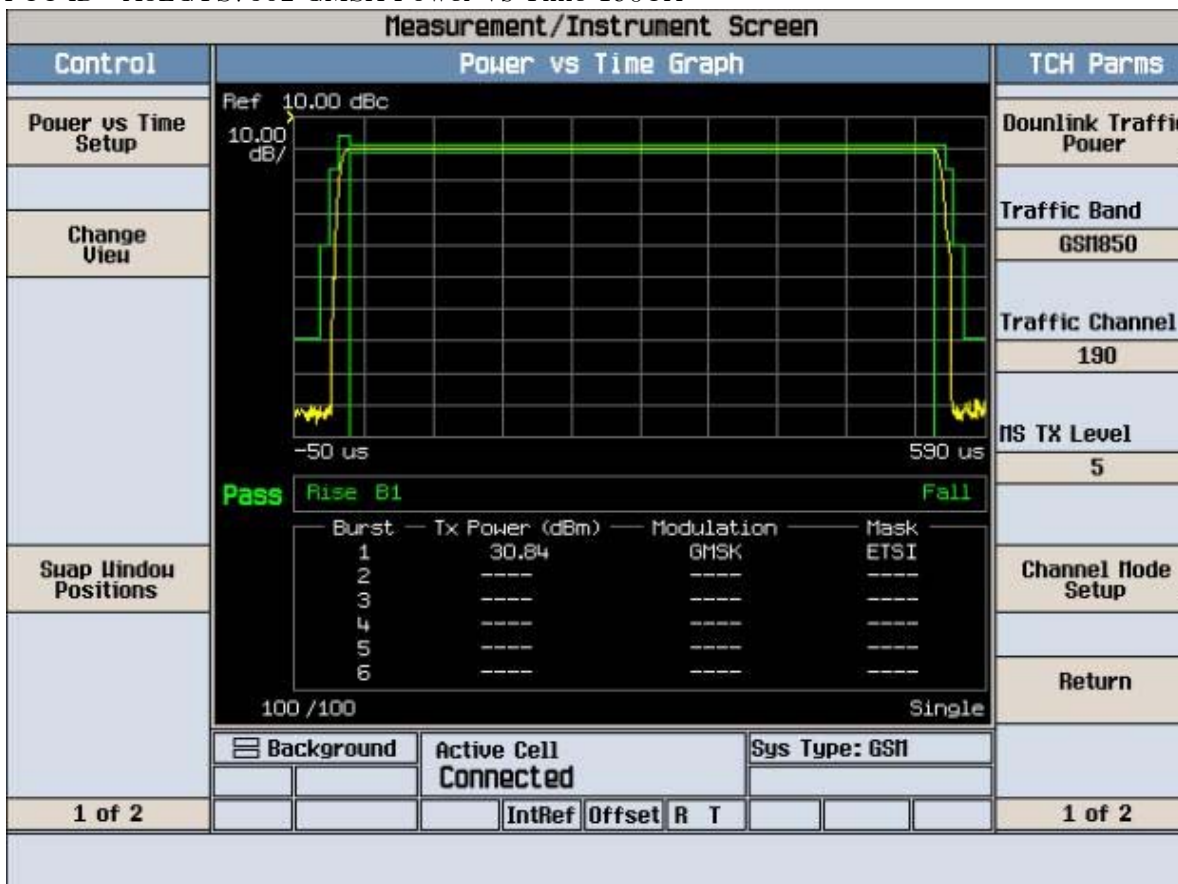

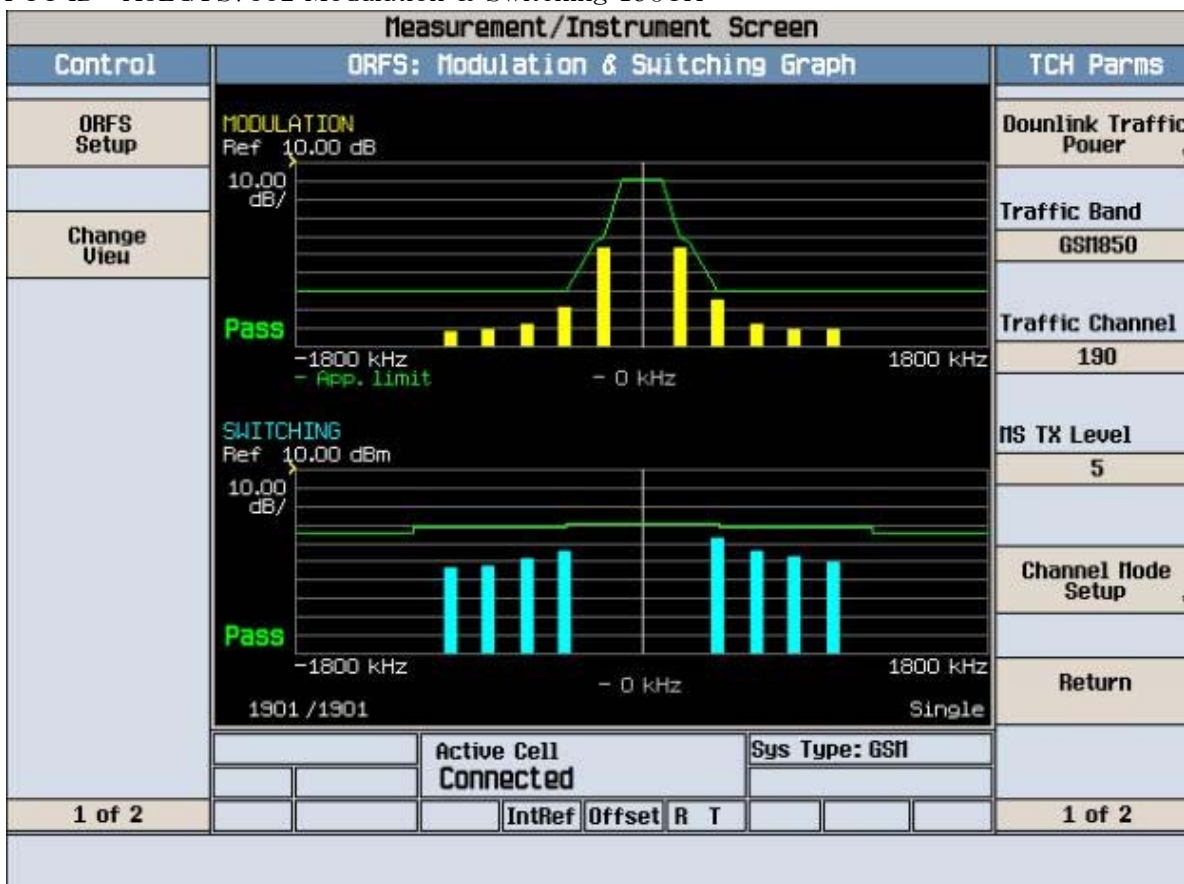
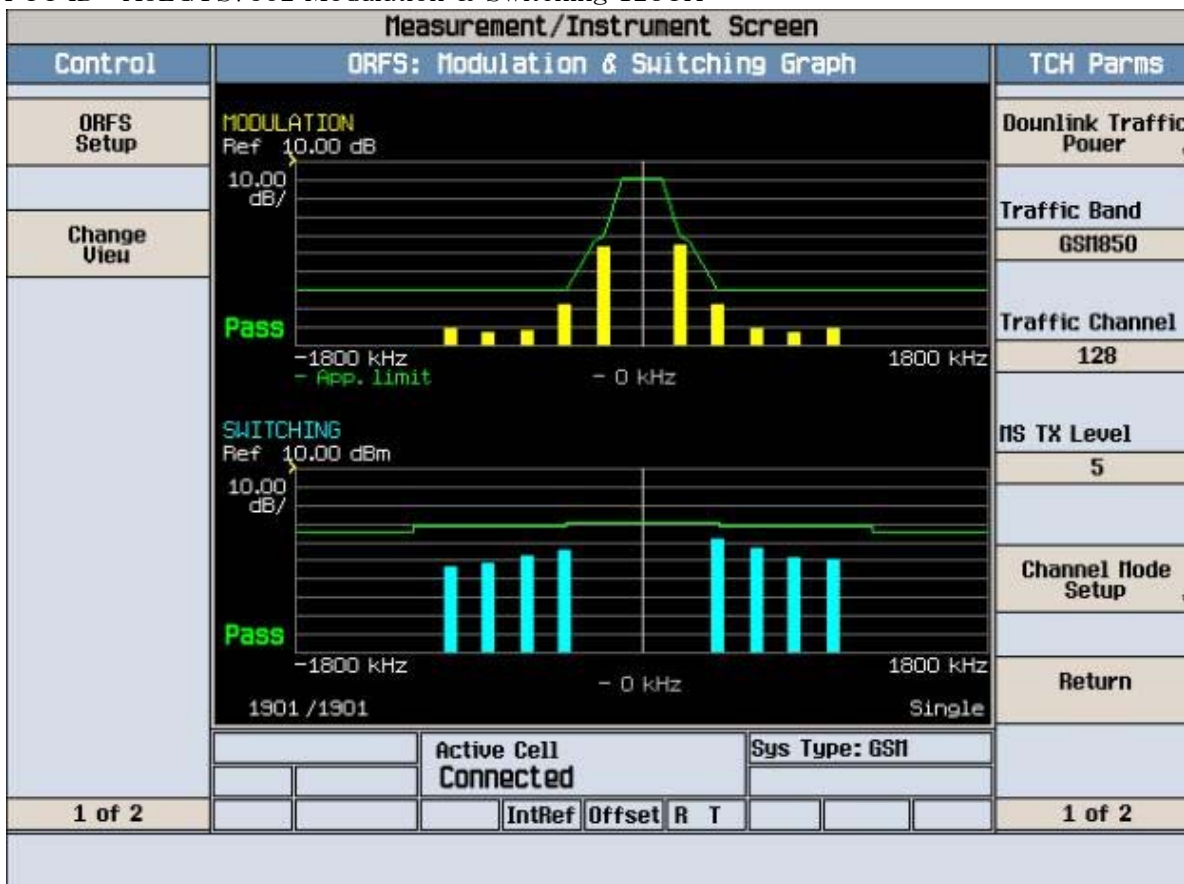

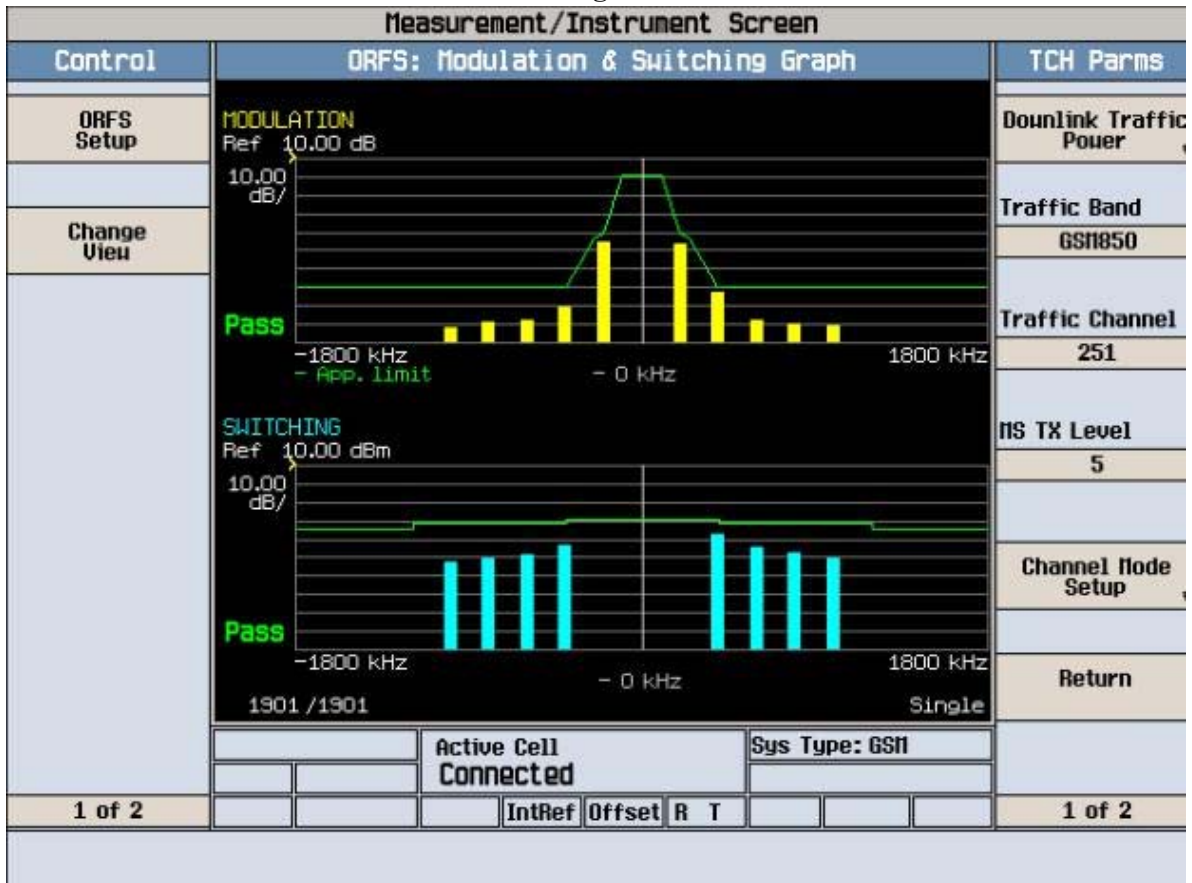

Agilent

R T

Freq/Channel

FCC ID:A3LGT\$7562 Cond Spur Ch.128

Ref 33 dBm

Atten 40 dB

#Peak

Log

10

dB/

Offst

7.95

dB

DI

-13.0

dBm

#PAvg

M1 S2

S3 FC

AA

£(f):

FTun

Swp

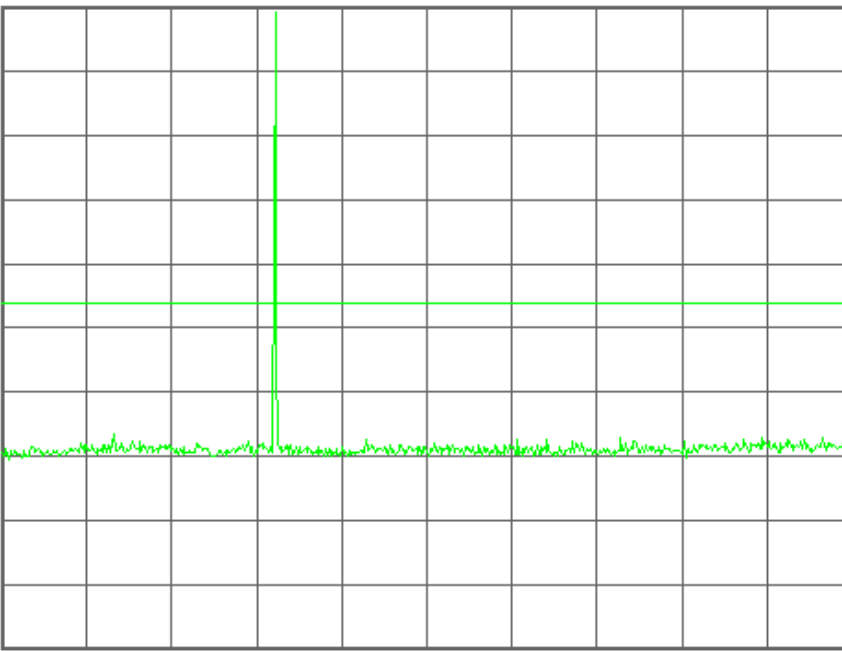

Center 1.265 GHz

Span 2.47 GHz

#Res BW 1 MHz

#VBW 1 MHz

Sweep 4.12 ms (601 pts)

Center Freq
1.26500000 GHz

Start Freq
30.0000000 MHz

Stop Freq
2.50000000 GHz

CF Step
247.000000 MHz
Auto Man

Freq Offset
0.00000000 Hz

Signal Track
On Off

File Operation Status, C:\TEMP.GIF file saved

Agilent

R T

Freq/Channel

FCC ID:A3LGT\$7562 Cond Spur Ch.128

Mkr1 819.2 MHz

Ref 33 dBm

Atten 40 dB

-29.85 dBm

#Peak

Log

10

dB/

Offst

7.95

dB

DI

-13.0

dBm

#PAvg

V1 S2

S3 FC

AA

£(f):

FTun

Swp

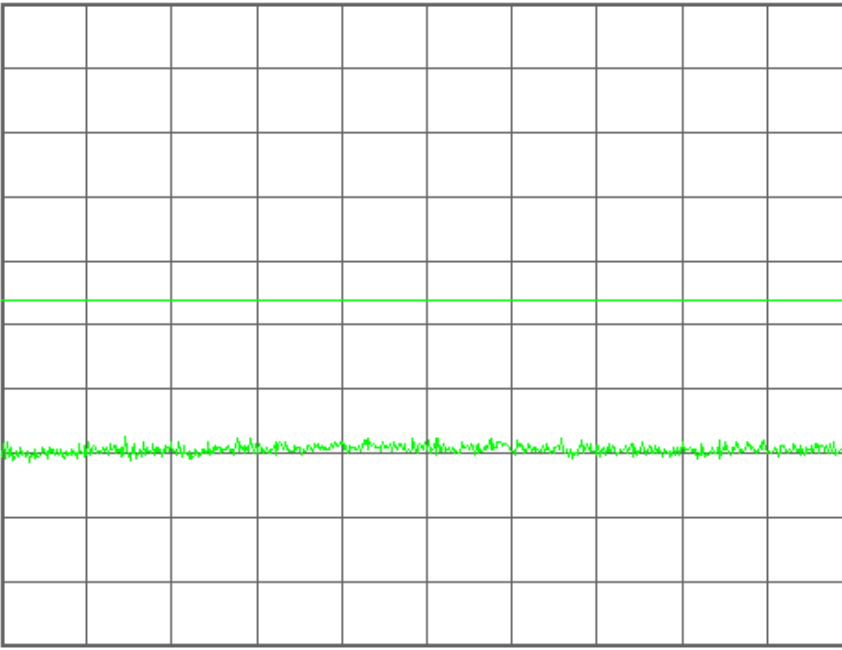

Center 424.6 MHz

Span 789.2 MHz

#Res BW 1 MHz

#VBW 1 MHz

Sweep 1.32 ms (601 pts)

Center Freq
424.600000 MHz

Start Freq
30.0000000 MHz

Stop Freq
819.200000 MHz

CF Step
78.9200000 MHz
Auto Man

Freq Offset
0.00000000 Hz

Signal Track
On Off

File Operation Status, C:\TEMP.GIF file saved

Agilent

R T

Freq/Channel

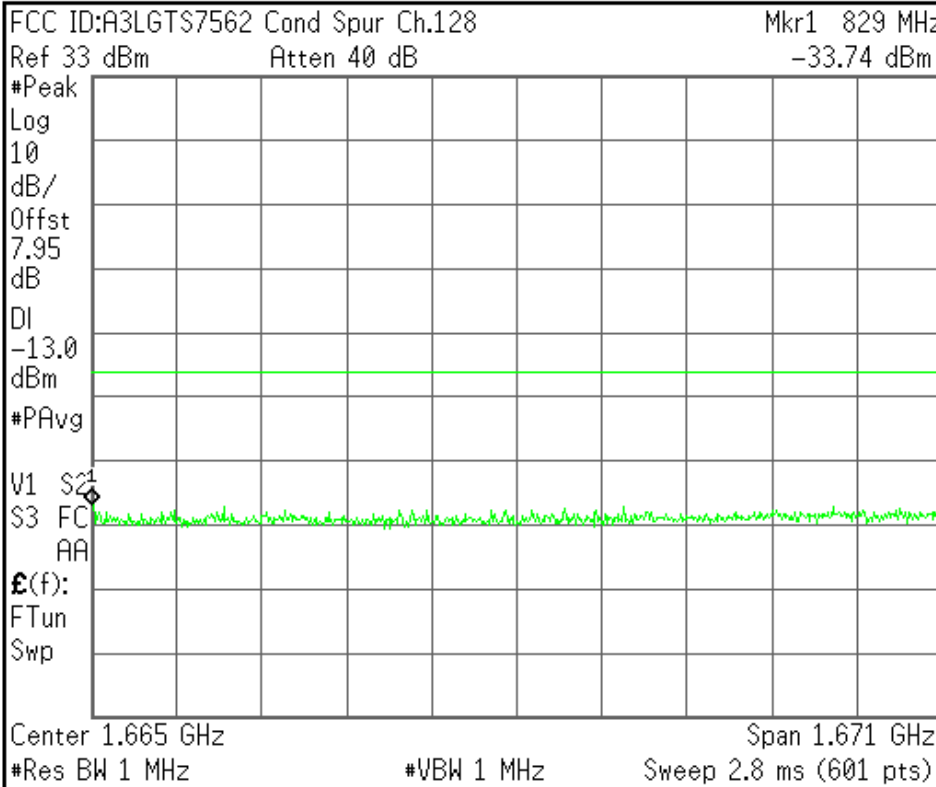

Center Freq 1.66460000 GHz
Start Freq 829.200000 MHz
Stop Freq 2.50000000 GHz
CF Step 167.080000 MHz Auto Man
Freq Offset 0.00000000 Hz
Signal Track On Off

File Operation Status, C:\TEMP.GIF file saved

Agilent

R T

Freq/Channel

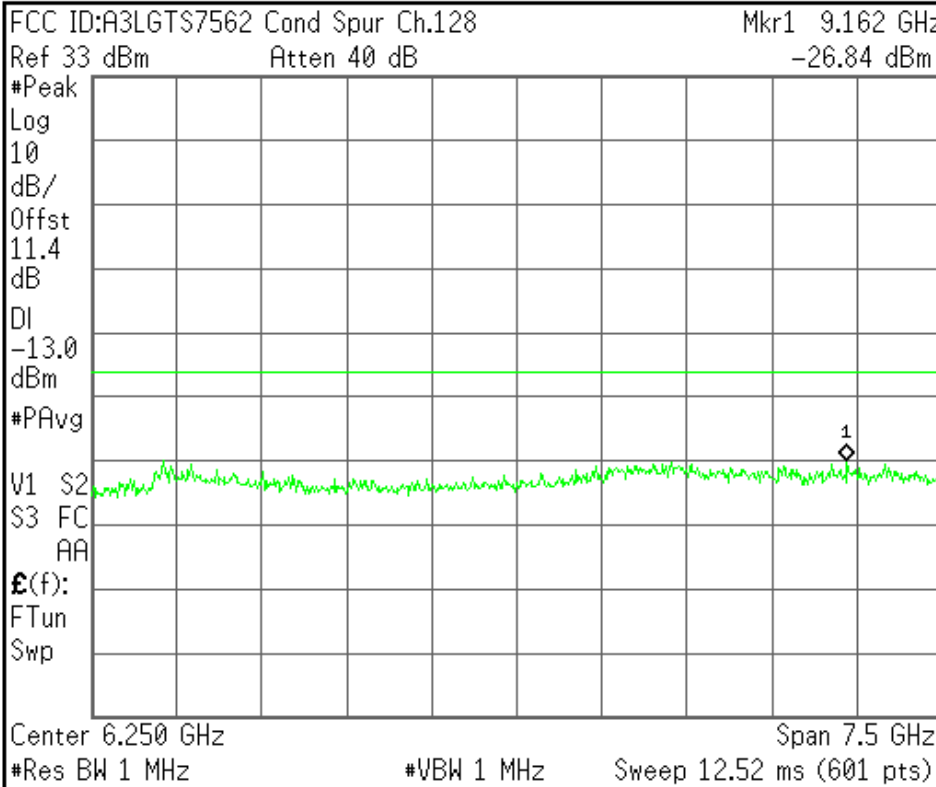

Center Freq 6.25000000 GHz
Start Freq 2.50000000 GHz
Stop Freq 10.00000000 GHz
CF Step 750.000000 MHz Auto Man
Freq Offset 0.00000000 Hz
Signal Track On Off

File Operation Status, C:\TEMP.GIF file saved

Agilent

R T

Freq/Channel

FCC ID:A3LGTS7562 Cond Spur Ch.190

Ref 33 dBm

Atten 40 dB

#Peak

Log

10

dB/

Offst

7.95

dB

DI

-13.0

dBm

#PAvg

M1 S2

S3 FC

AA

£(f):

FTun

Swp

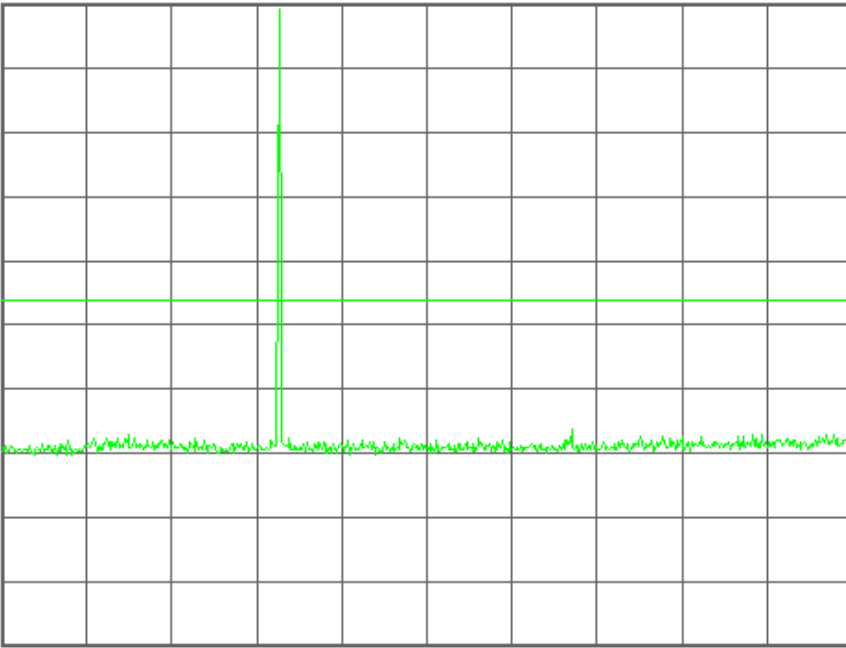

Center 1.265 GHz

Span 2.47 GHz

#Res BW 1 MHz

#VBW 1 MHz

Sweep 4.12 ms (601 pts)

Center Freq
1.26500000 GHz

Start Freq
30.0000000 MHz

Stop Freq
2.50000000 GHz

CF Step
247.000000 MHz
Auto Man

Freq Offset
0.00000000 Hz

Signal Track
On Off

File Operation Status, C:\TEMP.GIF file saved

Agilent

R T

Freq/Channel

FCC ID:A3LGTS7562 Cond Spur Ch.190

Mkr1 830.3 MHz

Ref 33 dBm

Atten 40 dB

-34.06 dBm

#Peak

Log

10

dB/

Offst

7.95

dB

DI

-13.0

dBm

#PAvg

M1 S2

S3 FC

AA

£(f):

FTun

Swp

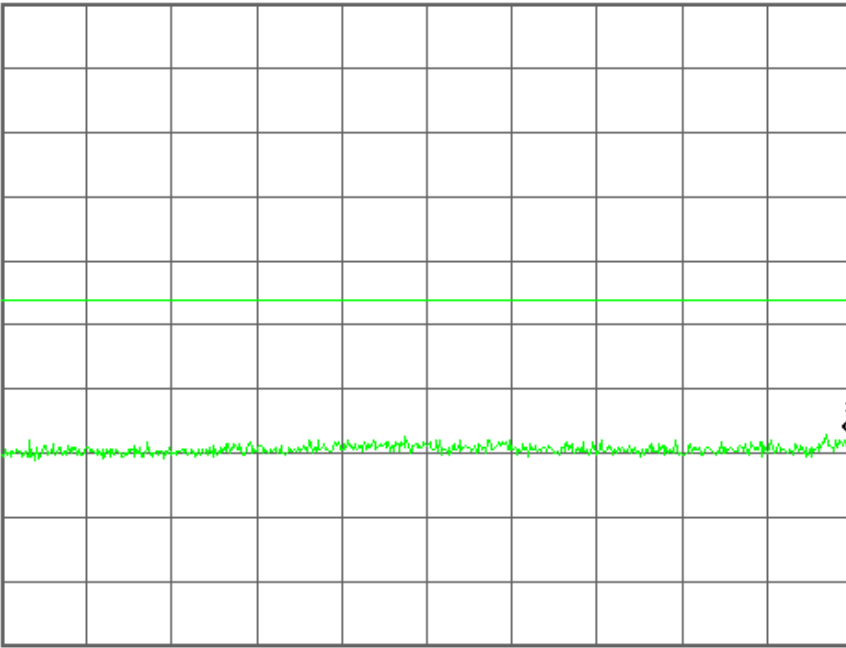

Center 430.8 MHz

Span 801.6 MHz

#Res BW 1 MHz

#VBW 1 MHz

Sweep 1.36 ms (601 pts)

Center Freq
430.800000 MHz

Start Freq
30.0000000 MHz

Stop Freq
831.600000 MHz

CF Step
80.1600000 MHz
Auto Man

Freq Offset
0.00000000 Hz

Signal Track
On Off

File Operation Status, C:\TEMP.GIF file saved

Agilent

R T

Freq/Channel

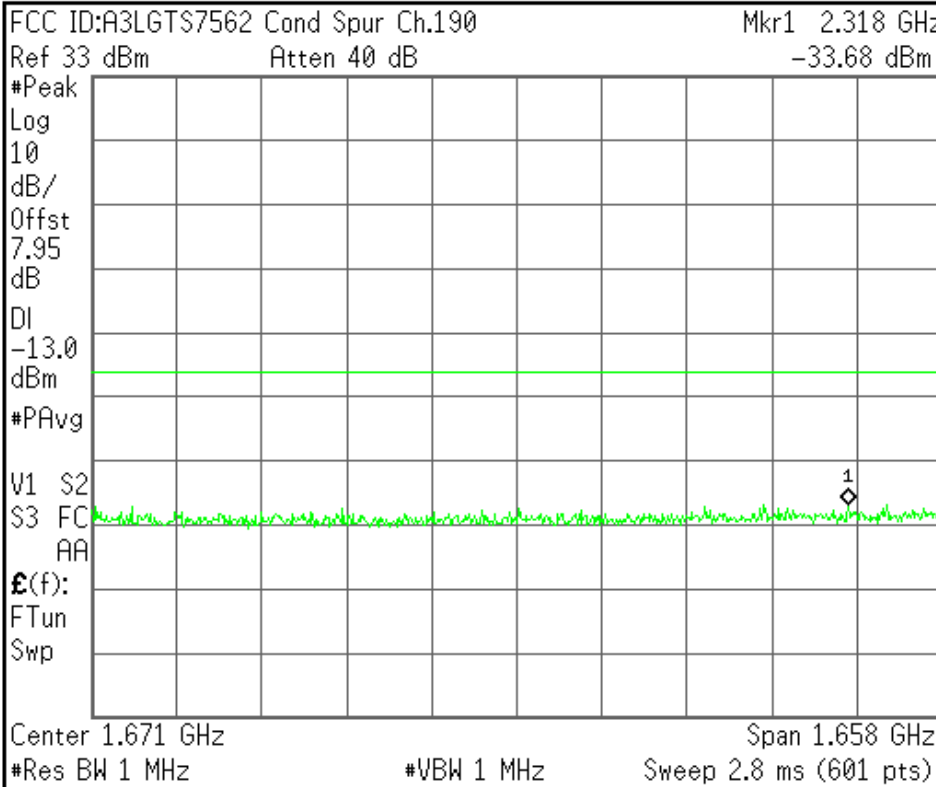

Center Freq 1.67080000 GHz
Start Freq 841.600000 MHz
Stop Freq 2.50000000 GHz
CF Step 165.840000 MHz Auto Man
Freq Offset 0.00000000 Hz
Signal Track On Off

File Operation Status, C:\TEMP.GIF file saved

Agilent

R T

Freq/Channel

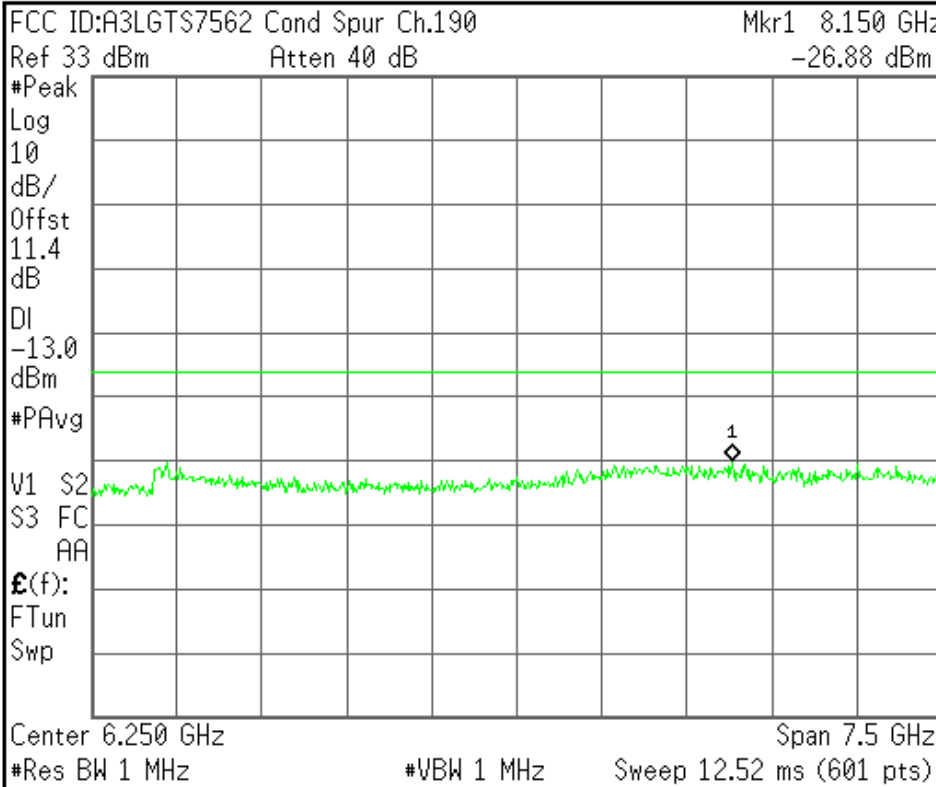

Center Freq 6.25000000 GHz
Start Freq 2.50000000 GHz
Stop Freq 10.00000000 GHz
CF Step 750.000000 MHz Auto Man
Freq Offset 0.00000000 Hz
Signal Track On Off

File Operation Status, C:\TEMP.GIF file saved

Agilent

R T

Freq/Channel

FCC ID:A3LGT\$7562 Cond Spur Ch.251

Ref 33 dBm

Atten 40 dB

#Peak

Log

10

dB/

Offst

7.95

dB

DI

-13.0

dBm

#PAvg

M1 S2

S3 FC

AA

£(f):

FTun

Swp

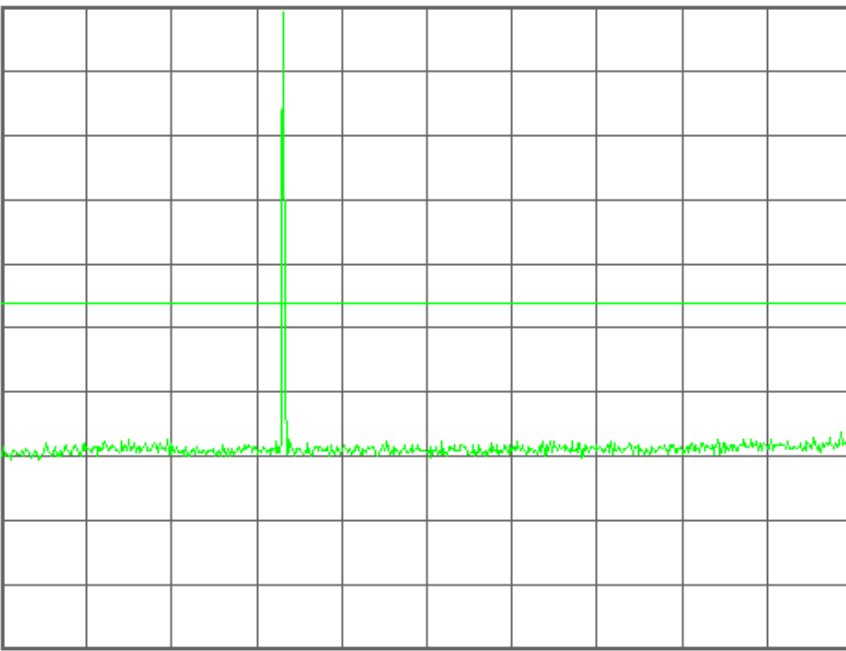

Center 1.265 GHz

Span 2.47 GHz

#Res BW 1 MHz

#VBW 1 MHz

Sweep 4.12 ms (601 pts)

Center Freq
1.26500000 GHz

Start Freq
30.0000000 MHz

Stop Freq
2.50000000 GHz

CF Step
247.000000 MHz
Auto Man

Freq Offset
0.00000000 Hz

Signal Track
On Off

File Operation Status, C:\TEMP.GIF file saved

Agilent

R T

Freq/Channel

FCC ID:A3LGT\$7562 Cond Spur Ch.251

Mkr1 607.8 MHz

Ref 33 dBm

Atten 40 dB

-33.27 dBm

#Peak

Log

10

dB/

Offst

7.95

dB

DI

-13.0

dBm

#PAvg

M1 S2

S3 FC

AA

£(f):

FTun

Swp

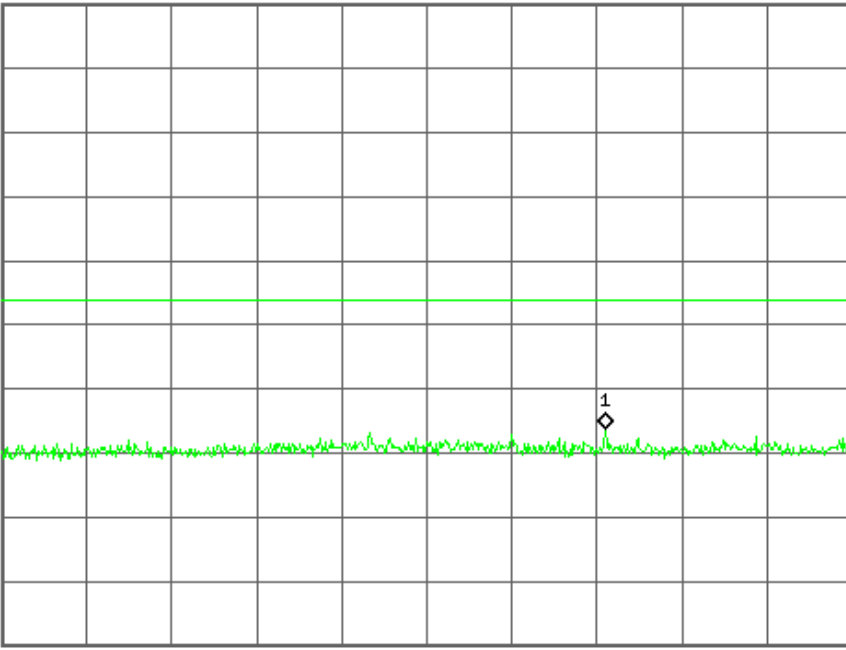

Center 436.9 MHz

Span 813.8 MHz

#Res BW 1 MHz

#VBW 1 MHz

Sweep 1.36 ms (601 pts)

Center Freq
436.900000 MHz

Start Freq
30.0000000 MHz

Stop Freq
843.800000 MHz

CF Step
81.3800000 MHz
Auto Man

Freq Offset
0.00000000 Hz

Signal Track
On Off

File Operation Status, C:\TEMP.GIF file saved

Agilent

R T

Freq/Channel

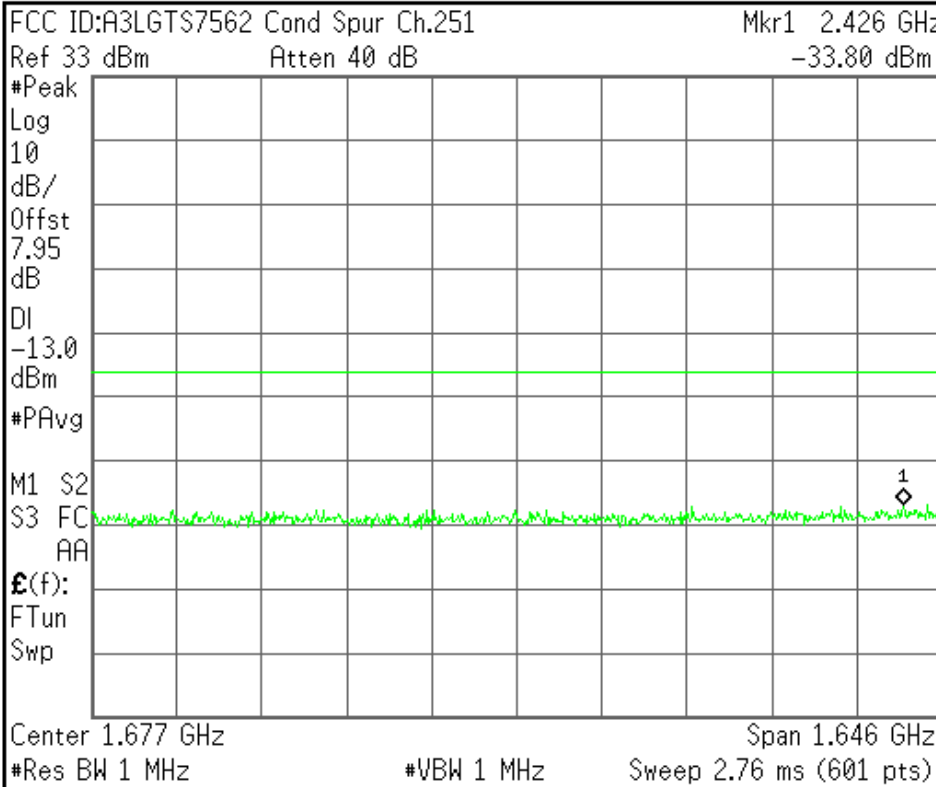

Center Freq 1.67690000 GHz
Start Freq 853.800000 MHz
Stop Freq 2.50000000 GHz
CF Step 164.620000 MHz Auto Man
Freq Offset 0.00000000 Hz
Signal Track On Off

File Operation Status, C:\TEMP.GIF file saved

Agilent

R T

Freq/Channel

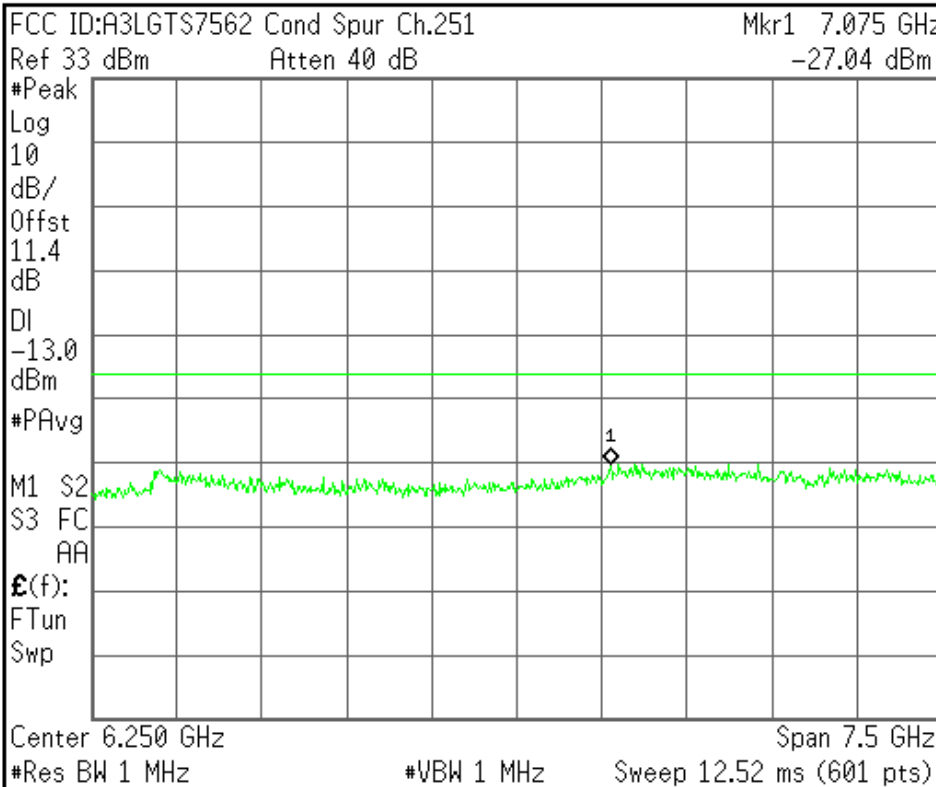

Center Freq 6.25000000 GHz
Start Freq 2.50000000 GHz
Stop Freq 10.00000000 GHz
CF Step 750.000000 MHz Auto Man
Freq Offset 0.00000000 Hz
Signal Track On Off

File Operation Status, C:\TEMP.GIF file saved

Agilent

R T

Freq/Channel

FCC ID:A3LGT\$7562 Band Edge Ch.128

Ref 33 dBm Atten 40 dB

#Avg
Log
10
dB/
Offst
7.95
dB
DI
-13.0
dBm
#PAvg
M1 S2
S3 FC
AA
£(f):
f>50k
Swp

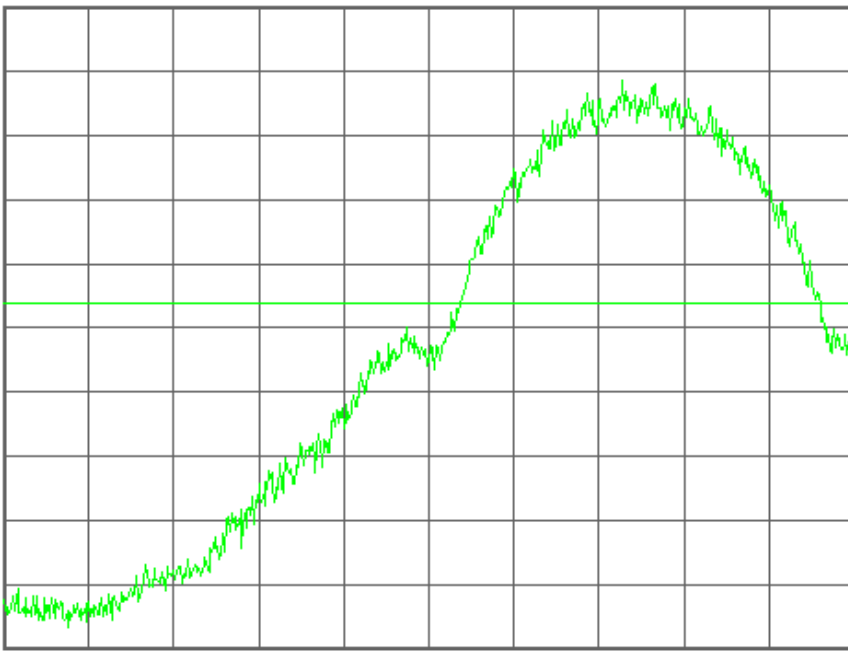

Center 824.000 0 MHz Span 810 kHz
#Res BW 3 kHz #VBW 3 kHz Sweep 343.2 ms (601 pts)

Center Freq
824.000000 MHz

Start Freq
823.595000 MHz

Stop Freq
824.405000 MHz

CF Step
81.0000000 kHz
Auto Man

Freq Offset
0.00000000 Hz

Signal Track
On Off

Neg.Trig Delay unavailable in Swept Mode, zero delay used.

Agilent

R T

Freq/Channel

FCC ID:A3LGT\$7562 Band Edge Ch.128

Ref 33 dBm Atten 40 dB

Mkr1 823.975 9 MHz

-15.97 dBm

#Avg
Log
10
dB/
Offst
7.95
dB
DI
-13.0
dBm
#PAvg
M1 S2
S3 FC
AA
£(f):
f>50k
Swp

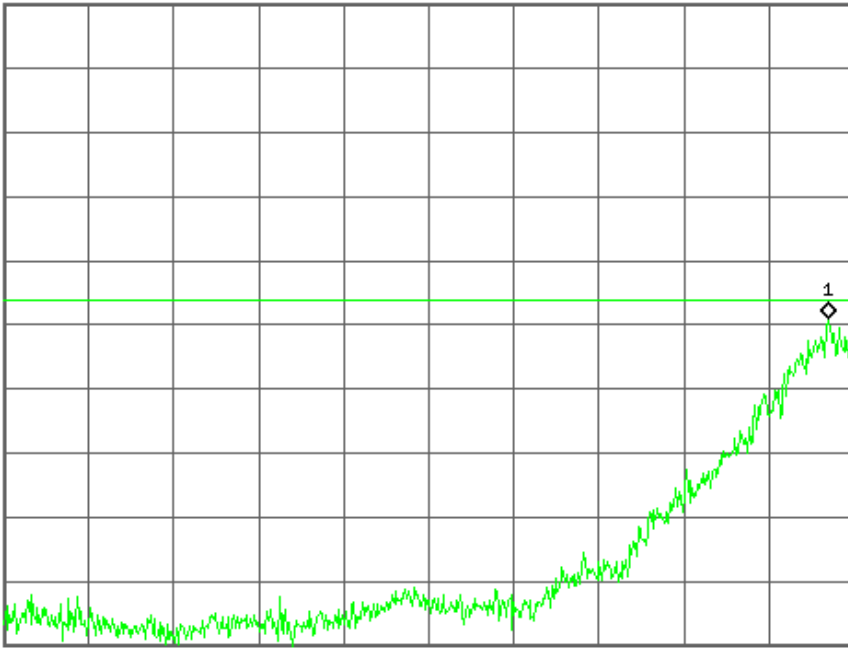

Center 823.595 0 MHz Span 810 kHz
#Res BW 3 kHz #VBW 3 kHz Sweep 343.2 ms (601 pts)

Center Freq
823.595000 MHz

Start Freq
823.190000 MHz

Stop Freq
824.000000 MHz

CF Step
81.0000000 kHz
Auto Man

Freq Offset
0.00000000 Hz

Signal Track
On Off

File Operation Status, C:\TEMP.GIF file saved

Agilent

R T

Freq/Channel

FCC ID:A3LGT\$7562 Band Edge Ch.251

Ref 33 dBm Atten 40 dB

#Avg

Log

10

dB/

Offst

7.95

dB

DI

-13.0

dBm

#PAvg

M1 S2

S3 FC

AA

£(f):

f>50k

Swp

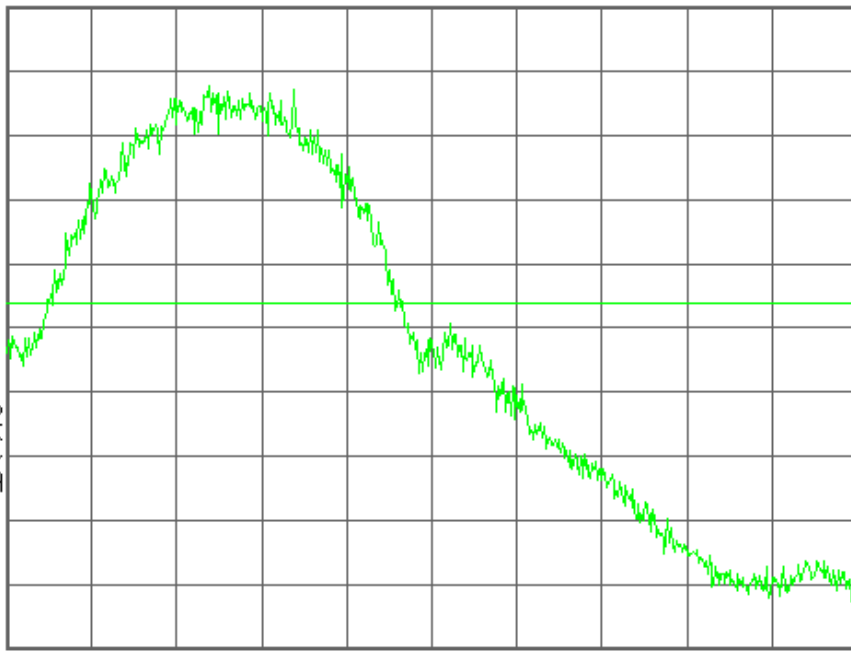

Center 849.000 0 MHz

Span 810 kHz

#Res BW 3 kHz

#VBW 3 kHz

Sweep 343.2 ms (601 pts)

Center Freq
849.000000 MHz

Start Freq
848.595000 MHz

Stop Freq
849.405000 MHz

CF Step
81.0000000 kHz
Auto Man

Freq Offset
0.00000000 Hz

Signal Track
On Off

Neg.Trig Delay unavailable in Swept Mode, zero delay used.

Agilent

R T

Freq/Channel

FCC ID:A3LGT\$7562 Band Edge Ch.251

Mkr1 849.020 1 MHz

Ref 33 dBm Atten 40 dB

-17.57 dBm

#Avg

Log

10

dB/

Offst

7.95

dB

DI

-13.0

dBm

#PAvg

M1 S2

S3 FC

AA

£(f):

f>50k

Swp

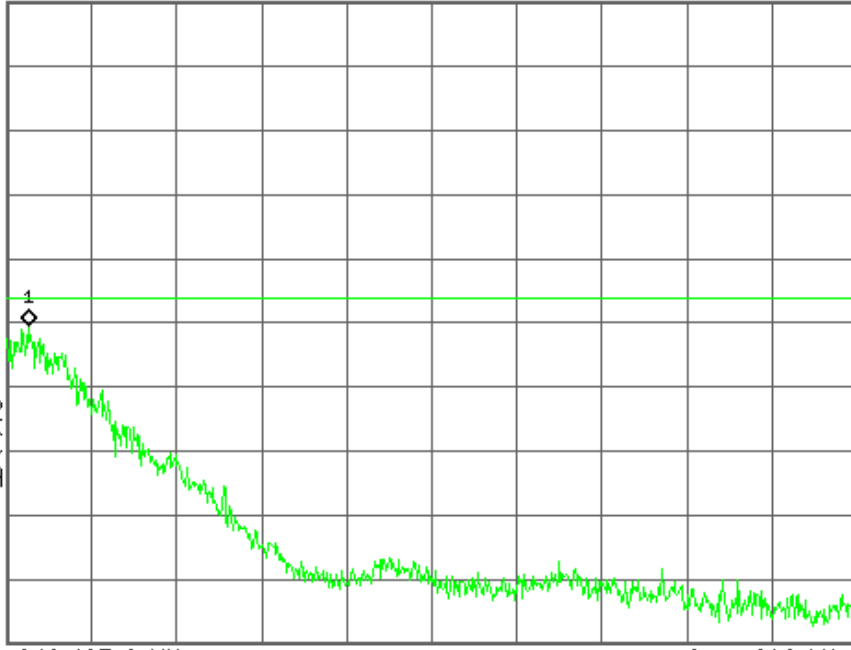

Center 849.405 0 MHz

Span 810 kHz

#Res BW 3 kHz

#VBW 3 kHz

Sweep 343.2 ms (601 pts)

Center Freq
849.405000 MHz

Start Freq
849.000000 MHz

Stop Freq
849.810000 MHz

CF Step
81.0000000 kHz
Auto Man

Freq Offset
0.00000000 Hz

Signal Track
On Off

File Operation Status, C:\TEMP.GIF file saved

GSM1900

Agilent

R T

Ch Freq 1.8502 GHz Trig Free

Occupied Bandwidth

FCC ID:A3LGTS7562 0BW Ch.512
Ref 30 dBm Atten 40 dB

Center 1.850 200 GHz Span 1 MHz
#Res BW 3 kHz #VBW 3 kHz #Sweep 1 s (601 pts)

Occupied Bandwidth	Occ BW % Pwr	99.00 %
248.6150 kHz	x dB	-26.00 dB
Transmit Freq Error		-1.008 kHz
x dB Bandwidth		308.165 kHz

Freq/Channel

Center Freq
1.85020000 GHz

Start Freq
1.84970000 GHz

Stop Freq
1.85070000 GHz

CF Step
100.000000 kHz
Auto Man

Freq Offset
0.00000000 Hz

Signal Track
On Off

File Operation Status, C:\TEMP.GIF file saved

Agilent

R T

Ch Freq 1.88 GHz Trig Free

Occupied Bandwidth

FCC ID:A3LGTS7562 0BW Ch.661
Ref 30 dBm Atten 40 dB

Center 1.880 000 GHz Span 1 MHz
#Res BW 3 kHz #VBW 3 kHz #Sweep 1 s (601 pts)

Occupied Bandwidth	Occ BW % Pwr	99.00 %
245.6692 kHz	x dB	-26.00 dB
Transmit Freq Error		-487.153 Hz
x dB Bandwidth		319.789 kHz

Freq/Channel

Center Freq
1.88000000 GHz

Start Freq
1.87950000 GHz

Stop Freq
1.88050000 GHz

CF Step
100.000000 kHz
Auto Man

Freq Offset
0.00000000 Hz

Signal Track
On Off

File Operation Status, C:\TEMP.GIF file saved

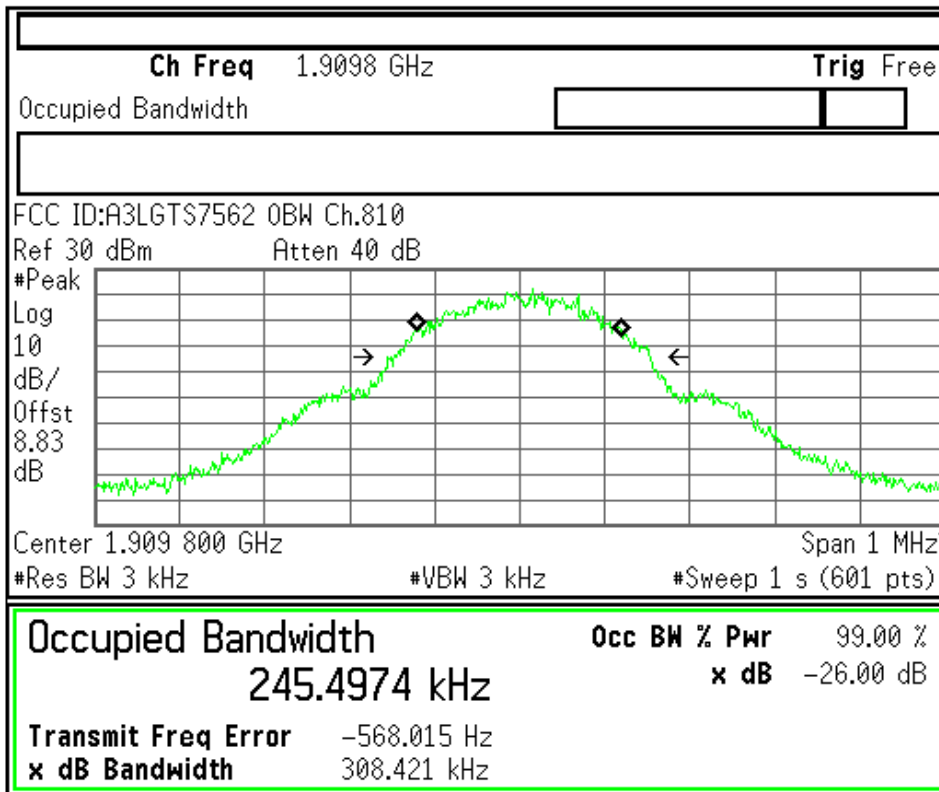

Freq/Channel
Center Freq 1.90980000 GHz
Start Freq 1.90930000 GHz
Stop Freq 1.91030000 GHz
CF Step 100.000000 kHz Auto Man
Freq Offset 0.00000000 Hz
Signal Track On Off

File Operation Status, C:\TEMP.GIF file saved

FCC ID : A3LGTS7562 Transmit Power 512CH

Measurement/Instrument Screen									
Control	Transmit Power							TCH Parms	
Transmit Power Setup			Burst 1	Burst 2	Burst 3	Burst 4	Burst 5	Burst 6	Downlink Traffic Power
	BP	Avg	27.84	----	----	----	----	----	Traffic Band
		SDev	0.00	----	----	----	----	----	PCS
	ECP	Avg	27.84	----	----	----	----	----	Traffic Channel
		SDev	0.00	----	----	----	----	----	512
	100 / 100 Single								MS TX Level
	Phase & Frequency Error								0
Snap Window Positions			Peak Phase °	RMS Phase °	Frequency Hz				Channel Mode Setup
		Minimum	3.71	1.54	-47.70				
		Maximum	6.27	2.03	-21.79				
		Average	4.56	1.78	-37.44				
		Pass/Fail	Pass	Pass	Pass				Return
	100 / 100 Single								
	Background	Active Cell Connected			Sys Type: GSM				
1 of 2			IntRef	Offset	R T				1 of 2

Measurement/Instrument Screen											
Control		Transmit Power							TCH Parms		
Transmit Power Setup	BP	Avg	27.84	----	----	----	----	----	Downlink Traffic Power	Traffic Band	
		SDev	0.00	----	----	----	----	----			PCS
	ECP	Avg	27.84	----	----	----	----	----	Traffic Channel	661	
		SDev	0.00	----	----	----	----	----			MS TX Level
			100 / 100							Single	
	Phase & Frequency Error										
					Peak Phase °	RMS Phase °	Frequency Hz				
	Minimum				3.25	1.22	-40.68		Channel Mode Setup		
	Maximum				5.33	1.76	-18.48		Return		
	Average				4.13	1.47	-29.83				
Pass/Fail				Pass	Pass	Pass					
		100 / 100							Single		
Swap Window Positions		Background		Active Cell Connected			Sys Type: GSM				
1 of 2				IntRef	Offset	R	T			1 of 2	

Measurement/Instrument Screen											
Control		Transmit Power							TCH Parms		
Transmit Power Setup	BP	Avg	27.97	----	----	----	----	----	Downlink Traffic Power	Traffic Band	
		SDev	0.00	----	----	----	----	----			PCS
	ECP	Avg	27.97	----	----	----	----	----	Traffic Channel	810	
		SDev	0.00	----	----	----	----	----			MS TX Level
			100 / 100							Single	
	Phase & Frequency Error										
					Peak Phase °	RMS Phase °	Frequency Hz				
	Minimum				4.02	1.23	-41.20		Channel Mode Setup		
	Maximum				6.87	1.78	-17.15		Return		
	Average				4.90	1.59	-32.46				
Pass/Fail				Pass	Pass	Pass					
		100 / 100							Single		
Swap Window Positions		Background		Active Cell Connected			Sys Type: GSM				
1 of 2				IntRef	Offset	R	T			1 of 2	

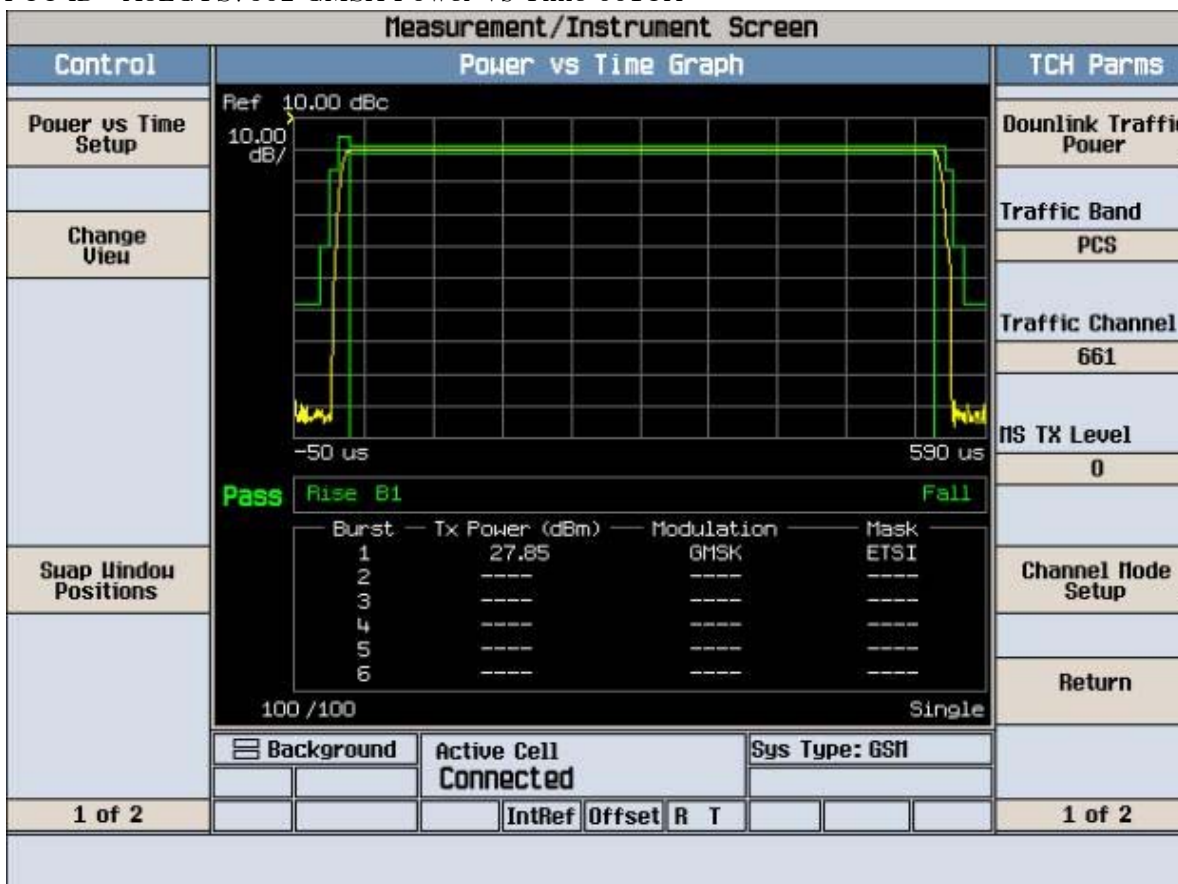
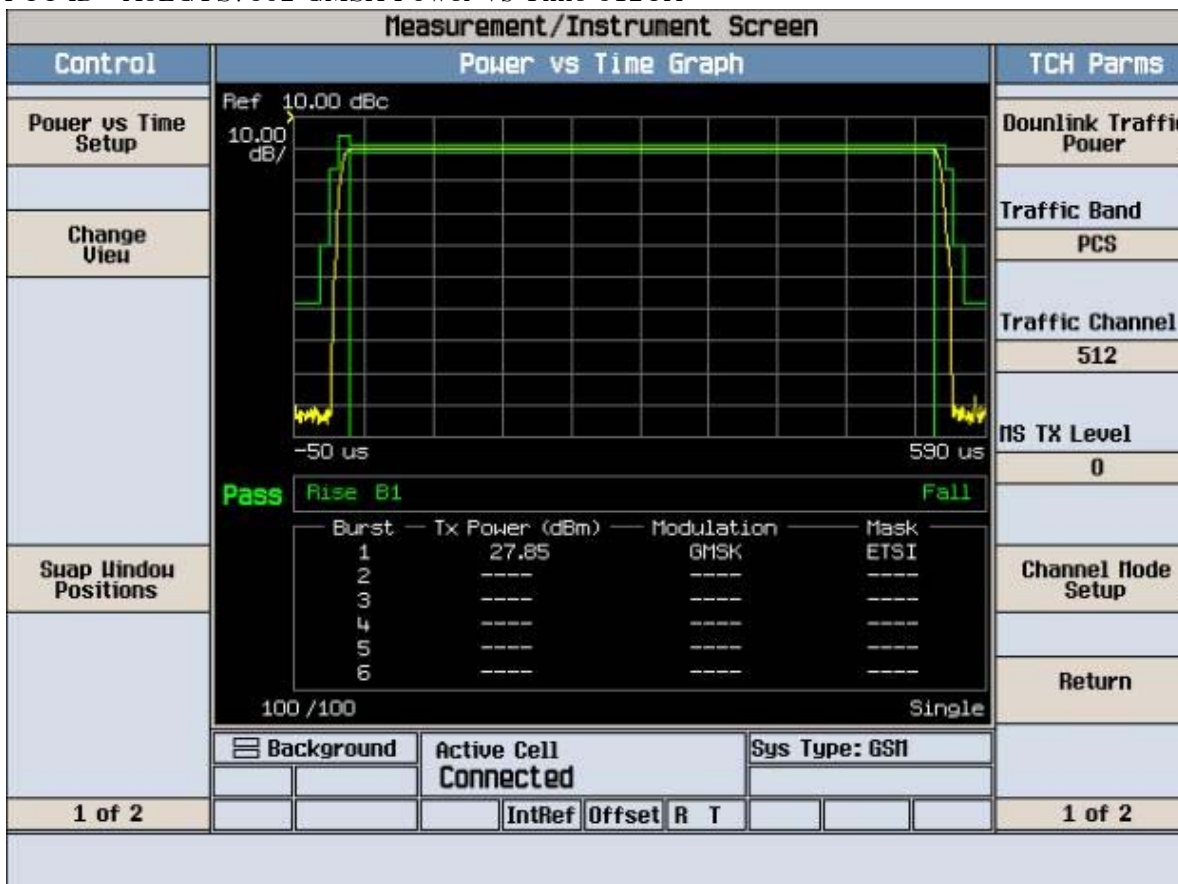

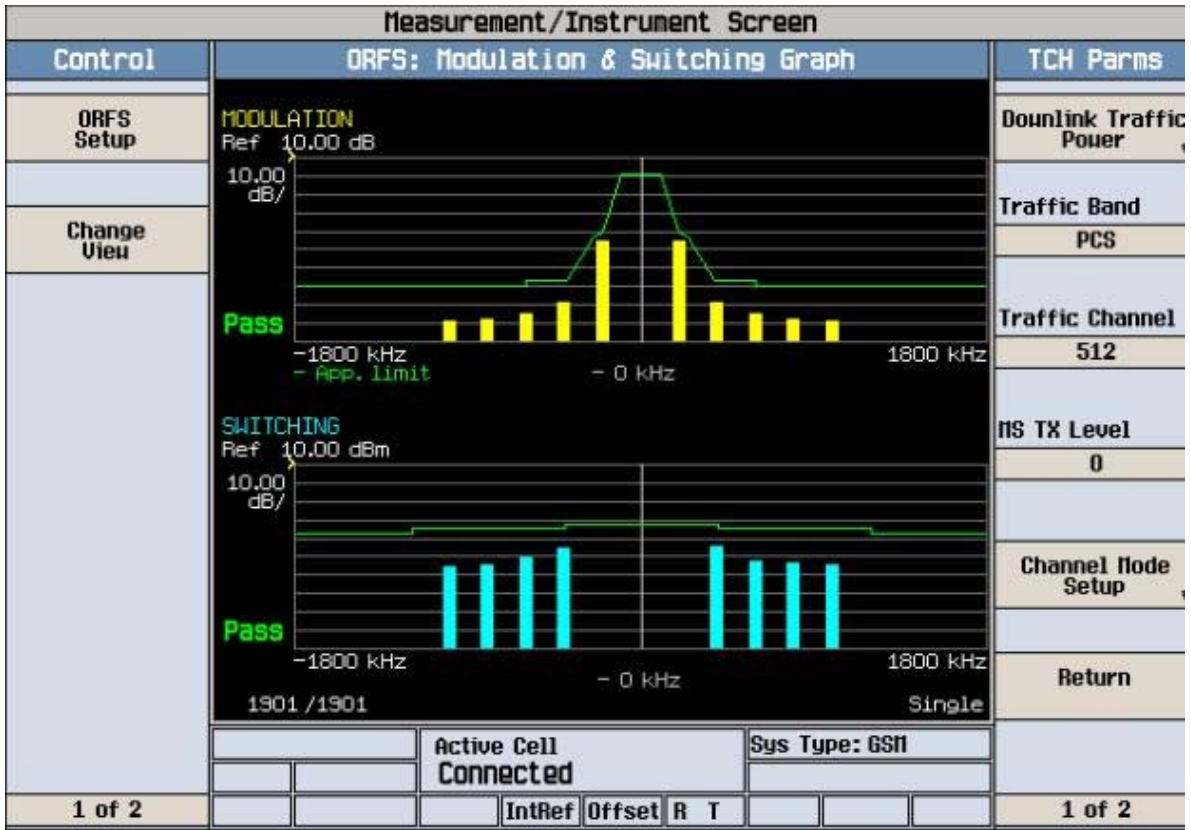
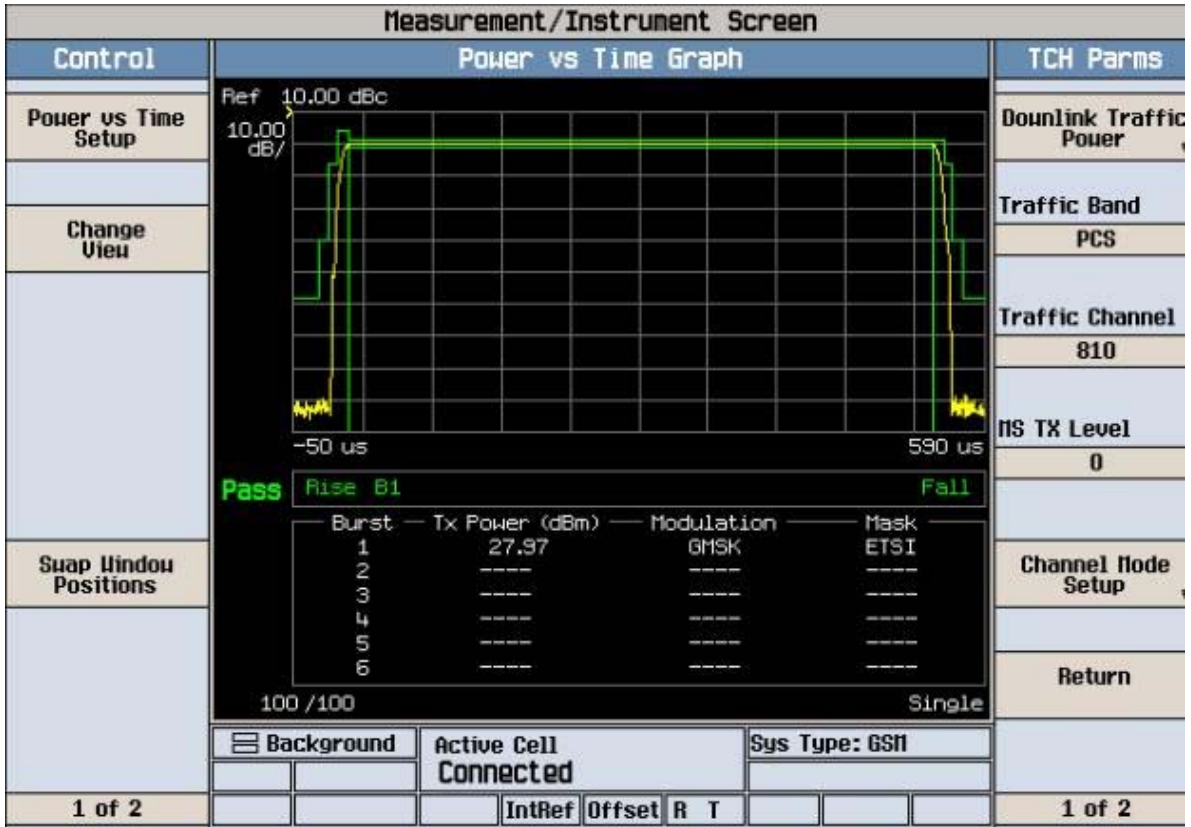

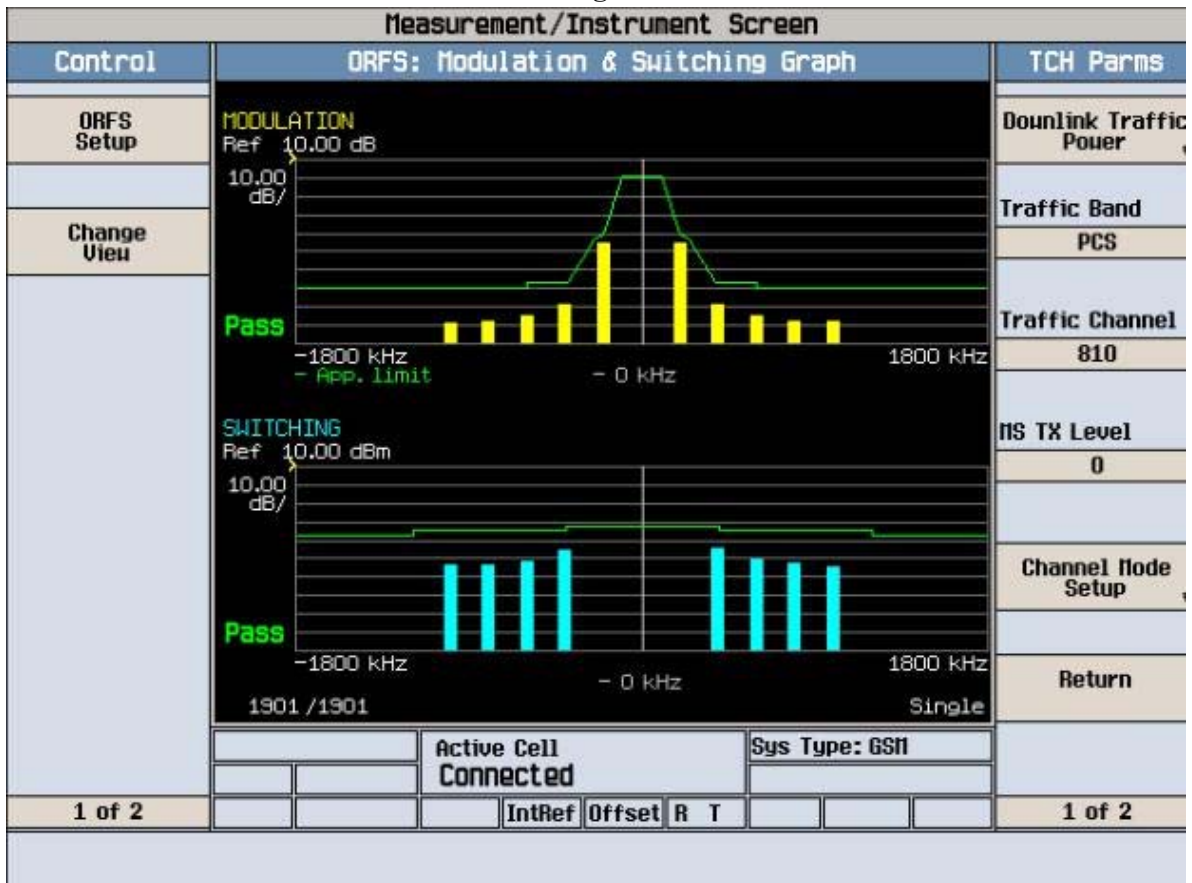
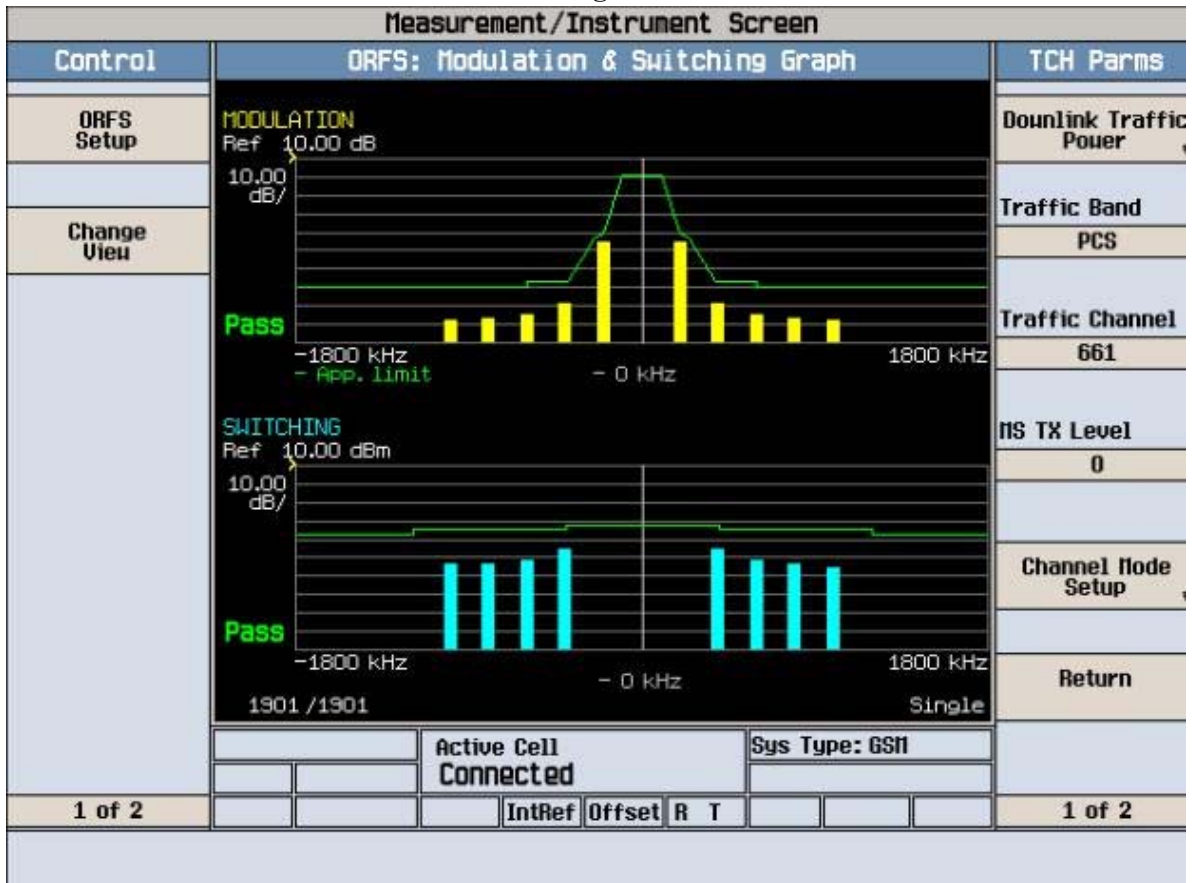

Agilent

R T

Freq/Channel

FCC ID:A3LGTS7562 Cond Spur Ch.512

Ref 30 dBm Atten 40 dB

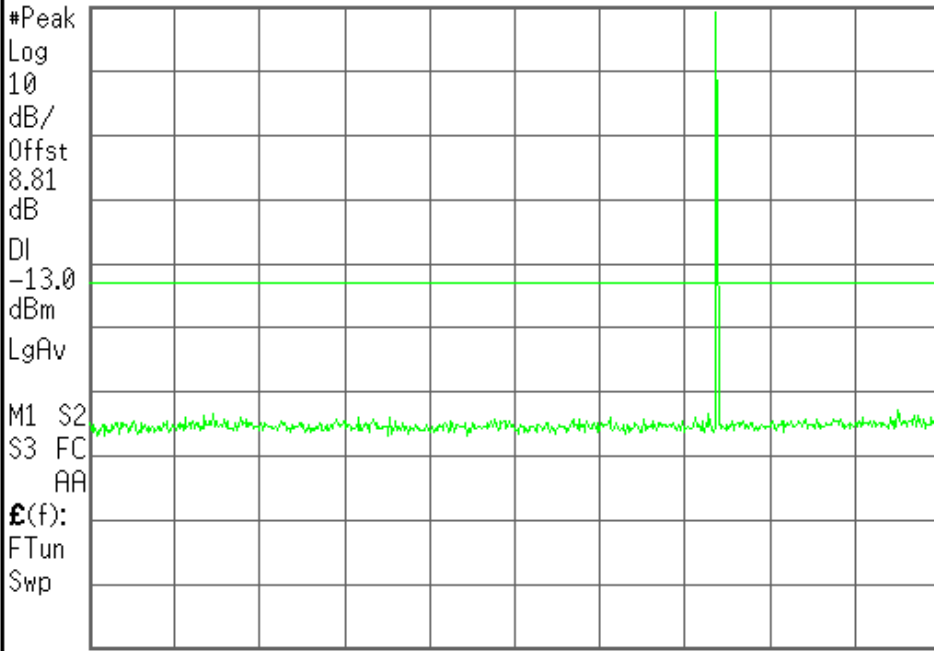

Center Freq
1.26500000 GHz

Start Freq
30.0000000 MHz

Stop Freq
2.50000000 GHz

CF Step
247.000000 MHz
Auto Man

Freq Offset
0.00000000 Hz

Signal Track
On Off

Center 1.265 GHz Span 2.47 GHz
#Res BW 1 MHz #VBW 1 MHz Sweep 4.12 ms (601 pts)

Copyright 2000-2006 Agilent Technologies

Agilent

R T

Freq/Channel

FCC ID:A3LGTS7562 Cond Spur Ch.512

Mkr1 1.631 GHz

Ref 30 dBm Atten 40 dB

-33.04 dBm

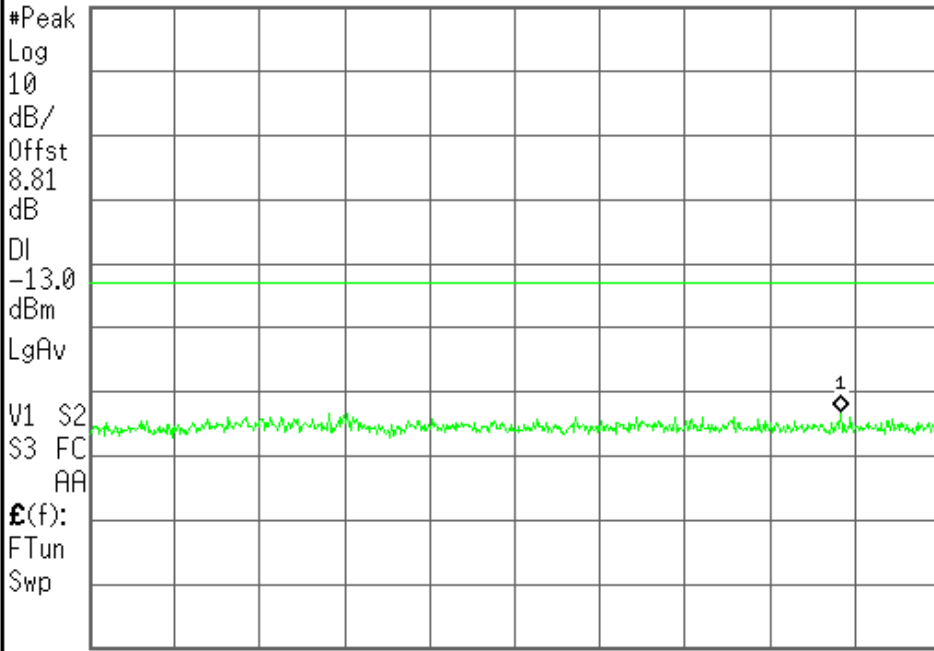

Center Freq
936.350000 MHz

Start Freq
30.0000000 MHz

Stop Freq
1.84270000 GHz

CF Step
181.270000 MHz
Auto Man

Freq Offset
0.00000000 Hz

Signal Track
On Off

Center 936 MHz Span 1.813 GHz
#Res BW 1 MHz #VBW 1 MHz Sweep 3.04 ms (601 pts)

File Operation Status, C:\TEMP.GIF file saved

Agilent

R T

Freq/Channel

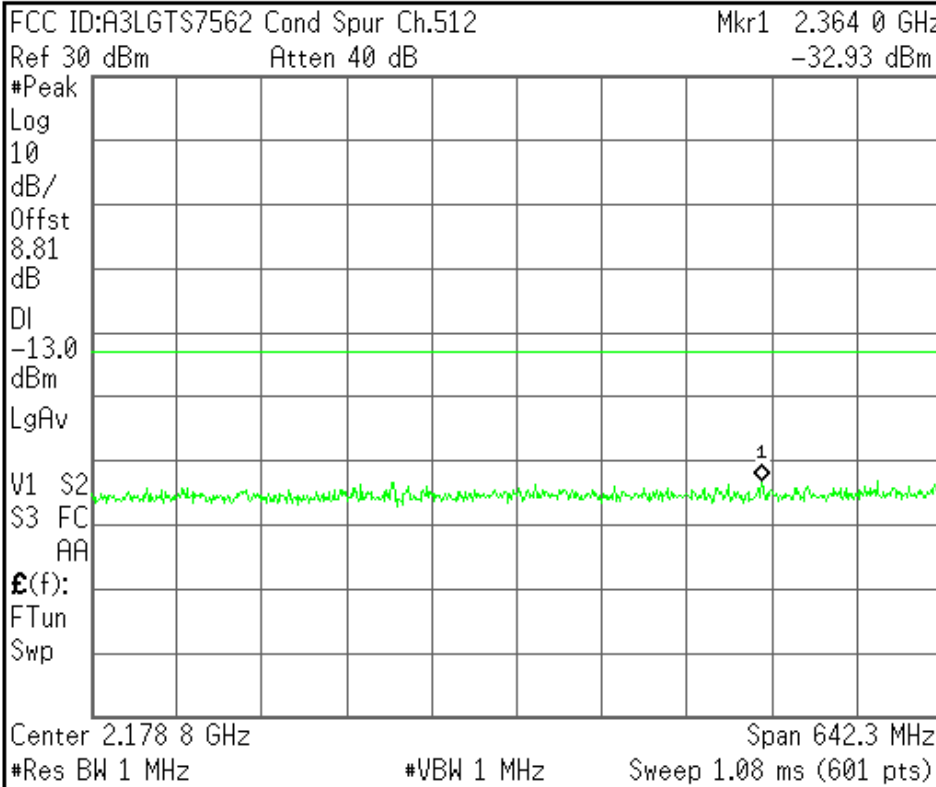

Center Freq
2.17885000 GHz

Start Freq
1.85770000 GHz

Stop Freq
2.50000000 GHz

CF Step
64.2300000 MHz
Auto Man

Freq Offset
0.00000000 Hz

Signal Track
On Off

File Operation Status, C:\TEMP.GIF file saved

Agilent

R T

Freq/Channel

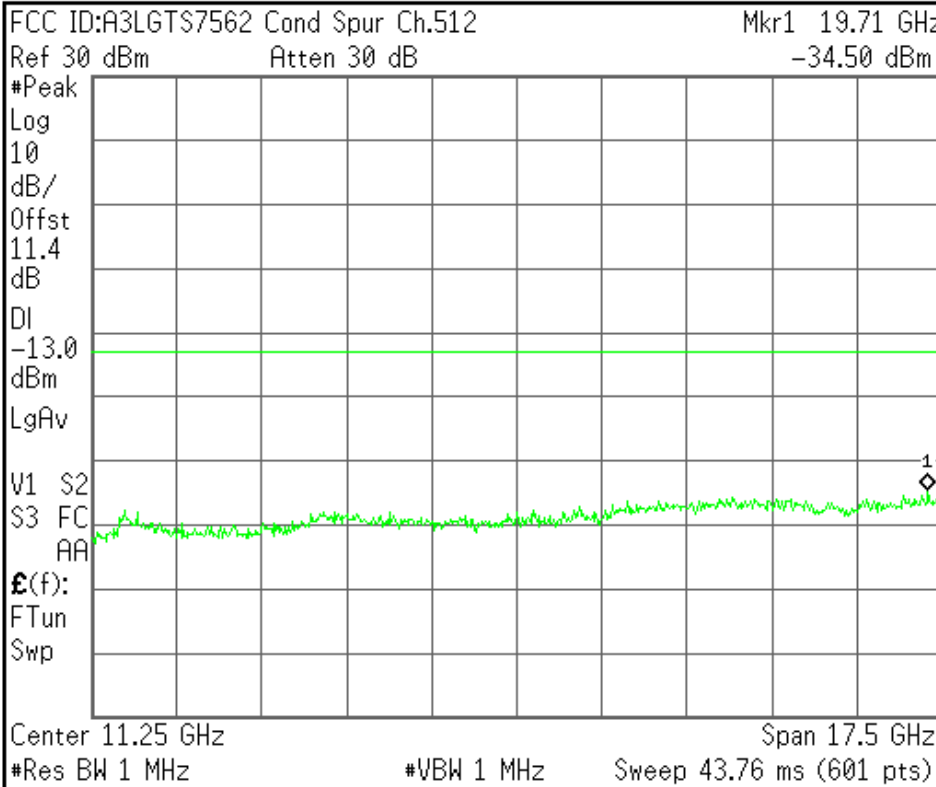

Center Freq
11.2500000 GHz

Start Freq
2.50000000 GHz

Stop Freq
20.0000000 GHz

CF Step
1.75000000 GHz
Auto Man

Freq Offset
0.00000000 Hz

Signal Track
On Off

File Operation Status, C:\TEMP.GIF file saved

Agilent

R T

Freq/Channel

FCC ID:A3LGT\$7562 Cond Spur Ch.661

Ref 30 dBm Atten 40 dB

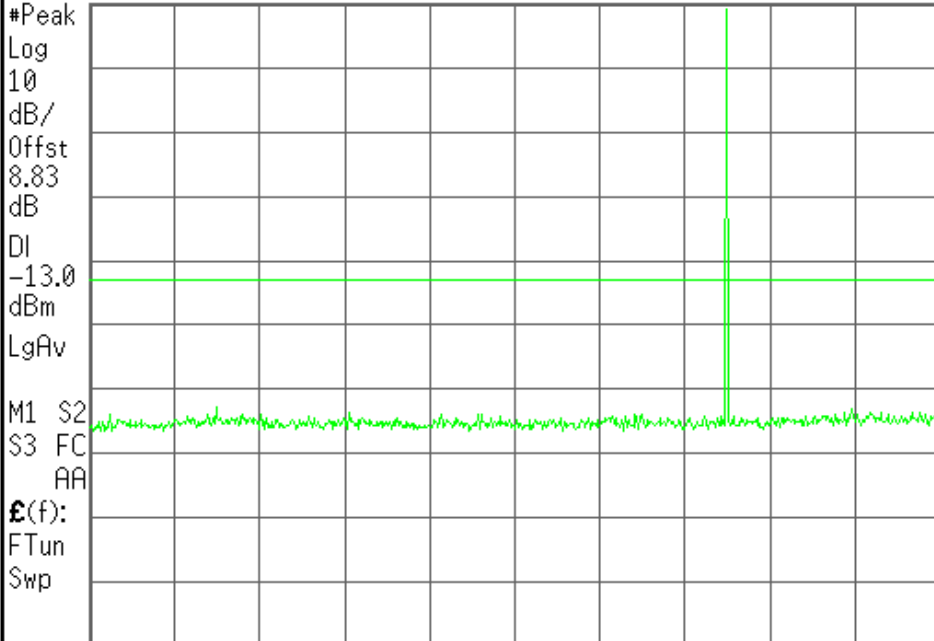

Center Freq
1.26500000 GHz

Start Freq
30.0000000 MHz

Stop Freq
2.50000000 GHz

CF Step
247.000000 MHz
Auto Man

Freq Offset
0.00000000 Hz

Signal Track
On Off

Center 1.265 GHz Span 2.47 GHz
#Res BW 1 MHz #VBW 1 MHz Sweep 4.12 ms (601 pts)

File Operation Status, C:\TEMP.GIF file saved

Agilent

R T

Freq/Channel

FCC ID:A3LGT\$7562 Cond Spur Ch.661

Mkr1 1.845 GHz

Ref 30 dBm Atten 40 dB

-33.44 dBm

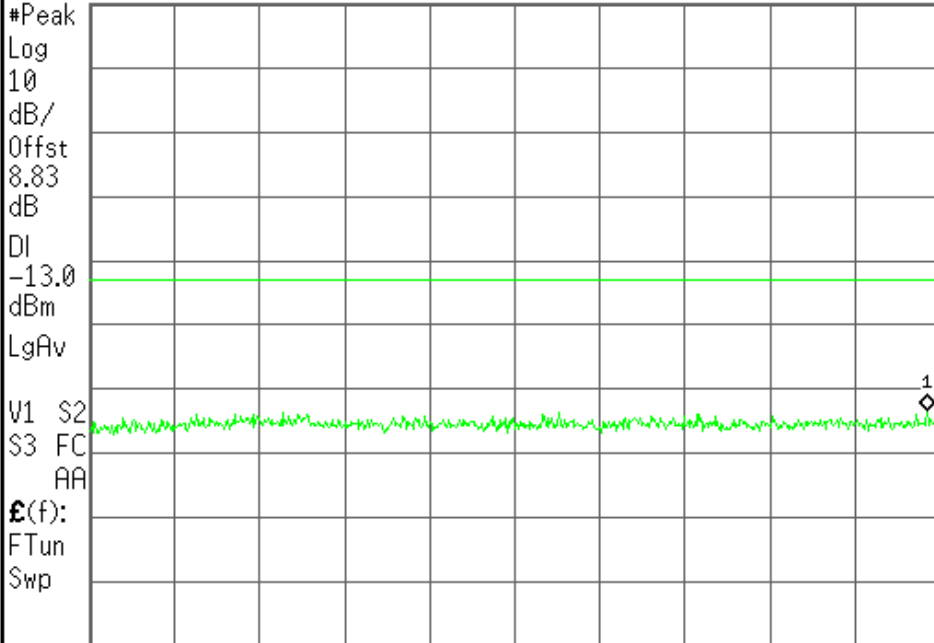

Center Freq
951.250000 MHz

Start Freq
30.0000000 MHz

Stop Freq
1.87250000 GHz

CF Step
184.250000 MHz
Auto Man

Freq Offset
0.00000000 Hz

Signal Track
On Off

Center 951 MHz Span 1.843 GHz
#Res BW 1 MHz #VBW 1 MHz Sweep 3.08 ms (601 pts)

File Operation Status, C:\TEMP.GIF file saved

Agilent

R T

Freq/Channel

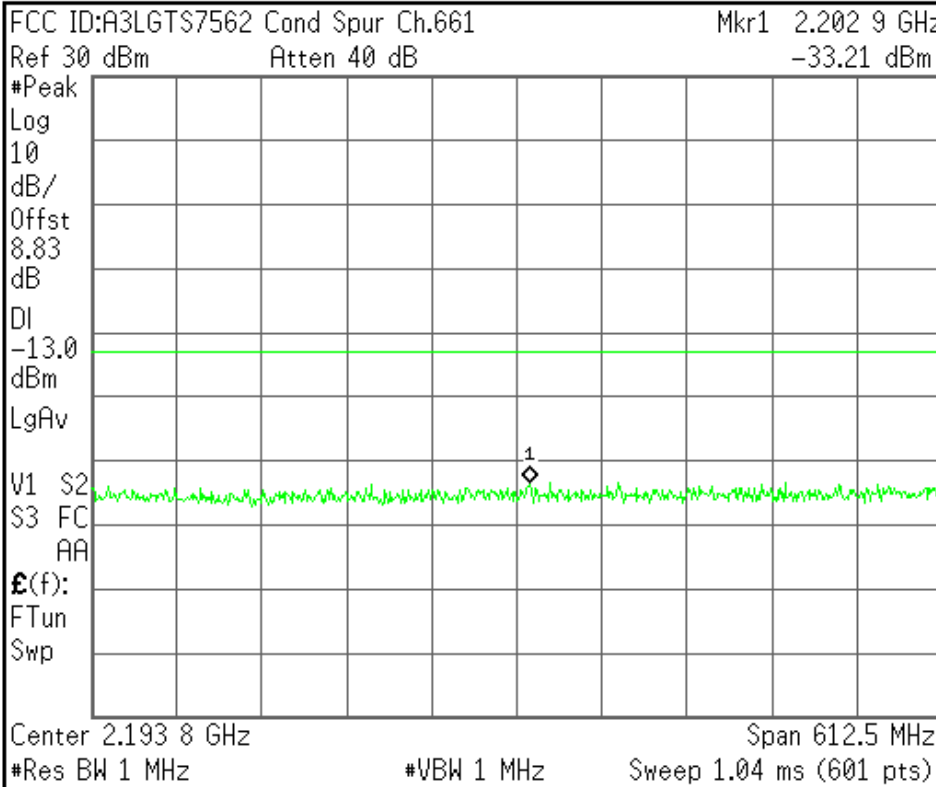

Center Freq 2.19375000 GHz
Start Freq 1.88750000 GHz
Stop Freq 2.50000000 GHz
CF Step Auto Man 61.2500000 MHz
Freq Offset 0.00000000 Hz
Signal Track On Off

File Operation Status, C:\TEMP.GIF file saved

Agilent

R T

Freq/Channel

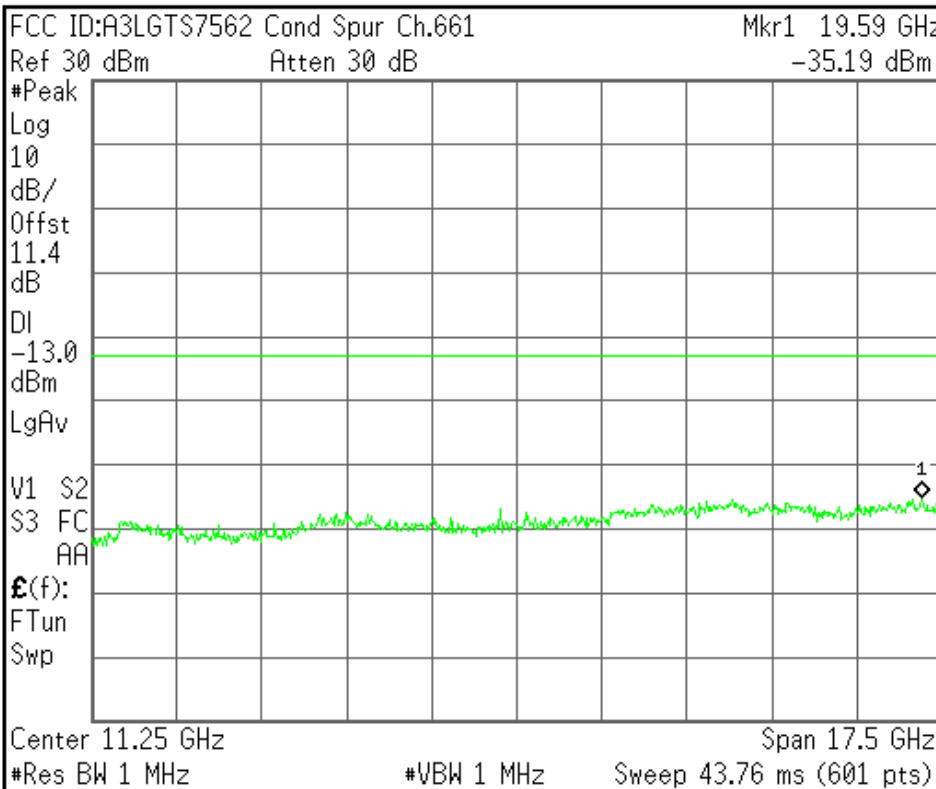

Center Freq 11.2500000 GHz
Start Freq 2.50000000 GHz
Stop Freq 20.0000000 GHz
CF Step Auto Man 1.75000000 GHz
Freq Offset 0.00000000 Hz
Signal Track On Off

File Operation Status, C:\TEMP.GIF file saved

Agilent

R T

Freq/Channel

FCC ID:A3LGT\$7562 Cond Spur Ch.810

Ref 30 dBm Atten 40 dB

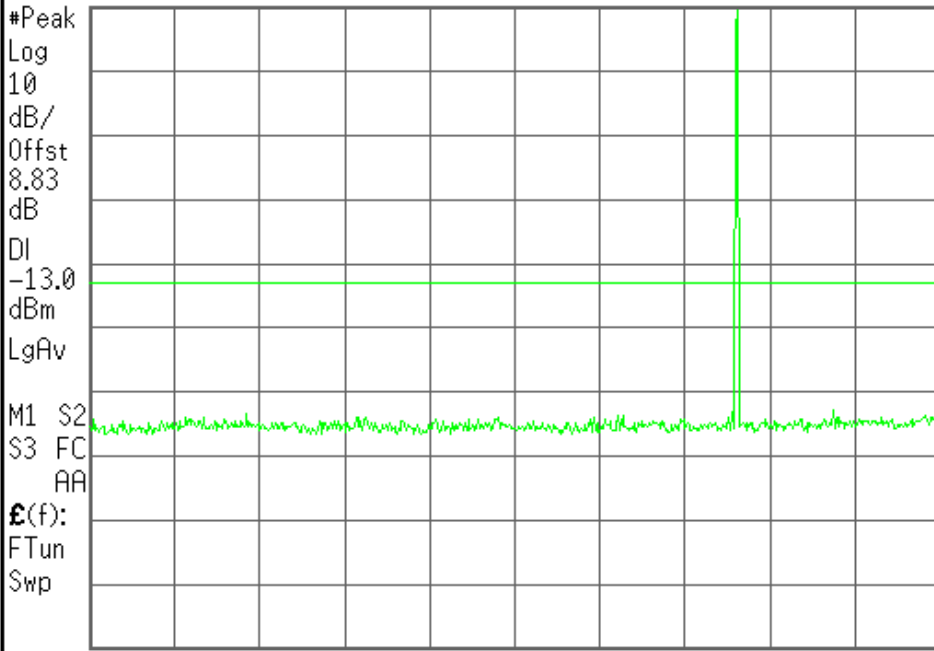

Center Freq
1.26500000 GHz

Start Freq
30.0000000 MHz

Stop Freq
2.50000000 GHz

CF Step
247.000000 MHz
Auto Man

Freq Offset
0.00000000 Hz

Signal Track
On Off

Center 1.265 GHz Span 2.47 GHz

#Res BW 1 MHz #VBW 1 MHz Sweep 4.12 ms (601 pts)

File Operation Status, C:\TEMP.GIF file saved

Agilent

R T

Freq/Channel

FCC ID:A3LGT\$7562 Cond Spur Ch.810

Mkr1 1.852 GHz

Ref 30 dBm Atten 40 dB

-33.34 dBm

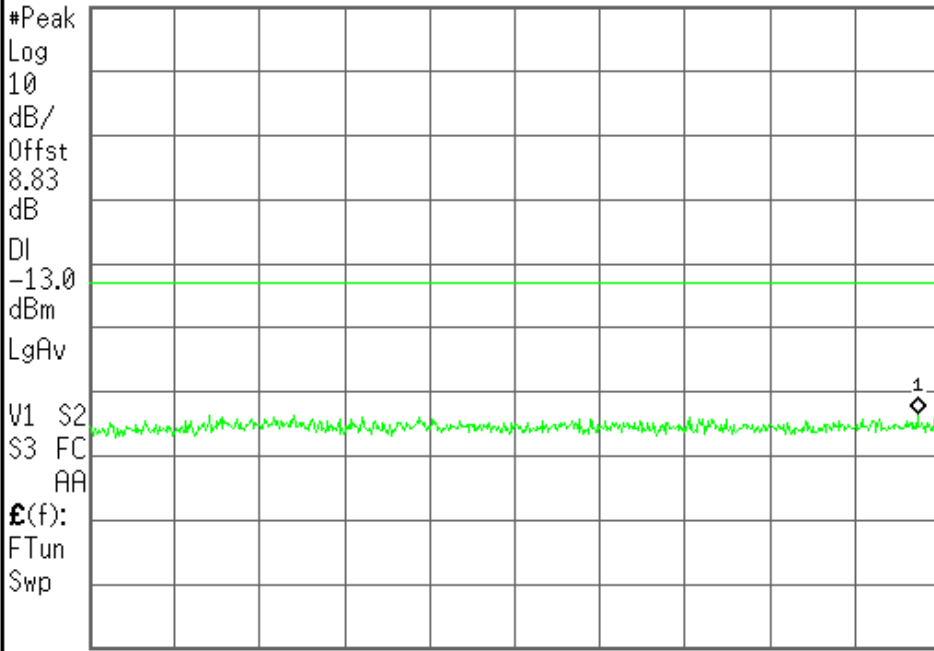

Center Freq
966.150000 MHz

Start Freq
30.0000000 MHz

Stop Freq
1.90230000 GHz

CF Step
187.230000 MHz
Auto Man

Freq Offset
0.00000000 Hz

Signal Track
On Off

Center 966 MHz Span 1.872 GHz

#Res BW 1 MHz #VBW 1 MHz Sweep 3.16 ms (601 pts)

File Operation Status, C:\TEMP.GIF file saved

Agilent

R T

Freq/Channel

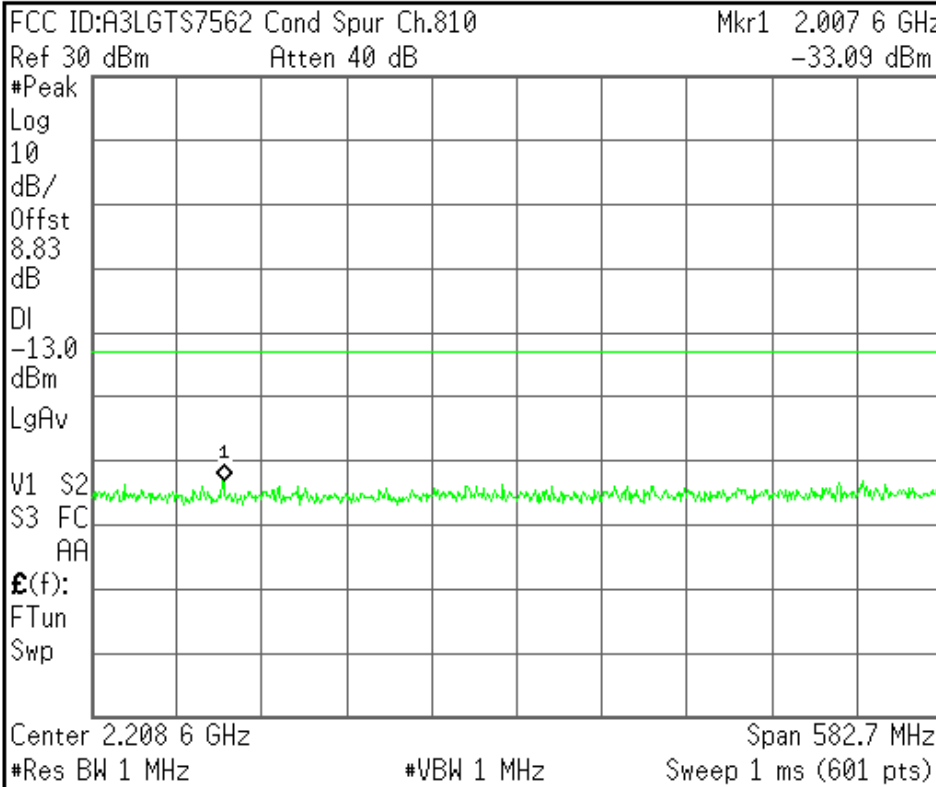

Center Freq 2.20865000 GHz
Start Freq 1.91730000 GHz
Stop Freq 2.50000000 GHz
CF Step 58.2700000 MHz Auto Man
Freq Offset 0.00000000 Hz
Signal Track On Off

File Operation Status, C:\TEMP.GIF file saved

Agilent

R T

Freq/Channel

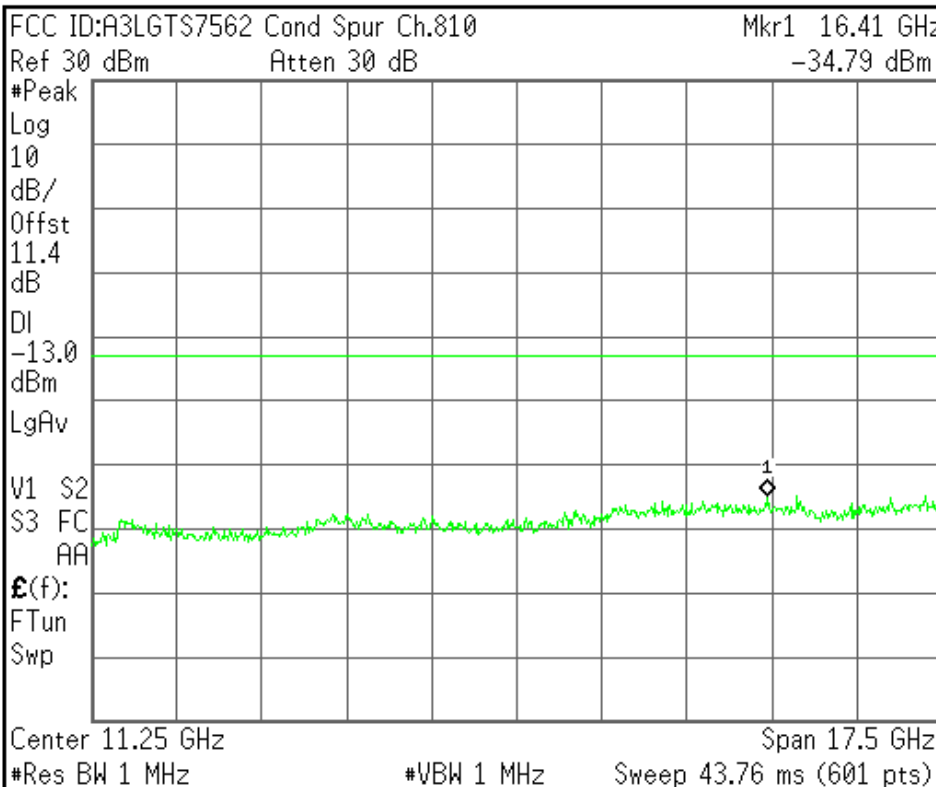

Center Freq 11.2500000 GHz
Start Freq 2.50000000 GHz
Stop Freq 20.0000000 GHz
CF Step 1.75000000 GHz Auto Man
Freq Offset 0.00000000 Hz
Signal Track On Off

File Operation Status, C:\TEMP.GIF file saved

Agilent

R T

Freq/Channel

FCC ID:A3LGT57562 Band Edge Ch.512

Ref 30 dBm Atten 40 dB

#Avg
Log
10
dB/
Offst
8.81
dB
DI
-13.0
dBm
PAvg
M1 S2
S3 FC
AA
£(f):
f>50k
Swp

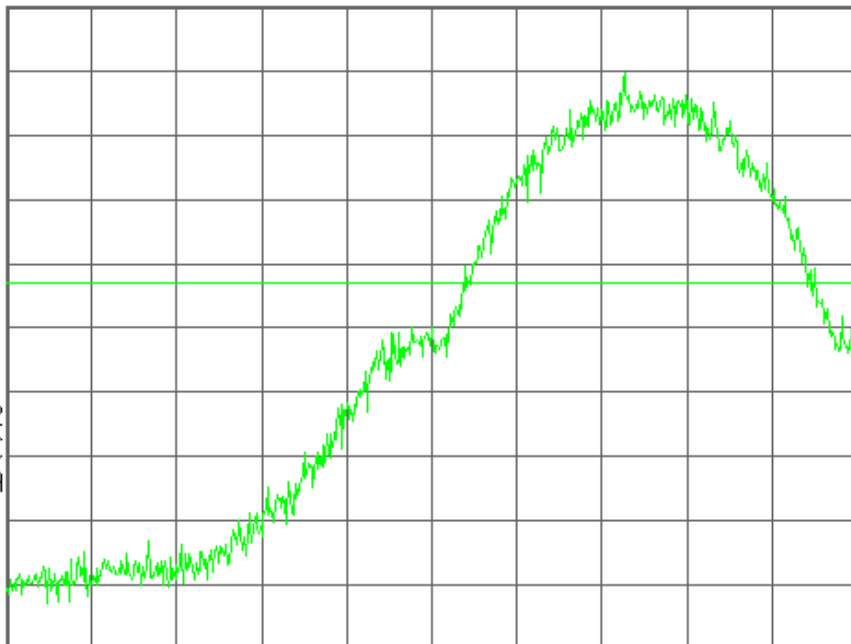

Center 1.850 000 0 GHz Span 810 kHz
#Res BW 3 kHz #VBW 3 kHz Sweep 343.2 ms (601 pts)

Center Freq
1.85000000 GHz

Start Freq
1.84959500 GHz

Stop Freq
1.85040500 GHz

CF Step
81.0000000 kHz
Auto Man

Freq Offset
0.00000000 Hz

Signal Track
On Off

File Operation Status, C:\TEMP.GIF file saved

Agilent

R T

Freq/Channel

FCC ID:A3LGT57562 Band Edge Ch.512

Mkr1 1.849 996 0 GHz

Ref 30 dBm Atten 40 dB

-19.06 dBm

#Avg
Log
10
dB/
Offst
8.81
dB
DI
-13.0
dBm
PAvg
M1 S2
S3 FC
AA
£(f):
f>50k
Swp

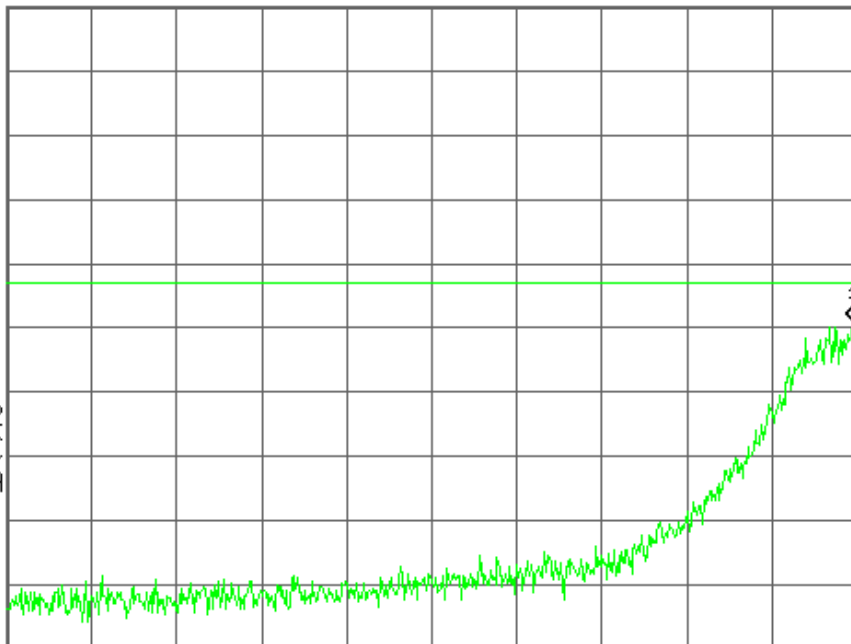

Center 1.849 595 0 GHz Span 810 kHz
#Res BW 3 kHz #VBW 3 kHz Sweep 343.2 ms (601 pts)

Center Freq
1.84959500 GHz

Start Freq
1.84919000 GHz

Stop Freq
1.85000000 GHz

CF Step
81.0000000 kHz
Auto Man

Freq Offset
0.00000000 Hz

Signal Track
On Off

File Operation Status, C:\TEMP.GIF file saved

Agilent

R T

Freq/Channel

FCC ID:A3LGT\$7562 Band Edge Ch.810

Ref 30 dBm Atten 40 dB

#Avg

Log

10

dB/

Offst

8.83

dB

DI

-13.0

dBm

PAvg

M1 S2

S3 FC

AA

£(f):

f>50k

Swp

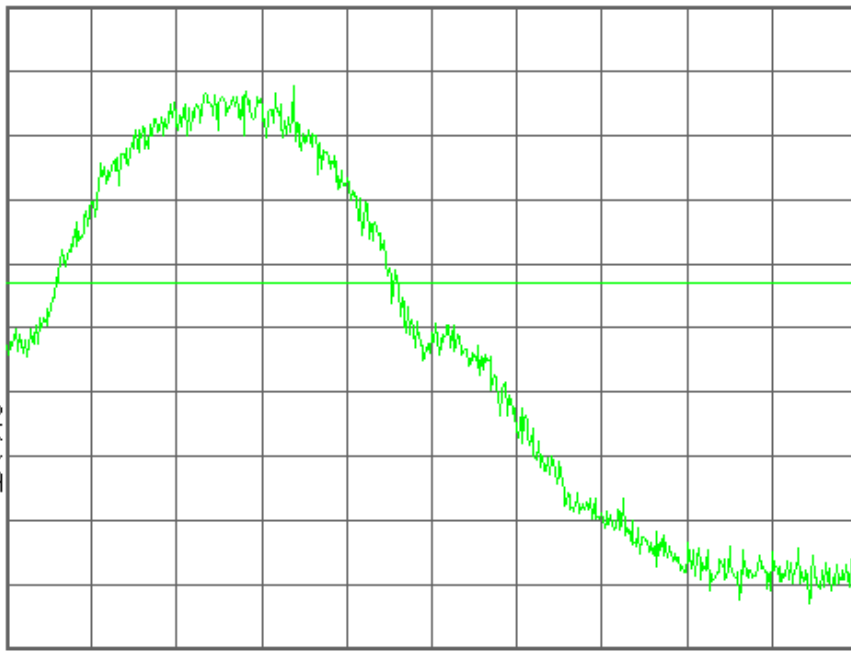

Center 1.910 000 0 GHz

Span 810 kHz

#Res BW 3 kHz

#VBW 3 kHz

Sweep 343.2 ms (601 pts)

Center Freq
1.91000000 GHz

Start Freq
1.90959500 GHz

Stop Freq
1.91040500 GHz

CF Step
81.0000000 kHz
Auto Man

Freq Offset
0.00000000 Hz

Signal Track
On Off

File Operation Status, C:\TEMP.GIF file saved

Agilent

R T

Freq/Channel

FCC ID:A3LGT\$7562 Band Edge Ch.810

Mkr1 1.910 016 2 GHz

Ref 30 dBm Atten 40 dB

-19.57 dBm

#Avg

Log

10

dB/

Offst

8.83

dB

DI

-13.0

dBm

PAvg

M1 S2

S3 FC

AA

£(f):

f>50k

Swp

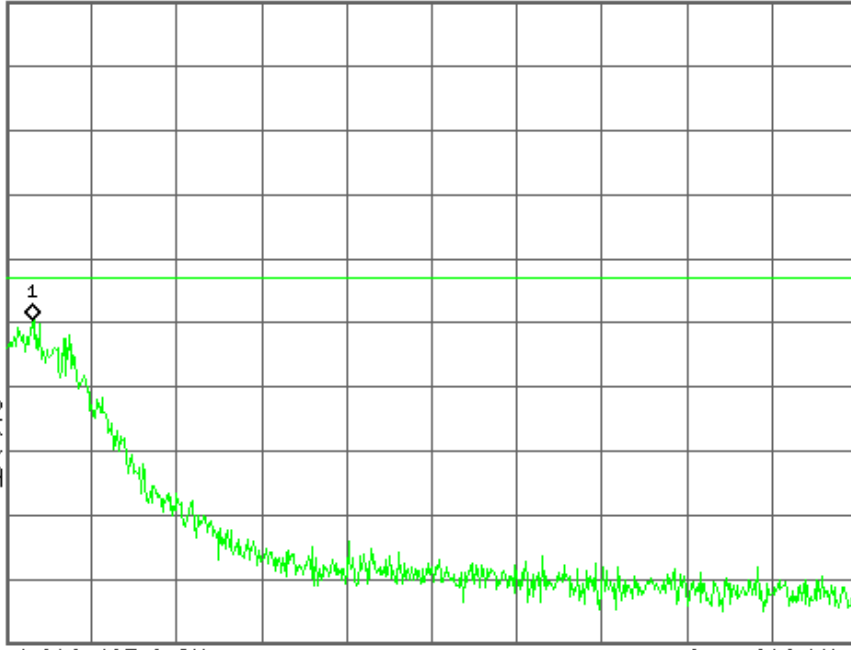

Center 1.910 405 0 GHz

Span 810 kHz

#Res BW 3 kHz

#VBW 3 kHz

Sweep 343.2 ms (601 pts)

Center Freq
1.91040500 GHz

Start Freq
1.91000000 GHz

Stop Freq
1.91081000 GHz

CF Step
81.0000000 kHz
Auto Man

Freq Offset
0.00000000 Hz

Signal Track
On Off

File Operation Status, C:\TEMP.GIF file saved

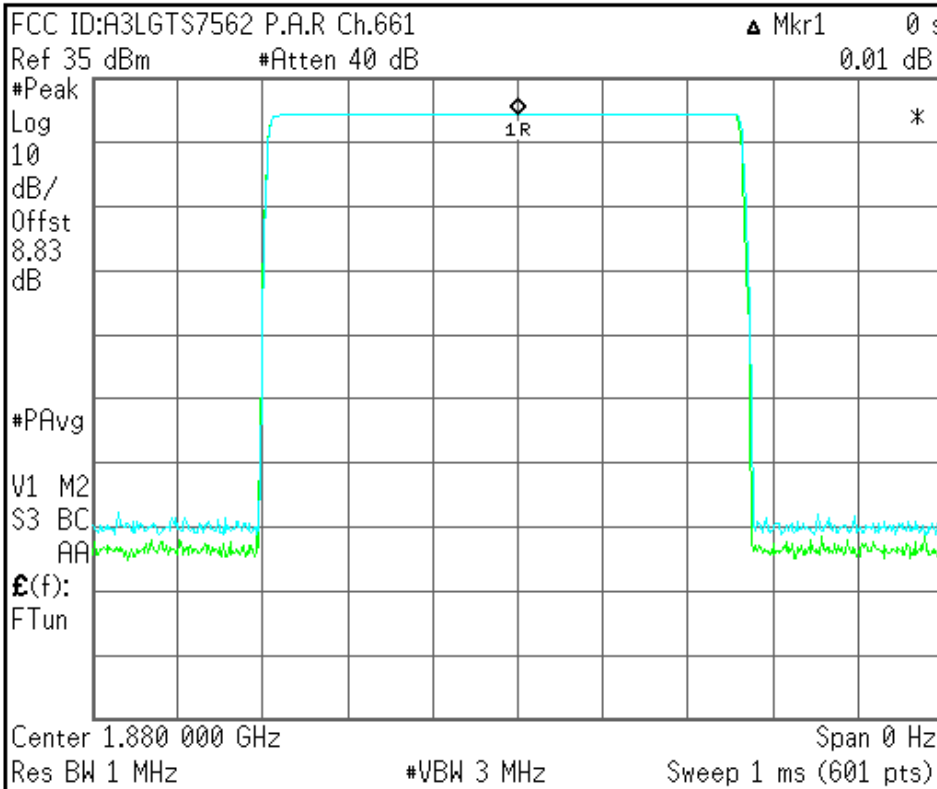

Freq/Channel
Center Freq 1.88000000 GHz
Start Freq 1.88000000 GHz
Stop Freq 1.88000000 GHz
CF Step 1.00000000 MHz Auto Man
Freq Offset 0.00000000 Hz
Signal Track On Off

File Operation Status, C:\TEMP.GIF file saved