



SAMSUNG ELECTRONICS Co., Ltd.,  
Regulatory Compliance Group  
IT R&D Center  
416 Maetan3-Dong,  
Yeongtong-gu, Suwon city,  
Gyeonggi-Do, Korea 443-742

## FCC CFR47 PART 22 SUBPART CERTIFICATION REPORT

Model Tested: GT-S7500T  
FCC ID (Requested): A3LGTS7500T  
Report No: FJ-189-R2  
Job No: FJ-189  
Date issued: Aug 23, 2012

- Abstract -

All measurement reported here in accordance with FCC Rules, 47CFR  
Part2, Part22

**Prepared By**

---

HK LEE – Test Engineer

**Authorized By**

---

WT JANG – Technical Manager

© Copyright SAMSUNG Electronics 2012



# TABLE OF CONTENT

<b>MEASUREMENT REPORT</b>	<b>Page</b>
<b>1. FCC Certification Information</b> .....	<b>3</b>
1.1 §2.1033 General Information .....	3
<b>2. INTRODUCTION</b> .....	<b>4</b>
2.1 General .....	4
<b>3. MEASURING INSTRUMENT CALIBRATION</b> .....	<b>5</b>
<b>4. TEST EQUIPMENT LIST</b> .....	<b>6</b>
<b>5. FCC 3G MEASUREMENT PROCEDURES</b> .....	<b>7</b>
5.1 Effective Radiated Power / Equivalent Isotropic Radiated Power .....	8
5.2 Radiated Spurious & Harmonic Emission .....	9
5.3 Occupied Bandwidth .....	11
5.4 Peak-Average Ratio .....	11
5.5 Spurious and Harmonic Emissions at Antenna Terminal .....	11
5.5.1 Occupied Bandwidth Emission Limits .....	11
5.5.2 Conducted Spurious Emission .....	13
5.6 Frequency Stability / Temperature Variation .....	14
<b>6. TEST DATA</b> .....	<b>15</b>
6.1 Effective Radiated Power(E.R.P.) .....	15
6.2 Cellular WCDMA Radiated Spurious & Harmonic measurement .....	16
6.3 Frequency Stability .....	17
6.3.1 Cellular WCDMA Frequency Stability Table .....	17
6.3.2 Cellular WCDMA Frequency Stability Graph .....	18
<b>7. SAMPLE CALCULATION</b> .....	<b>20</b>
7.1 Emission Designator .....	20
<b>8. CONCLUSION</b> .....	<b>21</b>
<b>9. TEST PLOT</b> .....	<b>22</b>



# MEASUREMENT REPORT

## 1. FCC Certification Information

The following information is in accordance with FCC Rules, 47CFR Part2, Subpart J, Sections 2.1033 – 2.1055.

### 1.1 §2.1033 General Information

- Applicant Name: SAMSUNG ELECTRONICS CO., LTD.
- Address: 416 Maetan3-Dong, Yeongtong-gu, Suwon City  
Gyeonggi-Do, Korea 443-742
  
- FCC ID: A3LGTS7500T
- Model: GT-S7500T
- Quantity: Quantity production is planned
- Emission Designators: 4M23F9W(Cellular WCDMA)
- Tx Freq. Range: 826.4 - 846.6 MHz (Cellular WCDMA)
  
- Rx Freq. Range: 871.4 - 891.6 MHz (Cellular WCDMA)
  
- Max. Power Rating: 0.073 W Cellular WCDMA (18.63 dBm)
  
- FCC Classification(s): Licensed Non-Broadcast Transmitter Held to Ear(TNE)
  
- Equipment (EUT) Type: Portable Handset
- Device Capabilities: 850/1900 GSM/GPRS and Cellular WCDMA/HSDPA Phone  
with Bluetooth, EDGE Rx only and WLAN
- Modulation(s): WCDMA
- Frequency Tolerance:  $\pm 0.00025\%$  (2.5ppm)
- FCC Rule Part(s): §22(H), §2.
- Dates of Test: July 16-17, 2012
- Place of Test: SAMSUNG Lab,
- Test Report S/N: FJ-189-R2

## 2. INTRODUCTION

### 2.1 General

These measurement test were conducted at **SAMSUNG ELECTRONICS CO., LTD(SUWON)**.  
The site address is 416 Maetan3-Dong, Yeongtong-gu, Suwon City, Gyeonggi-Do, Korea 443-742  
The site have 1 Fully-anechoic chamber and measurement facility.



Figure1. Map of the Suwon City area.

### Measurement Procedure

The radiated and spurious measurements were made Fully-anechoic chamber at a 3-meter test range (see Figure2). The equipment under testing was placed on the rotating device at the same height and at a distance of 3-meters from the receive antenna. The rotating device which can rotate horizontal axis was mounted on the turn unit to facilitate rotation around a vertical axis. The measurement was made for each horizontal/vertical position combination with receive antenna horizontally polarized. This measurement was repeated with receive antenna vertically polarized. The substitution antenna will replace the EUT antenna it the same position and in vertical polarization. The frequency of the signal generator shall be set to the frequencies that were measured on the EUT. The signal generator, output level, shall be adjusted until an equal or a known related level to what was measured from the EUT is obtained in the spectrum analyzer. This level was recorded. For readings above 1 GHz, the above procedure is repeated using horn antennas and the difference between the gain of the horn and an isotropic antenna are taken into consideration.



Figure2. Photograph of 3m Fully-Anechoic Chamber

### **3. MEASURING INSTRUMENT CALIBRATION**

The measuring equipment, which was utilized in performing the tests documented herein, has been calibrated in accordance with the manufacturer's recommendations for utilizing calibration equipment, which is traceable to recognized national standards.

- End of page -

#### 4. TEST EQUIPMENT LIST

Name Of Equipment	Model	Serial No.	Due Date
Spectrum Analyzer	ESI26	836119/010	2012-10-25
	E4440A(3Hz~26.5GHz)	MY46187454	2013-03-14
	E4440A(3Hz~26.5GHz)	MY41000236	2013-04-26
Signal Generator	SMR20	835197/030	2012-12-01
Network Analyzer	8753E	JP38160590	2013-06-19
Pre-Amplifier	8449B	3008A00691	2012-12-09
Communication test set	E5515C	MY47510060	2013-03-05
	E5515C	GB42360886	2012-09-02
Controller	CO2000	CO2000/424	Not Required
Turn Unit	CT0800	CT0800/057	Not Required
Rotating Device	DE3600-RH-PR	DE3600-RH-PR/050	Not Required
Antenna Master	MA4000	MA4000/204	Not Required
Horn Antenna	HF906	100134	2013-09-05
	BBHA9120	9120D-637	2013-09-14
Dipole Antenna	UHA 9105	9105-2412	2013-09-09
	UHA 9105	9105-2412	2013-09-09
Receive Antenna	HL040	353255/019	2013-09-05
Power Supply	E3640A	MY40003594	2013-06-19
	E3640A	MY40003595	2013-05-16
	E3632A	MY40022438	2013-03-02
Divider	11636B	58456	2013-04-03
	11636B	51942	2013-07-11
	11636B	58459	2013-04-03
	11636B	56918	2012-09-28
High Pass Filter	WHK/3.0/18G-10SS	492	2013-04-09
	WHK/3.5/18G-10SS	4	2013-04-09
Environmental Chamber	SH-241	92000548	2012-11-14
	SH-241	92000549	2012-11-14
Shielded Fully Anechoic Chamber	CHAMBER	ANT0001	Not Required

## **5. FCC 3G MEASUREMENT PROCEDURES**

The maximum output power is a measure of the maximum power the UE can transmit (i.e. the actual power as would be measured assuming no measurement error) in a band width of at least  $(1+\alpha)$  times the chip rate of the radio access mode

The default test configuration is configure an established radio link between the UE and a communication test set using a 12.2kbps RMC (reference measurement channel) configured in Test Loop Mode 1. Maximum output is verified according to 3GPP TS 34.121 Section 5.2

1. Configure TCP (Transmit Power Control) set to "All 1"s.
2. RMC and AMR connections at 12.2kbps are measured under 3.4kbps SRB (signaling radio bearer)
3. Measure the mean power of the UE in a bandwidth of at least  $(1+\alpha)$  times the chip rate of the radio access mode. The mean power shall be averaged over at least one timeslot.

## 5.1 Effective Radiated Power / Equivalent Isotropic Radiated Power

### Test Set-up for the ERP/EIRP TEST

Effective Radiated Power Output and Equivalent Isotropic Radiated Power output Measurements by Substitution Method according to ANSI/TIA/EIA-603-C-2004

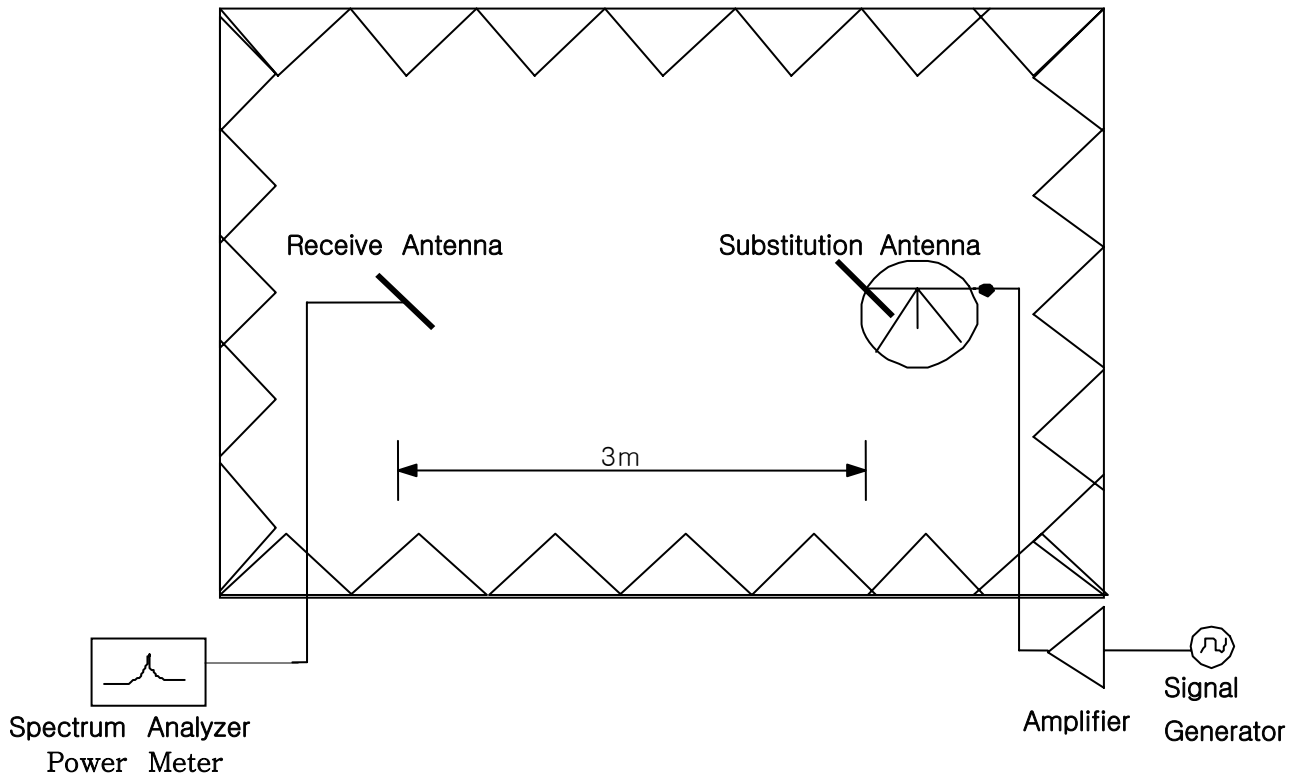

**Figure 3. Diagram of ERP/EIRP test Set-up**

The EUT was placed on the rotating device at 3-meters from the receive antenna and tested in 3 orthogonal planes. The turn unit and rotating device was adjusted for the highest reading on the receive spectrum analyzer. For GSM signals, an average detector is used, with RBW=VBW=5MHz, SPAN=10MHz. A half-wave dipole was substituted in place of the EUT. This dipole antenna and Horn antenna was driven by a signal generator and the level of the signal generator was adjusted to obtain the same receive spectrum analyzer reading. The conducted power at the terminals of dipole is measured. The ERP and EIRP are recorded. For readings above 1GHz, the above procedure is repeated using horn antennas and the difference between the gain of the horn and an isotropic or dipole antenna are taken into consideration.

## 5.2 Radiated Spurious & Harmonic Emission

### Test Set-up for the Radiated Emission TEST

Radiated Spurious Emission Measurements by Substitution Method according to ANSI/TIA/EIA-603-C-2004

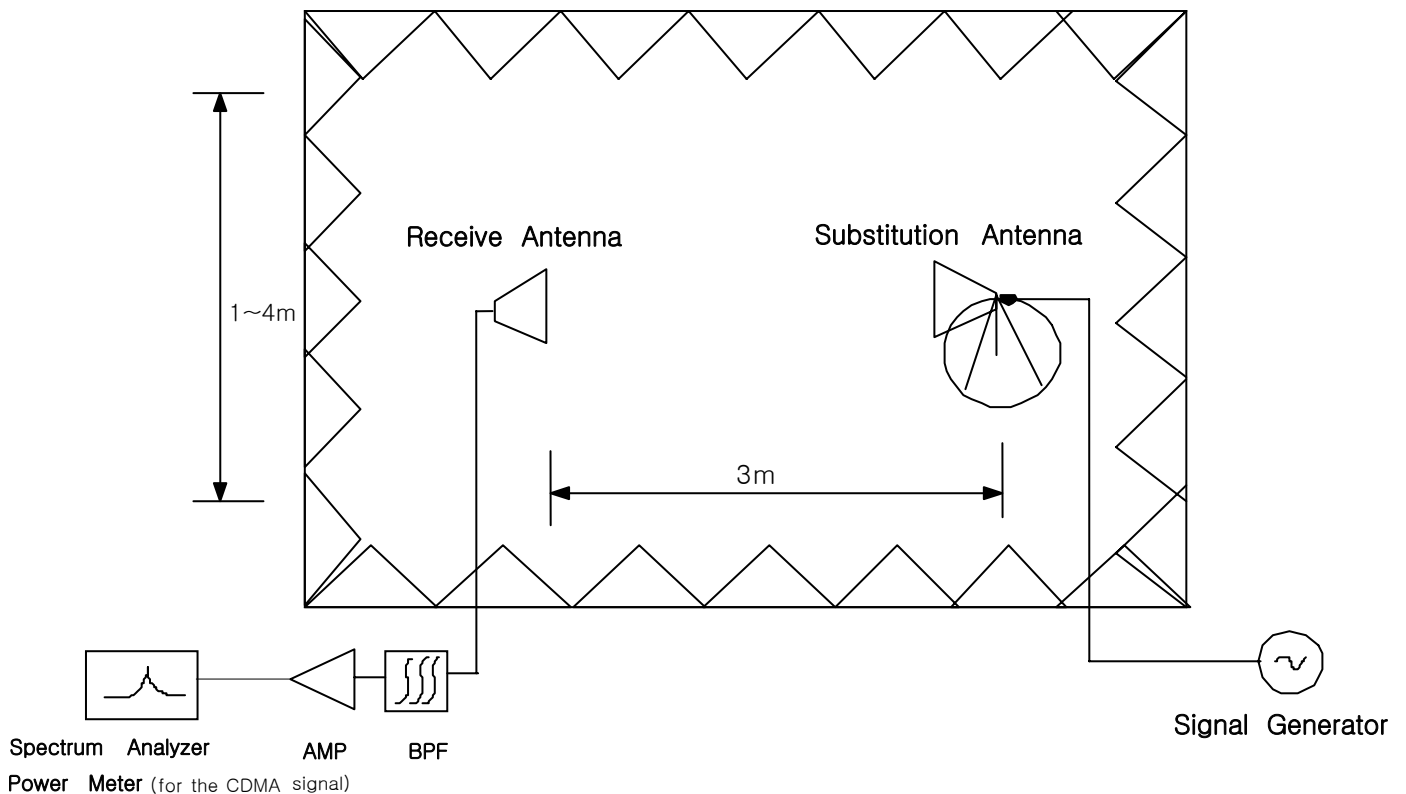

**Figure 4. Diagram of Radiated Spurious & Harmonic test Set-up**

The EUT was placed on the rotating device at 3-meters from the receive antenna and tested in 3 orthogonal planes. The turn unit and rotating device was adjusted for the highest reading on the receive spectrum analyzer. The Spectrum was investigated from 30MHz to the 10<sup>th</sup> Harmonic of the fundamental. A peak detector is used, with RBW=VBW=1MHz. The value that we could measure was only reported. A half-wave dipole was substituted in place of the EUT. This dipole antenna was driven by a signal generator and the level of the signal generator was adjusted to obtain the same receive spectrum analyzer reading. This spurious level is recorded. For readings above 1GHz, the above procedure is repeated using horn antennas and the difference between the gain of the horn and an isotropic or dipole antenna are taken into consideration.

### SAMPLE CALCULATION

#### Example: Channel 600 PCS Mode 2<sup>nd</sup> Harmonic(3760MHz)

The receive analyzer reading at 3meters with the EUT on the turntable was  $-81.0\text{dBm}$ . The gain of the substituted antenna is  $8.1\text{dBi}$ . The signal generator connected to the substituted antenna terminals is adjusted to produce a reading of  $-81.0\text{dBm}$  of the receive analyzer. The loss of the cable between the signal generator and the terminals of the substituted antenna is  $2.0\text{dB}$  at  $3760\text{MHz}$ . So  $6.1\text{dB}$  is added to the signal generator reading of  $-30.9\text{dBm}$  yielding  $-24.8\text{dBm}$ . The fundamental EIRP was  $25.5\text{dBm}$  so this harmonic was  $25.5\text{dBm} - (-24.8) = 50.3\text{dBc}$ .

- End of page -

#### ※ RF conduction Test set-up

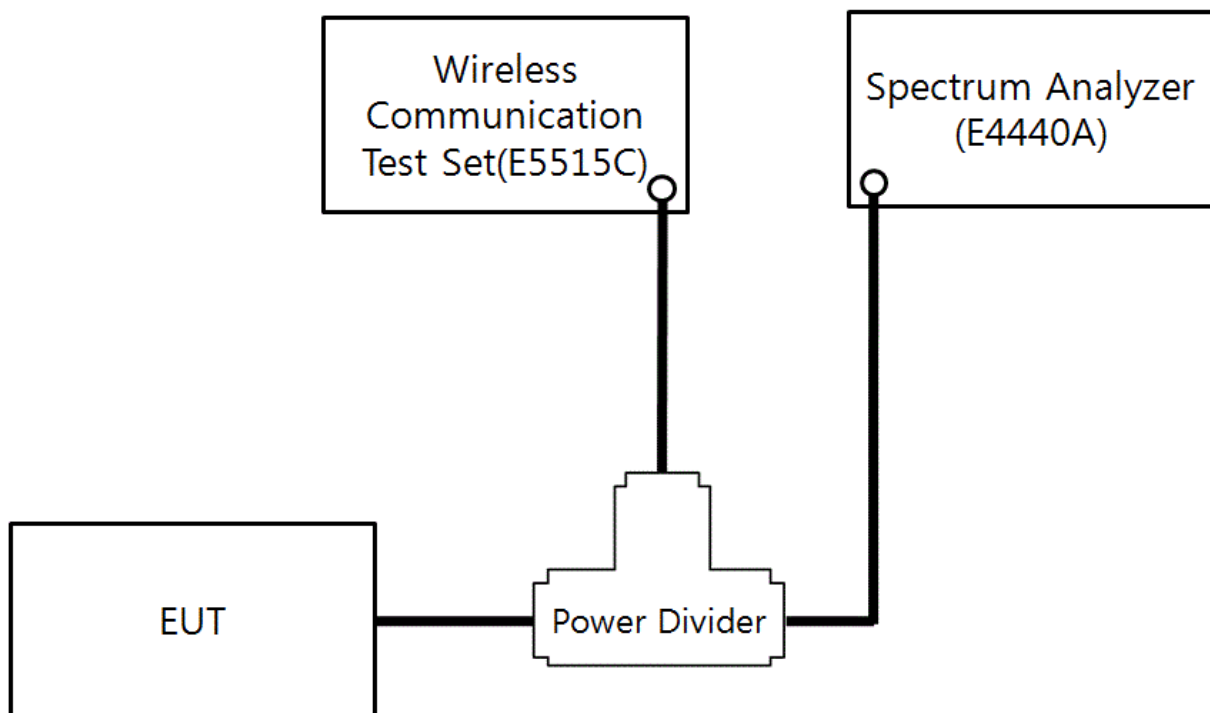

## 5.3 Occupied Bandwidth

### **Test Procedure**

The EUT was setup to maximum output power at its lowest channel. The occupied bandwidth was measured using a spectrum analyzer. The measurements are repeated for the highest and a middle channel. The EUT's occupied bandwidth is measured as the width of the signal between two points, one below the carrier center frequency and one above the carrier frequency, outside of which all emissions are attenuated at least 26dB below the transmitter power.

Plots of the EUT's occupied bandwidth are shown herein.

## 5.4 Peak-Average Ratio

A peak to average ratio measurement is performed at the conducted port of the EUT. For WCDMA signals, the spectrum analyzers Complementary Cumulative Distribution Function(CCDF) measurement profile is used to determine the largest deviation between the An average and the peak power of the EUT in a given bandwidth. The CCDF curve shows how much time the peak waveform spends at or above a given average power level. The percent of time the signal spends at or above the level defines the probability for that particular power level. For GSM signals, and a peak trace are used on a spectrum analyzer to determine the largest deviation between the average and the peak power of the EUT in a given bandwidth.

## 5.5 Spurious and Harmonic Emissions at Antenna Terminal

### 5.5.1 Occupied Bandwidth Emission Limits

- (a) The level of the carrier and the various conducted spurious and harmonic frequencies is measured by means of a calibrated spectrum analyzer. The spectrum is scanned from the lowest frequency generated in the equipment up to a frequency including its 10<sup>th</sup> harmonic
- (b) On any frequency outside a licensee's frequency block, the power of any emission shall be attenuated below the transmitter power (P) by at least  $43 + 10 \log(P)$  dB
- (c) Compliance with these provisions is based on the use of measurement instrumentation employing a resolution bandwidth of 1 MHz or greater. However, in the 1MHz bands immediately outside and adjacent to the frequency block a resolution bandwidth of at least one percent of the emission bandwidth of the fundamental emission of the transmitter may be employed. The emission bandwidth is defined as the width of the signal between two points, one below the carrier center frequency and one above the carrier center frequency, outside of which all emission are attenuated at least 26 dB below the transmitter power.

- End of page -



BLOCK	Freq. Range (MHz) Transmitter (Tx)	Freq. Range (MHz) Receiver (Rx)
A	1850 – 1865	1930 – 1945
B	1870 – 1885	1950 – 1965
C	1895 – 1910	1975 – 1990
D	1865 – 1870	1945 – 1950
E	1885 – 1890	1965 – 1970
F	1890 – 1895	1970 – 1975

**Table 1. Broadband PCS Service Frequency Blocks**

BLOCK	Freq. Range (MHz) Transmitter (Tx)	Freq. Range (MHz) Receiver (Rx)
A* Low + A	824 – 835	869 – 880
B	835 – 845	880 – 890
A* High	845 – 846.5	890 – 891.5
B*	846.5 – 849	891.5 – 894

**Table 2. Cellular Service Frequency Blocks**

BLOCK	Freq. Range (MHz) Transmitter (Tx)	Freq. Range (MHz) Receiver (Rx)
A	1710 – 1720	2110 – 2120
B	1720 – 1730	2120 – 2130
C	1730 – 1735	2130 – 2135
D	1735 – 1740	2135 – 2140
E	1740 – 1745	2140 – 2145
F	1745 – 1755	2145 – 2155

**Table 3. Broadband AWS Service Frequency Blocks**

### 5.5.2 Conducted Spurious Emission

#### **Minimum standard:**

On any frequency outside a license frequency block, the power of any emission shall be attenuated below the transmitter power(P) by at least  $43+10\log (P)$ dB. Limit equivalent to  $-13$ dBm, calculation shown below.

$$43 + 10\log ( 0.333 \text{ W} ) = 38.22\text{dB}$$
$$25.22 \text{ dBm} - 38.22 \text{ dB} = -13 \text{ dBm}$$

#### **Test Procedure:**

The EUT was setup to maximum output power at its lowest channel. The Resolution BW of the analyzer is set to 1% of the emission bandwidth to show compliance with the  $-13$ dBm limit, in the 1MHz bands immediately outside and adjacent to the edge of the frequency block. The measurements are repeated for the EUT's highest channel. For the Out-of-Band measurements a 1MHz RBW was used to scan from 10MHz to 10GHz. (PCS Mode : 10MHz to 20GHz). A display line was placed at  $-13$ dBm to show compliance. The high, lowest and a middle channel were tested for out of band measurements. Plots are shown herein.

## 5.6 Frequency Stability / Temperature Variation

The frequency stability of the transmitter is measured by:

- a.) Temperature: The temperature is carried from  $-30^{\circ}\text{C}$  to  $+50^{\circ}\text{C}$  using an environmental chamber.
- b.) Primary Supply Voltage: The primary supply voltage is varied from 85% to 115% of the voltage normally at the input to the device or at the power supply terminals if cables are not normally supplied.

Specification- The frequency stability shall be sufficient to ensure that the fundamental emission stays within the authorized frequency block. The frequency stability of the transmitter shall be maintained within  $\pm 0.00025$  ( $\pm 2.5\text{ppm}$ ) of the center frequency.

Time Period and Procedure:

1. The carrier frequency of the transmitter and the individual oscillators is measured at room temperature ( $25^{\circ}\text{C}$  to  $27^{\circ}\text{C}$  to provide a reference).
2. The equipment is subjected to an overnight "soak" at  $-30^{\circ}\text{C}$  without any power applied.
3. After the overnight "soak" at  $-30^{\circ}\text{C}$  (Usually 14~16 hours), the equipment is turned on in a "standby" condition for one minute before applying power to the transmitter. Measurement of the carrier frequency of the transmitter and the individual oscillators is made within a three minute interval after applying to the transmitter.
4. Frequency measurements are made at  $10^{\circ}\text{C}$  interval up to room temperature. At least a period of one and one half-hour is provided to allow stabilization of the equipment at each temperature level.
5. Again the transmitter carrier frequency and the individual oscillators is measured at room temperature to begin measurement of the upper temperature levels.
6. Frequency measurements are at 10 intervals starting at  $-30^{\circ}\text{C}$  up to  $+50^{\circ}\text{C}$  allowing at least two hours at each temperature for stabilization. In all measurements the frequency is measured within three minutes after re-applying power to the transmitter.
7. The artificial load is mounted external to the temperature chamber.

NOTE : The EUT is tested down to the battery endpoint.

- End of page -

## 6. TEST DATA

### 6.1 Effective Radiated Power(E.R.P.)

Supply Voltage : 3.7VDC

Modulation : Cellular WCDMA

#### ■ Result

Frequency (MHz)	Tested level [dBm]	Substitute Level [dBm]	Antenna Gain [dBd]	Polarization [H/V]	ERP [dBm]	ERP [W]	Battery
826.4	-20.57	16.67	-1.95	H	14.72	0.030	Standard
836.6	-21.70	17.07	-1.72	H	15.35	0.034	Standard
846.6	-20.04	20.21	-1.58	H	18.63	0.073	Standard

**NOTE :** Standard batteries are the only battery options for this phone

- All modes of operation were investigated, and the worst-case results are reported.

**Radiated measurements at 3 meters by Substitution Method**

## 6.2 Cellular WCDMA Radiated Spurious & Harmonic measurement

Operating Frequency : 826.4 MHz(Low), 836.4 MHz(Middle), 846.6 MHz(High)

Measured Output Power : 18.63 dBm = 0.073 W

Modulation Signal : CDMA

**Limit :  $43 + 10\log_{10}(P) = 31.63$  dBc**

Result(dBc) = Output Power(ERP, dBm) - Spurious Emission Level(dBm)

### Result

Channel	Frequency (MHz)	Level @ Antenna Terminals (dBm)	Substitute Antenna Gain (dBd)	Spurious Emission level (dBm)	POL (H/V)	Result (dBc)
4132	1652.80	-46.10	9.40	-36.70	H	55.33
	2479.20	-57.41	10.60	-46.81	H	65.44
	3305.60	-54.35	12.00	-42.35	H	60.98
	4132.00	-	-	-	-	-
	4958.40	-	-	-	-	-
	5784.80	-	-	-	-	-
4175	1672.80	-51.96	9.40	-42.56	H	61.19
	2509.20	-57.19	10.60	-46.59	H	65.22
	3345.60	-54.12	12.00	-42.12	H	60.75
	4182.00	-	-	-	-	-
	5018.40	-	-	-	-	-
	5854.80	-	-	-	-	-
4233	1693.20	-49.73	9.40	-40.33	H	58.96
	2539.80	-56.15	10.60	-45.55	H	64.18
	3386.40	-52.35	12.00	-40.35	V	58.98
	4233.00	-	-	-	-	-
	5079.60	-	-	-	-	-
	5926.20	-	-	-	-	-

### NOTE :

1. "-" Indicates the spurious emission could not be detected due to noise limitations or ambients.
2. The spectrum is measured from 30MHz to the 10<sup>th</sup> harmonic and All modes of operation were investigated, and the worst-case results are reported..

### Radiated Spurious Emission measurements at 3 meters by Substitution Method

## 6.3 Frequency Stability

### 6.3.1 Cellular WCDMA Frequency Stability Table

Operating Frequency : 836,600,000 Hz

Channel : 4183

Reference Voltage : 3.7VDC

**Deviation Limit :  $\pm 0.00025$  % or 2.5ppm**

Voltage (%)	Power (VDC)	Temp. (°C)	Frequency Error (Hz)	Frequency (Hz)	Deviation (%)	ppm
100%	3.70	+20(Ref)	2.00	836,600,002	0.000000	0.002
100%		-30	14.50	836,600,015	0.000002	0.017
100%		-20	24.80	836,600,025	0.000003	0.030
100%		-10	-43.60	836,599,956	-0.000005	-0.052
100%		0	-37.40	836,599,963	-0.000004	-0.045
100%		+10	21.20	836,600,021	0.000003	0.025
100%		+20	2.00	836,600,002	0.000000	0.002
100%		+30	48.70	836,600,049	0.000006	0.058
100%		+40	39.50	836,600,040	0.000005	0.047
100%		+50	-34.60	836,599,965	-0.000004	-0.041
115%	4.26	+20	-31.70	836,599,968	-0.000004	-0.038
Batt. Endpoint	3.35	+20	26.50	836,600,027	0.000003	0.032

**Note : The temperature is varied from -30 °C to +50 °C using an environmental chamber.**

**The EUT is tested down to the battery end point**

### 6.3.2 Cellular WCDMA Frequency Stability Graph

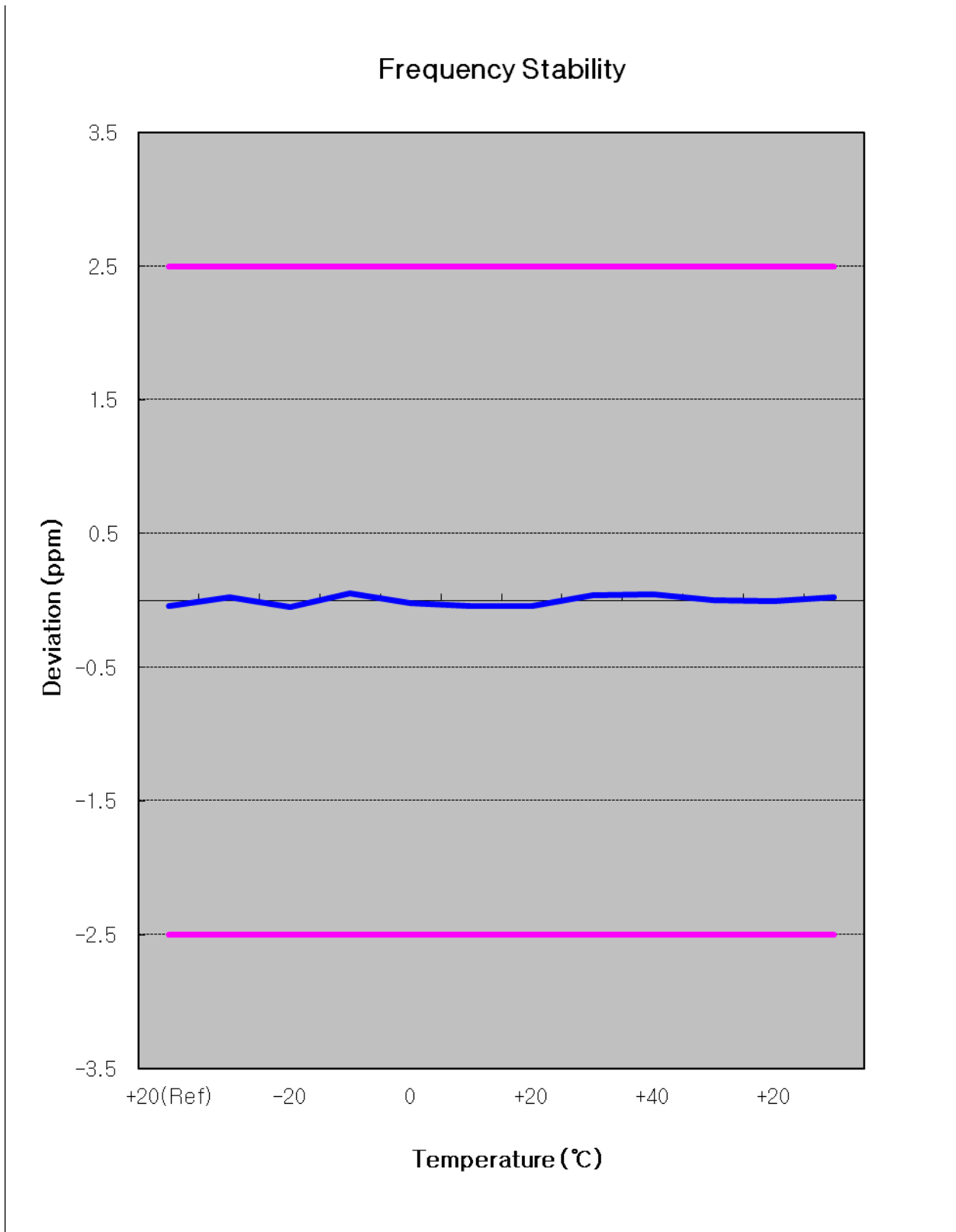

- End of page -

**Zoom In**

### Frequency Stability

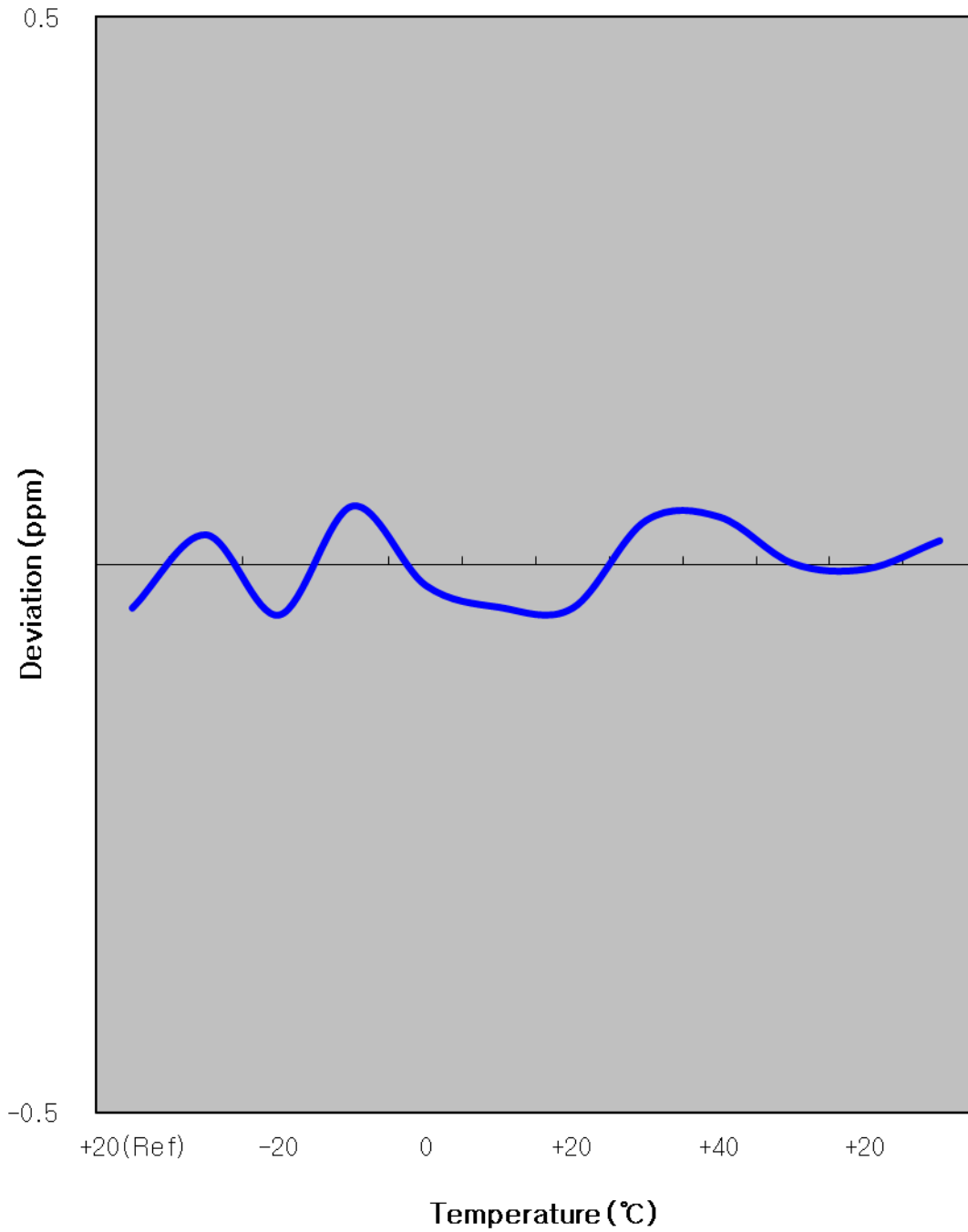

- End of page -

## 7. SAMPLE CALCULATION

### 7.1 Emission Designator

Emission Designator = 4M19F9W

CDMA BW = 4.19MHz

F = Frequency Modulation

9 = Composite Digital Info

W = Combination(Audio/Data)

(Measured at the 99.75% power bandwidth)

- End of page -



## **8. CONCLUSION**

The data collected shows that the SAMSUNG Portable Handset

FCC ID : A3LGTS7500T complies with all the requirements of Parts 2, 22 of the FCC Rules.

- End of page -

## 9. TEST PLOT

× For all frequencies, we measure Ref. offset every 1GHz. And we tested the plots with worst offset of all offset.

1. Spectrum Offset(dB) = Cable loss(dB) + Power divider(dB)
2. Ref Offset at 836.6 MHz = 7.95dBm

A3LGTS7500TBAND 5  
 (UL Channel : 4132, DL Channel : 4357)

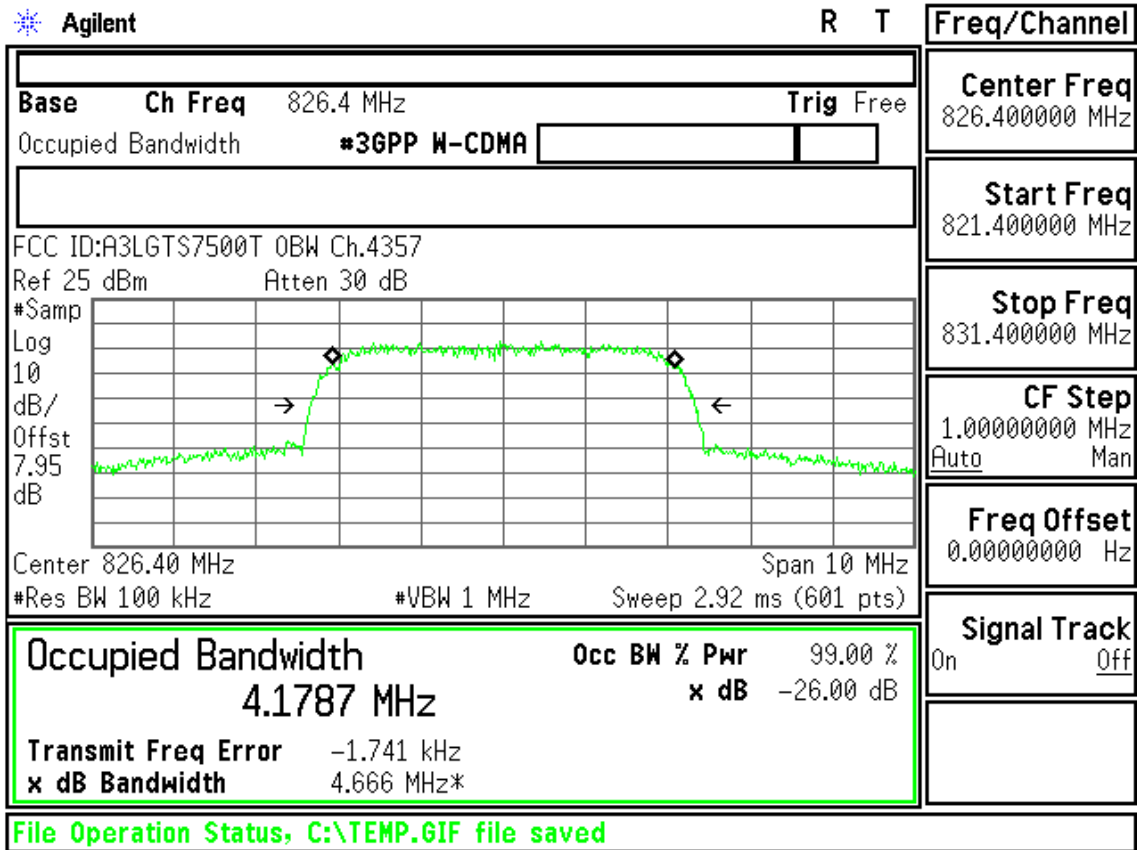

(UL Channel : 4183, DL Channel : 4408)

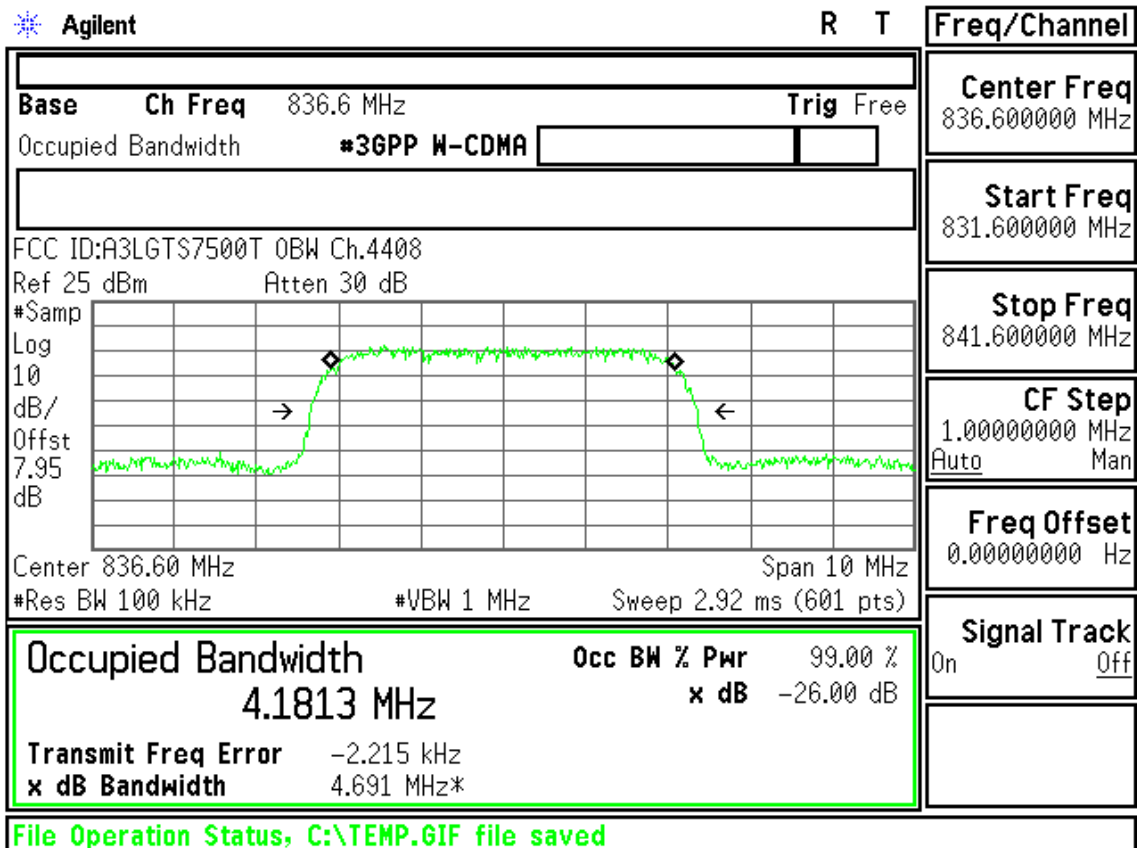

(UL Channel : 4233, DL Channel : 4458)

**Agilent** R T

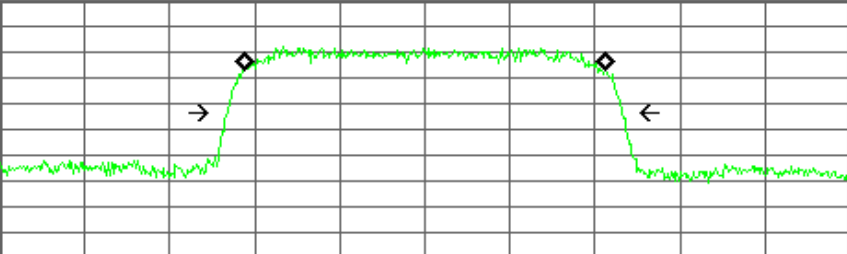
<b>Base</b>	<b>Ch Freq</b> 846.6 MHz	<b>Trig</b> Free	<b>Freq/Channel</b>
Occupied Bandwidth <b>*3GPP W-CDMA</b>			<b>Center Freq</b> 846.600000 MHz
FCC ID:A3LGTS7500T 0BW Ch.4458 Ref 25 dBm Atten 30 dB			<b>Start Freq</b> 841.600000 MHz
<div style="display: flex; align-items: center;"> <div style="writing-mode: vertical-rl; transform: rotate(180deg); font-size: small; margin-right: 5px;">                 #Samp Log 10 dB/ Offst 7.95 dB             </div>  </div>			<b>Stop Freq</b> 851.600000 MHz
Center 846.60 MHz <span style="float: right;">Span 10 MHz</span> #Res BW 100 kHz <span style="margin-left: 100px;">#VBW 1 MHz</span> <span style="float: right;">Sweep 2.92 ms (601 pts)</span>			<b>CF Step</b> 1.00000000 MHz Auto Man
<div style="border: 2px solid green; padding: 5px;"> <b>Occupied Bandwidth</b> <span style="float: right;"><b>Occ BW % Pwr</b> 99.00 %</span>  <span style="font-size: 1.2em;">4.2270 MHz</span> <span style="float: right;"><b>x dB</b> -26.00 dB</span>  <b>Transmit Freq Error</b> -3.013 kHz  <b>x dB Bandwidth</b> 4.649 MHz*                 </div>			<b>Freq Offset</b> 0.00000000 Hz
			<b>Signal Track</b> On Off

File Operation Status, C:\TEMP.GIF file saved

(UL Channel : 4132, DL Channel : 4357)

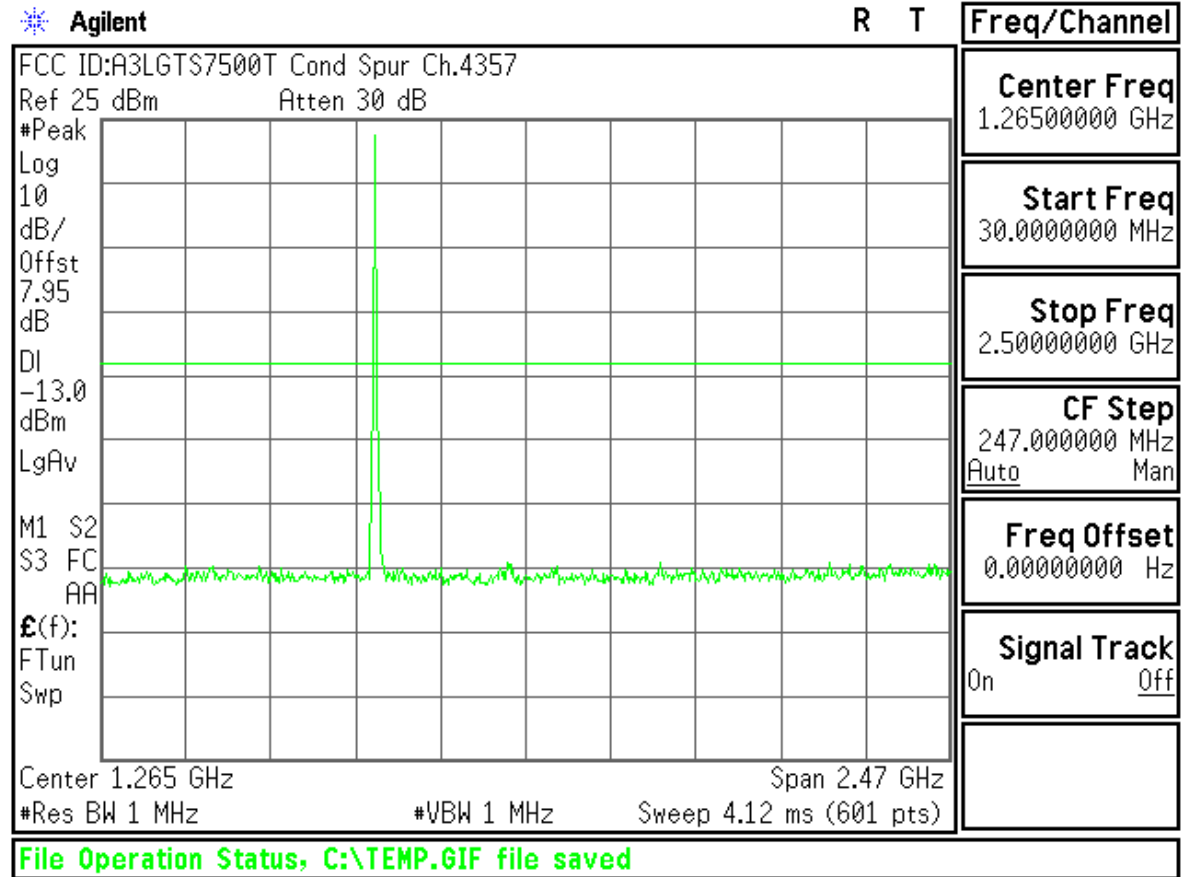

(UL Channel : 4132, DL Channel : 4357)

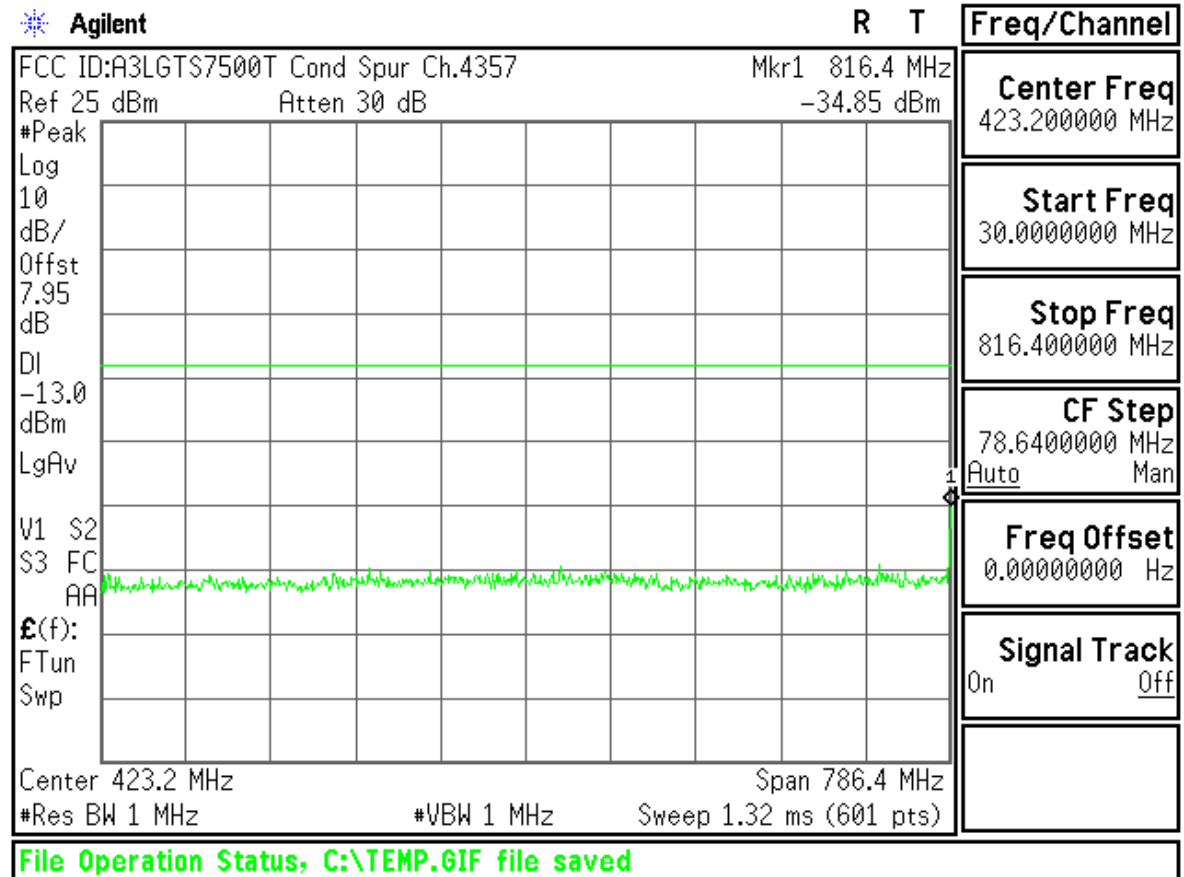

(UL Channel : 4132, DL Channel : 4357)

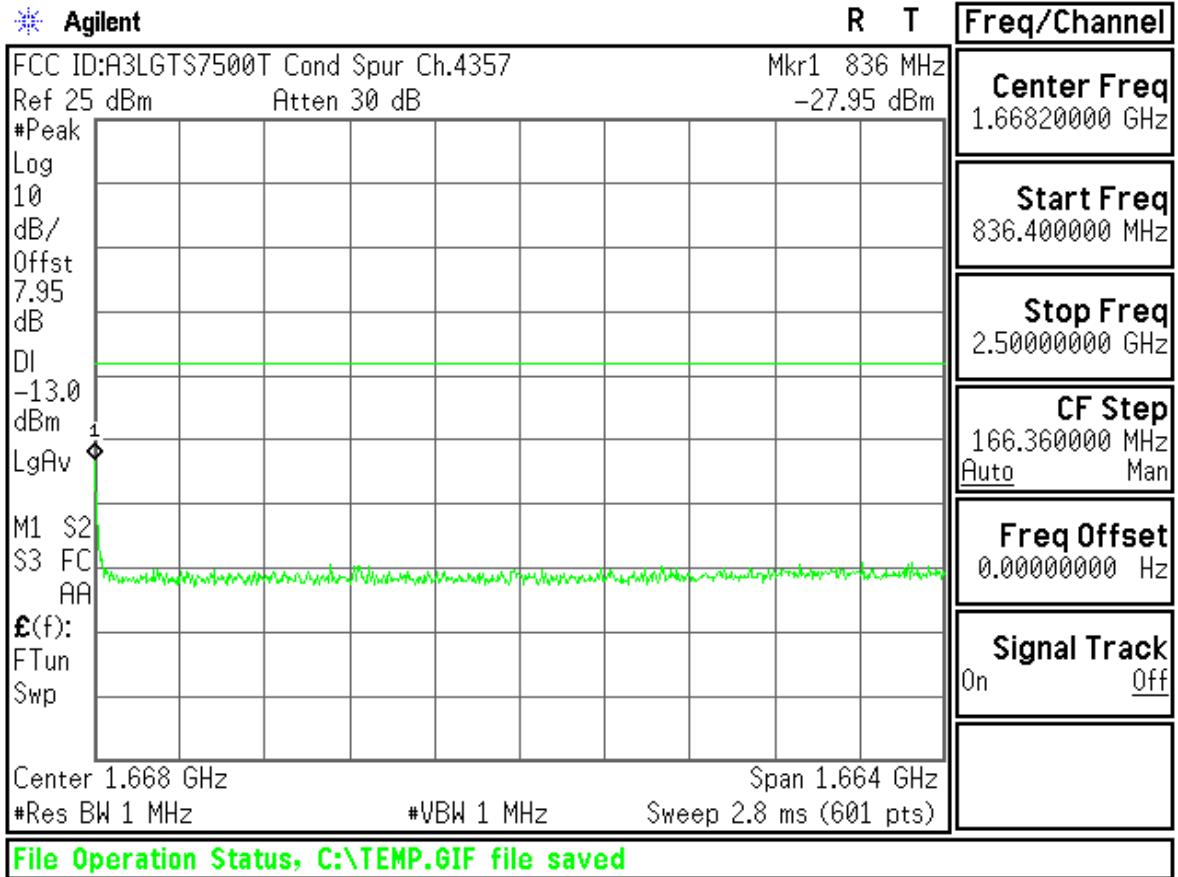

(UL Channel : 4132, DL Channel : 4357)

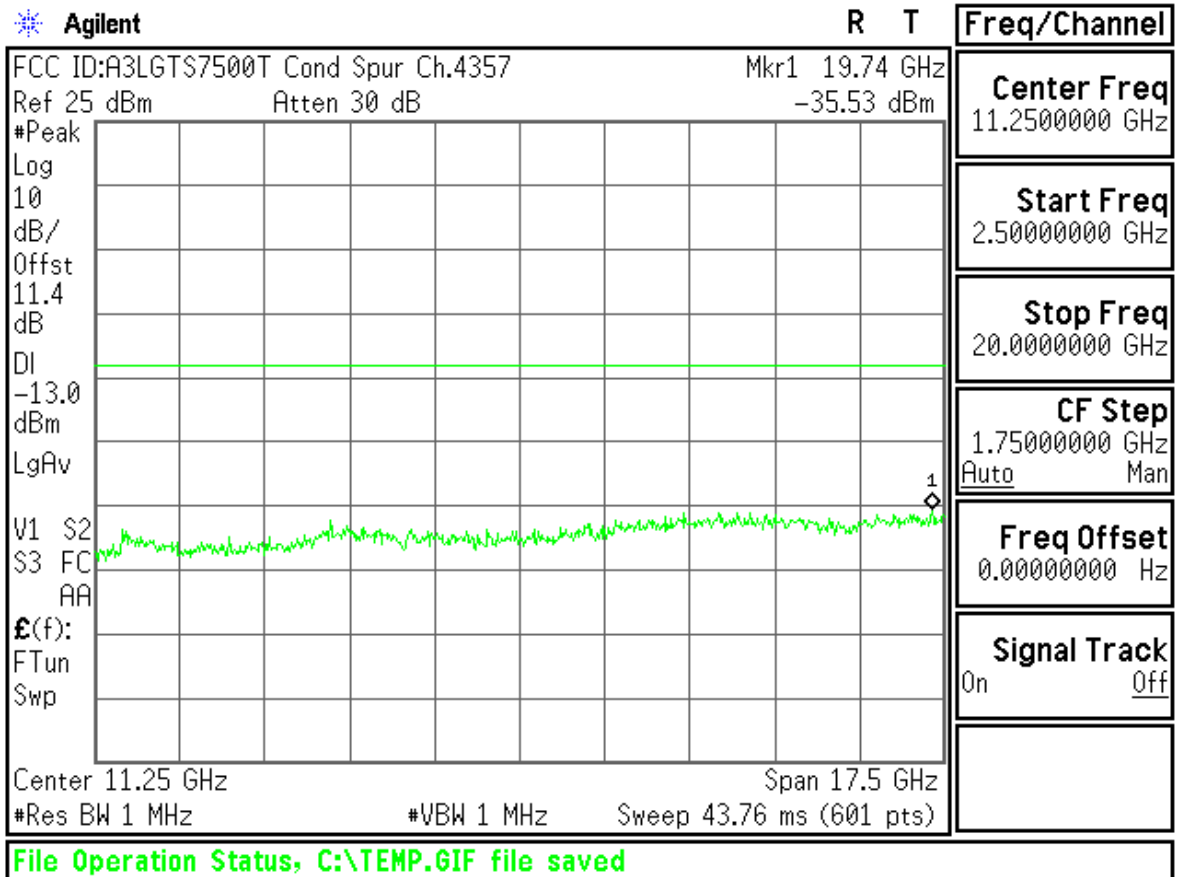

(UL Channel : 4183, DL Channel : 4408)

Agilent

R T

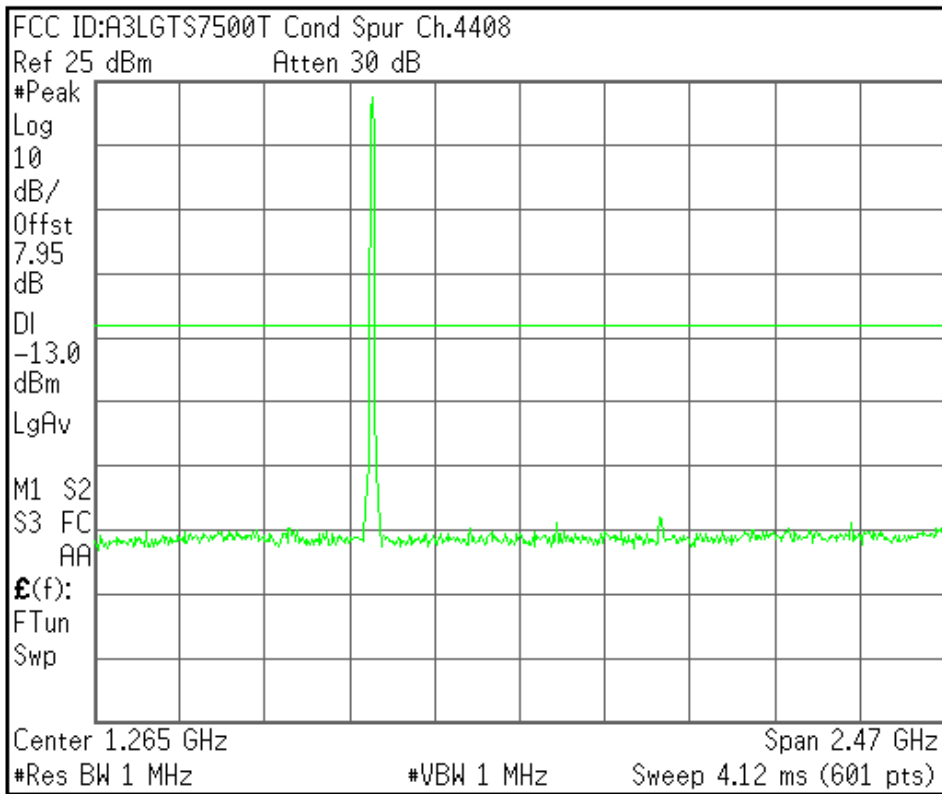

Freq/Channel	
Center Freq	1.26500000 GHz
Start Freq	30.0000000 MHz
Stop Freq	2.50000000 GHz
CF Step	247.000000 MHz Auto Man
Freq Offset	0.00000000 Hz
Signal Track	On Off

File Operation Status, C:\TEMP.GIF file saved

(UL Channel : 4183, DL Channel : 4408)

Agilent

R T

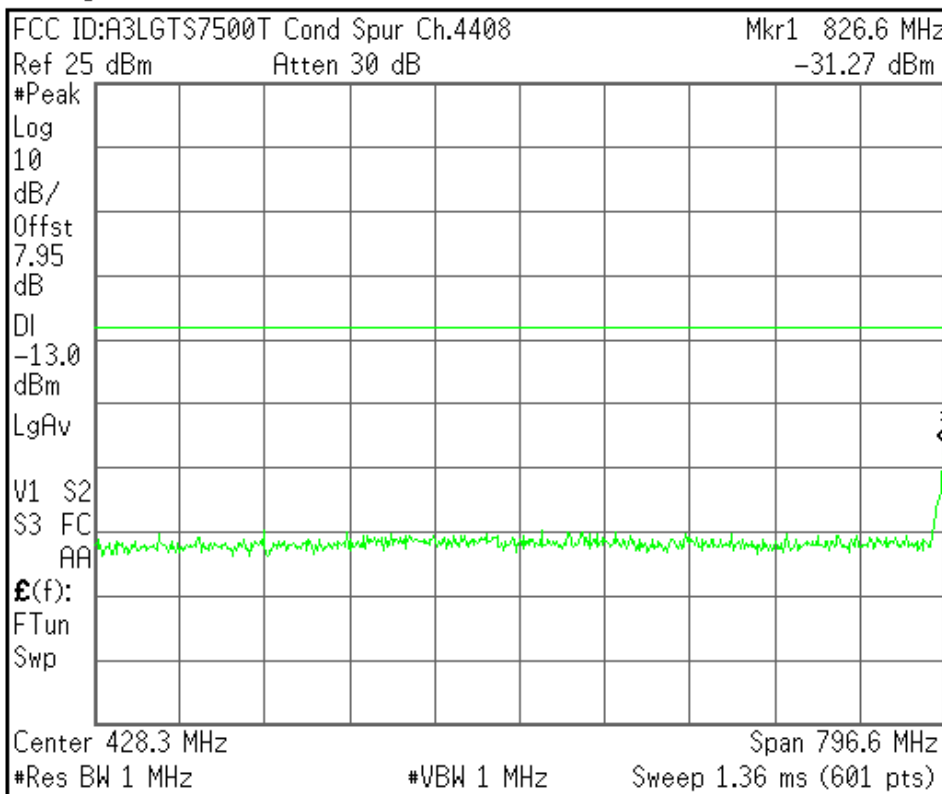

Freq/Channel	
Center Freq	428.300000 MHz
Start Freq	30.0000000 MHz
Stop Freq	826.600000 MHz
CF Step	79.6600000 MHz Auto Man
Freq Offset	0.00000000 Hz
Signal Track	On Off

File Operation Status, C:\TEMP.GIF file saved

(UL Channel : 4183, DL Channel : 4408)

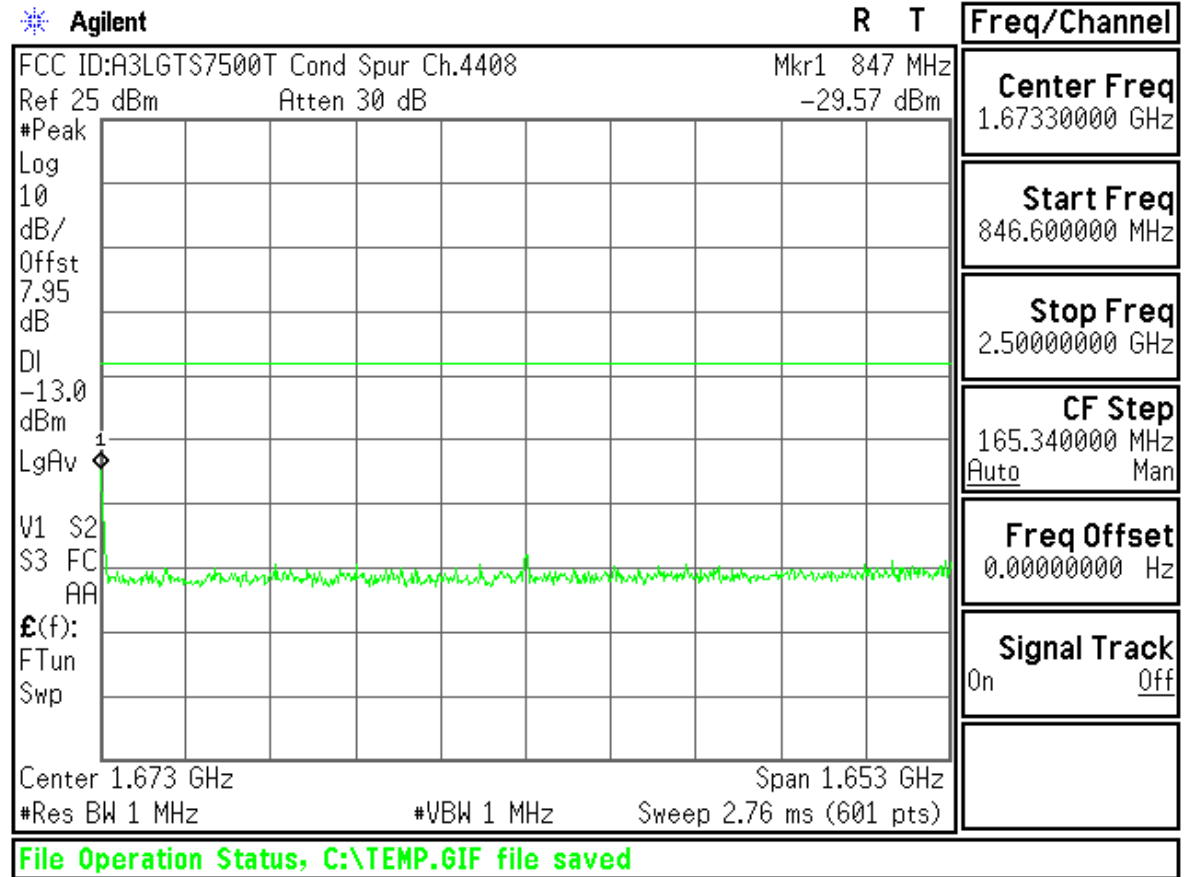

(UL Channel : 4183, DL Channel : 4408)

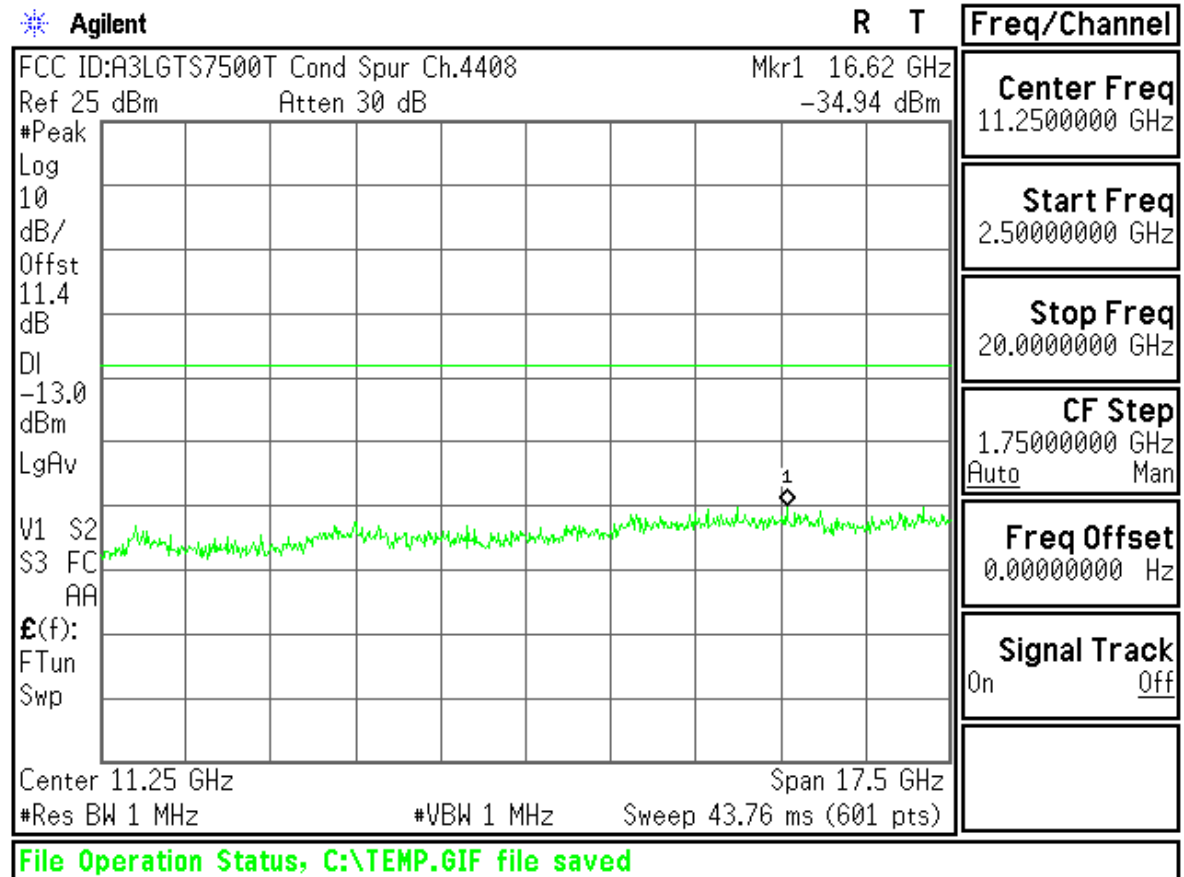

(UL Channel : 4233, DL Channel : 4458)

Agilent

R T

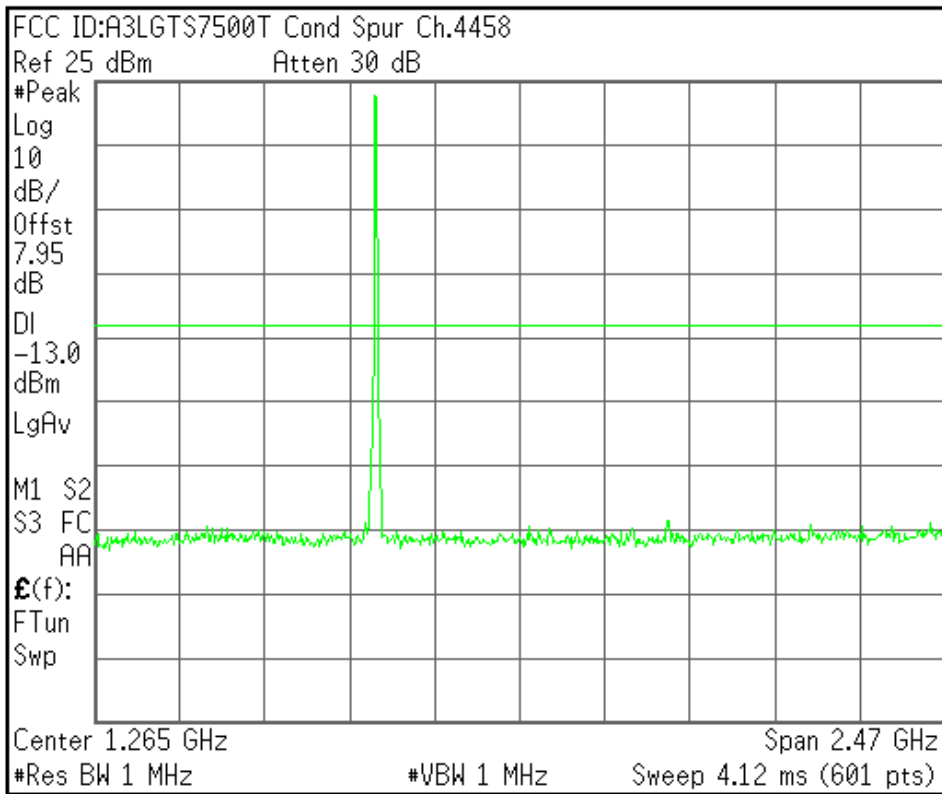

Freq/Channel

Center Freq	1.26500000 GHz
Start Freq	30.0000000 MHz
Stop Freq	2.50000000 GHz
CF Step	247.000000 MHz Auto Man
Freq Offset	0.00000000 Hz
Signal Track	On Off

File Operation Status, C:\TEMP.GIF file saved

(UL Channel : 4233, DL Channel : 4458)

Agilent

R T

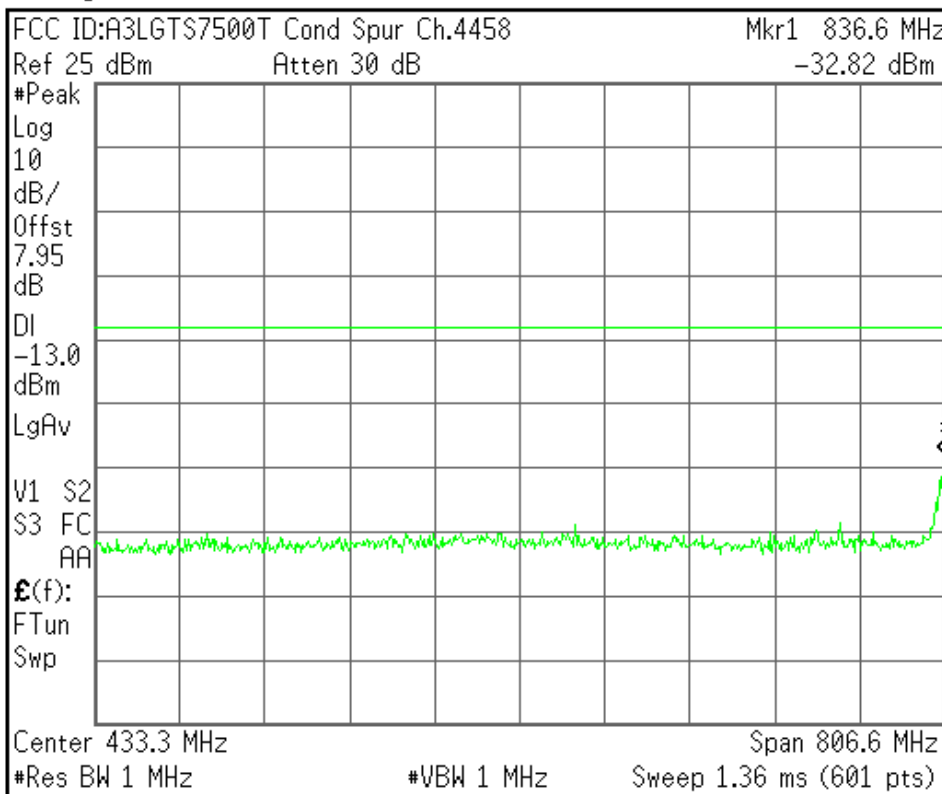

Freq/Channel

Center Freq	433.300000 MHz
Start Freq	30.0000000 MHz
Stop Freq	836.600000 MHz
CF Step	80.6600000 MHz Auto Man
Freq Offset	0.00000000 Hz
Signal Track	On Off

File Operation Status, C:\TEMP.GIF file saved

(UL Channel : 4233, DL Channel : 4458)

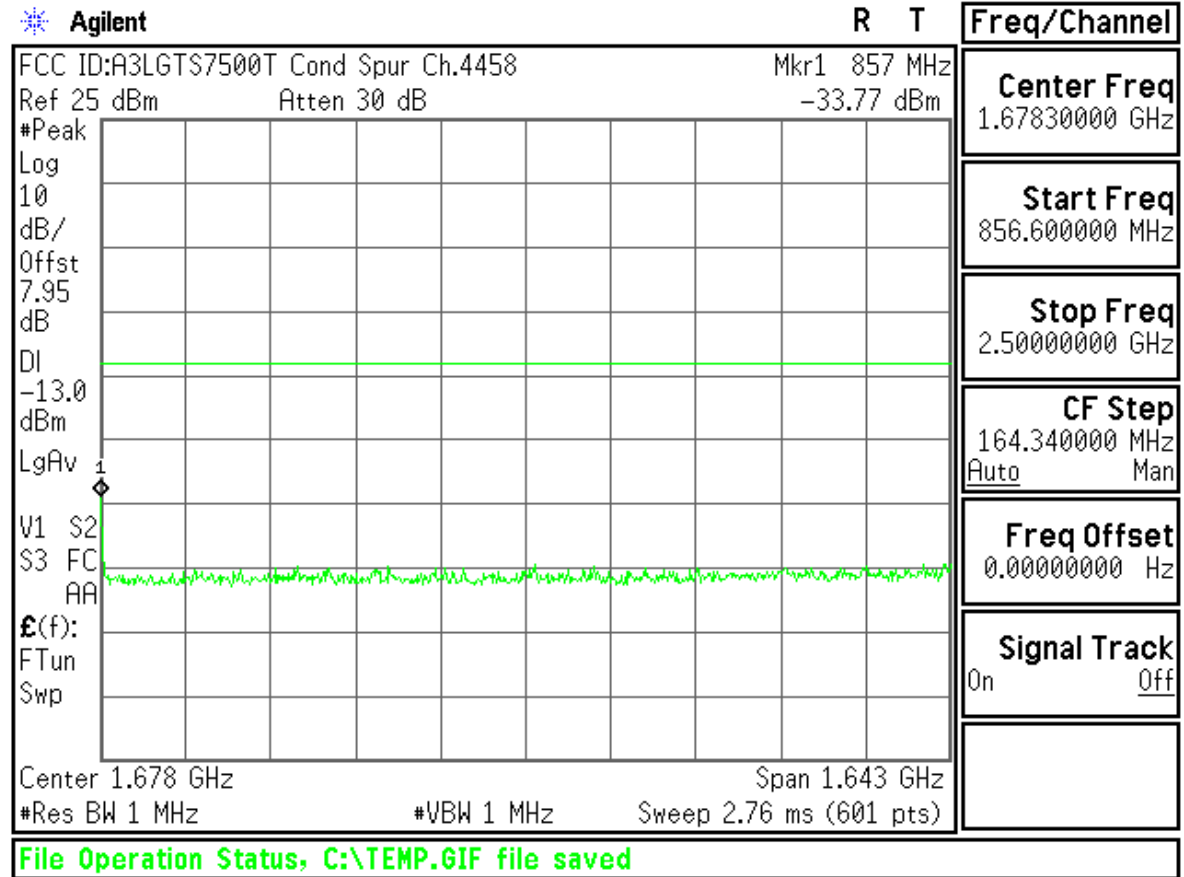

(UL Channel : 4233, DL Channel : 4458)

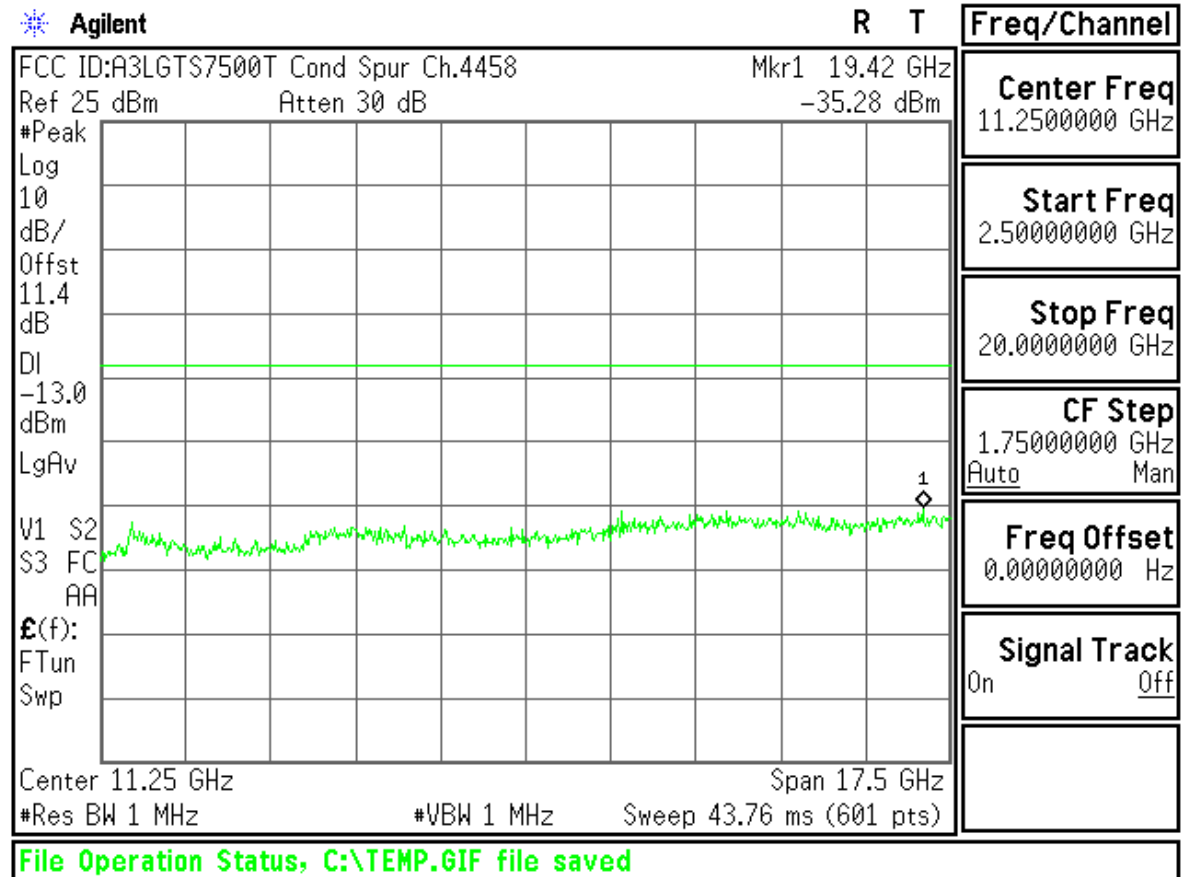

(UL Channel : 4132, DL Channel : 4357)

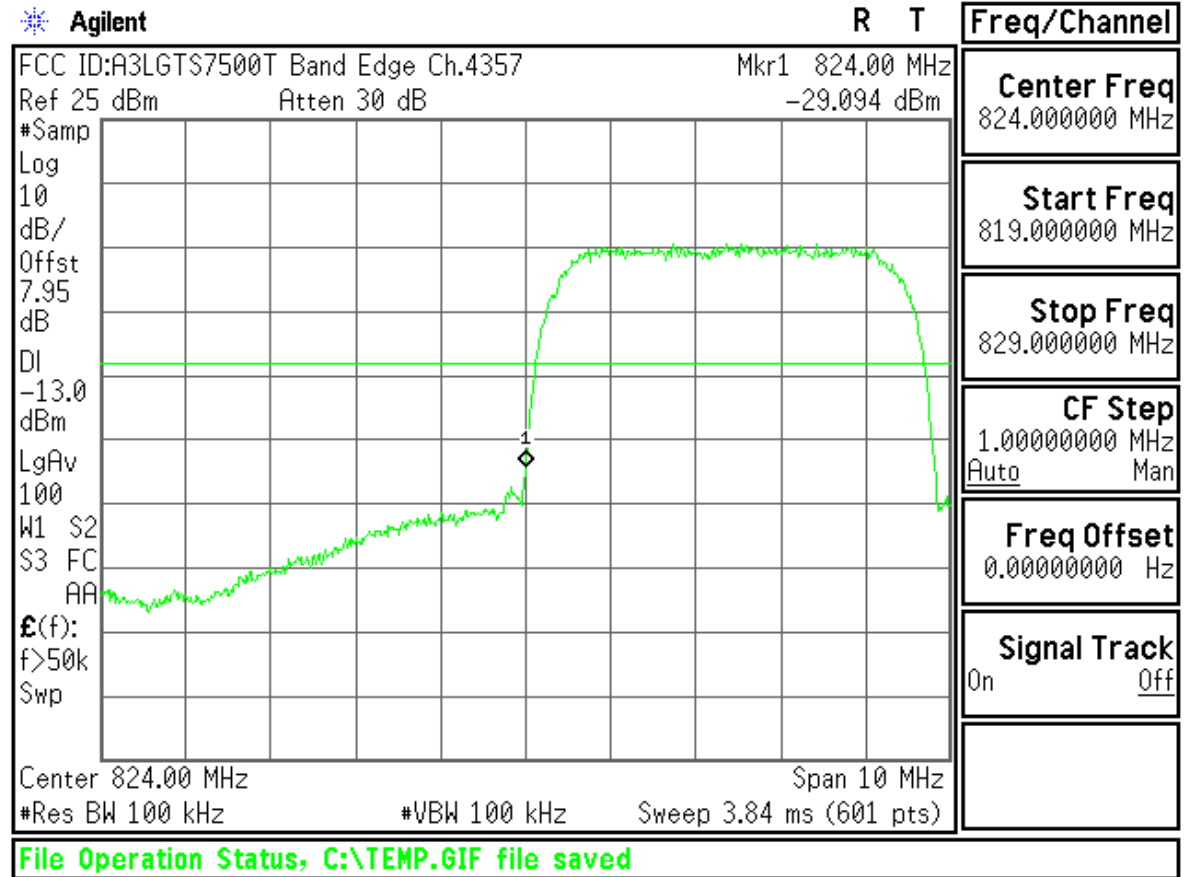

(UL Channel : 4233, DL Channel : 4458)

