



HCT CO., LTD.

CERTIFICATE OF COMPLIANCE FCC Certification

Applicant Name:
SAMSUNG Electronics Co., Ltd.

Address:
129, Samsung-ro, Yeongtong-gu Suwon-si,
Gyeonggi-do, 443-742 Rep. of Korea

Date of Issue:
August 21, 2013
Test Site/Location:
HCT CO., LTD., 105-1, Jangam-ri, Majang-Myeon,
Icheon-si, Kyunggi-Do, Korea
Report No.: HCTR1308FR29
HCT FRN: 0005866421

FCC ID: A3LGTS7392

APPLICANT: SAMSUNG Electronics Co., Ltd.

FCC Model(s): GT-S7392
EUT Type: 850/1900 GSM/GPRS Phone with BT v4.0(LE) , 802.11b/g/n and EDGE Rx only, Hotspot
FCC Classification: Licensed Portable Transmitter Held to Ear (PCE)
FCC Rule Part(s): §22, §24, §2
Tx Frequency: 824.20 - 848.80 MHz (GSM850)
1 850.20 - 1 909.80 MHz (GSM1900)
Rx Frequency: 869.20 - 893.80 MHz (GSM850)
1 930.20 - 1 989.80 MHz (GSM1900)
Max. RF Output Power: 0.185 W ERP GSM850 (22.67 dBm) / 0.818 W EIRP GSM1900 (29.13 dBm)
Emission Designator(s): 245 KGXW (GSM850) 246 KGXW (GSM1900)

The measurements shown in this report were made in accordance with the procedures specified in §2.947. I assume full responsibility for the accuracy and completeness of these measurements, and for the qualifications of all persons taking them.

HCT CO., LTD. Certifies that no party to this application has subject to a denial of Federal benefits that includes FCC benefits pursuant to section 5301 of the Anti-Drug Abuse Act of 1998,21 U.S. C.853(a)

Report prepared by
: Kyung Soo Kang
Test engineer of RF Team

Approved by
: Chang Seok Choi
Manager of RF Team

This report only responds to the tested sample and may not be reproduced, except in full, without written approval of the HCT Co., Ltd.

FCC CERTIFICATION REPORT

www.hct.co.kr

Test Report No.
HCTR1308FR29

Date of Issue:
August 21, 2013

EUT Type:
850/1900 GSM/GPRS Phone with BT v4.0(LE) , 802.11b/g/n and EDGE Rx only, Hotspot

FCC ID:
A3LGTS7392

Version

TEST REPORT NO.	DATE	DESCRIPTION
HCTR1308FR29	August 21, 2013	First Approval Report

Table of Contents

1. GENERAL INFORMATION		4
2. INTRODUCTION		5
2.1. EUT DESCRIPTION.....		5
2.2. MEASURING INSTRUMENT CALIBRATION.....		5
2.3. TEST FACILITY		5
3. DESCRIPTION OF TESTS		6
3.1 ERP/EIRP RADIATED POWER AND RADIATED SPURIOUS EMISSIONS.....		6
3.2 PEAK- TO- AVERAGE RATIO		7
3.3 OCCUPIED BANDWIDTH.		9
3.4 SPURIOUS AND HARMONIC EMISSIONS AT ANTENNA TERMINAL.....		10
3.5 FREQUENCY STABILITY / VARIATION OF AMBIENT TEMPERATURE		11
4. LIST OF TEST EQUIPMENT		12
5. SUMMARY OF TEST RESULTS		13
6. SAMPLE CALCULATION		14
7. TEST DATA		15
7.1 EFFECTIVE RADIATED POWER OUTPUT (GSM).....		15
7.2 EQUIVALENT ISOTROPIC RADIATED POWER (GSM)		16
7.3 RADIATED SPURIOUS EMISSIONS		17
7.3.1 RADIATED SPURIOUS EMISSIONS (GSM850).....		17
7.3.2 RADIATED SPURIOUS EMISSIONS (GSM1900).....		18
7.4 PEAK-TO-AVERAGE RATIO		19
7.5 OCCUPIED BANDWIDTH		19
7.6 CONDUCTED SPURIOUS EMISSIONS		20
7.6.1 BAND EDGE.....		20
7.7 FREQUENCY STABILITY / VARIATION OF AMBIENT TEMPERATURE		21
7.7.1 FREQUENCY STABILITY (GSM850)		21
7.7.2 FREQUENCY STABILITY (GSM1900)		22
8. TEST PLOTS.....		23

FCC CERTIFICATION REPORT			www.hct.co.kr
Test Report No. HCTR1308FR29	Date of Issue: August 21, 2013	EUT Type: 850/1900 GSM/GPRS Phone with BT v4.0(LE) , 802.11b/g/n and EDGE Rx only, Hotspot	FCC ID: A3LGTS7392



MEASUREMENT REPORT

1. GENERAL INFORMATION

Applicant Name: SAMSUNG Electronics Co., Ltd.

Address: 129, Samsung-ro, Yeongtong-gu Suwon-si, Gyeonggi-do, 443-742 Rep. of Korea

FCC ID: A3LGTS7392

Application Type: Certification

FCC Classification: Licensed Portable Transmitter Held to Ear (PCE)

FCC Rule Part(s): §22, §24, §2

EUT Type: 850/1900 GSM/GPRS Phone with BT v4.0(LE) , 802.11b/g/n and EDGE Rx only, Hotspot

Tx Frequency: 824.20 - 848.80 MHz (GSM850)
1 850.20 - 1 909.80 MHz (GSM1900)

Rx Frequency: 869.20 - 893.80 MHz (GSM850)
1 930.20 - 1 989.80 MHz (GSM1900)

Max. RF Output Power: 0.185 W ERP GSM850 (22.67 dBm) / 0.818 W EIRP GSM1900 (29.13 dBm)

Emission Designator(s): 245 KGXW (GSM850) 246 KGXW (GSM1900)

Date(s) of Tests: August 08, 2013 ~ August 21, 2013

Antenna Specification Manufacturer: Ethertronics INC.
Antenna type: Internal antenna
Peak Gain: GSM850 : -2.49 dBi
GSM1900 : -1.87 dBi

FCC CERTIFICATION REPORT

www.hct.co.kr

Test Report No.
HCTR1308FR29

Date of Issue:
August 21, 2013

EUT Type:
850/1900 GSM/GPRS Phone with BT v4.0(LE) , 802.11b/g/n and EDGE Rx only, Hotspot

FCC ID:
A3LGTS7392



2. INTRODUCTION

2.1. EUT DESCRIPTION

The SAMSUNG Electronics Co., Ltd. GT-S7392 850/1900 GSM/GPRS Phone with BT v4.0(LE) , 802.11b/g/n and EDGE Rx only, Hotspot consists of GSM850, GSM1900 and GPRS Class33.

2.2. MEASURING INSTRUMENT CALIBRATION

The measuring equipment, which was utilized in performing the tests documented herein, has been calibrated in accordance with the manufacturer's recommendations for utilizing calibration equipment, which is traceable to recognized national standards.

2.3. TEST FACILITY

The Fully-anechoic chamber and conducted measurement facility used to collect the radiated data are located at the 105-1, Jangam-ri , Majang-Myeon, Icheon-si, 467-811, KOREA.

The site is constructed in conformance with the requirements of ANSI C63.4 and CISPR Publication 22. Detailed description of test facility was submitted to the Commission and accepted dated March 02, 2011 (Registration Number: 90661)

FCC CERTIFICATION REPORT			www.hct.co.kr
Test Report No. HCTR1308FR29	Date of Issue: August 21, 2013	EUT Type: 850/1900 GSM/GPRS Phone with BT v4.0(LE) , 802.11b/g/n and EDGE Rx only, Hotspot	FCC ID: A3LGTS7392



3. DESCRIPTION OF TESTS

3.1 ERP/EIRP RADIATED POWER AND RADIATED SPURIOUS EMISSIONS

Note: ERP(Effective Radiated Power), EIRP(Effective Isotropic Radiated Power)

Test Procedure

Radiated emission measurements are performed in the Fully-anechoic chamber. The equipment under test is placed on a non-conductive table 3-meters away from the receive antenna in accordance with ANSI/TIA-603-C-2004 Clause 2.2.17. The turntable is rotated through 360 degrees, and the receiving antenna scans in order to determine the level of the maximized emission. The level and position of the maximized emission is recorded with the spectrum analyzer using a positive peak detector.

A half wave dipole is then substituted in place of the EUT. For emissions above 1GHz, a horn antenna is substituted in place of the EUT. The substitute antenna is driven by a signal generator and the previously recorded signal was duplicated.

The power is calculated by the following formula;

$$P_{d(dBm)} = P_{g(dBm)} - \text{cable loss}_{(dB)} + \text{antenna gain}_{(dB)}$$

Where: P_d is the dipole equivalent power and P_g is the generator output power into the substitution antenna.

The maximum EIRP is calculated by adding the forward power to the calibrated source plus its appropriate gain value. These steps are repeated with the receiving antenna in both vertical and horizontal polarization. the difference between the gain of the horn and an isotropic antenna are taken into consideration

FCC CERTIFICATION REPORT			www.hct.co.kr
Test Report No. HCTR1308FR29	Date of Issue: August 21, 2013	EUT Type: 850/1900 GSM/GPRS Phone with BT v4.0(LE) , 802.11b/g/n and EDGE Rx only, Hotspot	FCC ID: A3LGTS7392

3.2 PEAK- TO- AVERAGE RATIO

Test Procedure

Peak to Average Power Ratio is tested in accordance with KDB971168 D01 Power Meas License Digital Systems v02r01, June 7, 2013, Section 5.7.

- Section 5.7.1 CCDF Procedure

- a) Set resolution/measurement bandwidth \geq signal's occupied bandwidth;
- b) Set the number of counts to a value that stabilizes the measured CCDF curve;
- c) Set the measurement interval as follows:
 - 1) for continuous transmissions, set to 1 ms,
 - 2) for burst transmissions, employ an external trigger that is synchronized with the EUT burst timing sequence, or use the internal burst trigger with a trigger level that allows the burst to stabilize and set the measurement interval to a time that is less than or equal to the burst duration.
- d) Record the maximum PAPR level associated with a probability of 0.1%.

- Section 5.7.2 Alternate Procedure

Use one of the procedures presented in 5.1 to measure the total peak power and record as P_{Pk} . Use one of the applicable procedures presented 5.2 to measure the total average power and record as P_{Avg} . Determine the P.A.R. from: $P.A.R_{(dB)} = P_{Pk (dBm)} - P_{Avg (dBm)}$ (P_{Avg} = Average Power + Duty cycle Factor)

5.1.1 Peak power measurements with a spectrum/signal analyzer or EMI receiver

The following procedure can be used to determine the total peak output power.

- a) Set the RBW \geq OBW.
- b) Set VBW $\geq 3 \times$ RBW.
- c) Set span $\geq 2 \times$ RBW
- d) Sweep time = auto couple.
- e) Detector = peak.
- f) Ensure that the number of measurement points \geq span/RBW.
- g) Trace mode = max hold.
- h) Allow trace to fully stabilize.
- i) Use the peak marker function to determine the peak amplitude level.

FCC CERTIFICATION REPORT			www.hct.co.kr
Test Report No. HCTR1308FR29	Date of Issue: August 21, 2013	EUT Type: 850/1900 GSM/GPRS Phone with BT v4.0(LE) , 802.11b/g/n and EDGE Rx only, Hotspot	FCC ID: A3LGTS7392

5.2.2 Procedures for use with a spectrum/signal analyzer when EUT cannot be configured to transmit continuously and sweep triggering/signal gating cannot be properly implemented

If the EUT cannot be configured to transmit continuously (burst duty cycle < 98%), then one of the following procedures can be used. The selection of the applicable procedure will depend on the characteristics of the measured burst duty cycle.

Measure the burst duty cycle with a spectrum/signal analyzer or EMC receiver can be used in zero-span mode if the response time and spacing between bins on the sweep are sufficient to permit accurate measurement of the burst on/off time of the transmitted signal.

5.2.2.2 Constant burst duty cycle

If the measured burst duty cycle is constant (i.e., duty cycle variations are less than ± 2 percent), then:

- a) Set span to at least 1.5 times the OBW.
- b) Set RBW = 1-5% of the OBW, not to exceed 1 MHz.
- c) Set VBW ≥ 3 x RBW.
- d) Number of points in sweep ≥ 2 × span / RBW. (This gives bin-to-bin spacing ≤ RBW/2, so that narrowband signals are not lost between frequency bins.)
- e) Sweep time = auto.
- f) Detector = RMS (power averaging).
- g) Set sweep trigger to “free run”.
- h) Trace average at least 100 traces in power averaging (i.e., RMS) mode.
- i) Compute power by integrating the spectrum across the OBW of the signal using the instrument’s band power measurement function with band limits set equal to the OBW band edges. If the instrument does not have a band power function, sum the spectrum levels (in power units) at intervals equal to the RBW extending across the entire OBW of the spectrum.
- j) Add 10 log (1/x), where x is the duty cycle, to the measured power in order to compute the average power during the actual transmission times (because the measurement represents an average over both the on and off times of the transmission).

For example, add 10 log (1/0.25) = 6 dB if the duty cycle is a constant 25%.

FCC CERTIFICATION REPORT			www.hct.co.kr
Test Report No. HCTR1308FR29	Date of Issue: August 21, 2013	EUT Type: 850/1900 GSM/GPRS Phone with BT v4.0(LE) , 802.11b/g/n and EDGE Rx only, Hotspot	FCC ID: A3LGTS7392

3.3 OCCUPIED BANDWIDTH.

Test set-up

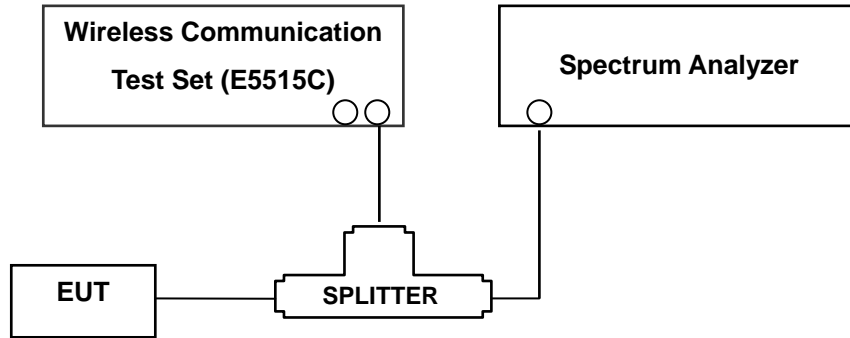

(Configuration of conducted Emission measurement)

The width of a frequency band such that, below the lower and above the upper frequency limits, the mean powers emitted are each equal to a specified percentage 0.5 % of the total mean power of a given emission.

Test Procedure

The EUT makes a call to the communication simulator. The power was measured with R&S Spectrum Analyzer. All measurements were done at 3 channels(low, middle and high operational range.)

The conducted occupied bandwidth used the power splitter via EUT RF power connector between simulation base station and spectrum analyzer.

The communication simulator station system controlled a EUT to export maximum output power under transmission mode and specific channel frequency. Use OBW measurement function of Spectrum analyzer to measure 99 % occupied bandwidth

FCC CERTIFICATION REPORT			www.hct.co.kr
Test Report No. HCTR1308FR29	Date of Issue: August 21, 2013	EUT Type: 850/1900 GSM/GPRS Phone with BT v4.0(LE) , 802.11b/g/n and EDGE Rx only, Hotspot	FCC ID: A3LGTS7392



3.4 SPURIOUS AND HARMONIC EMISSIONS AT ANTENNA TERMINAL.

Test Procedure

The level of the carrier and the various conducted spurious and harmonic frequencies is measured by means of a calibrated spectrum analyzer.

On any frequency outside a licensee’s frequency block, the power of any emission shall be attenuated below the transmitter power (P) by at least $43 + 10 \log(P)$ dB. The RBW settings used in the testing are greater than 1 % of the occupied bw. The 1 MHz RBW was used to scan from 10 MHz to 10 GHz. (GSM1900 Mode: 10 MHz to 20 GHz). A display line was placed at – 13 dBm to show compliance. The high, lowest and a middle channel were tested for out of band measurements.

Measurements of all out of band are made on RBW = 1MHz and VBW \geq 3 MHz in the worst case despite RBW = 100 kHz and VBW \geq 300 kHz upon 1 GHz.

- RBW = 1 MHz
- VBW \geq 3 MHz
- Detector = Peak
- Trace Mode = max hold
- Sweep time = auto
- Number of points in sweep \geq 2 * Span / RBW

- Band Edge Requirement : According to FCC 22.917 , 24.238(a) specified that power of any emission outside of The authorized operating frequency ranges must be attenuated below the transmitting power (P) by a factor of at least $43 + 10 \log(P)$ dB. In the 1 MHz bands immediately outside and adjacent to the frequency block a resolution bandwidth of at least one percent of the emission bandwidth of the fundamental emission of the transmitter may be employed.

The EUT makes a call to the communication simulator. The power was measured with R&S Spectrum Analyzer. All measurements were done at 2 channels(low and high operational frequency range.)

The band edge measurement used the power splitter via EUT RF power connector between simulation base station and spectrum analyzer.

The center frequency of spectrum is the band edge frequency and span is 1MHz RB of the spectrum is 3KHz and VB of the spectrum is 3KHz (GSM)

NOTES: The analyzer plot offsets were determined by below conditions.

- For GSM850, total offset 27 dBm = 20 dBm attenuator + 6 dBm Divider + 1 dBm RF cables.
- For GSM1900, total offset 27.2 dBm = 20 dBm attenuator + 6 dBm Divider + 1.2 dBm RF cables.

FCC CERTIFICATION REPORT			www.hct.co.kr
Test Report No. HCTR1308FR29	Date of Issue: August 21, 2013	EUT Type: 850/1900 GSM/GPRS Phone with BT v4.0(LE) , 802.11b/g/n and EDGE Rx only, Hotspot	FCC ID: A3LGTS7392

3.5 FREQUENCY STABILITY / VARIATION OF AMBIENT TEMPERATURE

Test Set-up

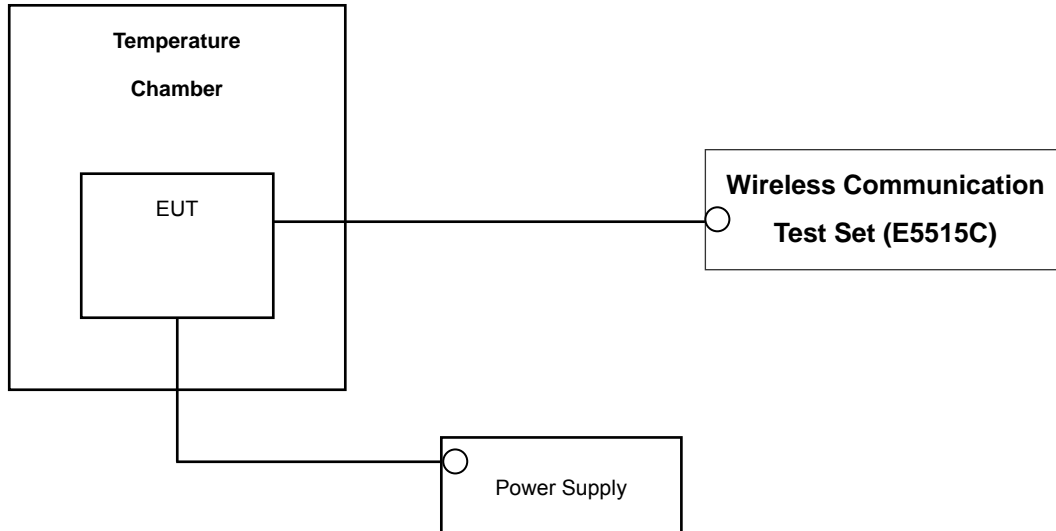

* Nominal Operating Voltage

Test Procedure

The frequency stability of the transmitter is measured by:

- a.) **Temperature:** The temperature is varied from - 30 °C to + 50 °C using an environmental chamber.
- b.) **Primary Supply Voltage:** The primary supply voltage is varied from battery end point to 115 % of the voltage normally at the input to the device or at the power supply terminals if cables are not normally supplied.

Specification — the frequency stability shall be sufficient to ensure that the fundamental emission stays within the authorized frequency block. The frequency stability of the transmitter shall be maintained within $\pm 0.00025\%$ (± 2.5 ppm) of the center frequency.

Time Period and Procedure:

The carrier frequency of the transmitter is measured at room temperature (20°C to provide a reference).

1. The equipment is turned on in a "standby" condition for one minute before applying power to the transmitter. Measurement of the carrier frequency of the transmitter is made within one minute after applying power to the transmitter.
2. Frequency measurements are made at 10°C intervals ranging from -30°C to +50°C. A period of at least one half-hour is provided to allow stabilization of the equipment at each temperature level.

NOTE: The EUT is tested down to the battery endpoint.

FCC CERTIFICATION REPORT			www.hct.co.kr
Test Report No. HCTR1308FR29	Date of Issue: August 21, 2013	EUT Type: 850/1900 GSM/GPRS Phone with BT v4.0(LE) , 802.11b/g/n and EDGE Rx only, Hotspot	FCC ID: A3LGTS7392

4. LIST OF TEST EQUIPMENT

Manufacture	Model/ Equipment	Serial Number	Calibration Interval	Calibration Due
Agilent	E9327A/ Power Sensor	MY4442009	Annual	04/16/2014
MITEQ	AMF-6D-001180-35-20P/AMP	1081666	Annual	09/11/2013
Wainwright	WHK1.2/15G-10EF/H.P.F	2	Annual	04/25/2014
Wainwright	WHK3.3/18G-10EF/H.P.F	1	Annual	04/25/2014
Hewlett Packard	11667B / Power Splitter	10126	Annual	11/07/2013
Digital	EP-3010/ Power Supply	3110117	Annual	11/07/2013
Schwarzbeck	UHAP/ Dipole Antenna	557	Biennial	03/05/2015
Schwarzbeck	UHAP/ Dipole Antenna	558	Biennial	05/03/2015
Korea Engineering	KR-1005L / Chamber	KRAB05063-3CH	Annual	11/07/2013
Schwarzbeck	BBHA 9120D/ Horn Antenna	147	Biennial	05/15/2014
Schwarzbeck	BBHA 9120D/ Horn Antenna	937	Biennial	10/17/2013
Agilent	E9020A/Spectrum Analyzer	MY51110063	Annual	05/14/2014
WEINSCHTEL	ATTENUATOR	BR0592	Annual	11/07/2013
REOHDE&SCHWARZ	FSV40/Spectrum Analyzer	1307.9002K40-100931-NK	Annual	06/10/2014
Agilent	8960 (E5515C)/ Base Station	GB44400269	Annual	02/14/2014

FCC CERTIFICATION REPORT

www.hct.co.kr

Test Report No.
HCTR1308FR29

Date of Issue:
August 21, 2013

EUT Type:
850/1900 GSM/GPRS Phone with BT v4.0(LE) , 802.11b/g/n and EDGE Rx only, Hotspot

FCC ID:
A3LGTS7392

5. SUMMARY OF TEST RESULTS

FCC Part Section(s)	Test Description	Test Limit	Test Condition	Test Result
2.1049, 22.917(a), 24.238(a)	Occupied Bandwidth	N/A	CONDUCTED	PASS
2.1051, 22.917(a), 24.238(a)	Band Edge / Spurious and Harmonic Emissions at Antenna Terminal.	< 43 + 10log10 (P[Watts]) at Band Edge and for all out-of-band emissions		PASS
*2.1046	Conducted Output Power	-		PASS
24.232(d)	Peak- to- Average Ratio	< 13 dB		PASS
2.1055, 22.355, 24.235	Frequency stability / variation of ambient temperature	< 2.5 ppm		PASS
22.913(a)(2) 24.232(c)	Effective Radiated Power	< 7 Watts max. ERP	RADIATED	PASS
	Equivalent Isotropic Radiated Power	< 2 Watts max. EIRP		PASS
2.1053, 22.917(a), 24.238(a)	Radiated Spurious and Harmonic Emissions	< 43 + 10log10 (P[Watts]) for all out-of band emissions		PASS

*: See SAR Report

6. SAMPLE CALCULATION

A. ERP Sample Calculation

Mode	Ch./ Freq.		Measured Level(dBm)	Substitute LEVEL(dBm)	Ant. Gain (dBd)	C.L	Pol.	ERP	
	channel	Freq.(MHz)						W	dBm
GSM850	128	824.20	-21.37	38.40	-10.61	0.95	H	0.483	26.84

ERP = SubstituteLEVEL(dBm) + Ant. Gain – CL(Cable Loss)

- 1) The EUT mounted on a non-conductive turntable is 0.8 meter above test site ground level.
- 2) During the test , the turn table is rotated and the antenna height is also varied from 1 to 4 meters until the maximum signal is found.
- 3) Record the field strength meter's level.
- 4) Replace the EUT with dipole/Horn antenna that is connected to a calibrated signal generator.
- 5) Increase the signal generator output till the field strength meter's level is equal to the item (3).
- 6) The signal generator output level with Ant. Gain and cable loss are the rating of effective radiated power (ERP).

B. Emission Designator

GSM Emission Designator

Emission Designator = 249KGXW

GSM BW = 249 kHz

G = Phase Modulation

X = Cases not otherwise covered

W = Combination (Audio/Data)

FCC CERTIFICATION REPORT			www.hct.co.kr
Test Report No. HCTR1308FR29	Date of Issue: August 21, 2013	EUT Type: 850/1900 GSM/GPRS Phone with BT v4.0(LE) , 802.11b/g/n and EDGE Rx only, Hotspot	FCC ID: A3LGTS7392

7. TEST DATA

7.1 EFFECTIVE RADIATED POWER OUTPUT (GSM)

(GSM850 Mode)

Ch./ Freq.		Measured Level(dBm)	Substitute LEVEL (dBm)	Ant. Gain (dBd)	C.L	Pol.	ERP	
channel	Freq.(MHz)						W	dBm
128	824.20	-25.85	33.92	-10.61	0.95	V	0.172	22.36
190	836.60	-26.06	34.12	-10.54	0.96	V	0.183	22.62
251	848.80	-26.18	34.24	-10.47	1.10	V	0.185	22.67

Note: Standard batteries are the only options for this phone. And a peak detector is used.

NOTES:

Effective Radiated Power Output Measurements by Substitution Method
according to ANSI/TIA/EIA-603-C-2004, Aug. 17, 2004:

The EUT was placed on a non-conductive styrofoam resin table 3-meters from the receive antenna. The receive antenna height and turntable rotation was adjusted for the highest reading on the receive spectrum analyzer. For CDMA signals, a peak detector is used, with RBW = VBW = 3 MHz. For WCDMA signals, a peak detector is used, with RBW = VBW = 5MHz. For AMPS, GSM, and NADC TDMA signals, a peak detector is used, with RBW = VBW = 1 MHz. A half-wave dipole was substituted in place of the EUT. This dipole antenna was driven by a signal generator and the level of the signal generator was adjusted to obtain the same receive spectrum analyzer reading. The conducted power at the terminals of the dipole is measured. The ERP is recorded.

This device was tested under all configurations and the highest power is reported in GSM mode and using a Power Control Level of "0" in the PCS Band and "5" in the Cellular Band. This unit was tested with its standard battery. Also, we have done x, y, z planes in EUT and horizontal and vertical polarization in detecting antenna. The worst case of the EUT is in y plane in GSM850 mode. Also worst case of detecting Antenna is in vertical polarization in GSM850 mode.

FCC CERTIFICATION REPORT			www.hct.co.kr
Test Report No. HCTR1308FR29	Date of Issue: August 21, 2013	EUT Type: 850/1900 GSM/GPRS Phone with BT v4.0(LE) , 802.11b/g/n and EDGE Rx only, Hotspot	FCC ID: A3LGTS7392

7.2 EQUIVALENT ISOTROPIC RADIATED POWER (GSM)

(GSM1900 Mode)

Ch./ Freq.		Measured Level(dBm)	Substitute LEVEL (dBm)	Ant. Gain (dBi)	C.L	Pol.	EIRP	
channel	Freq.(MHz)						W	dBm
512	1,850.20	-11.51	20.52	10.02	1.41	H	0.818	29.13
661	1,880.00	-11.93	20.38	10.04	1.45	H	0.789	28.97
810	1,909.80	-11.85	20.40	10.05	1.44	H	0.796	29.01

Note: Standard batteries are the only options for this phone. And a peak detector is used.

NOTES:

Equivalent Isotropic Radiated Power Measurements by Substitution Method
according to ANSI/TIA/EIA-603-C-2004, Aug. 17, 2004:

The EUT was placed on a non-conductive styrofoam resin table 3-meters from the receive antenna. The receive antenna height and turntable rotation was adjusted for the highest reading on the receive spectrum analyzer. For CDMA signals, a peak detector is used, with RBW = VBW = 3 MHz. For WCDMA signals, a peak detector is used, with RBW = VBW = 5MHz. For AMPS, GSM, and NADC TDMA signals, a peak detector is used, with RBW = VBW = 1 MHz. A Horn antenna was substituted in place of the EUT. This Horn antenna was driven by a signal generator and the level of the signal generator was adjusted to obtain the same receive spectrum analyzer reading. The conducted power at the terminals of the Horn antenna is measured. The difference between the gain of the horn and an isotropic antenna is taken into consideration and the EIRP is recorded.

This device was tested under all configurations and the highest power is reported in GSM mode and using a Power Control Level of "0" in the PCS Band and "5" in the Cellular Band. This unit was tested with its standard battery. Also, we have done x, y, z planes in EUT and horizontal and vertical polarization in detecting antenna. The worst case of the EUT is in x plane in GSM1900 mode. Also worst case of detecting Antenna is in horizontal polarization in GSM1900 mode.

FCC CERTIFICATION REPORT

www.hct.co.kr

Test Report No.
HCTR1308FR29

Date of Issue:
August 21, 2013

EUT Type:
850/1900 GSM/GPRS Phone with BT v4.0(LE) , 802.11b/g/n and EDGE Rx only, Hotspot

FCC ID:
A3LGTS7392

7.3 RADIATED SPURIOUS EMISSIONS

7.3.1 RADIATED SPURIOUS EMISSIONS (GSM850)

MEASURED OUTPUT POWER: 22.67 dBm = 0.185 W

MODULATION SIGNAL: GSM850

DISTANCE: 3 meters

LIMIT: $43 + 10 \log_{10}(W) =$ 35.67 dBc

Ch.	Freq.(MHz)	Measured Level [dBm]	Ant. Gain (dBd)	Substitute Level [dBm]	C.L	Pol.	ERP (dBm)	dBc
128 (824.2)	1,648.40	-34.47	7.05	-41.31	1.18	V	-35.44	58.11
	2,472.60	-52.49	7.90	-56.24	1.57	V	-49.91	72.58
	3,296.80	-55.09	9.91	-58.97	1.99	V	-51.05	73.72
190 (836.6)	1,673.20	-38.28	7.22	-45.28	1.20	H	-39.26	61.93
	2,509.80	-47.94	8.51	-51.73	1.65	H	-44.87	67.54
	3,346.40	-56.17	10.09	-60.56	2.00	H	-52.47	75.14
251 (848.8)	1,697.60	-38.04	7.34	-45.06	1.20	H	-38.92	61.59
	2,546.40	-47.15	8.61	-50.69	1.65	H	-43.73	66.40
	3,395.20	-56.14	10.22	-60.67	1.99	H	-52.44	75.11

NOTES: 1. Radiated Spurious Emission Measurements at 3 meters by Substitution Method

according to ANSI/TIA/EIA-603-C-2004, Aug. 17, 2004:

2. The magnitude of spurious emissions attenuated more than 20dB below the limit above 5th Harmonic for all channel.

3. we have done x, y, z planes in EUT and horizontal and vertical polarization in detecting antenna.

7.3.2 RADIATED SPURIOUS EMISSIONS (GSM1900)

MEASURED OUTPUT POWER: 29.13 dBm = 0.818 W

MODULATION SIGNAL: GSM1900

DISTANCE: 3 meters

LIMIT: $43 + 10 \log_{10}(W) =$ 42.13 dBc

Ch.	Freq.(MHz)	Measured Level [dBm]	Ant. Gain (dBi)	Substitute Level [dBm]	C.L	Pol.	EIRP (dBm)	dBc
512 (1850.2)	3,700.40	-39.83	12.27	-44.57	2.19	H	-34.49	63.62
	5,550.60	-48.75	13.40	-48.42	2.88	H	-37.90	67.03
	7,400.80	-49.81	11.37	-39.52	3.29	H	-31.44	60.57
661 (1880.0)	3,760.00	-36.92	12.31	-41.47	2.11	H	-31.27	60.40
	5,640.00	-49.93	13.41	-49.26	2.92	H	-38.77	67.90
	7,520.00	-53.93	11.55	-44.41	3.34	V	-36.20	65.33
810 (1909.8)	3,819.60	-34.66	12.37	-39.14	2.14	H	-28.91	58.04
	5,729.40	-49.97	13.42	-48.53	3.02	H	-38.13	67.26
	7,639.20	-50.50	11.70	-40.74	3.13	V	-32.17	61.30

- NOTES:**
1. Radiated Spurious Emission Measurements at 3 meters by Substitution Method according to ANSI/TIA/EIA-603-C-2004, Aug. 17, 2004:
 2. The magnitude of spurious emissions attenuated more than 20dB below the limit above 5th Harmonic for all channel.
 3. we have done x, y, z planes in EUT and horizontal and vertical polarization in detecting antenna.

7.4 PEAK-TO-AVERAGE RATIO

Band	Ch.	Measured P _{Pk} (dBm)	Measured P _{Avg} (dBm)	P _{Avg} (Duty Cycle)			P.A.R. = P _{Pk} - P _{Avg} (dB)	Limit (dB)	Pass / Fail
				Tx _{Total} (ms)	Tx _{On} (ms)	Factor (dB)			
GSM1900	661	29.344	19.54	4.612	0.5515	9.223	0.581	13	Pass

- Plots of the EUT's Peak- to- Average Ratio are shown Page 27 ~ 28.

NOTES:

Peak to Average Power Ratio was tested in accordance with KDB971168 D01 Power Meas License Digital Systems v02r01, June 7, 2013, Section 5.7.

Only GSM(include EDGE) Mode was tested by Section 5.7.2 Alternate Procedure

$P.A.R._{(dB)} = P_{Pk} (dBm) - P_{Avg} (dBm)$ (P_{Avg} = Average Power + Duty cycle Factor)

Duty cycle Factor = $10 \log (1/x)$, $x = Tx_{On} / Tx_{Total}$

7.5 OCCUPIED BANDWIDTH

Band	Channel	Frequency(MHz)	Data (GSM: kHz)
GSM850	128	824.20	243.94
	190	836.60	245.08
	251	848.80	244.94
GSM1900	512	1850.20	244.95
	661	1880.00	245.57
	810	1909.80	246.42

- Plots of the EUT's Occupied Bandwidth are shown Page 24 ~ 26.

FCC CERTIFICATION REPORT			www.hct.co.kr
Test Report No. HCTR1308FR29	Date of Issue: August 21, 2013	EUT Type: 850/1900 GSM/GPRS Phone with BT v4.0(LE) , 802.11b/g/n and EDGE Rx only, Hotspot	FCC ID: A3LGTS7392

7.6 CONDUCTED SPURIOUS EMISSIONS

Band	Channel	Frequency of Maximum Harmonic (GHz)	Maximum Data (dBm)
GSM850	128	3.3279	-29.014
	190	3.3215	-29.792
	251	2.5252	-29.589
GSM1900	512	16.8393	-26.346
	661	16.7908	-26.455
	810	16.9033	-27.067

- Plots of the EUT's Conducted Spurious Emissions are shown Page 32 ~ 38.

7.6.1 BAND EDGE

- Plots of the EUT's Band Edge are shown Page 28 ~ 32.

7.7 FREQUENCY STABILITY / VARIATION OF AMBIENT TEMPERATURE

7.7.1 FREQUENCY STABILITY (GSM850)

OPERATING FREQUENCY: 836,600,000 Hz
 CHANNEL: 190
 REFERENCE VOLTAGE: 3.8 VDC
 DEVIATION LIMIT: ± 0.000 25 % or 2.5 ppm

Voltage (%)	Power (VDC)	Temp. ()	Frequency (Hz)	Frequency Error (Hz)	Deviation (%)	ppm
100%	3.800	+20(Ref)	836 599 982	0	0.000 000	0.000
100%		-30	836 599 964	-18.69	-0.000 002	-0.022
100%		-20	836 599 966	-16.56	-0.000 002	-0.020
100%		-10	836 599 963	-19.51	-0.000 002	-0.023
100%		0	836 599 965	-17.21	-0.000 002	-0.021
100%		+10	836 599 964	-18.24	-0.000 002	-0.022
100%		+30	836 599 964	-18.54	-0.000 002	-0.022
100%		+40	836 599 998	15.68	0.000 002	0.019
100%		+50	836 599 997	14.63	0.000 002	0.017
115%		4.370	+20	836 599 964	-18.57	-0.000 002
Batt. Endpoint	3.500	+20	836 599 961	-21.03	-0.000 003	-0.025

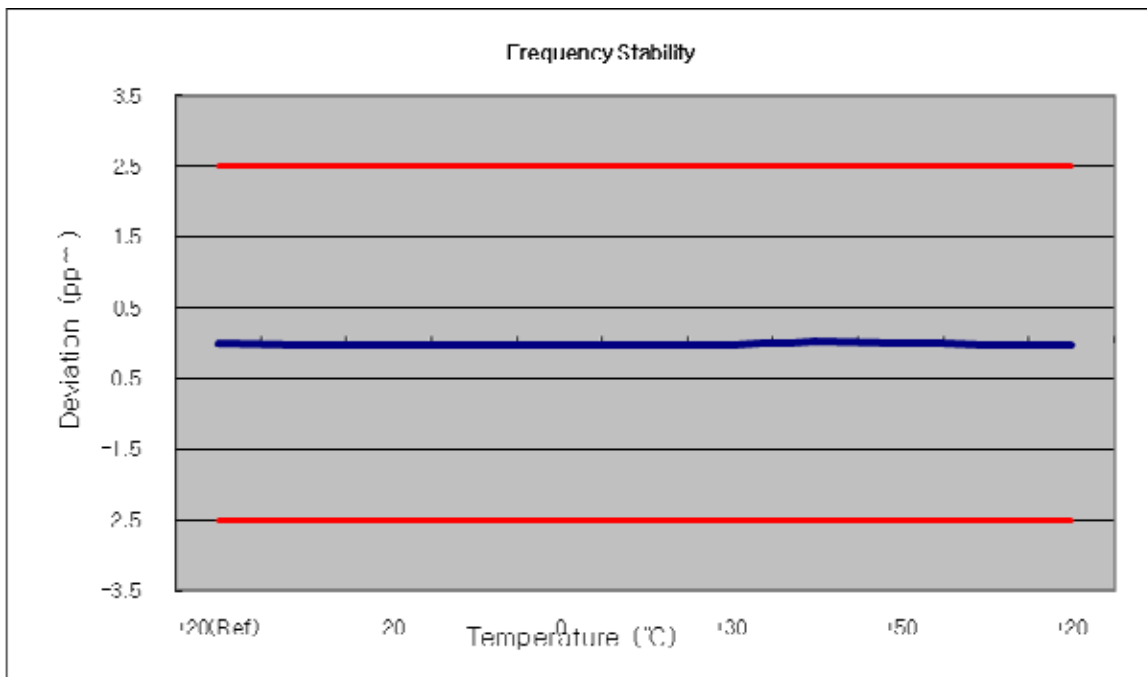

FCC CERTIFICATION REPORT

www.hct.co.kr

Test Report No.
HCTR1308FR29

Date of Issue:
August 21, 2013

EUT Type:
850/1900 GSM/GPRS Phone with BT v4.0(LE) , 802.11b/g/n and EDGE Rx only, Hotspot

FCC ID:
A3LGTS7392

7.7.2 FREQUENCY STABILITY (GSM1900)

OPERATING FREQUENCY: 1880,000,000 Hz
 CHANNEL: 661
 REFERENCE VOLTAGE: 3.8 VDC
 DEVIATION LIMIT: ± 0.000 25 % or 2.5 ppm

Voltage (%)	Power (VDC)	Temp. ()	Frequency (Hz)	Frequency Error (Hz)	Deviation (%)	ppm
100%	3.800	+20(Ref)	1879 999 978	0	0.000 000	0.000
100%		-30	1879 999 996	17.54	0.000 001	0.009
100%		-20	1879 999 960	-17.68	-0.000 001	-0.009
100%		-10	1879 999 954	-24.48	-0.000 001	-0.013
100%		0	1880 000 000	21.58	0.000 001	0.011
100%		+10	1880 000 000	22.32	0.000 001	0.012
100%		+30	1880 000 001	22.57	0.000 001	0.012
100%		+40	1879 999 961	-17.32	-0.000 001	-0.009
100%		+50	1879 999 954	-24.09	-0.000 001	-0.013
115%	4.370	+20	1879 999 998	20.18	0.000 001	0.011
Batt. Endpoint	3.500	+20	1879 999 997	19.13	0.000 001	0.010

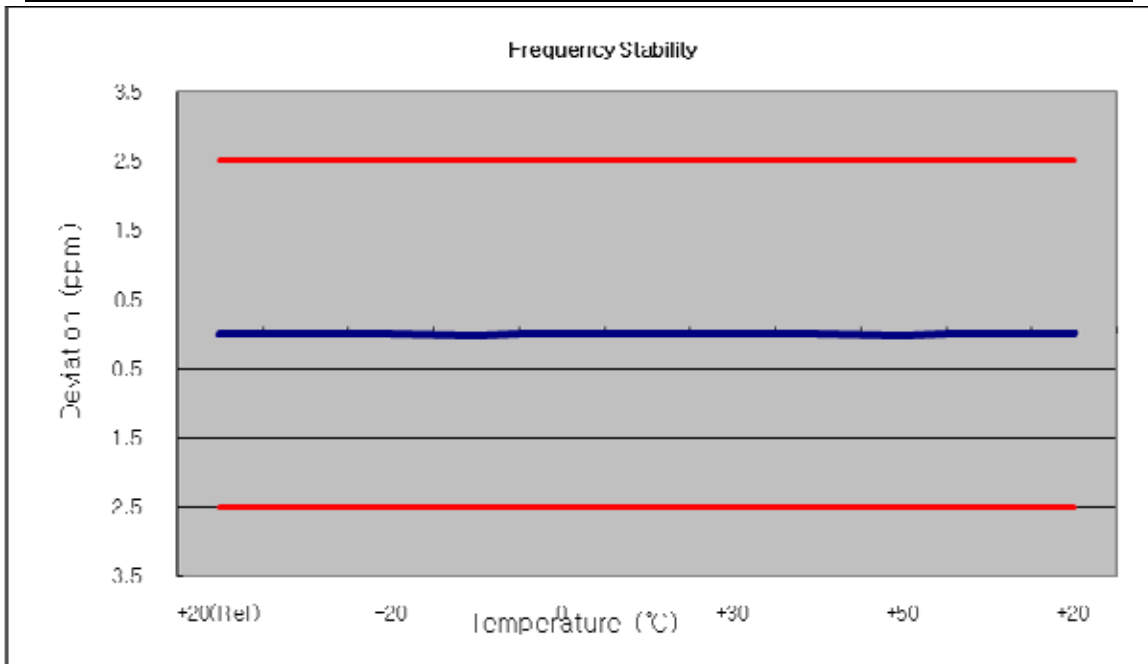

FCC CERTIFICATION REPORT



8. TEST PLOTS

FCC CERTIFICATION REPORT			www.hct.co.kr
Test Report No. HCTR1308FR29	Date of Issue: August 21, 2013	EUT Type: 850/1900 GSM/GPRS Phone with BT v4.0(LE) , 802.11b/g/n and EDGE Rx only, Hotspot	FCC ID: A3LGTS7392

■ GSM850 MODE (128 CH.) Occupied Bandwidth

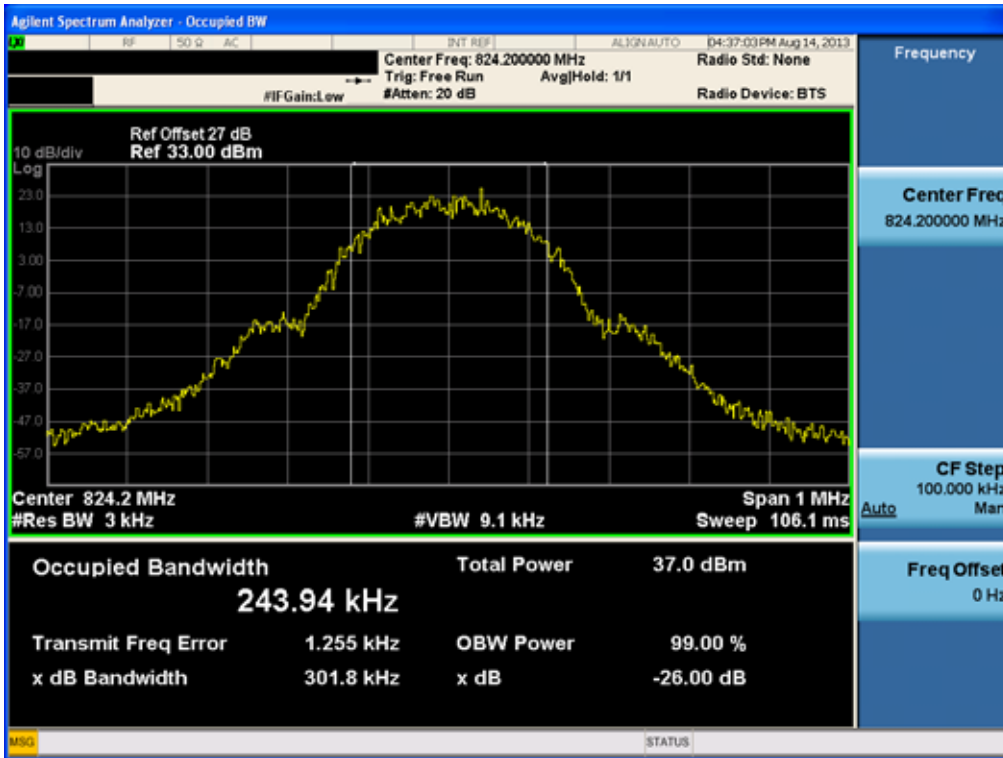

■ GSM850 MODE (190 CH.) Occupied Bandwidth

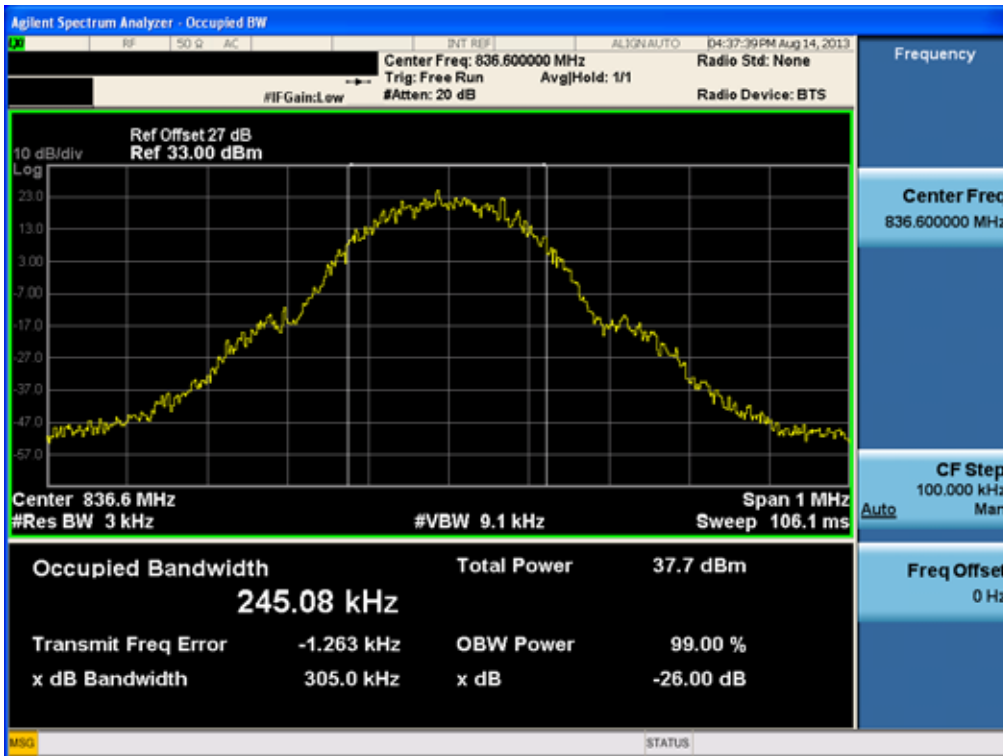

FCC CERTIFICATION REPORT

www.hct.co.kr

Test Report No.
HCTR1308FR29

Date of Issue:
August 21, 2013

EUT Type:
850/1900 GSM/GPRS Phone with BT v4.0(LE) , 802.11b/g/n and EDGE Rx only, Hotspot

FCC ID:
A3LGTS7392

■ GSM850 MODE (251 CH.) Occupied Bandwidth

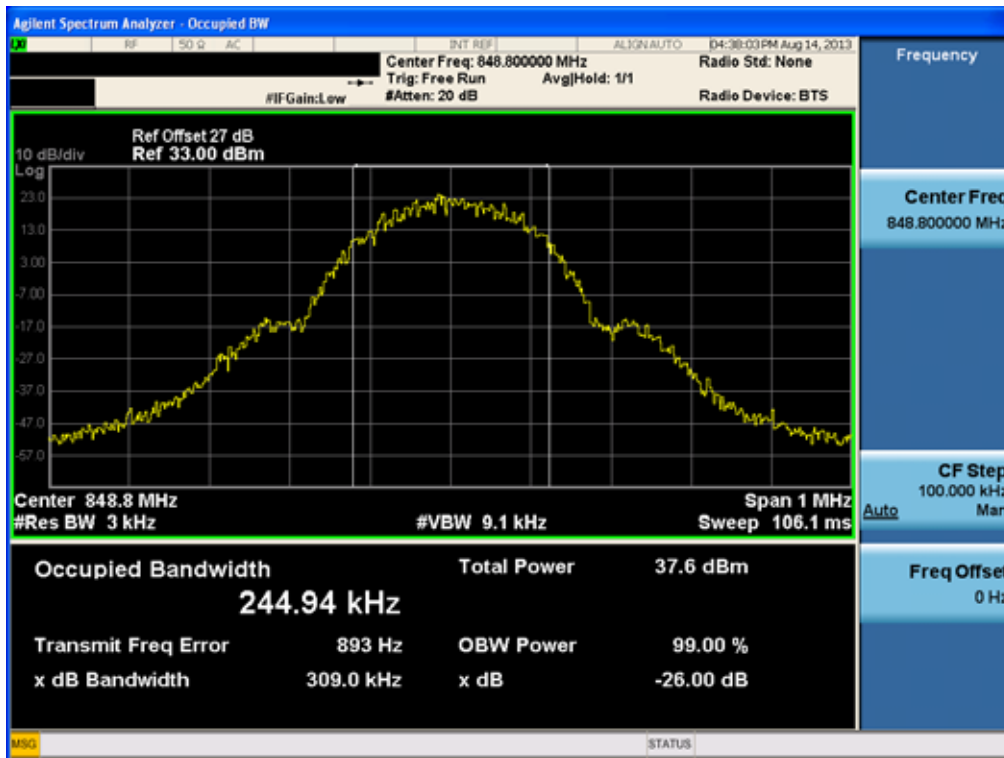

■ GSM1900 MODE (512 CH.) Occupied Bandwidth

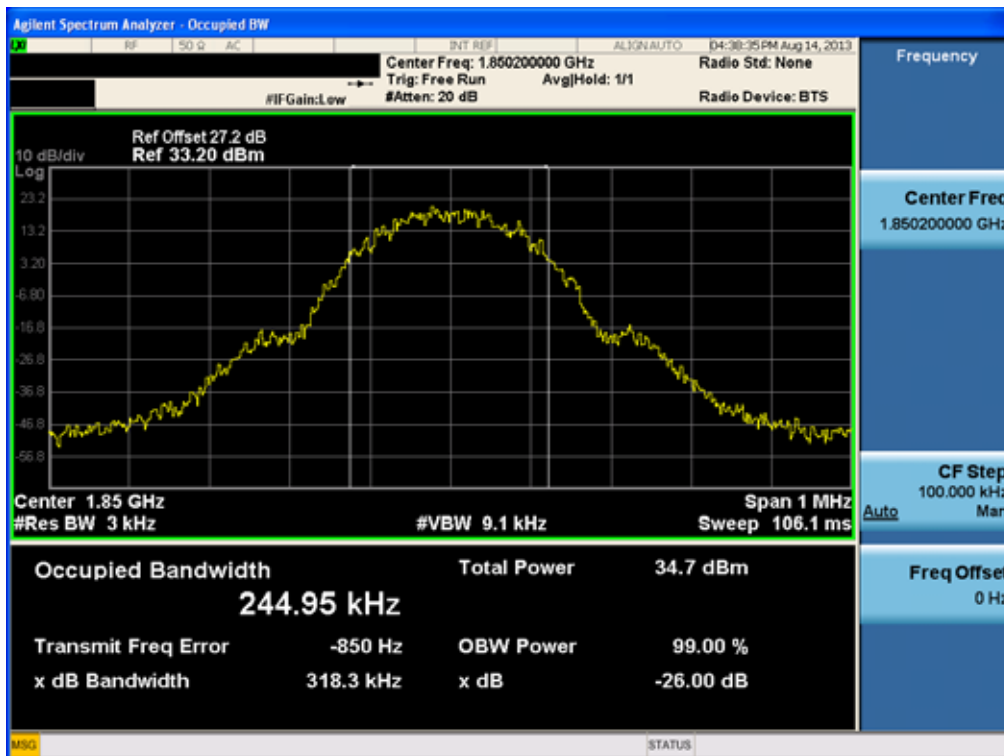

FCC CERTIFICATION REPORT

www.hct.co.kr

Test Report No.
HCTR1308FR29

Date of Issue:
August 21, 2013

EUT Type:
850/1900 GSM/GPRS Phone with BT v4.0(LE) , 802.11b/g/n and EDGE Rx only, Hotspot

FCC ID:
A3LGTS7392

■ GSM1900 MODE (661 CH.) Occupied Bandwidth

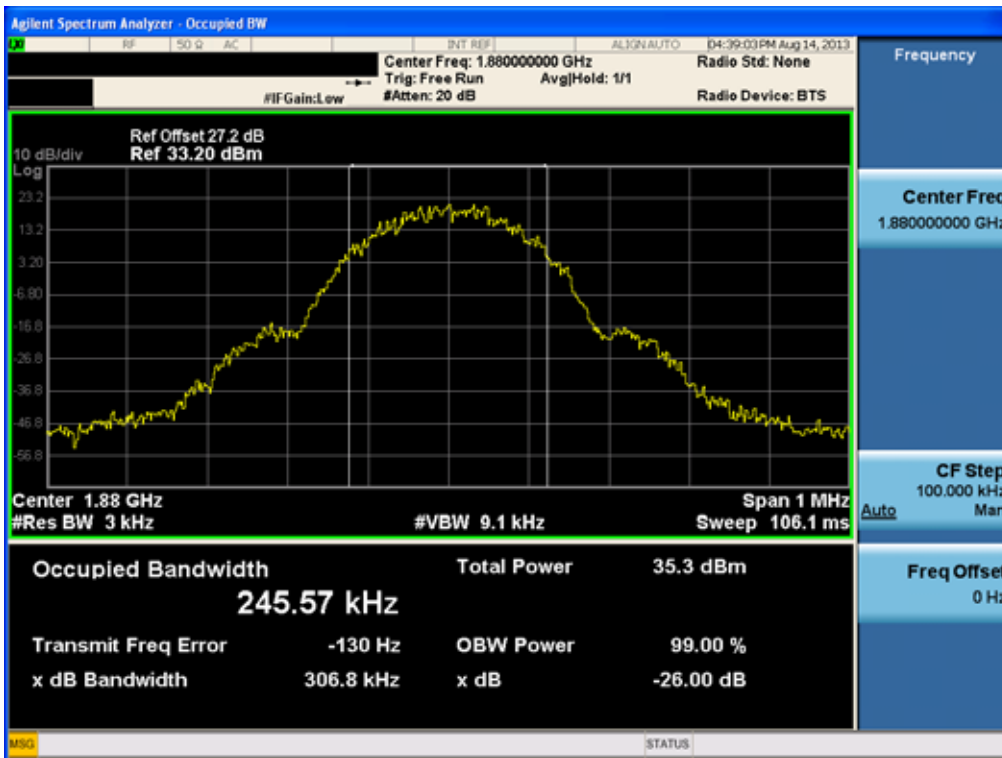

■ GSM1900 MODE (810 CH.) Occupied Bandwidth

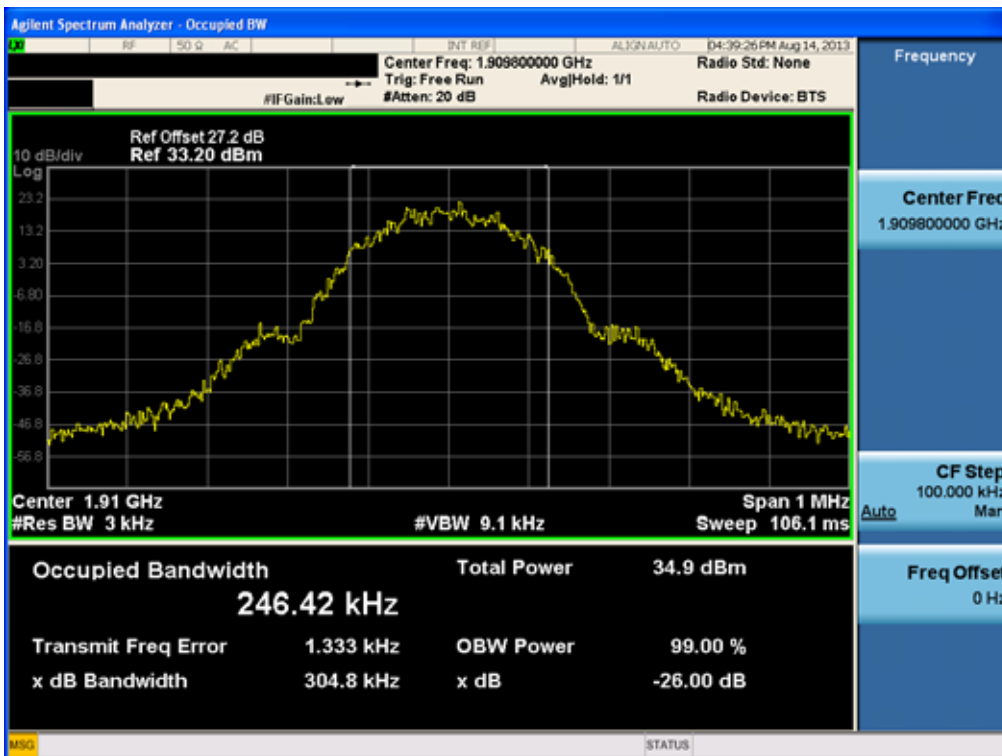

FCC CERTIFICATION REPORT

www.hct.co.kr

Test Report No.
HCTR1308FR29

Date of Issue:
August 21, 2013

EUT Type:
850/1900 GSM/GPRS Phone with BT v4.0(LE) , 802.11b/g/n and EDGE Rx only, Hotspot

FCC ID:
A3LGTS7392

■ GSM1900 MODE (661 CH.) Peak-to-Average Ratio P_{Pk}



■ GSM1900 MODE (661 CH.) Peak-to-Average Ratio P_{Avg}



FCC CERTIFICATION REPORT

www.hct.co.kr

Test Report No.
HCTR1308FR29

Date of Issue:
August 21, 2013

EUT Type:
850/1900 GSM/GPRS Phone with BT v4.0(LE) , 802.11b/g/n and EDGE Rx only, Hotspot

FCC ID:
A3LGTS7392

■ GSM1900 MODE (661 CH.) Peak-to-Average Ratio P_{Avg}

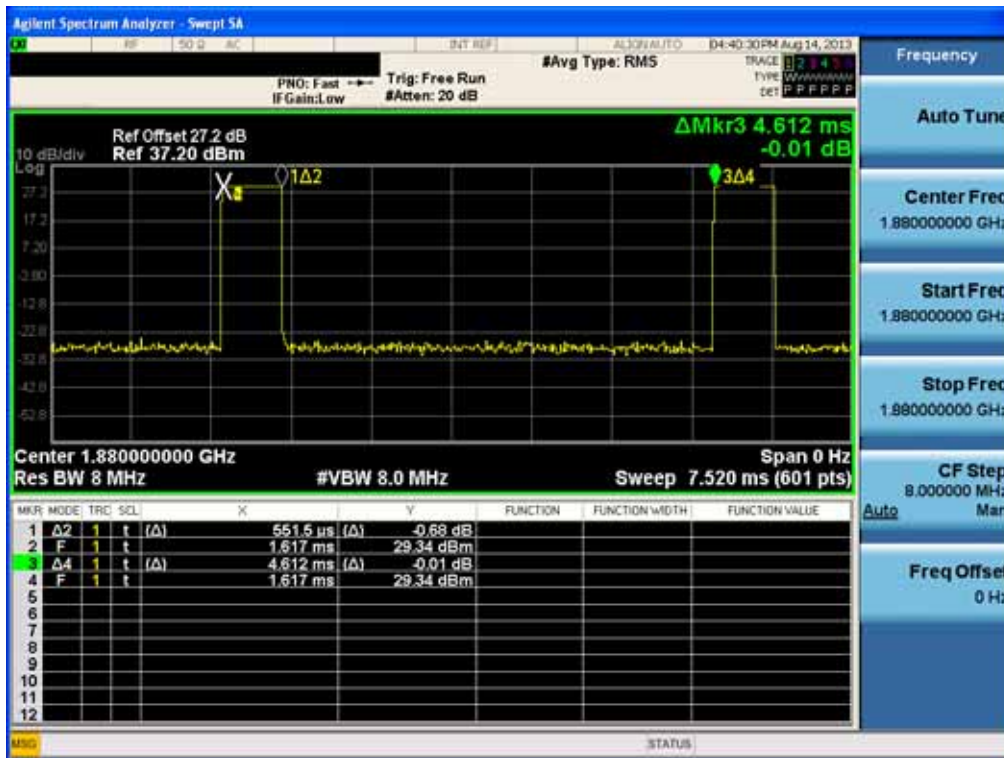

■ GSM850 MODE (128 CH.) Block Edge 1

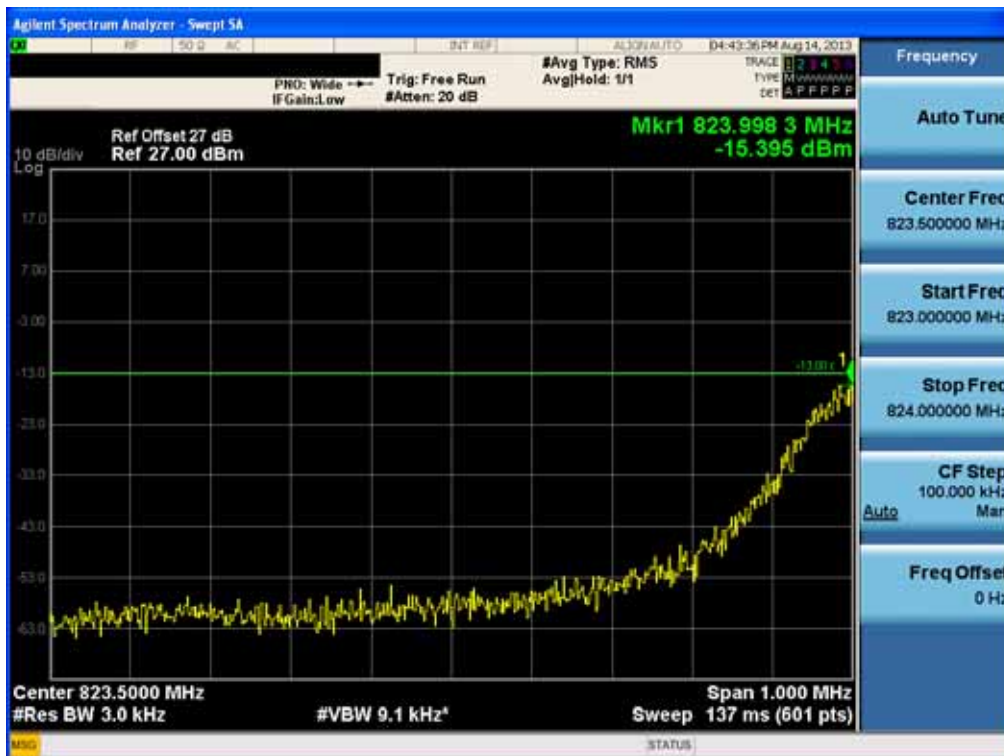

FCC CERTIFICATION REPORT

www.hct.co.kr

Test Report No.
HCTR1308FR29

Date of Issue:
August 21, 2013

EUT Type:
850/1900 GSM/GPRS Phone with BT v4.0(LE) , 802.11b/g/n and EDGE Rx only, Hotspot

FCC ID:
A3LGTS7392

■ GSM850 MODE (128 CH.) Block Edge 2



■ GSM850 MODE (251 CH.) Block Edge 1

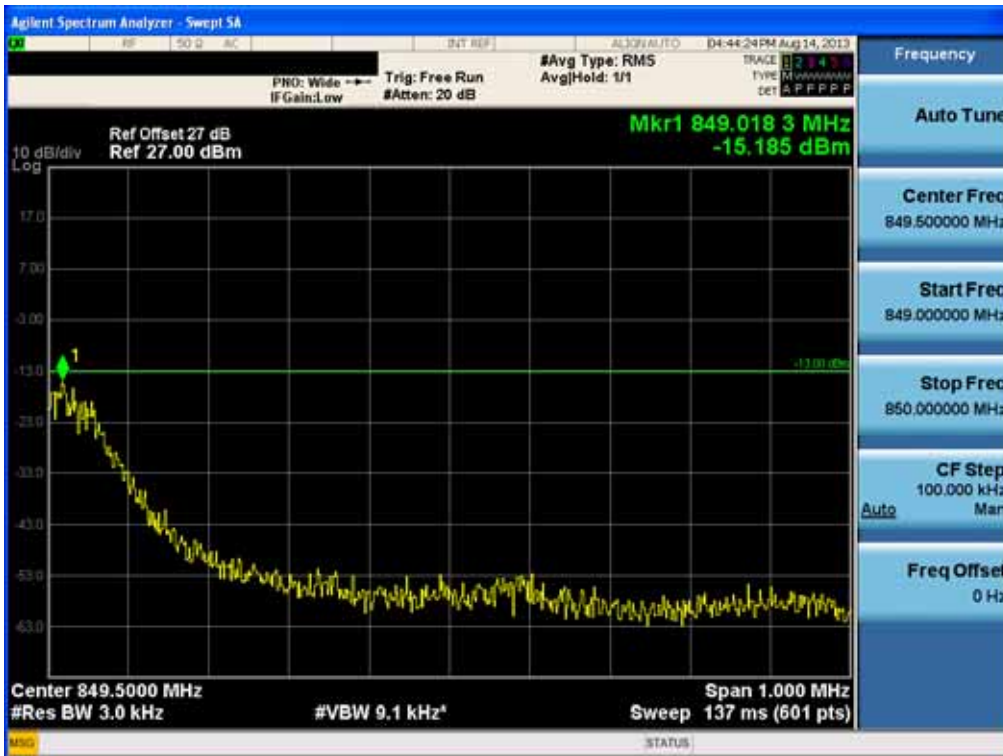

FCC CERTIFICATION REPORT

www.hct.co.kr

Test Report No.
HCTR1308FR29

Date of Issue:
August 21, 2013

EUT Type:
850/1900 GSM/GPRS Phone with BT v4.0(LE) , 802.11b/g/n and EDGE Rx only, Hotspot

FCC ID:
A3LGTS7392

■ GSM850 MODE (251 CH.) Block Edge 2



■ GSM1900 MODE (512 CH.) Block Edge 1



FCC CERTIFICATION REPORT

www.hct.co.kr

Test Report No.
HCTR1308FR29

Date of Issue:
August 21, 2013

EUT Type:
850/1900 GSM/GPRS Phone with BT v4.0(LE) , 802.11b/g/n and EDGE Rx only, Hotspot

FCC ID:
A3LGTS7392

■ GSM1900 MODE (512 CH.) Block Edge 2

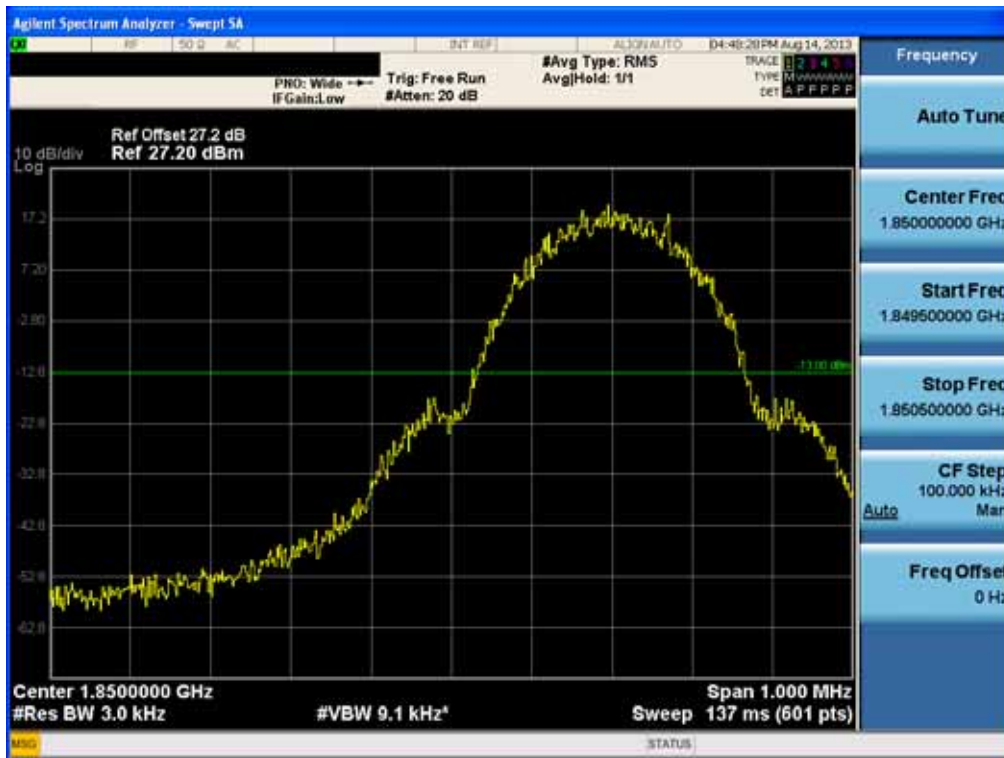

■ GSM1900 MODE (810 CH.) Block Edge 1

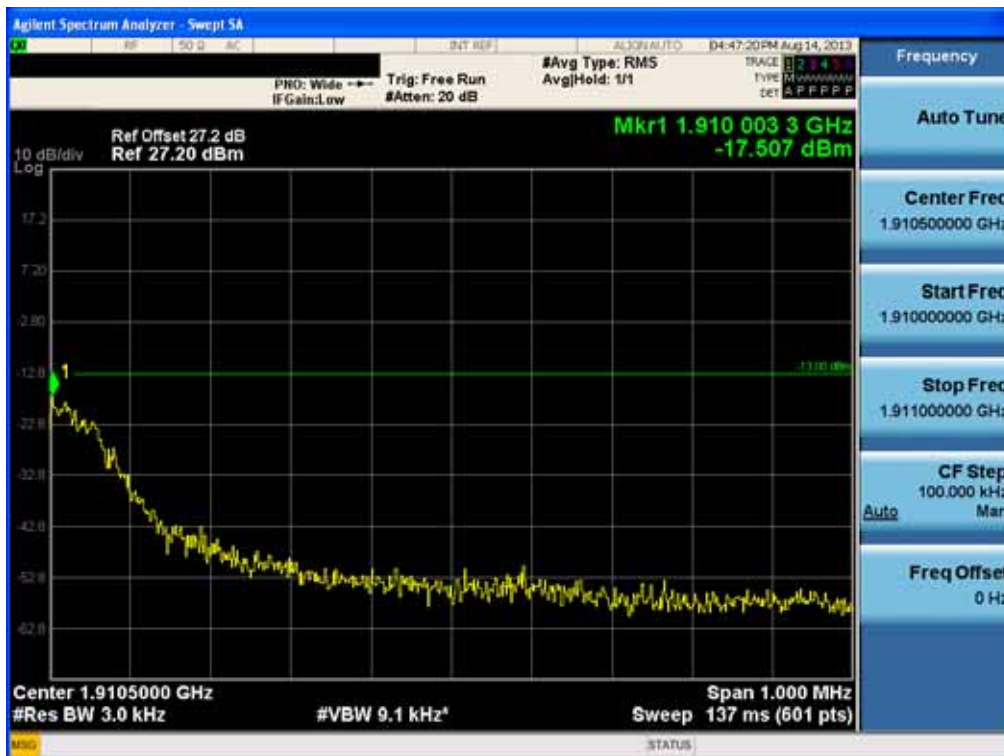

FCC CERTIFICATION REPORT

www.hct.co.kr

Test Report No.
HCTR1308FR29

Date of Issue:
August 21, 2013

EUT Type:
850/1900 GSM/GPRS Phone with BT v4.0(LE) , 802.11b/g/n and EDGE Rx only, Hotspot

FCC ID:
A3LGTS7392

■ GSM1900 MODE (810 CH.) Block Edge 2



■ GSM850 MODE (128 CH.) Conducted Spurious Emissions1

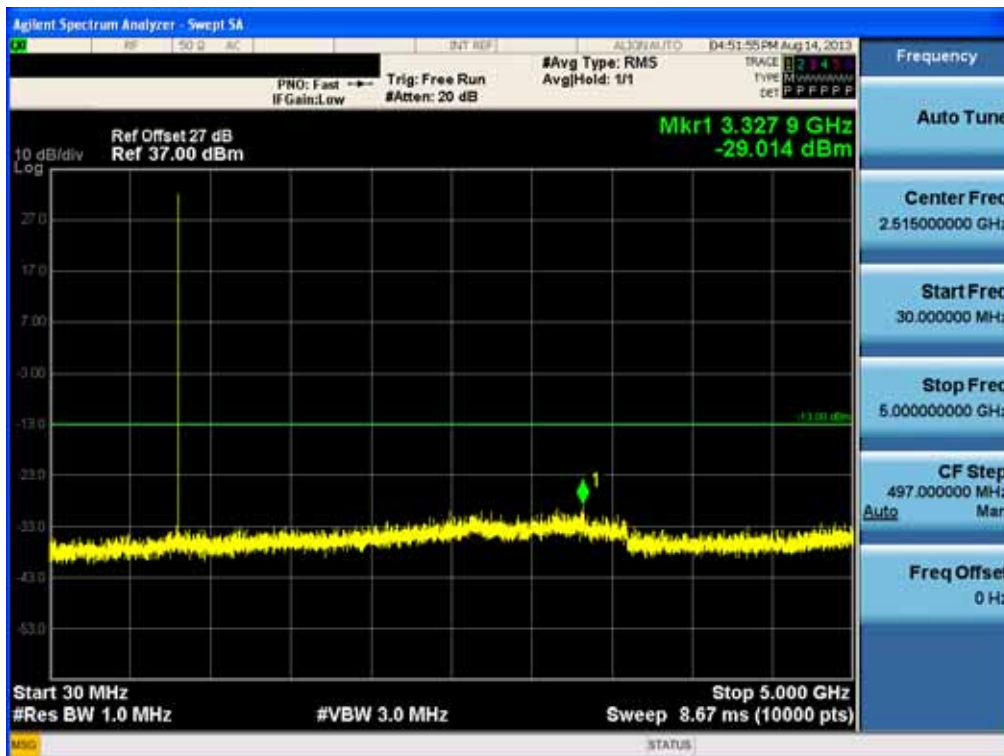

FCC CERTIFICATION REPORT

www.hct.co.kr

Test Report No.
HCTR1308FR29

Date of Issue:
August 21, 2013

EUT Type:
850/1900 GSM/GPRS Phone with BT v4.0(LE) , 802.11b/g/n and EDGE Rx only, Hotspot

FCC ID:
A3LGTS7392

■ GSM850 MODE (128 CH.) Conducted Spurious Emissions2

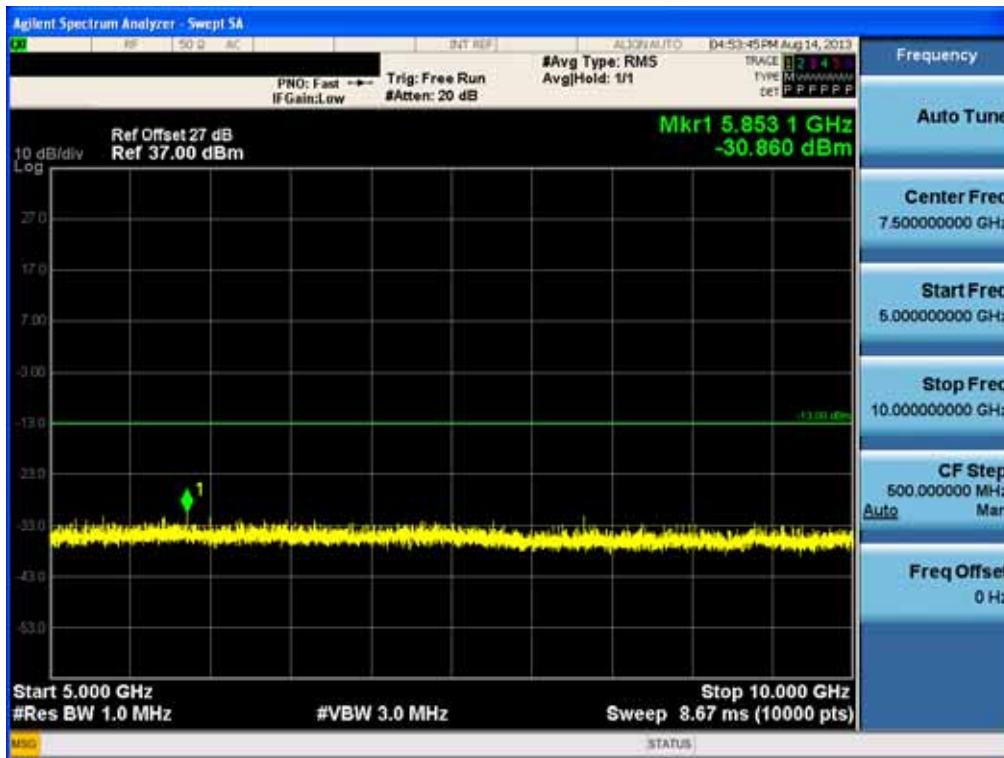

■ GSM850 MODE (190 CH.) Conducted Spurious Emissions1

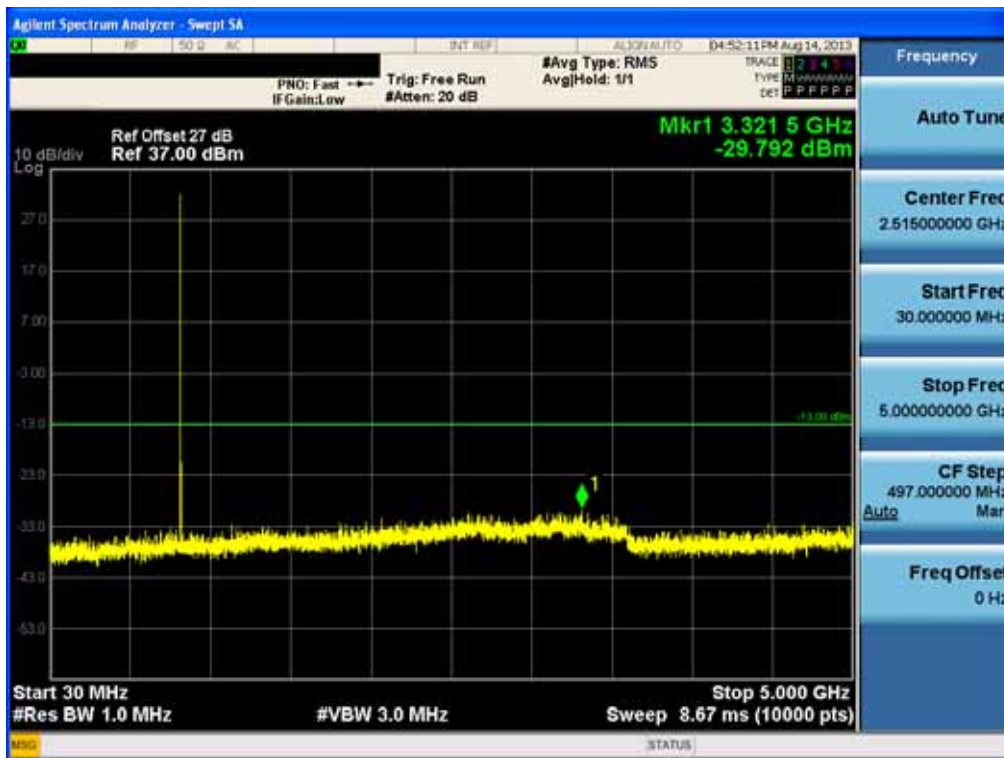

FCC CERTIFICATION REPORT

www.hct.co.kr

Test Report No.
HCTR1308FR29

Date of Issue:
August 21, 2013

EUT Type:
850/1900 GSM/GPRS Phone with BT v4.0(LE) , 802.11b/g/n and EDGE Rx only, Hotspot

FCC ID:
A3LGTS7392

■ GSM850 MODE (190 CH.) Conducted Spurious Emissions2

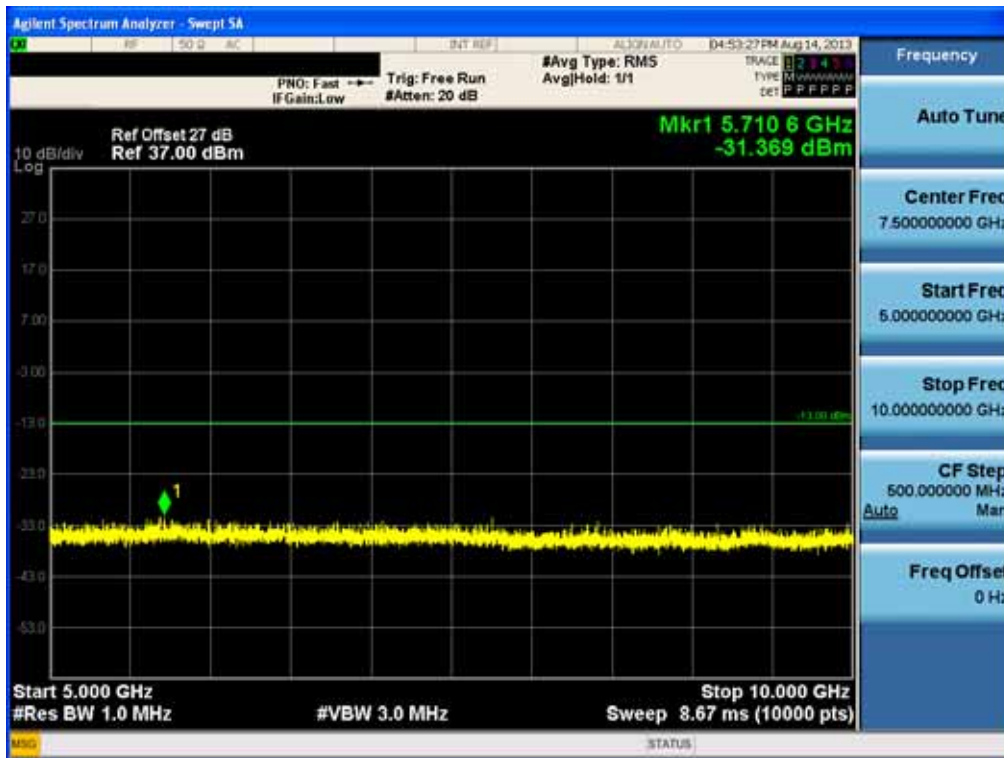

■ GSM850 MODE (251 CH.) Conducted Spurious Emissions1

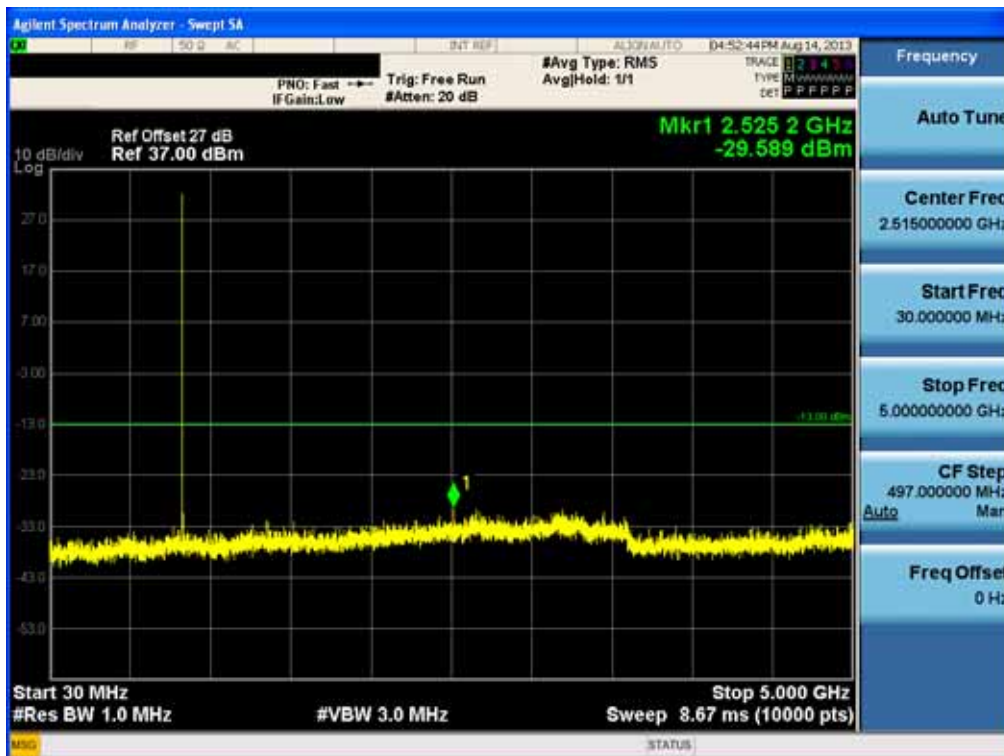

FCC CERTIFICATION REPORT

www.hct.co.kr

Test Report No.
HCTR1308FR29

Date of Issue:
August 21, 2013

EUT Type:
850/1900 GSM/GPRS Phone with BT v4.0(LE) , 802.11b/g/n and EDGE Rx only, Hotspot

FCC ID:
A3LGTS7392

■ GSM1900 MODE (512 CH.) Conducted Spurious Emissions2

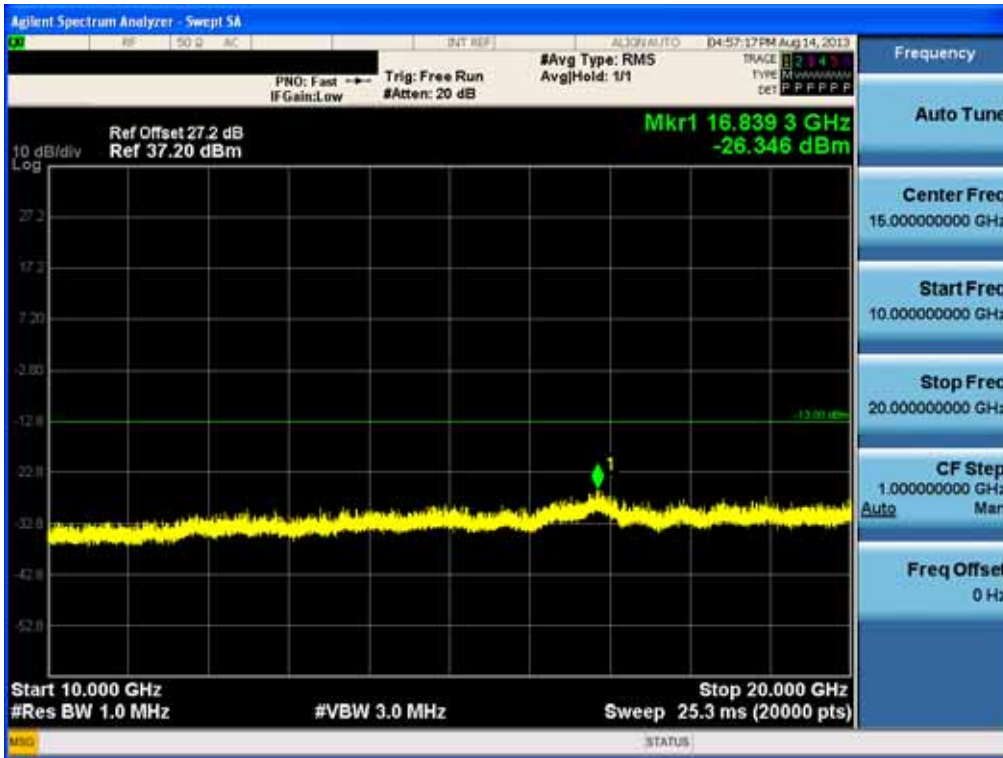

■ GSM1900 MODE (661 CH) Conducted Spurious Emissions1

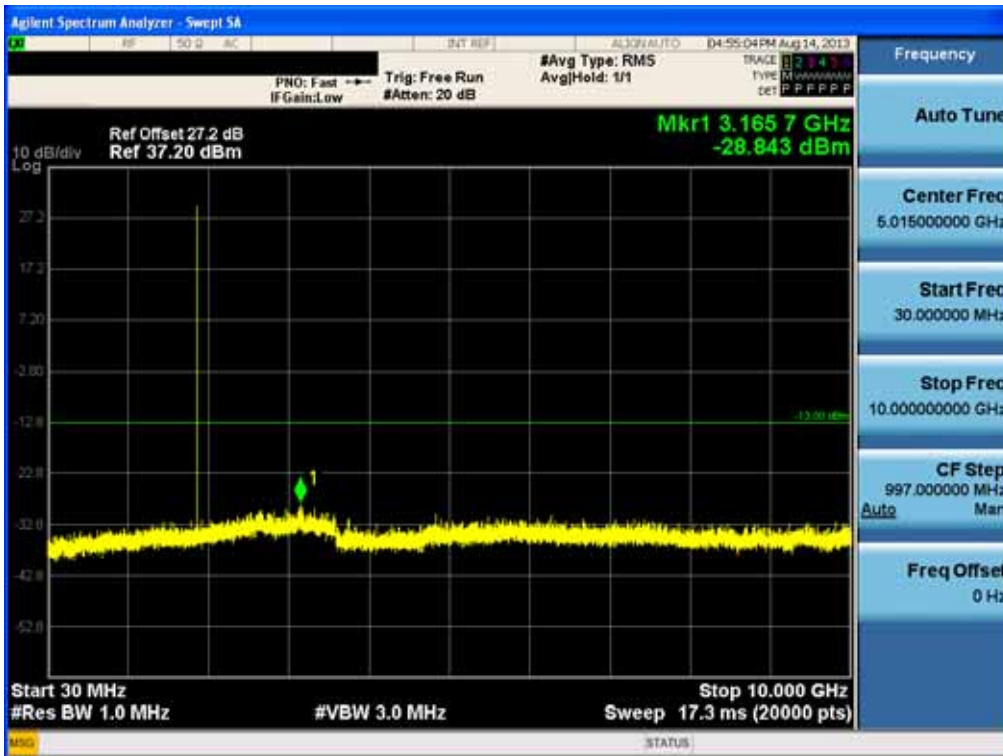

FCC CERTIFICATION REPORT

www.hct.co.kr

Test Report No.
HCTR1308FR29

Date of Issue:
August 21, 2013

EUT Type:
850/1900 GSM/GPRS Phone with BT v4.0(LE) , 802.11b/g/n and EDGE Rx only, Hotspot

FCC ID:
A3LGTS7392

■ GSM1900 MODE (661 CH.) Conducted Spurious Emissions2

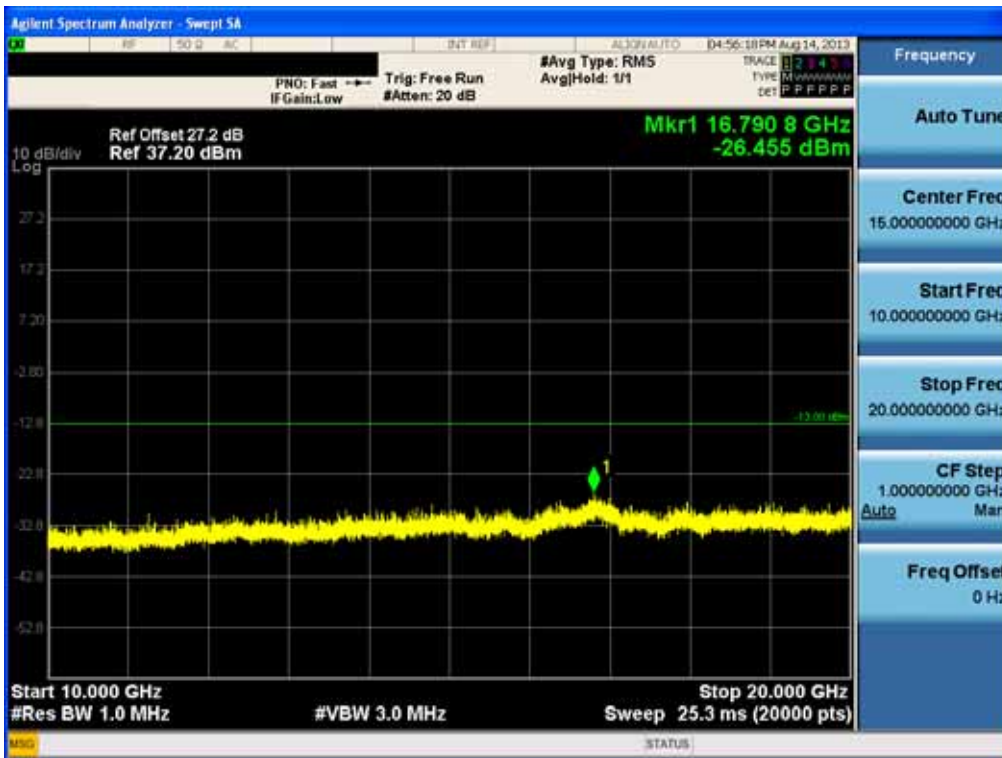

■ GSM1900 MODE (810 CH.) Conducted Spurious Emissions1

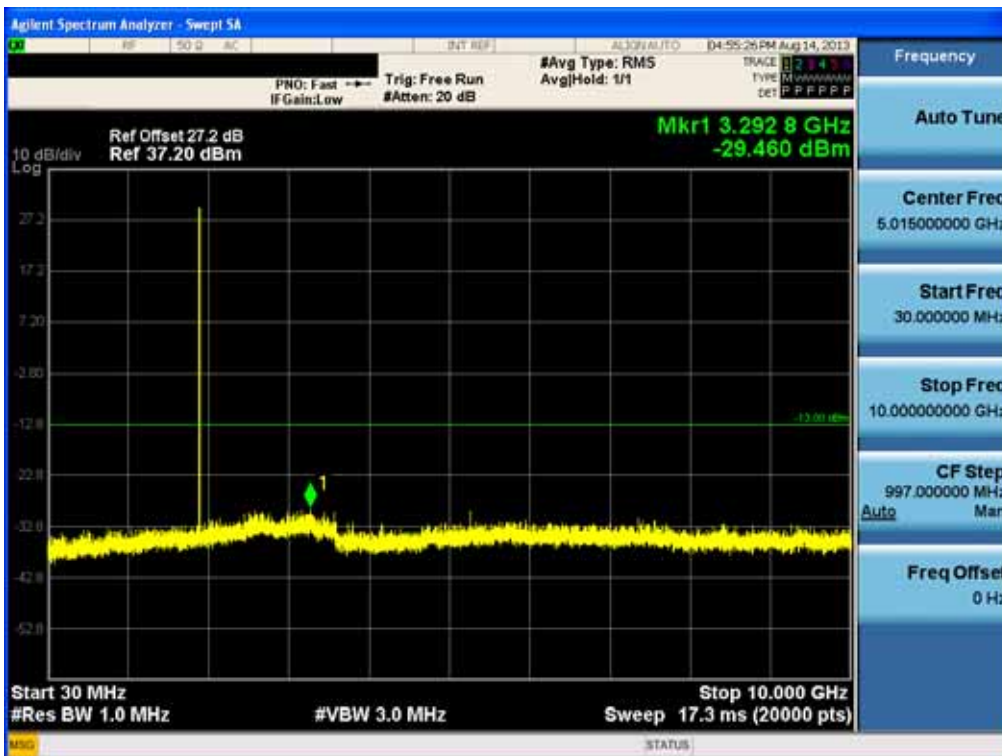

FCC CERTIFICATION REPORT

www.hct.co.kr

Test Report No.
HCTR1308FR29

Date of Issue:
August 21, 2013

EUT Type:
850/1900 GSM/GPRS Phone with BT v4.0(LE) , 802.11b/g/n and EDGE Rx only, Hotspot

FCC ID:
A3LGTS7392

