

# FCC RF Test Report

APPLICANT : Samsung Electronics Co., Ltd.  
EQUIPMENT : MOBILE PHONE  
BRAND NAME : SAMSUNG  
MODEL NAME : GT-S7278U  
FCC ID : A3LGTS7278U  
STANDARD : FCC 47 CFR Part 2, 24(E)  
CLASSIFICATION : PCS Licensed Transmitter Held to Ear (PCE)

The product was received on Oct. 31, 2013 and testing was completed on Nov. 15, 2013. We, SPORTON INTERNATIONAL (SHENZHEN) INC., would like to declare that the tested sample has been evaluated in accordance with the procedures given in ANSI / TIA / EIA-603-C-2004 and shown to be compliant with the applicable technical standards.

The test results in this report apply exclusively to the tested model / sample. Without written approval of SPORTON INTERNATIONAL (SHENZHEN) INC., the test report shall not be reproduced except in full.



Reviewed by: Joseph Lin / Supervisor

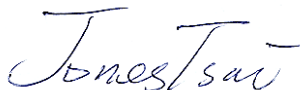

Approved by: Jones Tsai / Manager



## **SPORTON INTERNATIONAL (SHENZHEN) INC.**

**No. 3 Building, the third floor of south, Shahe River west, Fengzeyuan warehouse, Nanshan District, Shenzhen, Guangdong, P.R.C.**



## TABLE OF CONTENTS

REVISION HISTORY.....	3
SUMMARY OF TEST RESULT .....	4
<b>1 GENERAL DESCRIPTION .....</b>	<b>5</b>
1.1 Applicant.....	5
1.2 Manufacturer .....	5
1.3 Feature of Equipment Under Test.....	5
1.4 Product Specification of Equipment Under Test .....	5
1.5 Modification of EUT.....	6
1.6 Maximum EIRP Power, Frequency Tolerance, and Emission Designator.....	6
1.7 Testing Site .....	6
1.8 Applied Standards.....	6
<b>2 TEST CONFIGURATION OF EQUIPMENT UNDER TEST.....</b>	<b>7</b>
2.1 Test Mode.....	7
2.2 Connection Diagram of Test System .....	9
2.3 Support Unit used in test configuration and system.....	9
2.4 Measurement Results Explanation Example .....	10
<b>3 TEST RESULT.....</b>	<b>11</b>
3.1 Conducted Output Power Measurement.....	11
3.2 Peak-to-Average Ratio .....	13
3.3 Effective Isotropic Radiated Power Measurement .....	19
3.4 99% Occupied Bandwidth and 26dB Bandwidth Measurement.....	22
3.5 Band Edge Measurement.....	30
3.6 Conducted Spurious Emission Measurement.....	35
3.7 Field Strength of Spurious Radiation Measurement .....	56
3.8 Frequency Stability Measurement.....	70
<b>4 LIST OF MEASURING EQUIPMENT .....</b>	<b>74</b>
<b>5 UNCERTAINTY OF EVALUATION.....</b>	<b>75</b>



## SUMMARY OF TEST RESULT

Report Section	FCC Rule	Description	Limit	Result	Remark
3.1	§2.1046	Conducted Output Power	N/A	PASS	-
3.2	§24.232(d)	Peak-to-Average Ratio	< 13 dB	PASS	-
3.3	§24.232(c)	Equivalent Isotropic Radiated Power	< 2 Watts	PASS	-
3.4	§2.1049 §24.238(b)	Occupied Bandwidth	N/A	PASS	-
3.5	§2.1051 §24.238(a)	Band Edge Measurement	< 43+10log <sub>10</sub> (P[Watts])	PASS	-
3.6	§2.1051 §24.238(a)	Conducted Spurious Emission	< 43+10log <sub>10</sub> (P[Watts])	PASS	-
3.7	§2.1053 §24.238(a)	Field Strength of Spurious Radiation	< 43+10log <sub>10</sub> (P[Watts])	PASS	Under limit 33.86 dB at 5640.000 MHz
3.8	§2.1055 §24.235	Frequency Stability for Temperature & Voltage	< 2.5 ppm	PASS	-

# 1 General Description

## 1.1 Applicant

Samsung Electronics Co., Ltd.

No.9 WeiWu Rd., Micro Electronic Industrial Park, Jingang Highway, Xiqing District, Tianjin, China

## 1.2 Manufacturer

Samsung Electronics Co., Ltd.

No.9 WeiWu Rd., Micro Electronic Industrial Park, Jingang Highway, Xiqing District, Tianjin, China

## 1.3 Feature of Equipment Under Test

Product Feature	
Equipment	MOBILE PHONE
Brand Name	SAMSUNG
Model Name	GT-S7278U
FCC ID	A3LGTS7278U
GSM Operating Band(s)	GSM 900/1800/1900MHz
GPRS/EDGE Multislot Class	GPRS 4 Tx Slots, EDGE 4 Tx Slots
Wi-Fi Specification	2.4GHz 802.11b/g/n HT20
Bluetooth Version	v3.0 + EDR
HW Version	REV1.0
SW Version	S7278U.001
EUT Stage	Identical Prototype

Remark: The above EUT's information was declared by manufacturer. Please refer to the specifications or user's manual for more detailed description.

## 1.4 Product Specification of Equipment Under Test

Product Specification subjective to this standard	
Tx Frequency	1850.2 MHz ~ 1909.8MHz
Rx Frequency	1930.2 MHz ~ 1989.8 MHz
Maximum Output Power to Antenna	29.46 dBm
Antenna Type	Stamping Antenna
Type of Modulation	GSM: GMSK GPRS: GMSK EDGE: GMSK / 8PSK

### 1.5 Modification of EUT

No modifications are made to the EUT during all test items.

### 1.6 Maximum EIRP Power, Frequency Tolerance, and Emission Designator

FCC Rule	System	Type of Modulation	Maximum EIRP (W)	Frequency Tolerance (% , Hz, ppm)	Emission Designator
Part 24	GSM1900 GSM	GMSK	0.72	0.01 ppm	246KGXW
Part 24	GSM1900 EDGE 1 Tx Slot	8PSK	0.42	0.01 ppm	244KG7W

### 1.7 Testing Site

<b>Test Site</b>	SPORTON INTERNATIONAL (SHENZHEN) INC.		
<b>Test Site Location</b>	No. 3 Building, the third floor of south, Shahe River west, Fengzeyuan warehouse, Nanshan District, Shenzhen, Guangdong, P.R.C. TEL: +86-755-3320-2398		
<b>Test Site No.</b>	<b>Sporton Site No.</b>		<b>FCC Registration No.</b>
	TH01-SZ	03CH01-SZ	831040

### 1.8 Applied Standards

According to the specifications of the manufacturer, the EUT must comply with the requirements of the following standards:

- FCC 47 CFR Part 2, 24(E)
- ANSI / TIA / EIA-603-C-2004
- FCC KDB 971168 D01 Power Meas. License Digital Systems v02r01

**Remark:**

1. All test items were verified and recorded according to the standards and without any deviation during the test.
2. This EUT has also been tested and complied with the requirements of FCC Part 15, Subpart B, recorded in a separate test report.

## 2 Test Configuration of Equipment Under Test

### 2.1 Test Mode

During all testing, EUT is in link mode with base station emulator at maximum power level. The spurious emission measurements were carried out in semi-anechoic chamber with 3-meter test range, and EUT was rotated on three test planes to find out the worst emission (Y plane).

Frequency range investigated for radiated emission is from 30 MHz to 19000 MHz.

Test Modes		
Band	Radiated TCs	Conducted TCs
GSM 1900	■ GSM Link	■ GSM Link
GSM 1900	■ EDGE 1 Tx slot Link	■ EDGE 1 Tx slot Link

**Note:** We select the highest output power of each modulation to perform all testing, i.e., GSM mode for GMSK modulation, EDGE multi-slot 1 Tx slot for 8PSK modulation.



The conducted power tables are as follows:

For SIM1

Conducted Power (*Unit: dBm)			
Band	GSM1900		
Channel	512	661	810
Frequency	1850.2	1880.0	1909.8
GSM (GMSK, 1 Tx slot)	29.35	29.34	29.46
GPRS (GMSK, 1 Tx slot) – CS1	29.34	29.33	29.45
GPRS (GMSK, 2 Tx slots) – CS1	28.80	28.54	28.90
GPRS (GMSK, 3 Tx slot) – CS1	26.27	26.34	26.51
GPRS (GMSK, 4 Tx slots) – CS1	24.30	24.40	24.61
EDGE (GMSK, 1 Tx slot) – MCS1	26.28	26.35	26.55
EDGE (GMSK, 2 Tx slots) – MCS1	26.22	26.28	26.46
EDGE (GMSK, 3 Tx slots) – MCS1	26.25	26.32	26.49
EDGE (GMSK, 4 Tx slots) – MCS1	24.26	24.38	24.57

For SIM2

Conducted Power (*Unit: dBm)			
Band	GSM1900		
Channel	512	661	810
Frequency	1850.2	1880.0	1909.8
GSM (GMSK, 1 Tx slot)	29.33	29.32	29.45
GPRS (GMSK, 1 Tx slot) – CS1	29.32	29.31	29.44
GPRS (GMSK, 2 Tx slots) – CS1	28.79	28.51	28.89
GPRS (GMSK, 3 Tx slots) – CS1	26.25	26.31	26.49
GPRS (GMSK, 4 Tx slots) – CS1	24.27	24.37	24.58
EDGE (GMSK, 1 Tx slot) – MCS1	26.20	26.26	26.43
EDGE (GMSK, 2 Tx slots) – MCS1	26.23	26.29	26.46
EDGE (GMSK, 3 Tx slots) – MCS1	26.26	26.32	26.50
EDGE (GMSK, 4 Tx slots) – MCS1	24.28	24.39	24.59

## 2.2 Connection Diagram of Test System

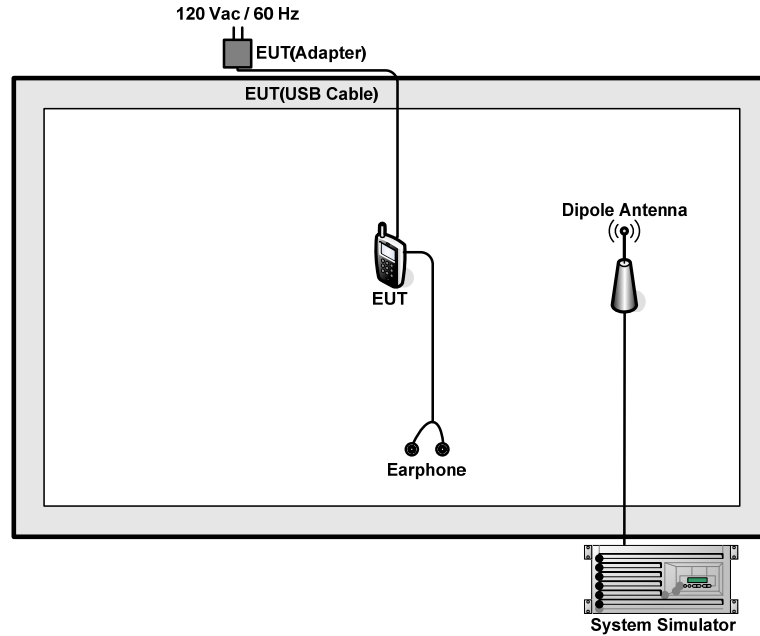

## 2.3 Support Unit used in test configuration and system

Item	Equipment	Trade Name	Model No.	FCC ID	Data Cable	Power Cord
1.	System Simulator	Agilent	E5515C	N/A	N/A	Unshielded, 1.8 m
2.	DC Power Supply	TOPWORD	3303DR	N/A	N/A	Unshielded, 1.8 m
3.	Earphone	SAMSUNG	EHS61ASFWE	N/A	Unshielded, 1.2 m	N/A

## 2.4 Measurement Results Explanation Example

For all conducted test items:

The offset level is set in the spectrum analyzer to compensate the RF cable loss and attenuator factor between EUT conducted output port and spectrum analyzer. With the offset compensation, the spectrum analyzer reading level is exactly the EUT RF output level.

Example :

The spectrum analyzer offset is derived from RF cable loss and attenuator factor.

*Offset = RF cable loss + attenuator factor.*

Following shows an offset computation example with cable loss 7.5 dB and 10dB attenuator.

$$\begin{aligned} \text{Offset(dB)} &= \text{RF cable loss(dB)} + \text{attenuator factor(dB)}. \\ &= 7.5 + 10 = 17.5 \text{ (dB)} \end{aligned}$$

### 3 Test Result

#### 3.1 Conducted Output Power Measurement

##### 3.1.1 Description of the Conducted Output Power Measurement

A base station simulator was used to establish communication with the EUT. Its parameters were set to transmit the maximum power on the EUT. The measured power in the radio frequency on the transmitter output terminals shall be reported.

##### 3.1.2 Measuring Instruments

See list of measuring instruments of this test report.

##### 3.1.3 Test Procedures

1. The transmitter output port was connected to base station.
2. Set EUT at maximum power through base station.
3. Select lowest, middle, and highest channels for each band and different modulation.
4. Measure the maximum burst average power for GSM and maximum average power for other modulation signal.

##### 3.1.4 Test Setup

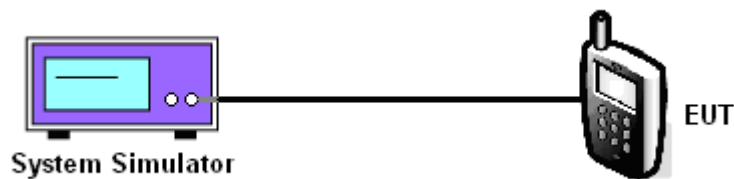

**3.1.5 Test Result of Conducted Output Power**

PCS Band						
Modes	GSM1900 (GSM)			GSM1900 (EDGE 1 Tx Slot)		
Channel	512 (Low)	661 (Mid)	810 (High)	512 (Low)	661 (Mid)	810 (High)
Frequency (MHz)	1850.2	1880	1909.8	1850.2	1880	1909.8
<b>Conducted Power (dBm)</b>	29.35	29.34	29.46	26.28	26.35	26.55
<b>Conducted Power (Watts)</b>	0.86	0.86	0.88	0.42	0.43	0.45

**Note:** Maximum burst average power for GSM.

## 3.2 Peak-to-Average Ratio

### 3.2.1 Description of the PAR Measurement

The peak-to-average ratio (PAR) of the transmission may not exceed 13 dB.

### 3.2.2 Measuring Instruments

See list of measuring instruments of this test report.

### 3.2.3 Test Procedures

1. The EUT was connected to Spectrum Analyzer and System Simulator via power divider.
2. For GSM operating modes:
  - a. Set EUT in maximum power output.
  - b. Set the RBW = 1MHz, VBW = 3MHz, Peak detector in spectrum analyzer for first trace.
  - c. Set the RBW = 1MHz, VBW = 3MHz, RMS detector in spectrum analyzer for second trace.
  - d. The wanted burst signal is triggered by spectrum analyzer, and measured respectively the peak level and Mean level without burst-off time, after system simulator synchronized with the spectrum analyzer.
3. Record the deviation as Peak to Average Ratio.

### 3.2.4 Test Setup

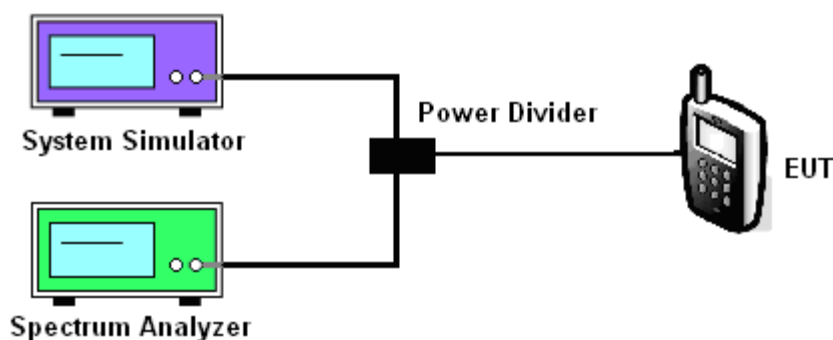



### 3.2.5 Test Result of Peak-to-Average Ratio

PCS Band						
Modes	GSM1900 (GSM)			GSM1900 (EDGE 1 Tx Slot)		
Channel	512 (Low)	661 (Mid)	810 (High)	512 (Low)	661 (Mid)	810 (High)
Frequency (MHz)	1850.2	1880	1909.8	1850.2	1880	1909.8
Peak-to-Average Ratio (dB)	0.29	0.29	0.30	3.13	3.12	3.13



### 3.2.6 Test Result (Plots) of Peak-to-Average Ratio

Band :	GSM 1900	Test Mode :	GSM Link (GMSK)
--------	----------	-------------	-----------------

Peak-to-Average Ratio on Channel 512 (1850.2 MHz)

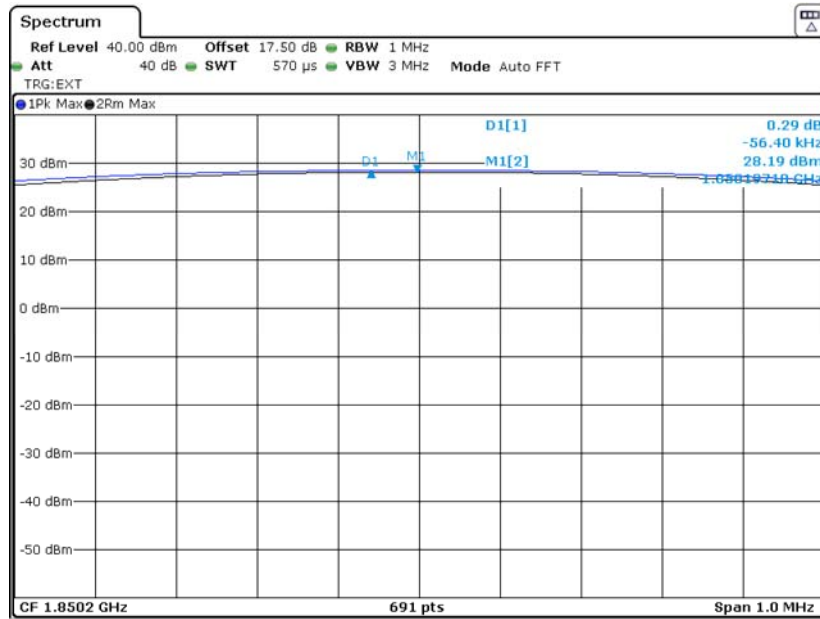

Date: 12.NOV.2013 08:44:52

Peak-to-Average Ratio on Channel 661 (1880.0 MHz)

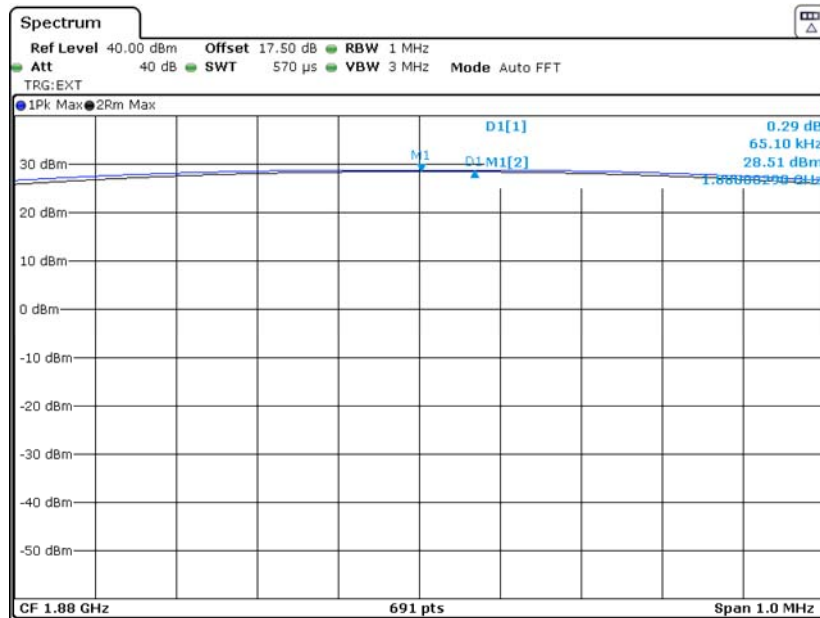

Date: 12.NOV.2013 08:44:11



Peak-to-Average Ratio on Channel 810 (1909.8 MHz)



Date: 12.NOV.2013 08:45:28



<b>Band :</b>	GSM 1900	<b>Test Mode :</b>	EDGE 1 Tx Slot Link (8PSK)
---------------	----------	--------------------	----------------------------

**Peak-to-Average Ratio on Channel 512 (1850.2 MHz)**

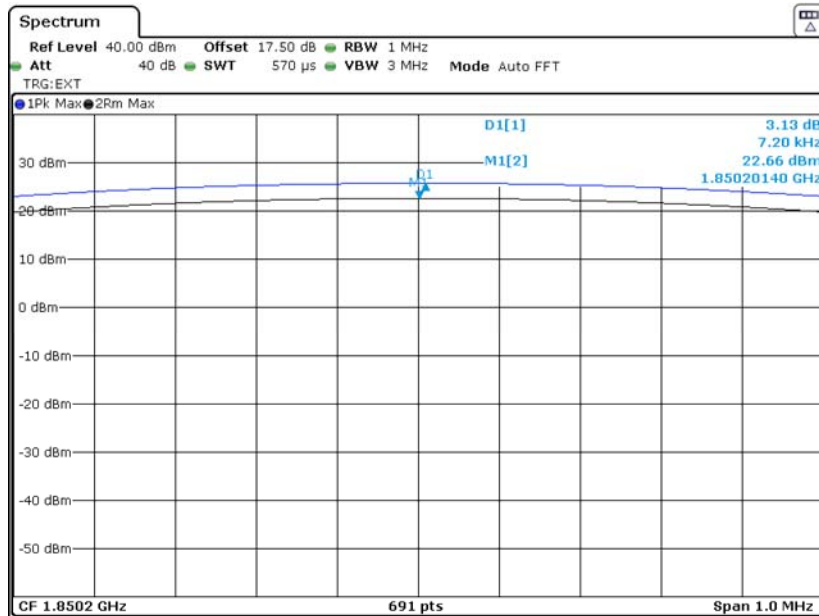

Date: 12.NOV.2013 08:47:39

**Peak-to-Average Ratio on Channel 661 (1880.0 MHz)**

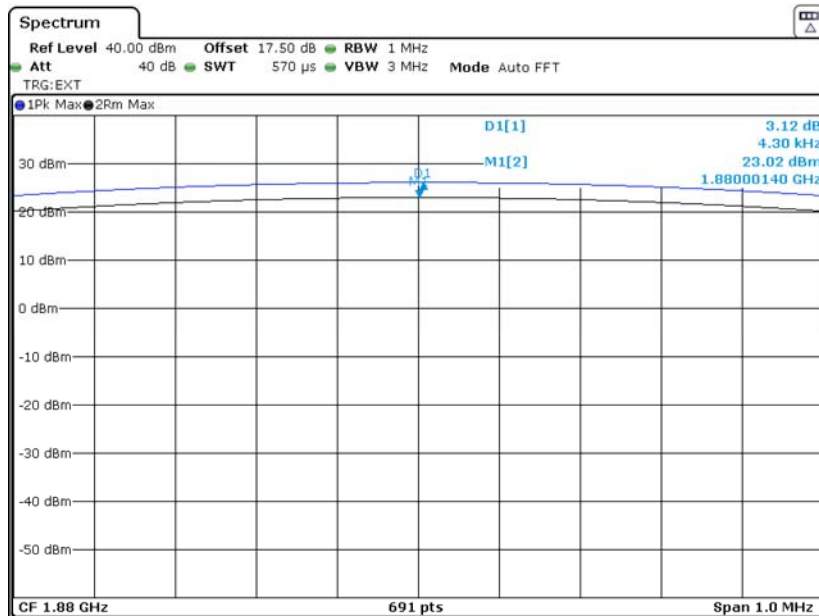

Date: 12.NOV.2013 08:47:03



Peak-to-Average Ratio on Channel 810 (1909.8 MHz)

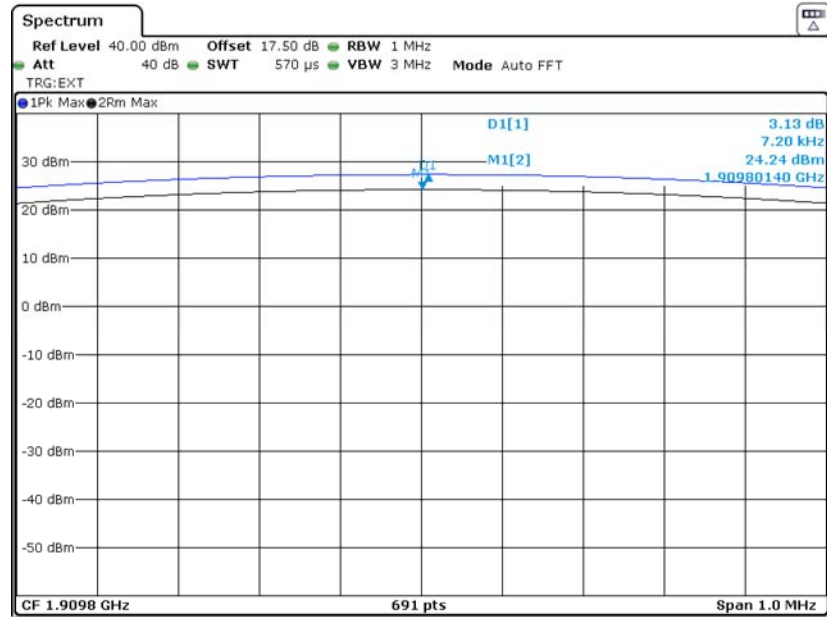

Date: 12.NOV.2013 08:48:11

### 3.3 Effective Isotropic Radiated Power Measurement

#### 3.3.1 Description of the EIRP Measurement

The substitution method, in ANSI / TIA / EIA-603-C-2004, was used for EIRP measurement, and the spectrum analyzer configuration follows KDB 971168 D01 Power Meas. License Digital Systems v02r01. The EIRP of mobile transmitters are limited to 2 Watts.

#### 3.3.2 Measuring Instruments

See list of measuring instruments of this test report.

#### 3.3.3 Test Procedures

1. The EUT was placed on an non-conductive rotating platform with 0.8 meter height in a semi-anechoic chamber. The radiated emission at the fundamental frequency was measured at 3 m with a test antenna and a spectrum analyzer with RBW= 1MHz, VBW= 3MHz for GSM per KDB 971168 D01.
2. During the measurement, the EUT was enforced in maximum power and linked with a base station. The highest emission was recorded from analyzer power level (LVL) from the 360 degrees rotation of the turntable and the test antenna raised and lowered over a range from 1 to 4 meters in both horizontally and vertically polarized orientations.
3. Effective Isotropic Radiated Power (EIRP) was measured by substitution method according to TIA/EIA-603-C. The EUT was replaced by dipole antenna (substitution antenna) at same location, and then a known power from S.G. was applied into the dipole antenna through a Tx cable, and then recorded the maximum Analyzer reading through raised and lowered the test antenna. The correction factor (in dB) = S.G. - Tx Cable loss + Substitution antenna gain - Analyzer reading. Then the EUT's EIRP was calculated with the correction factor,  $EIRP = LVL + \text{Correction factor}$  and  $ERP = EIRP - 2.15$ .

### 3.3.4 Test Setup

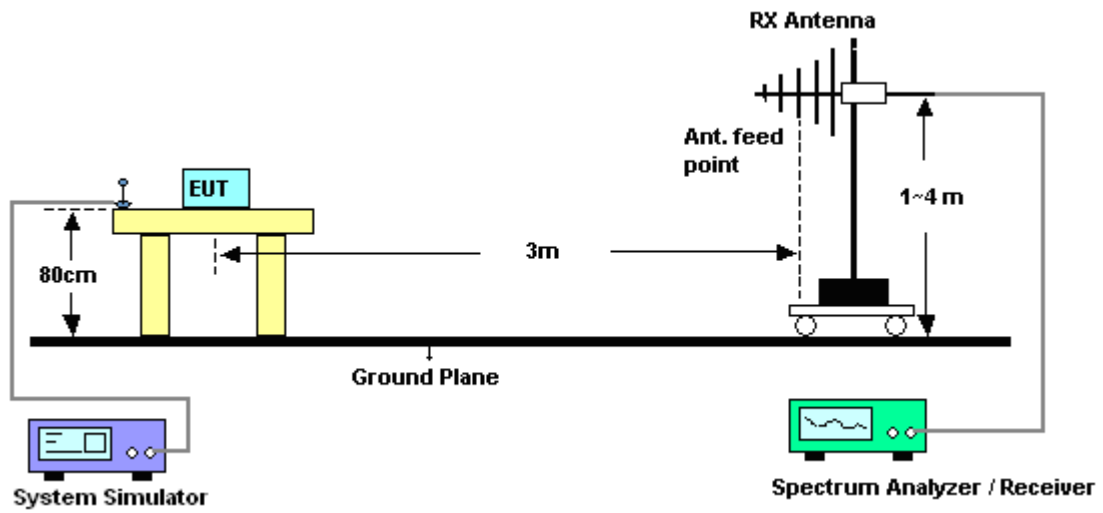

3.3.5 Test Result of EIRP

GSM1900 (GSM) Radiated Power EIRP				
Horizontal Polarization				
Frequency (MHz)	LVL (dBm)	Correction Factor (dB)	EIRP (dBm)	EIRP (W)
1850.2	-14.76	42.33	27.57	0.57
1880.0	-14.85	43.26	28.41	0.69
1909.8	-14.54	43.11	28.57	0.72
Vertical Polarization				
Frequency (MHz)	LVL (dBm)	Correction Factor (dB)	EIRP (dBm)	EIRP (W)
1850.2	-20.69	44.96	24.27	0.27
1880.0	-21.18	45.13	23.95	0.25
1909.8	-20.68	45.47	24.79	0.30

\* EIRP = LVL (dBm) + Correction Factor (dB)

GSM1900 (EDGE 1 Tx Slot) Radiated Power EIRP				
Horizontal Polarization				
Frequency (MHz)	LVL (dBm)	Correction Factor (dB)	EIRP (dBm)	EIRP (W)
1850.2	-16.98	42.33	25.35	0.34
1880.0	-17.46	43.26	25.80	0.38
1909.8	-16.90	43.11	26.21	0.42
Vertical Polarization				
Frequency (MHz)	LVL (dBm)	Correction Factor (dB)	EIRP (dBm)	EIRP (W)
1850.2	-23.86	44.96	21.10	0.13
1880.0	-24.44	45.13	20.69	0.12
1909.8	-22.96	45.47	22.51	0.18

## 3.4 99% Occupied Bandwidth and 26dB Bandwidth Measurement

### 3.4.1 Description of 99% Occupied Bandwidth and 26dB Bandwidth Measurement

The 99% occupied bandwidth is the width of a frequency band such that, below the lower and above the upper frequency limits, the mean powers emitted are each equal to a specified percentage 0.5% of the total mean transmitted power.

The emission bandwidth is defined as the width of the signal between two points, located at the 2 sides of the carrier frequency, outside of which all emissions are attenuated at least 26 dB below the transmitter power.

### 3.4.2 Measuring Instruments

See list of measuring instruments of this test report.

### 3.4.3 Test Procedures

4. The EUT was connected to Spectrum Analyzer and Base Station via power divider.
5. The RF output of EUT was connected to the spectrum analyzer by RF cable and attenuator. The path loss was compensated to the results for each measurement.
6. The 99% occupied bandwidth were measured, set RBW= 1% of span, VBW= 3\*RBW, sample detector, trace maximum hold.
7. The 26dB bandwidth were measured, set RBW= 1% of EBW, VBW= 3\*RBW, peak detector, trace maximum hold.

### 3.4.4 Test Setup

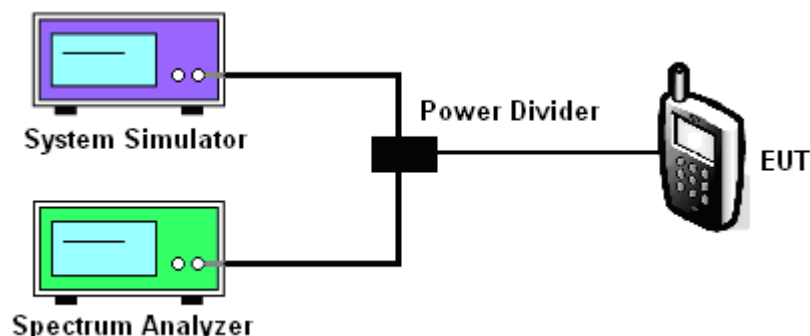

**3.4.5 Test Result of 99% Occupied Bandwidth and 26dB Bandwidth**

PCS Band						
Modes	GSM1900 (GSM)			GSM1900 (EDGE 1 Tx Slot)		
Channel	512 (Low)	661 (Mid)	810 (High)	512 (Low)	661 (Mid)	810 (High)
Frequency (MHz)	1850.2	1880	1909.8	1850.2	1880	1909.8
99% OBW (kHz)	246.00	246.00	244.00	240.00	242.00	244.00
26dB BW (kHz)	314.00	314.00	310.00	304.00	308.00	310.00



3.4.6 Test Result (Plots) of Occupied Bandwidth and 26dB Bandwidth

Band :	GSM 1900	Test Mode :	GSM Link (GMSK)
--------	----------	-------------	-----------------

99% Occupied Bandwidth Plot on Channel 512 (1850.2 MHz)

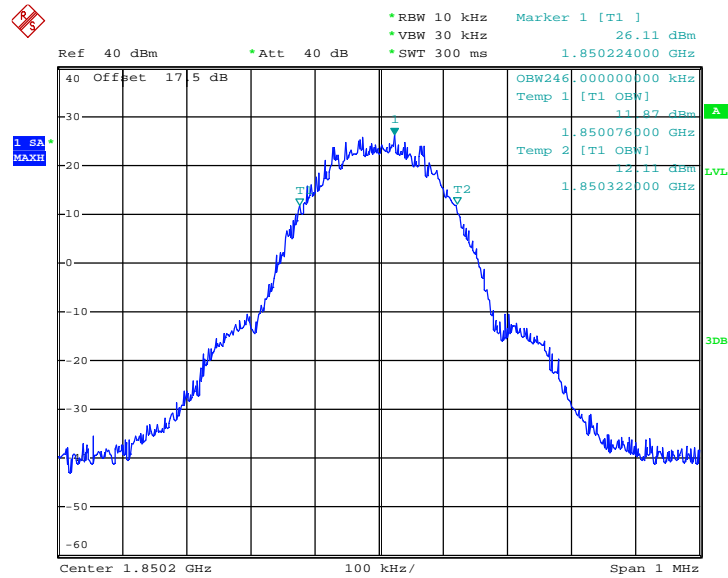

Date: 5.NOV.2013 18:18:50

26dB Bandwidth Plot on Channel 512 (1850.2 MHz)

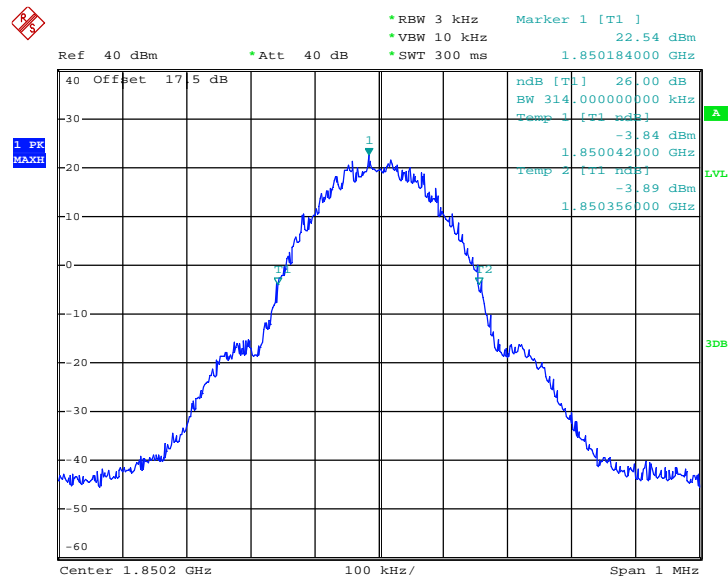

Date: 5.NOV.2013 18:10:36



99% Occupied Bandwidth Plot on Channel 661 (1880.0 MHz)

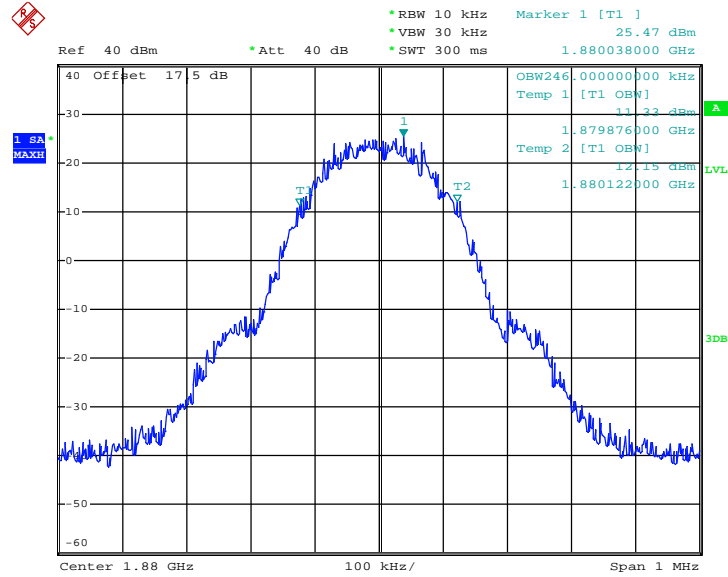

Date: 5.NOV.2013 18:16:42

26dB Bandwidth Plot on Channel 661 (1880.0 MHz)

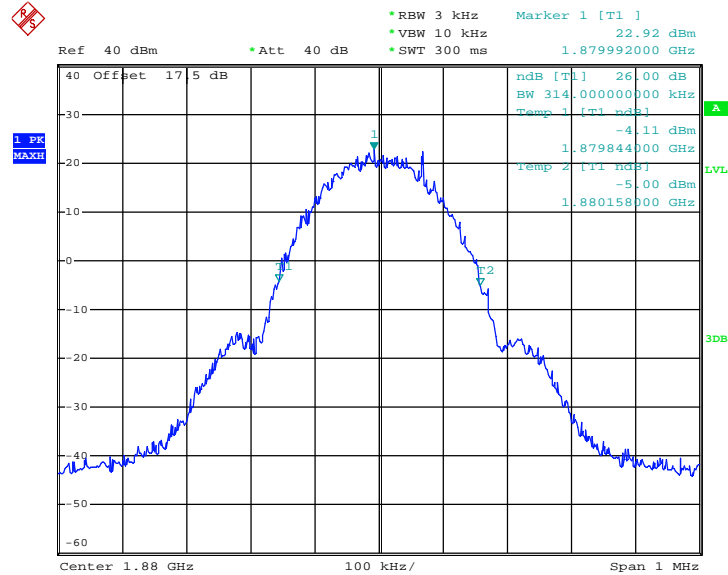

Date: 5.NOV.2013 18:08:29



99% Occupied Bandwidth Plot on Channel 810 (1909.8 MHz)

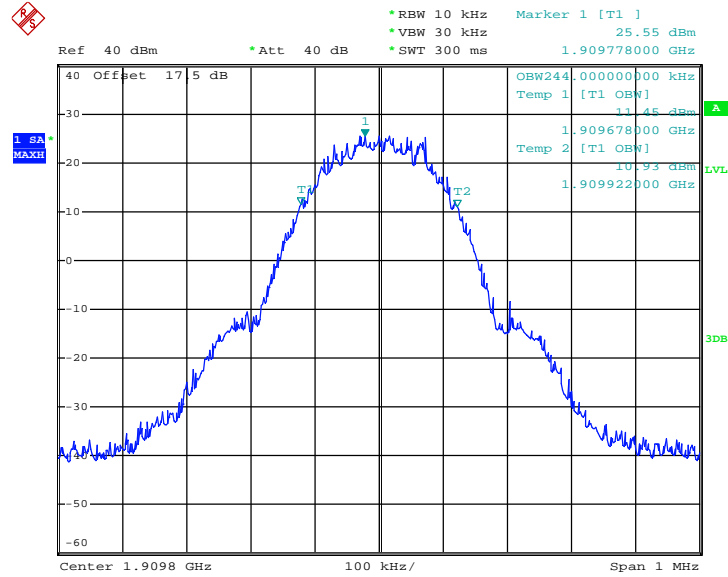

Date: 5.NOV.2013 18:15:17

26dB Bandwidth Plot on Channel 810 (1909.8 MHz)

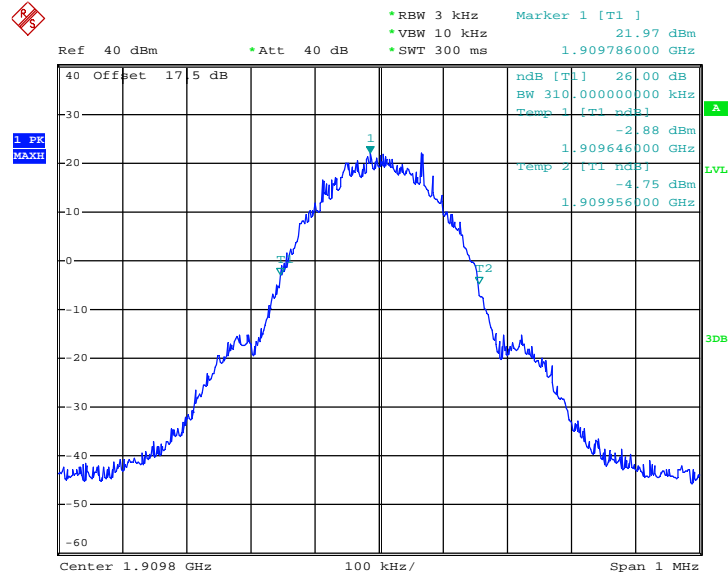

Date: 5.NOV.2013 18:12:08



<b>Band :</b>	GSM 1900	<b>Test Mode :</b>	EDGE 1 Tx Slot Link (8PSK)
---------------	----------	--------------------	-------------------------------

99% Occupied Bandwidth Plot on Channel 512 (1850.2 MHz)

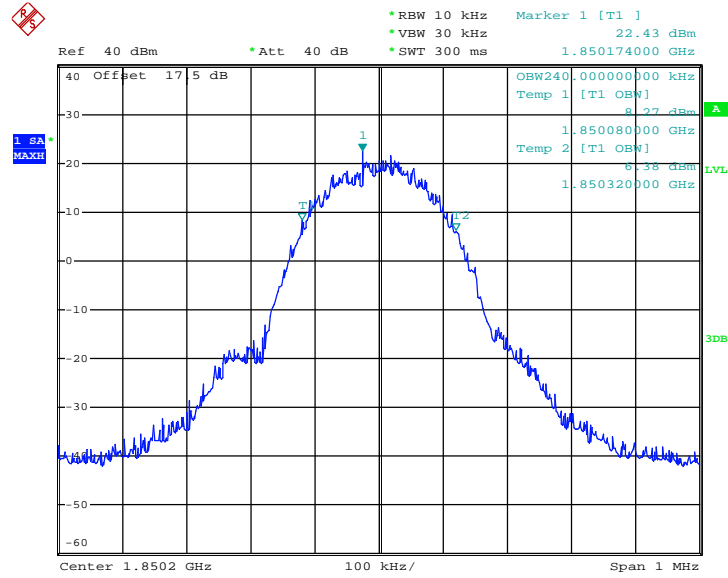

Date: 5.NOV.2013 18:56:57

26dB Bandwidth Plot on Channel 512 (1850.2 MHz)

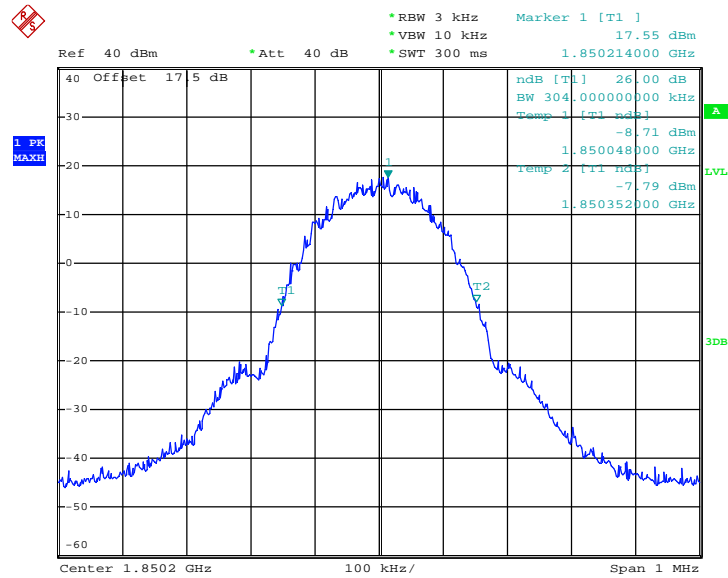

Date: 5.NOV.2013 18:38:58



99% Occupied Bandwidth Plot on Channel 661 (1880.0 MHz)

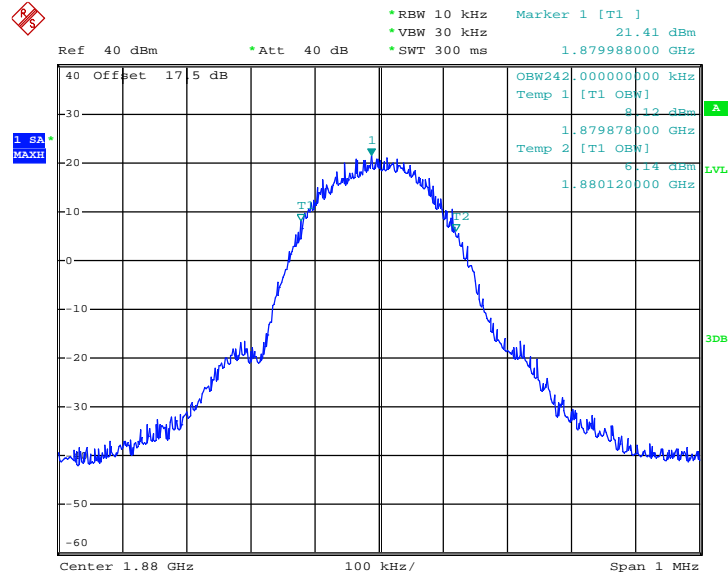

Date: 5.NOV.2013 18:54:04

26dB Bandwidth Plot on Channel 661 (1880.0 MHz)

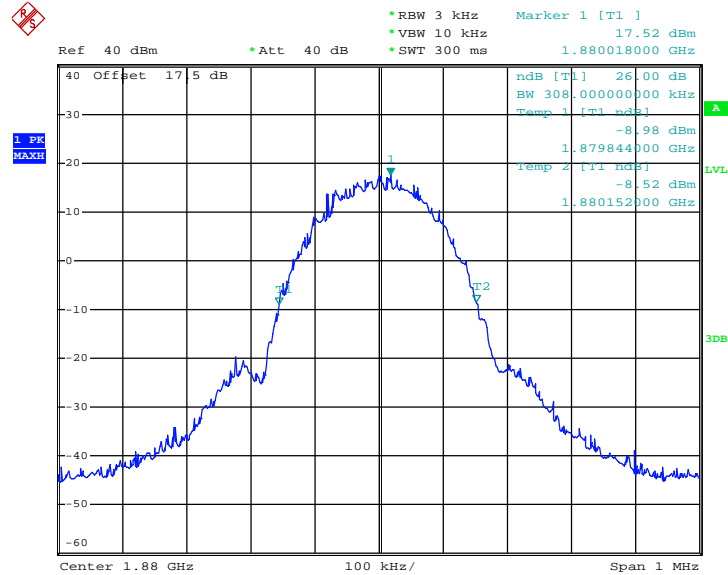

Date: 5.NOV.2013 18:42:05



99% Occupied Bandwidth Plot on Channel 810 (1909.8 MHz)

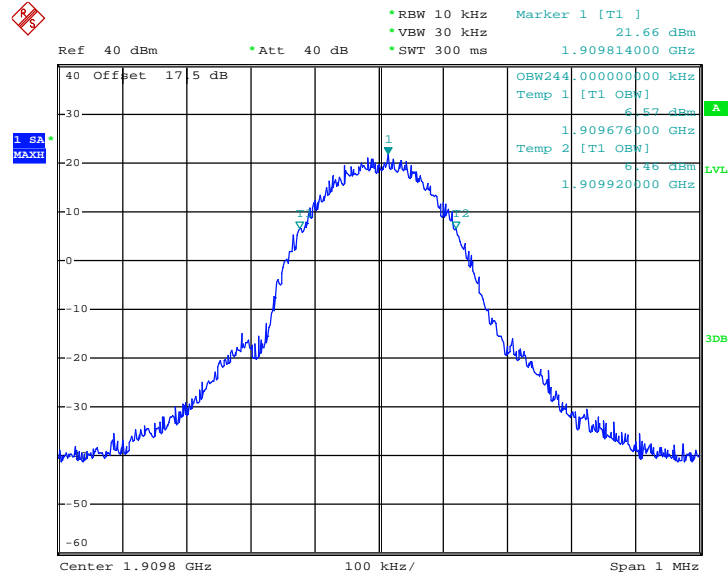

Date: 5.NOV.2013 18:51:14

26dB Bandwidth Plot on Channel 810 (1909.8 MHz)

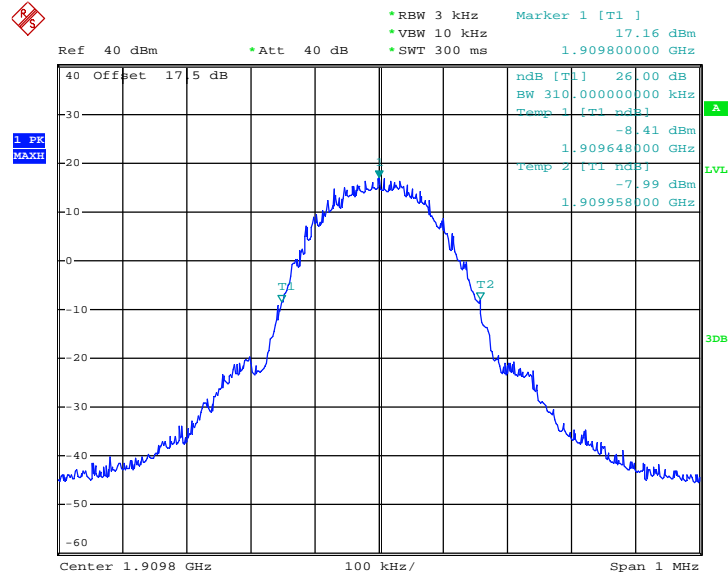

Date: 5.NOV.2013 18:44:33

### 3.5 Band Edge Measurement

#### 3.5.1 Description of Band Edge Measurement

The power of any emission outside of the authorized operating frequency ranges must be lower than the transmitter power (P) by a factor of at least  $43 + 10 \log (P)$  dB.

#### 3.5.2 Measuring Instruments

See list of measuring instruments of this test report.

#### 3.5.3 Test Procedures

1. The EUT was connected to Spectrum Analyzer and Base Station via power divider.
2. The RF output of EUT was connected to the spectrum analyzer by RF cable and attenuator. The path loss was compensated to the results for each measurement.
3. The band edges of low and high channels for the highest RF powers were measured. Setting RBW as roughly  $BW/100$ .
4. The RF fundamental frequency should be excluded against the limit line in the operating frequency band.
5. The limit line is derived from  $43 + 10\log(P)$  dB below the transmitter power P(Watts)
 
$$= P(W) - [43 + 10\log(P)] \text{ (dB)}$$

$$= [30 + 10\log(P)] \text{ (dBm)} - [43 + 10\log(P)] \text{ (dB)}$$

$$= -13\text{dBm}.$$

#### 3.5.4 Test Setup

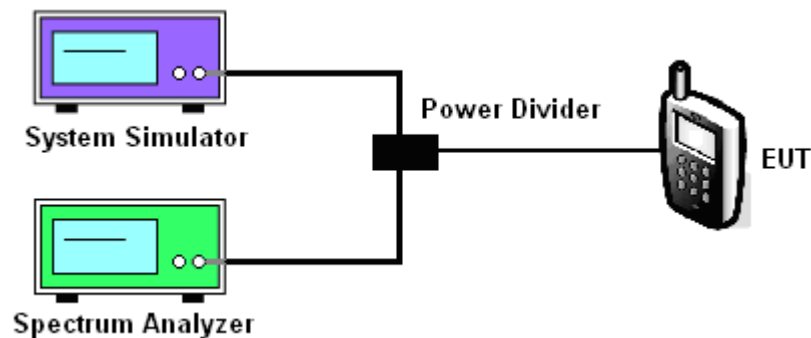

### 3.5.5 Test Result (Plots) of Conducted Band Edge

Band :	GSM1900	Test Mode :	GSM Link (GMSK)
Correction Factor :	0.20dB	Maximum 26dB Bandwidth :	0.314MHz
Band Edge :	-19.24dBm	Measurement Value :	-19.44dBm

Lower Band Edge Plot on Channel 512 (1850.2 MHz)

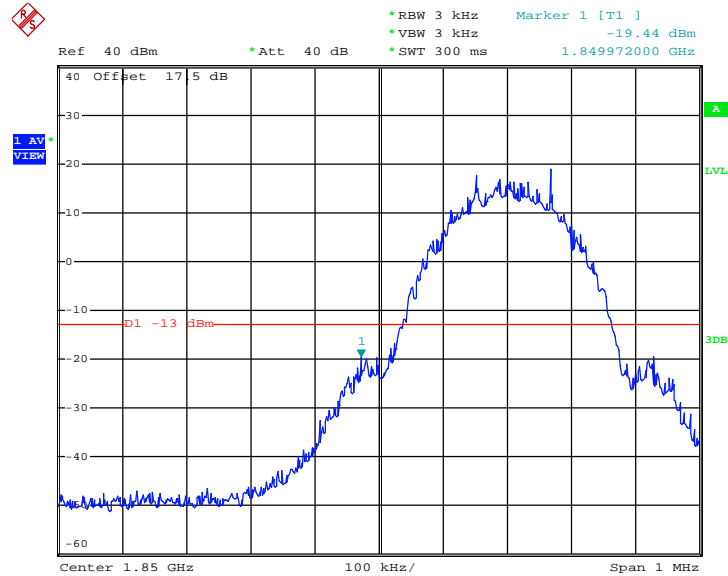

Date: 5.NOV.2013 18:21:17

1. Correction Factor(dB)= 10log(1% Emission BW/RBW)
  2. Band Edge= Measurement Value + Correction Factor(dB)
- For example, -19.44+ 0.20 = -19.24



Band :	GSM1900	Test Mode :	GSM Link (GMSK)
Correction Factor :	0.20dB	Maximum 26dB Bandwidth :	0.314MHz
Band Edge :	-20.94dBm	Measurement Value :	-21.14dBm

Higher Band Edge Plot on Channel 810 (1909.8 MHz)

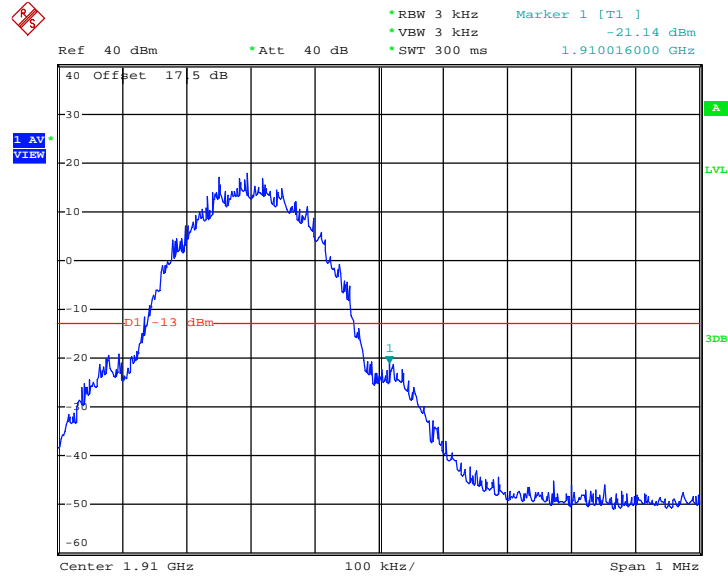

Date: 5.NOV.2013 18:23:09

1. Correction Factor(dB)=  $10\log(1\% \text{ Emission BW/RBW})$
2. Band Edge= Measurement Value + Correction Factor(dB)



Band :	GSM1900	Test Mode :	EDGE 1 Tx Slot Link (8PSK)
Correction Factor :	0.14dB	Maximum 26dB Bandwidth :	0.310MHz
Band Edge :	-24.85dBm	Measurement Value :	-24.99dBm

Lower Band Edge Plot on Channel 512 (1850.2 MHz)

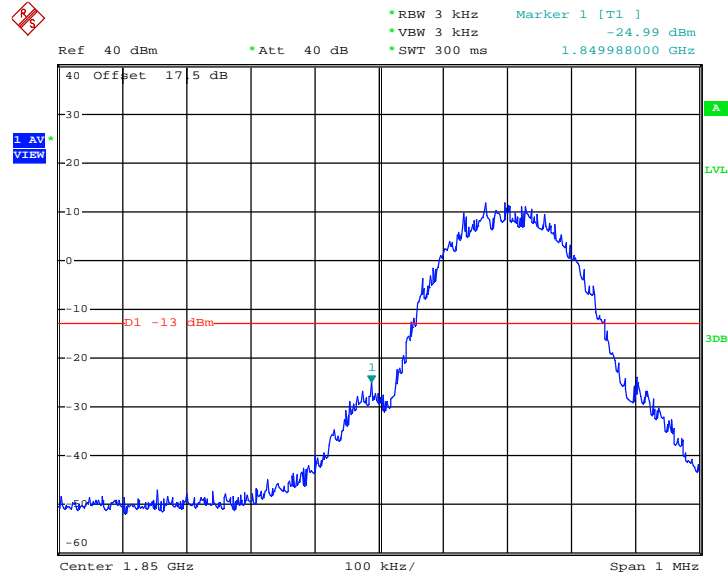

Date: 5.NOV.2013 18:32:59

1. Correction Factor(dB)= 10log(1% Emission BW/RBW)
2. Band Edge= Measurement Value + Correction Factor(dB)



Band :	GSM1900	Test Mode :	EDGE 1 Tx Slot Link (8PSK)
Correction Factor :	0.14dB	Maximum 26dB Bandwidth :	0.310MHz
Band Edge :	-25.81dBm	Measurement Value :	-25.95dBm

Higher Band Edge Plot on Channel 810 (1909.8 MHz)

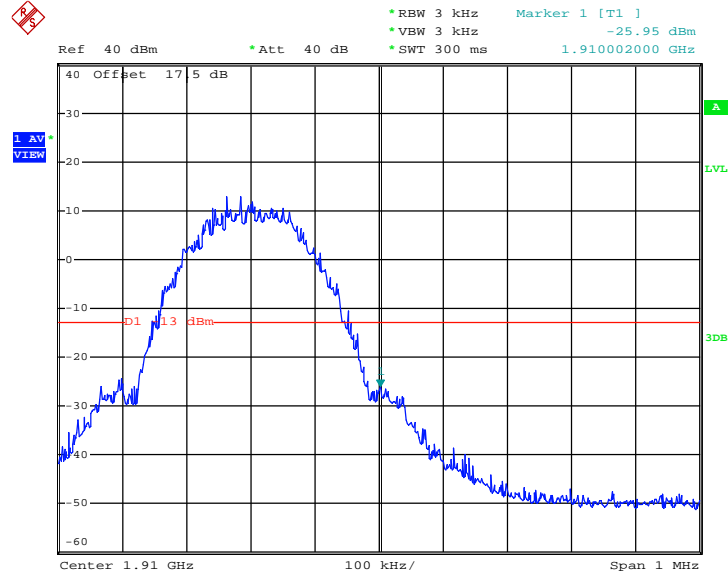

Date: 5.NOV.2013 18:30:53

1. Correction Factor(dB)= 10log(1% Emission BW/RBW)
2. Band Edge= Measurement Value + Correction Factor(dB)

### 3.6 Conducted Spurious Emission Measurement

#### 3.6.1 Description of Conducted Spurious Emission Measurement

The power of any emission outside of the authorized operating frequency ranges must be lower than the transmitter power (P) by a factor of at least  $43 + 10 \log (P)$  dB.

It is measured by means of a calibrated spectrum analyzer and scanned from 30 MHz up to a frequency including its 10<sup>th</sup> harmonic.

#### 3.6.2 Measuring Instruments

See list of measuring instruments of this test report.

#### 3.6.3 Test Procedures

1. The EUT was connected to spectrum analyzer and base station via power divider.
2. The RF output of EUT was connected to the spectrum analyzer by RF cable and attenuator. The path loss was compensated to the results for each measurement.
3. The middle channel for the highest RF power within the transmitting frequency was measured.
4. The conducted spurious emission for the whole frequency range was taken.
5. The RF fundamental frequency should be excluded against the limit line in the operating frequency band.
6. The limit line is derived from  $43 + 10\log(P)$  dB below the transmitter power P(Watts)
 
$$= P(W) - [43 + 10\log(P)] \text{ (dB)}$$

$$= [30 + 10\log(P)] \text{ (dBm)} - [43 + 10\log(P)] \text{ (dB)}$$

$$= -13\text{dBm}$$

#### 3.6.4 Test Setup

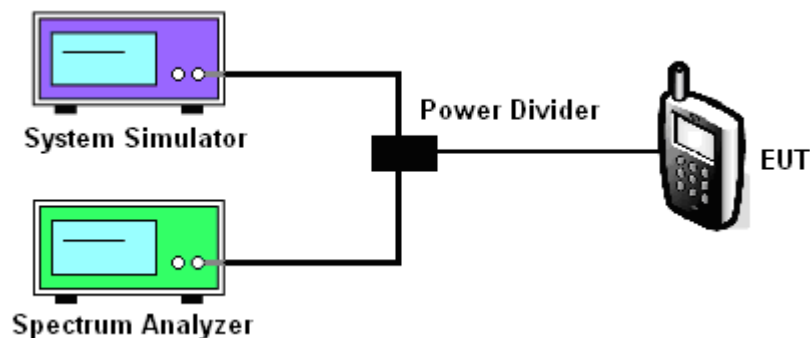

### 3.6.5 Test Result (Plots) of Conducted Spurious Emission

Band :	GSM1900	Channel :	CH512
Test Mode :	GSM Link (GMSK)	Frequency :	1850.2 MHz

Conducted Spurious Emission Plot between 30MHz ~ 1GHz

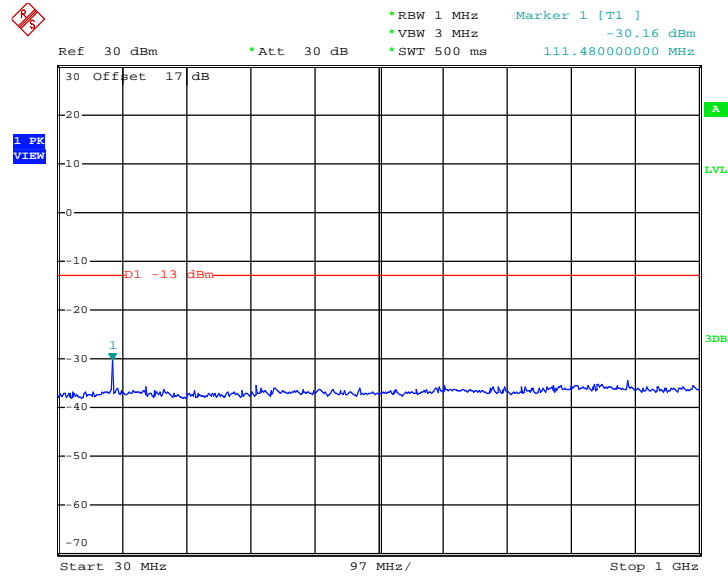

Date: 14.NOV.2013 20:17:35

Conducted Spurious Emission Plot between 1GHz ~ 3GHz

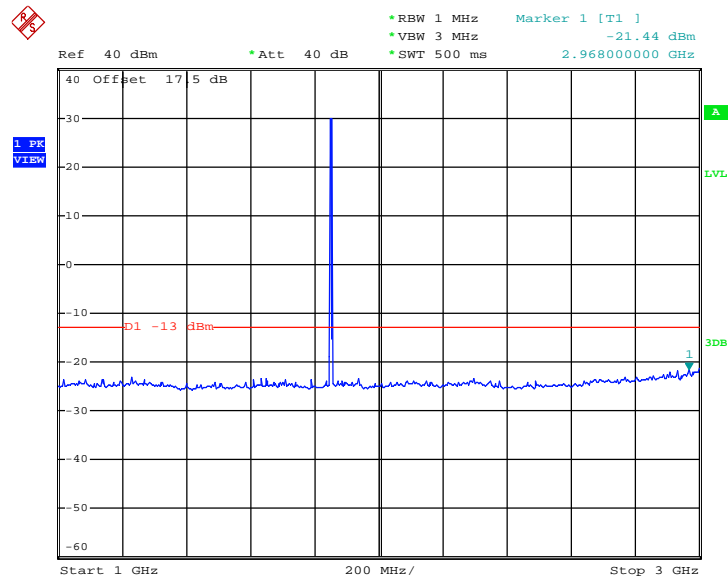

Date: 14.NOV.2013 20:35:00



### Conducted Spurious Emission Plot between 3GHz ~ 7GHz

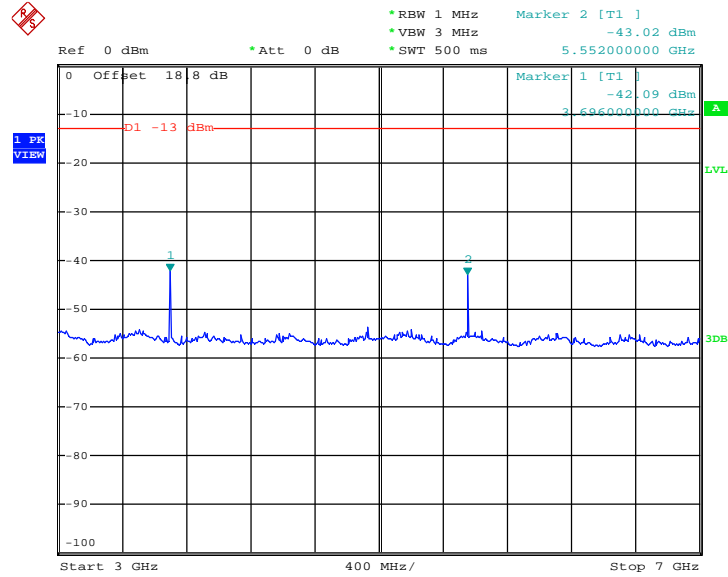

Date: 14.NOV.2013 19:53:51

### Conducted Spurious Emission Plot between 7GHz ~ 13.6GHz

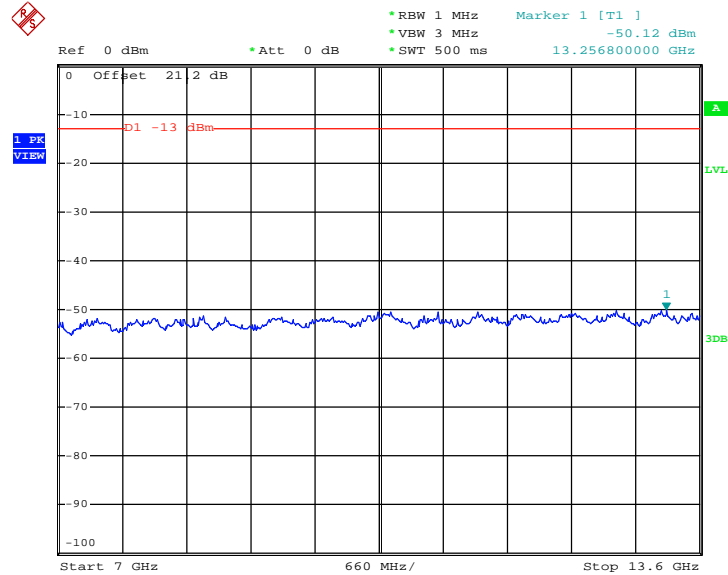

Date: 14.NOV.2013 19:52:12



Conducted Spurious Emission Plot between 13.6GHz ~ 19.1GHz

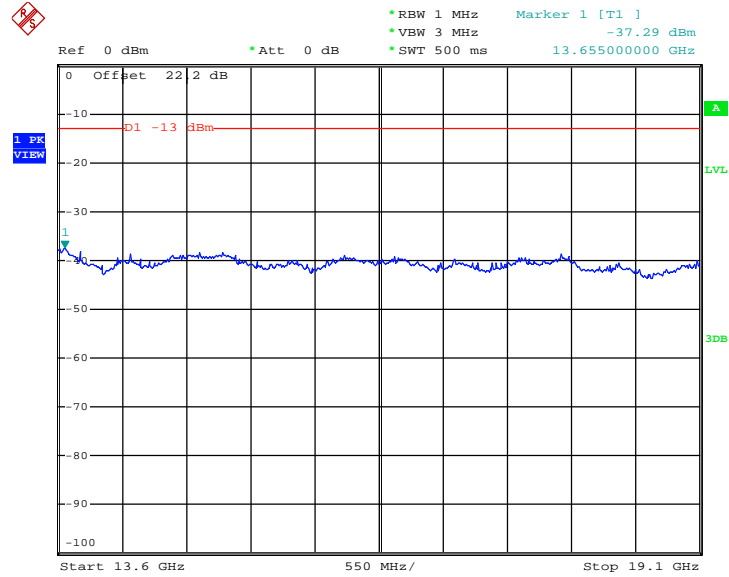

Date: 14.NOV.2013 19:48:31



Band :	GSM1900	Channel :	CH661
Test Mode :	GSM Link (GMSK)	Frequency :	1880.0 MHz

Conducted Spurious Emission Plot between 30MHz ~ 1GHz

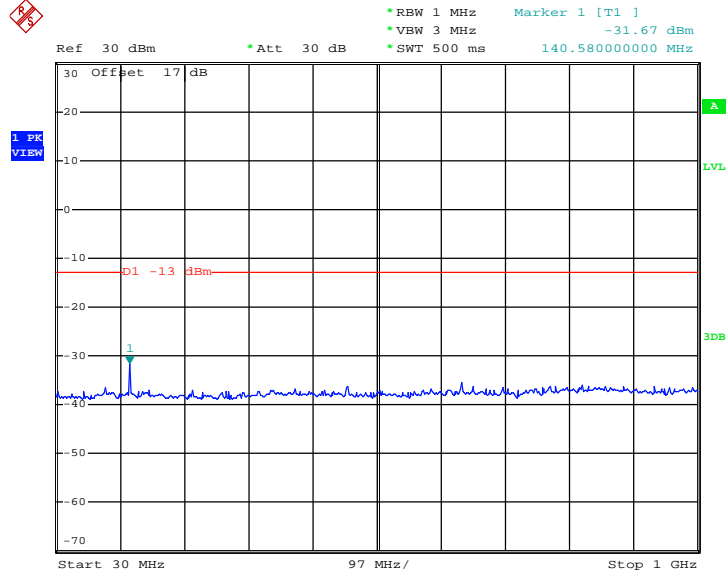

Date: 5.NOV.2013 18:01:42

Conducted Spurious Emission Plot between 1GHz ~ 3GHz

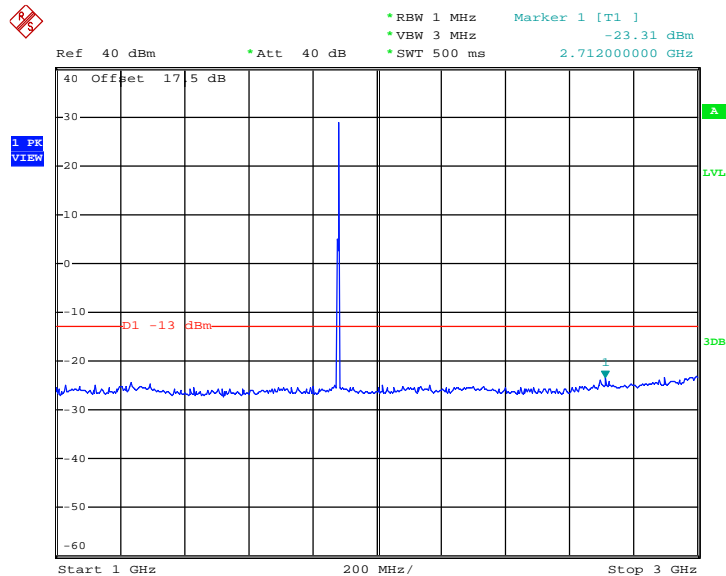

Date: 5.NOV.2013 18:04:20



Conducted Spurious Emission Plot between 3GHz ~ 7GHz

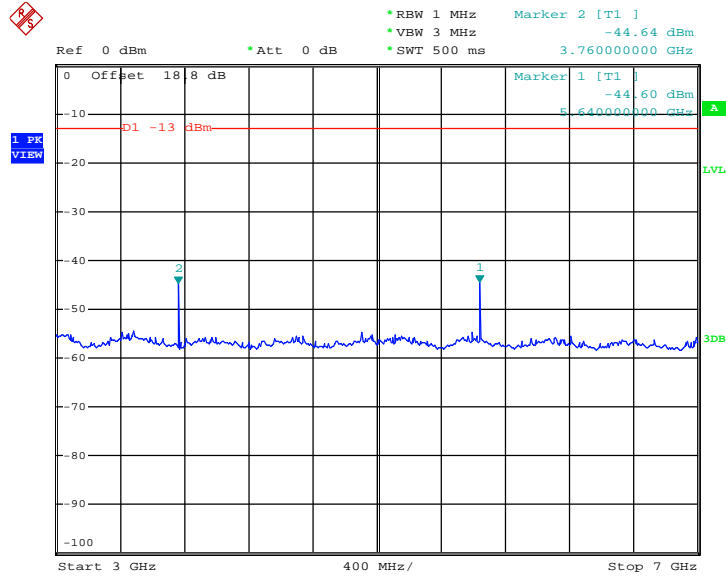

Date: 5.NOV.2013 17:54:11

Conducted Spurious Emission Plot between 7GHz ~ 13.6GHz

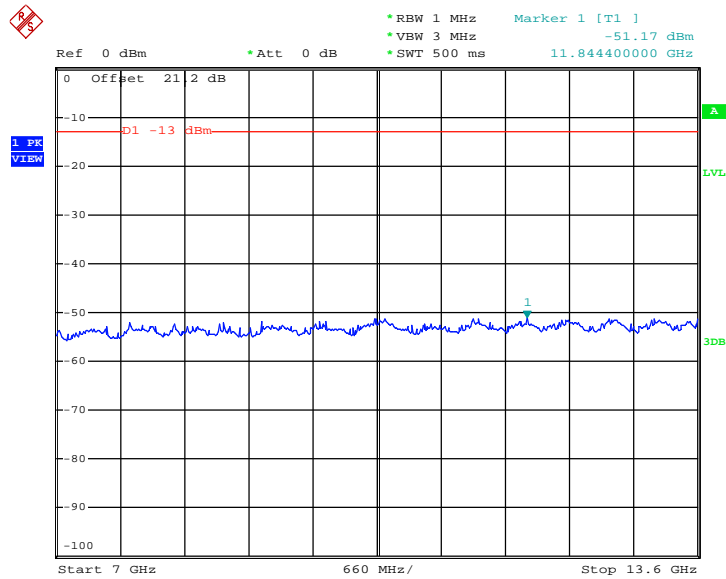

Date: 5.NOV.2013 17:57:16



Conducted Spurious Emission Plot between 13.6GHz ~ 19.1GHz

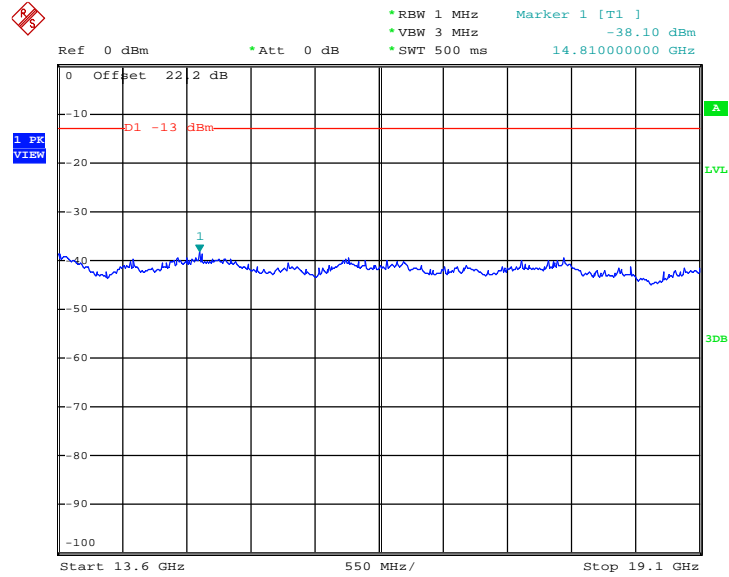

Date: 5.NOV.2013 17:59:03



Band :	GSM1900	Channel :	CH810
Test Mode :	GSM Link (GMSK)	Frequency :	1909.8 MHz

Conducted Spurious Emission Plot between 30MHz ~ 1GHz

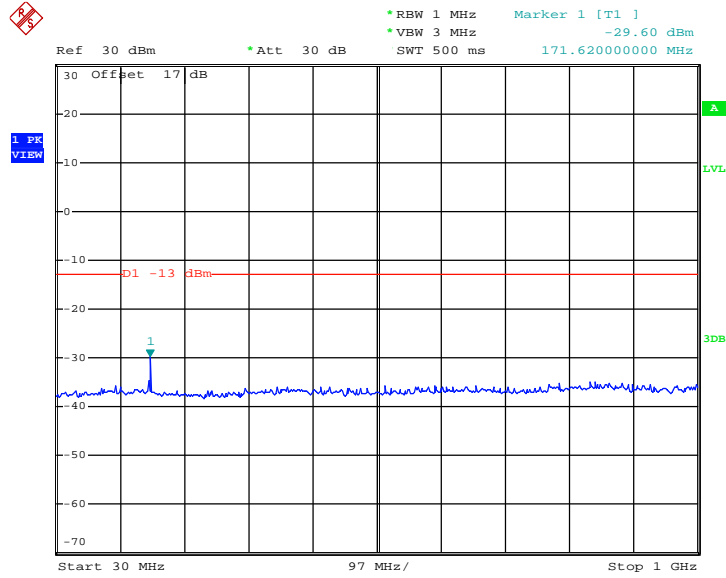

Date: 14.NOV.2013 20:15:48

Conducted Spurious Emission Plot between 1GHz ~ 3GHz

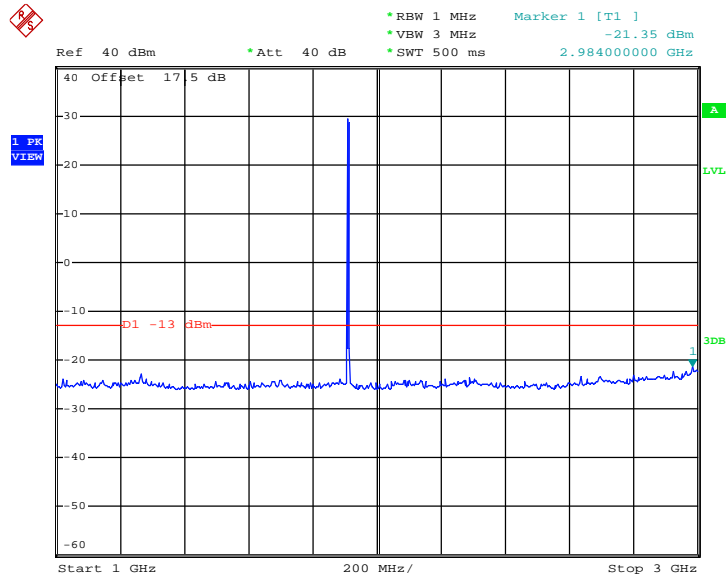

Date: 14.NOV.2013 20:01:40



### Conducted Spurious Emission Plot between 3GHz ~ 7GHz

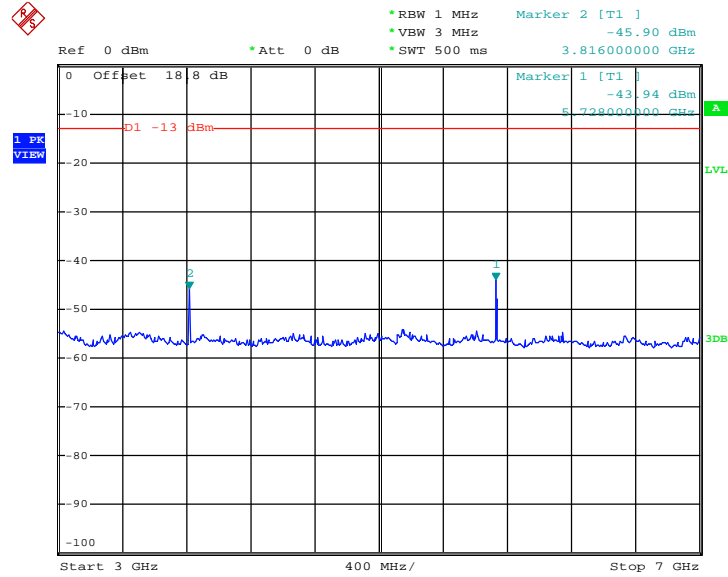

Date: 14.NOV.2013 19:56:56

### Conducted Spurious Emission Plot between 7GHz ~ 13.6GHz

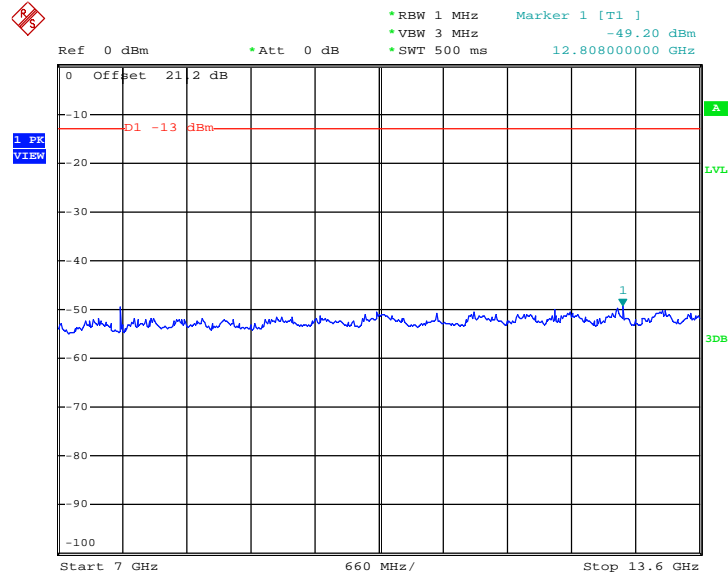

Date: 14.NOV.2013 19:51:03



Conducted Spurious Emission Plot between 13.6GHz ~ 19.1GHz

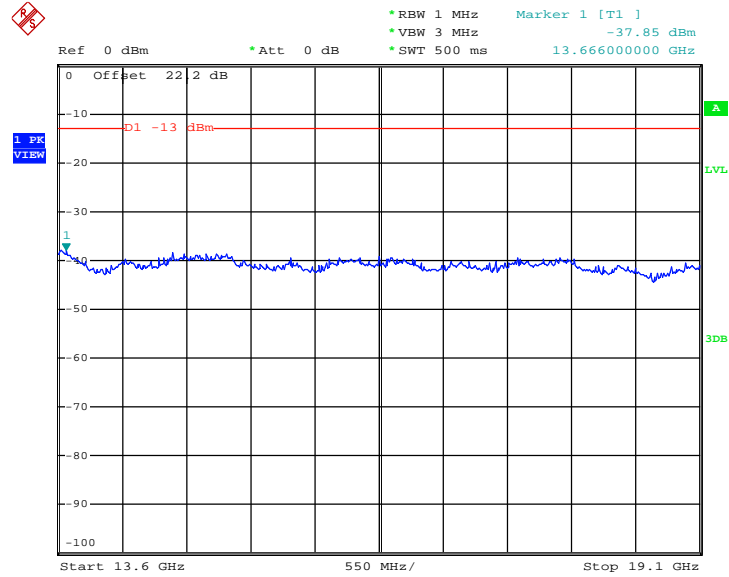

Date: 14.NOV.2013 19:49:29



Band :	GSM1900	Channel :	CH512
Test Mode :	EDGE 1 Tx Slot Link (8PSK)	Frequency :	1850.2 MHz

Conducted Spurious Emission Plot between 30MHz ~ 1GHz

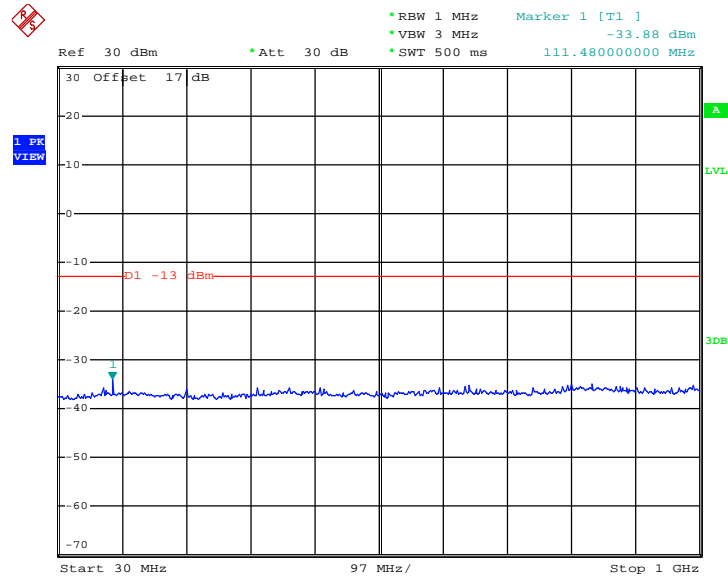

Date: 14.NOV.2013 20:52:43

Conducted Spurious Emission Plot between 1GHz ~ 3GHz

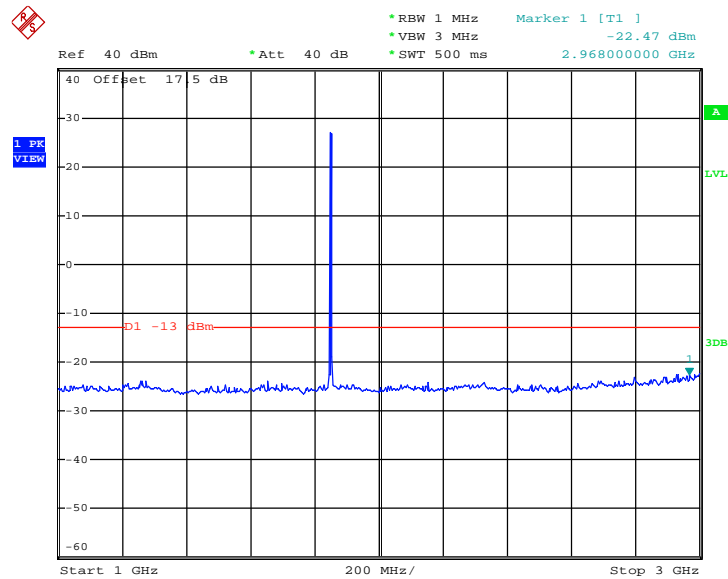

Date: 14.NOV.2013 20:45:08





### Conducted Spurious Emission Plot between 3GHz ~ 7GHz

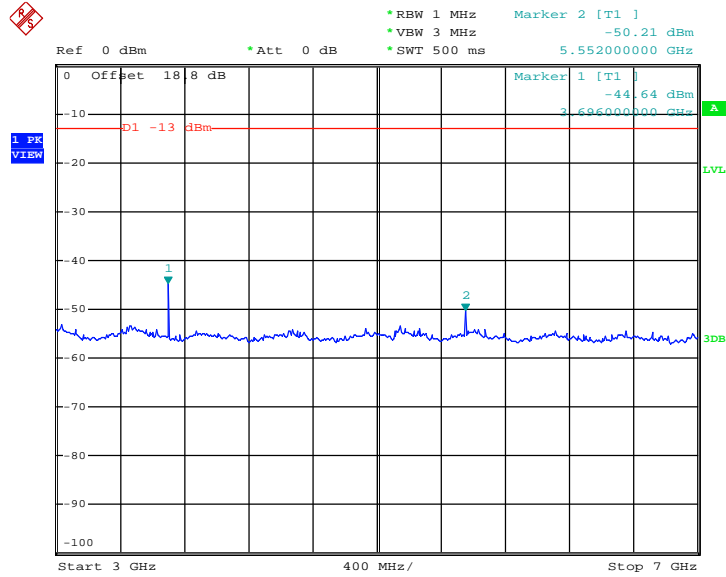

Date: 14.NOV.2013 20:59:46

### Conducted Spurious Emission Plot between 7GHz ~ 13.6GHz

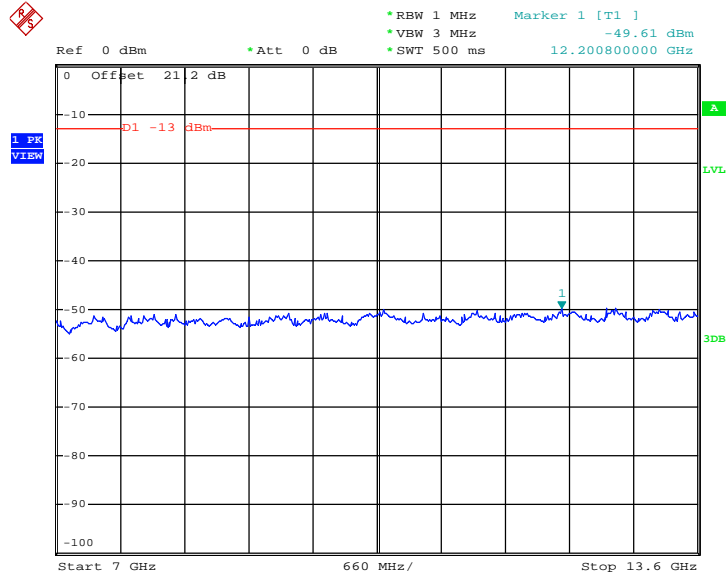

Date: 14.NOV.2013 21:05:13



Conducted Spurious Emission Plot between 13.6GHz ~ 19.1GHz

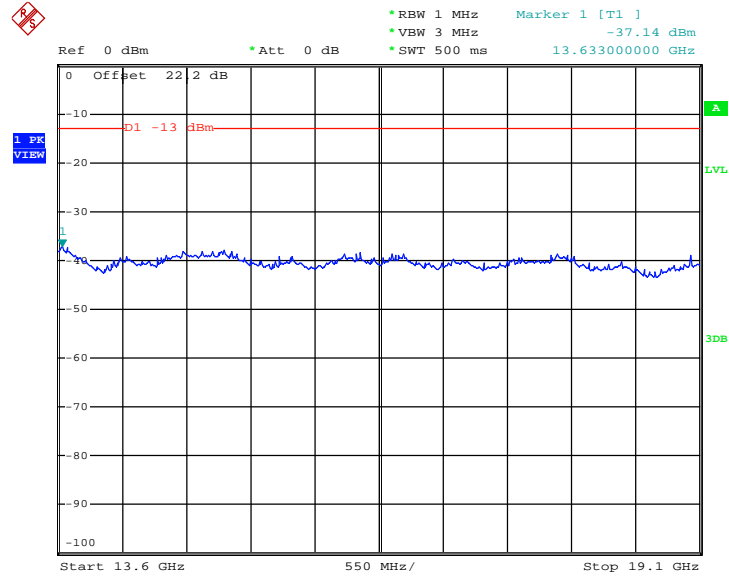

Date: 14.NOV.2013 21:08:01



<b>Band :</b>	GSM1900	<b>Channel :</b>	CH661
<b>Test Mode :</b>	EDGE 1 Tx Slot Link (8PSK)	<b>Frequency :</b>	1880.0 MHz

Conducted Spurious Emission Plot between 30MHz ~ 1GHz

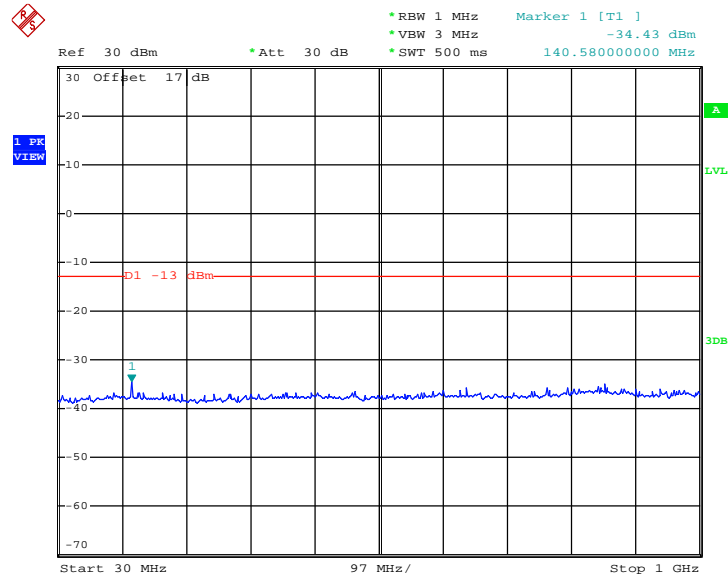

Date: 5.NOV.2013 19:11:06

Conducted Spurious Emission Plot between 1GHz ~ 3GHz

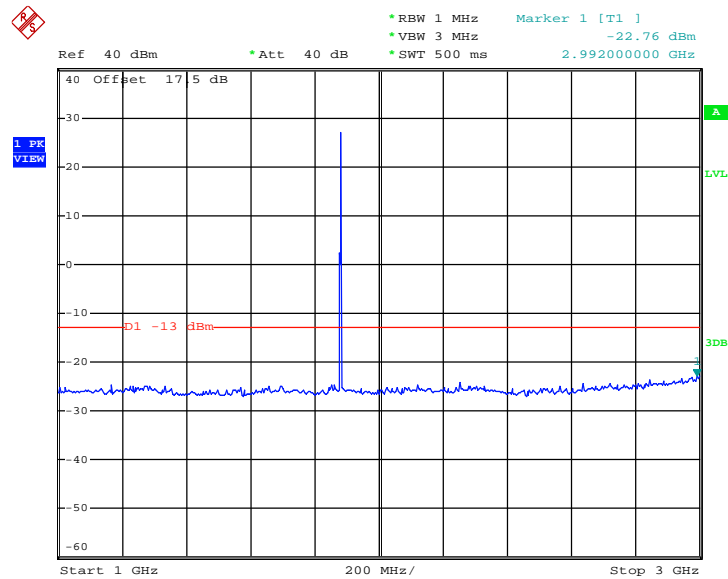

Date: 5.NOV.2013 19:13:32





### Conducted Spurious Emission Plot between 3GHz ~ 7GHz

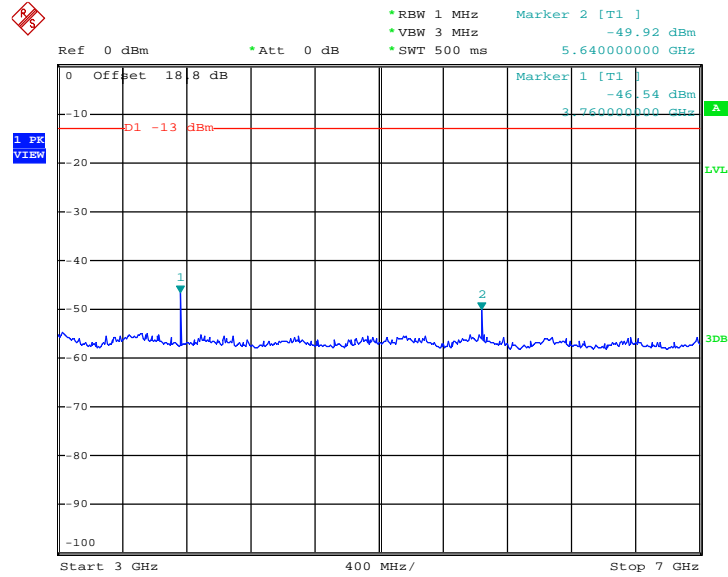

Date: 5.NOV.2013 19:16:49

### Conducted Spurious Emission Plot between 7GHz ~ 13.6GHz

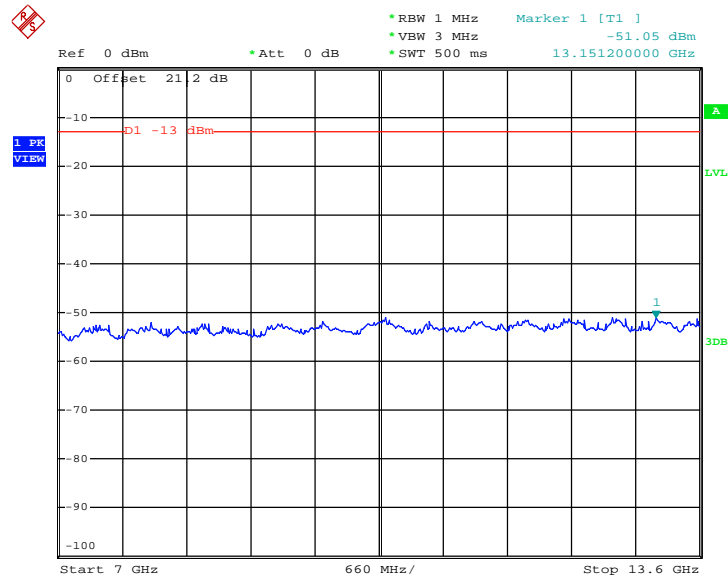

Date: 5.NOV.2013 19:18:30



Conducted Spurious Emission Plot between 13.6GHz ~ 19.1GHz

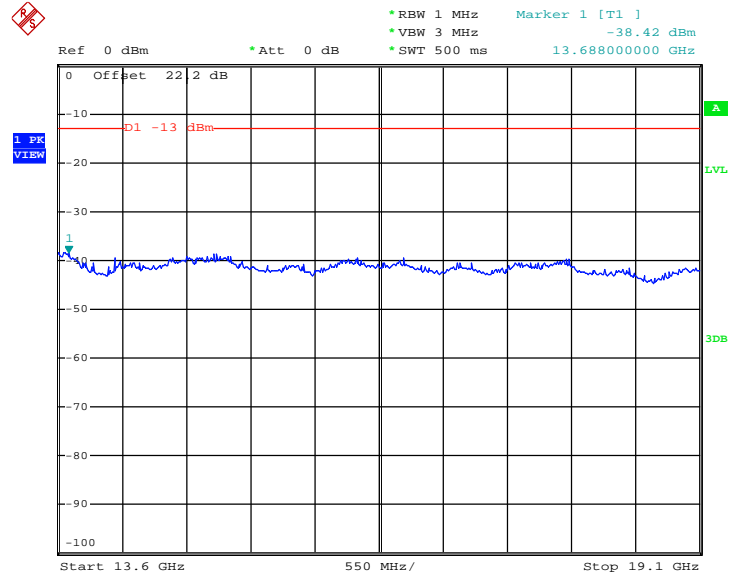

Date: 5.NOV.2013 19:21:11



Band :	GSM1900	Channel :	CH810
Test Mode :	EDGE 1 Tx Slot Link (8PSK)	Frequency :	1909.8 MHz

Conducted Spurious Emission Plot between 30MHz ~ 1GHz

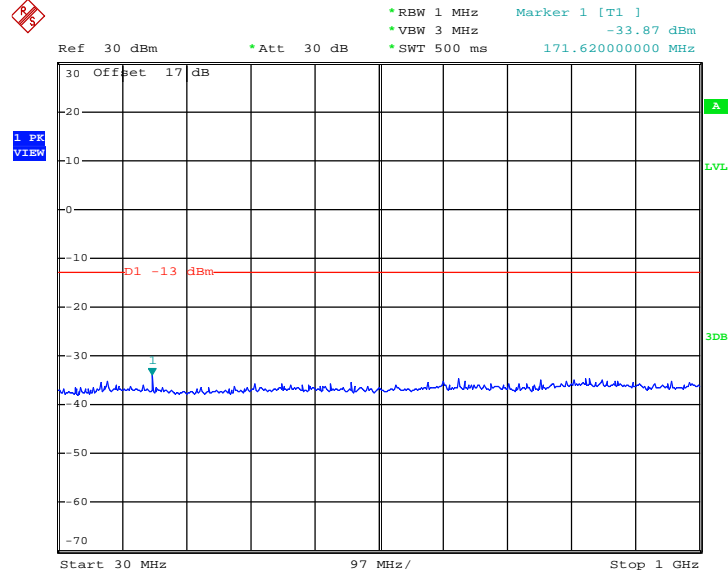

Date: 14.NOV.2013 20:51:08

Conducted Spurious Emission Plot between 1GHz ~ 3GHz

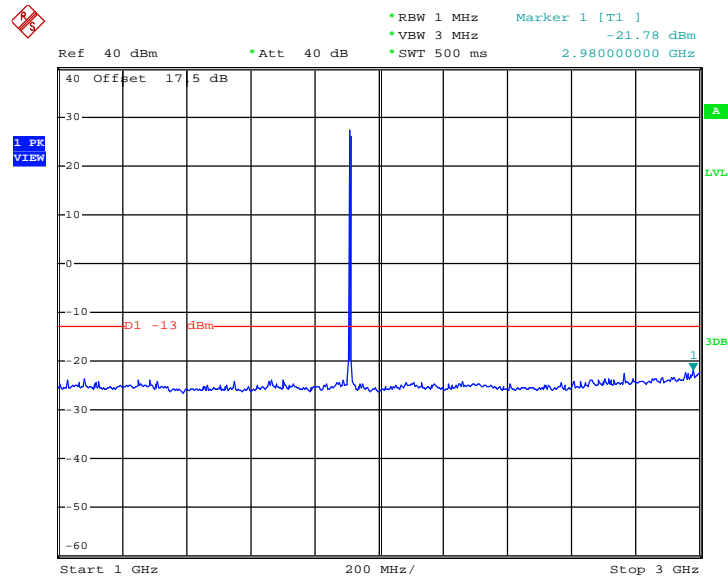

Date: 14.NOV.2013 20:46:38



### Conducted Spurious Emission Plot between 3GHz ~ 7GHz

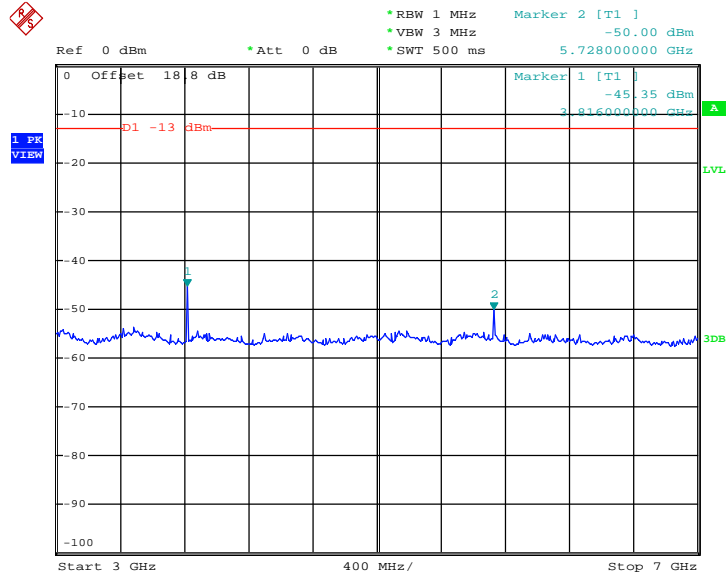

Date: 14.NOV.2013 21:01:01

### Conducted Spurious Emission Plot between 7GHz ~ 13.6GHz

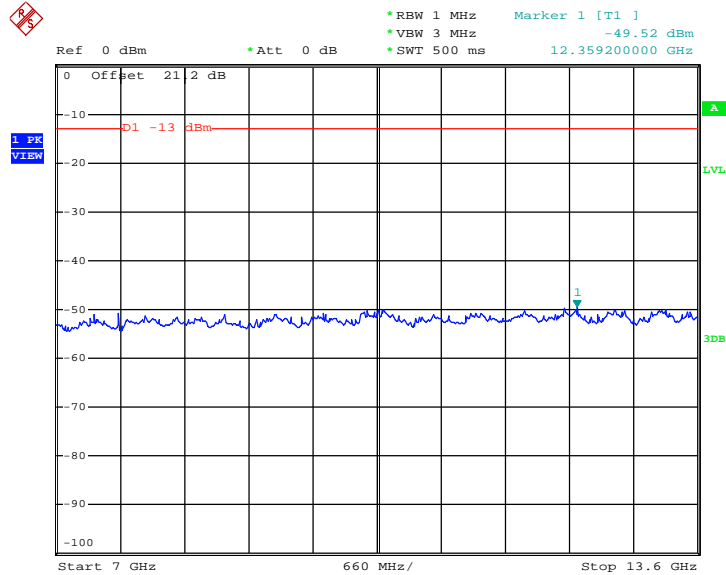

Date: 14.NOV.2013 21:02:59



Conducted Spurious Emission Plot between 13.6GHz ~ 19.1GHz

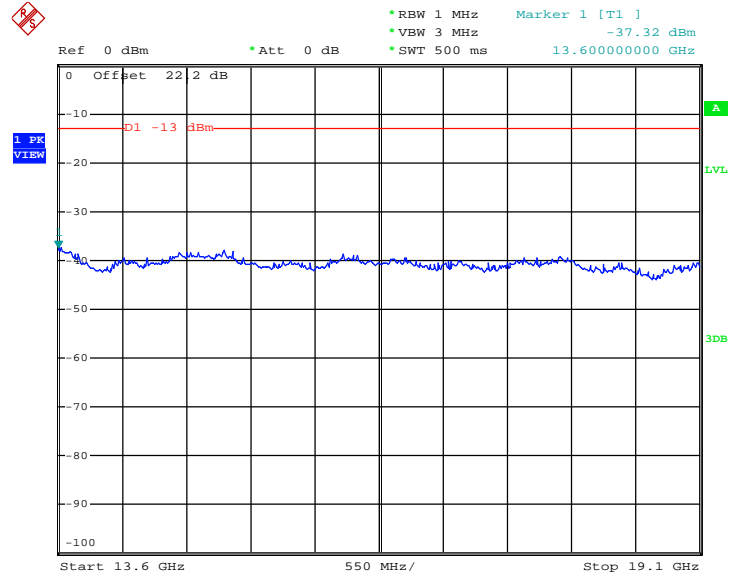

Date: 14.NOV.2013 21:09:14

## 3.7 Field Strength of Spurious Radiation Measurement

### 3.7.1 Description of Field Strength of Spurious Radiated Measurement

The power of any emission outside of the authorized operating frequency ranges must be attenuated below the transmitter power (P) by a factor of at least  $43 + 10 \log (P)$  dB. The spectrum is scanned from 30 MHz up to a frequency including its 10th harmonic.

### 3.7.2 Measuring Instruments

See list of measuring instruments of this test report.

### 3.7.3 Test Procedures

1. The EUT was placed on a rotatable wooden table with 0.8 meter above ground.
2. The EUT was set 3 meters from the receiving antenna, which was mounted on the antenna tower.
3. The table was rotated 360 degrees to determine the position of the highest spurious emission.
4. The height of the receiving antenna is varied between one meter and four meters to search the maximum spurious emission for both horizontal and vertical polarizations.
5. Make the measurement with the spectrum analyzer's RBW = 1MHz, VBW = 3MHz, taking the record of maximum spurious emission.
6. A horn antenna was substituted in place of the EUT and was driven by a signal generator.
7. Tune the output power of signal generator to the same emission level with EUT maximum spurious emission.
8. Taking the record of output power at antenna port.
9. Repeat step 7 to step 8 for another polarization.
10. The RF fundamental frequency should be excluded against the limit line in the operating frequency band.
11. The limit line is derived from  $43 + 10\log(P)$  dB below the transmitter power P(Watts)  
=  $P(W) - [43 + 10\log(P)]$  (dB)  
=  $[30 + 10\log(P)]$  (dBm) -  $[43 + 10\log(P)]$  (dB)  
= -13dBm.
12. EIRP (dBm) = S.G. Power – Tx Cable Loss + Tx Antenna Gain

### 3.7.4 Test Setup

For radiated emissions from 30MHz to 1GHz

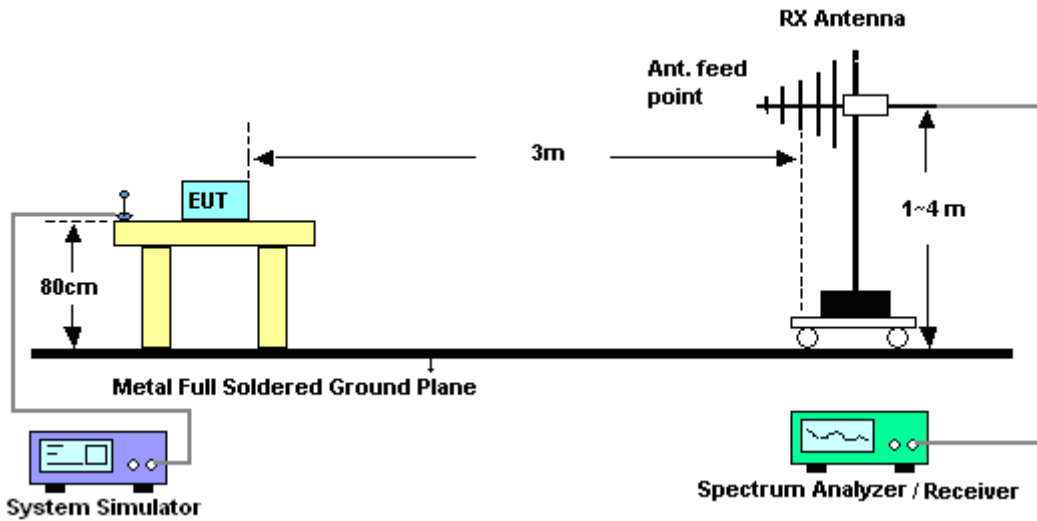

For radiated emissions above 1GHz

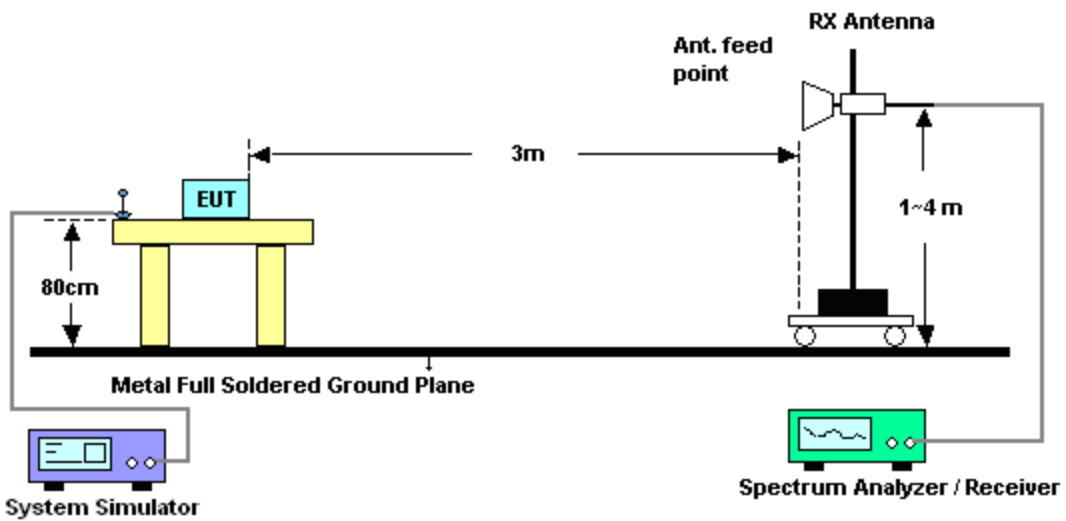



3.7.5 Test Result of Field Strength of Spurious Radiated

Band :	GSM1900 for CH512	Temperature :	23~25°C
Test Mode :	GSM Link (GMSK)	Relative Humidity :	48~52%
Test Engineer :	Gavin Zhang	Polarization :	Horizontal
Remark :	Spurious emissions within 30-1000MHz were found more than 20dB below limit line.		

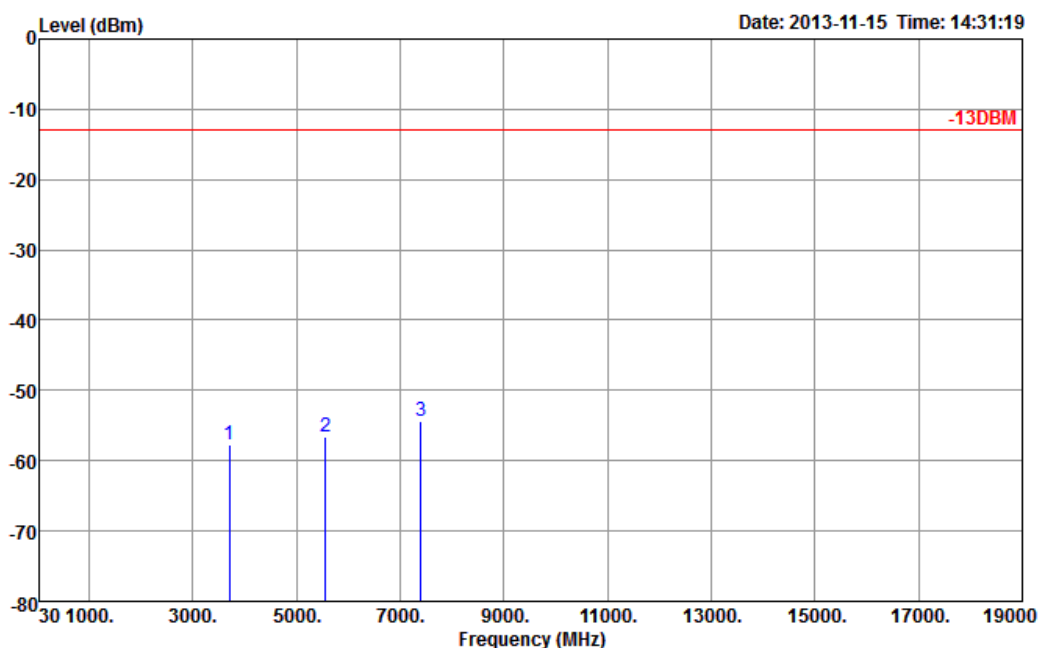

Site : 03CH01-SZ  
 Condition : -13DBM HF\_EIRP\_H\_130101 HORIZONTAL  
 Project : (FG)303104

Frequency ( MHz )	EIRP ( dBm )	Limit ( dBm )	Over Limit ( dB )	SPA Reading ( dBm )	S.G. Power ( dBm )	TX Cable loss ( dB )	TX Antenna Gain ( dBi )	Polarization ( H/V )	Result
3700.4	-57.63	-13	-44.63	-69.18	-64.38	1.2	7.95	H	Pass
5550.6	-56.56	-13	-43.56	-73.95	-64.66	1.5	9.60	H	Pass
7400.8	-54.48	-13	-41.48	-76.06	-64.67	1.7	11.89	H	Pass



<b>Band :</b>	GSM1900 for CH512	<b>Temperature :</b>	23~25°C
<b>Test Mode :</b>	GSM Link (GMSK)	<b>Relative Humidity :</b>	48~52%
<b>Test Engineer :</b>	Gavin Zhang	<b>Polarization :</b>	Vertical
<b>Remark :</b>	Spurious emissions within 30-1000MHz were found more than 20dB below limit line.		

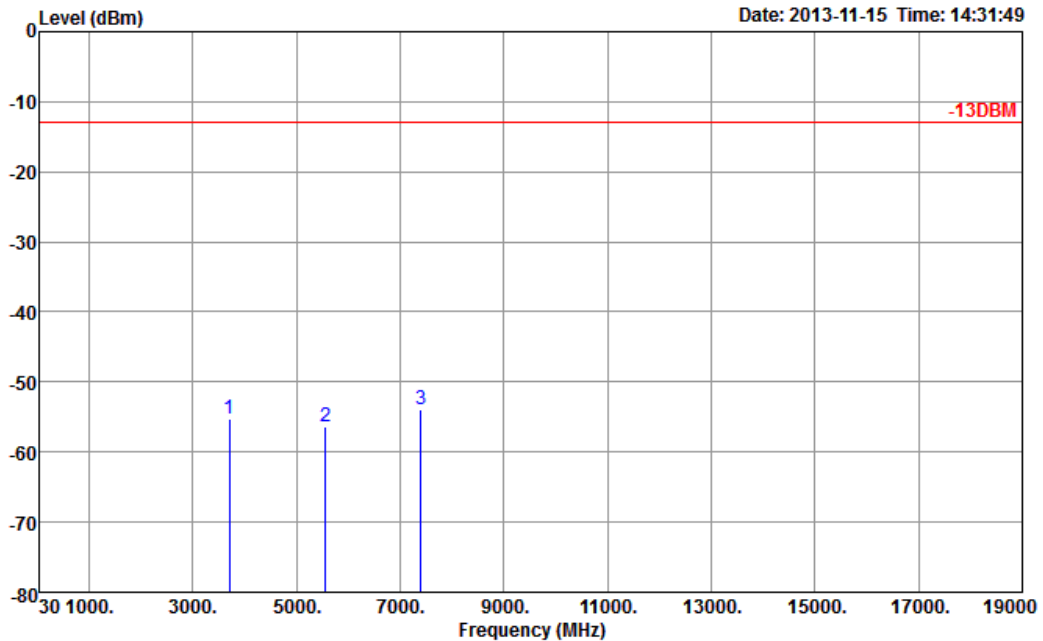

Site : 03CH01-SZ  
 Condition : -13DBM HF\_EIRP\_V\_130101 VERTICAL  
 Project : (FG)303104

Frequency ( MHz )	EIRP ( dBm )	Limit ( dBm )	Over Limit ( dB )	SPA Reading ( dBm )	S.G. Power ( dBm )	TX Cable loss ( dB )	TX Antenna Gain ( dBi )	Polarization ( H/V )	Result
3700.4	-55.33	-13	-42.33	-69.76	-62.08	1.2	7.95	V	Pass
5550.6	-56.40	-13	-43.40	-72.88	-64.50	1.5	9.6	V	Pass
7400.8	-53.95	-13	-40.95	-75.84	-64.14	1.7	11.89	V	Pass



<b>Band :</b>	GSM1900 for CH661	<b>Temperature :</b>	23~25°C
<b>Test Mode :</b>	GSM Link (GMSK)	<b>Relative Humidity :</b>	48~52%
<b>Test Engineer :</b>	Gavin Zhang	<b>Polarization :</b>	Horizontal
<b>Remark :</b>	Spurious emissions within 30-1000MHz were found more than 20dB below limit line.		

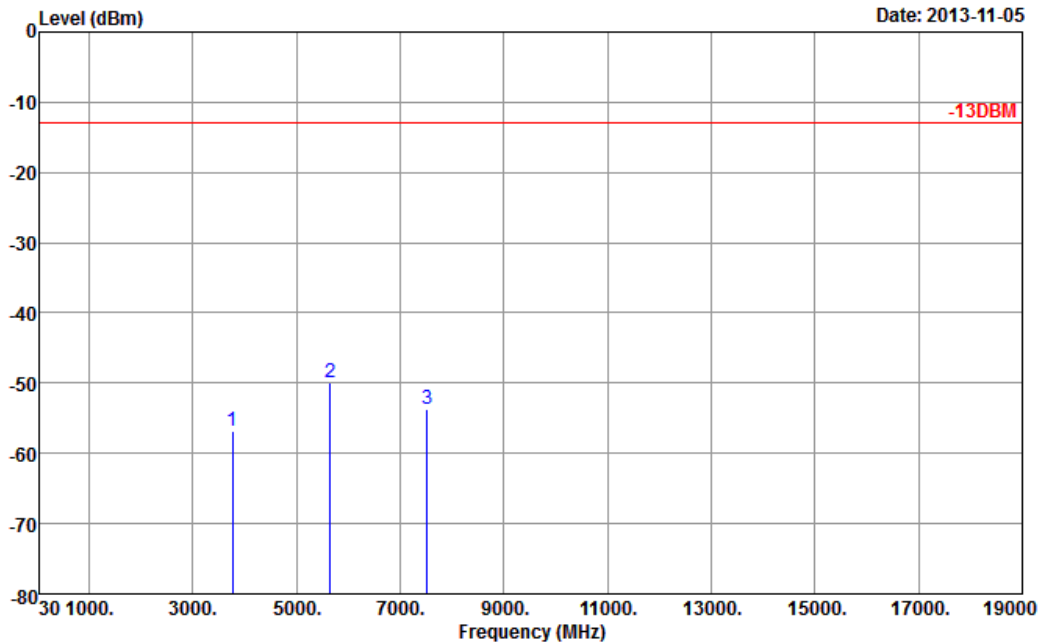

Site : 03CH01-SZ  
 Condition : -13DBM HF\_EIRP\_H\_130101 HORIZONTAL  
 Project : (FG)3O3104

Frequency ( MHz )	EIRP ( dBm )	Limit ( dBm )	Over Limit ( dB )	SPA Reading ( dBm )	S.G. Power ( dBm )	TX Cable loss ( dB )	TX Antenna Gain ( dBi )	Polarization ( H/V )	Result
3760	-56.88	-13	-43.88	-69.03	-63.62	1.28	8.02	H	Pass
5640	-49.96	-13	-36.96	-67.95	-58.38	1.58	10.00	H	Pass
7520	-53.66	-13	-40.66	-75.60	-63.98	1.78	12.10	H	Pass



<b>Band :</b>	GSM1900 for CH661	<b>Temperature :</b>	23~25°C
<b>Test Mode :</b>	GSM Link (GMSK)	<b>Relative Humidity :</b>	48~52%
<b>Test Engineer :</b>	Gavin Zhang	<b>Polarization :</b>	Vertical
<b>Remark :</b>	Spurious emissions within 30-1000MHz were found more than 20dB below limit line.		

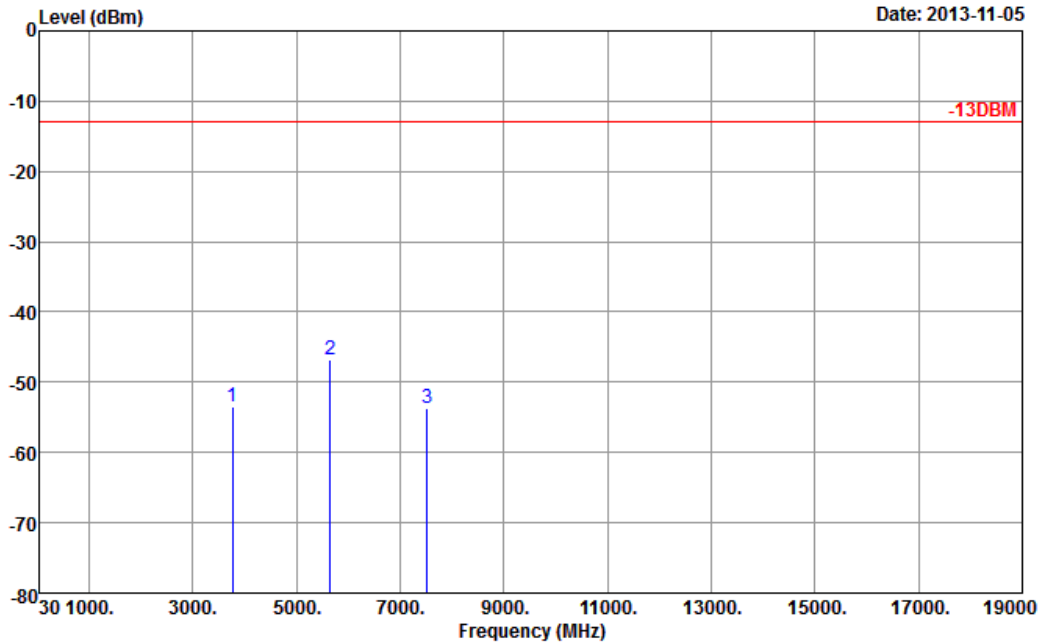

Site : 03CH01-SZ  
 Condition : -13DBM HF\_EIRP\_V\_130101 VERTICAL  
 Project : (FG)3O3104

Frequency ( MHz )	EIRP ( dBm )	Limit ( dBm )	Over Limit ( dB )	SPA Reading ( dBm )	S.G. Power ( dBm )	TX Cable loss ( dB )	TX Antenna Gain ( dBi )	Polarization ( H/V )	Result
3760	-53.56	-13	-40.56	-68.59	-60.30	1.28	8.02	V	Pass
5640	-46.86	-13	-33.86	-64	-55.28	1.58	10	V	Pass
7520	-53.63	-13	-40.63	-75.88	-63.95	1.78	12.1	V	Pass



<b>Band :</b>	GSM1900 for CH810	<b>Temperature :</b>	23~25°C
<b>Test Mode :</b>	GSM Link (GMSK)	<b>Relative Humidity :</b>	48~52%
<b>Test Engineer :</b>	Gavin Zhang	<b>Polarization :</b>	Horizontal
<b>Remark :</b>	Spurious emissions within 30-1000MHz were found more than 20dB below limit line.		

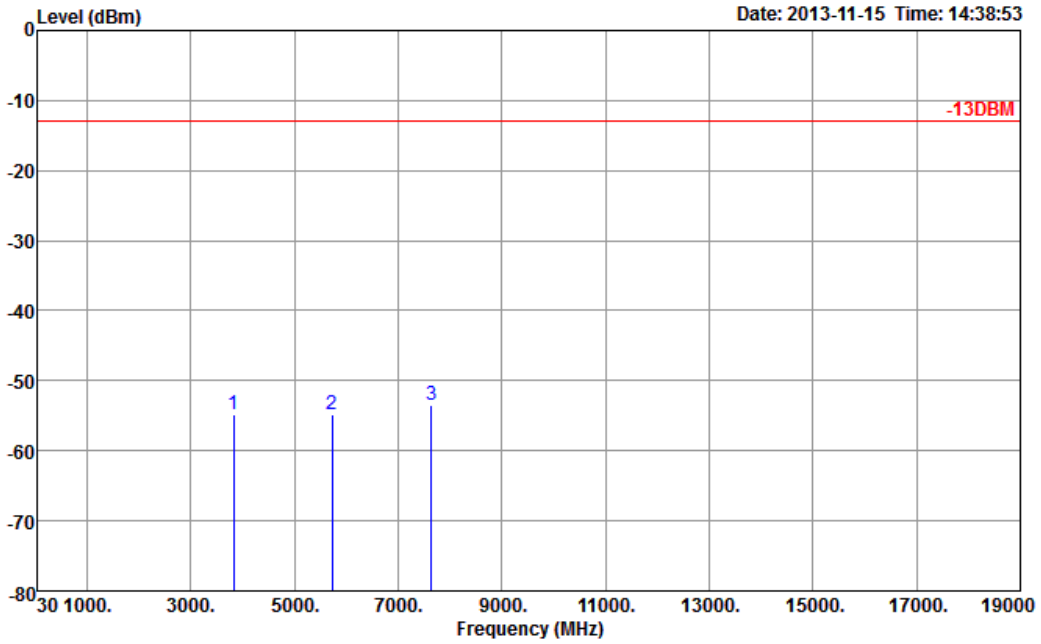

Site : 03CH01-SZ  
 Condition : -13DBM HF\_EIRP\_H\_130101 HORIZONTAL  
 Project : (FG)303104

Frequency ( MHz )	EIRP ( dBm )	Limit ( dBm )	Over Limit ( dB )	SPA Reading ( dBm )	S.G. Power ( dBm )	TX Cable loss ( dB )	TX Antenna Gain ( dBi )	Polarization ( H/V )	Result
3819.6	-54.93	-13	-41.93	-66.50	-61.70	1.23	8.00	H	Pass
5729.4	-54.81	-13	-41.81	-72.61	-62.94	1.52	9.65	H	Pass
7639.2	-53.48	-13	-40.48	-75.72	-63.66	1.82	12.00	H	Pass



<b>Band :</b>	GSM1900 for CH810	<b>Temperature :</b>	23~25°C
<b>Test Mode :</b>	GSM Link (GMSK)	<b>Relative Humidity :</b>	48~52%
<b>Test Engineer :</b>	Gavin Zhang	<b>Polarization :</b>	Vertical
<b>Remark :</b>	Spurious emissions within 30-1000MHz were found more than 20dB below limit line.		

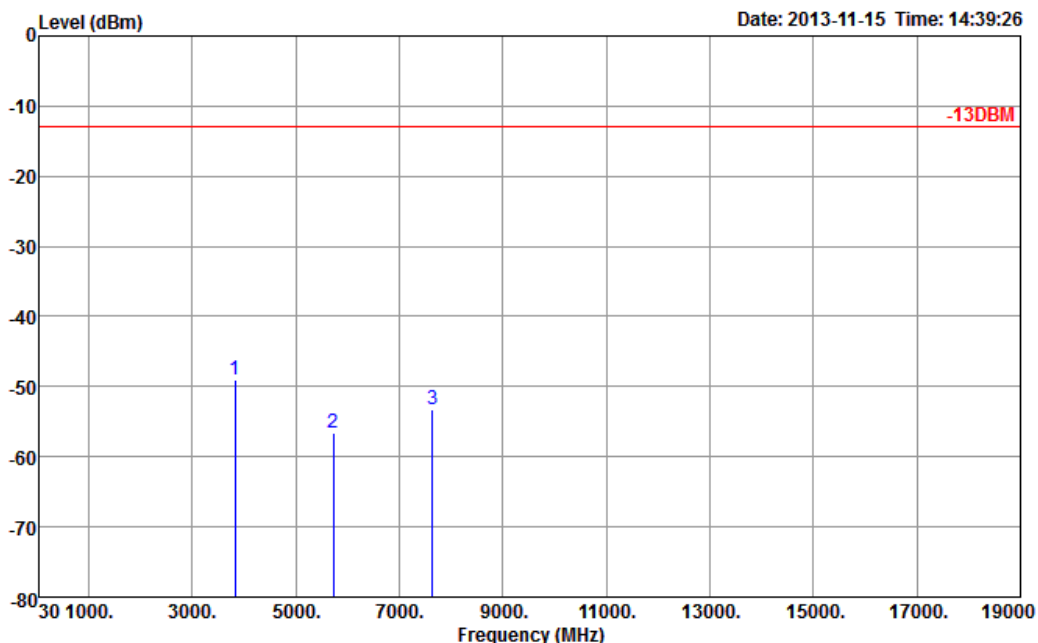

Site : 03CH01-SZ  
 Condition : -13DBM HF\_EIRP\_V\_130101 VERTICAL  
 Project : (FG)3O3104

Frequency ( MHz )	EIRP ( dBm )	Limit ( dBm )	Over Limit ( dB )	SPA Reading ( dBm )	S.G. Power ( dBm )	TX Cable loss ( dB )	TX Antenna Gain ( dBi )	Polarization ( H/V )	Result
3819.6	-49.01	-13	-36.01	-63.46	-55.78	1.23	8	V	Pass
5729.4	-56.55	-13	-43.55	-73.44	-64.68	1.52	9.65	V	Pass
7639.2	-53.29	-13	-40.29	-75.84	-63.47	1.82	12	V	Pass



<b>Band :</b>	GSM1900 for CH512	<b>Temperature :</b>	23~25°C
<b>Test Mode :</b>	EDGE 1 Tx Slot Link (8PSK)	<b>Relative Humidity :</b>	48~52%
<b>Test Engineer :</b>	Gavin Zhang	<b>Polarization :</b>	Horizontal
<b>Remark :</b>	Spurious emissions within 30-1000MHz were found more than 20dB below limit line.		

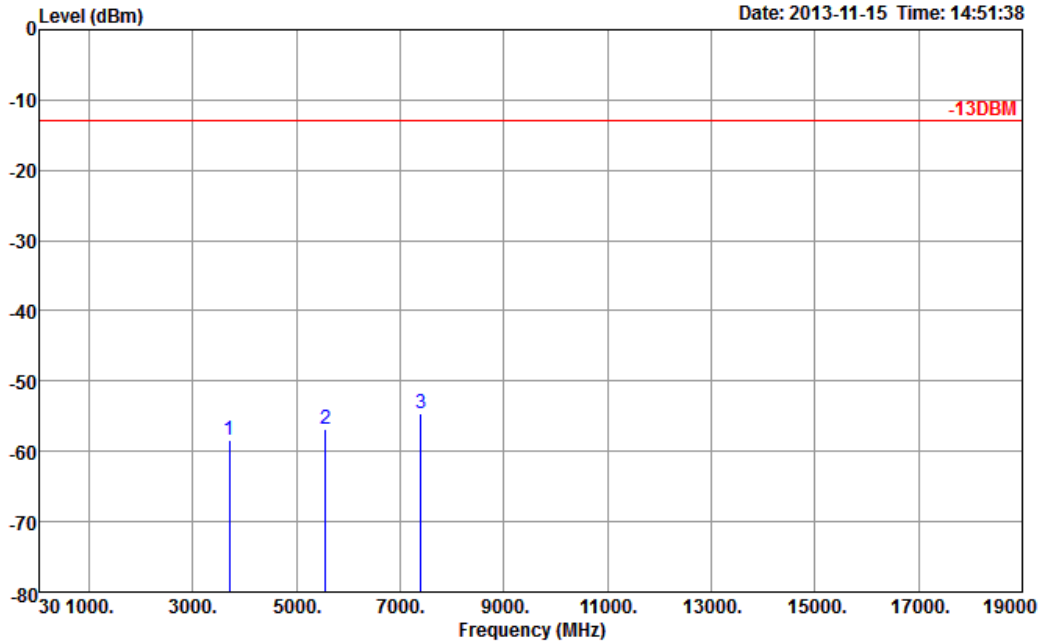

Site : 03CH01-SZ  
 Condition : -13DBM HF\_EIRP\_H\_130101 HORIZONTAL  
 Project : (FG)303104

Frequency ( MHz )	EIRP ( dBm )	Limit ( dBm )	Over Limit ( dB )	SPA Reading ( dBm )	S.G. Power ( dBm )	TX Cable loss ( dB )	TX Antenna Gain ( dBi )	Polarization ( H/V )	Result
3700.4	-58.42	-13	-45.42	-69.97	-65.17	1.2	7.95	H	Pass
5550.6	-56.84	-13	-43.84	-74.23	-64.94	1.5	9.60	H	Pass
7400.8	-54.61	-13	-41.61	-76.19	-64.80	1.7	11.89	H	Pass



<b>Band :</b>	GSM1900 for CH512	<b>Temperature :</b>	23~25°C
<b>Test Mode :</b>	EDGE 1 Tx Slot Link (8PSK)	<b>Relative Humidity :</b>	48~52%
<b>Test Engineer :</b>	Gavin Zhang	<b>Polarization :</b>	Vertical
<b>Remark :</b>	Spurious emissions within 30-1000MHz were found more than 20dB below limit line.		

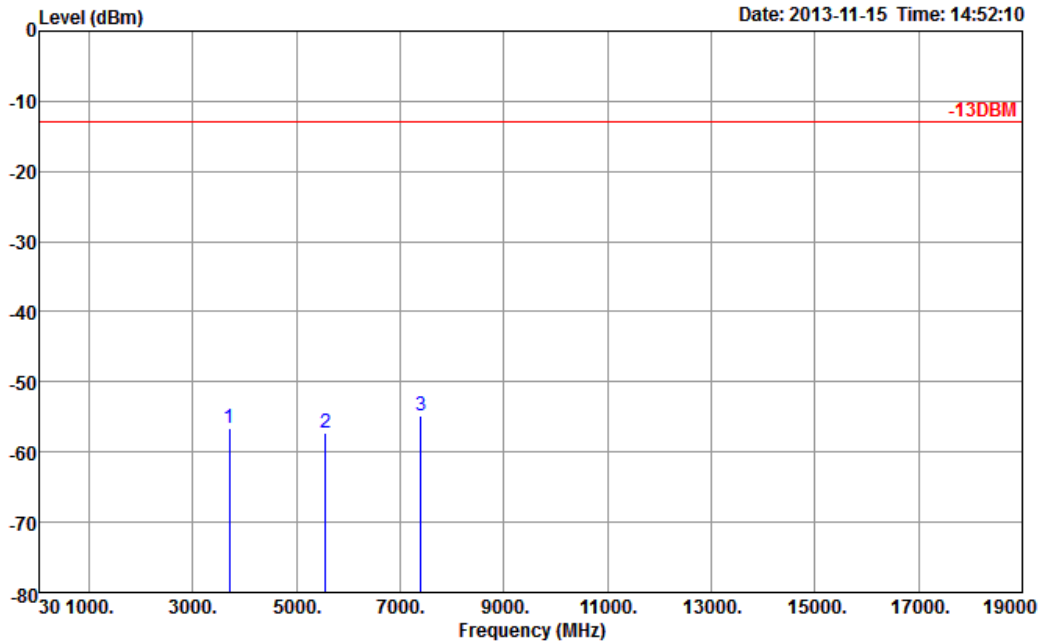

Site : 03CH01-SZ  
 Condition : -13DBM HF\_EIRP\_V\_130101 VERTICAL  
 Project : (FG)3O3104

Frequency ( MHz )	EIRP ( dBm )	Limit ( dBm )	Over Limit ( dB )	SPA Reading ( dBm )	S.G. Power ( dBm )	TX Cable loss ( dB )	TX Antenna Gain ( dBi )	Polarization ( H/V )	Result
3700.4	-56.61	-13	-43.61	-71.04	-63.36	1.2	7.95	V	Pass
5550.6	-57.23	-13	-44.23	-73.71	-65.33	1.5	9.6	V	Pass
7400.8	-54.89	-13	-41.89	-76.78	-65.08	1.7	11.89	V	Pass



<b>Band :</b>	GSM1900 for CH661	<b>Temperature :</b>	23~25°C
<b>Test Mode :</b>	EDGE 1 Tx Slot Link (8PSK)	<b>Relative Humidity :</b>	48~52%
<b>Test Engineer :</b>	Gavin Zhang	<b>Polarization :</b>	Horizontal
<b>Remark :</b>	Spurious emissions within 30-1000MHz were found more than 20dB below limit line.		

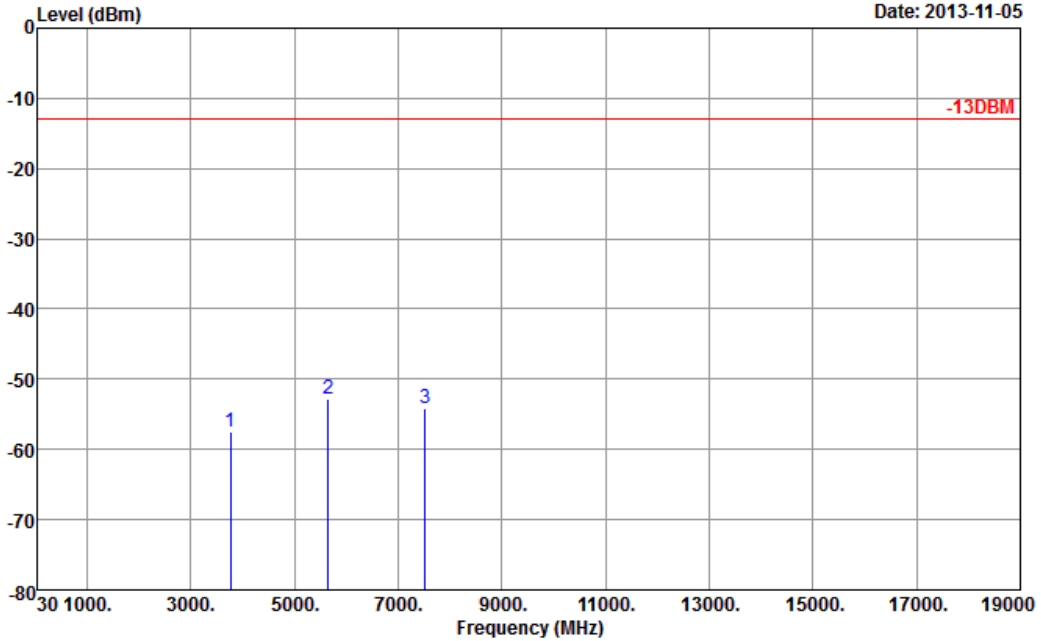

Site : 03CH01-SZ  
 Condition : -13DBM HF\_EIRP\_H\_130101 HORIZONTAL  
 Project : (FG)3O3104

Frequency ( MHz )	EIRP ( dBm )	Limit ( dBm )	Over Limit ( dB )	SPA Reading ( dBm )	S.G. Power ( dBm )	TX Cable loss ( dB )	TX Antenna Gain ( dBi )	Polarization ( H/V )	Result
3760	-57.44	-13	-44.44	-69.59	-64.18	1.28	8.02	H	Pass
5640	-52.82	-13	-39.82	-70.81	-61.24	1.58	10.00	H	Pass
7520	-54.08	-13	-41.08	-76.02	-64.40	1.78	12.10	H	Pass



<b>Band :</b>	GSM1900 for CH661	<b>Temperature :</b>	23~25°C
<b>Test Mode :</b>	EDGE 1 Tx Slot Link (8PSK)	<b>Relative Humidity :</b>	48~52%
<b>Test Engineer :</b>	Gavin Zhang	<b>Polarization :</b>	Vertical
<b>Remark :</b>	Spurious emissions within 30-1000MHz were found more than 20dB below limit line.		

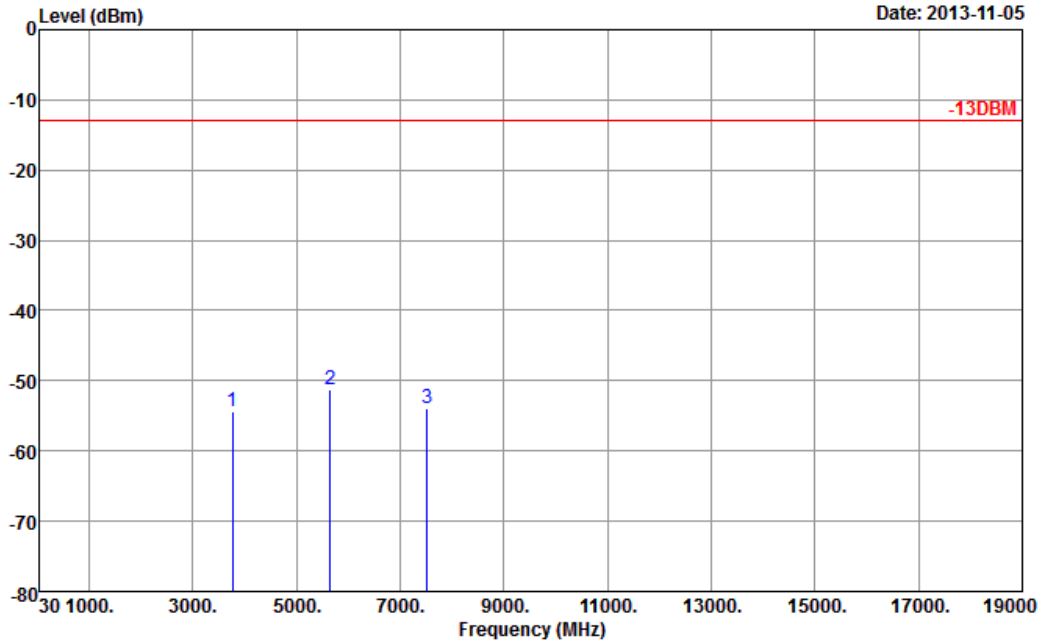

Site : 03CH01-SZ  
 Condition : -13DBM HF\_EIRP\_V\_130101 VERTICAL  
 Project : (FG)3O3104

Frequency ( MHz )	EIRP ( dBm )	Limit ( dBm )	Over Limit ( dB )	SPA Reading ( dBm )	S.G. Power ( dBm )	TX Cable loss ( dB )	TX Antenna Gain ( dBi )	Polarization ( H/V )	Result
3760	-54.45	-13	-41.45	-69.48	-61.19	1.28	8.02	V	Pass
5640	-51.19	-13	-38.19	-68.27	-59.61	1.58	10	V	Pass
7520	-53.94	-13	-40.94	-76.19	-64.26	1.78	12.1	V	Pass



<b>Band :</b>	GSM1900 for CH810	<b>Temperature :</b>	23~25°C
<b>Test Mode :</b>	EDGE 1 Tx Slot Link (8PSK)	<b>Relative Humidity :</b>	48~52%
<b>Test Engineer :</b>	Gavin Zhang	<b>Polarization :</b>	Horizontal
<b>Remark :</b>	Spurious emissions within 30-1000MHz were found more than 20dB below limit line.		

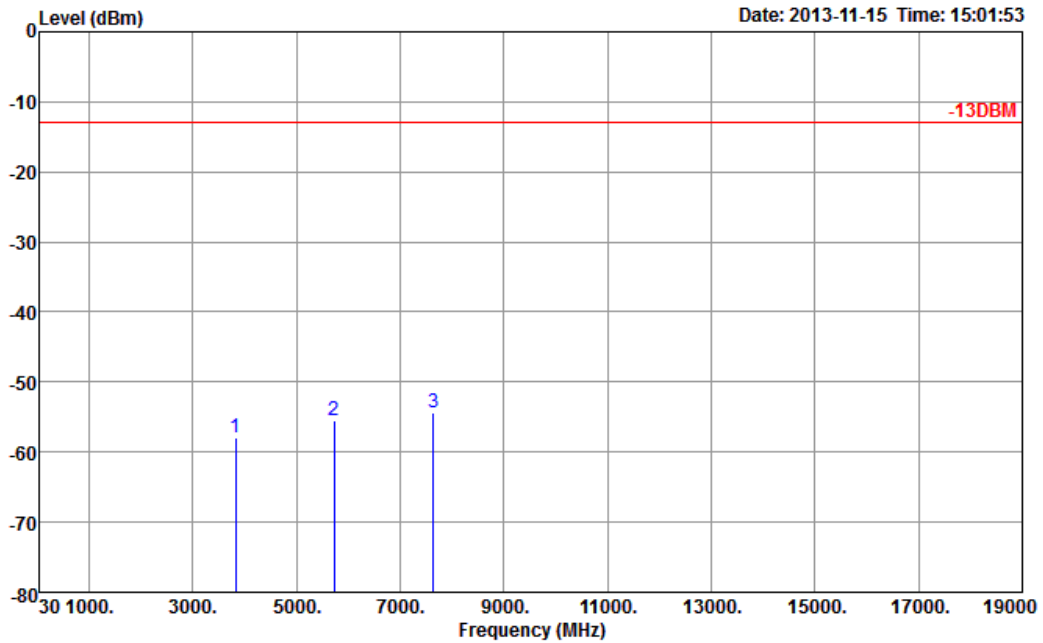

Site : 03CH01-SZ  
 Condition : -13DBM HF\_EIRP\_H\_130101 HORIZONTAL  
 Project : (FG)303104

Frequency ( MHz )	EIRP ( dBm )	Limit ( dBm )	Over Limit ( dB )	SPA Reading ( dBm )	S.G. Power ( dBm )	TX Cable loss ( dB )	TX Antenna Gain ( dBi )	Polarization ( H/V )	Result
3819.6	-58.04	-13	-45.04	-69.61	-64.81	1.23	8.00	H	Pass
5729.4	-55.57	-13	-42.57	-73.37	-63.70	1.52	9.65	H	Pass
7639.2	-54.35	-13	-41.35	-76.59	-64.53	1.82	12.00	H	Pass



<b>Band :</b>	GSM1900 for CH810	<b>Temperature :</b>	23~25°C
<b>Test Mode :</b>	EDGE 1 Tx Slot Link (8PSK)	<b>Relative Humidity :</b>	48~52%
<b>Test Engineer :</b>	Gavin Zhang	<b>Polarization :</b>	Vertical
<b>Remark :</b>	Spurious emissions within 30-1000MHz were found more than 20dB below limit line.		

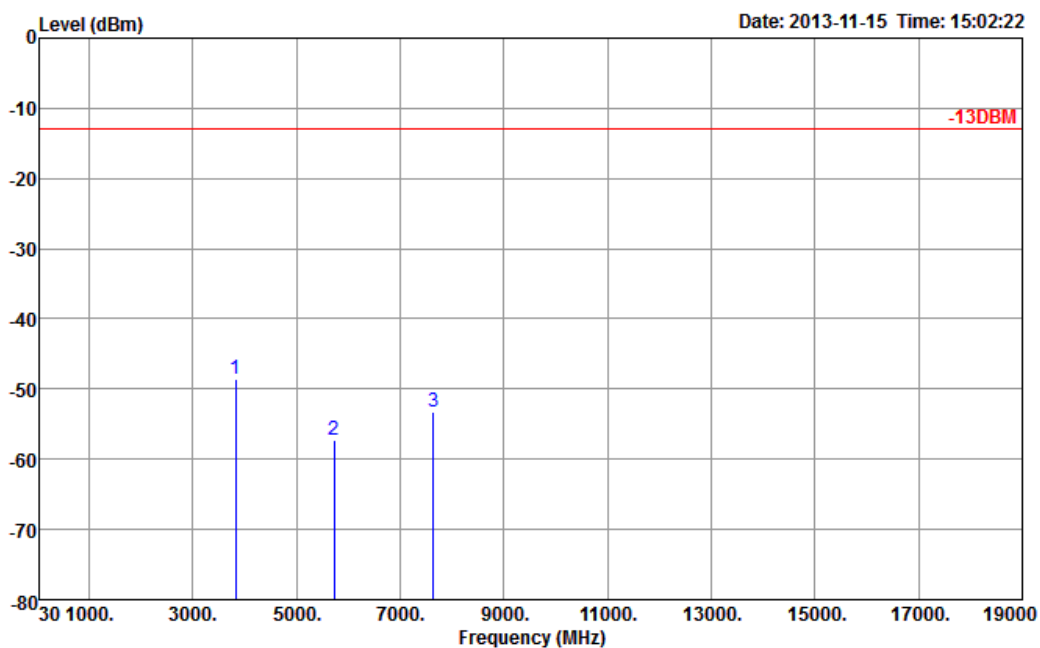

Site : 03CH01-SZ  
 Condition : -13DBM HF\_EIRP\_V\_130101 VERTICAL  
 Project : (FG)303104

Frequency ( MHz )	EIRP ( dBm )	Limit ( dBm )	Over Limit ( dB )	SPA Reading ( dBm )	S.G. Power ( dBm )	TX Cable loss ( dB )	TX Antenna Gain ( dBi )	Polarization ( H/V )	Result
3819.6	-48.50	-13	-35.50	-62.95	-55.27	1.23	8	V	Pass
5729.4	-57.36	-13	-44.36	-74.25	-65.49	1.52	9.65	V	Pass
7639.2	-53.37	-13	-40.37	-75.92	-63.55	1.82	12	V	Pass

## 3.8 Frequency Stability Measurement

### 3.8.1 Description of Frequency Stability Measurement

The frequency stability shall be measured by variation of ambient temperature and variation of primary supply voltage to ensure that the fundamental emission stays within the authorized frequency block. The frequency stability of the transmitter shall be maintained within  $\pm 0.00025\%$  ( $\pm 2.5\text{ppm}$ ) of the center frequency.

### 3.8.2 Measuring Instruments

See list of measuring instruments of this test report.

### 3.8.3 Test Procedures for Temperature Variation

1. The EUT was set up in the thermal chamber and connected with the base station.
2. With power OFF, the temperature was decreased to  $-30^{\circ}\text{C}$  and the EUT was stabilized before testing. Power was applied and the maximum change in frequency was recorded within one minute.
3. With power OFF, the temperature was raised in  $10^{\circ}\text{C}$  step up to  $50^{\circ}\text{C}$ . The EUT was stabilized at each step for at least half an hour. Power was applied and the maximum frequency change was recorded within one minute.

### 3.8.4 Test Procedures for Voltage Variation

1. The EUT was placed in a temperature chamber at  $25\pm 5^{\circ}\text{C}$  and connected with the base station.
2. The power supply voltage to the EUT was varied from BEP to 115% of the nominal value measured at the input to the EUT.
3. The variation in frequency was measured for the worst case.

### 3.8.5 Test Setup

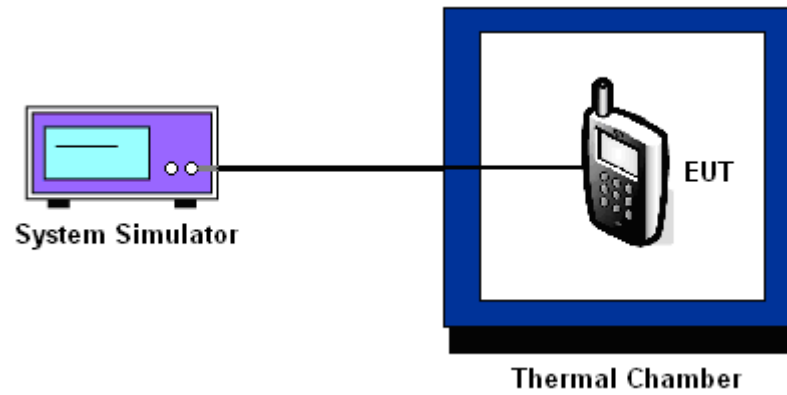



3.8.6 Test Result of Temperature Variation

Band :	GSM 1900	Channel :	661
Limit (ppm) :	2.5	Frequency :	1880.0 MHz

Temperature (°C)	GSM		EDGE 1 Tx Slot		Result
	Freq. Dev. (Hz)	Deviation (ppm)	Freq. Dev. (Hz)	Deviation (ppm)	
-30	25	+0.01	-23	-0.01	PASS
-20	23	+0.01	-21	-0.01	
-10	20	+0.01	-24	-0.01	
0	22	+0.01	-23	-0.01	
10	23	+0.01	-25	-0.01	
20	25	+0.01	-24	-0.01	
30	22	+0.01	-26	-0.01	
40	21	+0.01	-23	-0.01	
50	17	+0.01	-27	-0.01	

**3.8.7 Test Result of Voltage Variation**

Band & Channel	Mode	Voltage (Volt)	Freq. Dev. (Hz)	Deviation (ppm)	Limit (ppm)	Result
GSM 1900 CH661	GSM	3.8	26	+0.01	2.5	PASS
		BEP	26	+0.01		
		4.2	24	+0.01		
	EDGE 1 Tx Slot	3.8	-25	-0.01		
		BEP	-23	-0.01		
		4.2	-26	-0.01		

**Note:**

1. Normal Voltage = 3.8V.
2. Battery End Point (BEP) = 3.6 V.



## 4 List of Measuring Equipment

Instrument	Manufacturer	Model No.	Serial No.	Characteristics	Calibration Date	Test Date	Due Date	Remark
Spectrum Analyzer	R&S	FSP30	101400	9kHz~30GHz	Mar. 28, 2013	Nov. 05, 2013~ Nov. 14, 2013	Mar. 27, 2014	Conducted (TH01-SZ)
Spectrum Analyzer	R&S	FSV30	100845	9kHz~30GHz	Dec. 06, 2012	Nov. 05, 2013~ Nov. 14, 2013	Dec. 05, 2013	Conducted (TH01-SZ)
Power Meter	Anritsu	ML2495A	1218010	N/A	Mar. 28, 2013	Nov. 05, 2013~ Nov. 14, 2013	Mar. 27, 2014	Conducted (TH01-SZ)
Power Sensor	Anritsu	MA2411B	1207253	N/A	Mar. 28, 2013	Nov. 05, 2013~ Nov. 14, 2013	Mar. 27, 2014	Conducted (TH01-SZ)
Thermal Chamber	Hongzhan	LP-150U	HD20120425	N/A	Mar. 28, 2013	Nov. 05, 2013~ Nov. 14, 2013	Mar. 27, 2014	Conducted (TH01-SZ)
ESCI TEST Receiver	R&S	ESCI	100724	9kHz~3GHz	Mar. 28, 2013	Nov. 05, 2013~ Nov. 15, 2013	Mar. 27, 2014	Radiation (03CH01-SZ)
Spectrum Analyzer	R&S	FSP30	101362	9kHz~30GHz	Oct. 29, 2013	Nov. 05, 2013~ Nov. 15, 2013	Oct. 28, 2014	Radiation (03CH01-SZ)
Double Ridge Horn Antenna	ETS Lindgren	3117	00119436	1GHz~18GHz	Oct. 12, 2013	Nov. 05, 2013~ Nov. 15, 2013	Oct. 11, 2014	Radiation (03CH01-SZ)
Bilog Antenna	SCHAFFNER	CBL6112B	2614	30MHz~2GHz	Nov. 03, 2013	Nov. 05, 2013~ Nov. 15, 2013	Nov. 02, 2014	Radiation (03CH01-SZ)
Amplifier	ADVANTEST	BB525C	E9007003	9kHz~3GHz Gain 30dB	Mar. 28, 2013	Nov. 05, 2013~ Nov. 15, 2013	Mar. 27, 2014	Radiation (03CH01-SZ)
Amplifier	Yiai	AV3860B	04030	2GHz~26.5GHz	Mar. 28, 2013	Nov. 05, 2013~ Nov. 15, 2013	Mar. 27, 2014	Radiation (03CH01-SZ)
SHF-EHF-Horn	Schwarzbeck	BBHA9170	BBHA91702 49	14GHz~40GHz	Nov. 23, 2012	Nov. 05, 2013~ Nov. 15, 2013	Nov. 22, 2013	Radiation (03CH01-SZ)
Turn Table	EM Electronics	EM 1000	N/A	0 ~ 360 degree	N/A	Nov. 05, 2013~ Nov. 15, 2013	N/A	Radiation (03CH01-SZ)
Antenna Mast	EM electronics	EM 1000	N/A	1 m ~ 4 m	N/A	Nov. 05, 2013~ Nov. 15, 2013	N/A	Radiation (03CH01-SZ)



## 5 Uncertainty of Evaluation

### Uncertainty of Radiated Emission Measurement (30 MHz ~ 1000 MHz)

Measuring Uncertainty for a Level of Confidence of 95% ( $U = 2Uc(y)$ )	3.90
---	------