

# FCC RF Test Report

**APPLICANT** : Samsung Electronics Co., Ltd.  
**EQUIPMENT** : WCDMA Digital mobile phone  
**BRAND NAME** : SAMSUNG  
**MODEL NAME** : GT-S7272C  
**FCC ID** : A3LGTS7272C  
**STANDARD** : FCC Part 15 Subpart C §15.247  
**CLASSIFICATION** : (DTS) Digital Transmission System

The product was received on Nov. 26, 2013 and testing was completed on Dec. 16, 2013. We, SPORTON INTERNATIONAL (SHENZHEN) INC., would like to declare that the tested sample has been evaluated in accordance with the procedures and shown to be compliant with the applicable technical standards.

The test results in this report apply exclusively to the tested model / sample. Without written approval of SPORTON INTERNATIONAL (SHENZHEN) INC., the test report shall not be reproduced except in full.



Reviewed by: Joseph Lin / Supervisor



Approved by: Jones Tsai / Manager



## **SPORTON INTERNATIONAL (SHENZHEN) INC.**

**No. 3 Building, the third floor of south, Shahe River west, Fengzeyuan warehouse, Nanshan District, Shenzhen, Guangdong, P.R.C.**



# TABLE OF CONTENTS

**REVISION HISTORY..... 3**

**SUMMARY OF TEST RESULT ..... 4**

**1 GENERAL DESCRIPTION..... 5**

    1.1 Applicant ..... 5

    1.2 Manufacturer..... 5

    1.3 Feature of Equipment Under Test ..... 5

    1.4 Product Specification of Equipment Under Test..... 5

    1.5 Modification of EUT ..... 6

    1.6 Testing Site..... 6

    1.7 Applied Standards ..... 6

**2 TEST CONFIGURATION OF EQUIPMENT UNDER TEST..... 7**

    2.1 Descriptions of Test Mode ..... 7

    2.2 Test Mode..... 8

    2.3 Connection Diagram of Test System..... 9

    2.4 Support Unit used in test configuration and system ..... 10

    2.5 EUT Operation Test Setup ..... 10

    2.6 Measurement Results Explanation Example..... 10

**3 TEST RESULT ..... 11**

    3.1 6dB Bandwidth Measurement ..... 11

    3.2 Peak Output Power Measurement ..... 14

    3.3 Power Spectral Density Measurement ..... 16

    3.4 Conducted Band Edges and Spurious Emission Measurement ..... 22

    3.5 Radiated Band Edges and Spurious Emission Measurement ..... 30

    3.6 AC Conducted Emission Measurement..... 39

    3.7 Antenna Requirements..... 44

**4 LIST OF MEASURING EQUIPMENT..... 45**

**5 UNCERTAINTY OF EVALUATION..... 46**



## SUMMARY OF TEST RESULT

Report Section	FCC Rule	Description	Limit	Result	Remark
3.1	15.247(a)(2)	6dB Bandwidth	$\geq 0.5\text{MHz}$	Pass	-
3.2	15.247(b)(1)	Peak Output Power	$\leq 30\text{dBm}$	Pass	-
0	15.247(e)	Power Spectral Density	$\leq 8\text{dBm}$	Pass	-
3.4	15.247(d)	Conducted Band Edges and Spurious Emission	$\leq 20\text{dBc}$	Pass	-
3.5	15.247(d)	Radiated Band Edges and Spurious Emission	15.209(a) & 15.247(d)	Pass	Under limit 12.10 dB at 2499.130 MHz
3.6	15.207	AC Conducted Emission	15.207(a)	Pass	Under limit 12.30 dB at 3.360 MHz
3.7	15.203 & 15.247(b)	Antenna Requirement	N/A	Pass	-

# 1 General Description

## 1.1 Applicant

**Samsung Electronics Co., Ltd.**

No.9 WeiWu Rd., Micro Electronic Industrial Park, Jingang Highway, Xiqing District, Tianjin, China

## 1.2 Manufacturer

**Samsung Electronics Co., Ltd.**

No.9 WeiWu Rd., Micro Electronic Industrial Park, Jingang Highway, Xiqing District, Tianjin, China

## 1.3 Feature of Equipment Under Test

Product Feature	
Equipment	WCDMA Digital mobile phone
Brand Name	SAMSUNG
Model Name	GT-S7272C
FCC ID	A3LGTS7272C
GSM Operating Band(s)	GSM 850/900/1800/1900MHz
GPRS/EGPRS Multislot Class	GPRS Class 33, EGPRS Class 33
WCDMA Operating Band(s)	FDD Band I/VIII
Wi-Fi Specification	2.4GHz 802.11b/g/n HT20
Bluetooth Version	Bluetooth v3.0 + EDR/Bluetooth v4.0
HW Version	REV1.0
SW Version	S7272C.001
EUT Stage	Pre-Production

**Remark:** The above EUT's information was declared by manufacturer. Please refer to the specifications or user's manual for more detailed description.

## 1.4 Product Specification of Equipment Under Test

Product Specification subjective to this standard	
Tx/Rx Frequency Range	2402 MHz ~ 2480 MHz
Number of Channels	40
Carrier Frequency of Each Channel	40 Channel(37 hopping + 3 advertising channel)
Maximum Output Power to Antenna	2.03 dBm (0.0016 W)
Antenna Type	CAP Antenna with gain -4.20 dBi
Type of Modulation	Bluetooth 4.0 - LE : GFSK



### 1.5 Modification of EUT

No modifications are made to the EUT during all test items.

### 1.6 Testing Site

<b>Test Site</b>	SPORTON INTERNATIONAL (SHENZHEN) INC.			
<b>Test Site Location</b>	No. 3 Building, the third floor of south, Shahe River west, Fengzeyuan warehouse, Nanshan District, Shenzhen, Guangdong, P.R.C. TEL: +86-755- 3320-2398			
<b>Test Site No.</b>	<b>Sporton Site No.</b>			<b>FCC Registration No.</b>
	TH01-SZ	03CH01-SZ	CO01-SZ	831040

**Note:** The test site complies with ANSI C63.4 2003 requirement.

### 1.7 Applied Standards

According to the specifications of the manufacturer, the EUT must comply with the requirements of the following standards:

- FCC Part 15 Subpart C §15.247
- FCC KDB Publication No. 558074 D01 DTS Meas. Guidance v03r01
- ANSI C63.4-2003

**Remark:**

1. All test items were verified and recorded according to the standards and without any deviation during the test.
2. This EUT has also been tested and complied with the requirements of FCC Part 15, Subpart B, recorded in a separate test report.

## 2 Test Configuration of Equipment Under Test

### 2.1 Descriptions of Test Mode

The RF output power was recorded in the following table:

Channel	Frequency	Bluetooth 4.0 – LE RF Output Power	
		Data Rate / Modulation	
		GFSK	
		1Mbps	
Ch00	2402MHz	1.98 dBm	
Ch19	2440MHz	1.71 dBm	
Ch39	2480MHz	<b>2.03</b> dBm	

- a. The EUT has been associated with peripherals and configuration operated in a manner tended to maximize its emission characteristics in a typical application. Frequency range investigated: conduction (150 kHz to 30 MHz), radiation (9 kHz to the 10th harmonic of the highest fundamental frequency or to 40 GHz, whichever is lower). Pre-scanned tests, X, Y, Z in three orthogonal panels to determine the final configuration (X plane as worst plane) from all possible combinations.
  
- b. AC power line Conducted Emission was tested under maximum output power.

## 2.2 Test Mode

The following summary table is showing all test modes to demonstrate in compliance with the standard.

Summary table of Test Cases	
Test Item	Data Rate / Modulation
	Bluetooth 4.0 – LE / GFSK
<b>Conducted TCs</b>	Mode 1: Bluetooth Tx CH00_2402 MHz_1Mbps Mode 2: Bluetooth Tx CH19_2440 MHz_1Mbps Mode 3: Bluetooth Tx CH39_2480 MHz_1Mbps
<b>Radiated TCs</b>	Mode 1: Bluetooth Tx CH00_2402 MHz_1Mbps Mode 2: Bluetooth Tx CH19_2440 MHz_1Mbps Mode 3: Bluetooth Tx CH39_2480 MHz_1Mbps
<b>AC Conducted Emission</b>	Mode 1: GSM850 Idle + Bluetooth Link + WLAN Link + USB Cable (Charging from Adapter)
<b>Remark:</b> For Radiated TCs, The tests were performance with Adapter and USB Cable.	

## 2.3 Connection Diagram of Test System

### <Bluetooth 4.0 – LE Tx Mode>

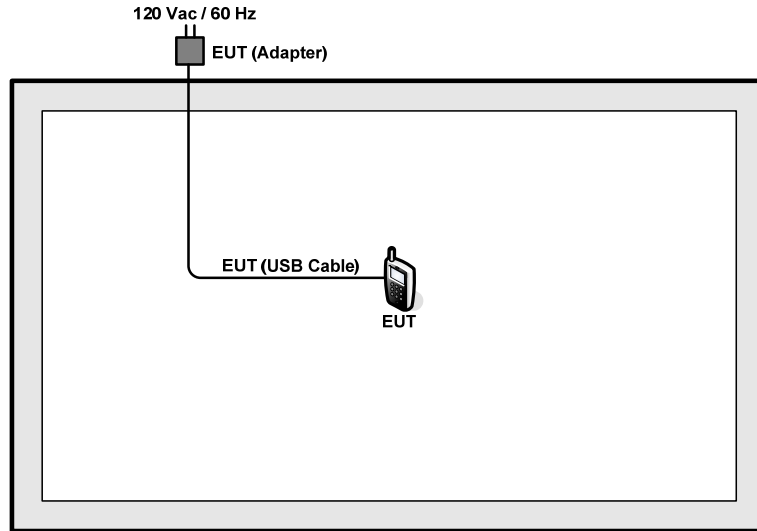

### <AC Conducted Emission Mode>

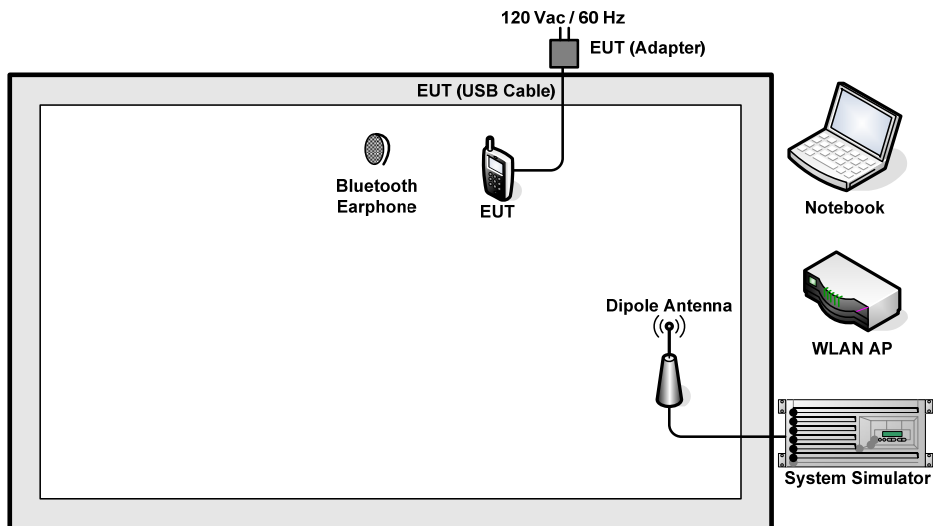

## 2.4 Support Unit used in test configuration and system

Item	Equipment	Trade Name	Model Name	FCC ID	Data Cable	Power Cord
1.	System Simulator	R&S	CMU 200	N/A	N/A	Unshielded, 1.8 m
2.	DC Power Supply	TOPWORD	3303DR	N/A	N/A	Unshielded, 1.8 m
3.	WLAN AP	D-Link	DIR-628	KA2DIR628A2	N/A	Unshielded, 1.8 m
4.	Notebook	DELL	Vostro1440	FCC DoC	N/A	AC I/P: Unshielded, 1.2 m DC O/P: Shielded, 1.8 m
5.	Bluetooth Earphone	Nokia	BH-108	PYAHS-107W	N/A	N/A

## 2.5 EUT Operation Test Setup

For Bluetooth 4.0 – LE function, the engineering test program was provided and enabled to make EUT continuous transmit/receive.

For AC power line conducted emissions, the EUT was set to connect with the WLAN AP under large package sizes transmission.

## 2.6 Measurement Results Explanation Example

**For all conducted test items:**

The offset level is set in the spectrum analyzer to compensate the RF cable loss and attenuator factor between EUT conducted output port and spectrum analyzer. With the offset compensation, the spectrum analyzer reading level is exactly the EUT RF output level.

Example :

The spectrum analyzer offset is derived from RF cable loss and attenuator factor.

*Offset = RF cable loss + attenuator factor.*

Following shows an offset computation example with cable loss 7.5 dB and 10dB attenuator.

$$\begin{aligned} \text{Offset(dB)} &= \text{RF cable loss(dB)} + \text{attenuator factor(dB)} \\ &= 7.5 + 10 = 17.5 \text{ (dB)} \end{aligned}$$

### 3 Test Result

#### 3.1 6dB Bandwidth Measurement

##### 3.1.1 Limit of 6dB Bandwidth

The minimum 6 dB bandwidth shall be at least 500 kHz.

##### 3.1.2 Measuring Instruments

The section 4.0 of List of Measuring Equipment of this test report is used for test.

##### 3.1.3 Test Procedures

1. The testing follows FCC KDB Publication No. 558074 D01 DTS Meas. Guidance v03r01.
2. The RF output of EUT was connected to the spectrum analyzer by RF cable and attenuator. The path loss was compensated to the results for each measurement.
3. Set to the maximum power setting and enable the EUT transmit continuously.
4. Make the measurement with the spectrum analyzer's resolution bandwidth (RBW) = 100 kHz. Set the Video bandwidth (VBW) = 300 kHz. In order to make an accurate measurement. The 6 dB bandwidth must be greater than 500 kHz.
5. Measure and record the results in the test report.

##### 3.1.4 Test Setup

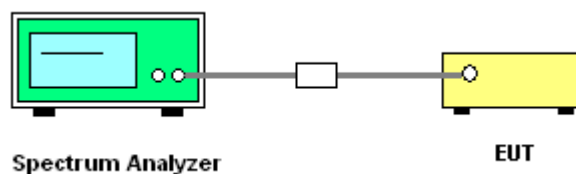



3.1.5 Test Result of 6dB Bandwidth

Test Mode :	Bluetooth 4.0 - LE	Temperature :	24~26°C
Test Engineer :	Blithe Li	Relative Humidity :	50~53%

Channel	Frequency (MHz)	6dB Bandwidth (MHz)	6dB Bandwidth Min. Limit (MHz)	Pass/Fail
00	2402	0.680	0.5	Pass
19	2440	0.674	0.5	Pass
39	2480	0.668	0.5	Pass

6 dB Bandwidth Plot on Channel 00

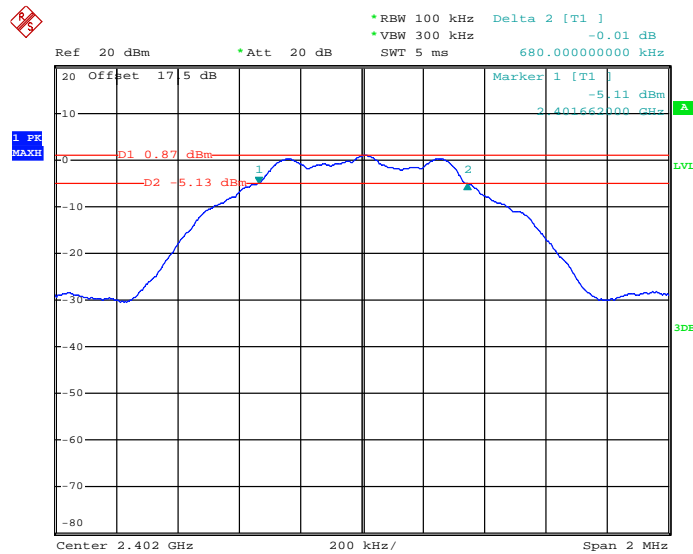

Date: 16.DEC.2013 15:26:03



### 6 dB Bandwidth Plot on Channel 19

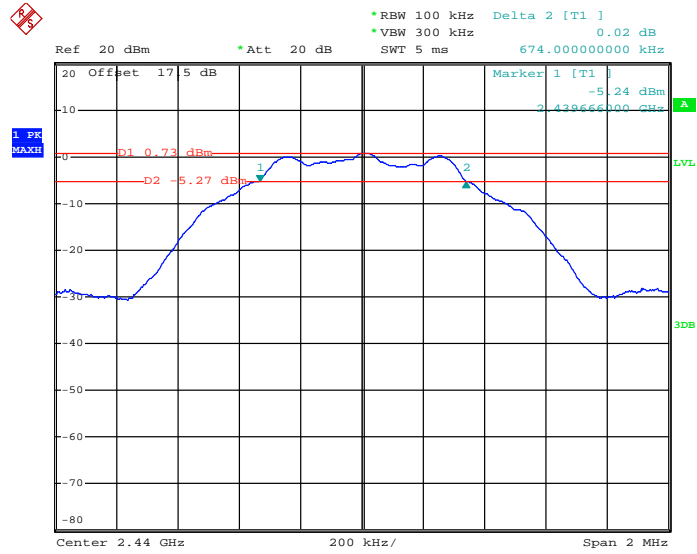

Date: 16.DEC.2013 15:29:53

### 6 dB Bandwidth Plot on Channel 39

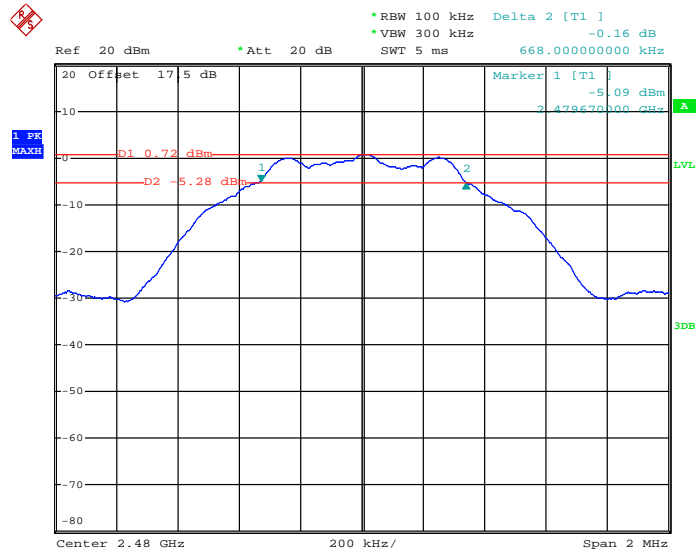

Date: 16.DEC.2013 15:35:11

## 3.2 Peak Output Power Measurement

### 3.2.1 Limit of Peak Output Power

For systems using digital modulation in the 2400-2483.5MHz, the limit for peak output power is 30dBm. If transmitting antenna of directional gain greater than 6dBi is used, the peak output power from the intentional radiator shall be reduced below the above stated value by the amount in dB that the directional gain of the antenna exceeds 6 dBi. In case of point-to-point operation, the limit has to be reduced by 1dB for every 3dB that the directional gain of the antenna exceeds 6dBi.

### 3.2.2 Measuring Instruments

The section 4.0 of List of Measuring Equipment of this test report is used for test.

### 3.2.3 Test Procedures

1. The testing follows the Measurement Procedure of FCC KDB No. 558074 DTS D01 Meas. Guidance v03r01.
2. The RF output of EUT was connected to the power meter by RF cable and attenuator. The path loss was compensated to the results for each measurement.
3. Set to the maximum power setting and enable the EUT transmit continuously.
4. Measure the conducted output power and record the results in the test report.

### 3.2.4 Test Setup

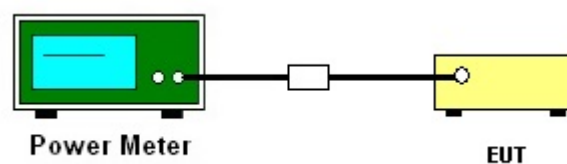



3.2.5 Test Result of Peak Output Power

Test Mode :	Bluetooth 4.0 - LE	Temperature :	24~26°C
Test Engineer :	Blithe Li	Relative Humidity :	50~53%

Channel	Frequency (MHz)	RF Power (dBm)		
		GFSK	Max. Limits (dBm)	Pass/Fail
		1 Mbps		
00	2402	1.98	30.00	Pass
19	2440	1.71	30.00	Pass
39	2480	2.03	30.00	Pass

### 3.3 Power Spectral Density Measurement

#### 3.3.1 Limit of Power Spectral Density

The peak power spectral density shall not be greater than 8dBm in any 3kHz band at any time interval of continuous transmission.

#### 3.3.2 Measuring Instruments

The section 4.0 of List of Measuring Equipment of this test report is used for test.

#### 3.3.3 Test Procedures

1. The testing follows Measurement Procedure 10.2 Method PKPSD of FCC KDB Publication No. 558074 D01 DTS Meas. Guidance v03r01
2. The RF output of EUT was connected to the spectrum analyzer by RF cable and attenuator. The path loss was compensated to the results for each measurement.
3. Set to the maximum power setting and enable the EUT transmit continuously.
4. Make the measurement with the spectrum analyzer's resolution bandwidth (RBW) = 3 kHz. Video bandwidth VBW = 10 kHz In order to make an accurate measurement, set the span to 1.5 times DTS Channel Bandwidth. (6dB BW)
5. Detector = peak, Sweep time = auto couple, Trace mode = max hold, Allow trace to fully stabilize. Use the peak marker function to determine the maximum power level.
6. Measure and record the results in the test report.
7. The Measured power density (dBm)/ 100kHz is a reference level and used as 20dBc down limit line for Conducted Band Edges and Conducted Spurious Emission.

#### 3.3.4 Test Setup

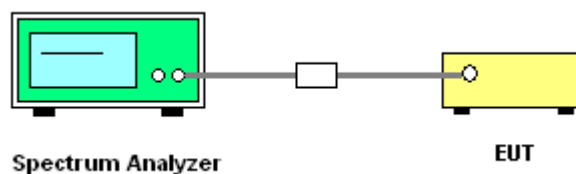

**3.3.5 Test Result of Power Spectral Density**

<b>Test Mode :</b>	Bluetooth 4.0 - LE	<b>Temperature :</b>	24~26°C
<b>Test Engineer :</b>	Blithe Li	<b>Relative Humidity :</b>	50~53%

Channel	Frequency (MHz)	Power Density		Max. Limits (dBm/3kHz)	Pass/Fail
		PSD/100kHz (dBm)	PSD/3kHz (dBm)		
00	2402	0.87	-14.40	8	Pass
19	2440	0.73	-14.48	8	Pass
39	2480	0.69	-14.50	8	Pass

**Note:**

1. Measured power density (dBm) has offset with cable loss.
2. The Measured power density (dBm)/ 100kHz is reference level and used as 20dBc down for Conducted Band Edges and Conducted Spurious Emission limit line.



### 3.3.6 Test Result of Power Spectral Density Plots (100kHz)

PSD 100kHz Plot on Channel 00

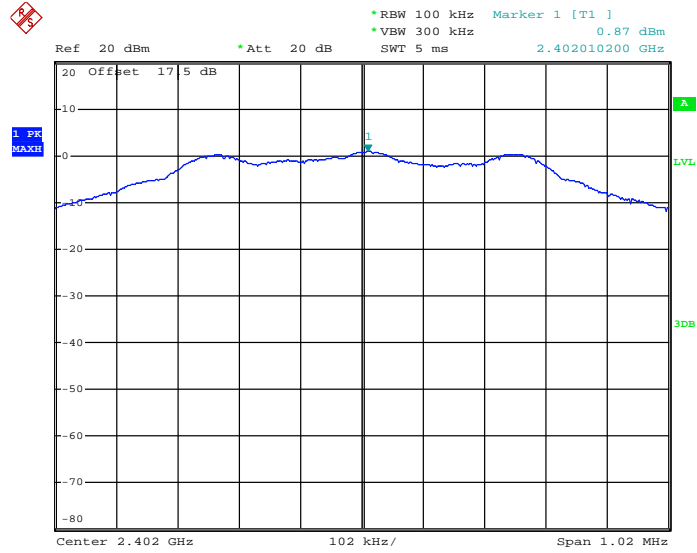

Date: 16.DEC.2013 15:26:31



### PSD 100kHz Plot on Channel 19

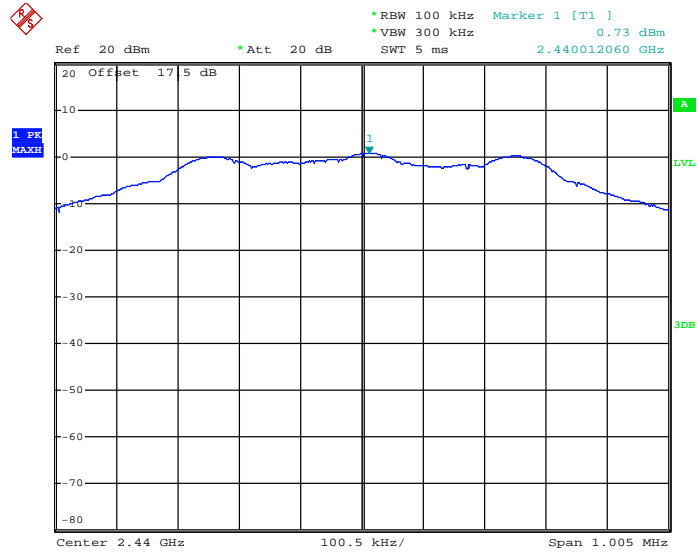

Date: 16.DEC.2013 15:30:22

### PSD 100kHz Plot on Channel 39

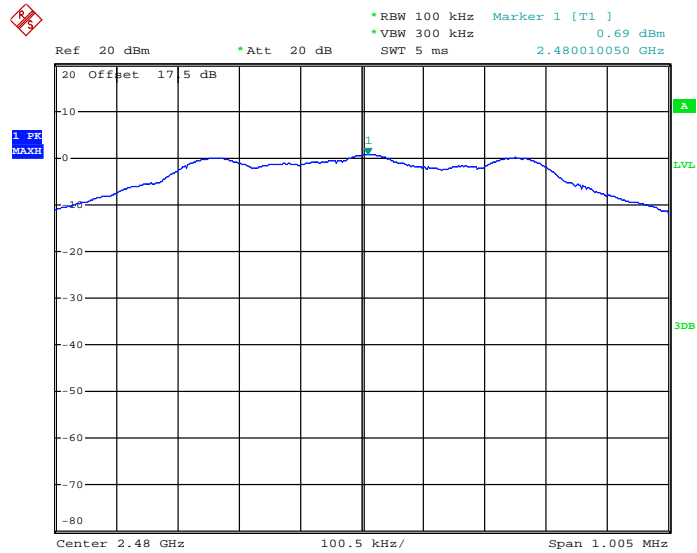

Date: 16.DEC.2013 15:35:39



### 3.3.7 Test Result of Power Spectral Density Plots (3kHz)

PSD 3kHz Plot on Channel 00

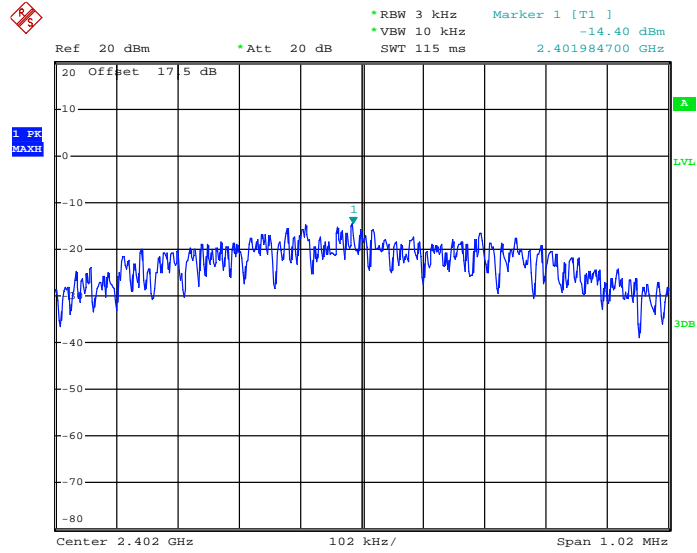

Date: 16.DEC.2013 15:26:22



PSD 3kHz Plot on Channel 19

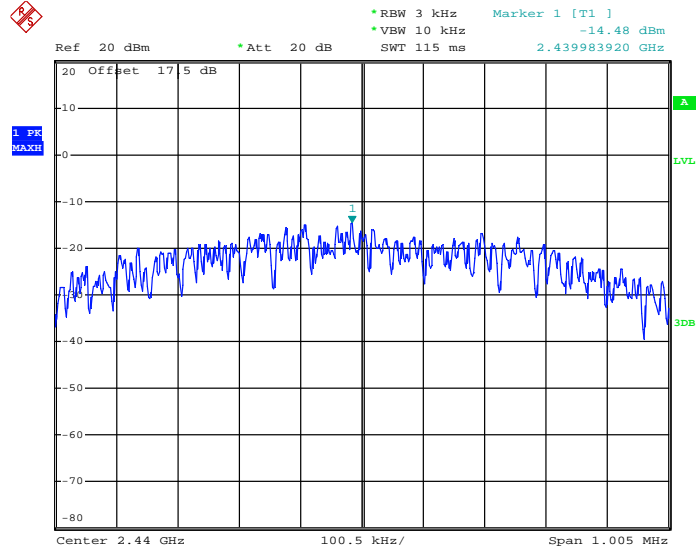

Date: 16.DEC.2013 15:30:13

PSD 3kHz Plot on Channel 39

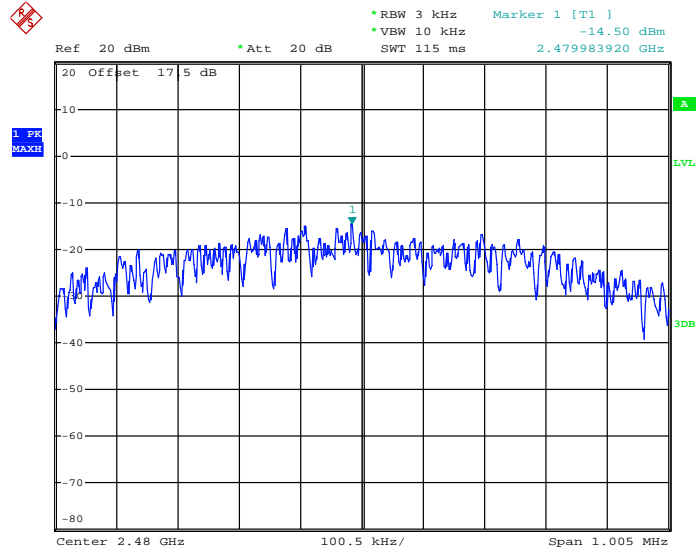

Date: 16.DEC.2013 15:35:31

### 3.4 Conducted Band Edges and Spurious Emission Measurement

#### 3.4.1 Limit of Conducted Band Edges and Spurious Emission

All harmonics/spurious must be at least 20 dB down from the highest emission level within the authorized band.

#### 3.4.2 Measuring Instruments

The section 4.0 of List of Measuring Equipment of this test report is used for test.

#### 3.4.3 Test Procedure

1. The testing follows FCC KDB Publication No. 558074 D01 DTS Meas. Guidance v03r01.
2. The RF output of EUT was connected to the spectrum analyzer by RF cable and attenuator. The path loss was compensated to the results for each measurement.
3. Set to the maximum power setting and enable the EUT transmit continuously.
4. Set RBW = 100 kHz, VBW=300 kHz, Peak Detector. Unwanted Emissions measured in any 100 kHz bandwidth outside of the authorized frequency band shall be attenuated by at least 20 dB relative to the maximum in-band peak PSD level in 100 kHz when maximum peak conducted output power procedure is used. If the transmitter complies with the conducted power limits based on the use of RMS averaging over a time interval, the attenuation required under this paragraph shall be 30 dB instead of 20 dB per 15.247(d).
5. Measure and record the results in the test report.
6. The RF fundamental frequency should be excluded against the limit line in the operating frequency band.

#### 3.4.4 Test Setup

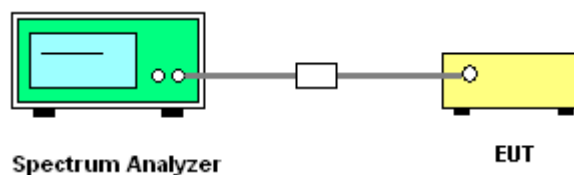



### 3.4.5 Test Result of Conducted Band Edges

Test Mode :	Bluetooth 4.0 - LE	Temperature :	24~26°C
Test Channel :	00 and 39	Relative Humidity :	50~53%
		Test Engineer :	Blithe Li

Low Band Edge Plot on Channel 00

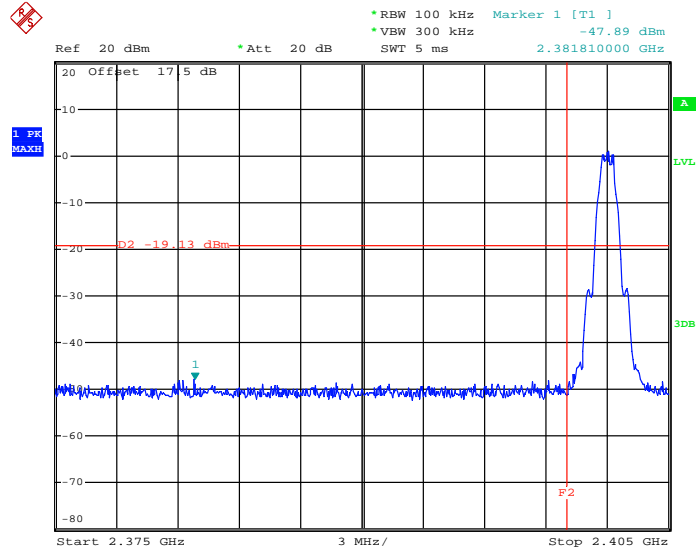

Date: 16.DEC.2013 15:26:45

High Band Edge Plot on Channel 39

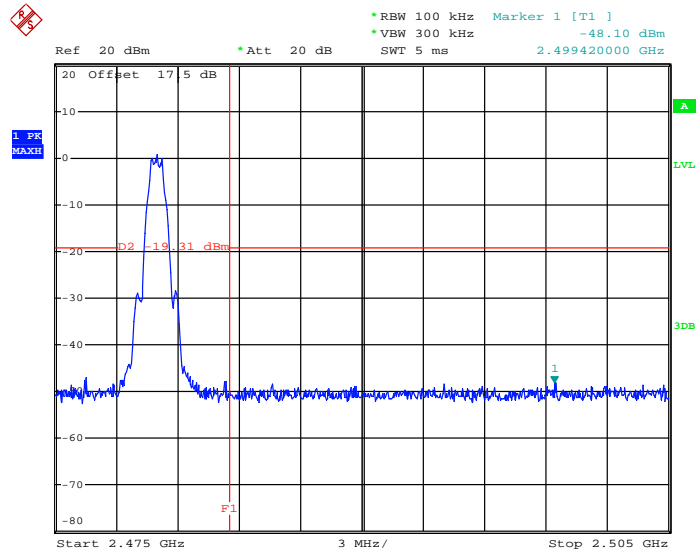

Date: 16.DEC.2013 15:35:54

### 3.4.6 Test Result of Conducted Spurious Emission

Test Mode :	Bluetooth 4.0 - LE	Temperature :	24~26°C
Test Channel :	00	Relative Humidity :	50~53%
		Test Engineer :	Blithe Li

Conducted Spurious Emission Plot on Bluetooth LE 1Mbps  
GFSK Channel 00

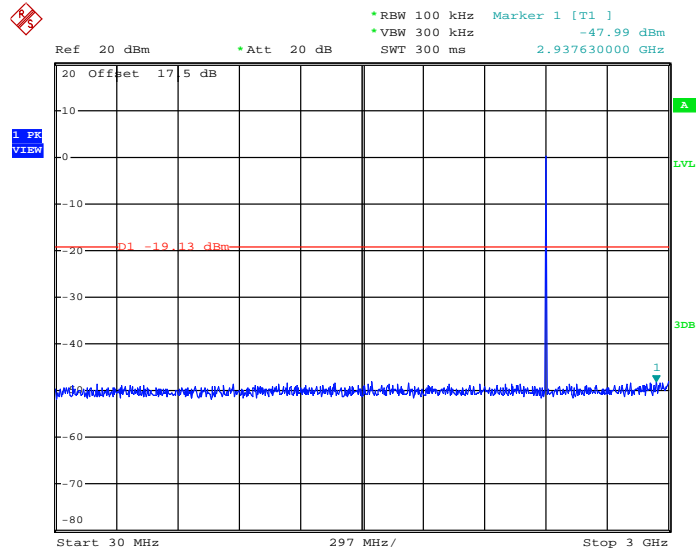

Date: 16.DEC.2013 15:27:04



### Conducted Spurious Emission Plot on Bluetooth LE 1Mbps GFSK Channel 00

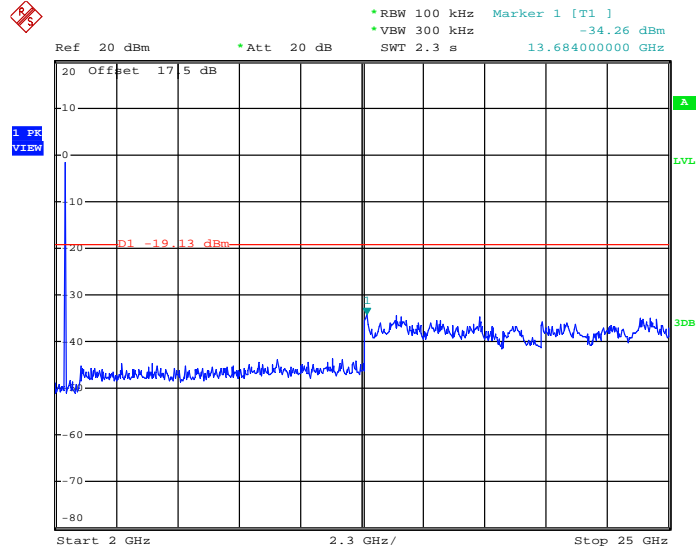

Date: 16.DEC.2013 15:27:23



Test Mode :	Bluetooth 4.0 - LE	Temperature :	24~26°C
Test Channel :	19	Relative Humidity :	50~53%
		Test Engineer :	Blithe Li

Conducted Spurious Emission Plot on Bluetooth LE 1Mbps  
GFSK Channel 19

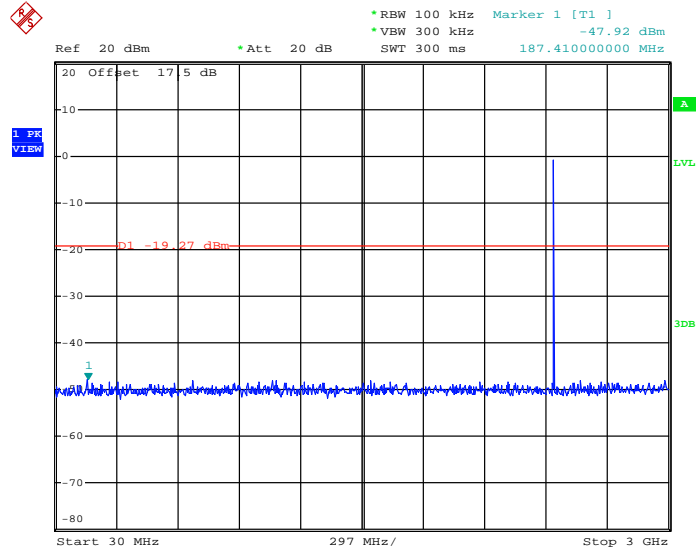

Date: 16.DEC.2013 15:30:42



### Conducted Spurious Emission Plot on Bluetooth LE 1Mbps GFSK Channel 19

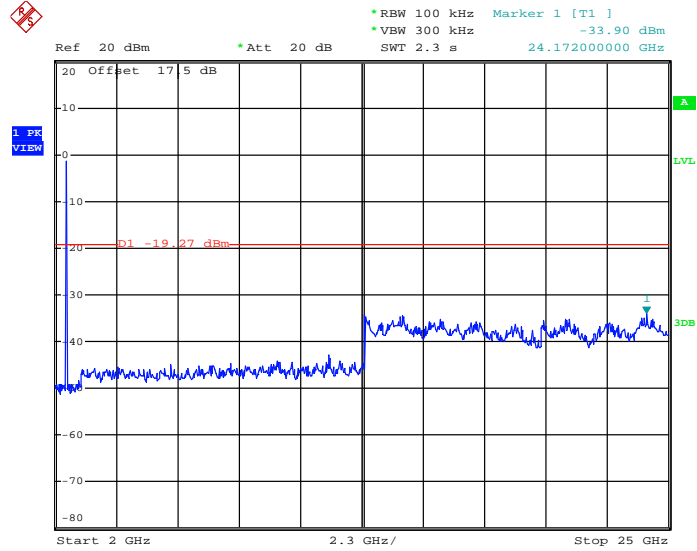

Date: 16.DEC.2013 15:31:00



Test Mode :	Bluetooth 4.0 - LE	Temperature :	24~26°C
Test Channel :	39	Relative Humidity :	50~53%
		Test Engineer :	Blithe Li

Conducted Spurious Emission Plot on Bluetooth LE 1Mbps  
GFSK Channel 39

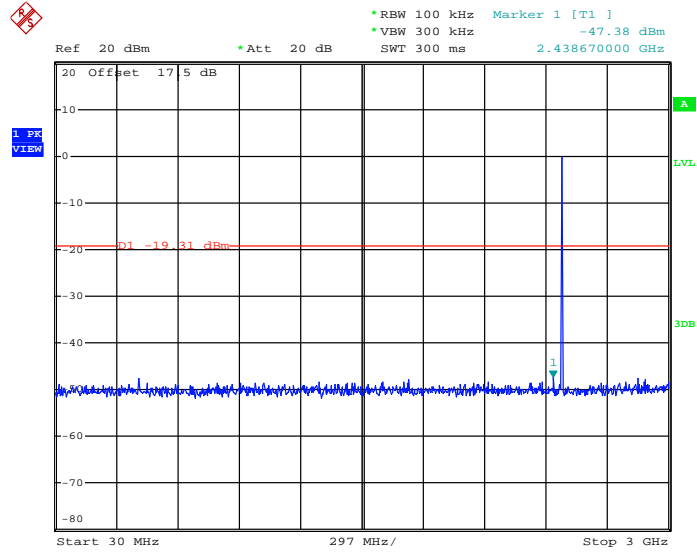

Date: 16.DEC.2013 15:36:13



### Conducted Spurious Emission Plot on Bluetooth LE 1Mbps GFSK Channel 39

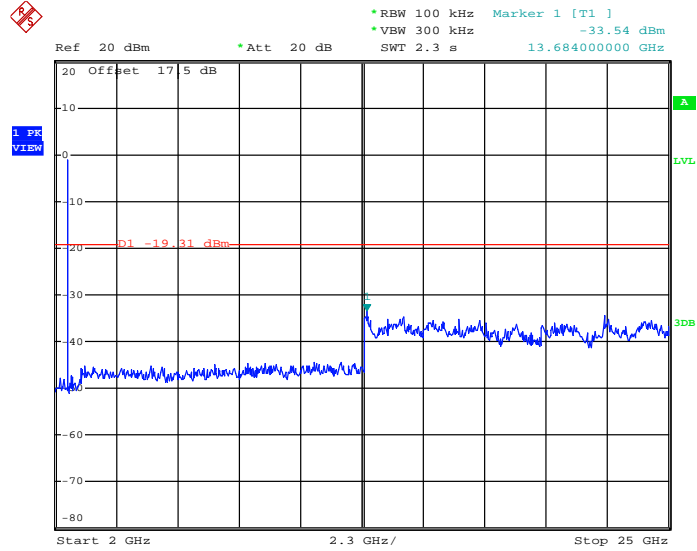

Date: 16.DEC.2013 15:36:32

### 3.5 Radiated Band Edges and Spurious Emission Measurement

#### 3.5.1 Limit of Radiated Band Edges and Spurious Emission

In any 100 kHz bandwidth outside the intentional radiator frequency band, all harmonics/spurious must be at least 20 dB below the highest emission level within the authorized band. If the output power of this device was measured by spectrum analyzer, the attenuation under this paragraph shall be 30 dB instead of 20 dB. In addition, radiated emissions which fall in the restricted bands must also comply with the FCC section 15.209 limits as below.

Frequency (MHz)	Field Strength (microvolts/meter)	Measurement Distance (meters)
0.009 – 0.490	2400/F(kHz)	300
0.490 – 1.705	24000/F(kHz)	30
1.705 – 30.0	30	30
30 – 88	100	3
88 – 216	150	3
216 - 960	200	3
Above 960	500	3

#### 3.5.2 Measuring Instruments

The section 4.0 of List of Measuring Equipment of this test report is used for test.

**3.5.3 Test Procedures**

1. The testing follows FCC KDB Publication No. 558074 D01 DTS Meas. Guidance v03r01.
2. The EUT was arranged to its worst case and then tune the antenna tower (from 1 m to 4 m) and turntable (from 0 degree to 360 degrees) to find the maximum reading. A pre-amp and a high pass filter are used for the test in order to get better signal level.
3. The EUT was placed on a turntable with 0.8 meter above ground.
4. The EUT was set 3 meters from the interference receiving antenna, which was mounted on the top of a variable height antenna tower.
5. Corrected Reading: Antenna Factor + Cable Loss + Read Level - Preamp Factor = Level
6. For measurement below 1GHz, If the emission level of the EUT measured by the peak detector is 3 dB lower than the applicable limit, the peak emission level will be reported. Otherwise, the emission measurement will be repeated using the quasi-peak detector and reported.
7. Use the following spectrum analyzer settings:
  - (1) Span shall wide enough to fully capture the emission being measured;
  - (2) Set RBW=100 kHz for  $f < 1$  GHz;  $VBW \geq RBW$ ; Sweep = auto; Detector function = peak; Trace = max hold;
  - (3) Set RBW = 1 MHz, VBW= 3MHz for  $f \geq 1$  GHz for peak measurement.  
 For average measurement:
    - $VBW = 10$  Hz, when duty cycle is no less than 98 percent.
    - $VBW \geq 1/T$ , when duty cycle is less than 98 percent where T is the minimum transmission duration over which the transmitter is on and is transmitting at its maximum power control level for the tested mode of operation.

Band	Duty Cycle(%)	T(ms)	1/T(kHz)	VBW Setting
Bluetooth 4.0 - LE	62.66	0.396	2.525	3kHz

### 3.5.4 Test Setup

For radiated emissions below 30MHz

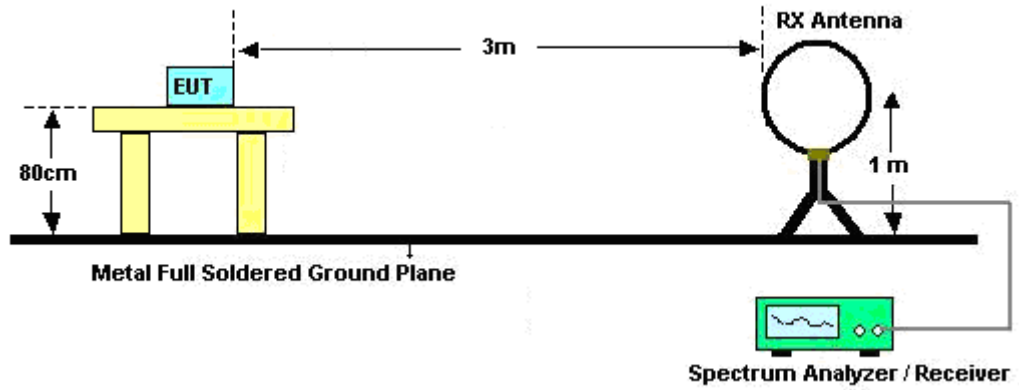

For radiated emissions from 30MHz to 1GHz

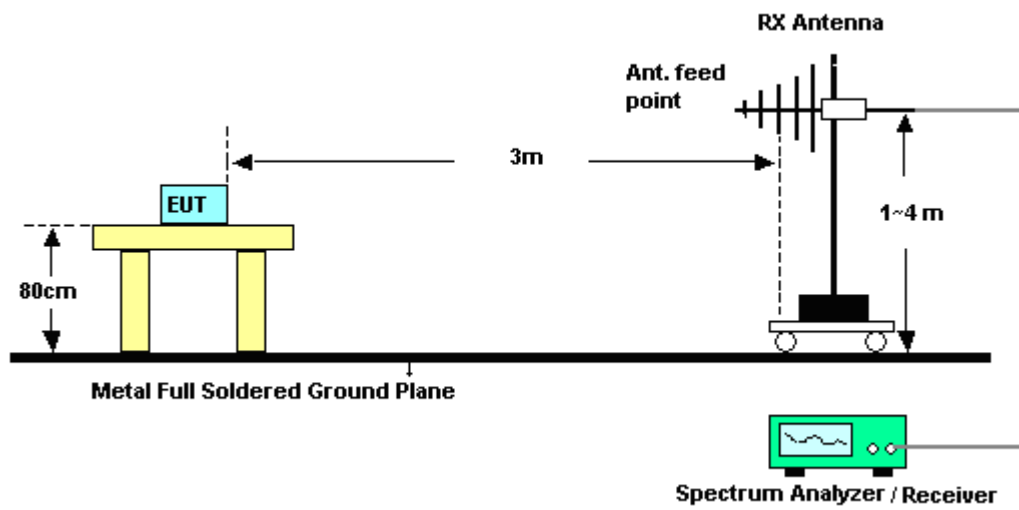

For radiated emissions above 1GHz

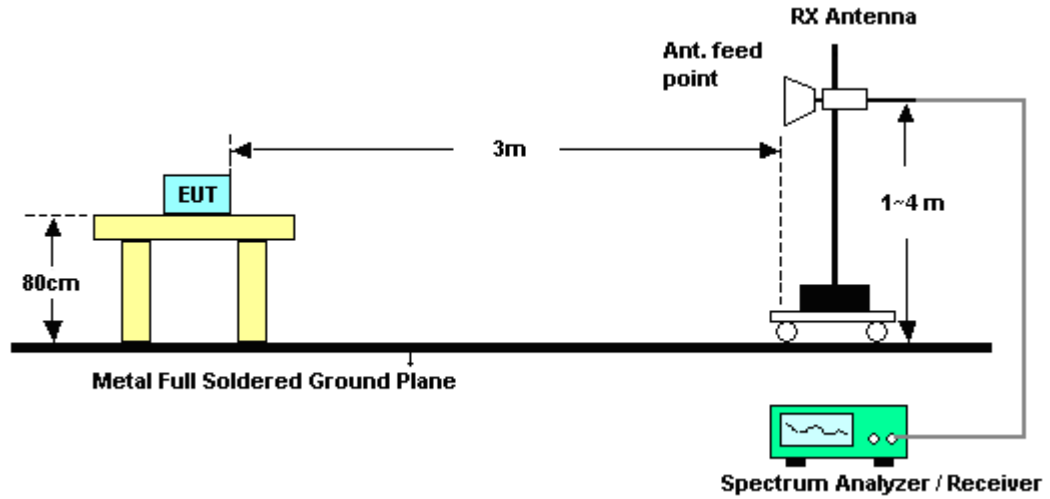

### 3.5.5 Test Results of Radiated Spurious Emissions (9 kHz ~ 30 MHz)

The low frequency, which started from 9 kHz to 30MHz, was pre-scanned and the result which was 20dB lower than the limit line per 15.31(o) was not reported.



3.5.6 Test Result of Radiated Spurious at Band Edges

Test Mode :	Mode 1	Temperature :	24~25°C
Test Channel :	00	Relative Humidity :	48~49%
		Test Engineer :	Leo Liao

ANTENNA POLARITY : HORIZONTAL										
Frequency ( MHz )	Level (dBμV /m )	Over Limit ( dB )	Limit Line (dBμV /m )	Read Level (dBμV)	Antenna Factor ( dB )	Cable Loss ( dB )	Preamp Factor ( dB )	Ant Pos ( cm )	Table Pos ( deg )	Remark
2383.35	48.72	-25.28	74	41.52	31.9	5.59	30.29	101	120	Peak
2382.81	40.99	-13.01	54	33.79	31.9	5.59	30.29	101	120	Average

ANTENNA POLARITY : VERTICAL										
Frequency ( MHz )	Level (dBμV /m )	Over Limit ( dB )	Limit Line (dBμV /m )	Read Level (dBμV)	Antenna Factor ( dB )	Cable Loss ( dB )	Preamp Factor ( dB )	Ant Pos ( cm )	Table Pos ( deg )	Remark
2368.41	47.47	-26.53	74	40.37	31.81	5.59	30.3	198	154	Peak
2382.63	38.76	-15.24	54	31.56	31.9	5.59	30.29	198	154	Average

Test Mode :	Mode 3	Temperature :	24~25°C
Test Channel :	39	Relative Humidity :	48~49%
		Test Engineer :	Leo Liao

ANTENNA POLARITY : HORIZONTAL										
Frequency ( MHz )	Level (dBμV /m )	Over Limit ( dB )	Limit Line (dBμV /m )	Read Level (dBμV)	Antenna Factor ( dB )	Cable Loss ( dB )	Preamp Factor ( dB )	Ant Pos ( cm )	Table Pos ( deg )	Remark
2499.55	49.46	-24.54	74	41.45	32.5	5.74	30.23	100	119	Peak
2499.13	41.9	-12.1	54	33.89	32.5	5.74	30.23	100	119	Average

ANTENNA POLARITY : VERTICAL										
Frequency ( MHz )	Level (dBμV /m )	Over Limit ( dB )	Limit Line (dBμV /m )	Read Level (dBμV)	Antenna Factor ( dB )	Cable Loss ( dB )	Preamp Factor ( dB )	Ant Pos ( cm )	Table Pos ( deg )	Remark
2483.86	48.3	-25.7	74	40.42	32.41	5.71	30.24	148	16	Peak
2499.19	38.79	-15.21	54	30.78	32.5	5.74	30.23	148	16	Average

### 3.5.7 Test Result of Radiated Spurious Emission (30MHz ~ 10<sup>th</sup> Harmonic)

**Note:** Pre-scanned all test modes and only choose the worst case mode recorded in the test report for radiated spurious emission below 1GHz.

<b>Test Mode :</b>	Mode 1	<b>Temperature :</b>	24~25°C
<b>Test Channel :</b>	00	<b>Relative Humidity :</b>	48~49%
<b>Test Engineer :</b>	Leo Liao	<b>Polarization :</b>	Horizontal
<b>Remark :</b>	1. 2402 MHz is fundamental signal which can be ignored. 2. Average measurement was not performed if peak level went lower than the average limit.		

Frequency ( MHz )	Level ( dBμV/m )	Over Limit ( dB )	Limit Line ( dBμV/m )	Read Level ( dBμV )	Antenna Factor ( dB )	Cable Loss ( dB )	Preamp Factor ( dB )	Ant Pos ( cm )	Table Pos ( deg )	Remark
2402	100.21	-	-	92.89	31.98	5.62	30.28	101	120	Peak
2402	99.37	-	-	92.05	31.98	5.62	30.28	101	120	Average
4804	36.99	-37.01	74	52.17	33.78	8.33	57.29	119	148	Peak

**Note:** Other harmonics are lower than background noise.

<b>Test Mode :</b>	Mode 1	<b>Temperature :</b>	24~25°C
<b>Test Channel :</b>	00	<b>Relative Humidity :</b>	48~49%
<b>Test Engineer :</b>	Leo Liao	<b>Polarization :</b>	Vertical
<b>Remark :</b>	1. 2402 MHz is fundamental signal which can be ignored. 2. Average measurement was not performed if peak level went lower than the average limit.		

Frequency ( MHz )	Level ( dBμV/m )	Over Limit ( dB )	Limit Line ( dBμV/m )	Read Level ( dBμV )	Antenna Factor ( dB )	Cable Loss ( dB )	Preamp Factor ( dB )	Ant Pos ( cm )	Table Pos ( deg )	Remark
2402	96.72	-	-	89.4	31.98	5.62	30.28	198	154	Peak
2402	95.89	-	-	88.57	31.98	5.62	30.28	198	154	Average
4804	36.11	-37.89	74	51.29	33.78	8.33	57.29	119	148	Peak

**Note:** Other harmonics are lower than background noise.



<b>Test Mode :</b>	Mode 2	<b>Temperature :</b>	24~25°C
<b>Test Channel :</b>	19	<b>Relative Humidity :</b>	48~49%
<b>Test Engineer :</b>	Leo Liao	<b>Polarization :</b>	Horizontal
<b>Remark :</b>	1. 2440 MHz is fundamental signal which can be ignored. 2. Average measurement was not performed if peak level went lower than the average limit.		

Frequency ( MHz )	Level ( dBμV/m )	Over Limit ( dB )	Limit Line ( dBμV/m )	Read Level ( dBμV )	Antenna Factor ( dB )	Cable Loss ( dB )	Preamp Factor ( dB )	Ant Pos ( cm )	Table Pos ( deg )	Remark
2440	101.77	-	-	94.14	32.24	5.65	30.26	102	118	Peak
2440	100.91	-	-	93.28	32.24	5.65	30.26	102	118	Average
4880	36.13	-37.87	74	50.96	33.93	8.41	57.17	110	245	Peak
7320	37.93	-36.07	74	51.17	33.9	10	57.14	184	225	Peak

**Note:** Other harmonics are lower than background noise.

<b>Test Mode :</b>	Mode 2	<b>Temperature :</b>	24~25°C
<b>Test Channel :</b>	19	<b>Relative Humidity :</b>	48~49%
<b>Test Engineer :</b>	Leo Liao	<b>Polarization :</b>	Vertical
<b>Remark :</b>	1. 2440 MHz is fundamental signal which can be ignored. 2. Average measurement was not performed if peak level went lower than the average limit.		

Frequency ( MHz )	Level ( dBμV/m )	Over Limit ( dB )	Limit Line ( dBμV/m )	Read Level ( dBμV )	Antenna Factor ( dB )	Cable Loss ( dB )	Preamp Factor ( dB )	Ant Pos ( cm )	Table Pos ( deg )	Remark
2440	96.37	-	-	88.74	32.24	5.65	30.26	200	155	Peak
2440	95.58	-	-	87.95	32.24	5.65	30.26	200	155	Average
4880	36.02	-37.98	74	50.85	33.93	8.41	57.17	110	245	Peak
7320	37.97	-36.03	74	51.21	33.9	10	57.14	184	225	Peak

**Note:** Other harmonics are lower than background noise.



<b>Test Mode :</b>	Mode 3	<b>Temperature :</b>	24~25°C
<b>Test Channel :</b>	39	<b>Relative Humidity :</b>	48~49%
<b>Test Engineer :</b>	Leo Liao	<b>Polarization :</b>	Horizontal
<b>Remark :</b>	1. 2480 MHz is fundamental signal which can be ignored. 2. Average measurement was not performed if peak level went lower than the average limit.		

Frequency ( MHz )	Level ( dBμV/m )	Over Limit ( dB )	Limit Line ( dBμV/m )	Read Level ( dBμV )	Antenna Factor ( dB )	Cable Loss ( dB )	Preamp Factor ( dB )	Ant Pos ( cm )	Table Pos ( deg )	Remark
121.18	17.03	-26.47	43.5	34.08	12.2	1.35	30.6	-	-	Peak
257.95	21.16	-24.84	46	35.99	13.43	1.88	30.14	-	-	Peak
417.03	23.97	-22.03	46	34.46	16.78	2.34	29.61	-	-	Peak
608.12	24.07	-21.93	46	31.34	19.14	2.78	29.19	-	-	Peak
773.02	26.91	-19.09	46	32.33	20.44	3.11	28.97	156	268	Peak
973.81	27.38	-26.62	54	30.69	21.92	3.47	28.7	-	-	Peak
2480	99.6	-	-	91.72	32.41	5.71	30.24	100	119	Peak
2480	98.64	-	-	90.76	32.41	5.71	30.24	100	119	Average
4960	36.86	-37.14	74	51.27	34.12	8.49	57.02	150	135	Peak
7440	37.53	-36.47	74	50.51	33.97	10.04	56.99	175	260	Peak

**Note:** Other harmonics are lower than background noise.



<b>Test Mode :</b>	Mode 3	<b>Temperature :</b>	24~25°C
<b>Test Channel :</b>	39	<b>Relative Humidity :</b>	48~49%
<b>Test Engineer :</b>	Leo Liao	<b>Polarization :</b>	Vertical
<b>Remark :</b>	1. 2480 MHz is fundamental signal which can be ignored. 2. Average measurement was not performed if peak level went lower than the average limit.		

Frequency ( MHz )	Level ( dBμV/m )	Over Limit ( dB )	Limit Line ( dBμV/m )	Read Level ( dBμV )	Antenna Factor ( dB )	Cable Loss ( dB )	Preamp Factor ( dB )	Ant Pos ( cm )	Table Pos ( deg )	Remark
109.54	16.94	-26.56	43.5	34.18	12.07	1.32	30.63	-	-	Peak
279.29	22.61	-23.39	46	37.73	13	1.95	30.07	-	-	Peak
430.61	23.27	-22.73	46	33.77	16.7	2.36	29.56	-	-	Peak
651.77	28.84	-17.16	46	35.8	19.32	2.85	29.13	-	-	Peak
803.09	29.02	-16.98	46	34.17	20.62	3.16	28.93	152	132	Peak
969.93	28.83	-25.17	54	32.28	21.8	3.46	28.71	-	-	Peak
2480	94.22	-	-	86.34	32.41	5.71	30.24	148	16	Peak
2480	93.39	-	-	85.51	32.41	5.71	30.24	148	16	Average
4960	36.67	-37.33	74	51.08	34.12	8.49	57.02	150	135	Peak
7440	37.83	-36.17	74	50.81	33.97	10.04	56.99	175	260	Peak

**Note:** Other harmonics are lower than background noise.

## 3.6 AC Conducted Emission Measurement

### 3.6.1 Limit of AC Conducted Emission

For equipment that is designed to be connected to the public utility (AC) power line, the radio frequency voltage that is conducted back onto the AC power line on any frequency or frequencies within the band 150 kHz to 30 MHz shall not exceed the limits in the following table.

Frequency of emission (MHz)	Conducted limit (dB $\mu$ V)	
	Quasi-peak	Average
0.15-0.5	66 to 56*	56 to 46*
0.5-5	56	46
5-30	60	50

\*Decreases with the logarithm of the frequency.

### 3.6.2 Measuring Instruments

The section 4.0 of List of Measuring Equipment of this test report is used for test.

### 3.6.3 Test Procedures

1. The EUT was placed 0.4 meter from the conducting wall of the shielding room was kept at least 80 centimeters from any other grounded conducting surface.
2. Connect EUT to the power mains through a line impedance stabilization network (LISN).
3. All the support units are connecting to the other LISN.
4. The LISN provides 50 ohm coupling impedance for the measuring instrument.
5. The FCC states that a 50 ohm, 50 microhenry LISN should be used.
6. Both sides of AC line were checked for maximum conducted interference.
7. The frequency range from 150 kHz to 30 MHz was searched.
8. Set the test-receiver system to Peak Detect Function and specified bandwidth with Maximum Hold Mode.





3.6.5 Test Result of AC Conducted Emission

Test Mode :	Mode 1	Temperature :	24~25°C
Test Engineer :	Henry Chen	Relative Humidity :	53~54%
Test Voltage :	120Vac / 60Hz	Phase :	Line
Function Type :	GSM850 Idle + Bluetooth Link + WLAN Link + USB Cable (Charging from Adapter)		

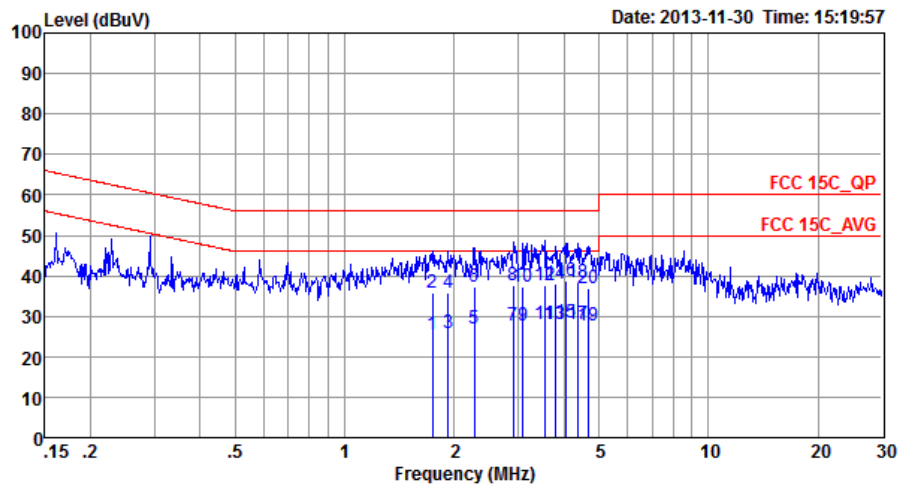

Site : CO01-SZ  
 Condition: FCC 15C\_QP LISN\_L\_20130328 LINE

	Freq	Level	Over Limit	Limit Line	Read Level	LISN Factor	Cable Loss	Remark
	MHz	dBuV	dB	dBuV	dBuV	dB	dB	
1	1.74	25.60	-20.40	46.00	15.20	0.22	10.18	Average
2	1.74	35.80	-20.20	56.00	25.40	0.22	10.18	QP
3	1.93	25.81	-20.19	46.00	15.40	0.23	10.18	Average
4	1.93	35.81	-20.19	56.00	25.40	0.23	10.18	QP
5	2.27	26.83	-19.17	46.00	16.40	0.24	10.19	Average
6	2.27	37.13	-18.87	56.00	26.70	0.24	10.19	QP
7	2.90	27.57	-18.43	46.00	17.11	0.26	10.20	Average
8	2.90	37.67	-18.33	56.00	27.21	0.26	10.20	QP
9	3.09	27.68	-18.32	46.00	17.20	0.27	10.21	Average
10	3.09	37.18	-18.82	56.00	26.70	0.27	10.21	QP
11	3.55	27.89	-18.11	46.00	17.40	0.28	10.21	Average
12	3.55	37.69	-18.31	56.00	27.20	0.28	10.21	QP
13	3.80	28.10	-17.90	46.00	17.59	0.29	10.22	Average
14	3.80	38.10	-17.90	56.00	27.59	0.29	10.22	QP
15	4.05	28.51	-17.49	46.00	18.00	0.29	10.22	Average
16 *	4.05	38.61	-17.39	56.00	28.10	0.29	10.22	QP
17	4.36	28.13	-17.87	46.00	17.60	0.30	10.23	Average
18	4.36	38.33	-17.67	56.00	27.80	0.30	10.23	QP
19	4.67	27.54	-18.46	46.00	17.01	0.30	10.23	Average
20	4.67	36.94	-19.06	56.00	26.41	0.30	10.23	QP



Test Mode :	Mode 1	Temperature :	24~25°C
Test Engineer :	Henry Chen	Relative Humidity :	53~54%
Test Voltage :	120Vac / 60Hz	Phase :	Neutral
Function Type :	GSM850 Idle + Bluetooth Link + WLAN Link + USB Cable (Charging from Adapter)		

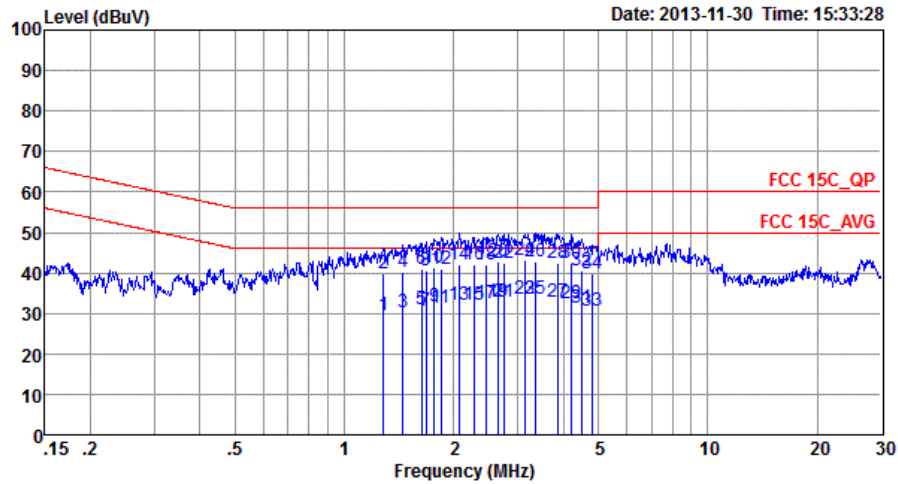

Site : C001-SZ  
 Condition: FCC 15C\_QP LISN\_N\_20130328 NEUTRAL

	Freq	Level	Over Limit	Limit Line	Read Level	LISN Factor	Cable Loss	Remark
	MHz	dBuV	dB	dBuV	dBuV	dB	dB	
1	1.28	29.61	-16.39	46.00	19.40	0.05	10.16	Average
2	1.28	40.01	-15.99	56.00	29.80	0.05	10.16	QP
3	1.45	30.22	-15.78	46.00	20.00	0.05	10.17	Average
4	1.45	40.32	-15.68	56.00	30.10	0.05	10.17	QP
5	1.63	30.83	-15.17	46.00	20.61	0.05	10.17	Average
6	1.63	40.93	-15.07	56.00	30.71	0.05	10.17	QP
7	1.68	30.63	-15.37	46.00	20.39	0.06	10.18	Average
8	1.68	40.53	-15.47	56.00	30.29	0.06	10.18	QP
9	1.77	31.64	-14.36	46.00	21.40	0.06	10.18	Average
10	1.77	41.24	-14.76	56.00	31.00	0.06	10.18	QP
11	1.85	31.34	-14.66	46.00	21.10	0.06	10.18	Average
12	1.85	41.04	-14.96	56.00	30.80	0.06	10.18	QP
13	2.07	32.05	-13.95	46.00	21.80	0.06	10.19	Average
14	2.07	42.25	-13.75	56.00	32.00	0.06	10.19	QP
15	2.27	32.26	-13.74	46.00	22.00	0.07	10.19	Average
16	2.27	41.96	-14.04	56.00	31.70	0.07	10.19	QP
17	2.45	32.47	-13.53	46.00	22.20	0.07	10.20	Average
18	2.45	42.07	-13.93	56.00	31.80	0.07	10.20	QP
19	2.65	32.97	-13.03	46.00	22.69	0.08	10.20	Average
20	2.65	42.97	-13.03	56.00	32.69	0.08	10.20	QP



Test Mode :	Mode 1	Temperature :	24~25°C
Test Engineer :	Henry Chen	Relative Humidity :	53~54%
Test Voltage :	120Vac / 60Hz	Phase :	Neutral
Function Type :	GSM850 Idle + Bluetooth Link + WLAN Link + USB Cable (Charging from Adapter)		

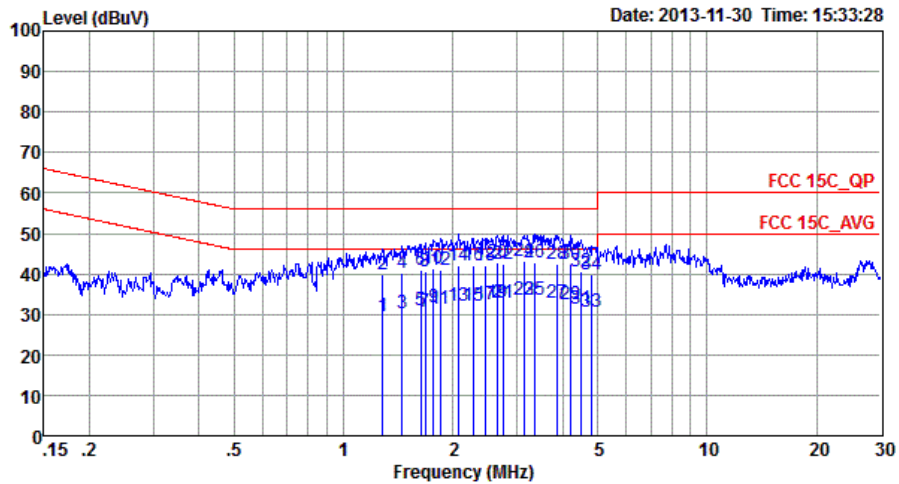

Site : C001-SZ  
 Condition: FCC 15C\_QP LISN\_N\_20130328 NEUTRAL

	Freq	Level	Over Limit	Limit Line	Read Level	LISN Factor	Cable Loss	Remark
	MHz	dBuV	dB	dBuV	dBuV	dB	dB	
21	2.75	32.98	-13.02	46.00	22.70	0.08	10.20	Average
22	2.75	42.58	-13.42	56.00	32.30	0.08	10.20	QP
23	3.14	33.59	-12.41	46.00	23.30	0.08	10.21	Average
24	3.14	43.29	-12.71	56.00	33.00	0.08	10.21	QP
25 *	3.36	33.70	-12.30	46.00	23.40	0.09	10.21	Average
26	3.36	42.90	-13.10	56.00	32.60	0.09	10.21	QP
27	3.88	32.91	-13.09	46.00	22.59	0.10	10.22	Average
28	3.88	42.41	-13.59	56.00	32.09	0.10	10.22	QP
29	4.22	32.33	-13.67	46.00	22.01	0.10	10.22	Average
30	4.22	42.33	-13.67	56.00	32.01	0.10	10.22	QP
31	4.50	31.43	-14.57	46.00	21.10	0.10	10.23	Average
32	4.50	40.73	-15.27	56.00	30.40	0.10	10.23	QP
33	4.82	30.54	-15.46	46.00	20.19	0.11	10.24	Average
34	4.82	39.74	-16.26	56.00	29.39	0.11	10.24	QP



## **3.7 Antenna Requirements**

### **3.7.1 Standard Applicable**

If directional gain of transmitting antennas is greater than 6dBi, the power shall be reduced by the same level in dB comparing to gain minus 6dBi. The use of a permanently attached antenna or of an antenna that uses a unique coupling to the intentional radiator shall be considered sufficient to comply with the FCC rule.

### **3.7.2 Antenna Anti-Replacement Construction**

An embedded-in antenna design is used.

### **3.7.3 Antenna Gain**

The antenna peak gain of EUT is less than 6 dBi. Therefore, it is not necessary to reduce maximum peak output power limit.

## 4 List of Measuring Equipment

Instrument	Manufacturer	Model No.	Serial No.	Characteristics	Calibration Date	Test Date	Due Date	Remark
Spectrum Analyzer	R&S	FSP30	101400	9kHz~30GHz	Mar. 28, 2013	Dec. 16, 2013	Mar. 27, 2014	Conducted (TH01-SZ)
Power Meter	Anritsu	ML2495A	1218010	N/A	Mar. 28, 2013	Dec. 16, 2013	Mar. 27, 2014	Conducted (TH01-SZ)
Power Sensor	Anritsu	MA2411B	1207253	N/A	Mar. 28, 2013	Dec. 16, 2013	Mar. 27, 2014	Conducted (TH01-SZ)
Spectrum Analyzer	Agilent Technologies	N9038A	MY52260185	20Hz~26.5GHz	Apr. 04, 2013	Dec. 07, 2013	Apr. 03, 2014	Radiation (03CH01-SZ)
Loop Antenna	R&S	HFH2-Z2	100354	9kHz-30MHz	May 29, 2013	Dec. 07, 2013	May 28, 2014	Radiation (03CH01-SZ)
Bilog Antenna	SCHAFFNER	CBL6112B	2614	30MHz~2GHz	Dec. 26, 2012	Dec. 07, 2013	Dec. 25, 2013	Radiation (03CH01-SZ)
Double Ridge Horn Antenna	ETS Lindgren	3117	00119436	1GHz~18GHz	Oct. 26, 2013	Dec. 07, 2013	Oct. 25, 2014	Radiation (03CH01-SZ)
SHF-EHF-Horn	Schwarzbeck	BBHA9170	BBHA9170249	14GHz~40GHz	Nov. 22, 2013	Dec. 07, 2013	Nov. 21, 2014	Radiation (03CH01-SZ)
Amplifier	ADVANTEST	BB525C	E9007003	9kHz~3000MHz GAIN 30db	Mar. 29, 2013	Dec. 07, 2013	Mar. 28, 2014	Radiation (03CH01-SZ)
Amplifier	Yiai	AV3860B	04030	2GHz~26.5GHz	Mar. 29, 2013	Dec. 07, 2013	Mar. 28, 2014	Radiation (03CH01-SZ)
Turn Table	EM Electronics	EM 1000	N/A	0 ~ 360 degree	N/A	Dec. 07, 2013	N/A	Radiation (03CH01-SZ)
Antenna Mast	EM Electronics	EM 1000	N/A	1 m - 4 m	N/A	Dec. 07, 2013	N/A	Radiation (03CH01-SZ)
ESCIO TEST Receiver	R&S	1142.8007.03	100724	9kHz~3GHz	Mar. 28, 2013	Nov. 30, 2013	Mar. 27, 2014	Conduction (CO01-SZ)
AC LISN	EMCO	3816/2SH	00103912	9kHz~30MHz	Mar. 28, 2013	Nov. 30, 2013	Mar. 27, 2014	Conduction (CO01-SZ)
AC LISN (for auxiliary equipment)	EMCO	3816/2SH	00103892	9kHz~30MHz	Mar. 28, 2013	Nov. 30, 2013	Mar. 27, 2014	Conduction (CO01-SZ)
AC Power Source	Chroma	61602	616020000891	N/A	Nov. 19, 2013	Nov. 30, 2013	Nov. 18, 2014	Conduction (CO01-SZ)



## 5 Uncertainty of Evaluation

### Uncertainty of Conducted Emission Measurement (150 kHz ~ 30 MHz)

Measuring Uncertainty for a Level of Confidence of 95% ( $U = 2Uc(y)$ )	2.26
---	------

### Uncertainty of Radiated Emission Measurement (30 MHz ~ 1000 MHz)

Measuring Uncertainty for a Level of Confidence of 95% ( $U = 2Uc(y)$ )	3.90
---	------