



PCTEST ENGINEERING LABORATORY, INC.

6660-B Dobbin Road, Columbia, MD 21045 USA
Tel. +1.410.290.6652 / Fax +1.410.290.6554
http://www.pctestlab.com



SAR COMPLIANCE EVALUATION REPORT

Applicant Name:
Samsung Electronics, Co. Ltd.
18600 Broadwick St.
Rancho Dominguez, CA 90220
United States

Date of Testing:
11/29/10 - 12/02/10
Test Site/Location:
PCTEST Lab, Columbia, MD, USA
Test Report Serial No.:
0Y1011261913.A3L

FCC ID: A3LGTS7230L

APPLICANT: SAMSUNG ELECTRONICS, CO. LTD.

EUT Type: 850/1900 GSM/GPRS/WCDMA/HSDPA Phone with EDGE Rx, Bluetooth and WLAN
Application Type: Certification
FCC Rule Part(s): CFR §2.1093; FCC/OET Bulletin 65 Supplement C [June 2001]
FCC Classification: Licensed Transmitter Held to Ear (PCE)
Digital Transmission System (DTS)
Model(s): GT-S7230L
Tx Frequency: 824.20 - 848.80 MHz (GSM 850) / 1850.20 - 1909.80 MHz (GSM 1900)
826.40 - 846.60 MHz (UMTS V) / 1852.4 - 1907.6 MHz (UMTS II)
2412 - 2462 MHz (WLAN)
Conducted Power: 32.06 dBm GSM 850 / 29.48 dBm GSM 1900
22.72 dBm UMTS V / 22.68 dBm UMTS II
17.13 dBm 2.4 GHz WLAN
Max. SAR Measurement: 0.43 W/kg GSM 850 Head SAR / 0.49 W/kg GSM 850 Body SAR
0.89 W/kg GSM 1900 Head SAR / 0.56 W/kg GSM 1900 Body SAR
0.26 W/kg UMTS V Head SAR / 0.19 W/kg UMTS V Body SAR
1.06 W/kg UMTS II Head SAR / 0.45 W/kg UMTS II Body SAR
0.56 W/kg 2.4 GHz WLAN Head SAR / 0.14 W/kg 2.4 GHz WLAN Body SAR
Test Device Serial No.: Pre-Production [S/N: FH 254 B]

This wireless portable device has been shown to be capable of compliance for localized specific absorption rate (SAR) for uncontrolled environment/general population exposure limits specified in ANSI/IEEE C95.1-1992 and has been tested in accordance with the measurement procedures specified in FCC/OET Bulletin 65 Supplement C (2001), IEEE 1528-2003 and in applicable Industry Canada Radio Standards Specifications (RSS); for North American frequency bands only.

I attest to the accuracy of data. All measurements reported herein were performed by me or were made under my supervision and are correct to the best of my knowledge and belief. I assume full responsibility for the completeness of these measurements and vouch for the qualifications of all persons taking them. Test results reported herein relate only to the item(s) tested.

PCTEST certifies that no party to this application has been subject to a denial of Federal benefits that includes FCC benefits pursuant to Section 5301 of the Anti-Drug Abuse Act of 1988, 21 U.S.C. 862.



Randy Ortanez
President



FCC ID: A3LGTS7230L		SAR COMPLIANCE REPORT		Reviewed by: Quality Manager
Filename: 0Y1011261913.A3L	Test Dates: 11/29/10 - 12/02/10	EUT Type: 850/1900 GSM/GPRS/WCDMA/HSDPA Phone with EDGE Rx,Bluetooth and WLAN		Page 1 of 41

TABLE OF CONTENTS

1	INTRODUCTION	3
2	TEST SITE LOCATION	4
3	SAR MEASUREMENT SETUP	5
4	DASY E-FIELD PROBE SYSTEM	7
5	PROBE CALIBRATION PROCESS	8
6	PHANTOM AND EQUIVALENT TISSUES.....	9
7	DOSIMETRIC ASSESSMENT & PHANTOM SPECS.....	10
8	DEFINITION OF REFERENCE POINTS	11
9	TEST CONFIGURATION POSITIONS	12
10	RF EXPOSURE LIMITS	15
11	FCC 3G MEASUREMENT PROCEDURES.....	16
12	SAR TESTING WITH IEEE 802.11 TRANSMITTERS.....	18
13	SYSTEM VERIFICATION.....	21
14	SAR DATA SUMMARY	24
15	FCC MULTI-TX AND ANTENNA SAR CONSIDERATIONS.....	31
16	EQUIPMENT LIST.....	33
17	MEASUREMENT UNCERTAINTIES	34
18	CONCLUSION.....	35
19	REFERENCES	36
20	SAR TEST SETUP PHOTOGRAPHS.....	38

FCC ID: A3LGTS7230L		SAR COMPLIANCE REPORT		Reviewed by: Quality Manager
Filename: 0Y1011261913.A3L	Test Dates: 11/29/10 - 12/02/10	EUT Type: 850/1900 GSM/GPRS/WCDMA/HSDPA Phone with EDGE Rx,Bluetooth and WLAN		Page 2 of 41

1 INTRODUCTION

The FCC has adopted the guidelines for evaluating the environmental effects of radio frequency (RF) radiation in ET Docket 93-62 on Aug. 6, 1996 to protect the public and workers from the potential hazards of RF emissions due to FCC-regulated portable devices. [1]

The safety limits used for the environmental evaluation measurements are based on the criteria published by the American National Standards Institute (ANSI) for localized specific absorption rate (SAR) in IEEE/ANSI C95.1-1992 Standard for Safety Levels with Respect to Human Exposure to Radio Frequency Electromagnetic Fields, 3 kHz to 300 GHz [3] and Health Canada RF Exposure Guidelines Safety Code 6 [24]. The measurement procedure described in IEEE/ANSI C95.3-2002 Recommended Practice for the Measurement of Potentially Hazardous Electromagnetic Fields - RF and Microwave [4] is used for guidance in measuring the Specific Absorption Rate (SAR) due to the RF radiation exposure from the Equipment Under Test (EUT). These criteria for SAR evaluation are similar to those recommended by the International Committee for Non-Ionizing Radiation Protection (ICNIRP) in Biological Effects and Exposure Criteria for Radiofrequency Electromagnetic Fields,” Report No. Vol 74. SAR is a measure of the rate of energy absorption due to exposure to an RF transmitting source. SAR values have been related to threshold levels for potential biological hazards.

1.1 SAR Definition

Specific Absorption Rate is defined as the time derivative (rate) of the incremental energy (dU) absorbed by (dissipated in) an incremental mass (dm) contained in a volume element (dV) of a given density (ρ). It is also defined as the rate of RF energy absorption per unit mass at a point in an absorbing body (see Fig. 1-1).

$$SAR = \frac{d}{dt} \left(\frac{dU}{dm} \right) = \frac{d}{dt} \left(\frac{dU}{\rho dV} \right)$$

Figure 1-1
SAR Mathematical Equation

SAR is expressed in units of Watts per Kilogram (W/kg).

$$SAR = \frac{\sigma \cdot E^2}{\rho}$$

where:

- σ = conductivity of the tissue-simulating material (S/m)
- ρ = mass density of the tissue-simulating material (kg/m^3)
- E = Total RMS electric field strength (V/m)

NOTE: The primary factors that control rate of energy absorption were found to be the wavelength of the incident field in relation to the dimensions and geometry of the irradiated organism, the orientation of the organism in relation to the polarity of field vectors, the presence of reflecting surfaces, and whether conductive contact is made by the organism with a ground plane.[6]

FCC ID: A3LGT57230L	 PCTEST ENGINEERING LABORATORY, INC.	SAR COMPLIANCE REPORT		Reviewed by: Quality Manager
Filename: OY1011261913.A3L	Test Dates: 11/29/10 - 12/02/10	EUT Type: 850/1900 GSM/GPRS/WCDMA/HSDPA Phone with EDGE Rx,Bluetooth and WLAN		Page 3 of 41

2 TEST SITE LOCATION

2.1 INTRODUCTION

The map at the right shows the location of the PCTEST LABORATORY in Columbia, Maryland. It is in proximity to the FCC Laboratory, the Baltimore-Washington International (BWI) airport, the city of Baltimore and Washington, DC.

These measurement tests were conducted at the PCTEST Engineering Laboratory, Inc. facility in New Concept Business Park, Guilford Industrial Park, Columbia, Maryland. The site address is 6660-B Dobbin Road, Columbia, MD 21045. The test site is one of the highest points in the Columbia area with an elevation of 390 feet above mean sea level. The site coordinates are 39° 11'15" N latitude and 76° 49' 38" W longitude. The facility is 1.5 miles north of the FCC laboratory, and the ambient signal and ambient signal strength are approximately equal to those of the FCC laboratory. There are no FM or TV transmitters within 15 miles of the site. The detailed description of the measurement facility was found to be in compliance with the requirements of § 2.948 according to ANSI C63.4 on January 27, 2006 and Industry Canada.

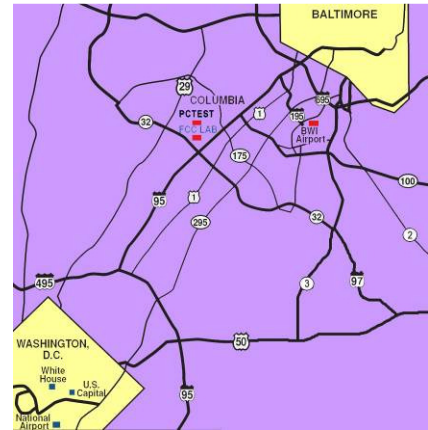

Figure 2-1

Map of the Greater Baltimore and Metropolitan Washington, D.C. area

2.2 Test Facility / Accreditations:

Measurements were performed at an independent accredited PCTEST Engineering Lab located in Columbia, MD 21045, U.S.A.



- PCTEST Lab is accredited to ISO 17025-2005 by the American Association for Laboratory Accreditation (A2LA) in Specific Absorption Rate (SAR) testing, Hearing-Aid Compatibility (HAC), Battery Safety, CTIA Test Plans, and wireless testing for FCC and Industry Canada Rules.
- PCTEST Lab is accredited to ISO 17025 by U.S. National Institute of Standards and Technology (NIST) under the National Voluntary Laboratory Accreditation Program (NVLAP Lab code: 100431-0) in EMC, FCC and Telecommunications.
- PCTEST facility is an FCC registered (PCTEST Reg. No. 90864) test facility with the site description report on file and has met all the requirements specified in Section 2.948 of the FCC Rules and Industry Canada (IC-2451).
- PCTEST Lab is a recognized U.S. Conformity Assessment Body (CAB) in EMC and R&TTE (n.b. 0982) under the U.S.-EU Mutual Recognition Agreement (MRA).
- PCTEST TCB is a Telecommunication Certification Body (TCB) accredited to ISO/IEC Guide 65 by the American National Standards Institute (ANSI) in all scopes of FCC Rules and all Industry Canada Standards (RSS).
- PCTEST facility is an IC registered (IC-2451) test laboratory with the site description on file at Industry Canada.
- PCTEST is a CTIA Authorized Test Laboratory (CATL) for AMPS and CDMA, and EvDO mobile phones.
- PCTEST is a CTIA Authorized Test Laboratory (CATL) for Over-the-Air (OTA) Antenna Performance testing for AMPS, CDMA, GSM, GPRS, EGPRS, UMTS (W-CDMA), CDMA 1xEVDO Data, CDMA 1xRTT Data

FCC ID: A3LGTS7230L		SAR COMPLIANCE REPORT		Reviewed by: Quality Manager
Filename: OY1011261913.A3L	Test Dates: 11/29/10 - 12/02/10	EUT Type: 850/1900 GSM/GPRS/WCDMA/HSDPA Phone with EDGE Rx,Bluetooth and WLAN		Page 4 of 41

3 SAR MEASUREMENT SETUP

3.1 Robotic System

Measurements are performed using the DASY4 automated dosimetric assessment system. The DASY4 is made by Schmid & Partner Engineering AG (SPEAG) in Zurich, Switzerland and consists of a high precision robotics system (Staubli), robot controller, desktop computer, near-field probe, probe alignment sensor, and the SAM phantom containing the head or body equivalent material. The robot is a six-axis industrial robot, performing precise movements to position the probe to the location (points) of maximum electromagnetic field (EMF) (see Figure 3-1).

3.2 System Hardware

A cell controller system contains the power supply, robot controller, teach pendant (Joystick), and a remote control used to drive the robot motors. The PC consists of the SAR Measurement Software DASY4, A/D interface card, monitor, mouse, and keyboard. The Staubli Robot is connected to the cell controller to allow software manipulation of the robot. A data acquisition electronic (DAE) circuit that performs the signal amplification, signal multiplexing, A/D conversion, offset measurements, mechanical surface detection, collision detection, etc. is connected to the Electro-optical coupler (EOC). The EOC performs the conversion from the optical into digital electric signal from the DAE and transfers data to the PC card.

3.3 System Electronics

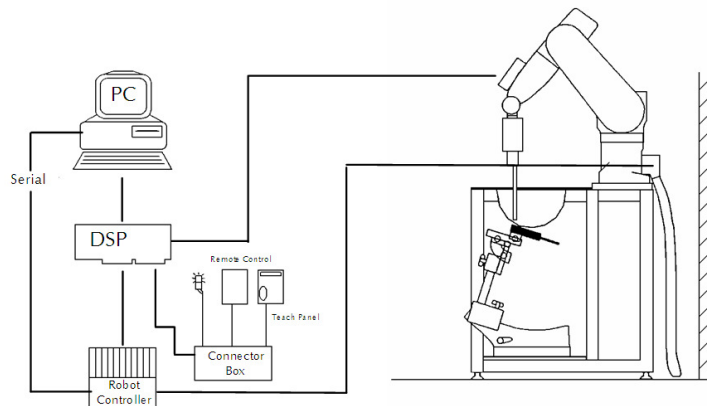



Figure 3-1
SAR Measurement System Setup

The DAE consists of a highly sensitive electrometer-grade auto-zeroing preamplifier, a channel and gain-switching multiplexer, a fast 16 bit AD-converter and a command decoder and control logic unit. Transmission to the PC-card is accomplished through an optical downlink for data and status information and an optical uplink for commands and clock lines. The mechanical probe mounting device includes two different sensor systems for frontal and sidewise probe contacts. They are also used for mechanical surface detection and probe collision detection. The robot uses its own controller with a built in VME-bus computer.

FCC ID: A3LGTS7230L	 PCTEST ENGINEERING LABORATORY, INC.	SAR COMPLIANCE REPORT	 SAMSUNG	Reviewed by: Quality Manager
Filename: OY1011261913.A3L	Test Dates: 11/29/10 - 12/02/10	EUT Type: 850/1900 GSM/GPRS/WCDMA/HSDPA Phone with EDGE Rx,Bluetooth and WLAN		Page 5 of 41

3.4 Automated Test System Specifications

Test Software: SPEAG DASY4 version 4.7 Measurement Software
 Robot: Stäubli Unimation Corp. Robot RX60L
 Repeatability: 0.02 mm
 No. of Axes: 6

Data Acquisition Electronic System (DAE)

Data Converter

Features: Signal Amplifier, multiplexer, A/D converter & control logic
 Software: SEMCAD software
 Connecting Lines: Optical Downlink for data and status info
 Optical upload for commands and clock

PC Interface Card



Function: Link to DAE
 16-bit A/D converter for surface detection system
 Two Serial & Ethernet link to robotics
 Direct emergency stop output for robot

Phantom

Type: SAM Twin Phantom (V4.0)
 Shell Material: Composite
 Thickness: 2.0 ± 0.2 mm



**Figure 3-2
SAR Measurement System**

FCC ID: A3LGTS7230L		SAR COMPLIANCE REPORT		Reviewed by: Quality Manager
Filename: 0Y1011261913.A3L	Test Dates: 11/29/10 - 12/02/10	EUT Type: 850/1900 GSM/GPRS/WCDMA/HSDPA Phone with EDGE Rx,Bluetooth and WLAN		Page 6 of 41

4.1 Probe Measurement System



**Figure 4-1
SAR System**

The SAR measurements were conducted with the dosimetric probe designed in the classical triangular configuration (see Figure 4-3) and optimized for dosimetric evaluation [9]. The probe is constructed using the thick film technique; with printed resistive lines on ceramic substrates. The probe is equipped with an optical multi-fiber line ending at the front of the probe tip. It is connected to the EOC box on the robot arm and provides an automatic detection of the phantom surface. Half of the fibers are connected to a pulsed infrared transmitter, the other half to a synchronized receiver. As the probe approaches the surface, the reflection from the surface produces a coupling from the transmitting to the receiving fibers. This reflection increases first during the approach, reaches maximum and then decreases. If the probe is flatly touching the surface, the coupling is zero. The distance of the coupling maximum to the surface is independent of the surface reflectivity and largely independent of the surface to probe angle. The DASY4 software reads the reflection during a software approach and looks for the

maximum using a 2nd order curve fitting (see Figure 5-1). The approach is stopped at reaching the maximum.

4.2 Probe Specifications

Model(s):	ES3DV2, ES3DV3, EX3DV4
Frequency Range:	10 MHz – 6.0 GHz (EX3DV4) 10 MHz – 4 GHz (ES3DV3)
Calibration:	In head and body simulating tissue at Frequencies from 300 up to 6000MHz
Linearity:	± 0.2 dB (30 MHz to 6 GHz) for EX3DV4 ± 0.2 dB (30 MHz to 4 GHz) for ES3DV3
Dynamic Range:	10 mW/kg – 100 W/kg
Probe Length:	330 mm
Probe Tip Length:	20 mm
Probe Tip Length:	20 mm
Body Diameter:	12 mm
Tip Diameter:	2.5 mm (3.9mm for ES3DV3)
Tip-Center:	1 mm (2.0 mm for ES3DV3)
Application:	SAR Dosimetry Testing Compliance tests of mobile phones Dosimetry in strong gradient fields



**Figure 4-2
Near-Field Probe**



**Figure 4-3
Triangular Probe
Configuration**

FCC ID: A3LGT57230L	 PCTEST ENGINEERING LABORATORY, INC.	SAR COMPLIANCE REPORT	 SAMSUNG	Reviewed by: Quality Manager
Filename: OY1011261913.A3L	Test Dates: 11/29/10 - 12/02/10	EUT Type: 850/1900 GSM/GPRS/WCDMA/HSDPA Phone with EDGE Rx,Bluetooth and WLAN		Page 7 of 41

5

PROBE CALIBRATION PROCESS

5.1 Dosimetric Assessment Procedure

Each E-Probe/Probe Amplifier combination has unique calibration parameters. A TEM cell calibration procedure is conducted to determine the proper amplifier settings to enter in the probe parameters. The amplifier settings are determined for a given frequency by subjecting the probe to a known E-field density (1 mW/cm²) using an RF Signal generator, TEM cell, and RF Power Meter.

5.2 Free Space Assessment

The free space E-field from amplified probe outputs is determined in a test chamber. This calibration can be performed in a TEM cell if the frequency is below 1 GHz and in a waveguide or other methodologies above 1 GHz for free space. For the free space calibration, the probe is placed in the volumetric center of the cavity and at the proper orientation with the field. The probe is rotated 360 degrees until the three channels show the maximum reading. The power density readings equates to 1 mW/cm².

5.3 Temperature Assessment

E-field temperature correlation calibration is performed in a flat phantom filled with the appropriate simulated head tissue. The E-field in the medium correlates with the temperature rise in the dielectric medium. For temperature correlation calibration a RF transparent thermistor-based temperature probe is used in conjunction with the E-field probe.

$$SAR = C \frac{\Delta T}{\Delta t}$$

where:

- Δt = exposure time (30 seconds),
- C = heat capacity of tissue (brain or muscle),
- ΔT = temperature increase due to RF exposure.

$$SAR = \frac{|E|^2 \cdot \sigma}{\rho}$$

where:

- σ = simulated tissue conductivity,
- ρ = Tissue density (1.25 g/cm³ for brain tissue)

SAR is proportional to $\Delta T/\Delta t$, the initial rate of tissue heating, before thermal diffusion takes place. The electric field in the simulated tissue can be used to estimate SAR by equating the thermally derived SAR to that with the E- field component.

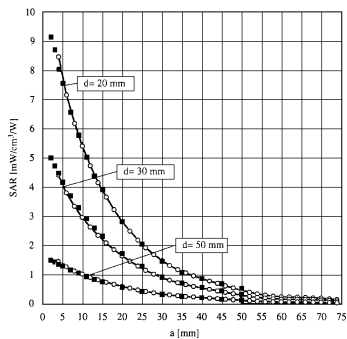

Figure 5-1 E-Field and Temperature measurements at 900MHz [9]

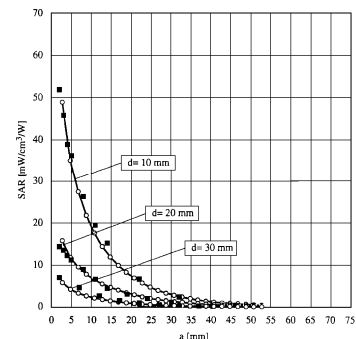



Figure 5-2 E-Field and temperature measurements at 1.9GHz [9]

FCC ID: A3LGTS7230L		SAR COMPLIANCE REPORT		Reviewed by: Quality Manager
Filename: OY1011261913.A3L	Test Dates: 11/29/10 - 12/02/10	EUT Type: 850/1900 GSM/GPRS/WCDMA/HSDPA Phone with EDGE Rx,Bluetooth and WLAN		Page 8 of 41

6

PHANTOM AND EQUIVALENT TISSUES

6.1 SAM Phantoms



**Figure 6-1
SAM Phantoms**

The SAM Twin Phantom V4.0 is constructed of a fiberglass shell integrated in a table. The shape of the shell is based on data from an anatomical study designed to represent the 90th percentile of the population [12][13]. The phantom enables the dosimetric evaluation of SAR for both left and right handed handset usage, as well as body-worn usage using the flat phantom region. Reference markings on the Phantom allow the complete setup of all predefined phantom positions and measurement grids by manually teaching three points in the robot. The shell phantom has a 2mm shell thickness (except the ear region where shell thickness increases to 6 mm).

6.2 Tissue Simulating Mixture Characterization

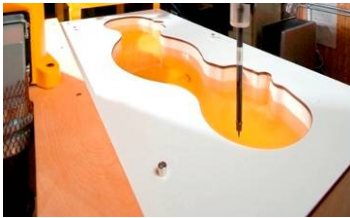



**Figure 6-2
SAM Phantom with
Simulating Tissue**

The mixture is characterized to obtain proper dielectric constant (permittivity) and conductivity of the tissue of interest. The tissue dielectric parameters recommended in IEEE 1528 and IEC 62209 have been used as targets for the compositions, and are to match within 5%, per the FCC recommendations.

Table 6-1
Composition of the Tissue Equivalent Matter

Frequency (MHz)	835	835	1900	1900	2450	2450
Tissue	Head	Body	Head	Body	Head	Body
Ingredients (% by weight)						
Bactericide	0.1	0.1				
DGBE			44.92	29.44	7.99	26.7
HEC	1	1				
NaCl	1.45	0.94	0.18	0.39	0.16	0.1
Sucrose	57	44.9				
Triton X-100					19.97	
Water	40.45	53.06	54.9	70.16	71.88	73.2

FCC ID: A3LGTS7230L		SAR COMPLIANCE REPORT		Reviewed by: Quality Manager
Filename: OY1011261913.A3L	Test Dates: 11/29/10 - 12/02/10	EUT Type: 850/1900 GSM/GPRS/WCDMA/HSDPA Phone with EDGE Rx,Bluetooth and WLAN		Page 9 of 41

7.1 Measurement Procedure

The evaluation was performed using the following procedure:

1. The SAR distribution at the exposed side of the head was measured at a distance no greater than 5.0 mm from the inner surface of the shell. The area covered the entire dimension of the head and the horizontal grid spacing was 15mm x 15mm.
2. The point SAR measurement was taken at the maximum SAR region determined from Step 1 to enable the monitoring of SAR fluctuations/drifts during testing the 1 gram cube. This fixed point was measured and used as a reference value.
3. Based on the area scan data, the area of the maximum absorption was determined by spline interpolation. Around this point, a volume of 32mm x 32mm x 30mm (fine resolution volume scan, zoom scan) was assessed by measuring 5 x 5 x 7 points. On this basis of this data set, the spatial peak SAR value was evaluated with the following procedure (see references or the DASY manual for more details):
 - a. The data was extrapolated to the surface of the outer-shell of the phantom. The combined distance extrapolated was the combined distance from the center of the dipoles 2.7mm away from the tip of the probe housing plus the 1.2 mm distance between the surface and the lowest measuring point. The extrapolation was based on a least-squares algorithm. A polynomial of the fourth order was calculated through the points in the z-axis (normal to the phantom shell).
 - b. After the maximum interpolated values were calculated between the points in the cube, the SAR was averaged over the spatial volume (1g or 10g) using a 3D-Spline interpolation algorithm. The 3D-spline is composed of three one-dimensional splines with the "Not a knot" condition (in x, y, and z directions). The volume was then integrated with the trapezoidal algorithm. One thousand points (10 x 10 x 10) were obtained through interpolation, in order to calculate the averaged SAR.
 - c. All neighboring volumes were evaluated until no neighboring volume with a higher average value was found.
4. The SAR reference value, at the same location as step 2, was re-measured after the zoom scan was complete. If the value deviated by more than 5%, the evaluation was repeated.
5. For 5 GHz testing finer resolution zoom scans were performed as specified by FCC SAR Measurement Requirements for 3 – 6 GHz, KDB pub 865664. The 5 GHz zoom scan requires a minimum volume of 24mm x 24mm x 20mm and 7 x 7 x 11 points.

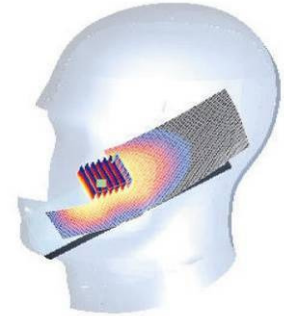



Figure 7-1
Sample SAR Area Scan

7.2 Specific Anthropomorphic Mannequin (SAM) Specifications

The phantom for handset SAR assessment testing is a low-loss dielectric shell, with shape and dimensions derived from the anthropometric data of the 90th percentile adult male head dimensions as tabulated by the US Army. The SAM Twin Phantom shell is bisected along the mid-sagittal plane into right and left halves (see Figure 7-2). The perimeter sidewalls of each phantom halves are extended to allow filling with liquid to a depth that is sufficient to minimize reflections from the upper surface. The liquid depth is maintained at a minimum depth of 15 cm.



Figure 7-2
SAM Twin Phantom Shell

FCC ID: A3LGT57230L	 PCTEST ENGINEERING LABORATORY, INC.	SAR COMPLIANCE REPORT		Reviewed by: Quality Manager
Filename: OY1011261913.A3L	Test Dates: 11/29/10 - 12/02/10	EUT Type: 850/1900 GSM/GPRS/WCDMA/HSDPA Phone with EDGE Rx,Bluetooth and WLAN		Page 10 of 41

8.1 EAR REFERENCE POINT

Figure 8-1 shows the front, back and side views of the SAM Twin Phantom. The point “M” is the reference point for the center of the mouth, “LE” is the left ear reference point (ERP), and “RE” is the right ERP. The ERP is 15mm posterior to the entrance to the ear canal (EEC) along the B-M line (Back-Mouth), as shown in Figure 8-1. The plane passing through the two ear canals and M is defined as the Reference Plane. The line N-F (Neck-Front) is perpendicular to the reference plane and passing through the RE (or LE) is called the Reference Pivoting Line (see Figure 8-2

Front, back and side view of SAM Twin Phantom Figure 8-2). Line B-M is perpendicular to the N-F line. Both N-F and B-M lines are marked on the external phantom shell to facilitate handset positioning [5].

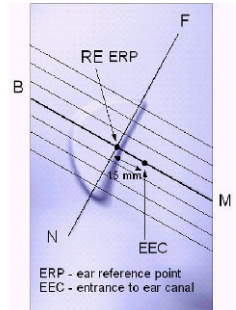

Figure 8-1
Close-Up Side view
of ERP

8.2 HANDSET REFERENCE POINTS

Two imaginary lines on the handset were established: the vertical centerline and the horizontal line. The test device was placed in a normal operating position with the “test device reference point” located along the “vertical centerline” on the front of the device aligned to the “ear reference point” (See Figure 8-3). The “test device reference point” was then located at the same level as the center of the ear reference point. The test device was positioned so that the “vertical centerline” was bisecting the front surface of the handset at its top and bottom edges, positioning the “ear reference point” on the outer surface of the both the left and right head phantoms on the ear reference point.

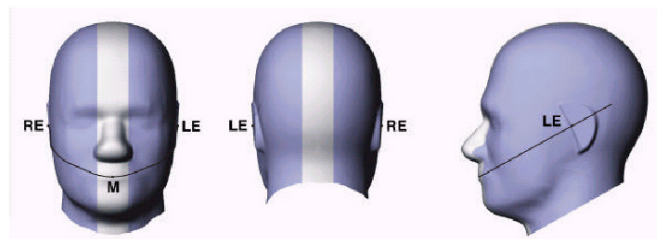

Figure 8-2
Front, back and side view of SAM Twin Phantom

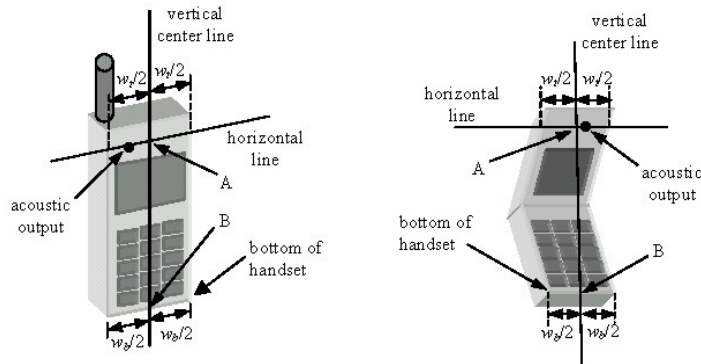



Figure 8-3
Handset Vertical Center & Horizontal Line Reference Points

FCC ID: A3LGT57230L	 PCTEST ENGINEERING LABORATORY, INC.	SAR COMPLIANCE REPORT	 SAMSUNG	Reviewed by: Quality Manager
Filename: OY1011261913.A3L	Test Dates: 11/29/10 - 12/02/10	EUT Type: 850/1900 GSM/GPRS/WCDMA/HSDPA Phone with EDGE Rx,Bluetooth and WLAN		Page 11 of 41

9

TEST CONFIGURATION POSITIONS

9.1 Device Holder

The DASY device holder has been made out of low-loss POM material having the following dielectric parameters: relative permittivity $\epsilon = 3$ and loss tangent $\delta = 0.02$.

9.2 Positioning for Cheek/Touch

1. The test device was positioned with the handset close to the surface of the phantom such that point A is on the (virtual) extension of the line passing through points RE and LE on the phantom (see Figure 9-1), such that the plane defined by the vertical center line and the horizontal line of the phone is approximately parallel to the sagittal plane of the phantom.

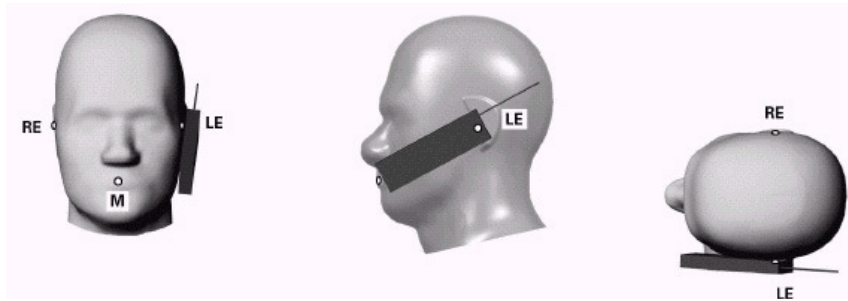



Figure 9-1 Front, Side and Top View of Cheek/Touch Position

2. The handset was translated towards the phantom along the line passing through RE & LE until the handset touches the ear.
3. While maintaining the handset in this plane, the handset was rotated around the LE-RE line until the vertical centerline was in the plane normal to MB-NF including the line MB (reference plane).
4. The phone was then rotated around the vertical centerline until the phone (horizontal line) was symmetrical with respect to the line NF.
5. While maintaining the vertical centerline in the reference plane, keeping point A on the line passing through RE and LE, and maintaining the phone contact with the ear, the handset was rotated about the line NF until any point on the handset made contact with a phantom point below the ear (cheek) (See Figure 9-2).

9.3 Positioning for Ear / 15° Tilt

With the test device aligned in the “Cheek/Touch Position”:

1. While maintaining the orientation of the phone, the phone was retracted parallel to the reference plane far enough to enable a rotation of the phone by 15 degree.
2. The phone was then rotated around the horizontal line by 15 degree.
3. While maintaining the orientation of the phone, the phone was moved parallel to the reference plane until any part of the phone touches the head. (In this position, point A was located on the line RE-LE). The tilted position is obtained when the contact is on the pinna. If the contact was at any location other than the pinna, the angle of the phone would then be reduced. The tilted position was obtained when any part of the phone was in contact of the ear as well as a second part of the phone was in contact with the head (see Figure 9-2).

FCC ID: A3LGTS7230L		SAR COMPLIANCE REPORT		Reviewed by: Quality Manager
Filename: OY1011261913.A3L	Test Dates: 11/29/10 - 12/02/10	EUT Type: 850/1900 GSM/GPRS/WCDMA/HSDPA Phone with EDGE Rx, Bluetooth and WLAN		Page 12 of 41

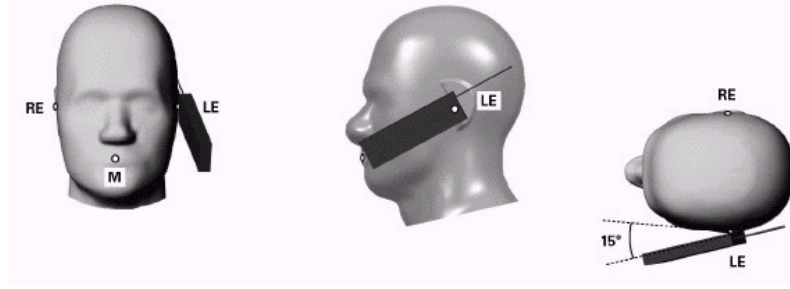

Figure 9-2 Front, Side and Top View of Ear/15° Tilt Position

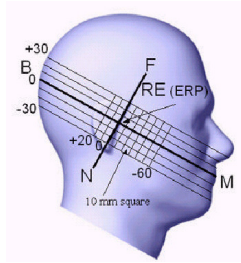

Figure 9-3 Side view w/ relevant markings



Figure 9-4 Body SAR Sample Photo (Not Actual EUT)

9.4 SAR Evaluations near the Mouth/Jaw Regions of the SAM Phantom

Antennas located near the bottom of a phone may require SAR measurements around the mouth and jaw regions of the SAM head phantom. This typically applies to clam-shell style phones that are generally longer in the unfolded normal use positions or to certain older style long rectangular phones. It has been known for some time that there are SAR measurement difficulties in these regions of the SAM phantom. SAR probes are calibrated in tissue equivalent liquids with sufficient separation between the probe sensors and nearby physical boundaries to ensure scattering does not affect probe calibration. When the probe tip is moved into tight regions with multiple boundaries surrounding its sensors, probe calibration and measurement accuracy can become questionable. In addition, these measurement locations often require a probe to be tilted at steep angles, where it may no longer comply with calibration requirements and measurement protocols, or satisfy the required measurement uncertainty. In some situations it is not feasible to tilt the probe or rotate the phantom, as suggested by measurement standards, to conduct these measurements.

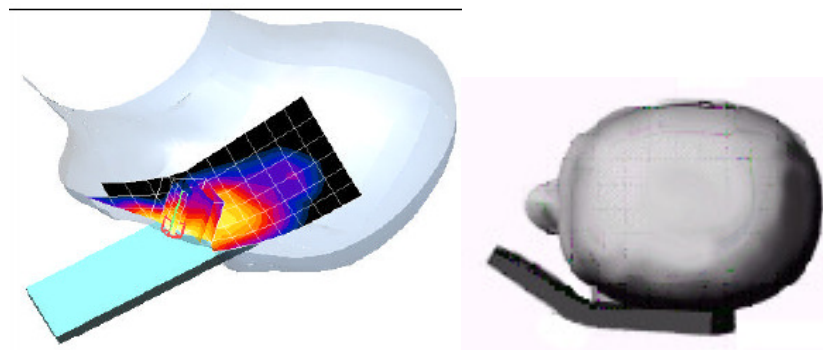



Figure 9-5 SAR Scans near the Jaw/Mouth

In order to ensure there is sufficient conservativeness for ensuring compliance until practical solutions are available, additional measurement considerations are necessary to address these technical difficulties. When measurements are required near the mouth, nose, jaw or similar tight regions of the SAM phantom,

FCC ID: A3LGTS7230L	 PCTEST ENGINEERING LABORATORY, INC.	SAR COMPLIANCE REPORT	 SAMSUNG	Reviewed by: Quality Manager
Filename: OY1011261913.A3L	Test Dates: 11/29/10 - 12/02/10	EUT Type: 850/1900 GSM/GPRS/WCDMA/HSDPA Phone with EDGE Rx,Bluetooth and WLAN		Page 13 of 41

area or zoom scans are often unable to fully enclose the peak SAR location as required by IEEE 1528 and Supplement C, due to probe orientation and positioning difficulties. Even when limited measurements are possible, the test results could be questionable due to probe calibration and measurement uncertainty issues. Under these circumstances, the following procedures apply, adopted from the FCC guidance on SAR handsets document publication 648474. The SAR required in these regions of SAM should be measured using a flat phantom. **Rectangular shaped phones** should be positioned with its bottom edge positioned from the flat phantom with the same distance provided by the cheek touching position using SAM. The ear reference point (ERP, as defined for SAM) of the phone should be positioned ½ cm from the flat phantom shell. **Clam-shell phones** should be positioned with the hinge against a smooth edge of the flat phantom where the upper half of the phone is unfolded and extended beyond the phantom side wall. The lower half of the phone is secured in the test device holder at a fixed distance below the flat phantom determined by the minimum separation along the lower edge of the phone in the cheek touching position using SAM. Any case with substantial variation in separation distance along the lower edge of a clam shell is discussed with the FCC for best-to-use methodology.



The flat phantom data should allow test results to be compared uniformly across measurement systems, until suitable solutions are available in measurement standards to address certain probe calibration and positioning issues, due to implementation differences between horizontal and upright SAM configurations. These flat phantom procedures are only applicable for stand-alone SAR evaluation in tight regions of the SAM phantom, where measurement is not feasible or test results can be questionable due to probe calibration and accessibility issues. Details on device positioning and photos showing how separation distances are determined are included in the SAR report Photographs. SAR for other regions of the head must be evaluated using SAM; therefore, a phone with antennas at different locations may require flat and SAM phantom evaluation for the different antennas.

9.5 Body Holster /Belt Clip Configurations

Body-worn operating configurations are tested with the belt-clips and holsters attached to the device and positioned against a flat phantom in a normal use configuration (see Figure 9-4). A device with a headset output is tested with a headset connected to the device.

Accessories for Body-worn operation configurations are divided into two categories: those that do not contain metallic components and those that do contain metallic components. When multiple accessories that do not contain metallic components are supplied with the device, the device is tested with only the accessory that dictates the closest spacing to the body. Then multiple accessories that contain metallic components are tested with the device with each accessory. If multiple accessories share an identical metallic component (i.e. the same metallic belt-clip used with different holsters with no other metallic components) only the accessory that dictates the closest spacing to the body is tested.

Body-worn accessories may not always be supplied or available as options for some devices intended to be authorized for body-worn use. In this case, a test configuration with a separation distance between the back of the device and the flat phantom is used. Test position spacing was documented. Transmitters that are designed to operate in front of a person’s face, as in push-to-talk configurations, are tested for SAR compliance with the front of the device positioned to face the flat phantom in head fluid. For devices that are carried next to the body such as a shoulder, waist or chest-worn transmitters, SAR compliance is tested with the accessories, including headsets and microphones, attached to the device and positioned against a flat phantom in a normal use configuration.

FCC ID: A3LGT57230L		SAR COMPLIANCE REPORT		Reviewed by: Quality Manager
Filename: OY1011261913.A3L	Test Dates: 11/29/10 - 12/02/10	EUT Type: 850/1900 GSM/GPRS/WCDMA/HSDPA Phone with EDGE Rx,Bluetooth and WLAN		Page 14 of 41

10 RF EXPOSURE LIMITS

10.1 Uncontrolled Environment

UNCONTROLLED ENVIRONMENTS are defined as locations where there is the exposure of individuals who have no knowledge or control of their exposure. The general population/uncontrolled exposure limits are applicable to situations in which the general public may be exposed or in which persons who are exposed as a consequence of their employment may not be made fully aware of the potential for exposure or cannot exercise control over their exposure. Members of the general public would come under this category when exposure is not employment-related; for example, in the case of a wireless transmitter that exposes persons in its vicinity.



10.2 Controlled Environment

CONTROLLED ENVIRONMENTS are defined as locations where there is exposure that may be incurred by persons who are aware of the potential for exposure, (i.e. as a result of employment or occupation). In general, occupational/controlled exposure limits are applicable to situations in which persons are exposed as a consequence of their employment, who have been made fully aware of the potential for exposure and can exercise control over their exposure. This exposure category is also applicable when the exposure is of a transient nature due to incidental passage through a location where the exposure levels may be higher than the general population/uncontrolled limits, but the exposed person is fully aware of the potential for exposure and can exercise control over his or her exposure by leaving the area or by some other appropriate means.

Table 10-1
SAR Human Exposure Specified in ANSI/IEEE C95.1-1992 and Health Canada Safety Code 6

HUMAN EXPOSURE LIMITS		
	UNCONTROLLED ENVIRONMENT <i>General Population</i> (W/kg) or (mW/g)	CONTROLLED ENVIRONMENT <i>Occupational</i> (W/kg) or (mW/g)
SPATIAL PEAK SAR Brain	1.6	8.0
SPATIAL AVERAGE SAR Whole Body	0.08	0.4
SPATIAL PEAK SAR Hands, Feet, Ankles, Wrists	4.0	20

1. The Spatial Peak value of the SAR averaged over any 1 gram of tissue (defined as a tissue volume in the shape of a cube) and over the appropriate averaging time.
2. The Spatial Average value of the SAR averaged over the whole body.
3. The Spatial Peak value of the SAR averaged over any 10 grams of tissue (defined as a tissue volume in the shape of a cube) and over the appropriate averaging time.

FCC ID: A3LGT57230L	 PCTEST ENGINEERING LABORATORY, INC.	SAR COMPLIANCE REPORT		Reviewed by: Quality Manager
Filename: OY1011261913.A3L	Test Dates: 11/29/10 - 12/02/10	EUT Type: 850/1900 GSM/GPRS/WCDMA/HSDPA Phone with EDGE Rx,Bluetooth and WLAN		Page 15 of 41

11 FCC 3G MEASUREMENT PROCEDURES

Power measurements were performed using a base station simulator under digital average power.

11.1 Procedures Used to Establish RF Signal for SAR



The device was placed into a simulated call using a base station simulator in a shielded chamber. Such test signals offer a consistent means for testing SAR and are recommended for evaluating SAR [4]. SAR measurements were taken with a fully charged battery. In order to verify that the device was tested and maintained at full power, it was configured with the base station simulator. The SAR measurement software calculates a reference point at the start and end of the test to check for power drifts. If SAR deviations of more than 5% occurred, the tests were repeated.

11.2 RF Conducted Powers

11.2.1 GSM Conducted Powers

		RF Conducted Power Table				
		Voice	GPRS Data			
Band	Channel	GSM [dBm] CS (1 Slot)	GPRS [dBm] 1 Tx Slot	GPRS [dBm] 2 Tx Slot	GPRS [dBm] 3 Tx Slot	GPRS [dBm] 4 Tx Slot
Cellular	128	32.05	32.06	30.49	28.48	26.52
	190	31.87	31.89	30.34	28.35	26.37
	251	31.86	31.87	30.32	28.36	26.39
PCS	512	29.25	29.27	27.73	25.72	23.61
	661	29.42	29.48	27.94	25.92	23.82
	810	28.98	29.01	27.52	25.54	23.48

GSM Class: B
GPRS Multislot class: 12
EDGE Multislot class: Rx only
DTM Multislot class: N/A



FCC ID: A3LGTS7230L		SAR COMPLIANCE REPORT		Reviewed by: Quality Manager
Filename: 0Y1011261913.A3L	Test Dates: 11/29/10 - 12/02/10	EUT Type: 850/1900 GSM/GPRS/WCDMA/HSDPA Phone with EDGE Rx,Bluetooth and WLAN		Page 16 of 41

11.2.2 WCDMA / HSDPA Conducted Powers

UMTS RF Conducted Power Table					
		<i>HSDPA Inactive</i>		<i>HSDPA Active</i>	
Band	Channel	12.2 kbps RMC [dBm]	12.2 kbps AMR [dBm]	12.2 kbps RMC [dBm]	12.2 kbps AMR [dbm]
V (Cellular)	4132	22.33	22.29	22.25	22.27
	4183	22.72	22.57	22.68	22.55
	4233	22.65	22.62	22.59	22.54
II (PCS)	9262	22.63	22.57	22.54	22.49
	9400	22.68	22.65	22.62	22.57
	9538	22.59	22.56	22.53	22.52



Figure 11-1
Power Measurement Setup

FCC ID: A3LGTS7230L		SAR COMPLIANCE REPORT		Reviewed by: Quality Manager
Filename: 0Y1011261913.A3L	Test Dates: 11/29/10 - 12/02/10	EUT Type: 850/1900 GSM/GPRS/WCDMA/HSDPA Phone with EDGE Rx,Bluetooth and WLAN		Page 17 of 41

12 SAR TESTING WITH IEEE 802.11 TRANSMITTERS

Normal network operating configurations are not suitable for measuring the SAR of 802.11 a/b/g transmitters. Unpredictable fluctuations in network traffic and antenna diversity conditions can introduce undesirable variations in SAR results. The SAR for these devices should be measured using chipset based test mode software to ensure the results are consistent and reliable.

12.1 General Device Setup

Chipset based test mode software is hardware dependent and generally varies among manufacturers. The device operating parameters established in test mode for SAR measurements must be identical to those programmed in production units, including output power levels, amplifier gain settings and other RF performance tuning parameters. The test frequencies should correspond to actual channel frequencies defined for domestic use. SAR for devices with switched diversity should be measured with only one antenna transmitting at a time during each SAR measurement, according to a fixed modulation and data rate. The same data pattern should be used for all measurements.



12.2 Frequency Channel Configurations [27]

802.11 a/b/g and 4.9 GHz operating modes are tested independently according to the service requirements in each frequency band. 802.11 b/g modes are tested on channels 1, 6 and 11. 802.11a is tested for UNII operations on channels 36 and 48 in the 5.15-5.25 GHz band; channels 52 and 64 in the 5.25-5.35 GHz band; channels 104, 116, 124 and 136 in the 5.470-5.725 GHz band; and channels 149 and 161 in the 5.8 GHz band. When 5.8 GHz §15.247 is also available, channels 149, 157 and 165 should be tested instead of the UNII channels. 4.9 GHz is tested on channels 1, 10 and 5 or 6, whichever has the higher output power, for 5 MHz channels; channels 11, 15 and 19 for 10 MHz channels; and channels 21 and 25 for 20 MHz channels. These are referred to as the “default test channels”. 802.11g mode was evaluated only if the output power was 0.25 dB higher than the 802.11b mode.

**Table 12-1
802.11 Test Channels per FCC Requirements**

Mode	GHz	Channel	Turbo Channel	"Default Test Channels"		
				§15.247		UNII
				802.11b	802.11g	
802.11 b/g	2.412	1		√	∇	
	2.437	6	6	√	∇	
	2.462	11		√	∇	
802.11a	5.18	36				√
	5.20	40	42 (5.21 GHz)			*
	5.22	44				
	5.24	48	50 (5.25 GHz)			√
	5.26	52				√
	5.28	56	58 (5.29 GHz)			*
	5.30	60				*
	5.32	64			√	
	5.500	100	Unknown			*
	5.520	104				√
	5.540	108				*
	5.560	112				*
	5.580	116				√
	5.600	120				*
	5.620	124				√
	5.640	128				*
	5.660	132				*
	5.680	136				√
	5.700	140			*	
	UNII or §15.247	5.745	149		√	√
5.765		153	152 (5.76 GHz)		*	*
5.785		157		√	√	*
5.805		161	160 (5.80 GHz)		*	√
§15.247	5.825	165		√		



FCC ID: A3LGT57230L	 PCTEST ENGINEERING LABORATORY, INC.	SAR COMPLIANCE REPORT		Reviewed by: Quality Manager
Filename: OY1011261913.A3L	Test Dates: 11/29/10 - 12/02/10	EUT Type: 850/1900 GSM/GPRS/WCDMA/HSDPA Phone with EDGE Rx,Bluetooth and WLAN		Page 18 of 41

Table 12-2
IEEE 802.11b Average RF Power

Freq [MHz]	Channel	Data Rate [Mbps]	Average Power (dBm)
2412	1	1	16.71
		2	16.61
		5.5	16.68
		11	16.43
2437	6	1	16.97
		2	16.9
		5.5	16.9
		11	16.83
2462	11	1	17.13
		2	17.1
		5.5	17.04
		11	17.09

Table 12-3
IEEE 802.11g Average RF Power

Freq [MHz]	Channel	Data Rate [Mbps]	Average Power (dBm)
2412	1	6	13.46
		9	13.58
		12	13.4
		18	13.47
		24	13.45
		36	13.28
		48	13.21
		54	13.22
		2437	6
9	13.87		
12	13.81		
18	13.72		
24	13.69		
36	13.59		
48	13.31		
54	13.65		
2462	11		
		9	14.04
		12	14.01
		18	13.99
		24	14.05
		36	13.79
		48	13.88
		54	13.77





FCC ID: A3LGTS7230L		SAR COMPLIANCE REPORT		Reviewed by: Quality Manager
Filename: OY1011261913.A3L	Test Dates: 11/29/10 - 12/02/10	EUT Type: 850/1900 GSM/GPRS/WCDMA/HSDPA Phone with EDGE Rx,Bluetooth and WLAN		Page 19 of 41

Table 12-4
IEEE 802.11n Average RF Power

Freq [MHz]	Channel	MCS Index	Data Rate [Mbps]	Average Power (dBm)
2412	1	0	6.5/7.2	11.4
		1	13/14.4	10.84
		2	19.5/21.7	10.73
		3	26/28.9	10.71
		4	39/43.3	10.57
		5	52/57.8	10.46
		6	58.5/65	10.54
2437	6	7	65/72.2	10.86
		0	6.5/7.2	11.44
		1	13/14.4	11.12
		2	19.5/21.7	10.93
		3	26/28.9	10.96
		4	39/43.3	10.88
		5	52/57.8	10.78
2462	11	6	58.5/65	10.84
		7	65/72.2	10.83
		0	6.5/7.2	11.53
		1	13/14.4	11.41
		2	19.5/21.7	11.25
		3	26/28.9	11.2
		4	39/43.3	11.15
		5	52/57.8	10.96
		6	58.5/65	10.99
		7	65/72.2	11



Figure 12-1
Power Measurement Setup

FCC ID: A3LGTS7230L		SAR COMPLIANCE REPORT		Reviewed by: Quality Manager
Filename: 0Y1011261913.A3L	Test Dates: 11/29/10 - 12/02/10	EUT Type: 850/1900 GSM/GPRS/WCDMA/HSDPA Phone with EDGE Rx,Bluetooth and WLAN		Page 20 of 41

13 SYSTEM VERIFICATION



13.1 Tissue Verification

**Table 13-1
Measured Tissue Properties**

Calibrated for Tests Performed on:	Tissue Type	Measured Frequency (MHz)	Measured Conductivity, σ (S/m)	Measured Dielectric Constant, ϵ	TARGET Conductivity, σ (S/m)	TARGET Dielectric Constant, ϵ	% dev σ	% dev ϵ
11/29/2010	835H	820	0.897	42.42	0.90	41.57	-0.14%	2.04%
		835	0.884	42.40	0.90	41.50	-1.78%	2.17%
		850	0.902	42.60	0.92	41.50	-1.54%	2.65%
11/29/2010	835B	820	0.993	56.74	0.97	55.20	2.37%	2.79%
		835	1.007	56.21	0.97	55.20	3.81%	1.83%
		850	1.012	56.52	0.97	55.20	4.33%	2.39%
12/01/2010	1900H	1850	1.420	40.72	1.40	40.00	1.43%	1.80%
		1880	1.446	40.57	1.40	40.00	3.29%	1.43%
		1910	1.465	40.43	1.40	40.00	4.64%	1.08%
12/01/2010	1900B	1850	1.446	54.32	1.52	53.30	-4.87%	1.91%
		1880	1.475	54.22	1.52	53.30	-2.96%	1.73%
		1910	1.518	54.11	1.52	53.30	-0.13%	1.52%
12/02/2010	2450H	2401	1.806	38.04	1.758	39.30	2.76%	-3.20%
		2450	1.867	37.87	1.80	39.20	3.72%	-3.39%
		2499	1.914	37.72	1.85	39.13	3.33%	-3.61%
12/02/2010	2450B	2401	1.950	51.43	1.90	52.77	2.47%	-2.53%
		2450	2.015	51.29	1.95	52.70	3.33%	-2.68%
		2499	2.086	51.10	2.02	52.64	3.32%	-2.92%

Note: KDB Publication 450824 was ensured to be applied for probe calibration frequencies greater than or equal to 50 MHz of the DUT frequencies.

The above measured tissue parameters were used in the DASY software to perform interpolation via the DASY software to determine actual dielectric parameters at the test frequencies (per IEEE 1528 6.6.1.2). The SAR test plots may slightly differ from the table above since the DASY software rounds to three significant digits.

FCC ID: A3LGTS7230L		SAR COMPLIANCE REPORT			Reviewed by: Quality Manager
Filename: 0Y1011261913.A3L	Test Dates: 11/29/10 - 12/02/10	EUT Type: 850/1900 GSM/GPRS/WCDMA/HSDPA Phone with EDGE Rx,Bluetooth and WLAN			Page 21 of 41

13.2 Measurement Procedure for Tissue verification

- 1) The network analyzer and probe system was configured and calibrated.
- 2) The probe was immersed in the sample which was placed in a nonmetallic container. Trapped air bubbles beneath the flange were minimized by placing the probe at a slight angle.
- 3) The complex admittance with respect to the probe aperture was measured
- 4) The complex relative permittivity , for example from the below equation (Pournaropoulos and Misra):

$$Y = \frac{j2\omega\epsilon_r\epsilon_0}{[\ln(b/a)]^2} \int_a^b \int_a^b \int_0^\pi \cos\phi' \frac{\exp[-j\omega r(\mu_0\epsilon_r'\epsilon_0)^{1/2}]}{r} d\phi' d\rho' d\rho$$

where Y is the admittance of the probe in contact with the sample, the primed and unprimed coordinates refer to source and observation points, respectively, $r^2 = \rho^2 + \rho'^2 - 2\rho\rho' \cos\phi'$, ω is the angular frequency, and $j = \sqrt{-1}$.



13.3 Justification for Extended SAR Dipole Calibrations

Usage of SAR dipoles calibrated less than 2 years ago but more than 1 year ago were confirmed in maintaining return loss (< - 20 dB, within 20% of prior calibration) and impedance (within 5 ohm from prior calibration) requirements per extended calibrations in KDB Publication 450824:

D835V2 SN: 4d026				
Date of Measurement	Return Loss (dB)	Δ %	Impedance (Ω)	$\Delta\Omega$
8/24/2009	-22.5		51	
8/19/2010	-21.4	-5%	50.1	-0.9

D1900V2 SN:5d080				
Date of Measurement	Return Loss (dB)	Δ %	Impedance (Ω)	$\Delta\Omega$
8/18/2009	-24.3		50	
8/19/2010	-22.4	-7.8%	51	1.0

D2450V2 SN: 719				
Date of Measurement	Return Loss (dB)	Δ %	Impedance (Ω)	$\Delta\Omega$
8/27/2009	-28.6		53.4	
8/19/2010	-27.5	-3.8%	51	-2.4

FCC ID: A3LGTS7230L	 PCTEST ENGINEERING LABORATORY, INC.	SAR COMPLIANCE REPORT		Reviewed by: Quality Manager
Filename: OY1011261913.A3L	Test Dates: 11/29/10 - 12/02/10	EUT Type: 850/1900 GSM/GPRS/WCDMA/HSDPA Phone with EDGE Rx,Bluetooth and WLAN		Page 22 of 41

13.4 Test System Verification

Prior to assessment, the system is verified to $\pm 10\%$ of the manufacturer SAR measurement on the reference dipole at the time of calibration.

**Table 13-2
System Verification Results**

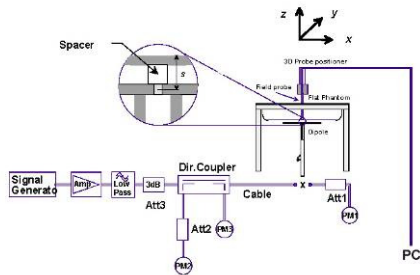

System Verification TARGET & MEASURED										
Date:	Amb. Temp (°C)	Liquid Temp (°C)	Input Power (W)	Tissue Frequency (MHz)	Dipole SN	Tissue Type	Measured SAR _{1g} (W/kg)	1 W Target SAR _{1g} (W/kg)	1 W Normalized SAR _{1g} (W/kg)	Deviation (%)
11/29/2010	23.6	22.8	0.100	835	4d026	Head	0.929	9.460	9.29	-1.80%
12/01/2010	23.9	22.3	0.040	1900	5d080	Head	1.66	40.100	41.50	3.49%
12/02/2010	23.8	22.1	0.040	2450	719	Head	2.2	53.500	55.00	2.80%



**Figure 13-1
System Verification Setup Diagram**



**Figure 13-2
System Verification Setup Photo**

FCC ID: A3LGT57230L		SAR COMPLIANCE REPORT		Reviewed by: Quality Manager
Filename: OY1011261913.A3L	Test Dates: 11/29/10 - 12/02/10	EUT Type: 850/1900 GSM/GPRS/WCDMA/HSDPA Phone with EDGE Rx,Bluetooth and WLAN		Page 23 of 41



14 SAR DATA SUMMARY

Table 14-1
Head SAR Results

MEASUREMENT RESULTS								
FREQUENCY		Mode/Band	C_Power[dBm]		Side	Test Position	Battery Type	SAR (1g)
MHz	Ch.		Start	End				(W/kg)
836.60	190	GSM 850	31.87	31.89	Right	Touch	Standard	0.432
836.60	190	GSM 850	31.87	31.87	Right	Tilt	Standard	0.256
836.60	190	GSM 850	31.87	31.84	Left	Touch	Standard	0.407
836.60	190	GSM 850	31.87	31.91	Left	Tilt	Standard	0.213
ANSI / IEEE C95.1 1992 - SAFETY LIMIT Spatial Peak Uncontrolled Exposure/General Population					Brain 1.6 W/kg (mW/g) averaged over 1 gram			

Notes:

1. The test data reported are the worst-case SAR value with the position set in a typical configuration. Test procedures used were according to FCC/OET Bulletin 65, Supplement C [June 2001].
2. All modes of operation were investigated, and worst-case results are reported.
3. Batteries are fully charged for all readings. Standard battery was used.
4. Tissue parameters and temperatures are listed on the SAR plots.
5. Liquid tissue depth was at least 15.0 cm.
6. Justification for reduced test configurations: Per FCC/OET Bulletin 65 Supplement C (June 2001) and Public Notice DA-02-1438, if the SAR measured at the middle channel for each test configuration (left, right, cheek/touch, tilt/ear, extended and retracted) is at least 3.0 dB lower than the SAR limit, testing at the high and low channels is optional for such test configuration(s).



FCC ID: A3LGTS7230L	 PCTEST ENGINEERING LABORATORY, INC.	SAR COMPLIANCE REPORT		Reviewed by: Quality Manager
Filename: 0Y1011261913.A3L	Test Dates: 11/29/10 - 12/02/10	EUT Type: 850/1900 GSM/GPRS/WCDMA/HSDPA Phone with EDGE Rx,Bluetooth and WLAN		Page 24 of 41

**Table 14-2
Head SAR Results**

MEASUREMENT RESULTS								
FREQUENCY		Mode/Band	C_Power[dBm]		Side	Test Position	Battery Type	SAR (1g)
MHz	Ch.		Start	End				(W/kg)
1880.00	661	GSM 1900	29.42	29.46	Right	Touch	Standard	0.713
1880.00	661	GSM 1900	29.42	29.41	Right	Tilt	Standard	0.392
1850.20	512	GSM 1900	29.25	29.25	Left	Touch	Standard	0.824
1880.00	661	GSM 1900	29.42	29.42	Left	Touch	Standard	0.889
1909.80	810	GSM 1900	28.98	28.97	Left	Touch	Standard	0.857
1880.00	661	GSM 1900	29.42	29.49	Left	Tilt	Standard	0.300
ANSI / IEEE C95.1 1992 - SAFETY LIMIT					Brain			
Spatial Peak					1.6 W/kg (mW/g)			
Uncontrolled Exposure/General Population					averaged over 1 gram			

Notes:

1. The test data reported are the worst-case SAR value with the position set in a typical configuration. Test procedures used were according to FCC/OET Bulletin 65, Supplement C [June 2001].
2. All modes of operation were investigated, and worst-case results are reported.
3. Batteries are fully charged for all readings. Standard battery was used.
4. Tissue parameters and temperatures are listed on the SAR plots.
5. Liquid tissue depth was at least 15.0 cm.
6. Justification for reduced test configurations: Per FCC/OET Bulletin 65 Supplement C (June 2001) and Public Notice DA-02-1438, if the SAR measured at the middle channel for each test configuration (left, right, cheek/touch, tilt/ear, extended and retracted) is at least 3.0 dB lower than the SAR limit, testing at the high and low channels is optional for such test configuration(s).



FCC ID: A3LGTS7230L		SAR COMPLIANCE REPORT		Reviewed by: Quality Manager
Filename: OY1011261913.A3L	Test Dates: 11/29/10 - 12/02/10	EUT Type: 850/1900 GSM/GPRS/WCDMA/HSDPA Phone with EDGE Rx,Bluetooth and WLAN		Page 25 of 41

**Table 14-3
Head SAR Results**

MEASUREMENT RESULTS								
FREQUENCY		Mode/Band	C_Power[dBm]		Side	Test Position	Battery Type	SAR (1g)
MHz	Ch.		Start	End				(W/kg)
836.60	4183	UMTS V	22.72	22.71	Right	Touch	Standard	0.263
836.60	4183	UMTS V	22.72	22.78	Right	Tilt	Standard	0.168
836.60	4183	UMTS V	22.72	22.75	Left	Touch	Standard	0.244
836.60	4183	UMTS V	22.72	22.80	Left	Tilt	Standard	0.151
ANSI / IEEE C95.1 1992 - SAFETY LIMIT					Brain			
Spatial Peak					1.6 W/kg (mW/g)			
Uncontrolled Exposure/General Population					averaged over 1 gram			

Notes:

1. The test data reported are the worst-case SAR value with the position set in a typical configuration. Test procedures used were according to FCC/OET Bulletin 65, Supplement C [June 2001].
2. All modes of operation were investigated, and worst-case results are reported.
3. Batteries are fully charged for all readings. Standard battery was used.
4. Tissue parameters and temperatures are listed on the SAR plots.
5. Liquid tissue depth was at least 15.0 cm.
6. Justification for reduced test configurations: Per FCC/OET Bulletin 65 Supplement C (June 2001) and Public Notice DA-02-1438, if the SAR measured at the middle channel for each test configuration (left, right, cheek/touch, tilt/ear, extended and retracted) is at least 3.0 dB lower than the SAR limit, testing at the high and low channels is optional for such test configuration(s).
7. WCDMA mode was tested under RMC 12.2 kbps with HSDPA Inactive.



FCC ID: A3LGTS7230L		SAR COMPLIANCE REPORT		Reviewed by: Quality Manager
Filename: 0Y1011261913.A3L	Test Dates: 11/29/10 - 12/02/10	EUT Type: 850/1900 GSM/GPRS/WCDMA/HSDPA Phone with EDGE Rx,Bluetooth and WLAN		Page 26 of 41

**Table 14-4
Head SAR Results**

MEASUREMENT RESULTS								
FREQUENCY		Mode	C_Power[dBm]		Side	Test Position	Battery Type	SAR (1g)
MHz	Ch.		Start	End				(W/kg)
1880.00	9400	UMTS II	22.68	22.68	Right	Touch	Standard	0.782
1880.00	9400	UMTS II	22.68	22.66	Right	Tilt	Standard	0.434
1852.40	9262	UMTS II	22.63	22.64	Left	Touch	Standard	0.916
1880.00	9400	UMTS II	22.68	22.69	Left	Touch	Standard	1.060
1907.60	9538	UMTS II	22.59	22.58	Left	Touch	Standard	0.962
1880.00	9400	UMTS II	22.68	22.64	Left	Tilt	Standard	0.315
ANSI / IEEE C95.1 1992 - SAFETY LIMIT					Brain			
Spatial Peak					1.6 W/kg (mW/g)			
Uncontrolled Exposure/General Population					averaged over 1 gram			

Notes:

1. The test data reported are the worst-case SAR value with the position set in a typical configuration. Test procedures used were according to FCC/OET Bulletin 65, Supplement C [June 2001].
2. All modes of operation were investigated, and worst-case results are reported.
3. Batteries are fully charged for all readings. Standard battery was used.
4. Tissue parameters and temperatures are listed on the SAR plots.
5. Liquid tissue depth was at least 15.0 cm.
6. Justification for reduced test configurations: Per FCC/OET Bulletin 65 Supplement C (June 2001) and Public Notice DA-02-1438, if the SAR measured at the middle channel for each test configuration (left, right, cheek/touch, tilt/ear, extended and retracted) is at least 3.0 dB lower than the SAR limit, testing at the high and low channels is optional for such test configuration(s).
7. WCDMA mode was tested under RMC 12.2 kbps with HSDPA Inactive.



FCC ID: A3LGTS7230L		SAR COMPLIANCE REPORT		Reviewed by: Quality Manager
Filename: 0Y1011261913.A3L	Test Dates: 11/29/10 - 12/02/10	EUT Type: 850/1900 GSM/GPRS/WCDMA/HSDPA Phone with EDGE Rx,Bluetooth and WLAN		Page 27 of 41

**Table 14-5
Head SAR Results**

MEASUREMENT RESULTS									
FREQUENCY		Mode	C_Power[dBm]		Side	Test Position	Battery Type	Data Rate (Mbps)	SAR (1g)
MHz	Ch.		Start	End					(W/kg)
2462	11	IEEE 802.11b	17.13	17.24	Right	Touch	Standard	1	0.562
2462	11	IEEE 802.11b	17.13	17.08	Right	Tilt	Standard	1	0.153
2462	11	IEEE 802.11b	17.13	17.18	Left	Touch	Standard	1	0.356
2462	11	IEEE 802.11b	17.13	17.14	Left	Tilt	Standard	1	0.095
ANSI / IEEE C95.1 1992 - SAFETY LIMIT Spatial Peak Uncontrolled Exposure/General Population					Brain 1.6 W/kg (mW/g) averaged over 1 gram				

Notes:

1. The test data reported are the worst-case SAR value with the position set in a typical configuration. Test procedures used were according to FCC/OET Bulletin 65, Supplement C [June 2001].
2. All modes of operation were investigated, and worst-case results are reported.
3. Batteries are fully charged for all readings. Standard battery was used.
4. Tissue parameters and temperatures are listed on the SAR plots.
5. Liquid tissue depth was at least 15.0 cm.
6. Justification for reduced test configurations for WIFI channels per KDB Publication 248227 and April 2010 FCC/TCB Meeting Notes: Highest average RF output power channel for the lowest data rate were selected for SAR evaluation. Other IEEE 802.11 modes (including 802.11n) were not investigated since the average output powers were not greater than 0.25 dB than that of the corresponding channel in the lowest data rate IEEE 802.11b mode.
7. WLAN transmission was verified using a spectrum analyzer.



FCC ID: A3LGTS7230L		SAR COMPLIANCE REPORT		Reviewed by: Quality Manager
Filename: 0Y1011261913.A3L	Test Dates: 11/29/10 - 12/02/10	EUT Type: 850/1900 GSM/GPRS/WCDMA/HSDPA Phone with EDGE Rx,Bluetooth and WLAN		Page 28 of 41

**Table 14-6
Body SAR Results**

MEASUREMENT RESULTS											
FREQUENCY		Mode	Service	C_Power[dBm]		Position	Spacing	Battery Type	Slots	Side	SAR (1g)
MHz	Ch.			Start	End						(W/kg)
836.60	190	GSM 850	GPRS	30.34	30.34	Body	1.5 cm	Standard	2	back	0.488
1880.00	661	GSM 1900	GPRS	27.94	27.91	Body	1.5 cm	Standard	2	back	0.559
836.60	4183	UMTS V	RMC	22.72	22.72	Body	1.5 cm	Standard	N/A	back	0.191
1880.00	9400	UMTS II	RMC	22.68	22.63	Body	1.5 cm	Standard	N/A	back	0.454
ANSI / IEEE C95.1 1992 - SAFETY LIMIT							Body				
Spatial Peak							1.6 W/kg (mW/g)				
Uncontrolled Exposure/General Population							averaged over 1 gram				

Notes:

1. The test data reported are the worst-case SAR value with the position set in a typical configuration. Test procedures used were according to FCC/OET Bulletin 65, Supplement C [June 2001].
2. All modes of operation were investigated, and worst-case results are reported.
3. Tissue parameters and temperatures are listed on the SAR plots.
4. Batteries are fully charged for all readings. Standard battery was used.
5. Liquid tissue depth was at least 15.0 cm.
6. WCDMA mode in Body SAR was tested under RMC 12.2 kbps with HSDPA Inactive.
7. Justification for reduced test configurations per KDB Publication 941225: The source-based time-averaged output power was evaluated for all multi-slot operations. In addition to the worst-case reported, all source-based time-averaged powers within 10% of the worst-case were additionally included in the evaluation.
8. Justification for reduced test configurations: Per FCC/OET Bulletin 65 Supplement C (June 2001) and Public Notice DA-02-1438, if the SAR measured at the middle channel for each test configuration is at least 3.0 dB lower than the SAR limit, testing at the high and low channels is optional for such test configuration(s).

FCC ID: A3LGTS7230L		SAR COMPLIANCE REPORT		Reviewed by: Quality Manager
Filename: OY1011261913.A3L	Test Dates: 11/29/10 - 12/02/10	EUT Type: 850/1900 GSM/GPRS/WCDMA/HSDPA Phone with EDGE Rx,Bluetooth and WLAN		Page 29 of 41

**Table 14-7
2.4 GHz Body SAR Results**

MEASUREMENT RESULTS											
FREQUENCY		Mode	C_Power[dBm]		Position	Service	Spacing	Battery Type	Data Rate (Mbps)	Side	SAR
MHz	Ch.		Start	End							(W/kg)
2462	11	IEEE 802.11b	17.13	17.19	Body	DSSS	1.5 cm	Standard	1	back	0.116
2462	11	IEEE 802.11b	17.13	17.18	Body	DSSS	1.5 cm	Standard	1	front	0.140
ANSI / IEEE C95.1 1992 - SAFETY LIMIT							Body				
Spatial Peak							1.6 W/kg (mW/g)				
Uncontrolled Exposure/General Population							averaged over 1 gram				

Notes:

1. The test data reported are the worst-case SAR value with the position set in a typical configuration. Test procedures used were according to FCC/OET Bulletin 65, Supplement C [June 2001].
2. All modes of operation were investigated, and worst-case results are reported.
3. Batteries are fully charged for all readings. Standard battery was used.
4. Tissue parameters and temperatures are listed on the SAR plots.
5. Liquid tissue depth is was at least 15.0 cm.
6. Justification for reduced test configurations for WIFI channels per KDB Publication 248227 and April 2010 FCC/TCB Meeting Notes: Highest average RF output power channel for the lowest data rate were selected for SAR evaluation. Other IEEE 802.11 modes (including 802.11n) were not investigated since the average output powers were not greater than 0.25 dB than that of the corresponding channel in the lowest data rate IEEE 802.11b mode.
7. WLAN transmission was verified using a spectrum analyzer.

FCC ID: A3LGT57230L		SAR COMPLIANCE REPORT		Reviewed by: Quality Manager
Filename: 0Y1011261913.A3L	Test Dates: 11/29/10 - 12/02/10	EUT Type: 850/1900 GSM/GPRS/WCDMA/HSDPA Phone with EDGE Rx,Bluetooth and WLAN		Page 30 of 41

15 FCC MULTI-TX AND ANTENNA SAR CONSIDERATIONS

15.1 Introduction

The following procedures adopted from “FCC SAR Considerations for Cell Phones with Multiple Transmitters” v01r03 from May 2008 are applicable to handsets with built-in unlicensed transmitters such as 802.11a/b/g and Bluetooth devices which may simultaneously transmit with the licensed transmitter.

15.2 FCC Power Tables & Conditions

	2.45	5.15 - 5.35	5.47 - 5.85	GHz
P_{Ref}	12	6	5	mW

Device output power should be rounded to the nearest mW to compare with values specified in this table.

Figure 15-1
Output Power Thresholds for Unlicensed Transmitters



	Individual Transmitter	Simultaneous Transmission
Licensed Transmitters	<u>Routine evaluation required</u>	<u>SAR not required:</u> <u>Unlicensed only</u>
Unlicensed Transmitters	<p><u>When there is no simultaneous transmission –</u></p> <ul style="list-style-type: none"> output $\leq 60/f$: SAR not required output $> 60/f$: stand-alone SAR required <p><u>When there is simultaneous transmission –</u></p> <p><u>Stand-alone SAR not required when</u></p> <ul style="list-style-type: none"> output $\leq 2 \cdot P_{Ref}$ and antenna is ≥ 5.0 cm from other antennas output $\leq P_{Ref}$ and antenna is ≥ 2.5 cm from other antennas <p><u>Otherwise stand-alone SAR is required</u></p> <p><u>When stand-alone SAR is required</u></p> <ul style="list-style-type: none"> test SAR on highest output channel for each wireless mode and exposure condition if SAR for highest output channel is $> 50\%$ of SAR limit, evaluate all channels according to normal procedures 	<ul style="list-style-type: none"> when stand-alone 1-g SAR is not required and antenna is ≥ 5 cm from other antennas <p><u>Licensed & Unlicensed</u></p> <ul style="list-style-type: none"> when the sum of the 1-g SAR is < 1.6 W/kg for all simultaneous transmitting antennas when SAR to peak location separation ratio of simultaneous transmitting antenna pair is < 0.3 <p><u>SAR required:</u> <u>Licensed & Unlicensed</u></p> <p>antenna pairs with SAR to peak location separation ratio ≥ 0.3; test is only required for the configuration that results in the highest SAR in stand-alone configuration for each wireless mode and exposure condition</p> <p>Note: simultaneous transmission exposure conditions for head and body can be different for different style phones; therefore, different test requirements may apply</p>

Figure 15-2
SAR Evaluation Requirements for Multiple Transmitter Handsets

15.3 Multiple Antenna/Transmission Information for GT-S7230L

The separation distance between the main antenna and the Bluetooth antenna and is 17 mm and the distance between main antenna and WLAN antenna is 17 mm.

The RF Conducted Power of Bluetooth Tx is 6.76 mW and the RF Conducted power of WLAN is 51.64 mW.

FCC ID: A3LGTS7230L		SAR COMPLIANCE REPORT		Reviewed by: Quality Manager
Filename: OY1011261913.A3L	Test Dates: 11/29/10 - 12/02/10	EUT Type: 850/1900 GSM/GPRS/WCDMA/HSDPA Phone with EDGE Rx,Bluetooth and WLAN		Page 31 of 41



15.4 Conclusion for Bluetooth

Based on the output power, antenna separation distance and the Body SAR of the dominant transmitter, a stand-alone Bluetooth SAR test is not required.

Simult Tx	Configuration	2G/3G SAR (W/kg)	WiFi SAR (W/kg)	Bluetooth SAR (W/kg)	Σ SAR (W/kg)
Head SAR	Right Cheek	0.782	0.562		1.344
	Right Tilt	0.434	0.153		0.587
	Left Cheek	1.060	0.356		1.416
	Left Tilt	0.315	0.095		0.410
Body SAR	Body	0.559	0.140	0	0.699

15.5 Simultaneous Tx Evaluation per KDB 648474

The above numerical summed SAR was below the SAR limit. Therefore, the above analysis is sufficient to determine that simultaneous transmission cases will not exceed the SAR limit. Therefore, no volumetric SAR summation is required since the numerical sums are below the limit.



FCC ID: A3LGTS7230L		SAR COMPLIANCE REPORT			Reviewed by: Quality Manager
Filename: 0Y1011261913.A3L	Test Dates: 11/29/10 - 12/02/10	EUT Type: 850/1900 GSM/GPRS/WCDMA/HSDPA Phone with EDGE Rx, Bluetooth and WLAN			Page 32 of 41

16

EQUIPMENT LIST

Manufacturer	Model	Description	Cal Date	Cal Interval	Cal Due	Serial Number
Agilent	85070B	Dielectric Probe Kit	8/22/2010	Annual	8/22/2011	US33020316
Agilent	8648D	(9kHz-4GHz) Signal Generator	10/11/2010	Annual	10/11/2011	3613A00315
Agilent	8753E	(30kHz-6GHz) Network Analyzer	3/31/2010	Annual	3/31/2011	JP38020182
Agilent	E5515C	Wireless Communications Test Set	10/11/2010	Annual	10/11/2011	GB46110872
Agilent	E5515C	Wireless Communications Test Set	10/11/2010	Annual	10/11/2011	GB46310798
Agilent	E5515C	Wireless Communications Test Set	8/12/2010	Annual	8/12/2011	GB41450275
Agilent	E8257D	(250kHz-20GHz) Signal Generator	3/30/2010	Annual	3/30/2011	MY45470194
Gigatronics	80701A	(0.05-18GHz) Power Sensor	10/11/2010	Annual	10/11/2011	1833460
Gigatronics	8651A	Universal Power Meter	10/11/2010	Annual	10/11/2011	8650319
Rohde & Schwarz	CMU200	Base Station Simulator	6/21/2010	Annual	6/21/2011	833855/0010
SPEAG	D1450V2	1450 MHz SAR Dipole	5/20/2009	Biennial	5/20/2011	1025
SPEAG	D1765V2	1765 MHz SAR Dipole	5/19/2009	Biennial	5/19/2011	1008
SPEAG	D1900V2	1900 MHz SAR Dipole	1/20/2009	Biennial	1/20/2011	502
SPEAG	D1900V2	1900 MHz SAR Dipole	8/18/2009	Biennial	8/18/2011	5d080
SPEAG	D2450V2	2450 MHz SAR Dipole	8/27/2009	Biennial	8/27/2011	719
SPEAG	D2450V2	2450 MHz SAR Dipole	1/8/2009	Biennial	1/8/2011	797
SPEAG	D2600V2	2600 MHz SAR Dipole	8/12/2009	Biennial	8/12/2011	1004
SPEAG	D5GHzV2	5 GHz SAR Dipole	8/19/2009	Biennial	8/19/2011	1007
SPEAG	D5GHzV2	5 GHz SAR Dipole	1/15/2009	Biennial	1/15/2011	1057
SPEAG	D835V2	835 MHz SAR Dipole	1/19/2009	Biennial	1/19/2011	4d047
SPEAG	D835V2	835 MHz SAR Dipole	8/24/2009	Biennial	8/24/2011	4d026
SPEAG	DAE4	Dasy Data Acquisition Electronics	3/22/2010	Annual	3/22/2011	704
SPEAG	DAE4	Dasy Data Acquisition Electronics	4/21/2010	Annual	4/21/2011	665
SPEAG	DAE4	Dasy Data Acquisition Electronics	1/22/2010	Annual	1/22/2011	649
SPEAG	ES3DV2	SAR Probe	9/21/2010	Annual	9/21/2011	3022
SPEAG	EX3DV4	SAR Probe	8/19/2010	Annual	8/19/2011	3561
SPEAG	EX3DV4	SAR Probe	1/26/2010	Annual	1/26/2011	3550
SPEAG	DAE4	Dasy Data Acquisition Electronics	7/8/2010	Annual	7/8/2011	859
SPEAG	D750V3	750 MHz Dipole	8/19/2010	Biennial	8/19/2012	1003
SPEAG	ES3DV3	SAR Probe	3/16/2010	Annual	3/16/2011	3213
SPEAG	ES3DV3	SAR Probe	4/20/2010	Annual	4/20/2011	3209
Rohde & Schwarz	SMIQ03B	Signal Generator	4/1/2010	Annual	4/1/2011	DE27259
SPEAG	D1640V2	1640 MHz Dipole	8/17/2010	Biennial	8/17/2012	321
Rohde & Schwarz	CMW500	LTE Radio Communication Tester	8/30/2010	Annual	8/30/2011	100976
Agilent	8648D	Signal Generator	4/1/2010	Annual	4/1/2011	3629U00687
Apriel	ALS-PR-DIEL	Dielectric Probe Kit	N/A		N/A	260-00959
Agilent	E5515C	Wireless Communications Tester	4/14/2010	Annual	4/14/2011	US41140256
SPEAG	ES3DV3	SAR Probe	2/10/2010	Annual	2/10/2011	3173
Amplifier Research	5S1G4	5W, 800MHz-4.2GHz	N/A			17042

Justification for 2-year calibration cycle for SAR dipoles is found in Section 13.3.



FCC ID: A3LGT57230L		SAR COMPLIANCE REPORT		Reviewed by: Quality Manager
Filename: OY1011261913.A3L	Test Dates: 11/29/10 - 12/02/10	EUT Type: 850/1900 GSM/GPRS/WCDMA/HSDPA Phone with EDGE Rx,Bluetooth and WLAN		Page 33 of 41

17 MEASUREMENT UNCERTAINTIES

Applicable for 800 – 3000 MHz.

a	b	c	d	e= f(d,k)	f	g	h = c x f/e	i = c x g/e	k
Uncertainty Component	IEEE 1528 Sec.	Tol. (± %)	Prob. Dist.	Div.	c _i 1gm	c _i 10gms	1gm u _i (± %)	10gms u _i (± %)	v _i
Measurement System									
Probe Calibration	E.2.1	5.5	N	1	1.0	1.0	5.5	5.5	∞
Axial Isotropy	E.2.2	0.25	N	1	0.7	0.7	0.2	0.2	∞
Hemishperical Isotropy	E.2.2	1.3	N	1	1.0	1.0	1.3	1.3	∞
Boundary Effect	E.2.3	0.4	N	1	1.0	1.0	0.4	0.4	∞
Linearity	E.2.4	0.3	N	1	1.0	1.0	0.3	0.3	∞
System Detection Limits	E.2.5	5.1	N	1	1.0	1.0	5.1	5.1	∞
Readout Electronics	E.2.6	1.0	N	1	1.0	1.0	1.0	1.0	∞
Response Time	E.2.7	0.8	R	1.73	1.0	1.0	0.5	0.5	∞
Integration Time	E.2.8	2.6	R	1.73	1.0	1.0	1.5	1.5	∞
RF Ambient Conditions	E.6.1	3.0	R	1.73	1.0	1.0	1.7	1.7	∞
Probe Positioner Mechanical Tolerance	E.6.2	0.4	R	1.73	1.0	1.0	0.2	0.2	∞
Probe Positioning w/ respect to Phantom	E.6.3	2.9	R	1.73	1.0	1.0	1.7	1.7	∞
Extrapolation, Interpolation & Integration algorithms for Max. SAR Evaluation	E.5	1.0	R	1.73	1.0	1.0	0.6	0.6	∞
Test Sample Related									
Test Sample Positioning	E.4.2	6.0	N	1	1.0	1.0	6.0	6.0	287
Device Holder Uncertainty	E.4.1	3.32	R	1.73	1.0	1.0	1.9	1.9	∞
Output Power Variation - SAR drift measurement	6.6.2	5.0	R	1.73	1.0	1.0	2.9	2.9	∞
Phantom & Tissue Parameters									
Phantom Uncertainty (Shape & Thickness tolerances)	E.3.1	4.0	R	1.73	1.0	1.0	2.3	2.3	∞
Liquid Conductivity - deviation from target values	E.3.2	5.0	R	1.73	0.64	0.43	1.8	1.2	∞
Liquid Conductivity - measurement uncertainty	E.3.3	3.8	N	1	0.64	0.43	2.4	1.6	6
Liquid Permittivity - deviation from target values	E.3.2	5.0	R	1.73	0.60	0.49	1.7	1.4	∞
Liquid Permittivity - measurement uncertainty	E.3.3	4.5	N	1	0.60	0.49	2.7	2.2	6
Combined Standard Uncertainty (k=1)				RSS			11.8	11.5	299
Expanded Uncertainty (95% CONFIDENCE LEVEL)				k=2			23.7	23.0	

The above measurement uncertainties are according to IEEE Std. 1528-2003



FCC ID: A3LGT57230L		SAR COMPLIANCE REPORT		Reviewed by: Quality Manager
Filename: OY1011261913.A3L	Test Dates: 11/29/10 - 12/02/10	EUT Type: 850/1900 GSM/GPRS/WCDMA/HSDPA Phone with EDGE Rx,Bluetooth and WLAN		Page 34 of 41

18 CONCLUSION

18.1 Measurement Conclusion



The SAR evaluation indicates that the EUT complies with the RF radiation exposure limits of the FCC and Industry Canada, with respect to all parameters subject to this test. These measurements were taken to simulate the RF effects of RF exposure under worst-case conditions. Precise laboratory measures were taken to assure repeatability of the tests. The results and statements relate only to the item(s) tested.

Please note that the absorption and distribution of electromagnetic energy in the body are very complex phenomena that depend on the mass, shape, and size of the body, the orientation of the body with respect to the field vectors, and the electrical properties of both the body and the environment. Other variables that may play a substantial role in possible biological effects are those that characterize the environment (e.g. ambient temperature, air velocity, relative humidity, and body insulation) and those that characterize the individual (e.g. age, gender, activity level, debilitation, or disease). Because various factors may interact with one another to vary the specific biological outcome of an exposure to electromagnetic fields, any protection guide should consider maximal amplification of biological effects as a result of field-body interactions, environmental conditions, and physiological variables. [3]



FCC ID: A3LGTS7230L		SAR COMPLIANCE REPORT		Reviewed by: Quality Manager
Filename: 0Y1011261913.A3L	Test Dates: 11/29/10 - 12/02/10	EUT Type: 850/1900 GSM/GPRS/WCDMA/HSDPA Phone with EDGE Rx,Bluetooth and WLAN	Page 35 of 41	

19 REFERENCES

- [1] Federal Communications Commission, ET Docket 93-62, Guidelines for Evaluating the Environmental Effects of Radiofrequency Radiation, Aug. 1996.
- [2] ANSI/IEEE C95.1-2005, American National Standard safety levels with respect to human exposure to radio frequency electromagnetic fields, 300kHz to 100GHz, New York: IEEE, 2006.
- [3] ANSI/IEEE C95.1-1992, American National Standard safety levels with respect to human exposure to radio frequency electromagnetic fields, 300kHz to 100GHz, New York: IEEE, Sept. 1992.
- [4] ANSI/IEEE C95.3-2002, IEEE Recommended Practice for the Measurement of Potentially Hazardous Electromagnetic Fields - RF and Microwave, New York: IEEE, December 2002.
- [5] Federal Communications Commission, OET Bulletin 65 (Edition 97-01), Supplement C (Edition 01-01), Evaluating Compliance with FCC Guidelines for Human Exposure to Radiofrequency Electromagnetic Fields, June 2001.
- [6] IEEE Standards Coordinating Committee 34 – IEEE Std. 1528-2003, Recommended Practice for Determining the Peak Spatial-Average Specific Absorption Rate (SAR) in the Human Body Due to Wireless Communications Devices.
- [7] NCRP, National Council on Radiation Protection and Measurements, Biological Effects and Exposure Criteria for RadioFrequency Electromagnetic Fields, NCRP Report No. 86, 1986. Reprinted Feb. 1995.
- [8] T. Schmid, O. Egger, N. Kuster, Automated E-field scanning system for dosimetric assessments, IEEE Transaction on Microwave Theory and Techniques, vol. 44, Jan. 1996, pp. 105-113.
- [9] K. Pokovic, T. Schmid, N. Kuster, Robust setup for precise calibration of E-field probes in tissue simulating liquids at mobile communications frequencies, ICECOM97, Oct. 1997, pp. 120-124.
- [10] K. Pokovic, T. Schmid, and N. Kuster, E-field Probe with improved isotropy in brain simulating liquids, Proceedings of the ELMAR, Zadar, Croatia, June 23-25, 1996, pp. 172-175.
- [11] Schmid & Partner Engineering AG, Application Note: Data Storage and Evaluation, June 1998, p2.
- [12] V. Hombach, K. Meier, M. Burkhardt, E. Kuhn, N. Kuster, The Dependence of EM Energy Absorption upon Human Head Modeling at 900 MHz, IEEE Transaction on Microwave Theory and Techniques, vol. 44 no. 10, Oct. 1996, pp. 1865-1873.
- [13] N. Kuster and Q. Balzano, Energy absorption mechanism by biological bodies in the near field of dipole antennas above 300MHz, IEEE Transaction on Vehicular Technology, vol. 41, no. 1, Feb. 1992, pp. 17-23.
- [14] G. Hartsgrove, A. Kraszewski, A. Surowiec, Simulated Biological Materials for Electromagnetic Radiation Absorption Studies, University of Ottawa, Bioelectromagnetics, Canada: 1987, pp. 29-36.
- [15] Q. Balzano, O. Garay, T. Manning Jr., Electromagnetic Energy Exposure of Simulated Users of Portable Cellular Telephones, IEEE Transactions on Vehicular Technology, vol. 44, no.3, Aug. 1995.

FCC ID: A3LGT57230L		SAR COMPLIANCE REPORT		Reviewed by: Quality Manager
Filename: OY1011261913.A3L	Test Dates: 11/29/10 - 12/02/10	EUT Type: 850/1900 GSM/GPRS/WCDMA/HSDPA Phone with EDGE Rx,Bluetooth and WLAN		Page 36 of 41

- [16] W. Gander, Computermathematick, Birkhaeuser, Basel, 1992.
- [17] W.H. Press, S.A. Teukolsky, W.T. Vetterling, and B.P. Flannery, Numerical Receptions in C, The Art of Scientific Computing, Second edition, Cambridge University Press, 1992.
- [18] Federal Communications Commission, OET Bulletin 65, Evaluating Compliance with FCC Guidelines for Human Exposure to Radiofrequency Electromagnetic Fields. Supplement C, Dec. 1997.
- [19] N. Kuster, R. Kastle, T. Schmid, Dosimetric evaluation of mobile communications equipment with known precision, IEEE Transaction on Communications, vol. E80-B, no. 5, May 1997, pp. 645-652.
- [20] CENELEC CLC/SC111B, European Prestandard (prENV 50166-2), Human Exposure to Electromagnetic Fields High-frequency: 10kHz-300GHz, Jan. 1995.
- [21] Prof. Dr. Niels Kuster, ETH, Eidgenössische Technische Hochschule Zürich, Dosimetric Evaluation of the Cellular Phone.
- [22] IEC 62209-1, Human exposure to radio frequency fields from hand-held and body-mounted wireless communication devices - Human models, instrumentation, and procedures - Part 1: Procedure to determine the specific absorption rate (SAR) for hand-held devices used in close proximity to the ear (frequency range of 300 MHz to 3 GHz), Feb. 2005.
- [23] Industry Canada RSS-102 Radio Frequency Exposure Compliance of Radiocommunication Apparatus (All Frequency Bands) Issue 4, March 2010.
- [24] Health Canada Safety Code 6 Limits of Human Exposure to Radio Frequency Electromagnetic Fields in the Frequency Range from 3 kHz – 300 GHz, 2009
- [25] FCC Public Notice DA-02-1438. Office of Engineering and Technology Announces a Transition Period for the Phantom Requirements of Supplement C to OET Bulletin 65, June 19, 2002
- [26] FCC SAR Measurement Procedures for 3G Devices KDB Publication 941225
- [27] SAR Measurement procedures for IEEE 802.11a/b/g KDB Publication 248227
- [28] FCC SAR Considerations for Handsets with Multiple Transmitters and Antennas, KDB Publication 648474
- [29] FCC Application Note for SAR Probe Calibration and System Verification Consideration for Measurements at 150 MHz – 3 GHz, KDB Publication 450824
- [30] FCC SAR Evaluation Considerations for Laptop Computers with Antennas Built-in on Display Screens, KDB Publication 616217
- [31] FCC SAR Measurement Requirements for 3 – 6 GHz, KDB Publication 865664
- [32] FCC Mobile Portable RF Exposure Procedure, KDB Publication 447498
- [33] FCC SAR Procedures for Dongle Transmitters, KDB Publication 447498
- [34] Anexo à Resolução No. 533, de 10 de Setembro de 2009.

FCC ID: A3LGT57230L		SAR COMPLIANCE REPORT		Reviewed by: Quality Manager
Filename: OY1011261913.A3L	Test Dates: 11/29/10 - 12/02/10	EUT Type: 850/1900 GSM/GPRS/WCDMA/HSDPA Phone with EDGE Rx,Bluetooth and WLAN		Page 37 of 41

APPENDIX A: SAR TEST DATA

PCTEST ENGINEERING LABORATORY, INC.

**DUT: A3LGTS7230L; Type: 850/1900 GSM/GPRS/WCDMA/HSDPA Phone
with EDGE Rx, Bluetooth and WLAN; Serial: FH 254 B**

Communication System: GSM850; Frequency: 836.6 MHz; Duty Cycle: 1:8.3
Medium: 835 Brain; Medium parameters used (interpolated):
 $f = 836.6 \text{ MHz}$; $\sigma = 0.886 \text{ mho/m}$; $\epsilon_r = 42.4$; $\rho = 1000 \text{ kg/m}^3$
Phantom section: Right Section

Test Date: 11-29-2010; Ambient Temp: 23.6 °C; Tissue Temp: 22.8 °C

Probe: EX3DV4 - SN3550; ConvF(8.28, 8.28, 8.28); Calibrated: 1/26/2010
Sensor-Surface: 4mm (Mechanical Surface Detection)
Electronics: DAE4 Sn649; Calibrated: 1/22/2010
Phantom: SAM Main; Type: SAM 4.0; Serial: TP-1114
Measurement SW: DASY4, V4.7 Build 80; Postprocessing SW: SEMCAD, V1.8 Build 186

Mode: GSM 850, Right Head, Touch, Mid.ch

Area Scan (7x11x1): Measurement grid: dx=15mm, dy=15mm
Zoom Scan (5x5x7)/Cube 0: Measurement grid: dx=8mm, dy=8mm, dz=5mm
Reference Value = 22.3 V/m
Peak SAR (extrapolated) = 0.546 W/kg
SAR(1 g) = 0.432 mW/g; SAR(10 g) = 0.322 mW/g

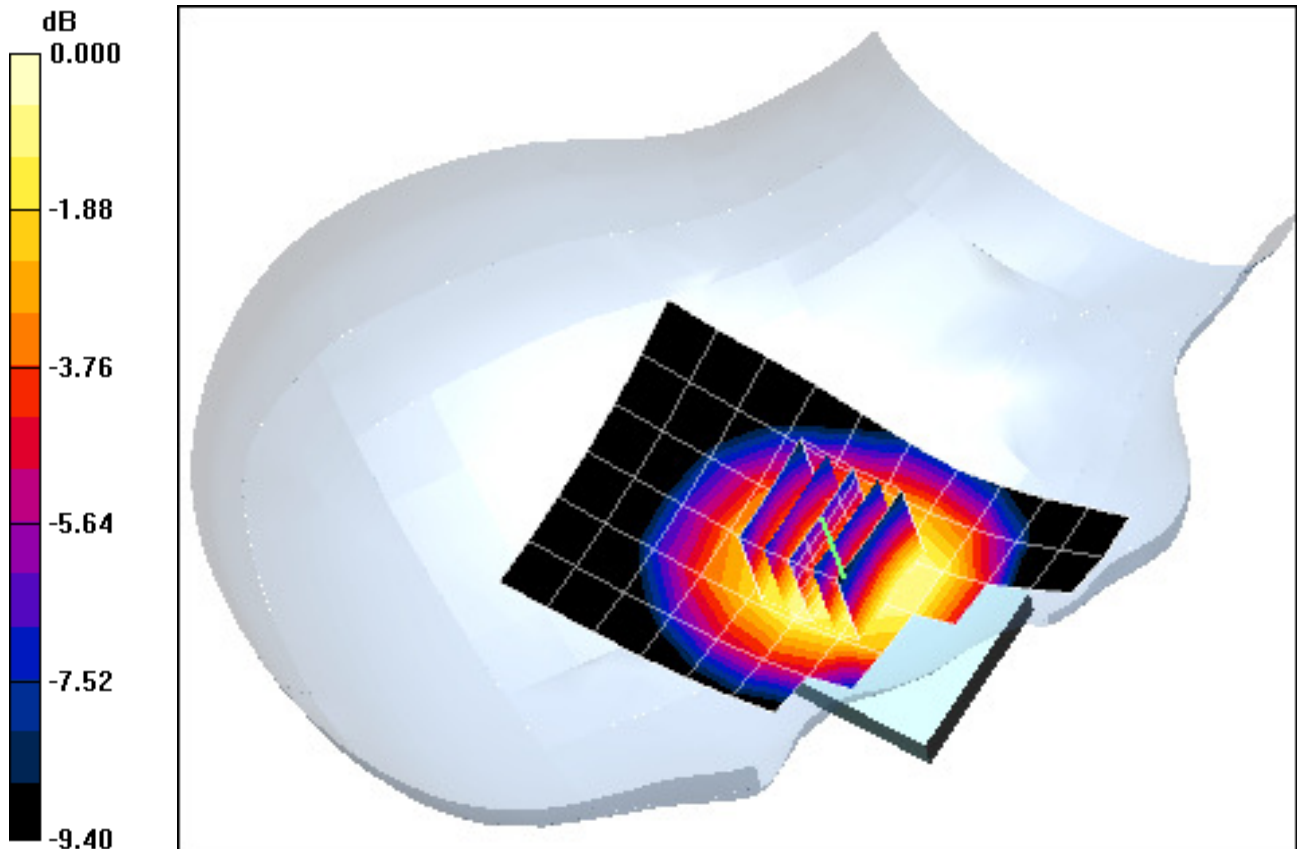

0 dB = 0.455mW/g

PCTEST ENGINEERING LABORATORY, INC.

**DUT: A3LGTS7230L; Type: 850/1900 GSM/GPRS/WCDMA/HSDPA Phone
with EDGE Rx, EDGE Rx, EDGE Rx, Bluetooth and WLAN; Serial: FH 254 B**

Communication System: GSM850; Frequency: 836.6 MHz; Duty Cycle: 1:8.3

Medium: 835 Brain; Medium parameters used (interpolated):

$f = 836.6 \text{ MHz}$; $\sigma = 0.886 \text{ mho/m}$; $\epsilon_r = 42.4$; $\rho = 1000 \text{ kg/m}^3$

Phantom section: Right Section

Test Date: 11-29-2010; Ambient Temp: 23.6 °C; Tissue Temp: 22.8 °C

Probe: EX3DV4 - SN3550; ConvF(8.28, 8.28, 8.28); Calibrated: 1/26/2010

Sensor-Surface: 4mm (Mechanical Surface Detection)

Electronics: DAE4 Sn649; Calibrated: 1/22/2010

Phantom: SAM Main; Type: SAM 4.0; Serial: TP-1114

Measurement SW: DASY4, V4.7 Build 80; Postprocessing SW: SEMCAD, V1.8 Build 186

Mode: GSM 850, Right Head, Touch, Mid.ch

Area Scan (7x11x1): Measurement grid: dx=15mm, dy=15mm

Zoom Scan (5x5x7)/Cube 0: Measurement grid: dx=8mm, dy=8mm, dz=5mm

Reference Value = 22.3 V/m

Peak SAR (extrapolated) = 0.546 W/kg

SAR(1 g) = 0.432 mW/g; SAR(10 g) = 0.322 mW/g

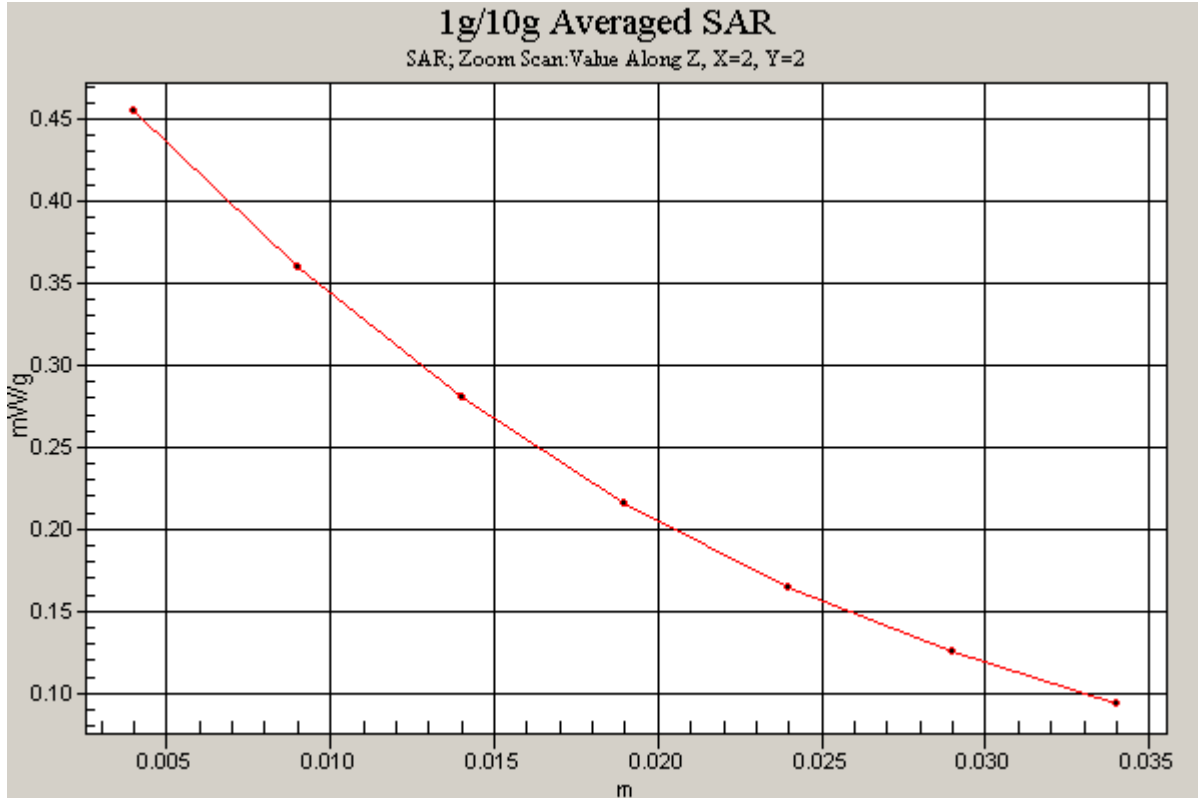

PCTEST ENGINEERING LABORATORY, INC.

**DUT: A3LGTS7230L; Type: 850/1900 GSM/GPRS/WCDMA/HSDPA Phone
with EDGE Rx, Bluetooth and WLAN; Serial: FH 254 B**

Communication System: GSM850; Frequency: 836.6 MHz; Duty Cycle: 1:8.3
Medium: 835 Brain; Medium parameters used (interpolated):
 $f = 836.6 \text{ MHz}$; $\sigma = 0.886 \text{ mho/m}$; $\epsilon_r = 42.4$; $\rho = 1000 \text{ kg/m}^3$
Phantom section: Right Section

Test Date: 11-29-2010; Ambient Temp: 23.6 °C; Tissue Temp: 22.8 °C

Probe: EX3DV4 - SN3550; ConvF(8.28, 8.28, 8.28); Calibrated: 1/26/2010
Sensor-Surface: 4mm (Mechanical Surface Detection)
Electronics: DAE4 Sn649; Calibrated: 1/22/2010
Phantom: SAM Main; Type: SAM 4.0; Serial: TP-1114
Measurement SW: DASY4, V4.7 Build 80; Postprocessing SW: SEMCAD, V1.8 Build 186

Mode: GSM 850, Right Head, Tilt, Mid.ch

Area Scan (7x11x1): Measurement grid: dx=15mm, dy=15mm
Zoom Scan (5x5x7)/Cube 0: Measurement grid: dx=8mm, dy=8mm, dz=5mm
Reference Value = 17.1 V/m
Peak SAR (extrapolated) = 0.330 W/kg
SAR(1 g) = 0.256 mW/g; SAR(10 g) = 0.188 mW/g

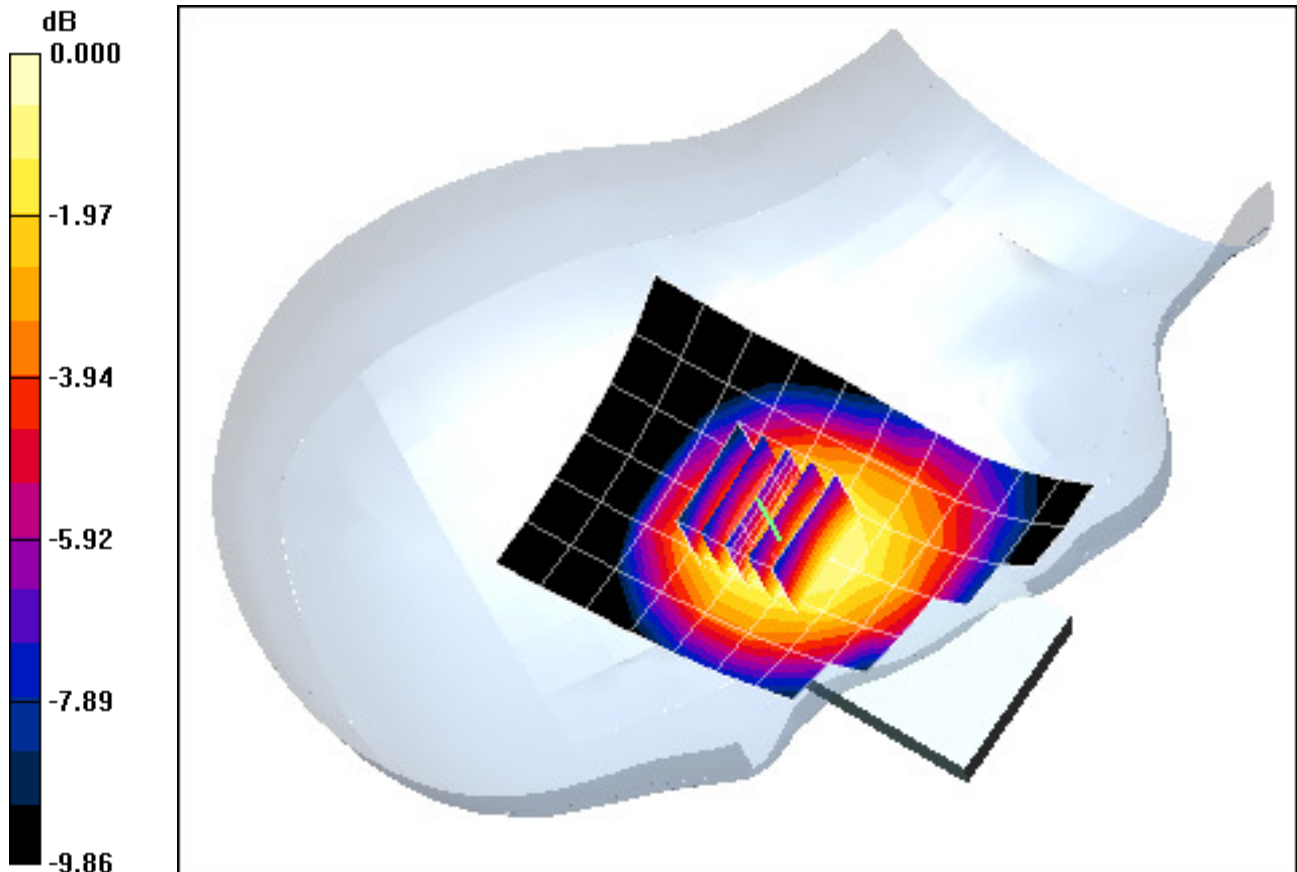

0 dB = 0.269mW/g

PCTEST ENGINEERING LABORATORY, INC.

**DUT: A3LGTS7230L; Type: 850/1900 GSM/GPRS/WCDMA/HSDPA Phone
with EDGE Rx, Bluetooth and WLAN; Serial: FH 254 B**

Communication System: GSM850; Frequency: 836.6 MHz; Duty Cycle: 1:8.3

Medium: 835 Brain; Medium parameters used (interpolated):

$f = 836.6 \text{ MHz}$; $\sigma = 0.886 \text{ mho/m}$; $\epsilon_r = 42.4$; $\rho = 1000 \text{ kg/m}^3$

Phantom section: Left Section

cTest Date: 11-29-2010; Ambient Temp: 23.6 °C; Tissue Temp: 22.8 °C

Probe: EX3DV4 - SN3550; ConvF(8.28, 8.28, 8.28); Calibrated: 1/26/2010

Sensor-Surface: 4mm (Mechanical Surface Detection)

Electronics: DAE4 Sn649; Calibrated: 1/22/2010

Phantom: SAM Main; Type: SAM 4.0; Serial: TP-1114

Measurement SW: DASY4, V4.7 Build 80; Postprocessing SW: SEMCAD, V1.8 Build 186

Mode: GSM 850, Left Head, Touch, Mid.ch

Area Scan (7x11x1): Measurement grid: dx=15mm, dy=15mm

Zoom Scan (5x5x7)/Cube 0: Measurement grid: dx=8mm, dy=8mm, dz=5mm

Reference Value = 21.4 V/m

Peak SAR (extrapolated) = 0.525 W/kg

SAR(1 g) = 0.407 mW/g; SAR(10 g) = 0.300 mW/g

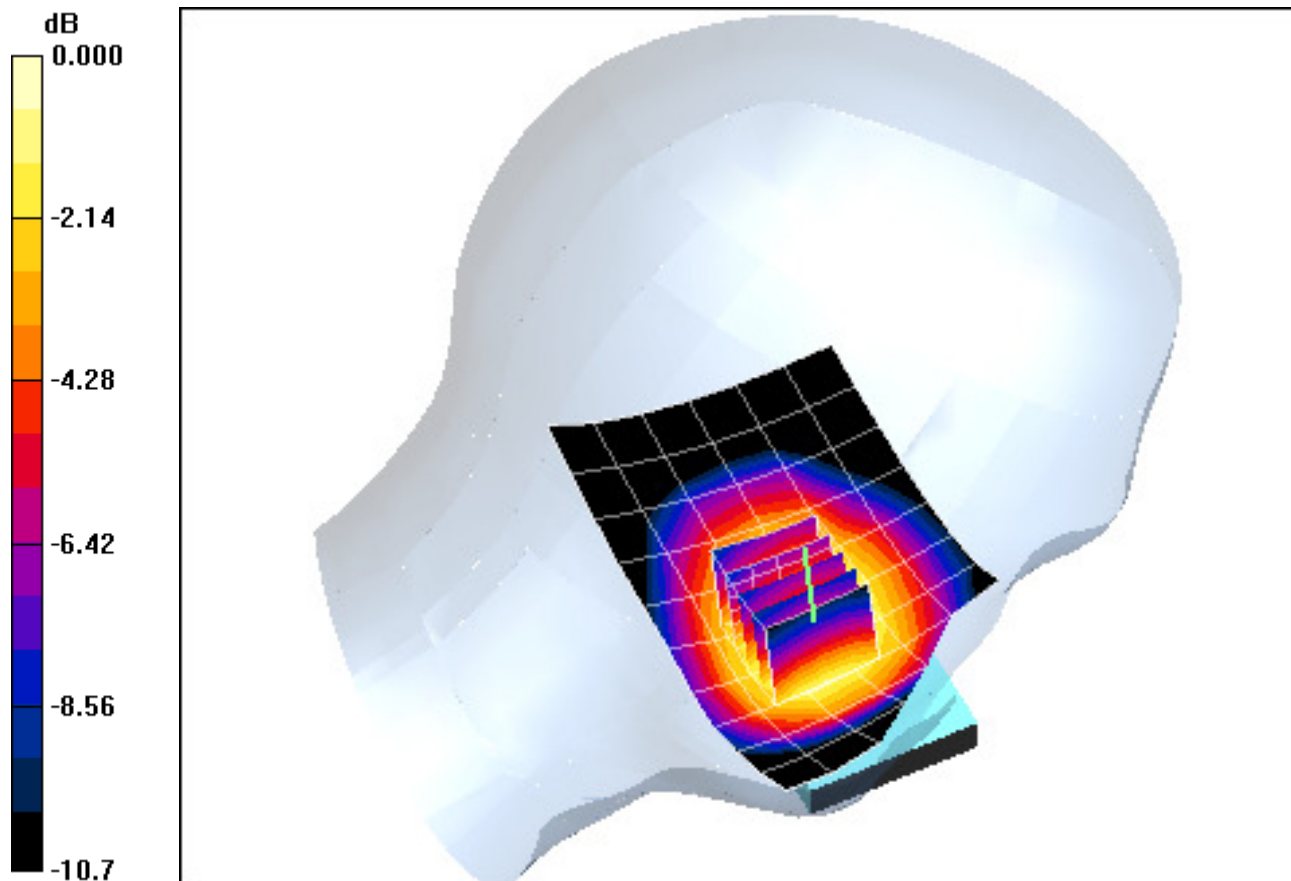

0 dB = 0.431mW/g

PCTEST ENGINEERING LABORATORY, INC.

**DUT: A3LGTS7230L; Type: 850/1900 GSM/GPRS/WCDMA/HSDPA Phone
with EDGE Rx, Bluetooth and WLAN; Serial: FH 254 B**

Communication System: GSM850; Frequency: 836.6 MHz; Duty Cycle: 1:8.3

Medium: 835 Brain; Medium parameters used (interpolated):

$f = 836.6 \text{ MHz}$; $\sigma = 0.886 \text{ mho/m}$; $\epsilon_r = 42.4$; $\rho = 1000 \text{ kg/m}^3$

Phantom section: Left Section

Test Date: 11-29-2010; Ambient Temp: 23.6 °C; Tissue Temp: 22.8 °C

Probe: EX3DV4 - SN3550; ConvF(8.28, 8.28, 8.28); Calibrated: 1/26/2010

Sensor-Surface: 4mm (Mechanical Surface Detection)

Electronics: DAE4 Sn649; Calibrated: 1/22/2010

Phantom: SAM Main; Type: SAM 4.0; Serial: TP-1114

Measurement SW: DASY4, V4.7 Build 80; Postprocessing SW: SEMCAD, V1.8 Build 186

Mode: GSM 850, Left Head, Tilt, Mid.ch

Area Scan (7x11x1): Measurement grid: dx=15mm, dy=15mm

Zoom Scan (5x5x7)/Cube 0: Measurement grid: dx=8mm, dy=8mm, dz=5mm

Reference Value = 15.8 V/m

Peak SAR (extrapolated) = 0.279 W/kg

SAR(1 g) = 0.213 mW/g; SAR(10 g) = 0.156 mW/g

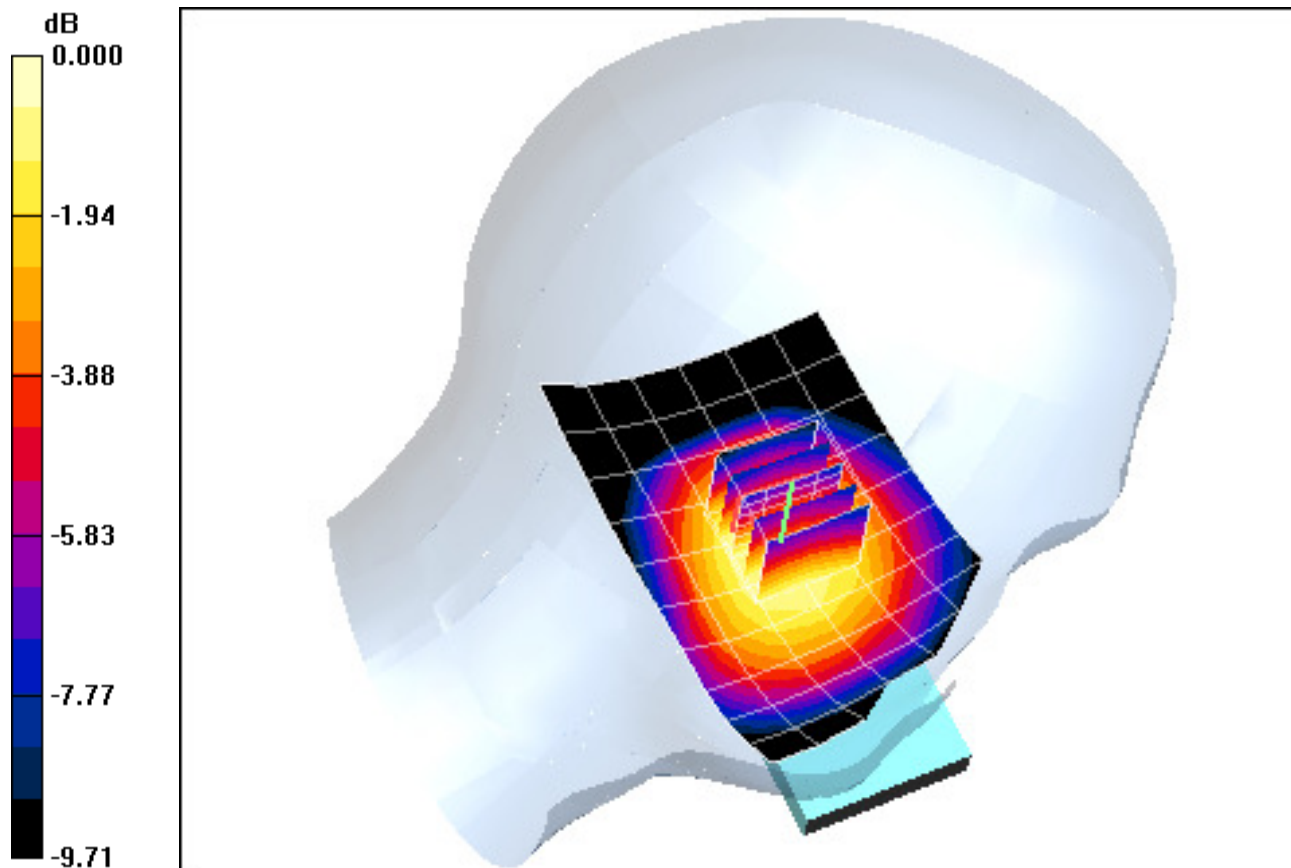

0 dB = 0.226mW/g

PCTEST ENGINEERING LABORATORY, INC.

**DUT: A3LGTS7230L; Type: 850/1900 GSM/GPRS/WCDMA/HSDPA Phone
with EDGE Rx, Bluetooth and WLAN; Serial: FH 254 B**

Communication System: GSM1900; Frequency: 1880 MHz; Duty Cycle: 1:8.3

Medium: 1900 Brain; Medium parameters used:

$f = 1880 \text{ MHz}$; $\sigma = 1.45 \text{ mho/m}$; $\epsilon_r = 40.6$; $\rho = 1000 \text{ kg/m}^3$

Phantom section: Right Section

Test Date: 12-01-2010; Ambient Temp: 23.9 °C; Tissue Temp: 22.3 °C

Probe: EX3DV4 - SN3550; ConvF(6.81, 6.81, 6.81); Calibrated: 1/26/2010

Sensor-Surface: 4mm (Mechanical Surface Detection)

Electronics: DAE4 Sn649; Calibrated: 1/22/2010

Phantom: SAM Main; Type: SAM 4.0; Serial: TP-1114

Measurement SW: DASY4, V4.7 Build 80; Postprocessing SW: SEMCAD, V1.8 Build 186

Mode: GSM 1900, Right Head, Touch, Mid.ch

Area Scan (7x11x1): Measurement grid: dx=15mm, dy=15mm

Zoom Scan (5x5x7)/Cube 0: Measurement grid: dx=8mm, dy=8mm, dz=5mm

Reference Value = 22.0 V/m

Peak SAR (extrapolated) = 1.07 W/kg

SAR(1 g) = 0.713 mW/g; SAR(10 g) = 0.450 mW/g

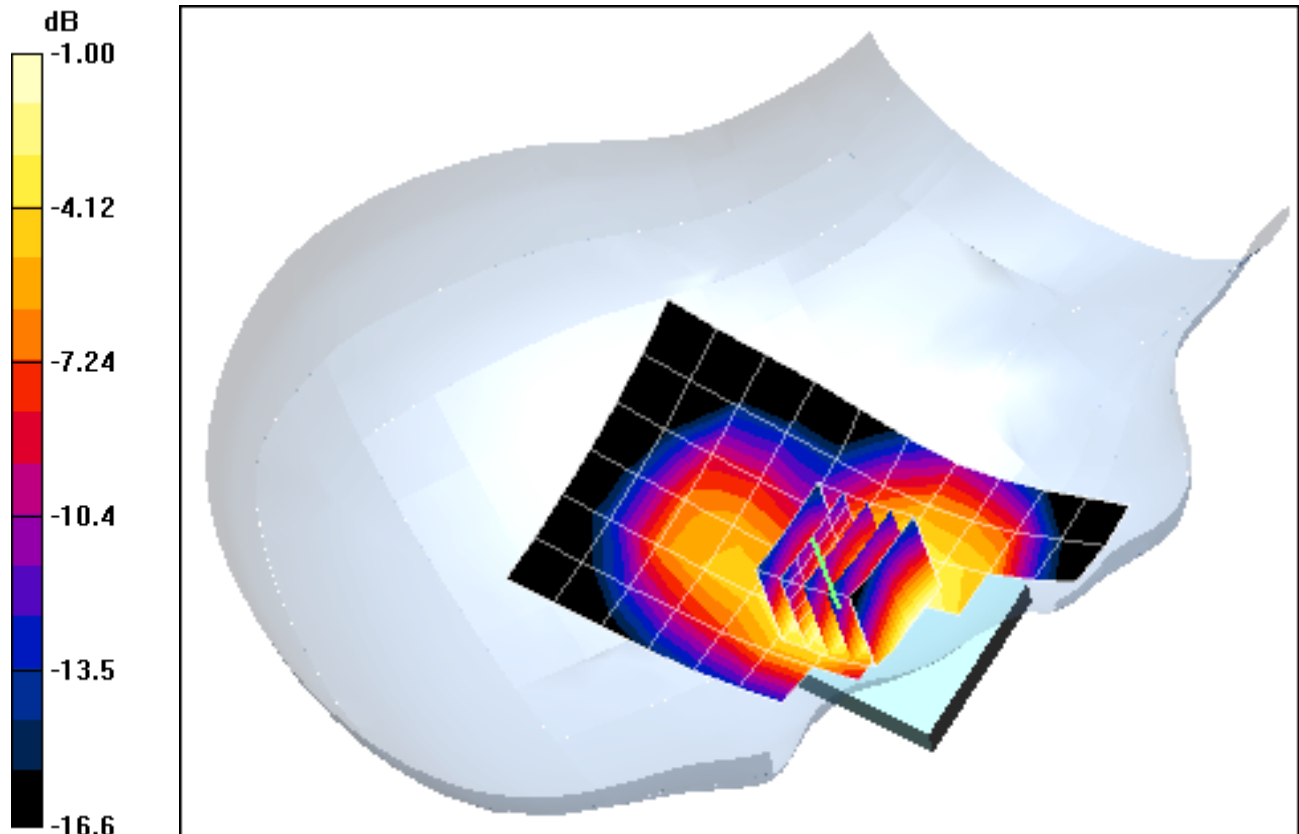

0 dB = 0.757mW/g

PCTEST ENGINEERING LABORATORY, INC.

**DUT: A3LGTS7230L; Type: 850/1900 GSM/GPRS/WCDMA/HSDPA Phone
with EDGE Rx, Bluetooth and WLAN; Serial: FH 254 B**

Communication System: GSM1900; Frequency: 1880 MHz; Duty Cycle: 1:8.3

Medium: 1900 Brain; Medium parameters used:

$f = 1880 \text{ MHz}$; $\sigma = 1.45 \text{ mho/m}$; $\epsilon_r = 40.6$; $\rho = 1000 \text{ kg/m}^3$

Phantom section: Right Section

Test Date: 12-01-2010; Ambient Temp: 23.9 °C; Tissue Temp: 22.3 °C

Probe: EX3DV4 - SN3550; ConvF(6.81, 6.81, 6.81); Calibrated: 1/26/2010

Sensor-Surface: 4mm (Mechanical Surface Detection)

Electronics: DAE4 Sn649; Calibrated: 1/22/2010

Phantom: SAM Main; Type: SAM 4.0; Serial: TP-1114

Measurement SW: DASY4, V4.7 Build 80; Postprocessing SW: SEMCAD, V1.8 Build 186

Mode: GSM 1900, Right Head, Tilt, Mid.ch

Area Scan (7x11x1): Measurement grid: dx=15mm, dy=15mm

Zoom Scan (5x5x7)/Cube 0: Measurement grid: dx=8mm, dy=8mm, dz=5mm

Reference Value = 17.1 V/m

Peak SAR (extrapolated) = 0.621 W/kg

SAR(1 g) = 0.392 mW/g; SAR(10 g) = 0.228 mW/g

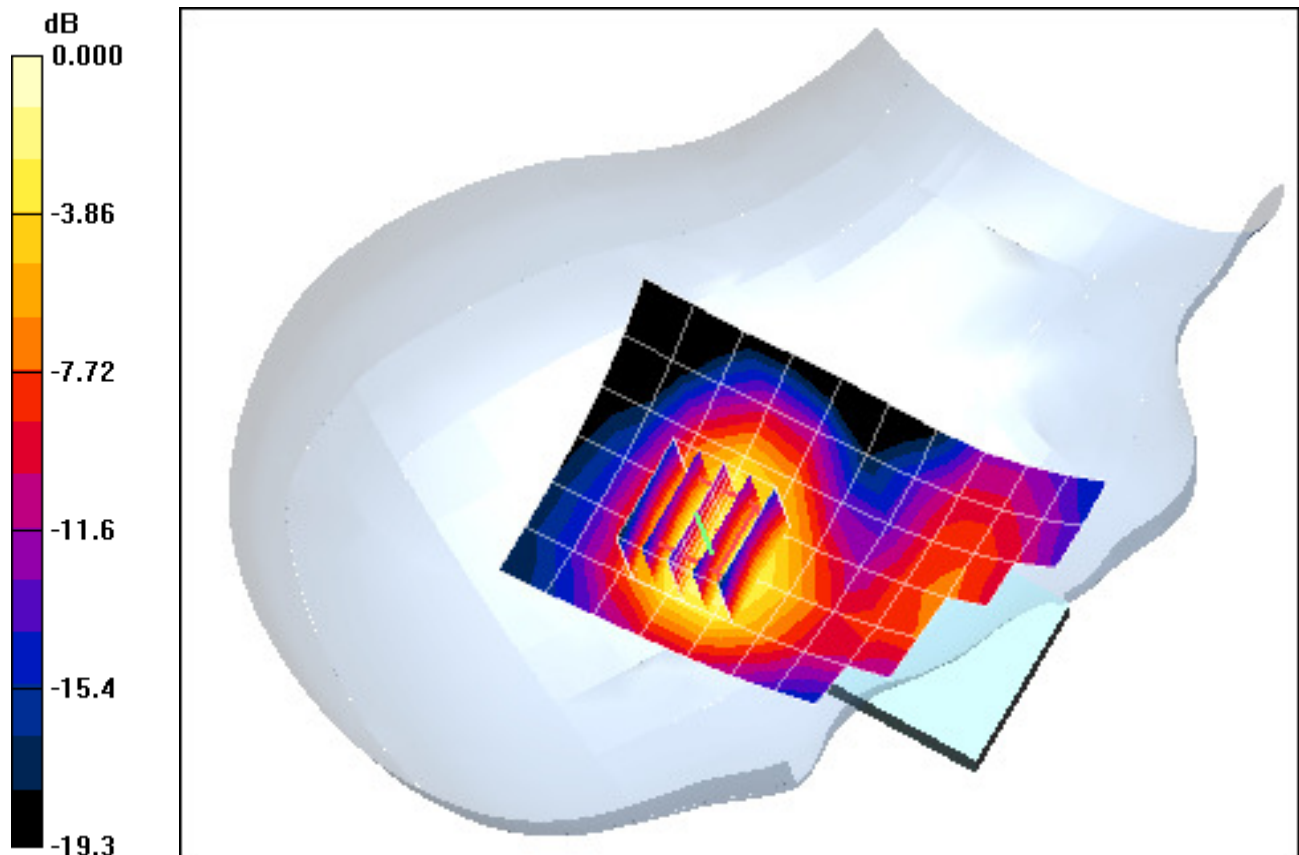

0 dB = 0.424mW/g

PCTEST ENGINEERING LABORATORY, INC.

**DUT: A3LGTS7230L; Type: 850/1900 GSM/GPRS/WCDMA/HSDPA Phone
with EDGE Rx, Bluetooth and WLAN; Serial: FH 254 B**

Communication System: GSM1900; Frequency: 1880 MHz; Duty Cycle: 1:8.3

Medium: 1900 Brain; Medium parameters used:

$f = 1880 \text{ MHz}$; $\sigma = 1.45 \text{ mho/m}$; $\epsilon_r = 40.6$; $\rho = 1000 \text{ kg/m}^3$

Phantom section: Left Section

Test Date: 12-01-2010; Ambient Temp: 23.9 °C; Tissue Temp: 22.3 °C

Probe: EX3DV4 - SN3550; ConvF(6.81, 6.81, 6.81); Calibrated: 1/26/2010

Sensor-Surface: 4mm (Mechanical Surface Detection)

Electronics: DAE4 Sn649; Calibrated: 1/22/2010

Phantom: SAM Main; Type: SAM 4.0; Serial: TP-1114

Measurement SW: DASY4, V4.7 Build 80; Postprocessing SW: SEMCAD, V1.8 Build 186

Mode: GSM 1900, Left Head, Touch, Mid.ch

Area Scan (7x11x1): Measurement grid: dx=15mm, dy=15mm

Zoom Scan (5x5x7)/Cube 0: Measurement grid: dx=8mm, dy=8mm, dz=5mm

Reference Value = 25.1 V/m

Peak SAR (extrapolated) = 1.41 W/kg

SAR(1 g) = 0.889 mW/g; SAR(10 g) = 0.511 mW/g

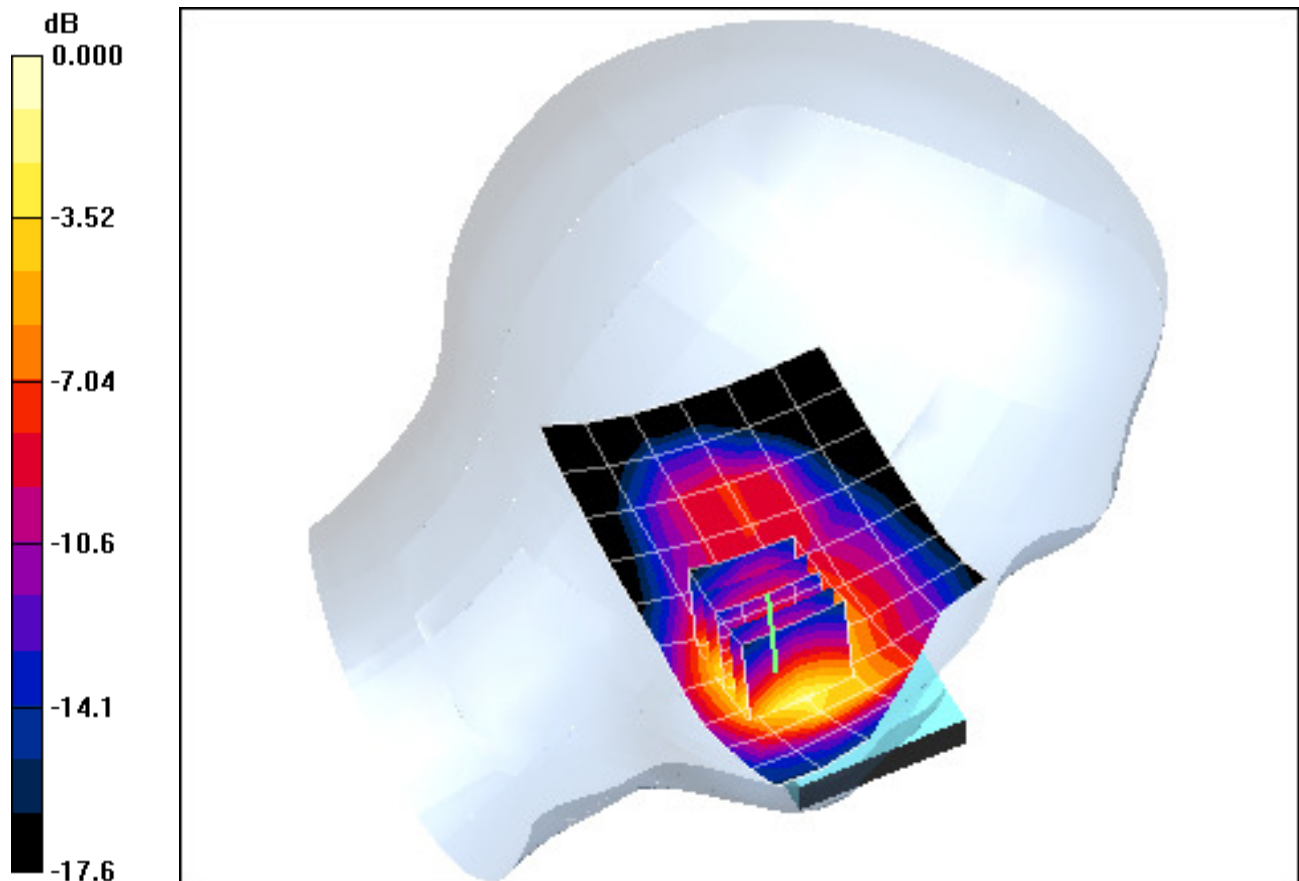

0 dB = 0.974mW/g

PCTEST ENGINEERING LABORATORY, INC.

**DUT: A3LGTS7230L; Type: 850/1900 GSM/GPRS/WCDMA/HSDPA Phone
with EDGE Rx, Bluetooth and WLAN; Serial: FH 254 B**

Communication System: GSM1900; Frequency: 1880 MHz; Duty Cycle: 1:8.3

Medium: 1900 Brain; Medium parameters used:

$f = 1880 \text{ MHz}$; $\sigma = 1.45 \text{ mho/m}$; $\epsilon_r = 40.6$; $\rho = 1000 \text{ kg/m}^3$

Phantom section: Left Section

Test Date: 12-01-2010; Ambient Temp: 23.9 °C; Tissue Temp: 22.3 °C

Probe: EX3DV4 - SN3550; ConvF(6.81, 6.81, 6.81); Calibrated: 1/26/2010

Sensor-Surface: 4mm (Mechanical Surface Detection)

Electronics: DAE4 Sn649; Calibrated: 1/22/2010

Phantom: SAM Main; Type: SAM 4.0; Serial: TP-1114

Measurement SW: DASY4, V4.7 Build 80; Postprocessing SW: SEMCAD, V1.8 Build 186

Mode: GSM 1900, Left Head, Tilt, Mid.ch

Area Scan (7x11x1): Measurement grid: dx=15mm, dy=15mm

Zoom Scan (5x5x7)/Cube 0: Measurement grid: dx=8mm, dy=8mm, dz=5mm

Reference Value = 14.5 V/m

Peak SAR (extrapolated) = 0.468 W/kg

SAR(1 g) = 0.300 mW/g; SAR(10 g) = 0.183 mW/g

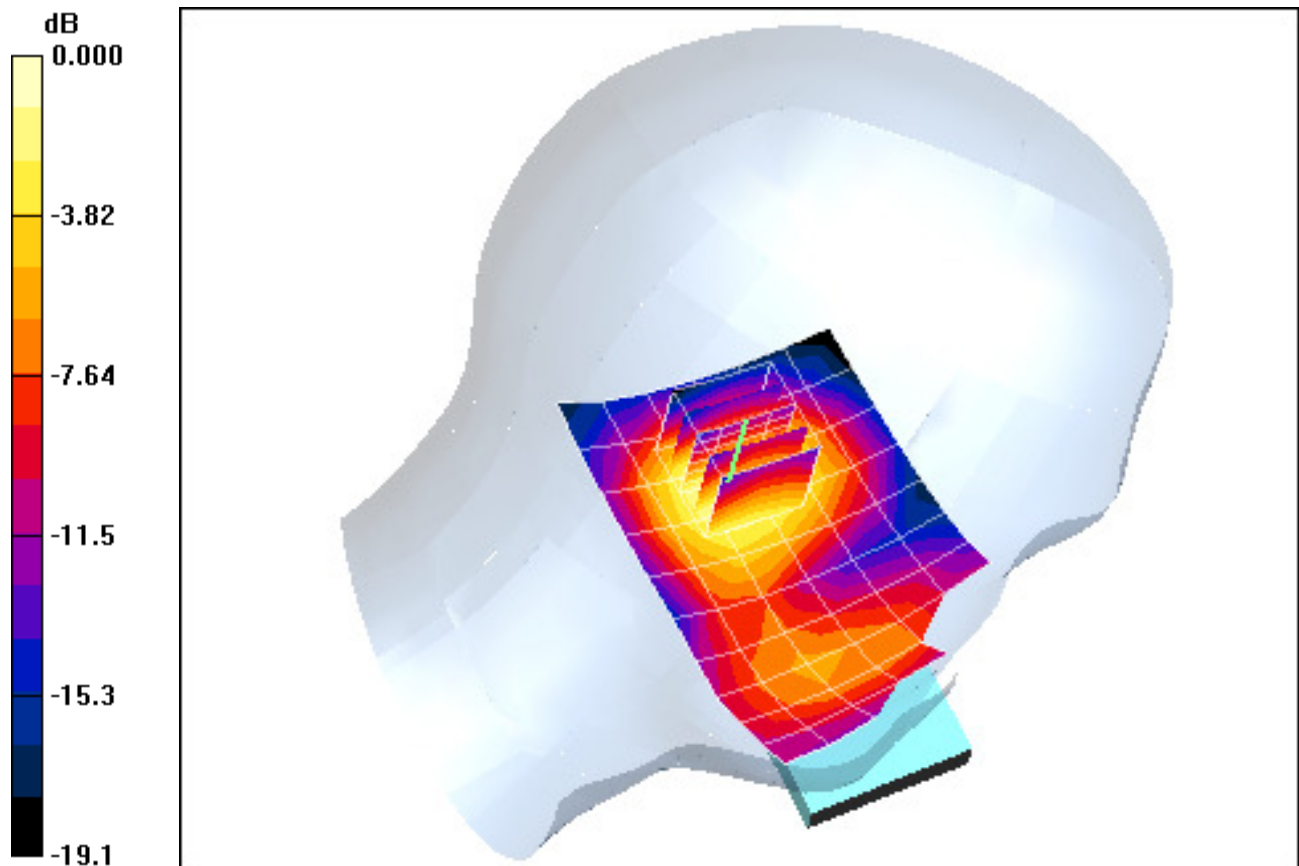

0 dB = 0.324mW/g

PCTEST ENGINEERING LABORATORY, INC.

**DUT: A3LGTS7230L; Type: 850/1900 GSM/GPRS/WCDMA/HSDPA Phone
with EDGE Rx, Bluetooth and WLAN; Serial: FH 254 B**

Communication System: WCDMA850; Frequency: 836.6 MHz; Duty Cycle: 1:1

Medium: 835 Brain; Medium parameters used (interpolated):

$f = 836.6 \text{ MHz}$; $\sigma = 0.886 \text{ mho/m}$; $\epsilon_r = 42.4$; $\rho = 1000 \text{ kg/m}^3$

Phantom section: Right Section

Test Date: 11-29-2010; Ambient Temp: 23.6 °C; Tissue Temp: 22.8 °C

Probe: EX3DV4 - SN3550; ConvF(8.28, 8.28, 8.28); Calibrated: 1/26/2010

Sensor-Surface: 4mm (Mechanical Surface Detection)

Electronics: DAE4 Sn649; Calibrated: 1/22/2010

Phantom: SAM Main; Type: SAM 4.0; Serial: TP-1114

Measurement SW: DASY4, V4.7 Build 80; Postprocessing SW: SEMCAD, V1.8 Build 186

Mode: WCDMA 850, Right Head, Touch, Mid.ch

Area Scan (7x11x1): Measurement grid: dx=15mm, dy=15mm

Zoom Scan (5x5x7)/Cube 0: Measurement grid: dx=8mm, dy=8mm, dz=5mm

Reference Value = 17.5 V/m

Peak SAR (extrapolated) = 0.333 W/kg

SAR(1 g) = 0.263 mW/g; SAR(10 g) = 0.195 mW/g

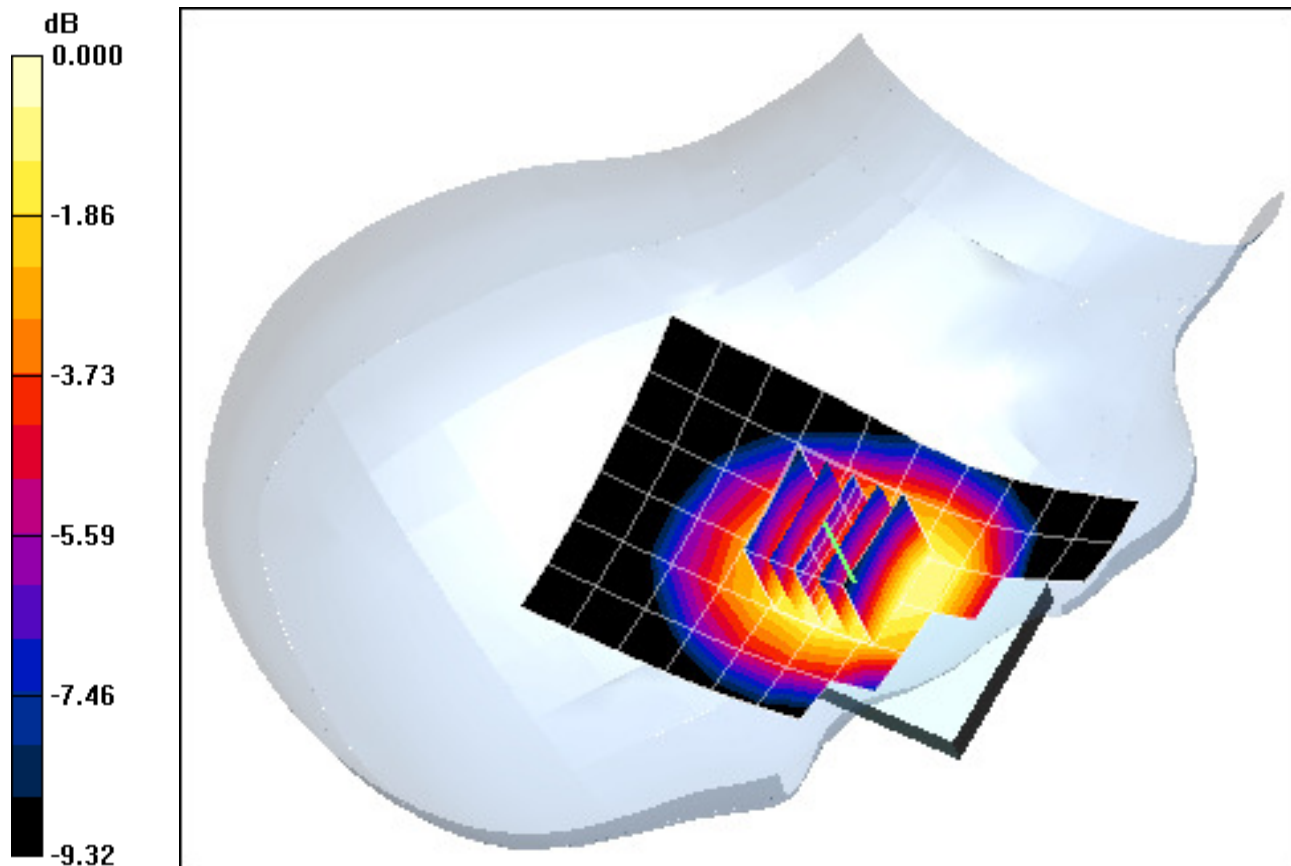

0 dB = 0.276mW/g

PCTEST ENGINEERING LABORATORY, INC.

DUT: A3LGTS7230L; Type: 850/1900 GSM/GPRS/WCDMA/HSDPA Phone with EDGE Rx, Bluetooth and WLAN; Serial: FH 254 B

Communication System: WCDMA850; Frequency: 836.6 MHz; Duty Cycle: 1:1

Medium: 835 Brain; Medium parameters used (interpolated):

$f = 836.6 \text{ MHz}$; $\sigma = 0.886 \text{ mho/m}$; $\epsilon_r = 42.4$; $\rho = 1000 \text{ kg/m}^3$

Phantom section: Right Section

Test Date: 11-29-2010; Ambient Temp: 23.6 °C; Tissue Temp: 22.8 °C

Probe: EX3DV4 - SN3550; ConvF(8.28, 8.28, 8.28); Calibrated: 1/26/2010

Sensor-Surface: 4mm (Mechanical Surface Detection)

Electronics: DAE4 Sn649; Calibrated: 1/22/2010

Phantom: SAM Main; Type: SAM 4.0; Serial: TP-1114

Measurement SW: DASY4, V4.7 Build 80; Postprocessing SW: SEMCAD, V1.8 Build 186

Mode: WCDMA 850, Right Head, Tilt, Mid.ch

Area Scan (7x11x1): Measurement grid: dx=15mm, dy=15mm

Zoom Scan (5x5x7)/Cube 0: Measurement grid: dx=8mm, dy=8mm, dz=5mm

Reference Value = 13.7 V/m

Peak SAR (extrapolated) = 0.216 W/kg

SAR(1 g) = 0.168 mW/g; SAR(10 g) = 0.123 mW/g

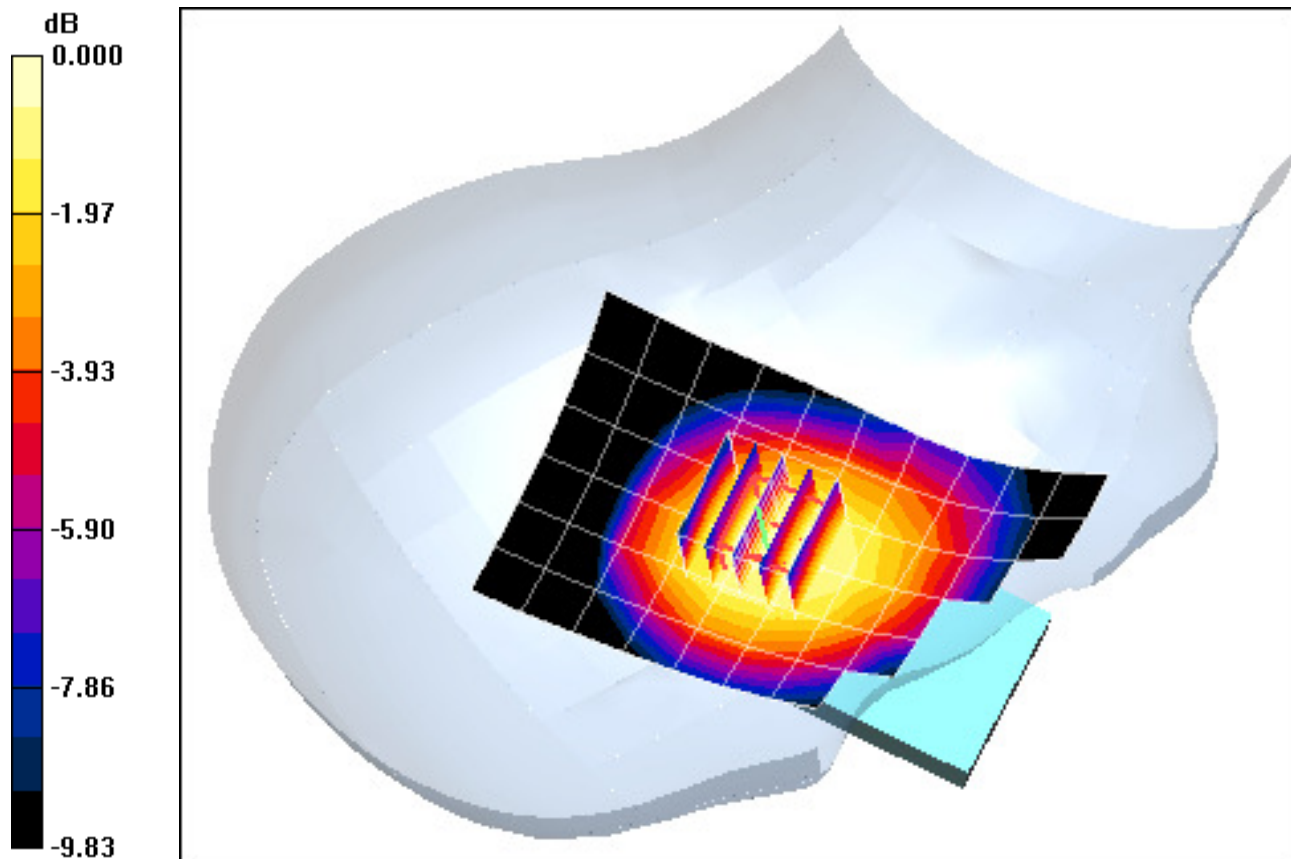

0 dB = 0.177mW/g

PCTEST ENGINEERING LABORATORY, INC.

**DUT: A3LGTS7230L; Type: 850/1900 GSM/GPRS/WCDMA/HSDPA Phone
with EDGE Rx, Bluetooth and WLAN; Serial: FH 254 B**

Communication System: WCDMA850; Frequency: 836.6 MHz; Duty Cycle: 1:1

Medium: 835 Brain; Medium parameters used (interpolated):

$f = 836.6 \text{ MHz}$; $\sigma = 0.886 \text{ mho/m}$; $\epsilon_r = 42.4$; $\rho = 1000 \text{ kg/m}^3$

Phantom section: Left Section

Test Date: 11-29-2010; Ambient Temp: 23.6 °C; Tissue Temp: 22.8 °C

Probe: EX3DV4 - SN3550; ConvF(8.28, 8.28, 8.28); Calibrated: 1/26/2010

Sensor-Surface: 4mm (Mechanical Surface Detection)

Electronics: DAE4 Sn649; Calibrated: 1/22/2010

Phantom: SAM Main; Type: SAM 4.0; Serial: TP-1114

Measurement SW: DASY4, V4.7 Build 80; Postprocessing SW: SEMCAD, V1.8 Build 186

Mode: WCDMA 850, Left Head, Touch, Mid.ch

Area Scan (7x11x1): Measurement grid: dx=15mm, dy=15mm

Zoom Scan (5x5x7)/Cube 0: Measurement grid: dx=8mm, dy=8mm, dz=5mm

Reference Value = 16.9 V/m

Peak SAR (extrapolated) = 0.311 W/kg

SAR(1 g) = 0.244 mW/g; SAR(10 g) = 0.180 mW/g

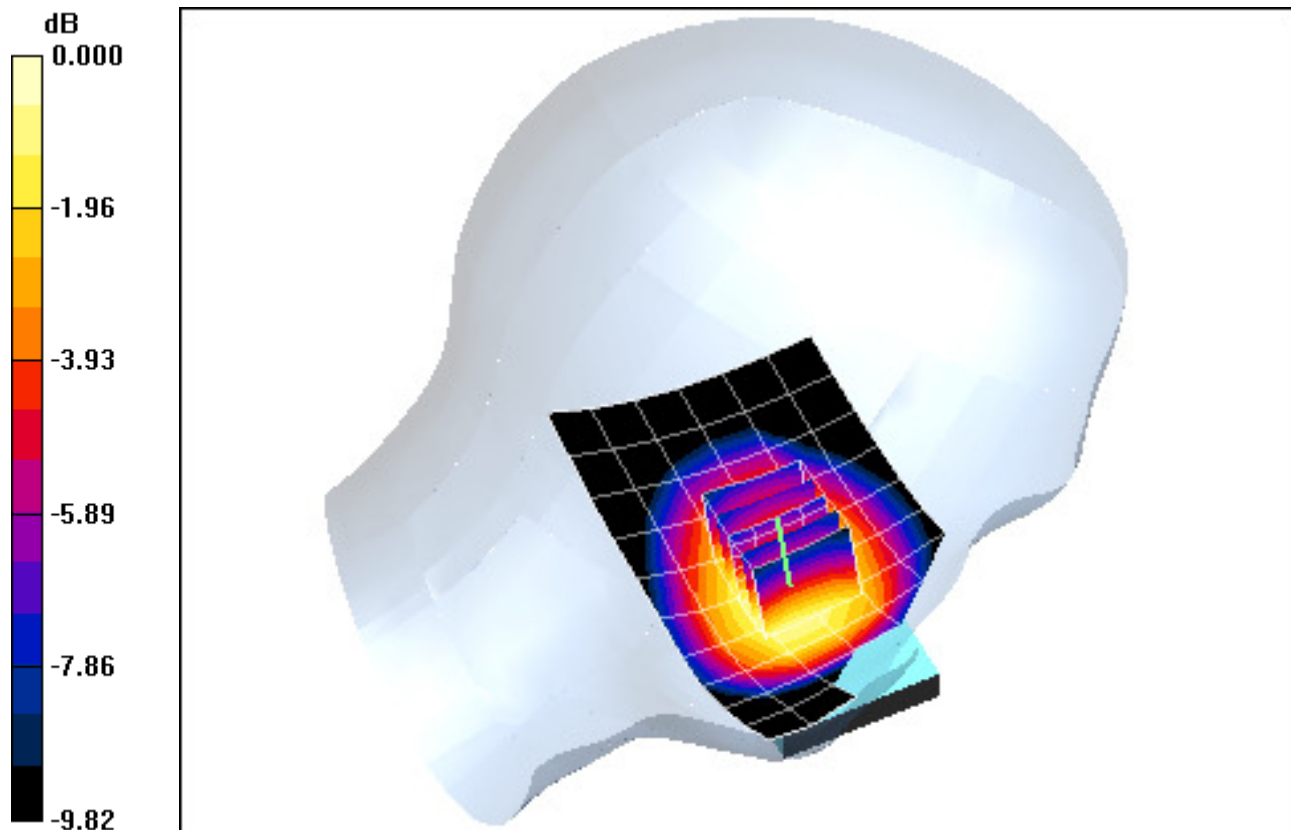

0 dB = 0.258mW/g

PCTEST ENGINEERING LABORATORY, INC.

**DUT: A3LGTS7230L; Type: 850/1900 GSM/GPRS/WCDMA/HSDPA Phone
with EDGE Rx, Bluetooth and WLAN; Serial: FH 254 B**

Communication System: WCDMA850; Frequency: 836.6 MHz; Duty Cycle: 1:1
Medium: 835 Brain; Medium parameters used (interpolated):
 $f = 836.6 \text{ MHz}$; $\sigma = 0.886 \text{ mho/m}$; $\epsilon_r = 42.4$; $\rho = 1000 \text{ kg/m}^3$
Phantom section: Left Section

Test Date: 11-29-2010; Ambient Temp: 23.6 °C; Tissue Temp: 22.8 °C

Probe: EX3DV4 - SN3550; ConvF(8.28, 8.28, 8.28); Calibrated: 1/26/2010
Sensor-Surface: 4mm (Mechanical Surface Detection)
Electronics: DAE4 Sn649; Calibrated: 1/22/2010
Phantom: SAM Main; Type: SAM 4.0; Serial: TP-1114
Measurement SW: DASY4, V4.7 Build 80; Postprocessing SW: SEMCAD, V1.8 Build 186

Mode: WCDMA 850, Left Head, Tilt, Mid.ch

Area Scan (7x11x1): Measurement grid: dx=15mm, dy=15mm
Zoom Scan (5x5x7)/Cube 0: Measurement grid: dx=8mm, dy=8mm, dz=5mm
Reference Value = 13.1 V/m
Peak SAR (extrapolated) = 0.196 W/kg
SAR(1 g) = 0.151 mW/g; SAR(10 g) = 0.111 mW/g

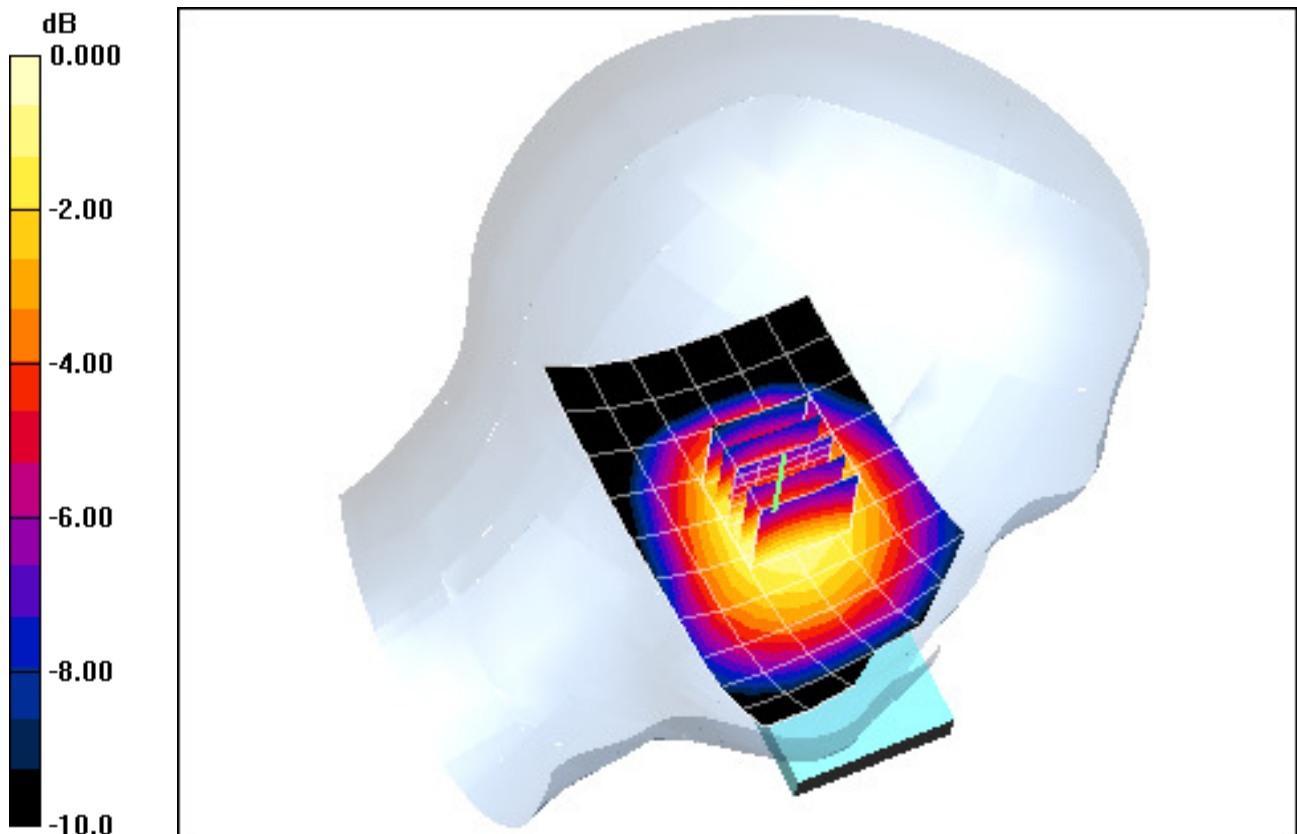

0 dB = 0.159mW/g

PCTEST ENGINEERING LABORATORY, INC.

**DUT: A3LGTS7230L; Type: 850/1900 GSM/GPRS/WCDMA/HSDPA Phone
with EDGE Rx, Bluetooth and WLAN; Serial: FH 254 B**

Communication System: WCDMA1900; Frequency: 1880 MHz; Duty Cycle: 1:1
Medium: 1900 Brain; Medium parameters used:

$$f = 1880 \text{ MHz}; \sigma = 1.45 \text{ mho/m}; \epsilon_r = 40.6; \rho = 1000 \text{ kg/m}^3$$

Phantom section: Right Section

Test Date: 12-01-2010; Ambient Temp: 23.9 °C; Tissue Temp: 22.3 °C

Probe: EX3DV4 - SN3550; ConvF(6.81, 6.81, 6.81); Calibrated: 1/26/2010

Sensor-Surface: 4mm (Mechanical Surface Detection)

Electronics: DAE4 Sn649; Calibrated: 1/22/2010

Phantom: SAM Main; Type: SAM 4.0; Serial: TP-1114

Measurement SW: DASY4, V4.7 Build 80; Postprocessing SW: SEMCAD, V1.8 Build 186

Mode: WCDMA 1900, Right Head, Touch, Mid.ch

Area Scan (7x11x1): Measurement grid: dx=15mm, dy=15mm

Zoom Scan (5x5x7)/Cube 0: Measurement grid: dx=8mm, dy=8mm, dz=5mm

Reference Value = 24.0 V/m

Peak SAR (extrapolated) = 1.16 W/kg

SAR(1 g) = 0.782 mW/g; SAR(10 g) = 0.505 mW/g

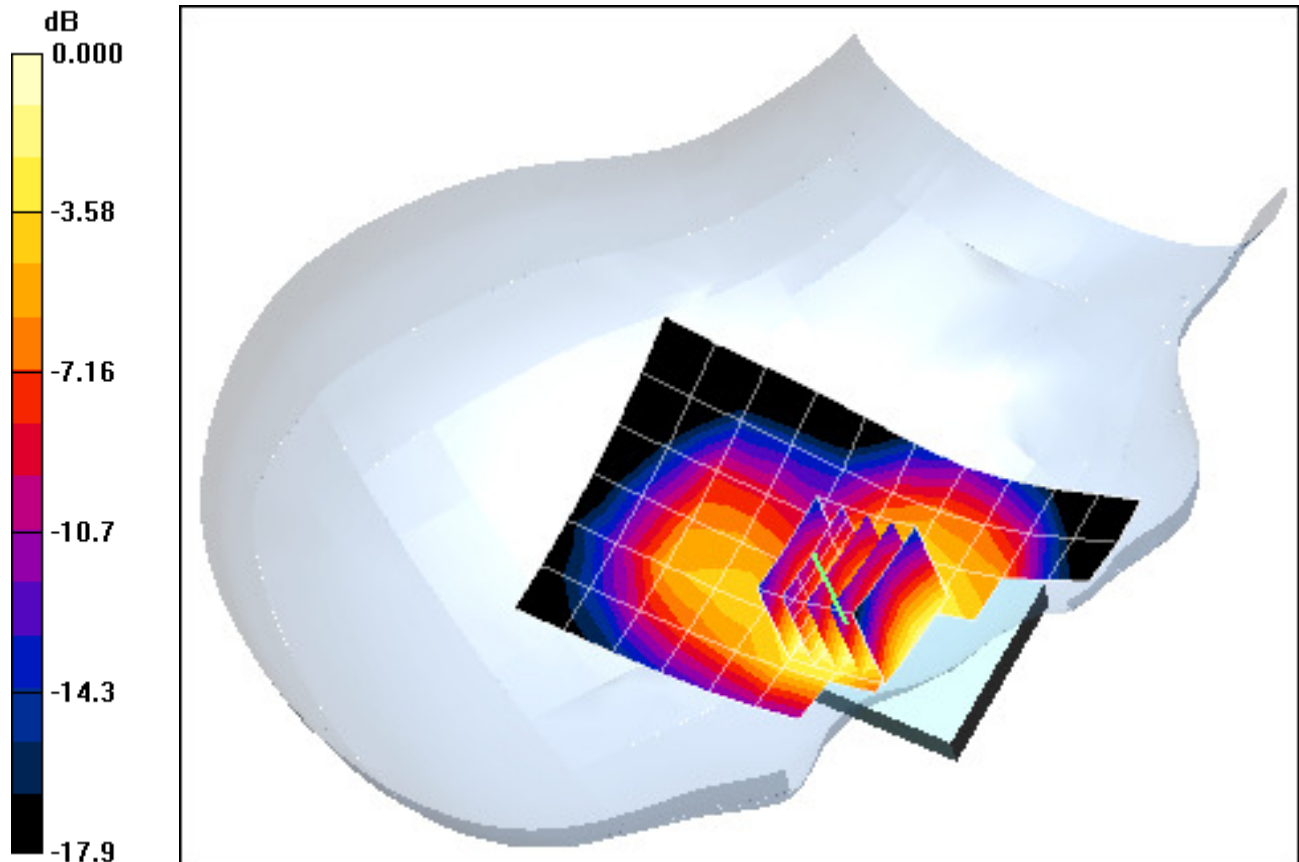

0 dB = 0.816mW/g

PCTEST ENGINEERING LABORATORY, INC.

**DUT: A3LGTS7230L; Type: 850/1900 GSM/GPRS/WCDMA/HSDPA Phone
with EDGE Rx, Bluetooth and WLAN; Serial: FH 254 B**

Communication System: WCDMA1900; Frequency: 1880 MHz; Duty Cycle: 1:1
Medium: 1900 Brain; Medium parameters used:

$$f = 1880 \text{ MHz}; \sigma = 1.45 \text{ mho/m}; \epsilon_r = 40.6; \rho = 1000 \text{ kg/m}^3$$

Phantom section: Right Section

Test Date: 12-01-2010; Ambient Temp: 23.9 °C; Tissue Temp: 22.3 °C

Probe: EX3DV4 - SN3550; ConvF(6.81, 6.81, 6.81); Calibrated: 1/26/2010

Sensor-Surface: 4mm (Mechanical Surface Detection)

Electronics: DAE4 Sn649; Calibrated: 1/22/2010

Phantom: SAM Main; Type: SAM 4.0; Serial: TP-1114

Measurement SW: DASY4, V4.7 Build 80; Postprocessing SW: SEMCAD, V1.8 Build 186

Mode: WCDMA 1900, Right Head, Tilt, Mid.ch

Area Scan (7x11x1): Measurement grid: dx=15mm, dy=15mm

Zoom Scan (5x5x7)/Cube 0: Measurement grid: dx=8mm, dy=8mm, dz=5mm

Reference Value = 18.1 V/m

Peak SAR (extrapolated) = 0.672 W/kg

SAR(1 g) = 0.434 mW/g; SAR(10 g) = 0.258 mW/g

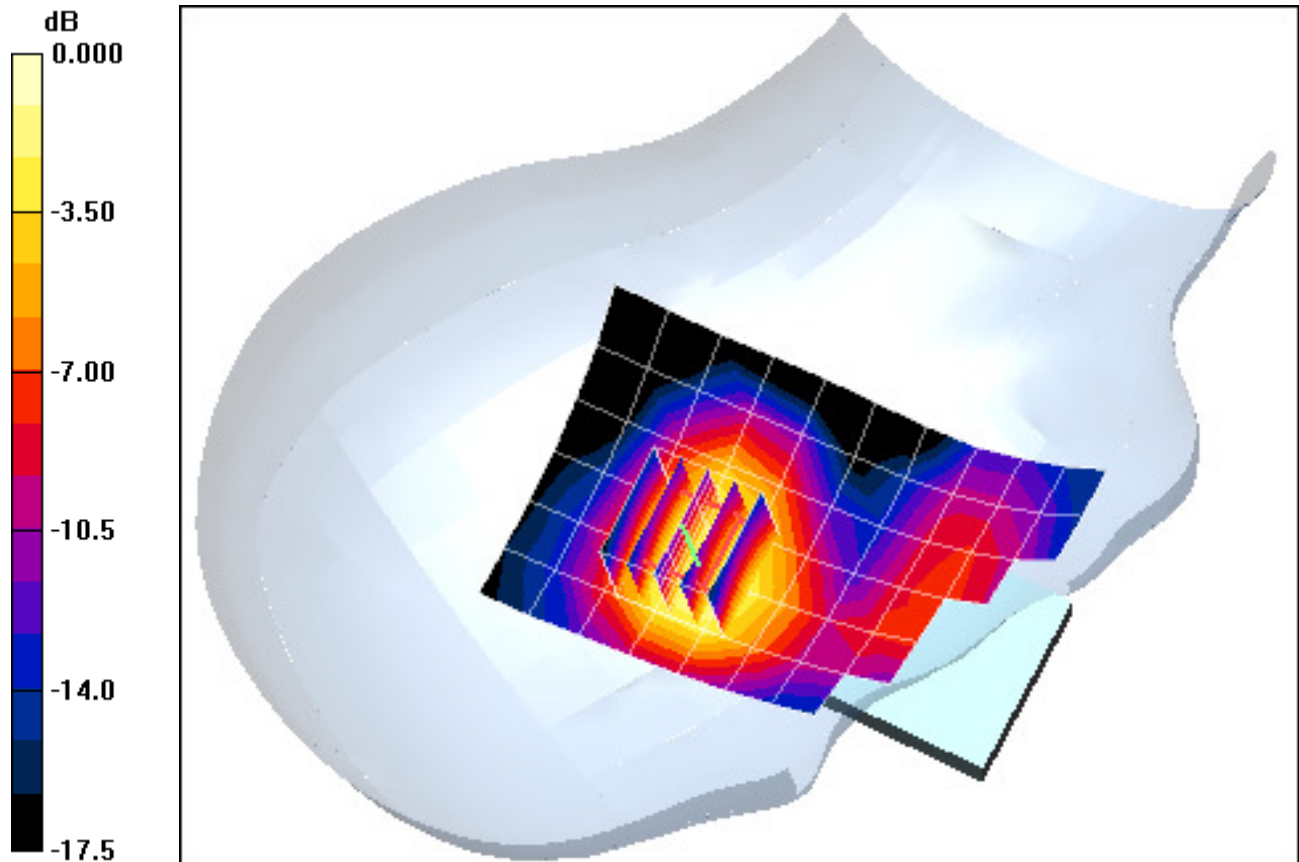

0 dB = 0.466mW/g

PCTEST ENGINEERING LABORATORY, INC.

**DUT: A3LGTS7230L; Type: 850/1900 GSM/GPRS/WCDMA/HSDPA Phone
with EDGE Rx, Bluetooth and WLAN; Serial: FH 254 B**

Communication System: WCDMA1900; Frequency: 1880 MHz; Duty Cycle: 1:1
Medium: 1900 Brain; Medium parameters used:

$$f = 1880 \text{ MHz}; \sigma = 1.45 \text{ mho/m}; \epsilon_r = 40.6; \rho = 1000 \text{ kg/m}^3$$

Phantom section: Left Section

Test Date: 12-01-2010; Ambient Temp: 23.9 °C; Tissue Temp: 22.3 °C

Probe: EX3DV4 - SN3550; ConvF(6.81, 6.81, 6.81); Calibrated: 1/26/2010

Sensor-Surface: 4mm (Mechanical Surface Detection)

Electronics: DAE4 Sn649; Calibrated: 1/22/2010

Phantom: SAM Main; Type: SAM 4.0; Serial: TP-1114

Measurement SW: DASY4, V4.7 Build 80; Postprocessing SW: SEMCAD, V1.8 Build 186

Mode: WCDMA 1900, Left Head, Touch, Mid.ch

Area Scan (7x11x1): Measurement grid: dx=15mm, dy=15mm

Zoom Scan (5x5x7)/Cube 0: Measurement grid: dx=8mm, dy=8mm, dz=5mm

Reference Value = 28.3 V/m

Peak SAR (extrapolated) = 1.69 W/kg

SAR(1 g) = 1.06 mW/g; SAR(10 g) = 0.611 mW/g

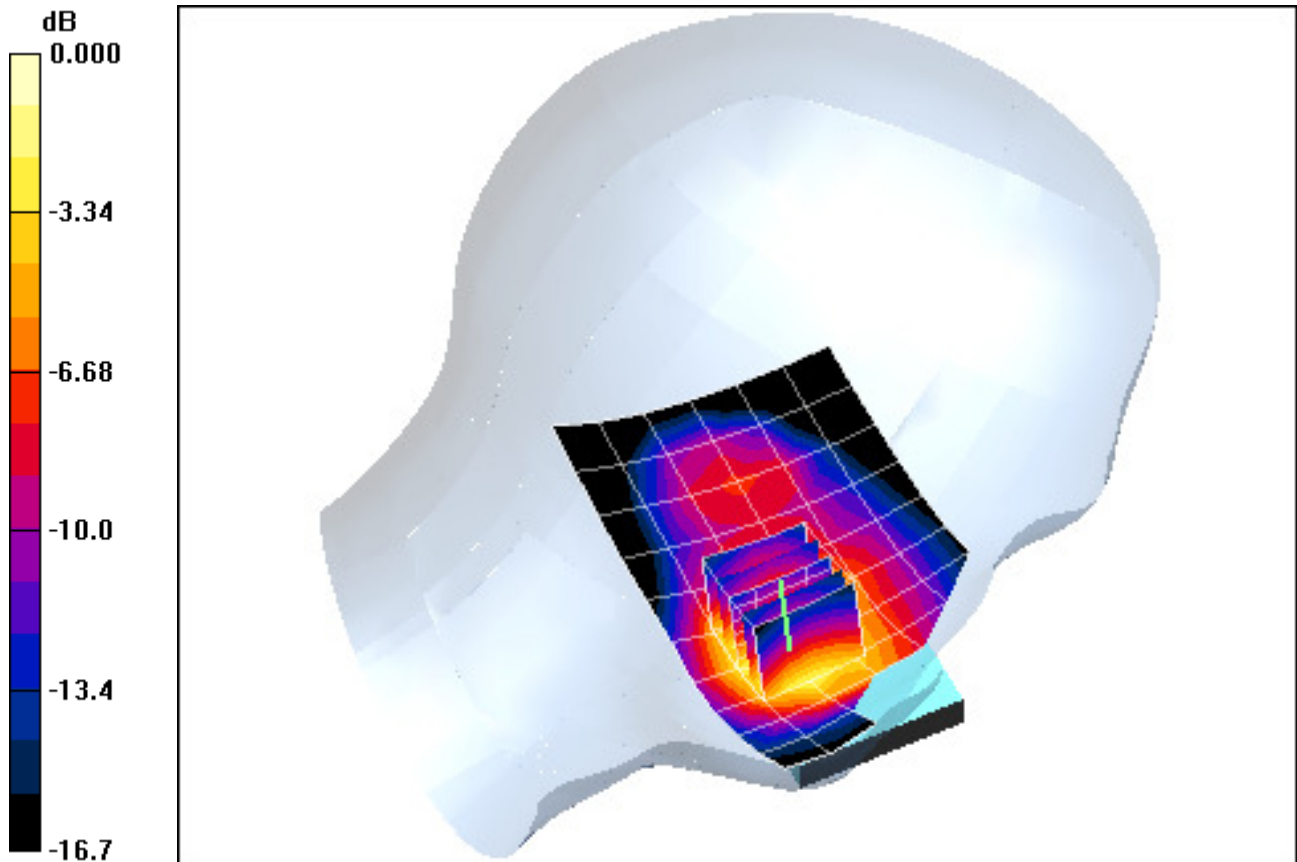

0 dB = 1.12mW/g

PCTEST ENGINEERING LABORATORY, INC.

**DUT: A3LGTS7230L; Type: 850/1900 GSM/GPRS/WCDMA/HSDPA Phone
with EDGE Rx, Bluetooth and WLAN; Serial: FH 254 B**

Communication System: WCDMA1900; Frequency: 1880 MHz; Duty Cycle: 1:1

Medium: 1900 Brain; Medium parameters used:

$f = 1880 \text{ MHz}$; $\sigma = 1.45 \text{ mho/m}$; $\epsilon_r = 40.6$; $\rho = 1000 \text{ kg/m}^3$

Phantom section: Left Section

Test Date: 12-01-2010; Ambient Temp: 23.9 °C; Tissue Temp: 22.3 °C

Probe: EX3DV4 - SN3550; ConvF(6.81, 6.81, 6.81); Calibrated: 1/26/2010

Sensor-Surface: 4mm (Mechanical Surface Detection)

Electronics: DAE4 Sn649; Calibrated: 1/22/2010

Phantom: SAM Main; Type: SAM 4.0; Serial: TP-1114

Measurement SW: DASY4, V4.7 Build 80; Postprocessing SW: SEMCAD, V1.8 Build 186

Mode: WCDMA 1900, Left Head, Tilt, Mid.ch

Area Scan (7x11x1): Measurement grid: dx=15mm, dy=15mm

Zoom Scan (5x5x7)/Cube 0: Measurement grid: dx=8mm, dy=8mm, dz=5mm

Reference Value = 15.2 V/m

Peak SAR (extrapolated) = 0.485 W/kg

SAR(1 g) = 0.315 mW/g; SAR(10 g) = 0.192 mW/g

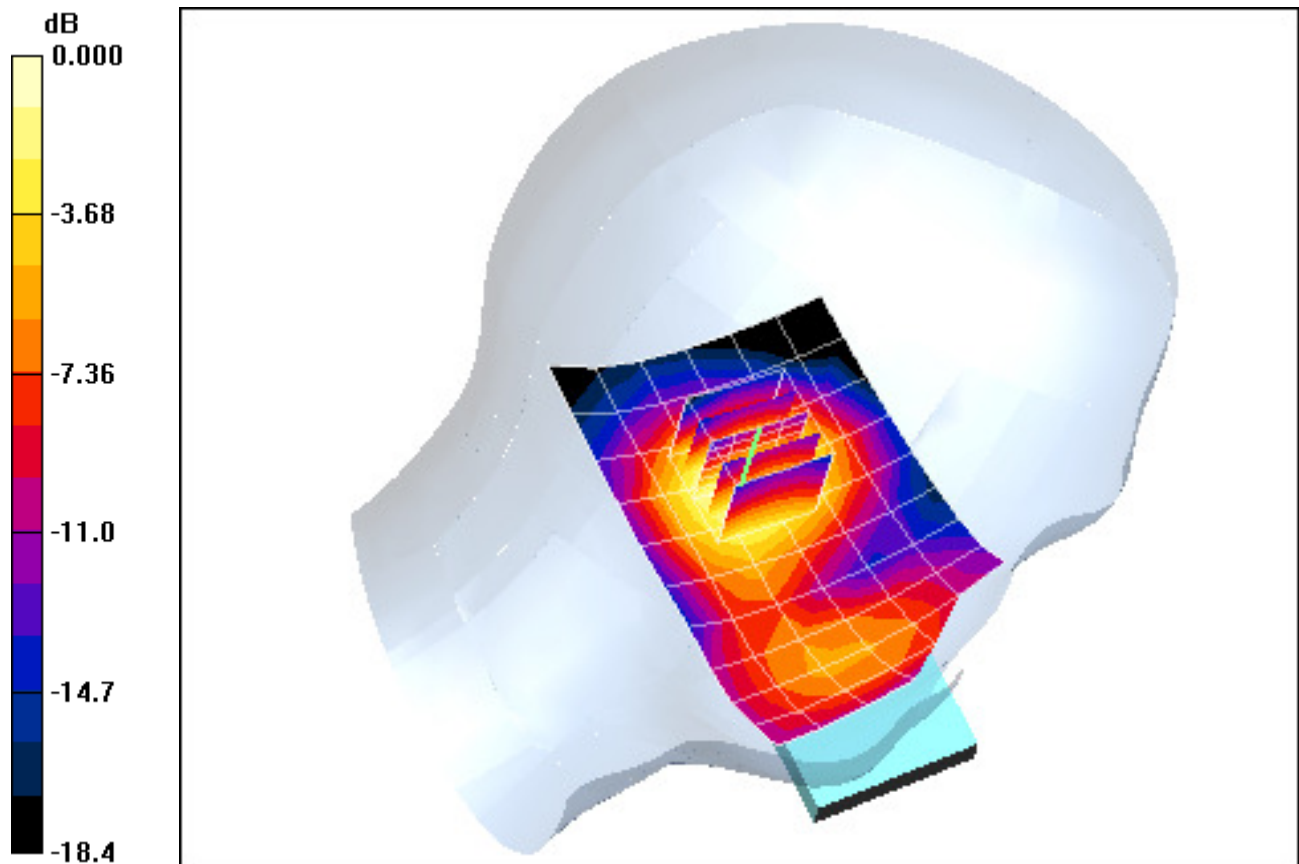

0 dB = 0.330mW/g

PCTEST ENGINEERING LABORATORY, INC.

**DUT: A3LGTS7230L; Type: 850/1900 GSM/GPRS/WCDMA/HSDPA Phone
with EDGE Rx, Bluetooth and WLAN; Serial: FH 254 B**

Communication System: WCDMA1900; Frequency: 1880 MHz; Duty Cycle: 1:1

Medium: 1900 Brain; Medium parameters used:

$f = 1880 \text{ MHz}$; $\sigma = 1.45 \text{ mho/m}$; $\epsilon_r = 40.6$; $\rho = 1000 \text{ kg/m}^3$

Phantom section: Left Section

Test Date: 12-01-2010; Ambient Temp: 23.9 °C; Tissue Temp: 22.3 °C

Probe: EX3DV4 - SN3550; ConvF(6.81, 6.81, 6.81); Calibrated: 1/26/2010

Sensor-Surface: 4mm (Mechanical Surface Detection)

Electronics: DAE4 Sn649; Calibrated: 1/22/2010

Phantom: SAM Main; Type: SAM 4.0; Serial: TP-1114

Measurement SW: DASY4, V4.7 Build 80; Postprocessing SW: SEMCAD, V1.8 Build 186

Mode: WCDMA 1900, Left Head, Tilt, Mid.ch

Area Scan (7x11x1): Measurement grid: dx=15mm, dy=15mm

Zoom Scan (5x5x7)/Cube 0: Measurement grid: dx=8mm, dy=8mm, dz=5mm

Reference Value = 15.2 V/m

Peak SAR (extrapolated) = 0.485 W/kg

SAR(1 g) = 0.315 mW/g; SAR(10 g) = 0.192 mW/g

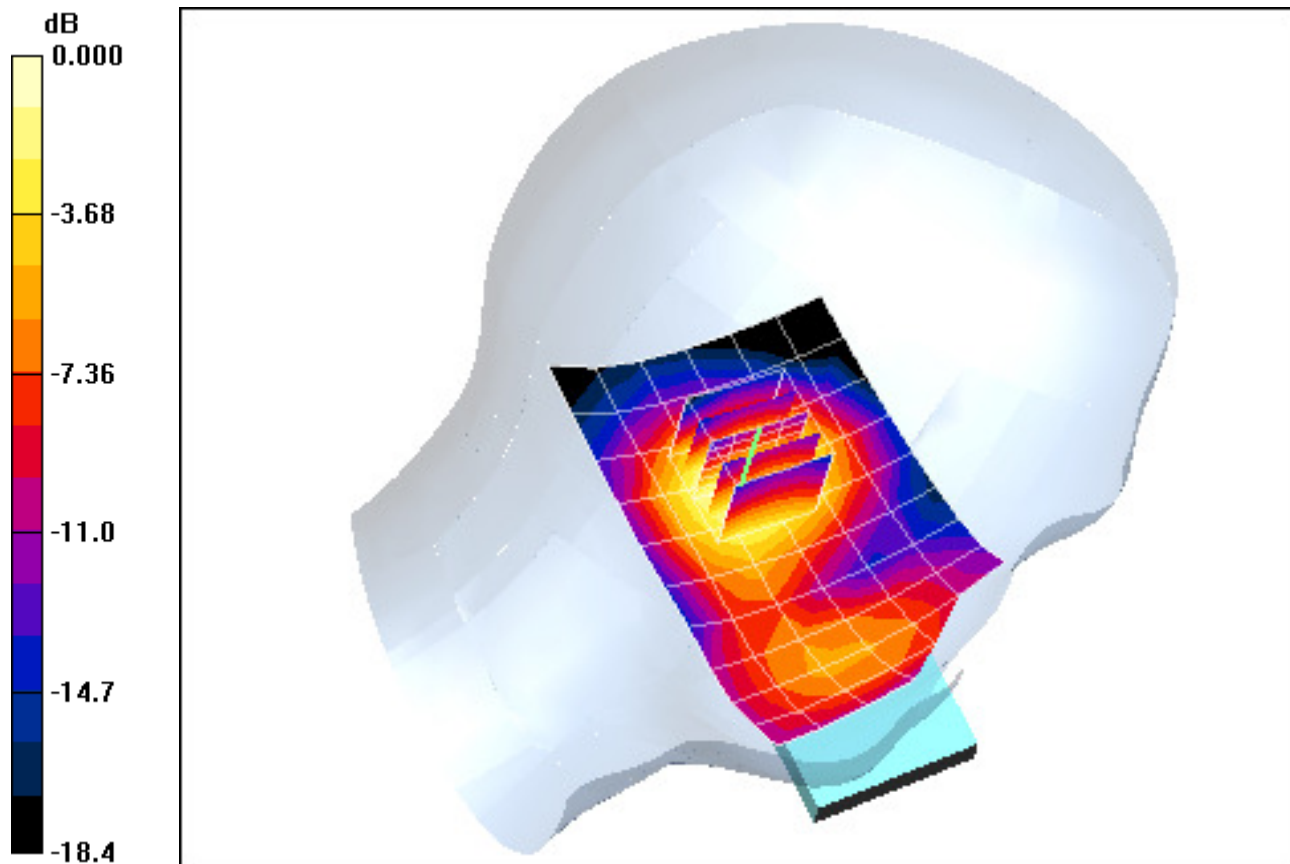

0 dB = 0.330mW/g

PCTEST ENGINEERING LABORATORY, INC.

**DUT: A3LGTS7230L; Type: 850/1900 GSM/GPRS/WCDMA/HSDPA Phone
with EDGE Rx, Bluetooth and WLAN; Serial: FH 254 B**

Communication System: IEEE 802.11b; Frequency: 2462 MHz; Duty Cycle: 1:1
Medium: 2450 Brain; Medium parameters used (interpolated):
 $f = 2462 \text{ MHz}$; $\sigma = 1.88 \text{ mho/m}$; $\epsilon_r = 37.8$; $\rho = 1000 \text{ kg/m}^3$

Phantom section: Right Section

Test Date: 12-02-2010; Ambient Temp: 23.8 °C; Tissue Temp: 22.1 °C

Probe: EX3DV4 - SN3550; ConvF(6.21, 6.21, 6.21); Calibrated: 1/26/2010
Sensor-Surface: 3mm (Mechanical Surface Detection)
Electronics: DAE4 Sn649; Calibrated: 1/22/2010
Phantom: SAM Main; Type: SAM 4.0; Serial: TP-1114
Measurement SW: DASY4, V4.7 Build 80; Postprocessing SW: SEMCAD, V1.8 Build 186

Mode: IEE 802.11b, Right Head, Touch, Ch 11, 1 Mbps

Area Scan (7x11x1): Measurement grid: dx=15mm, dy=15mm
Zoom Scan (5x5x7)/Cube 0: Measurement grid: dx=8mm, dy=8mm, dz=5mm
Reference Value = 16.8 V/m
Peak SAR (extrapolated) = 1.13 W/kg
SAR(1 g) = 0.562 mW/g; SAR(10 g) = 0.275 mW/g

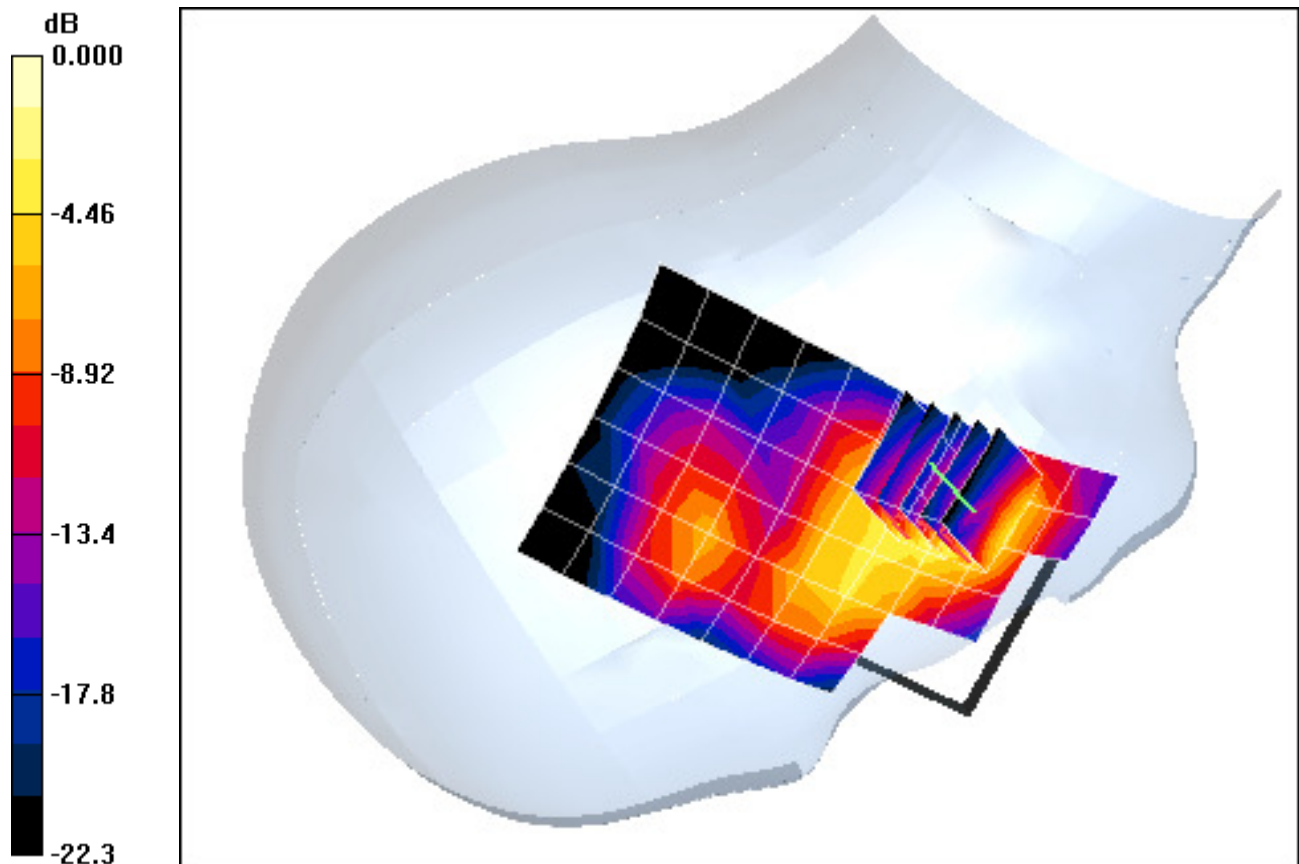

0 dB = 0.711mW/g

PCTEST ENGINEERING LABORATORY, INC.

**DUT: A3LGTS7230L; Type: 850/1900 GSM/GPRS/WCDMA/HSDPA Phone
with EDGE Rx, Bluetooth and WLAN; Serial: FH 254 B**

Communication System: IEEE 802.11b; Frequency: 2462 MHz; Duty Cycle: 1:1
Medium: 2450 Brain; Medium parameters used (interpolated):

$$f = 2462 \text{ MHz}; \sigma = 1.88 \text{ mho/m}; \epsilon_r = 37.8; \rho = 1000 \text{ kg/m}^3$$

Phantom section: Right Section

Test Date: 12-02-2010; Ambient Temp: 23.8 °C; Tissue Temp: 22.1 °C

Probe: EX3DV4 - SN3550; ConvF(6.21, 6.21, 6.21); Calibrated: 1/26/2010

Sensor-Surface: 3mm (Mechanical Surface Detection)

Electronics: DAE4 Sn649; Calibrated: 1/22/2010

Phantom: SAM Main; Type: SAM 4.0; Serial: TP-1114

Measurement SW: DASY4, V4.7 Build 80; Postprocessing SW: SEMCAD, V1.8 Build 186

Mode: IEE 802.11b, Right Head, Touch, Ch 11, 1 Mbps

Area Scan (7x11x1): Measurement grid: dx=15mm, dy=15mm

Zoom Scan (5x5x7)/Cube 0: Measurement grid: dx=8mm, dy=8mm, dz=5mm

Reference Value = 16.8 V/m

Peak SAR (extrapolated) = 1.13 W/kg

SAR(1 g) = 0.562 mW/g; SAR(10 g) = 0.275 mW/g

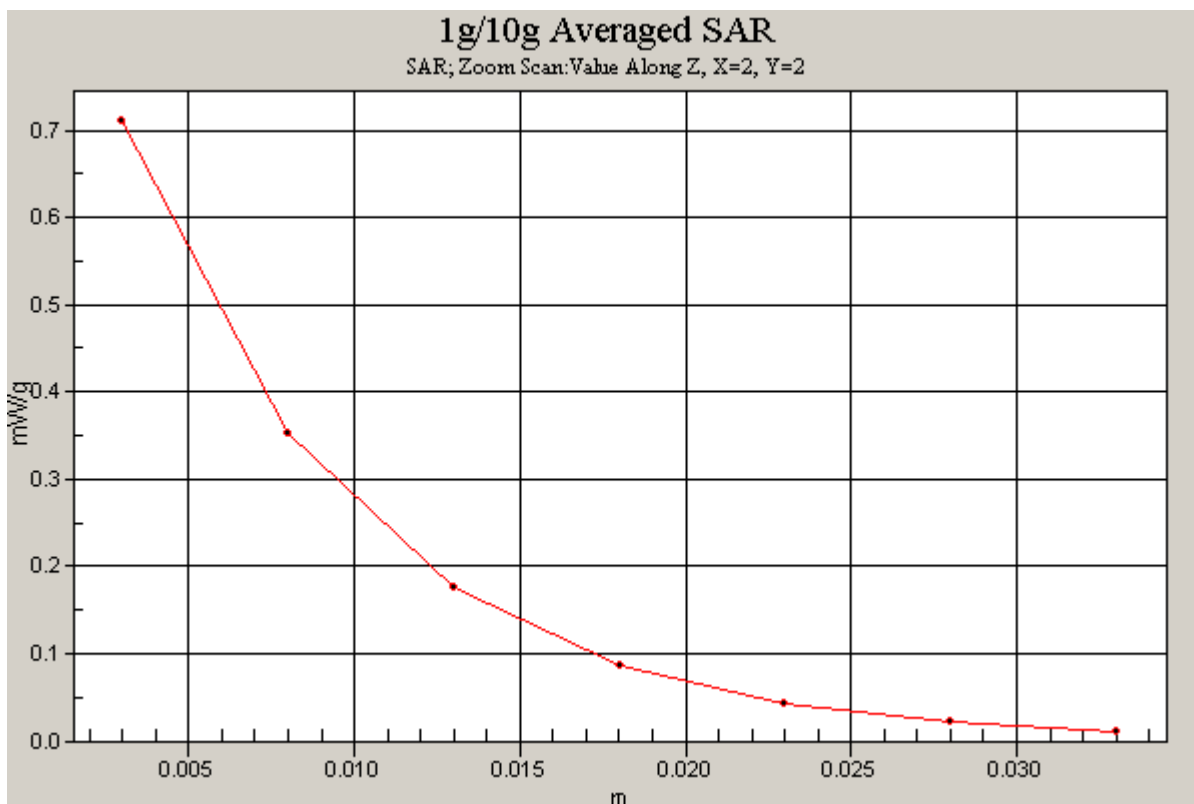

PCTEST ENGINEERING LABORATORY, INC.

**DUT: A3LGTS7230L; Type: 850/1900 GSM/GPRS/WCDMA/HSDPA Phone
with EDGE Rx, Bluetooth and WLAN; Serial: FH 254 B**

Communication System: IEEE 802.11b; Frequency: 2462 MHz; Duty Cycle: 1:1
Medium: 2450 Brain; Medium parameters used (interpolated):

$f = 2462 \text{ MHz}$; $\sigma = 1.88 \text{ mho/m}$; $\epsilon_r = 37.8$; $\rho = 1000 \text{ kg/m}^3$

Phantom section: Right Section

Test Date: 12-02-2010; Ambient Temp: 23.8 °C; Tissue Temp: 22.1 °C

Probe: EX3DV4 - SN3550; ConvF(6.21, 6.21, 6.21); Calibrated: 1/26/2010

Sensor-Surface: 3mm (Mechanical Surface Detection)

Electronics: DAE4 Sn649; Calibrated: 1/22/2010

Phantom: SAM Main; Type: SAM 4.0; Serial: TP-1114

Measurement SW: DASY4, V4.7 Build 80; Postprocessing SW: SEMCAD, V1.8 Build 186

Mode: IEEE 802.11b, Right Head, Tilt, Ch 11, 1 Mbps

Area Scan (7x11x1): Measurement grid: dx=15mm, dy=15mm

Zoom Scan (5x5x7)/Cube 0: Measurement grid: dx=8mm, dy=8mm, dz=5mm

Reference Value = 8.59 V/m

Peak SAR (extrapolated) = 0.289 W/kg

SAR(1 g) = 0.153 mW/g; SAR(10 g) = 0.074 mW/g

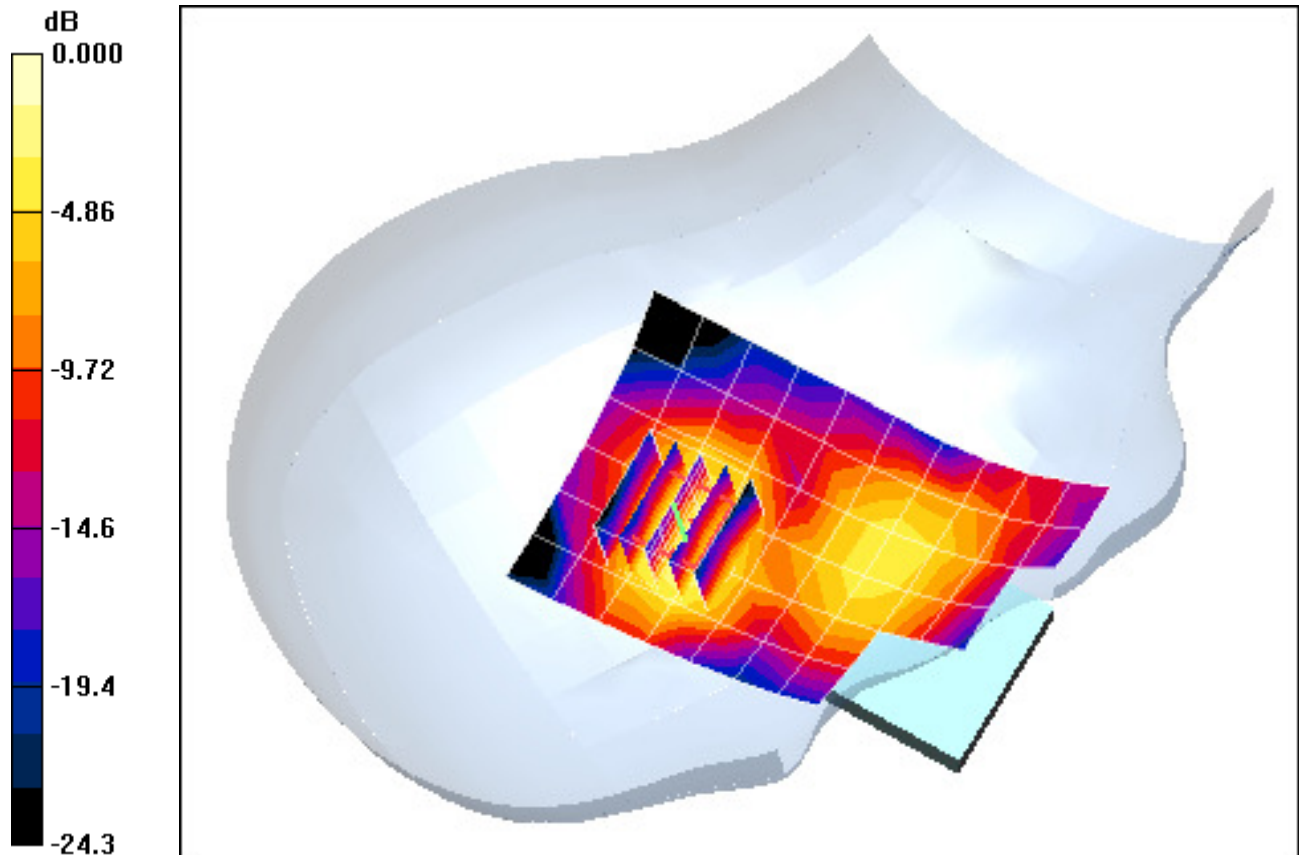

0 dB = 0.194mW/g

PCTEST ENGINEERING LABORATORY, INC.

**DUT: A3LGTS7230L; Type: 850/1900 GSM/GPRS/WCDMA/HSDPA Phone
with EDGE Rx, Bluetooth and WLAN; Serial: FH 254 B**

Communication System: IEEE 802.11b; Frequency: 2462 MHz; Duty Cycle: 1:1
Medium: 2450 Brain ; Medium parameters used (interpolated):

$f = 2462 \text{ MHz}$; $\sigma = 1.88 \text{ mho/m}$; $\epsilon_r = 37.8$; $\rho = 1000 \text{ kg/m}^3$

Phantom section: Left Section

Test Date: 12-02-2010; Ambient Temp: 23.8 °C; Tissue Temp: 22.1 °C

Probe: EX3DV4 - SN3550; ConvF(6.21, 6.21, 6.21); Calibrated: 1/26/2010

Sensor-Surface: 3mm (Mechanical Surface Detection)

Electronics: DAE4 Sn649; Calibrated: 1/22/2010

Phantom: SAM Main; Type: SAM 4.0; Serial: TP-1114

Measurement SW: DASY4, V4.7 Build 80; Postprocessing SW: SEMCAD, V1.8 Build 186

Mode: IEEE 802.11b, Left Head, Touch, Ch 11, 1 Mbps

Area Scan (7x11x1): Measurement grid: dx=15mm, dy=15mm

Zoom Scan (5x5x7)/Cube 0: Measurement grid: dx=8mm, dy=8mm, dz=5mm

Reference Value = 14.0 V/m

Peak SAR (extrapolated) = 0.579 W/kg

SAR(1 g) = 0.356 mW/g; SAR(10 g) = 0.210 mW/g

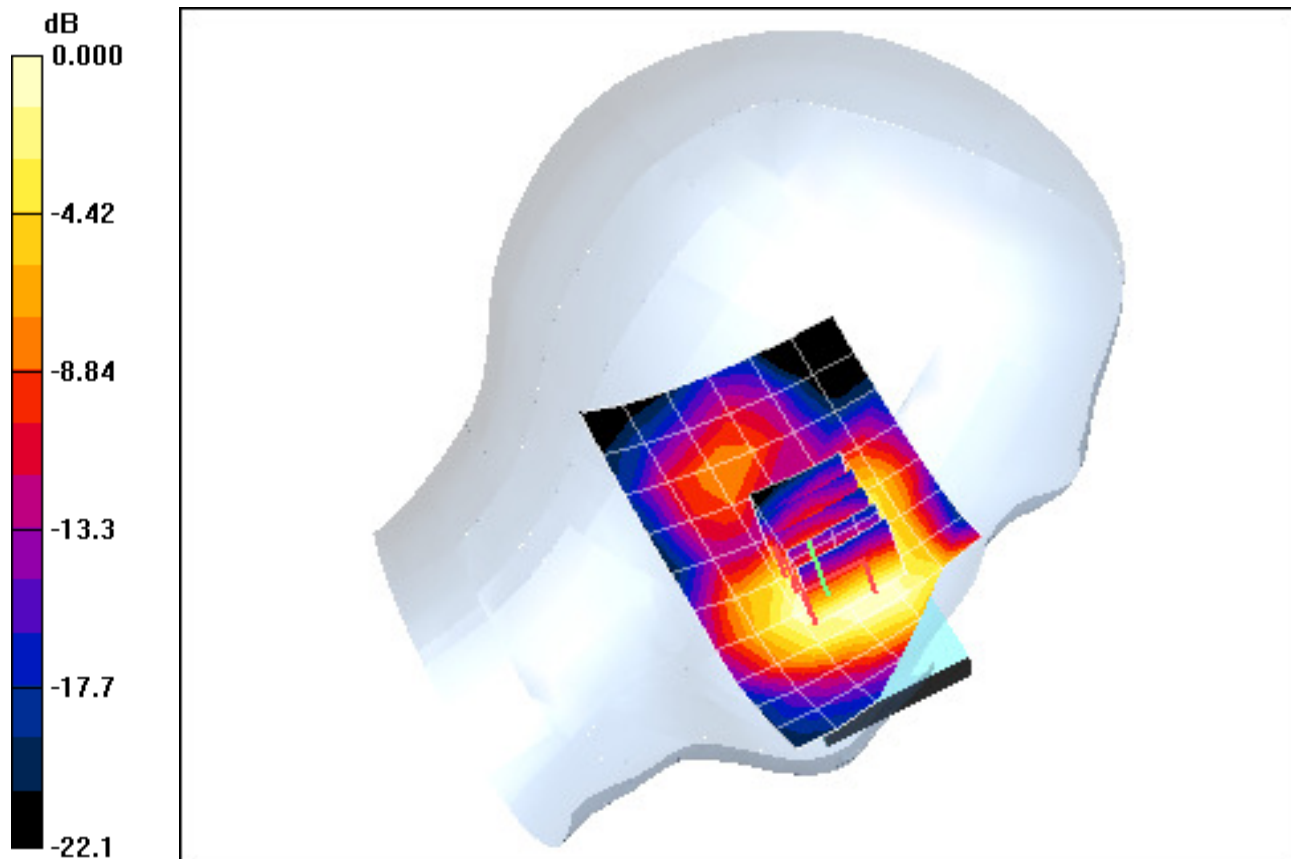

0 dB = 0.424mW/g

PCTEST ENGINEERING LABORATORY, INC.

DUT: A3LGTS7230L; Type: 850/1900 GSM/GPRS/WCDMA/HSDPA Phone with EDGE Rx, Bluetooth and WLAN; Serial: FH 254 B

Communication System: IEEE 802.11b; Frequency: 2437 MHz; Duty Cycle: 1:1
Medium: 2450 Brain; Medium parameters used (interpolated):

$f = 2437 \text{ MHz}$; $\sigma = 1.85 \text{ mho/m}$; $\epsilon_r = 37.9$; $\rho = 1000 \text{ kg/m}^3$

Phantom section: Left Section

Test Date: 12-02-2010; Ambient Temp: 23.8 °C; Tissue Temp: 22.1 °C

Probe: EX3DV4 - SN3550; ConvF(6.21, 6.21, 6.21); Calibrated: 1/26/2010

Sensor-Surface: 3mm (Mechanical Surface Detection)

Electronics: DAE4 Sn649; Calibrated: 1/22/2010

Phantom: SAM Main; Type: SAM 4.0; Serial: TP-1114

Measurement SW: DASY4, V4.7 Build 80; Postprocessing SW: SEMCAD, V1.8 Build 186

Mode: IEEE 802.11b, Left Head, Tilt, Ch 06, 1 Mbps

Area Scan (7x11x1): Measurement grid: dx=15mm, dy=15mm

Zoom Scan (5x5x7)/Cube 0: Measurement grid: dx=8mm, dy=8mm, dz=5mm

Reference Value = 7.00 V/m

Peak SAR (extrapolated) = 0.171 W/kg

SAR(1 g) = 0.095 mW/g; SAR(10 g) = 0.048 mW/g

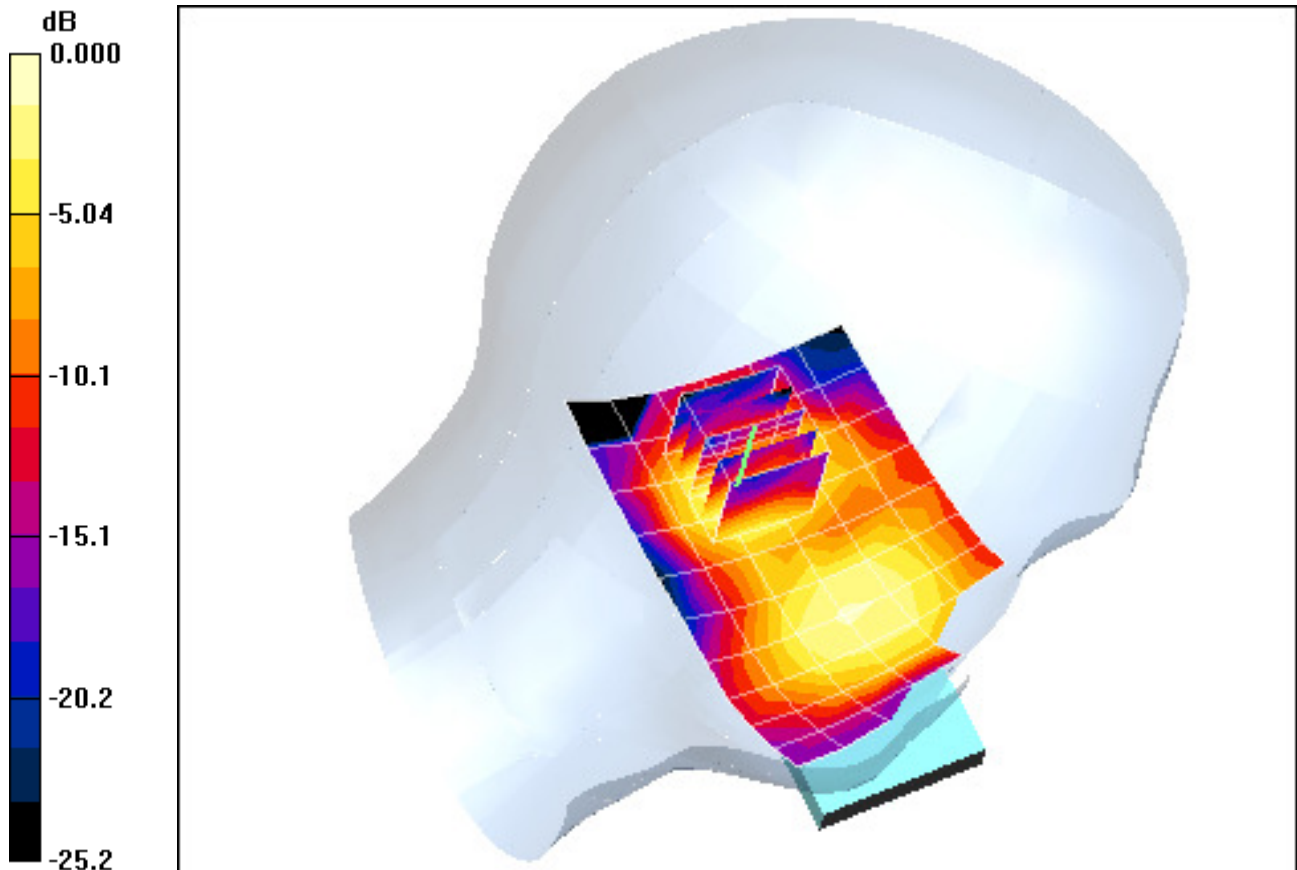

0 dB = 0.118mW/g

PCTEST ENGINEERING LABORATORY, INC.

**DUT: A3LGTS7230L; Type: 850/1900 GSM/GPRS/WCDMA/HSDPA Phone
with EDGE Rx, Bluetooth and WLAN; Serial: FH 254 B**

Communication System: GSM850 GPRS; 2 Tx slots; Frequency: 836.6 MHz; Duty Cycle: 1:4.15
Medium: 835 Muscle; Medium parameters used (interpolated):

$$f = 836.6 \text{ MHz}; \sigma = 1.01 \text{ mho/m}; \epsilon_r = 56.2; \rho = 1000 \text{ kg/m}^3$$

Phantom section: Flat Section; Space: 1.5 cm

Test Date: 11-29-2010; Ambient Temp: 23.8 °C; Tissue Temp: 22.9 °C

Probe: EX3DV4 - SN3550; ConvF(8.3, 8.3, 8.3); Calibrated: 1/26/2010

Sensor-Surface: 4mm (Mechanical Surface Detection)

Electronics: DAE4 Sn649; Calibrated: 1/22/2010

Phantom: SAM Sub; Type: SAM 4.0; Serial: TP-1357

Measurement SW: DASY4, V4.7 Build 80; Postprocessing SW: SEMCAD, V1.8 Build 186

Mode: GPRS 850, Body SAR, Back side, Mid.ch, 2 Tx Slots

Area Scan (7x11x1): Measurement grid: dx=15mm, dy=15mm

Zoom Scan (5x5x7)/Cube 0: Measurement grid: dx=8mm, dy=8mm, dz=5mm

Reference Value = 21.7 V/m

Peak SAR (extrapolated) = 0.665 W/kg

SAR(1 g) = 0.488 mW/g; SAR(10 g) = 0.347 mW/g

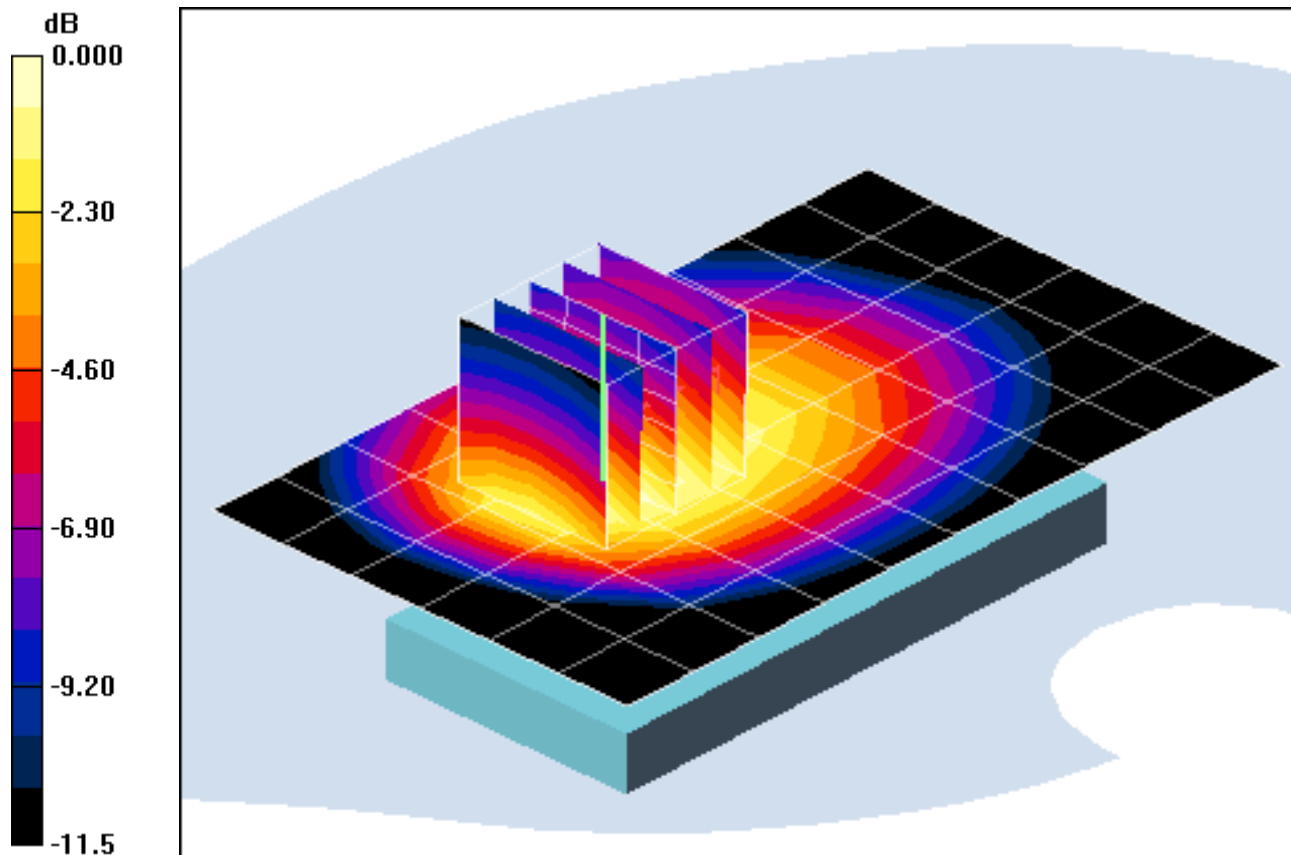

0 dB = 0.515mW/g

PCTEST ENGINEERING LABORATORY, INC.

**DUT: A3LGTS7230L; Type: 850/1900 GSM/GPRS/WCDMA/HSDPA Phone
with EDGE Rx, Bluetooth and WLAN; Serial: FH 254 B**

Communication System: GSM850 GPRS; 2 Tx slots; Frequency: 836.6 MHz; Duty Cycle: 1:4.15
Medium: 835 Muscle; Medium parameters used (interpolated):

$$f = 836.6 \text{ MHz}; \sigma = 1.01 \text{ mho/m}; \epsilon_r = 56.2; \rho = 1000 \text{ kg/m}^3$$

Phantom section: Flat Section; Space: 1.5 cm

Test Date: 11-29-2010; Ambient Temp: 23.8 °C; Tissue Temp: 22.9 °C

Probe: EX3DV4 - SN3550; ConvF(8.3, 8.3, 8.3); Calibrated: 1/26/2010

Sensor-Surface: 4mm (Mechanical Surface Detection)

Electronics: DAE4 Sn649; Calibrated: 1/22/2010

Phantom: SAM Sub; Type: SAM 4.0; Serial: TP-1357

Measurement SW: DASY4, V4.7 Build 80; Postprocessing SW: SEMCAD, V1.8 Build 186

Mode: GPRS 850, Body SAR, Back side, Mid.ch, 2 Tx Slots

Area Scan (7x11x1): Measurement grid: dx=15mm, dy=15mm

Zoom Scan (5x5x7)/Cube 0: Measurement grid: dx=8mm, dy=8mm, dz=5mm

Reference Value = 21.7 V/m

Peak SAR (extrapolated) = 0.665 W/kg

SAR(1 g) = 0.488 mW/g; SAR(10 g) = 0.347 mW/g

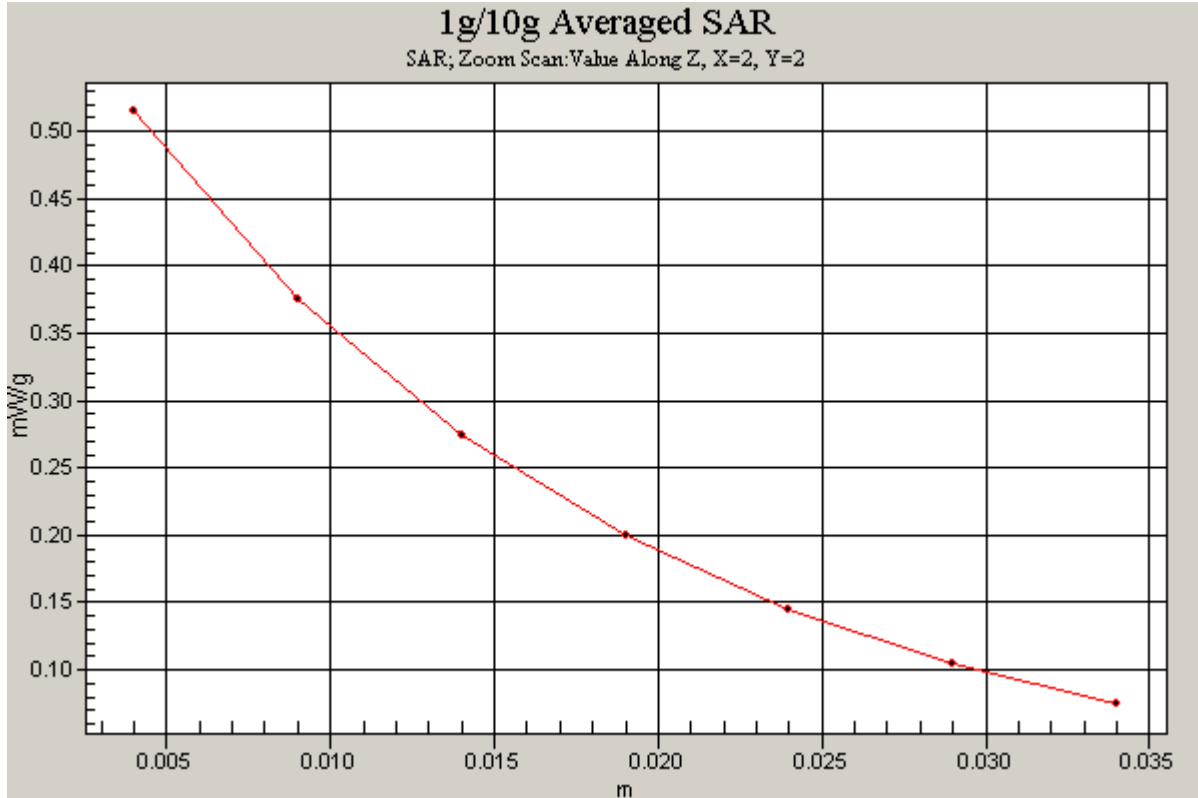

PCTEST ENGINEERING LABORATORY, INC.

**DUT: A3LGTS7230L; Type: 850/1900 GSM/GPRS/WCDMA/HSDPA Phone
with EDGE Rx, Bluetooth and WLAN; Serial: FH 254 B**

Communication System: GSM1900 GPRS; 2 Tx slots; Frequency: 1880 MHz; Duty Cycle: 1:4.15

Medium: 1900 Muscle; Medium parameters used:

$f = 1880 \text{ MHz}$; $\sigma = 1.48 \text{ mho/m}$; $\epsilon_r = 54.2$; $\rho = 1000 \text{ kg/m}^3$

Phantom section: Flat Section; Space: 1.5 cm

Test Date: 12-01-2010; Ambient Temp: 24.1 °C; Tissue Temp: 22.6 °C

Probe: EX3DV4 - SN3550; ConvF(6.63, 6.63, 6.63); Calibrated: 1/26/2010

Sensor-Surface: 4mm (Mechanical Surface Detection)

Electronics: DAE4 Sn649; Calibrated: 1/22/2010

Phantom: SAM Main; Type: SAM 4.0; Serial: TP-1114

Measurement SW: DASY4, V4.7 Build 80; Postprocessing SW: SEMCAD, V1.8 Build 186

Mode: GPRS 1900, Body SAR, Back side, Mid.ch, 2 Tx Slots

Area Scan (7x11x1): Measurement grid: dx=15mm, dy=15mm

Zoom Scan (5x5x7)/Cube 0: Measurement grid: dx=8mm, dy=8mm, dz=5mm

Reference Value = 19.6 V/m

Peak SAR (extrapolated) = 0.897 W/kg

SAR(1 g) = 0.559 mW/g; SAR(10 g) = 0.335 mW/g

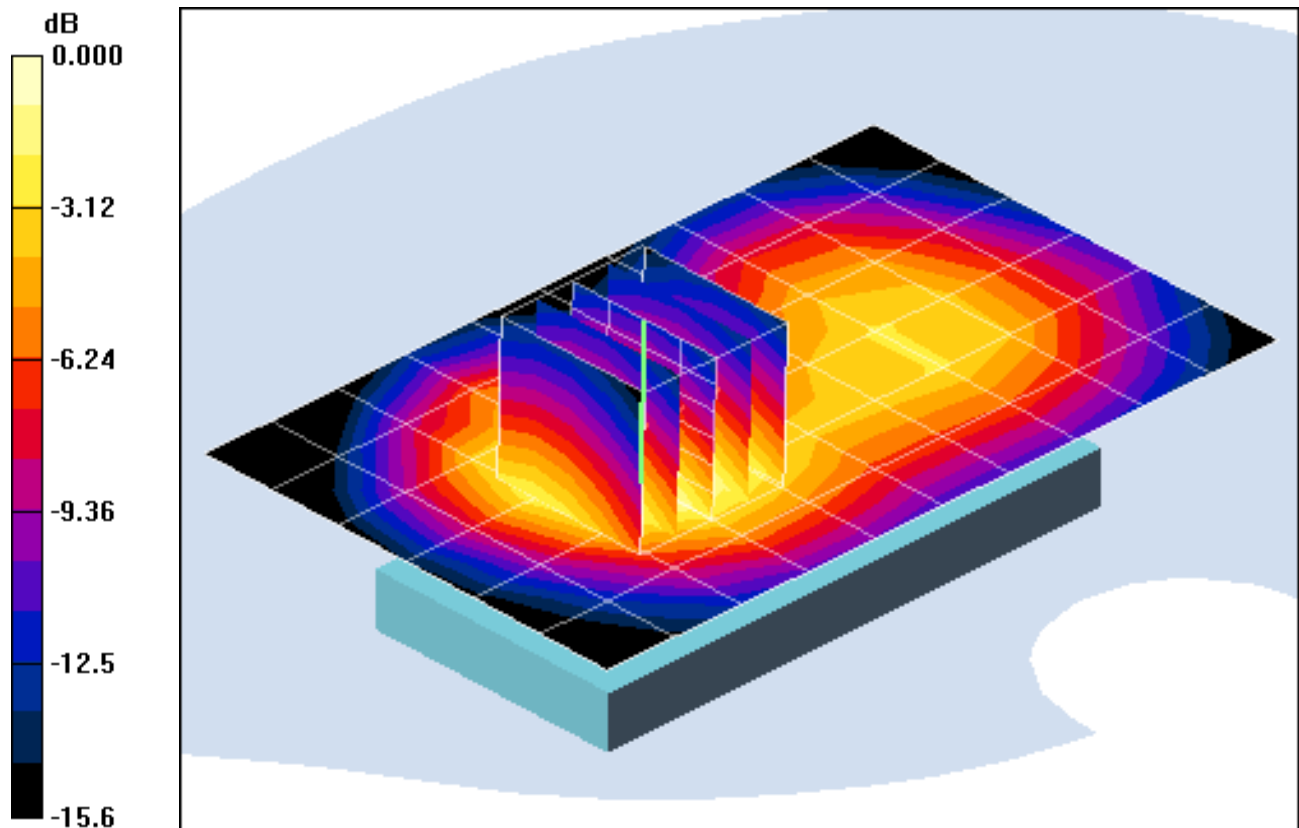

0 dB = 0.605mW/g

PCTEST ENGINEERING LABORATORY, INC.

**DUT: A3LGTS7230L; Type: 850/1900 GSM/GPRS/WCDMA/HSDPA Phone
with EDGE Rx, Bluetooth and WLAN; Serial: FH 254 B**

Communication System: GSM1900 GPRS; 2 Tx slots; Frequency: 1880 MHz; Duty Cycle: 1:4.15

Medium: 1900 Muscle; Medium parameters used:

$$f = 1880 \text{ MHz}; \sigma = 1.48 \text{ mho/m}; \epsilon_r = 54.2; \rho = 1000 \text{ kg/m}^3$$

Phantom section: Flat Section; Space: 1.5 cm

Test Date: 12-01-2010; Ambient Temp: 24.1 °C; Tissue Temp: 22.6 °C

Probe: EX3DV4 - SN3550; ConvF(6.63, 6.63, 6.63); Calibrated: 1/26/2010

Sensor-Surface: 4mm (Mechanical Surface Detection)

Electronics: DAE4 Sn649; Calibrated: 1/22/2010

Phantom: SAM Main; Type: SAM 4.0; Serial: TP-1114

Measurement SW: DASY4, V4.7 Build 80; Postprocessing SW: SEMCAD, V1.8 Build 186

Mode: GPRS 1900, Body SAR, Back side, Mid.ch, 2 Tx Slots

Area Scan (7x11x1): Measurement grid: dx=15mm, dy=15mm

Zoom Scan (5x5x7)/Cube 0: Measurement grid: dx=8mm, dy=8mm, dz=5mm

Reference Value = 19.6 V/m

Peak SAR (extrapolated) = 0.897 W/kg

SAR(1 g) = 0.559 mW/g; SAR(10 g) = 0.335 mW/g

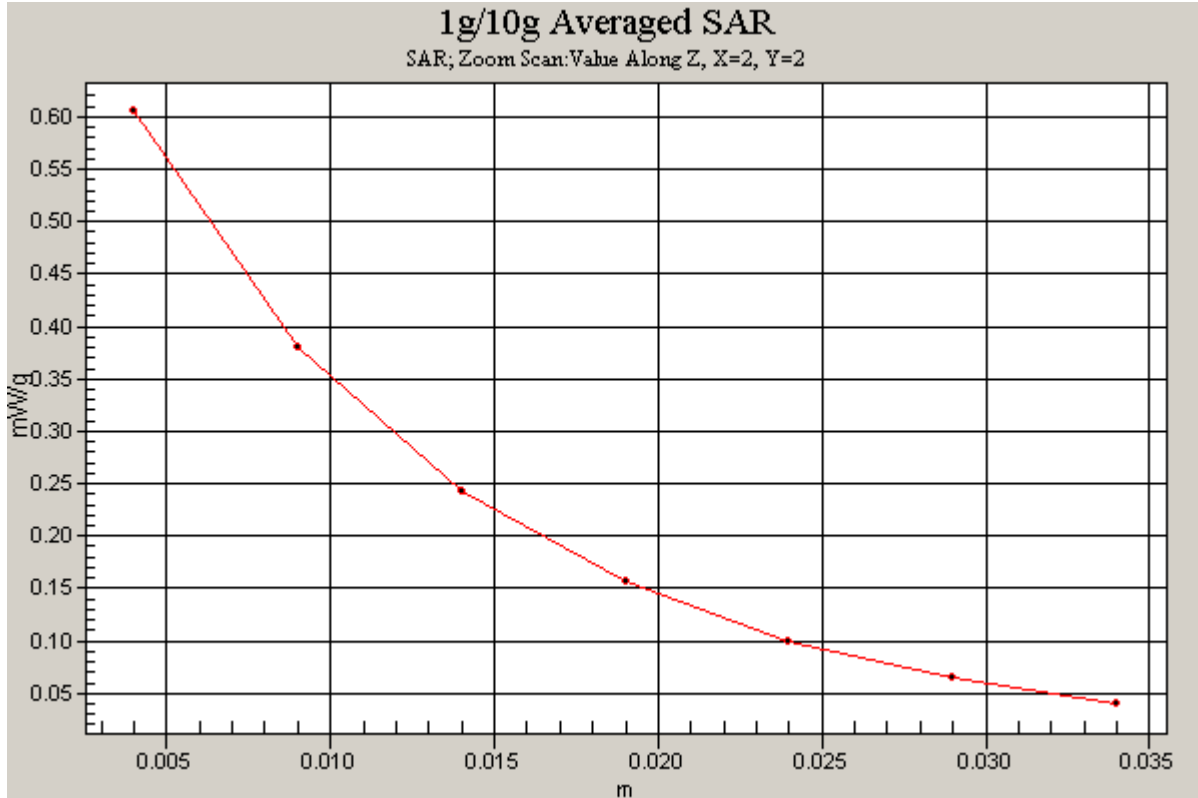

PCTEST ENGINEERING LABORATORY, INC.

**DUT: A3LGTS7230L; Type: 850/1900 GSM/GPRS/WCDMA/HSDPA Phone
with EDGE Rx, Bluetooth and WLAN; Serial: FH 254 A**

Communication System: WCDMA850; Frequency: 836.6 MHz; Duty Cycle: 1:1
Medium: 835 Muscle; Medium parameters used (interpolated):

$f = 836.6 \text{ MHz}$; $\sigma = 1.01 \text{ mho/m}$; $\epsilon_r = 56.2$; $\rho = 1000 \text{ kg/m}^3$

Phantom section: Flat Section; Space: 1.5 cm

Test Date: 11-29-2010; Ambient Temp: 23.8 °C; Tissue Temp: 22.9 °C

Probe: EX3DV4 - SN3550; ConvF(8.3, 8.3, 8.3); Calibrated: 1/26/2010

Sensor-Surface: 4mm (Mechanical Surface Detection)

Electronics: DAE4 Sn649; Calibrated: 1/22/2010

Phantom: SAM Sub; Type: SAM 4.0; Serial: TP-1357

Measurement SW: DASY4, V4.7 Build 80; Postprocessing SW: SEMCAD, V1.8 Build 186

Mode: WCDMA 850, Body SAR, Back side, Mid.ch

Area Scan (7x11x1): Measurement grid: dx=15mm, dy=15mm

Zoom Scan (5x5x7)/Cube 0: Measurement grid: dx=8mm, dy=8mm, dz=5mm

Reference Value = 14.0 V/m

Peak SAR (extrapolated) = 0.258 W/kg

SAR(1 g) = 0.191 mW/g; SAR(10 g) = 0.134 mW/g

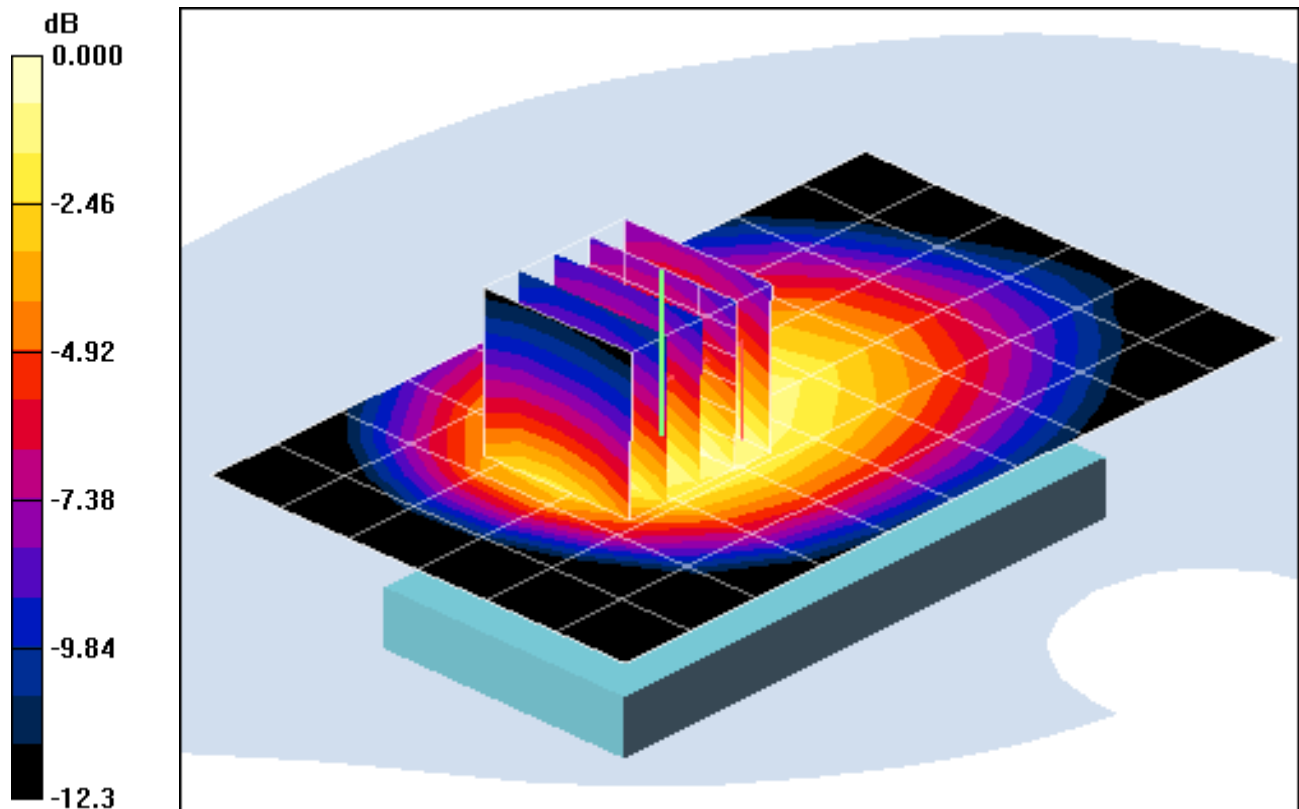

0 dB = 0.203mW/g

PCTEST ENGINEERING LABORATORY, INC.

**DUT: A3LGTS7230L; Type: 850/1900 GSM/GPRS/WCDMA/HSDPA Phone
with EDGE Rx, Bluetooth and WLAN; Serial: FH 254 B**

Communication System: WCDMA1900; Frequency: 1880 MHz; Duty Cycle: 1:1

Medium: 1900 Muscle; Medium parameters used:

$f = 1880 \text{ MHz}$; $\sigma = 1.48 \text{ mho/m}$; $\epsilon_r = 54.2$; $\rho = 1000 \text{ kg/m}^3$

Phantom section: Flat Section; Space: 1.5 cm

Test Date: 12-01-2010; Ambient Temp: 24.1 °C; Tissue Temp: 22.6 °C

Probe: EX3DV4 - SN3550; ConvF(6.63, 6.63, 6.63); Calibrated: 1/26/2010

Sensor-Surface: 4mm (Mechanical Surface Detection)

Electronics: DAE4 Sn649; Calibrated: 1/22/2010

Phantom: SAM Main; Type: SAM 4.0; Serial: TP-1114

Measurement SW: DASY4, V4.7 Build 80; Postprocessing SW: SEMCAD, V1.8 Build 186

Mode: WCDMA 1900, Body SAR, Back side, Mid.ch

Area Scan (7x11x1): Measurement grid: dx=15mm, dy=15mm

Zoom Scan (5x5x7)/Cube 0: Measurement grid: dx=8mm, dy=8mm, dz=5mm

Reference Value = 17.8 V/m

Peak SAR (extrapolated) = 0.725 W/kg

SAR(1 g) = 0.454 mW/g; SAR(10 g) = 0.273 mW/g

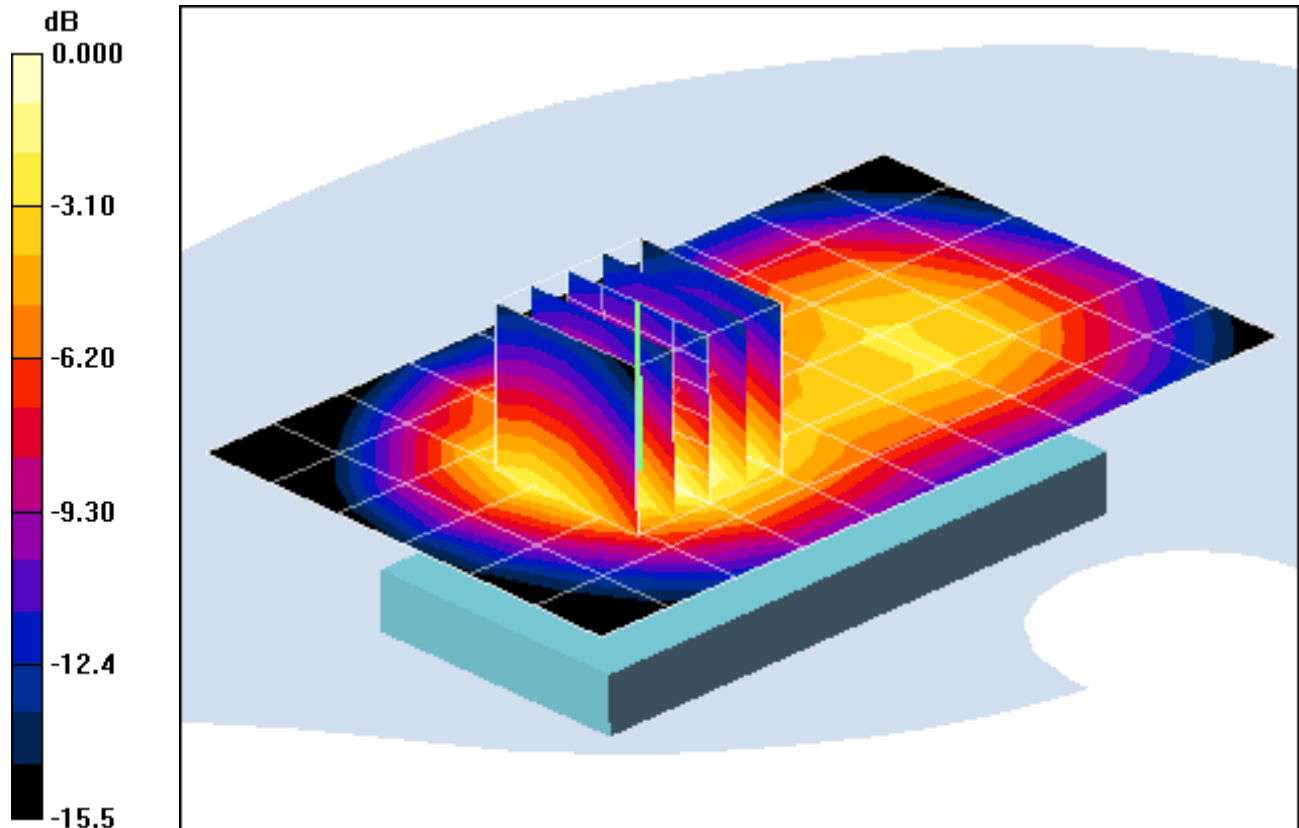

0 dB = 0.491mW/g

PCTEST ENGINEERING LABORATORY, INC.

**DUT: A3LGTS7230L; Type: 850/1900 GSM/GPRS/WCDMA/HSDPA Phone
with EDGE Rx, Bluetooth and WLAN; Serial: FH 254 B**

Communication System: IEEE 802.11b; Frequency: 2462 MHz; Duty Cycle: 1:1

Medium: 2450 Muscle; Medium parameters used (interpolated):

$f = 2462 \text{ MHz}$; $\sigma = 2.03 \text{ mho/m}$; $\epsilon_r = 51.2$; $\rho = 1000 \text{ kg/m}^3$

Phantom section: Flat Section; Space: 1.5 cm

Test Date: 12-02-2010; Ambient Temp: 23.9 °C; Tissue Temp: 22.3 °C

Probe: EX3DV4 - SN3550; ConvF(6.4, 6.4, 6.4); Calibrated: 1/26/2010

Sensor-Surface: 3mm (Mechanical Surface Detection)

Electronics: DAE4 Sn649; Calibrated: 1/22/2010

Phantom: SAM Sub; Type: SAM 4.0; Serial: TP-1357

Measurement SW: DASY4, V4.7 Build 80; Postprocessing SW: SEMCAD, V1.8 Build 186

Mode: IEEE 802.11b, Body SAR, Front Side, Ch.11, 1Mbps

Area Scan (7x11x1): Measurement grid: dx=15mm, dy=15mm

Zoom Scan (5x5x7)/Cube 0: Measurement grid: dx=8mm, dy=8mm, dz=5mm

Reference Value = 8.38 V/m

Peak SAR (extrapolated) = 0.253 W/kg

SAR(1 g) = 0.140 mW/g; SAR(10 g) = 0.078 mW/g

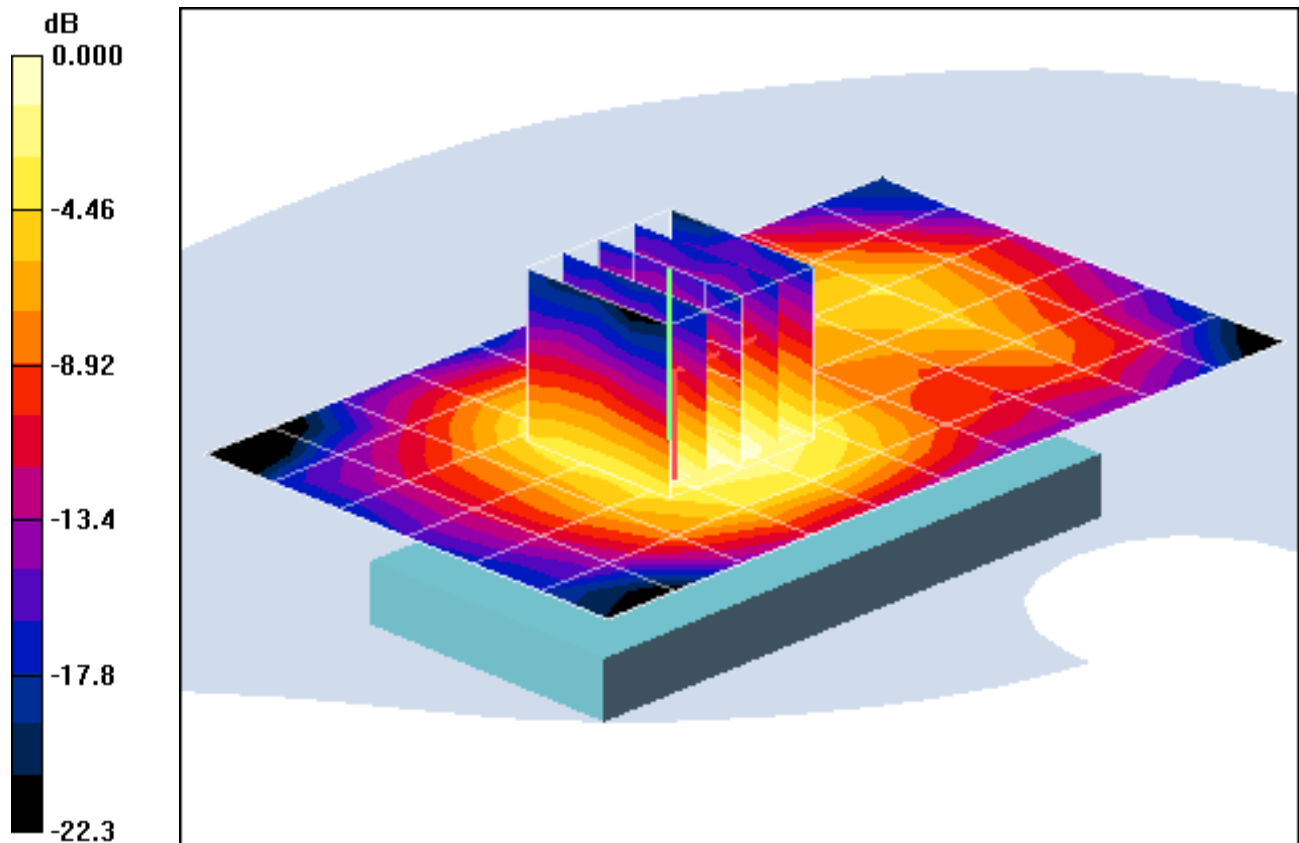

0 dB = 0.171mW/g

PCTEST ENGINEERING LABORATORY, INC.

**DUT: A3LGTS7230L; Type: 850/1900 GSM/GPRS/WCDMA/HSDPA Phone
with EDGE Rx, Bluetooth and WLAN; Serial: FH 254 B**

Communication System: IEEE 802.11b; Frequency: 2462 MHz; Duty Cycle: 1:1

Medium: 2450 Muscle; Medium parameters used (interpolated):

$f = 2462 \text{ MHz}$; $\sigma = 2.03 \text{ mho/m}$; $\epsilon_r = 51.2$; $\rho = 1000 \text{ kg/m}^3$

Phantom section: Flat Section; Space: 1.5 cm

Test Date: 12-02-2010; Ambient Temp: 23.9 °C; Tissue Temp: 22.3 °C

Probe: EX3DV4 - SN3550; ConvF(6.4, 6.4, 6.4); Calibrated: 1/26/2010

Sensor-Surface: 3mm (Mechanical Surface Detection)

Electronics: DAE4 Sn649; Calibrated: 1/22/2010

Phantom: SAM Sub; Type: SAM 4.0; Serial: TP-1357

Measurement SW: DASY4, V4.7 Build 80; Postprocessing SW: SEMCAD, V1.8 Build 186

Mode: IEEE 802.11b, Body SAR, Front Side, Ch.11, 1Mbps

Area Scan (7x11x1): Measurement grid: dx=15mm, dy=15mm

Zoom Scan (5x5x7)/Cube 0: Measurement grid: dx=8mm, dy=8mm, dz=5mm

Reference Value = 8.38 V/m

Peak SAR (extrapolated) = 0.253 W/kg

SAR(1 g) = 0.140 mW/g; SAR(10 g) = 0.078 mW/g

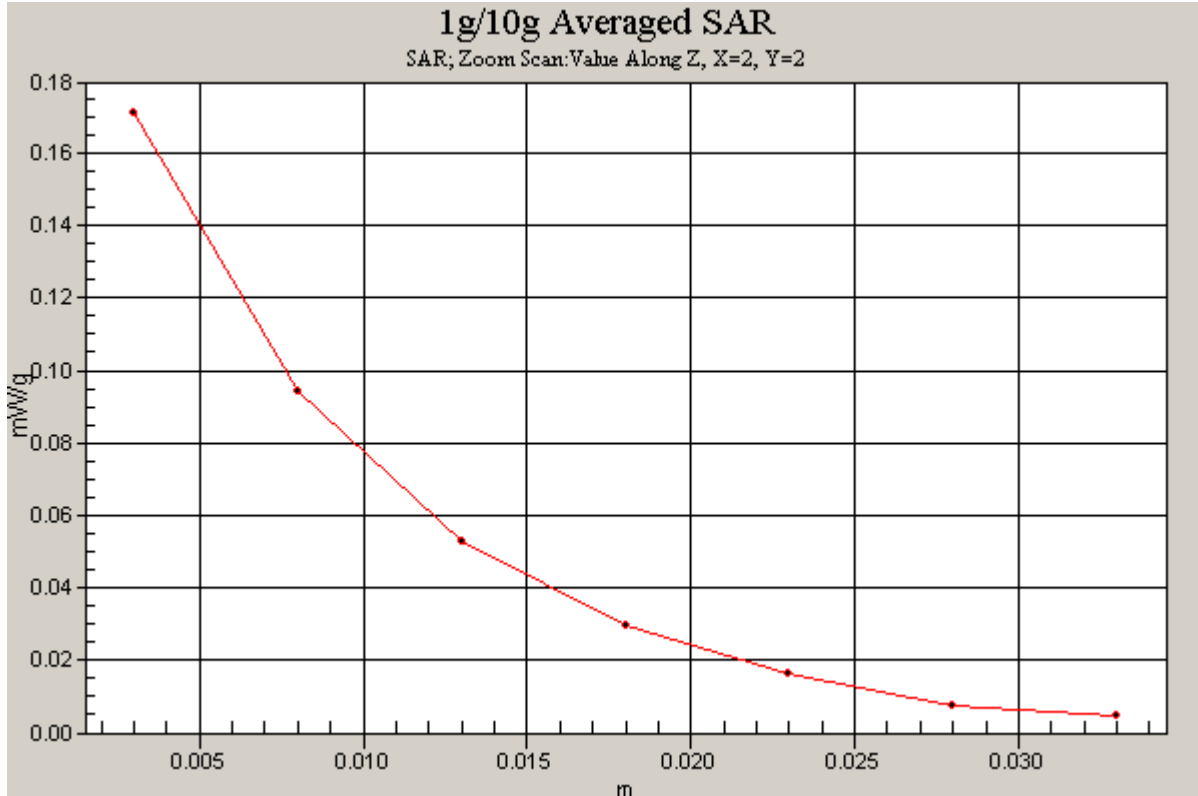

APPENDIX B: DIPOLE VALIDATION

PCTEST ENGINEERING LABORATORY, INC.

DUT: Dipole 835 MHz; Type: D835V2; Serial: 4d026

Communication System: CW; Frequency: 835 MHz; Duty Cycle: 1:1

Medium: 835 Brain; Medium parameters used:

$f = 835 \text{ MHz}$; $\sigma = 0.884 \text{ mho/m}$; $\epsilon_r = 42.4$; $\rho = 1000 \text{ kg/m}^3$

Phantom section: Flat Section ; Space: 1.5 cm

Test Date: 11-29-2010; Ambient Temp: 23.6 °C; Tissue Temp: 22.8 °C

Probe: EX3DV4 - SN3550; ConvF(8.28, 8.28, 8.28); Calibrated: 1/26/2010

Sensor-Surface: 4mm (Mechanical Surface Detection)

Electronics: DAE4 Sn649; Calibrated: 1/22/2010

Phantom: SAM Main; Type: SAM 4.0; Serial: TP-1114

Measurement SW: DASY4, V4.7 Build 80; Postprocessing SW: SEMCAD, V1.8 Build 186

835MHz SAR Verification

Area Scan (7x13x1): Measurement grid: dx=15mm, dy=15mm

Zoom Scan (5x5x7)/Cube 0: Measurement grid: dx=8mm, dy=8mm, dz=5mm

Input Power = 20.0 dBm (100 mW)

SAR(1 g) = 0.926 mW/g; SAR(10 g) = 0.600 mW/g

Deviation = -1.80 %

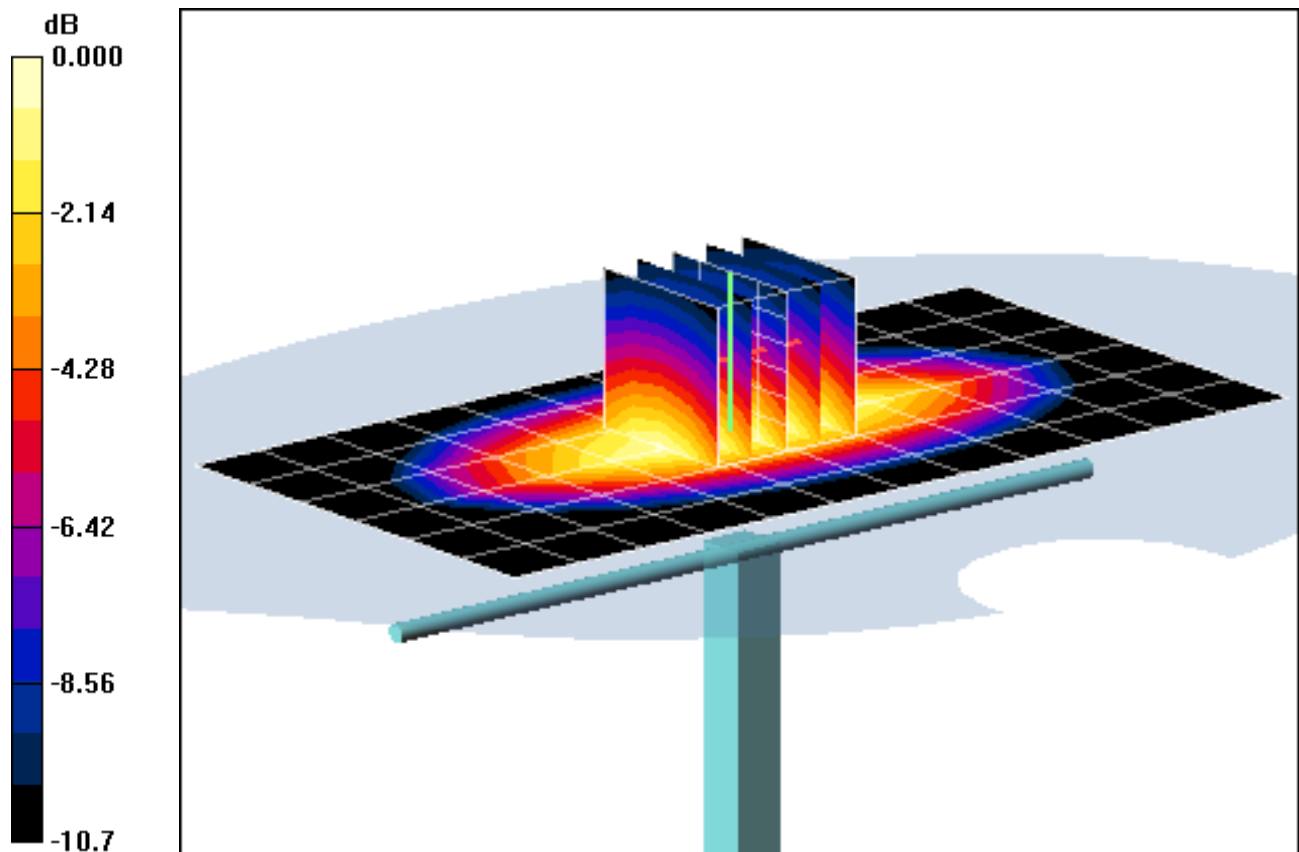

0 dB = 0.999mW/g

PCTEST ENGINEERING LABORATORY, INC.

DUT: SAR Dipole 1900 MHz; Type: D1900V2; Serial: 5d080

Communication System: CW; Frequency: 1900 MHz; Duty Cycle: 1:1

Medium: 1900 Brain; Medium parameters used (interpolated):

$f = 1900 \text{ MHz}$; $\sigma = 1.46 \text{ mho/m}$; $\epsilon_r = 40.5$; $\rho = 1000 \text{ kg/m}^3$

Phantom section: Flat Section; Space: 1.0 cm

Test Date: 12-01-2010; Ambient Temp: 23.9 °C; Tissue Temp: 22.3 °C

Probe: EX3DV4 - SN3550; ConvF(6.81, 6.81, 6.81); Calibrated: 1/26/2010

Sensor-Surface: 3mm (Mechanical Surface Detection)

Electronics: DAE4 Sn649; Calibrated: 1/22/2010

Phantom: SAM Main; Type: SAM 4.0; Serial: TP-1114

Measurement SW: DASY4, V4.7 Build 80; Postprocessing SW: SEMCAD, V1.8 Build 186

1900MHz System Verification

Area Scan (5x7x1): Measurement grid: dx=15mm, dy=15mm

Zoom Scan (5x5x7)/Cube 0: Measurement grid: dx=8mm, dy=8mm, dz=5mm

Input Power = 16.0 dBm (40 mW)

SAR(1 g) = 1.66 mW/g; SAR(10 g) = 0.848 mW/g

Deviation = 3.49 %

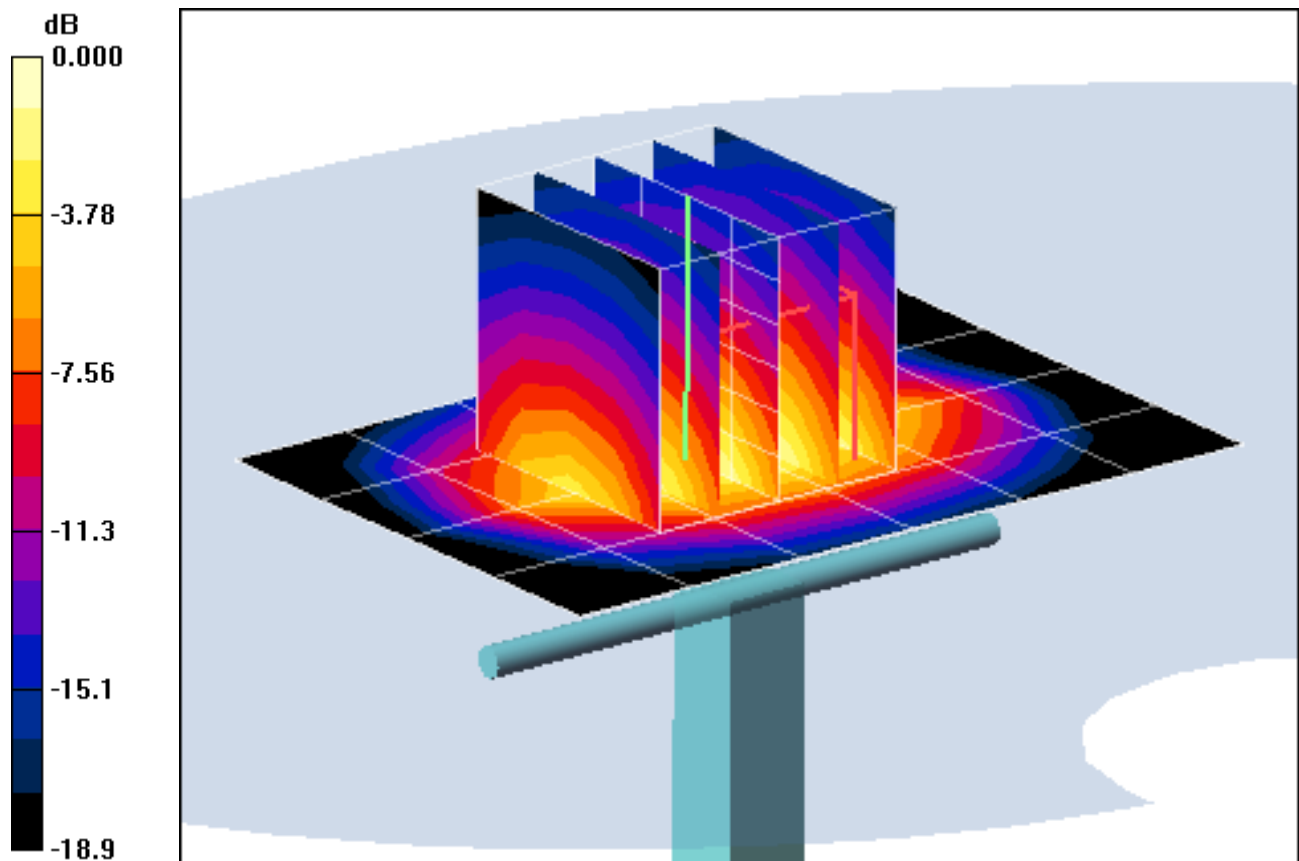

0 dB = 2.07mW/g

PCTEST ENGINEERING LABORATORY, INC.

DUT: SAR Dipole 2450 MHz; Type: D2450V2; Serial: 719

Communication System: CW; Frequency: 2450 MHz; Duty Cycle: 1:1

Medium: 2450 Brain; Medium parameters used:

$f = 2450 \text{ MHz}$; $\sigma = 1.87 \text{ mho/m}$; $\epsilon_r = 37.9$; $\rho = 1000 \text{ kg/m}^3$

Phantom section: Flat Section; Space: 1.0 cm

Test Date: 12-02-2010; Ambient Temp: 23.8 °C; Tissue Temp: 22.1 °C

Probe: EX3DV4 - SN3550; ConvF(6.21, 6.21, 6.21); Calibrated: 1/26/2010

Sensor-Surface: 3mm (Mechanical Surface Detection)

Electronics: DAE4 Sn649; Calibrated: 1/22/2010

Phantom: SAM Main; Type: SAM 4.0; Serial: TP-1114

Measurement SW: DASY4, V4.7 Build 80; Postprocessing SW: SEMCAD, V1.8 Build 186

2450MHz System Verification

Area Scan (5x7x1): Measurement grid: dx=15mm, dy=15mm

Zoom Scan (5x5x7)/Cube 0: Measurement grid: dx=8mm, dy=8mm, dz=5mm

Input Power = 16.0 dBm (40 mW)

SAR(1 g) = 2.2 mW/g; SAR(10 g) = 0.996 mW/g

Deviation = 2.80 %

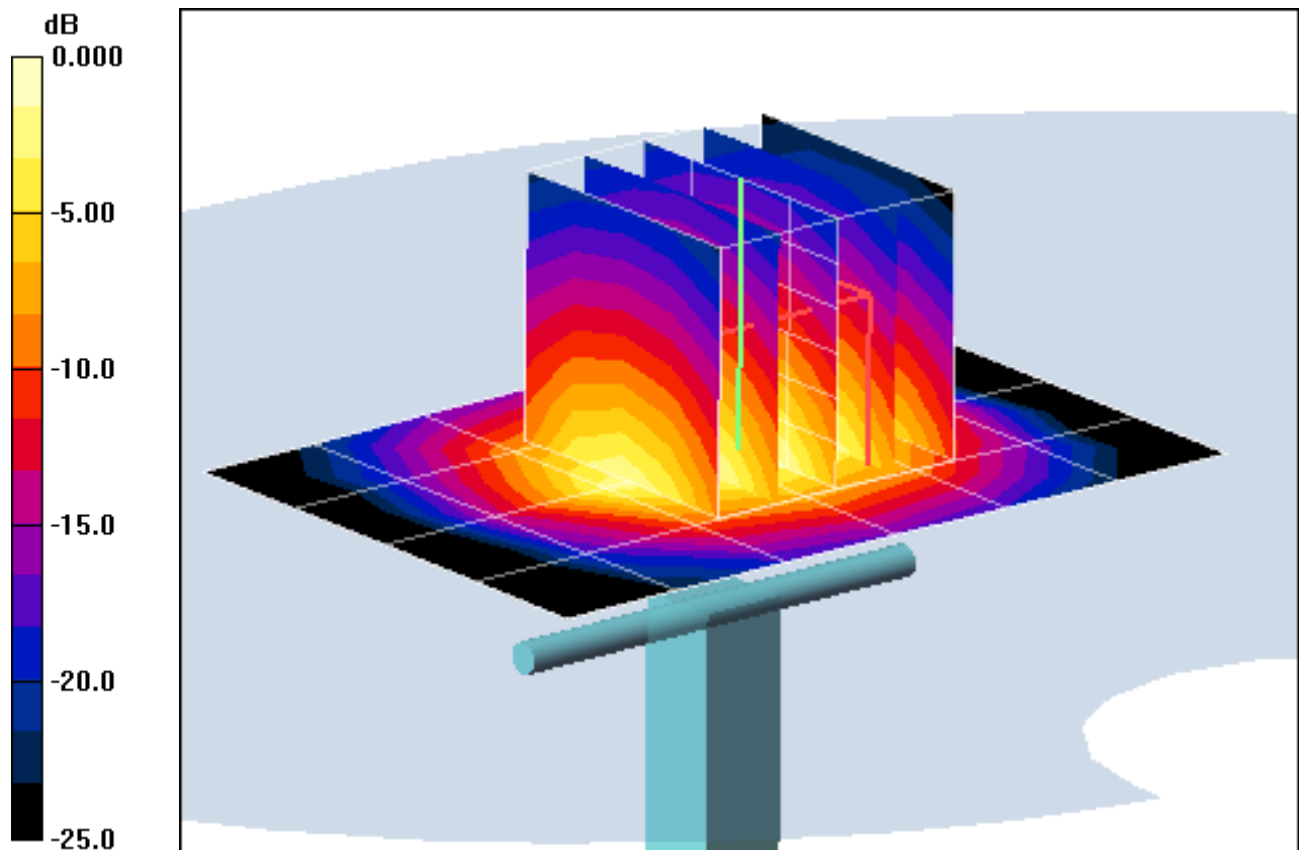

0 dB = 2.84mW/g

APPENDIX C: PROBE CALIBRATION



Accredited by the Swiss Accreditation Service (SAS)
The Swiss Accreditation Service is one of the signatories to the EA
Multilateral Agreement for the recognition of calibration certificates

Accreditation No.: SCS 108

Client **PC Test**

Certificate No: **EX3-3550_Jan10**

CALIBRATION CERTIFICATE

Object **EX3DV4 - SN:3550**

Calibration procedure(s) **QA CAL-01.v6, QA CAL-14.v3, QA CAL-23.v3 and QA CAL-25.v2
Calibration procedure for dosimetric E-field probes**

Calibration date: **January 26, 2010**

✓
1/26/10

This calibration certificate documents the traceability to national standards, which realize the physical units of measurements (SI).
The measurements and the uncertainties with confidence probability are given on the following pages and are part of the certificate.

All calibrations have been conducted in the closed laboratory facility: environment temperature (22 ± 3)°C and humidity < 70%.

Calibration Equipment used (M&TE critical for calibration)

Primary Standards	ID #	Cal Date (Certificate No.)	Scheduled Calibration
Power meter E4419B	GB41293874	1-Apr-09 (No. 217-01030)	Apr-10
Power sensor E4412A	MY41495277	1-Apr-09 (No. 217-01030)	Apr-10
Power sensor E4412A	MY41498087	1-Apr-09 (No. 217-01030)	Apr-10
Reference 3 dB Attenuator	SN: S5054 (3c)	31-Mar-09 (No. 217-01026)	Mar-10
Reference 20 dB Attenuator	SN: S5086 (20b)	31-Mar-09 (No. 217-01028)	Mar-10
Reference 30 dB Attenuator	SN: S5129 (30b)	31-Mar-09 (No. 217-01027)	Mar-10
Reference Probe ES3DV2	SN: 3013	30-Dec-09 (No. ES3-3013_Dec09)	Dec-10
DAE4	SN: 660	29-Sep-09 (No. DAE4-660_Sep09)	Sep-10
Secondary Standards	ID #	Check Date (in house)	Scheduled Check
RF generator HP 8648C	US3642U01700	4-Aug-99 (in house check Oct-09)	In house check: Oct-11
Network Analyzer HP 8753E	US37390585	18-Oct-01 (in house check Oct-09)	In house check: Oct10

Calibrated by:	Name Katja Pokovic	Function Technical Manager	Signature <i>[Signature]</i>
Approved by:	Name Fin Bornholt	R&D Director R&D Director	Signature <i>[Signature]</i>

Issued: January 26, 2010

This calibration certificate shall not be reproduced except in full without written approval of the laboratory.



Accredited by the Swiss Accreditation Service (SAS)

The Swiss Accreditation Service is one of the signatories to the EA
Multilateral Agreement for the recognition of calibration certificates

Accreditation No.: **SCS 108**

Glossary:

TSL	tissue simulating liquid
NORM _{x,y,z}	sensitivity in free space
ConvF	sensitivity in TSL / NORM _{x,y,z}
DCP	diode compression point
CF	crest factor (1/duty_cycle) of the RF signal
A, B, C	modulation dependent linearization parameters
Polarization φ	φ rotation around probe axis
Polarization ϑ	ϑ rotation around an axis that is in the plane normal to probe axis (at measurement center), i.e., $\vartheta = 0$ is normal to probe axis

Calibration is Performed According to the Following Standards:

- IEEE Std 1528-2003, "IEEE Recommended Practice for Determining the Peak Spatial-Averaged Specific Absorption Rate (SAR) in the Human Head from Wireless Communications Devices: Measurement Techniques", December 2003
- IEC 62209-1, "Procedure to measure the Specific Absorption Rate (SAR) for hand-held devices used in close proximity to the ear (frequency range of 300 MHz to 3 GHz)", February 2005

Methods Applied and Interpretation of Parameters:

- NORM_{x,y,z}**: Assessed for E-field polarization $\vartheta = 0$ ($f \leq 900$ MHz in TEM-cell; $f > 1800$ MHz: R22 waveguide). NORM_{x,y,z} are only intermediate values, i.e., the uncertainties of NORM_{x,y,z} does not effect the E²-field uncertainty inside TSL (see below ConvF).
- NORM(f)_{x,y,z} = NORM_{x,y,z} * frequency_response** (see Frequency Response Chart). This linearization is implemented in DASY4 software versions later than 4.2. The uncertainty of the frequency response is included in the stated uncertainty of ConvF.
- DCP_{x,y,z}**: DCP are numerical linearization parameters assessed based on the data of power sweep with CW signal (no uncertainty required). DCP does not depend on frequency nor media.
- A_{x,y,z}; B_{x,y,z}; C_{x,y,z}; VR_{x,y,z}; A, B, C** are numerical linearization parameters assessed based on the data of power sweep for specific modulation signal. The parameters do not depend on frequency nor media. VR is the maximum calibration range expressed in RMS voltage across the diode.
- ConvF and Boundary Effect Parameters**: Assessed in flat phantom using E-field (or Temperature Transfer Standard for $f \leq 800$ MHz) and inside waveguide using analytical field distributions based on power measurements for $f > 800$ MHz. The same setups are used for assessment of the parameters applied for boundary compensation (alpha, depth) of which typical uncertainty values are given. These parameters are used in DASY4 software to improve probe accuracy close to the boundary. The sensitivity in TSL corresponds to NORM_{x,y,z} * ConvF whereby the uncertainty corresponds to that given for ConvF. A frequency dependent ConvF is used in DASY version 4.4 and higher which allows extending the validity from ± 50 MHz to ± 100 MHz.
- Spherical isotropy (3D deviation from isotropy)**: in a field of low gradients realized using a flat phantom exposed by a patch antenna.
- Sensor Offset**: The sensor offset corresponds to the offset of virtual measurement center from the probe tip (on probe axis). No tolerance required.

Probe EX3DV4

SN:3550

Manufactured:	May 19, 2004
Last calibrated:	January 21, 2009
Recalibrated:	January 26, 2010

Calibrated for DASY Systems

(Note: non-compatible with DASY2 system!)

DASY - Parameters of Probe: EX3DV4 SN:3550**Basic Calibration Parameters**

	Sensor X	Sensor Y	Sensor Z	Unc (k=2)
Norm ($\mu\text{V}/(\text{V}/\text{m})^2$) ^A	0.48	0.47	0.48	± 10.1%
DCP (mV) ^B	92.9	88.4	91.4	

Modulation Calibration Parameters

UID	Communication System Name	PAR		A dB	B dBuV	C	VR mV	Unc ^E (k=2)
10000	CW	0.00	X	0.00	0.00	1.00	300	± 1.5%
			Y	0.00	0.00	1.00	300	
			Z	0.00	0.00	1.00	300	

The reported uncertainty of measurement is stated as the standard uncertainty of measurement multiplied by the coverage factor k=2, which for a normal distribution corresponds to a coverage probability of approximately 95%.

^A The uncertainties of NormX,Y,Z do not affect the E²-field uncertainty inside TSL (see Pages 5 and 6).

^B Numerical linearization parameter: uncertainty not required.

^E Uncertainty is determined using the maximum deviation from linear response applying rectangular distribution and is expressed for the square of the field value.

DASY - Parameters of Probe: EX3DV4 SN:3550

Calibration Parameter Determined in Head Tissue Simulating Media

f [MHz]	Validity [MHz] ^c	Permittivity	Conductivity	ConvF X	ConvF Y	ConvF Z	Alpha	Depth Unc (k=2)
835	± 50 / ± 100	41.5 ± 5%	0.90 ± 5%	8.28	8.28	8.28	0.45	0.70 ± 11.0%
1750	± 50 / ± 100	40.1 ± 5%	1.37 ± 5%	7.03	7.03	7.03	0.39	0.75 ± 11.0%
1900	± 50 / ± 100	40.0 ± 5%	1.40 ± 5%	6.81	6.81	6.81	0.32	0.81 ± 11.0%
2450	± 50 / ± 100	39.2 ± 5%	1.80 ± 5%	6.21	6.21	6.21	0.22	1.07 ± 11.0%

^c The validity of ± 100 MHz only applies for DASY v4.4 and higher (see Page 2). The uncertainty is the RSS of the ConvF uncertainty at calibration frequency and the uncertainty for the indicated frequency band.

DASY - Parameters of Probe: EX3DV4 SN:3550

Calibration Parameter Determined in Body Tissue Simulating Media

f [MHz]	Validity [MHz] ^c	Permittivity	Conductivity	ConvF X	ConvF Y	ConvF Z	Alpha	Depth Unc (k=2)
835	± 50 / ± 100	55.2 ± 5%	0.97 ± 5%	8.30	8.30	8.30	0.47	0.76 ± 11.0%
1750	± 50 / ± 100	53.4 ± 5%	1.49 ± 5%	6.90	6.90	6.90	0.49	0.69 ± 11.0%
1900	± 50 / ± 100	53.3 ± 5%	1.52 ± 5%	6.63	6.63	6.63	0.76	0.54 ± 11.0%
2450	± 50 / ± 100	52.7 ± 5%	1.95 ± 5%	6.40	6.40	6.40	0.22	1.09 ± 11.0%
2600	± 50 / ± 100	52.5 ± 5%	2.16 ± 5%	6.26	6.26	6.26	0.19	1.42 ± 11.0%
4950	± 50 / ± 100	49.4 ± 5%	5.01 ± 5%	3.64	3.64	3.64	0.50	1.75 ± 13.1%
5200	± 50 / ± 100	49.0 ± 5%	5.30 ± 5%	3.73	3.73	3.73	0.50	1.75 ± 13.1%
5300	± 50 / ± 100	48.5 ± 5%	5.42 ± 5%	3.52	3.52	3.52	0.52	1.75 ± 13.1%
5500	± 50 / ± 100	48.6 ± 5%	5.65 ± 5%	3.26	3.26	3.26	0.55	1.80 ± 13.1%
5600	± 50 / ± 100	48.5 ± 5%	5.77 ± 5%	3.16	3.16	3.16	0.65	1.80 ± 13.1%
5800	± 50 / ± 100	48.2 ± 5%	6.00 ± 5%	3.30	3.30	3.30	0.60	1.75 ± 13.1%

^c The validity of ± 100 MHz only applies for DASY v4.4 and higher (see Page 2). The uncertainty is the RSS of the ConvF uncertainty at calibration frequency and the uncertainty for the indicated frequency band.

Frequency Response of E-Field

(TEM-Cell:ifi110 EXX, Waveguide: R22)

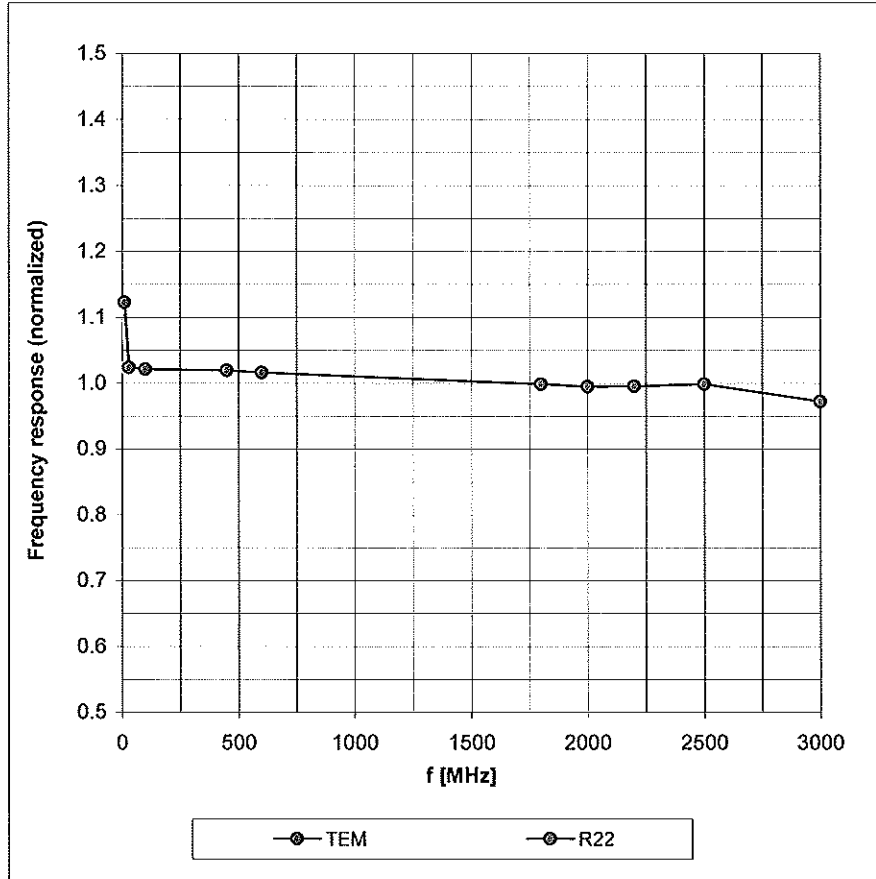

Uncertainty of Frequency Response of E-field: $\pm 6.3\%$ (k=2)

Receiving Pattern (ϕ), $\vartheta = 0^\circ$

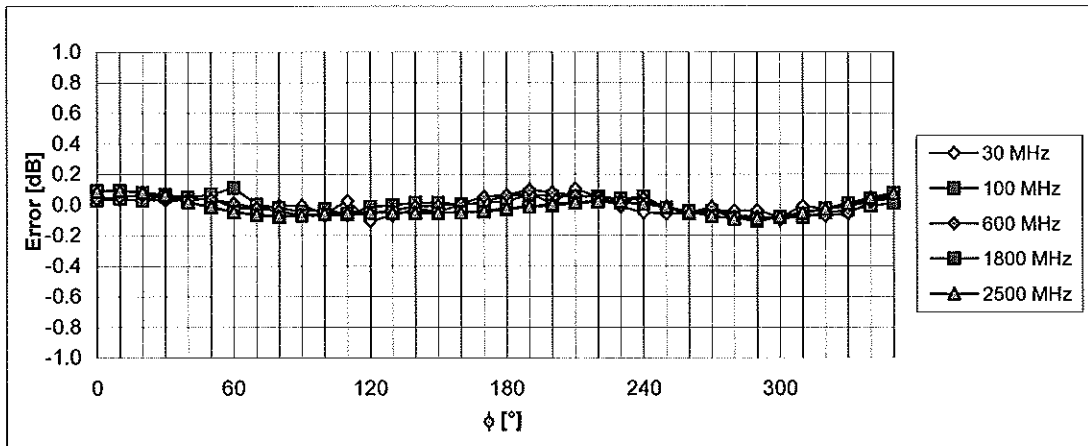
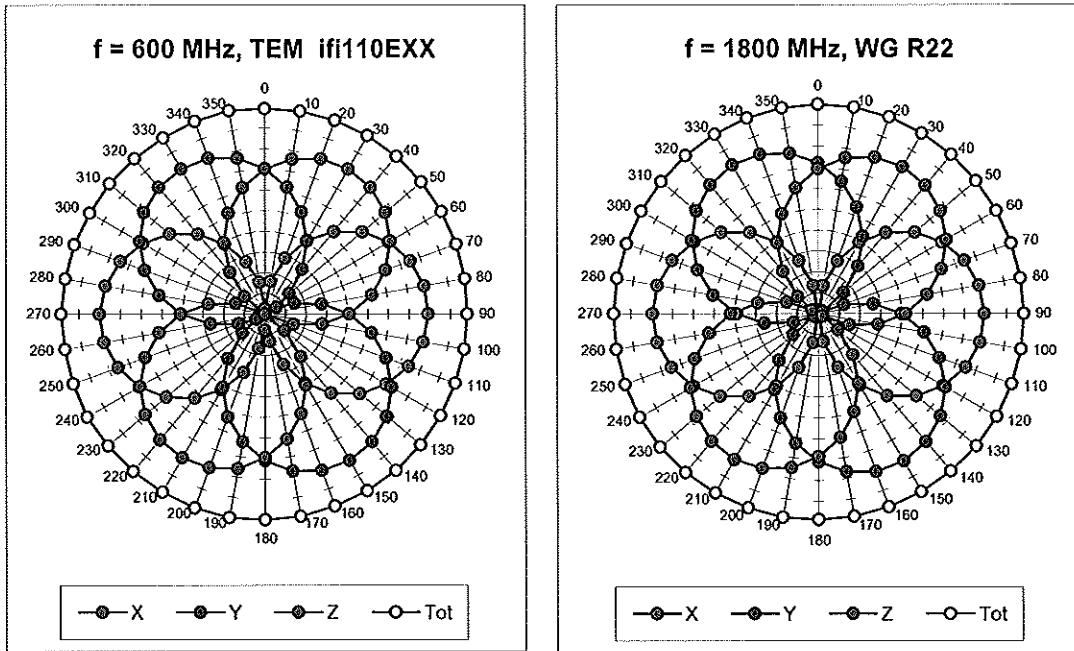

Uncertainty of Axial Isotropy Assessment: $\pm 0.5\%$ ($k=2$)

Dynamic Range $f(SAR_{head})$ (Waveguide R22, $f = 1800$ MHz)

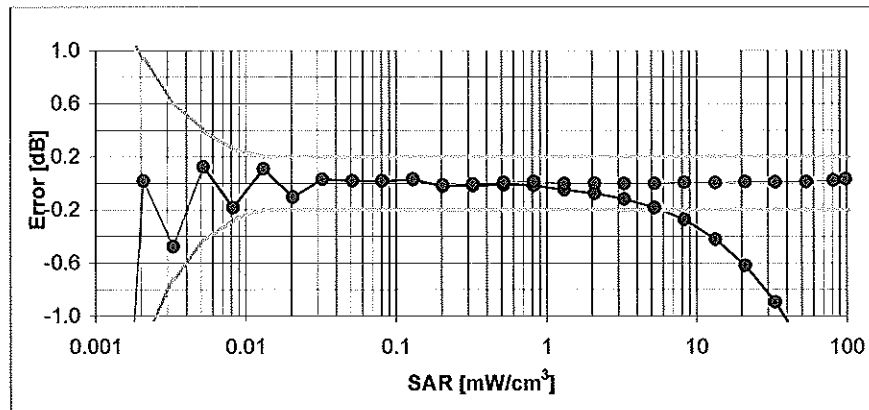
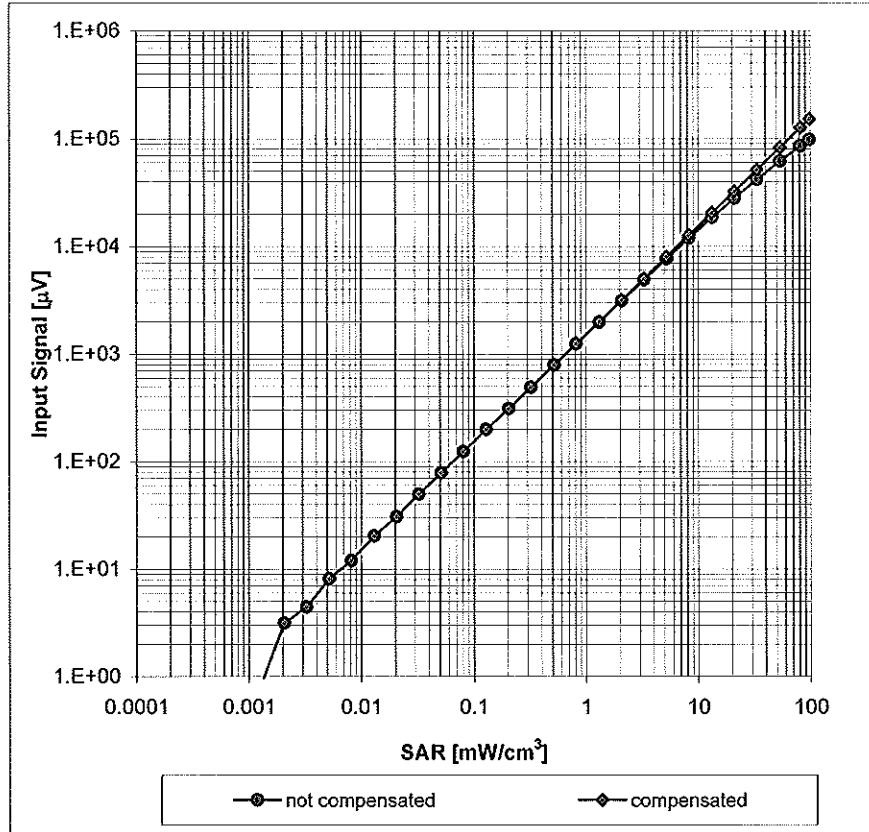

Uncertainty of Linearity Assessment: $\pm 0.6\%$ ($k=2$)

Conversion Factor Assessment

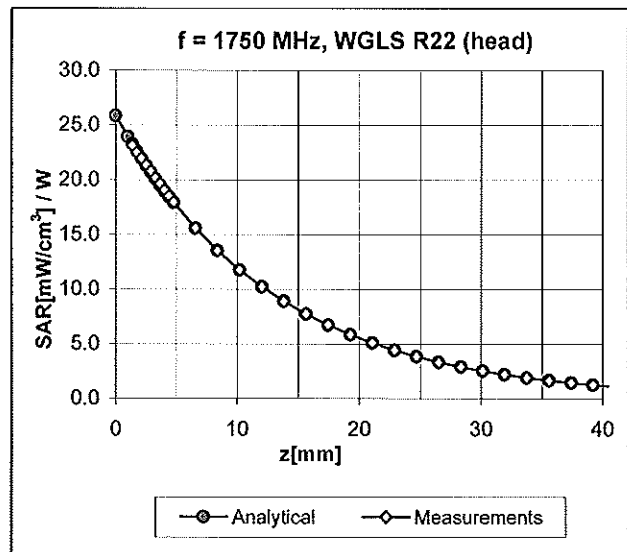
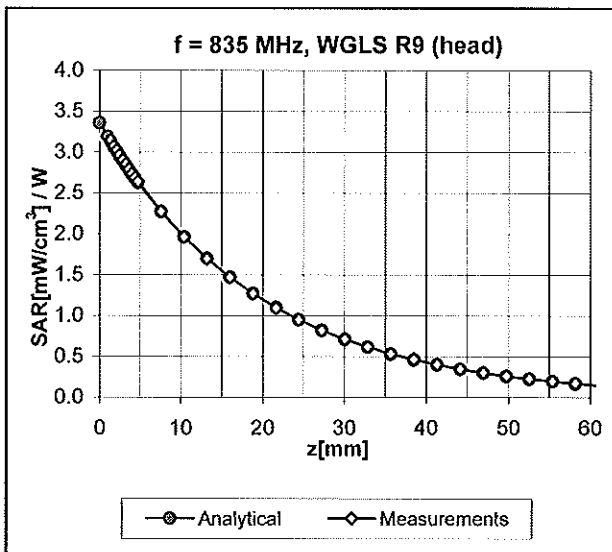

Deviation from Isotropy in HSL

Error (ϕ, θ), f = 900 MHz

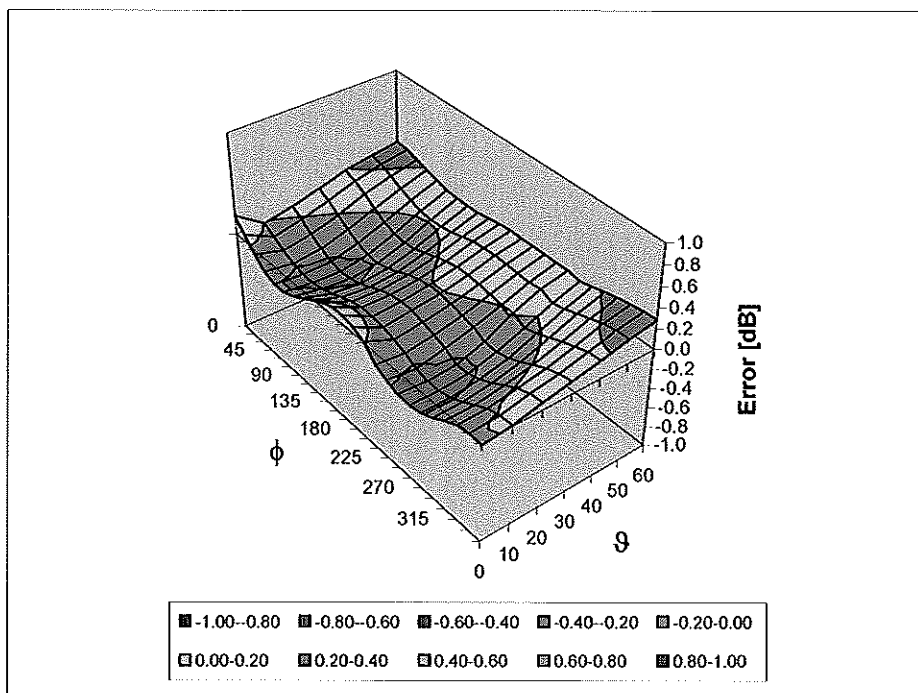

Uncertainty of Spherical Isotropy Assessment: $\pm 2.6\%$ (k=2)

Other Probe Parameters

Sensor Arrangement	Triangular
Connector Angle (°)	Not applicable
Mechanical Surface Detection Mode	enabled
Optical Surface Detection Mode	disabled
Probe Overall Length	337 mm
Probe Body Diameter	10 mm
Tip Length	9 mm
Tip Diameter	2.5 mm
Probe Tip to Sensor X Calibration Point	1 mm
Probe Tip to Sensor Y Calibration Point	1 mm
Probe Tip to Sensor Z Calibration Point	1 mm
Recommended Measurement Distance from Surface	2 mm



Accredited by the Swiss Accreditation Service (SAS)
The Swiss Accreditation Service is one of the signatories to the EA
Multilateral Agreement for the recognition of calibration certificates

Accreditation No.: **SCS 108**

Client **PC Test**

Certificate No: **D835V2-4d026_Aug09**

CALIBRATION CERTIFICATE

Object **D835V2 - SN: 4d026**

Calibration procedure(s) **QA CAL-05.v7
Calibration procedure for dipole validation kits**

Calibration date: **August 24, 2009**

Condition of the calibrated item **In Tolerance**

This calibration certificate documents the traceability to national standards, which realize the physical units of measurements (SI).
The measurements and the uncertainties with confidence probability are given on the following pages and are part of the certificate.

All calibrations have been conducted in the closed laboratory facility: environment temperature (22 ± 3)°C and humidity < 70%.

Calibration Equipment used (M&TE critical for calibration)

Primary Standards	ID #	Cal Date (Certificate No.)	Scheduled Calibration
Power meter EPM-442A	GB37480704	08-Oct-08 (No. 217-00898)	Oct-09
Power sensor HP 8481A	US37292783	08-Oct-08 (No. 217-00898)	Oct-09
Reference 20 dB Attenuator	SN: 5086 (20g)	31-Mar-09 (No. 217-01025)	Mar-10
Type-N mismatch combination	SN: 5047.2 / 06327	31-Mar-09 (No. 217-01029)	Mar-10
Reference Probe ES3DV3	SN: 3205	26-Jun-09 (No. ES3-3205_Jun09)	Jun-10
DAE4	SN: 601	07-Mar-09 (No. DAE4-601_Mar09)	Mar-10

Secondary Standards	ID #	Check Date (In house)	Scheduled Check
Power sensor HP 8481A	MY41092317	18-Oct-02 (in house check Oct-07)	In house check: Oct-09
RF generator R&S SMT-06	100005	4-Aug-99 (in house check Oct-07)	In house check: Oct-09
Network Analyzer HP 8753E	US37390585 S4206	18-Oct-01 (in house check Oct-08)	In house check: Oct-09

	Name	Function	Signature
Calibrated by:	Jeton Kastrati	Laboratory Technician	
Approved by:	Katja Pokovic	Technical Manager	

✓ok
sz
8/31/09

Issued: August 25, 2009

This calibration certificate shall not be reproduced except in full without written approval of the laboratory.



Accredited by the Swiss Accreditation Service (SAS)
The Swiss Accreditation Service is one of the signatories to the EA
Multilateral Agreement for the recognition of calibration certificates

Accreditation No.: **SCS 108**

Glossary:

TSL	tissue simulating liquid
ConvF	sensitivity in TSL / NORM x,y,z
N/A	not applicable or not measured

Calibration is Performed According to the Following Standards:

- a) IEEE Std 1528-2003, "IEEE Recommended Practice for Determining the Peak Spatial-Averaged Specific Absorption Rate (SAR) in the Human Head from Wireless Communications Devices: Measurement Techniques", December 2003
- b) IEC 62209-1, "Procedure to measure the Specific Absorption Rate (SAR) for hand-held devices used in close proximity to the ear (frequency range of 300 MHz to 3 GHz)", February 2005
- c) Federal Communications Commission Office of Engineering & Technology (FCC OET), "Evaluating Compliance with FCC Guidelines for Human Exposure to Radiofrequency Electromagnetic Fields; Additional Information for Evaluating Compliance of Mobile and Portable Devices with FCC Limits for Human Exposure to Radiofrequency Emissions", Supplement C (Edition 01-01) to Bulletin 65

Additional Documentation:

- d) DASY4/5 System Handbook

Methods Applied and Interpretation of Parameters:

- *Measurement Conditions:* Further details are available from the Validation Report at the end of the certificate. All figures stated in the certificate are valid at the frequency indicated.
- *Antenna Parameters with TSL:* The dipole is mounted with the spacer to position its feed point exactly below the center marking of the flat phantom section, with the arms oriented parallel to the body axis.
- *Feed Point Impedance and Return Loss:* These parameters are measured with the dipole positioned under the liquid filled phantom. The impedance stated is transformed from the measurement at the SMA connector to the feed point. The Return Loss ensures low reflected power. No uncertainty required.
- *Electrical Delay:* One-way delay between the SMA connector and the antenna feed point. No uncertainty required.
- *SAR measured:* SAR measured at the stated antenna input power.
- *SAR normalized:* SAR as measured, normalized to an input power of 1 W at the antenna connector.
- *SAR for nominal TSL parameters:* The measured TSL parameters are used to calculate the nominal SAR result.

Measurement Conditions

DASY system configuration, as far as not given on page 1.

DASY Version	DASY5	V5.0
Extrapolation	Advanced Extrapolation	
Phantom	Modular Flat Phantom V4.9	
Distance Dipole Center - TSL	15 mm	with Spacer
Zoom Scan Resolution	dx, dy, dz = 5 mm	
Frequency	835 MHz \pm 1 MHz	

Head TSL parameters

The following parameters and calculations were applied.

	Temperature	Permittivity	Conductivity
Nominal Head TSL parameters	22.0 °C	41.5	0.90 mho/m
Measured Head TSL parameters	(22.0 \pm 0.2) °C	41.2 \pm 6 %	0.90 mho/m \pm 6 %
Head TSL temperature during test	(22.0 \pm 0.2) °C	----	----

SAR result with Head TSL

SAR averaged over 1 cm ³ (1 g) of Head TSL	Condition	
SAR measured	250 mW input power	2.37 mW / g
SAR normalized	normalized to 1W	9.48 mW / g
SAR for nominal Head TSL parameters ¹	normalized to 1W	9.46 mW / g \pm 17.0 % (k=2)

SAR averaged over 10 cm ³ (10 g) of Head TSL	condition	
SAR measured	250 mW input power	1.55 mW / g
SAR normalized	normalized to 1W	6.20 mW / g
SAR for nominal Head TSL parameters ¹	normalized to 1W	6.19 mW / g \pm 16.5 % (k=2)

¹ Correction to nominal TSL parameters according to d), chapter "SAR Sensitivities"

Body TSL parameters

The following parameters and calculations were applied.

	Temperature	Permittivity	Conductivity
Nominal Body TSL parameters	22.0 °C	55.2	0.97 mho/m
Measured Body TSL parameters	(22.0 ± 0.2) °C	53.4 ± 6 %	0.99 mho/m ± 6 %
Body TSL temperature during test	(22.5 ± 0.2) °C	----	----

SAR result with Body TSL

SAR averaged over 1 cm ³ (1 g) of Body TSL	Condition	
SAR measured	250 mW input power	2.50 mW / g
SAR normalized	normalized to 1W	10.0 mW / g
SAR for nominal Body TSL parameters ²	normalized to 1W	9.78 mW / g ± 17.0 % (k=2)

SAR averaged over 10 cm ³ (10 g) of Body TSL	condition	
SAR measured	250 mW input power	1.63 mW / g
SAR normalized	normalized to 1W	6.52 mW / g
SAR for nominal Body TSL parameters ²	normalized to 1W	6.42 mW / g ± 16.5 % (k=2)

² Correction to nominal TSL parameters according to d), chapter "SAR Sensitivities"

Appendix

Antenna Parameters with Head TSL

Impedance, transformed to feed point	51.0 Ω - 7.5 j Ω
Return Loss	- 22.5 dB

Antenna Parameters with Body TSL

Impedance, transformed to feed point	46.9 Ω - 8.6 j Ω
Return Loss	- 20.6 dB

General Antenna Parameters and Design

Electrical Delay (one direction)	1.388 ns
----------------------------------	----------

After long term use with 100W radiated power, only a slight warming of the dipole near the feedpoint can be measured.

The dipole is made of standard semirigid coaxial cable. The center conductor of the feeding line is directly connected to the second arm of the dipole. The antenna is therefore short-circuited for DC-signals.

No excessive force must be applied to the dipole arms, because they might bend or the soldered connections near the feedpoint may be damaged.

Additional EUT Data

Manufactured by	SPEAG
Manufactured on	December 17, 2004

DASY5 Validation Report for Head TSL

Date/Time: 24.08.2009 13:11:23

Test Laboratory: SPEAG, Zurich, Switzerland

DUT: Dipole 835 MHz; Type: D835V2; Serial: D835V2 - SN:4d026

Communication System: CW-835; Frequency: 835 MHz; Duty Cycle: 1:1

Medium: HSL 900 MHz

Medium parameters used: $f = 835$ MHz; $\sigma = 0.9$ mho/m; $\epsilon_r = 41.2$; $\rho = 1000$ kg/m³

Phantom section: Flat Section

Measurement Standard: DASY5 (IEEE/IEC)

DASY5 Configuration:

- Probe: ES3DV3 - SN3205; ConvF(6.04, 6.04, 6.04); Calibrated: 26.06.2009
- Sensor-Surface: 3mm (Mechanical Surface Detection)
- Electronics: DAE4 Sn601; Calibrated: 07.03.2009
- Phantom: Flat Phantom 4.9L; Type: QD000P49AA; Serial: 1001
- Measurement SW: DASY5, V5.0 Build 120; SEMCAD X Version 13.4 Build 45

Pin=250mW; dip=15mm/Zoom Scan (7x7x7)/Cube 0: Measurement grid: dx=5mm, dy=5mm, dz=5mm

Reference Value = 57.1 V/m; Power Drift = 0.016 dB

Peak SAR (extrapolated) = 3.55 W/kg

SAR(1 g) = 2.37 mW/g; SAR(10 g) = 1.55 mW/g

Maximum value of SAR (measured) = 2.77 mW/g

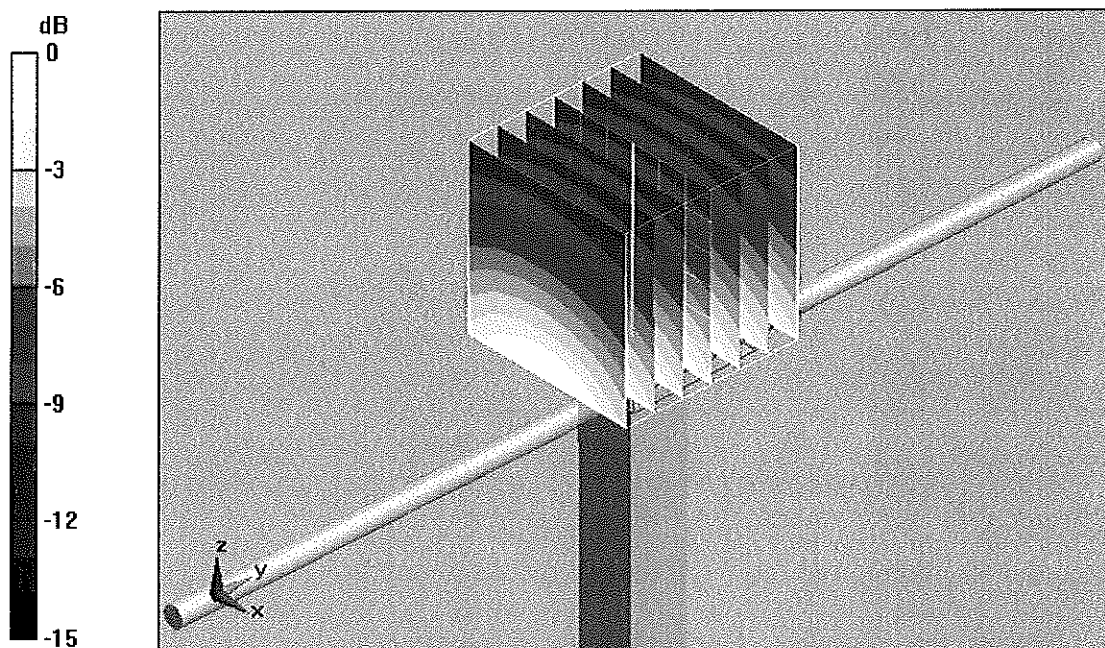

0 dB = 2.77mW/g

Impedance Measurement Plot for Head TSL

24 Aug 2009 11:32:41

CH1 S11 1 U FS 1: 50.971 Ω -7.4922 Ω 25.440 pF 835.000 000 MHz

*
De1
CA

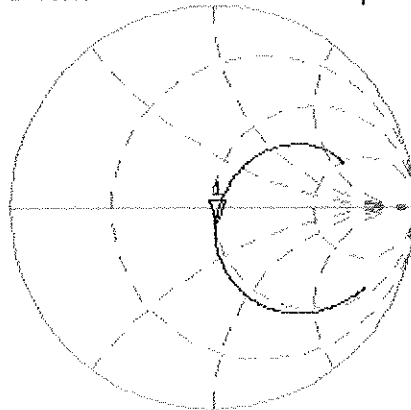

Avg
16
↑

CH2 S11 LOG 5 dB/REF -20 dB 1: -22.544 dB 835.000 000 MHz

CA
Avg
16
↑

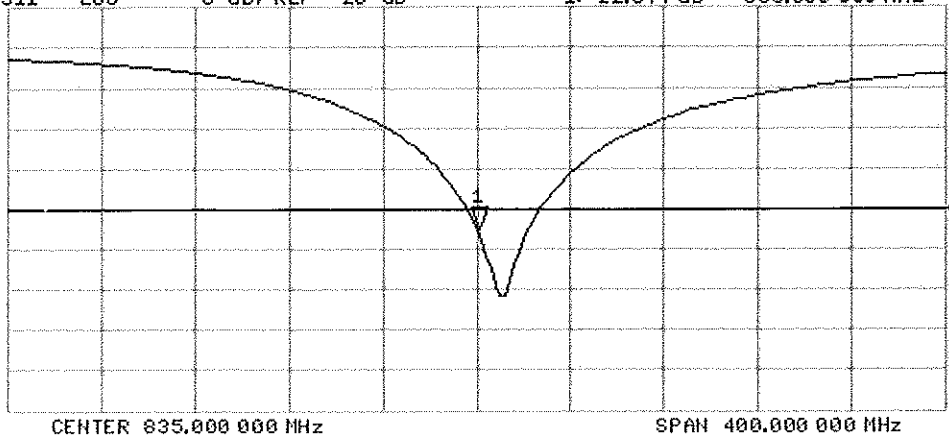

DASY5 Validation Report for Body TSL

Date/Time: 17.08.2009 09:50:53

Test Laboratory: SPEAG, Zurich, Switzerland

DUT: Dipole 835 MHz; Type: D835V2; Serial: D835V2 - SN:4d026

Communication System: CW; Frequency: 835 MHz; Duty Cycle: 1:1

Medium: MSL900

Medium parameters used: $f = 835$ MHz; $\sigma = 0.99$ mho/m; $\epsilon_r = 53.4$; $\rho = 1000$ kg/m³

Phantom section: Flat Section

Measurement Standard: DASY5 (IEEE/IEC)

DASY5 Configuration:

- Probe: ES3DV3 - SN3205; ConvF(5.97, 5.97, 5.97); Calibrated: 26.06.2009
- Sensor-Surface: 3mm (Mechanical Surface Detection)
- Electronics: DAE4 Sn601; Calibrated: 07.03.2009
- Phantom: Flat Phantom 4.9L; Type: QD000P49AA; Serial: 1001
- Measurement SW: DASY5, V5.0 Build 120; SEMCAD X Version 13.4 Build 45

Pin = 250mW, d = 15mm/Zoom Scan (7x7x7)/Cube 0: Measurement grid: dx=5mm, dy=5mm, dz=5mm

Reference Value = 55.8 V/m; Power Drift = 0.014 dB

Peak SAR (extrapolated) = 3.71 W/kg

SAR(1 g) = 2.5 mW/g; SAR(10 g) = 1.63 mW/g

Maximum value of SAR (measured) = 2.92 mW/g

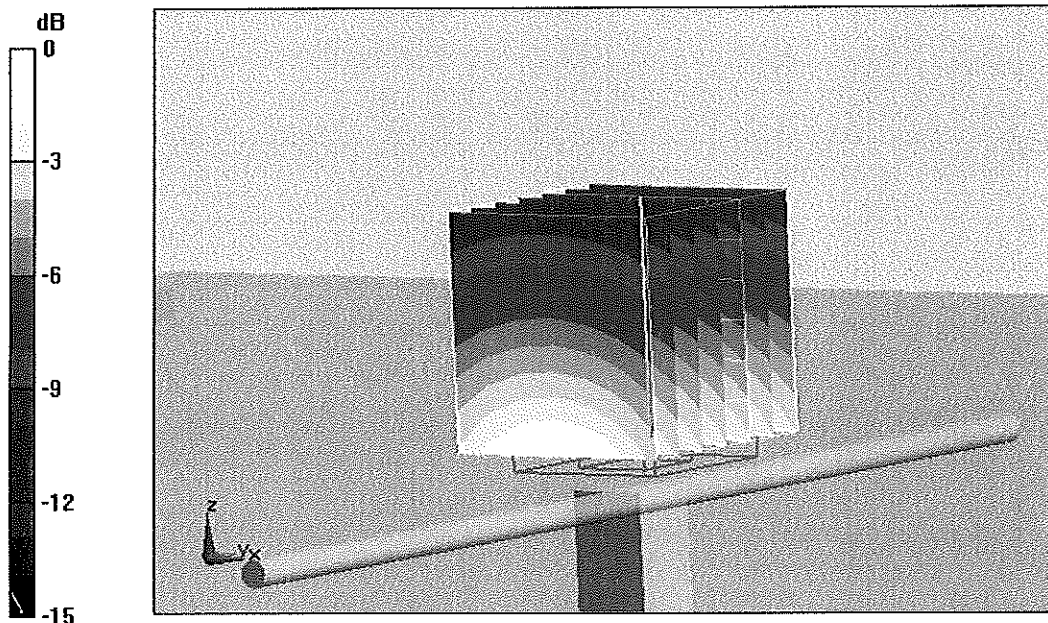

0 dB = 2.92mW/g

Impedance Measurement Plot for Body TSL

17 Aug 2009 08:48:23

CH1 S11 1 U FS 1: 46.928 Ω -8.5547 Ω 22.281 pF 835.000 000 MHz

*
Del
Cor
Avg
16
↑

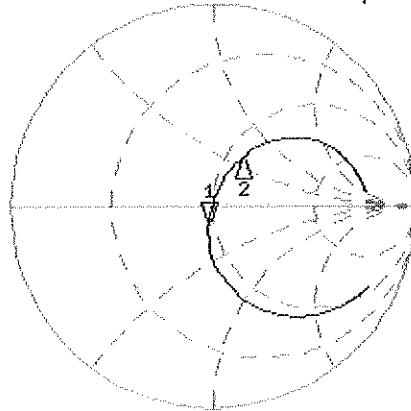

CH1 Markers
2: 58.551 Ω
30.164 Ω
900.000 MHz

CH2 S11 LOG 5 dB/REF -20 dB 1: -20.592 dB 835.000 000 MHz

Cor
Avg
16
↑

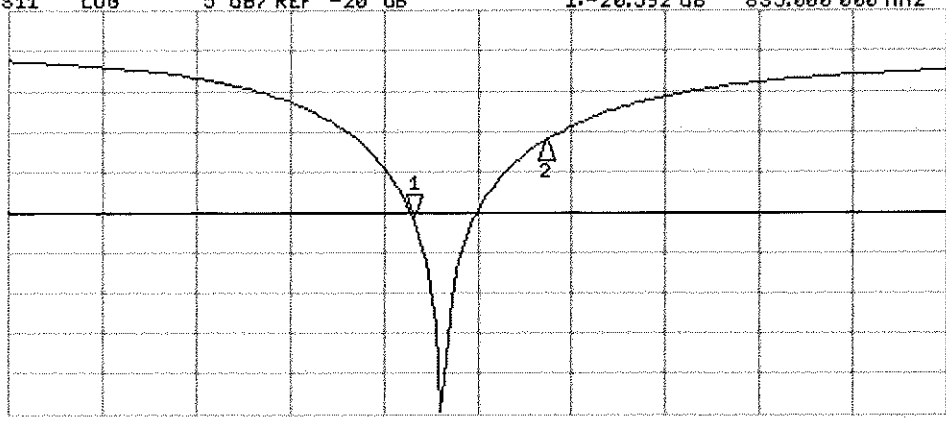

CH2 Markers
2: -11.110 dB
900.000 MHz

START 635.000 000 MHz

STOP 1 100.000 000 MHz



Accredited by the Swiss Accreditation Service (SAS)
The Swiss Accreditation Service is one of the signatories to the EA
Multilateral Agreement for the recognition of calibration certificates

Accreditation No.: **SCS 108**

Client **PC Test**

Certificate No: **D1900V2-5d080-Aug09**

CALIBRATION CERTIFICATE

Object **D1900V2 - SN: 5d080**

Calibration procedure(s) **QA CAL-05.v7
Calibration procedure for dipole validation kits**

Calibration date: **August 18, 2009**

Condition of the calibrated item **In Tolerance**

This calibration certificate documents the traceability to national standards, which realize the physical units of measurements (SI).
The measurements and the uncertainties with confidence probability are given on the following pages and are part of the certificate.

All calibrations have been conducted in the closed laboratory facility: environment temperature (22 ± 3)°C and humidity < 70%.

Calibration Equipment used (M&TE critical for calibration)

Primary Standards	ID #	Cal Date (Calibrated by, Certificate No.)	Scheduled Calibration
Power meter EPM-442A	GB37480704	08-Oct-08 (No. 217-00898)	Oct-09
Power sensor HP 8481A	US37292783	08-Oct-08 (No. 217-00898)	Oct-09
Reference 20 dB Attenuator	SN: 5086 (20g)	31-Mar-09 (No. 217-01025)	Mar-10
Type-N mismatch combination	SN: 5047.2 / 06327	31-Mar-09 (No. 217-01029)	Mar-10
Reference Probe ES3DV3	SN: 3205	26-Jun-09 (No. ES3-3205_Jun09)	Jun-10
DAE4	SN: 601	07-Mar-09 (No. DAE4-601_Mar09)	Mar-10
Secondary Standards	ID #	Check Date (in house)	Scheduled Check
Power sensor HP 8481A	MY41092317	18-Oct-02 (in house check Oct-07)	In house check: Oct-09
RF generator R&S SMT-06	100005	4-Aug-99 (in house check Oct-07)	In house check: Oct-09
Network Analyzer HP 8753E	US37390585 S4206	18-Oct-01 (in house check Oct-08)	In house check: Oct-09

Calibrated by: **Claudio Leubler** (Laboratory Technician) *[Signature]*

Approved by: **Katja Pokovic** (Technical Manager) *[Signature]*

Issued: August 19, 2009
This calibration certificate shall not be reproduced except in full without written approval of the laboratory.

*OK ✓
8/31/09*



Accredited by the Swiss Accreditation Service (SAS)
The Swiss Accreditation Service is one of the signatories to the EA
Multilateral Agreement for the recognition of calibration certificates

Accreditation No.: **SCS 108**

Glossary:

TSL	tissue simulating liquid
ConvF	sensitivity in TSL / NORM x,y,z
N/A	not applicable or not measured

Calibration is Performed According to the Following Standards:

- IEEE Std 1528-2003, "IEEE Recommended Practice for Determining the Peak Spatial-Averaged Specific Absorption Rate (SAR) in the Human Head from Wireless Communications Devices: Measurement Techniques", December 2003
- CENELEC EN 50361, "Basic standard for the measurement of Specific Absorption Rate related to human exposure to electromagnetic fields from mobile phones (300 MHz - 3 GHz), July 2001
- Federal Communications Commission Office of Engineering & Technology (FCC OET), "Evaluating Compliance with FCC Guidelines for Human Exposure to Radiofrequency Electromagnetic Fields; Additional Information for Evaluating Compliance of Mobile and Portable Devices with FCC Limits for Human Exposure to Radiofrequency Emissions", Supplement C (Edition 01-01) to Bulletin 65

Additional Documentation:

- DASY4/5 System Handbook

Methods Applied and Interpretation of Parameters:

- Measurement Conditions:** Further details are available from the Validation Report at the end of the certificate. All figures stated in the certificate are valid at the frequency indicated.
- Antenna Parameters with TSL:** The dipole is mounted with the spacer to position its feed point exactly below the center marking of the flat phantom section, with the arms oriented parallel to the body axis.
- Feed Point Impedance and Return Loss:** These parameters are measured with the dipole positioned under the liquid filled phantom. The impedance stated is transformed from the measurement at the SMA connector to the feed point. The Return Loss ensures low reflected power. No uncertainty required.
- Electrical Delay:** One-way delay between the SMA connector and the antenna feed point. No uncertainty required.
- SAR measured:** SAR measured at the stated antenna input power.
- SAR normalized:** SAR as measured, normalized to an input power of 1 W at the antenna connector.
- SAR for nominal TSL parameters:** The measured TSL parameters are used to calculate the nominal SAR result.

Measurement Conditions

DASY system configuration, as far as not given on page 1.

DASY Version	DASY5	V5.0
Extrapolation	Advanced Extrapolation	
Phantom	Modular Flat Phantom V5.0	
Distance Dipole Center - TSL	10 mm	with Spacer
Zoom Scan Resolution	dx, dy, dz = 5 mm	
Frequency	1900 MHz \pm 1 MHz	

Head TSL parameters

The following parameters and calculations were applied.

	Temperature	Permittivity	Conductivity
Nominal Head TSL parameters	22.0 °C	40.0	1.40 mho/m
Measured Head TSL parameters	(22.0 \pm 0.2) °C	40.8 \pm 6 %	1.45 mho/m \pm 6 %
Head TSL temperature during test	(22.0 \pm 0.2) °C	----	----

SAR result with Head TSL

SAR averaged over 1 cm³ (1 g) of Head TSL	condition	
SAR measured	250 mW input power	10.2 mW / g
SAR normalized	normalized to 1W	40.8 mW / g
SAR for nominal Head TSL parameters ¹	normalized to 1W	40.1 mW / g \pm 17.0 % (k=2)

SAR averaged over 10 cm³ (10 g) of Head TSL	Condition	
SAR measured	250 mW input power	5.30 mW / g
SAR normalized	normalized to 1W	21.2 mW / g
SAR for nominal Head TSL parameters ¹	normalized to 1W	21.0 mW / g \pm 16.5 % (k=2)

¹ Correction to nominal TSL parameters according to d), chapter "SAR Sensitivities"

Body TSL parameters

The following parameters and calculations were applied.

	Temperature	Permittivity	Conductivity
Nominal Body TSL parameters	22.0 °C	53.3	1.52 mho/m
Measured Body TSL parameters	(22.0 ± 0.2) °C	53.9 ± 6 %	1.57 mho/m ± 6 %
Body TSL temperature during test	(22.0 ± 0.2) °C	----	----

SAR result with Body TSL

SAR averaged over 1 cm ³ (1 g) of Body TSL	Condition	
SAR measured	250 mW input power	10.3 mW / g
SAR normalized	normalized to 1W	41.2 mW / g
SAR for nominal Body TSL parameters ²	normalized to 1W	40.5 mW / g ± 17.0 % (k=2)

SAR averaged over 10 cm ³ (10 g) of Body TSL	condition	
SAR measured	250 mW input power	5.41 mW / g
SAR normalized	normalized to 1W	21.6 mW / g
SAR for nominal Body TSL parameters ²	normalized to 1W	21.5 mW / g ± 16.5 % (k=2)

² Correction to nominal TSL parameters according to d), chapter "SAR Sensitivities"

Appendix

Antenna Parameters with Head TSL

Impedance, transformed to feed point	50.0 Ω + 6.1 j Ω
Return Loss	- 24.3 dB

Antenna Parameters with Body TSL

Impedance, transformed to feed point	47.1 Ω + 5.7 j Ω
Return Loss	- 23.6 dB

General Antenna Parameters and Design

Electrical Delay (one direction)	1.193 ns

After long term use with 100W radiated power, only a slight warming of the dipole near the feedpoint can be measured.

The dipole is made of standard semirigid coaxial cable. The center conductor of the feeding line is directly connected to the second arm of the dipole. The antenna is therefore short-circuited for DC-signals.

No excessive force must be applied to the dipole arms, because they might bend or the soldered connections near the feedpoint may be damaged.

Additional EUT Data

Manufactured by	SPEAG
Manufactured on	June 28, 2006

DASY5 Validation Report for Head TSL

Date/Time: 05.08.2009 14:25:51

Test Laboratory: SPEAG, Zurich, Switzerland

DUT: Dipole 1900 MHz; Type: D1900V2; Serial: D1900V2 - SN:5d080

Communication System: CW; Frequency: 1900 MHz; Duty Cycle: 1:1

Medium: HSL U11 BB

Medium parameters used: $f = 1900$ MHz; $\sigma = 1.45$ mho/m; $\epsilon_r = 40.8$; $\rho = 1000$ kg/m³

Phantom section: Flat Section

Measurement Standard: DASY5 (IEEE/IEC)

DASY5 Configuration:

- Probe: ES3DV3 - SN3205; ConvF(5.09, 5.09, 5.09); Calibrated: 26.06.2009
- Sensor-Surface: 3mm (Mechanical Surface Detection)
- Electronics: DAE4 Sn601; Calibrated: 07.03.2009
- Phantom: Flat Phantom 5.0 (front); Type: QD000P50AA; Serial: 1001
- Measurement SW: DASY5, V5.0 Build 120; SEMCAD X Version 13.4 Build 45

Pin = 250 mW; dip = 10 mm, scan at 3.0 mm/Zoom Scan (dist=3.0 mm, probe 0deg)

(7x7x7)/Cube 0: Measurement grid: dx=5mm, dy=5mm, dz=5mm

Reference Value = 94.9 V/m; Power Drift = 0.040 dB

Peak SAR (extrapolated) = 18.7 W/kg

SAR(1 g) = 10.2 mW/g; SAR(10 g) = 5.3 mW/g

Maximum value of SAR (measured) = 12.6 mW/g

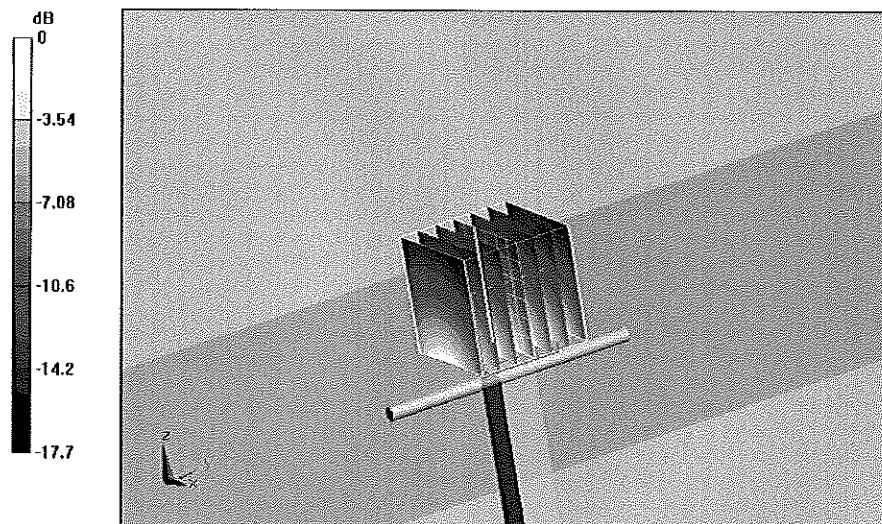

0 dB = 12.6mW/g

Impedance Measurement Plot for Head TSL

5 Aug 2009 11:36:10

[CH1] S11 1 U FS 2: 50.018 Ω 6.0918 Ω 510.28 μ H 1 900.000 000 MHz

*
Del
Cor

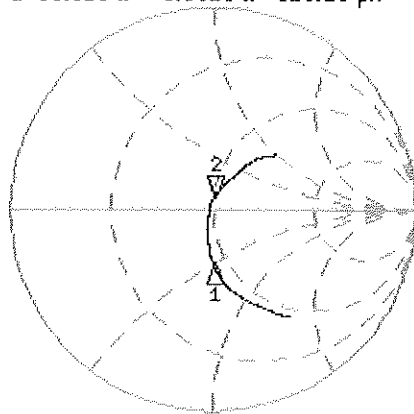

CH1 Markers
1: 43.418 Ω
-25.646 Ω
1.75000 GHz

Avg
16

↑

CH2 S11 LOG 5 dB/REF -20 dB 2: -24.341 dB 1 900.000 000 MHz

Cor

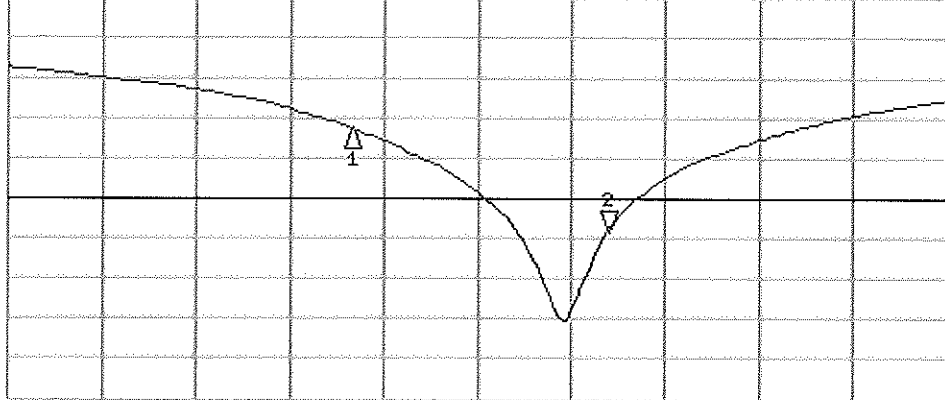

CH2 Markers
1: -11.257 dB
1.75000 GHz

↑

START 1 550.000 000 MHz

STOP 2 100.000 000 MHz

DASY5 Validation Report for Body TSL

Date/Time: 18.08.2009 14:14:25

Test Laboratory: SPEAG, Zurich, Switzerland

DUT: Dipole 1900 MHz; Type: D1900V2; Serial: D1900V2 - SN:5d080

Communication System: CW; Frequency: 1900 MHz; Duty Cycle: 1:1

Medium: MSL U10 BB

Medium parameters used: $f = 1900$ MHz; $\sigma = 1.57$ mho/m; $\epsilon_r = 53.9$; $\rho = 1000$ kg/m³

Phantom section: Flat Section

Measurement Standard: DASY5 (IEEE/IEC)

DASY5 Configuration:

- Probe: ES3DV3 - SN3205; ConvF(4.59, 4.59, 4.59); Calibrated: 26.06.2009
- Sensor-Surface: 3mm (Mechanical Surface Detection)
- Electronics: DAE4 Sn601; Calibrated: 07.03.2009
- Phantom: Flat Phantom 5.0 (back); Type: QD000P50AA; Serial: 1002
- Measurement SW: DASY5, V5.0 Build 120; SEMCAD X Version 13.4 Build 45

Pin = 250 mW; dip = 10 mm, scan at 3.0mm/Zoom Scan (dist=3.0mm, probe 0deg)

(7x7x7)/Cube 0: Measurement grid: dx=5mm, dy=5mm, dz=5mm

Reference Value = 96.7 V/m; Power Drift = -0.00545 dB

Peak SAR (extrapolated) = 17.7 W/kg

SAR(1 g) = 10.3 mW/g; SAR(10 g) = 5.41 mW/g

Maximum value of SAR (measured) = 13.1 mW/g

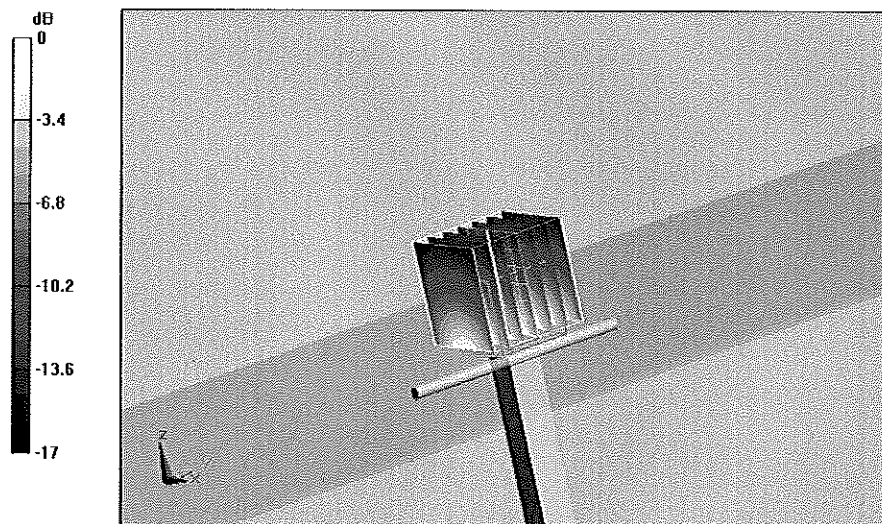

0 dB = 13.1mW/g

Impedance Measurement Plot for Body TSL

18 Aug 2009 10:46:59

CH1 S11 1 U FS 2: 47.070 Ω 5.7227 Ω 479.36 μ H 1 900.000 000 MHz

*
De1
Cor

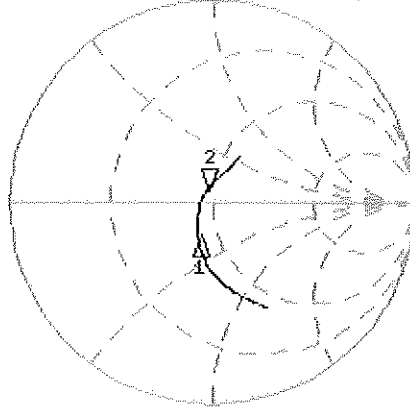

CH1 Markers
1: 41.258 Ω
-14.293 Ω
1.80000 GHz

Avg
16

↑

CH2 S11 LOG 5 dB/REF -20 dB 2: -23.598 dB 1 900.000 000 MHz

Cor

Avg
16

↑

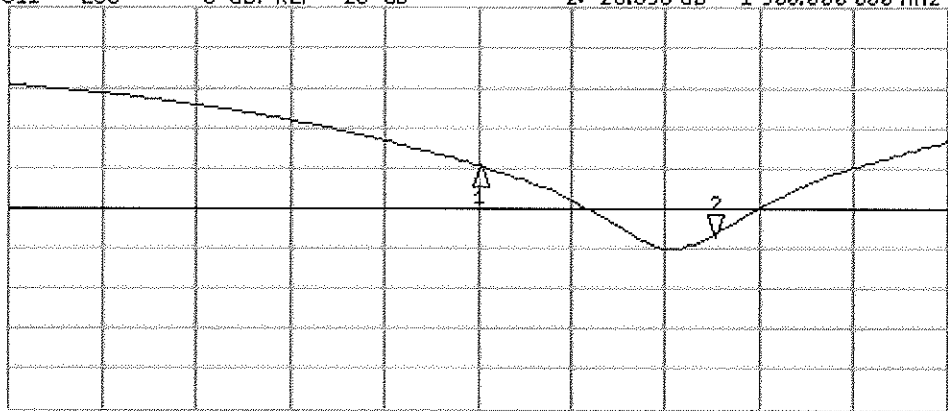

CH2 Markers
1: -14.828 dB
1.80000 GHz

START 1 600.000 000 MHz

STOP 2 000.000 000 MHz



Accredited by the Swiss Accreditation Service (SAS)
The Swiss Accreditation Service is one of the signatories to the EA
Multilateral Agreement for the recognition of calibration certificates

Accreditation No.: **SCS 108**

Client **PC Test**

Certificate No: **D1900V2-5d080-Aug09**

CALIBRATION CERTIFICATE

Object **D1900V2 - SN: 5d080**

Calibration procedure(s) **QA CAL-05.v7
Calibration procedure for dipole validation kits**

Calibration date: **August 18, 2009**

Condition of the calibrated item **In Tolerance**

This calibration certificate documents the traceability to national standards, which realize the physical units of measurements (SI).
The measurements and the uncertainties with confidence probability are given on the following pages and are part of the certificate.

All calibrations have been conducted in the closed laboratory facility: environment temperature (22 ± 3)°C and humidity < 70%.

Calibration Equipment used (M&TE critical for calibration)

Primary Standards	ID #	Cal Date (Calibrated by, Certificate No.)	Scheduled Calibration
Power meter EPM-442A	GB37480704	08-Oct-08 (No. 217-00898)	Oct-09
Power sensor HP 8481A	US37292783	08-Oct-08 (No. 217-00898)	Oct-09
Reference 20 dB Attenuator	SN: 5086 (20g)	31-Mar-09 (No. 217-01025)	Mar-10
Type-N mismatch combination	SN: 5047.2 / 06327	31-Mar-09 (No. 217-01029)	Mar-10
Reference Probe ES3DV3	SN: 3205	26-Jun-09 (No. ES3-3205_Jun09)	Jun-10
DAE4	SN: 601	07-Mar-09 (No. DAE4-601_Mar09)	Mar-10
Secondary Standards	ID #	Check Date (in house)	Scheduled Check
Power sensor HP 8481A	MY41092317	18-Oct-02 (in house check Oct-07)	In house check: Oct-09
RF generator R&S SMT-06	100005	4-Aug-99 (in house check Oct-07)	In house check: Oct-09
Network Analyzer HP 8753E	US37390585 S4206	18-Oct-01 (in house check Oct-08)	In house check: Oct-09

Calibrated by: **Claudio Leubler** (Laboratory Technician) *[Signature]*

Approved by: **Katja Pokovic** (Technical Manager) *[Signature]*

Issued: August 19, 2009
This calibration certificate shall not be reproduced except in full without written approval of the laboratory.

OK ✓
8/31/09



Accredited by the Swiss Accreditation Service (SAS)
The Swiss Accreditation Service is one of the signatories to the EA
Multilateral Agreement for the recognition of calibration certificates

Accreditation No.: **SCS 108**

Glossary:

TSL	tissue simulating liquid
ConvF	sensitivity in TSL / NORM x,y,z
N/A	not applicable or not measured

Calibration is Performed According to the Following Standards:

- IEEE Std 1528-2003, "IEEE Recommended Practice for Determining the Peak Spatial-Averaged Specific Absorption Rate (SAR) in the Human Head from Wireless Communications Devices: Measurement Techniques", December 2003
- CENELEC EN 50361, "Basic standard for the measurement of Specific Absorption Rate related to human exposure to electromagnetic fields from mobile phones (300 MHz - 3 GHz), July 2001
- Federal Communications Commission Office of Engineering & Technology (FCC OET), "Evaluating Compliance with FCC Guidelines for Human Exposure to Radiofrequency Electromagnetic Fields; Additional Information for Evaluating Compliance of Mobile and Portable Devices with FCC Limits for Human Exposure to Radiofrequency Emissions", Supplement C (Edition 01-01) to Bulletin 65

Additional Documentation:

- DASY4/5 System Handbook

Methods Applied and Interpretation of Parameters:

- Measurement Conditions:* Further details are available from the Validation Report at the end of the certificate. All figures stated in the certificate are valid at the frequency indicated.
- Antenna Parameters with TSL:* The dipole is mounted with the spacer to position its feed point exactly below the center marking of the flat phantom section, with the arms oriented parallel to the body axis.
- Feed Point Impedance and Return Loss:* These parameters are measured with the dipole positioned under the liquid filled phantom. The impedance stated is transformed from the measurement at the SMA connector to the feed point. The Return Loss ensures low reflected power. No uncertainty required.
- Electrical Delay:* One-way delay between the SMA connector and the antenna feed point. No uncertainty required.
- SAR measured:* SAR measured at the stated antenna input power.
- SAR normalized:* SAR as measured, normalized to an input power of 1 W at the antenna connector.
- SAR for nominal TSL parameters:* The measured TSL parameters are used to calculate the nominal SAR result.

Measurement Conditions

DASY system configuration, as far as not given on page 1.

DASY Version	DASY5	V5.0
Extrapolation	Advanced Extrapolation	
Phantom	Modular Flat Phantom V5.0	
Distance Dipole Center - TSL	10 mm	with Spacer
Zoom Scan Resolution	dx, dy, dz = 5 mm	
Frequency	1900 MHz \pm 1 MHz	

Head TSL parameters

The following parameters and calculations were applied.

	Temperature	Permittivity	Conductivity
Nominal Head TSL parameters	22.0 °C	40.0	1.40 mho/m
Measured Head TSL parameters	(22.0 \pm 0.2) °C	40.8 \pm 6 %	1.45 mho/m \pm 6 %
Head TSL temperature during test	(22.0 \pm 0.2) °C	----	----

SAR result with Head TSL

SAR averaged over 1 cm³ (1 g) of Head TSL	condition	
SAR measured	250 mW input power	10.2 mW / g
SAR normalized	normalized to 1W	40.8 mW / g
SAR for nominal Head TSL parameters ¹	normalized to 1W	40.1 mW / g \pm 17.0 % (k=2)

SAR averaged over 10 cm³ (10 g) of Head TSL	Condition	
SAR measured	250 mW input power	5.30 mW / g
SAR normalized	normalized to 1W	21.2 mW / g
SAR for nominal Head TSL parameters ¹	normalized to 1W	21.0 mW / g \pm 16.5 % (k=2)

¹ Correction to nominal TSL parameters according to d), chapter "SAR Sensitivities"

Body TSL parameters

The following parameters and calculations were applied.

	Temperature	Permittivity	Conductivity
Nominal Body TSL parameters	22.0 °C	53.3	1.52 mho/m
Measured Body TSL parameters	(22.0 ± 0.2) °C	53.9 ± 6 %	1.57 mho/m ± 6 %
Body TSL temperature during test	(22.0 ± 0.2) °C	----	----

SAR result with Body TSL

SAR averaged over 1 cm ³ (1 g) of Body TSL	Condition	
SAR measured	250 mW input power	10.3 mW / g
SAR normalized	normalized to 1W	41.2 mW / g
SAR for nominal Body TSL parameters ²	normalized to 1W	40.5 mW / g ± 17.0 % (k=2)

SAR averaged over 10 cm ³ (10 g) of Body TSL	condition	
SAR measured	250 mW input power	5.41 mW / g
SAR normalized	normalized to 1W	21.6 mW / g
SAR for nominal Body TSL parameters ²	normalized to 1W	21.5 mW / g ± 16.5 % (k=2)

² Correction to nominal TSL parameters according to d), chapter "SAR Sensitivities"

Appendix

Antenna Parameters with Head TSL

Impedance, transformed to feed point	50.0 Ω + 6.1 j Ω
Return Loss	- 24.3 dB

Antenna Parameters with Body TSL

Impedance, transformed to feed point	47.1 Ω + 5.7 j Ω
Return Loss	- 23.6 dB

General Antenna Parameters and Design

Electrical Delay (one direction)	1.193 ns

After long term use with 100W radiated power, only a slight warming of the dipole near the feedpoint can be measured.

The dipole is made of standard semirigid coaxial cable. The center conductor of the feeding line is directly connected to the second arm of the dipole. The antenna is therefore short-circuited for DC-signals.

No excessive force must be applied to the dipole arms, because they might bend or the soldered connections near the feedpoint may be damaged.

Additional EUT Data

Manufactured by	SPEAG
Manufactured on	June 28, 2006

DASY5 Validation Report for Head TSL

Date/Time: 05.08.2009 14:25:51

Test Laboratory: SPEAG, Zurich, Switzerland

DUT: Dipole 1900 MHz; Type: D1900V2; Serial: D1900V2 - SN:5d080

Communication System: CW; Frequency: 1900 MHz; Duty Cycle: 1:1

Medium: HSL U11 BB

Medium parameters used: $f = 1900$ MHz; $\sigma = 1.45$ mho/m; $\epsilon_r = 40.8$; $\rho = 1000$ kg/m³

Phantom section: Flat Section

Measurement Standard: DASY5 (IEEE/IEC)

DASY5 Configuration:

- Probe: ES3DV3 - SN3205; ConvF(5.09, 5.09, 5.09); Calibrated: 26.06.2009
- Sensor-Surface: 3mm (Mechanical Surface Detection)
- Electronics: DAE4 Sn601; Calibrated: 07.03.2009
- Phantom: Flat Phantom 5.0 (front); Type: QD000P50AA; Serial: 1001
- Measurement SW: DASY5, V5.0 Build 120; SEMCAD X Version 13.4 Build 45

Pin = 250 mW; dip = 10 mm, scan at 3.0 mm/Zoom Scan (dist=3.0 mm, probe 0deg)

(7x7x7)/Cube 0: Measurement grid: dx=5mm, dy=5mm, dz=5mm

Reference Value = 94.9 V/m; Power Drift = 0.040 dB

Peak SAR (extrapolated) = 18.7 W/kg

SAR(1 g) = 10.2 mW/g; SAR(10 g) = 5.3 mW/g

Maximum value of SAR (measured) = 12.6 mW/g

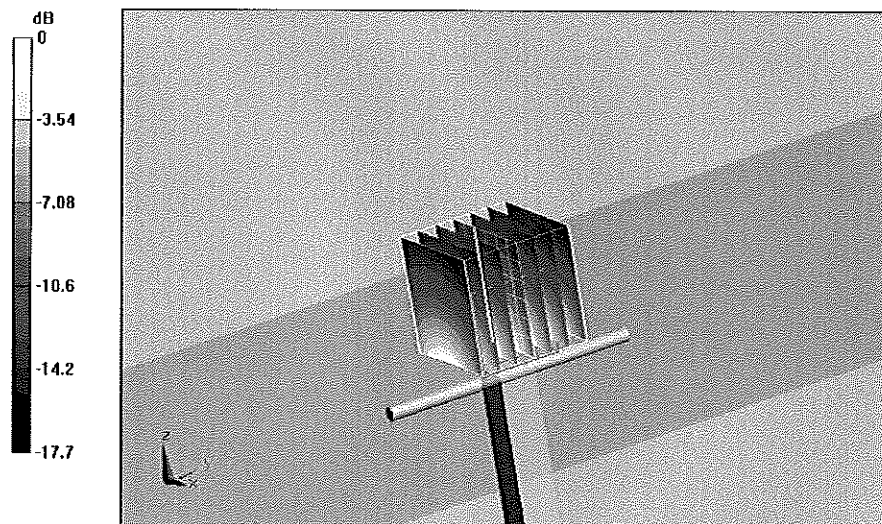

0 dB = 12.6mW/g

Impedance Measurement Plot for Head TSL

5 Aug 2009 11:36:10

[CH1] S11 1 U FS 2: 50.018 Ω 6.0918 Ω 510.28 μ H 1 900.000 000 MHz

*
Del
Cor

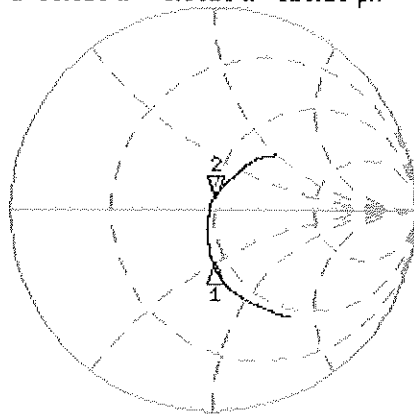

CH1 Markers
1: 43.418 Ω
-25.646 Ω
1.75000 GHz

Avg
16

↑

CH2 S11 LOG 5 dB/REF -20 dB 2: -24.341 dB 1 900.000 000 MHz

Cor

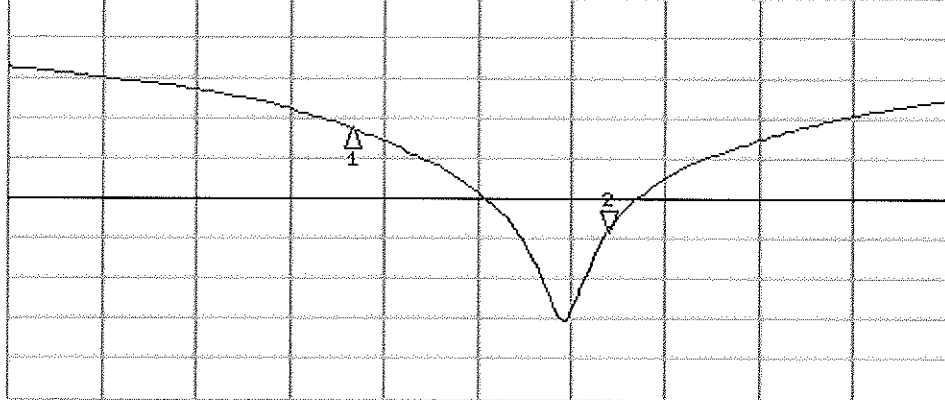

CH2 Markers
1: -11.257 dB
1.75000 GHz

↑

START 1 550.000 000 MHz

STOP 2 100.000 000 MHz

DASY5 Validation Report for Body TSL

Date/Time: 18.08.2009 14:14:25

Test Laboratory: SPEAG, Zurich, Switzerland

DUT: Dipole 1900 MHz; Type: D1900V2; Serial: D1900V2 - SN:5d080

Communication System: CW; Frequency: 1900 MHz; Duty Cycle: 1:1

Medium: MSL U10 BB

Medium parameters used: $f = 1900$ MHz; $\sigma = 1.57$ mho/m; $\epsilon_r = 53.9$; $\rho = 1000$ kg/m³

Phantom section: Flat Section

Measurement Standard: DASY5 (IEEE/IEC)

DASY5 Configuration:

- Probe: ES3DV3 - SN3205; ConvF(4.59, 4.59, 4.59); Calibrated: 26.06.2009
- Sensor-Surface: 3mm (Mechanical Surface Detection)
- Electronics: DAE4 Sn601; Calibrated: 07.03.2009
- Phantom: Flat Phantom 5.0 (back); Type: QD000P50AA; Serial: 1002
- Measurement SW: DASY5, V5.0 Build 120; SEMCAD X Version 13.4 Build 45

Pin = 250 mW; dip = 10 mm, scan at 3.0mm/Zoom Scan (dist=3.0mm, probe 0deg)

(7x7x7)/Cube 0: Measurement grid: dx=5mm, dy=5mm, dz=5mm

Reference Value = 96.7 V/m; Power Drift = -0.00545 dB

Peak SAR (extrapolated) = 17.7 W/kg

SAR(1 g) = 10.3 mW/g; SAR(10 g) = 5.41 mW/g

Maximum value of SAR (measured) = 13.1 mW/g

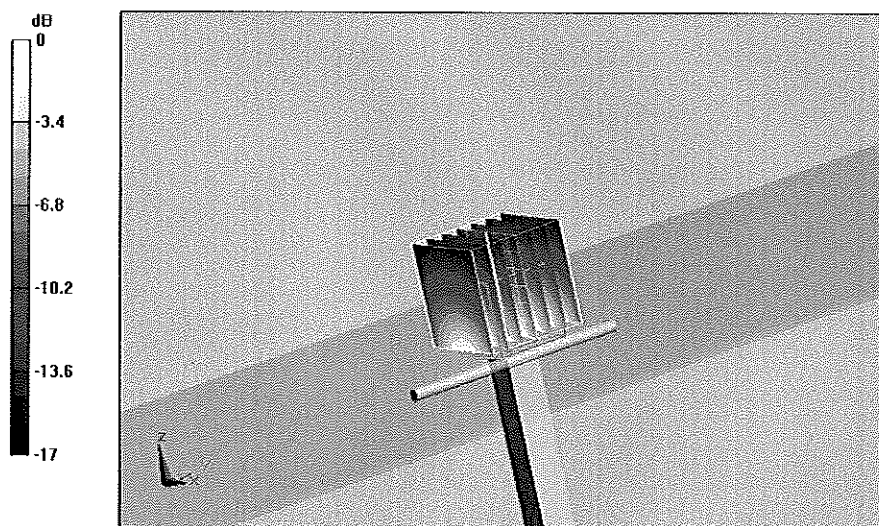

0 dB = 13.1mW/g

Impedance Measurement Plot for Body TSL

18 Aug 2009 10:46:59

CH1 S11 1 U FS 2: 47.070 Ω 5.7227 Ω 479.36 μ H 1 900.000 000 MHz

*
De1
Cor

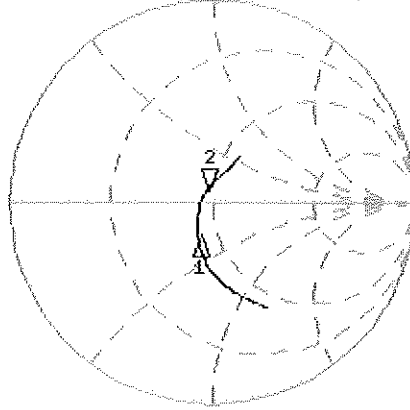

CH1 Markers
1: 41.258 Ω
-14.293 Ω
1.80000 GHz

Avg
16

↑

CH2 S11 LOG 5 dB/REF -20 dB 2: -23.598 dB 1 900.000 000 MHz

Cor

Avg
16

↑

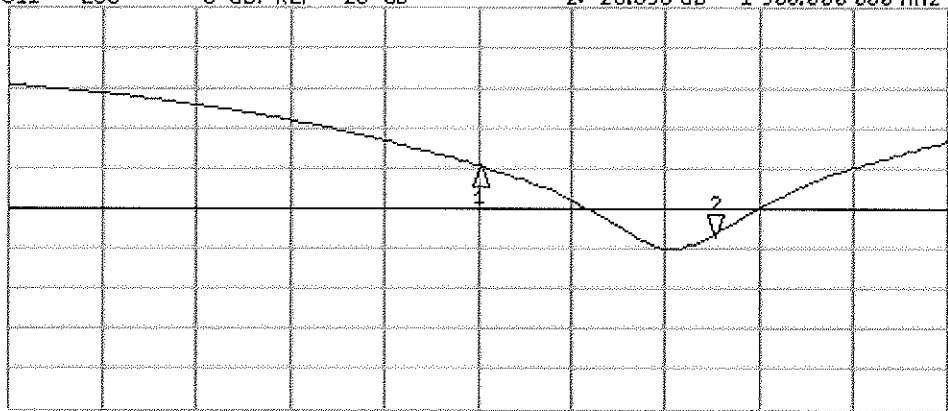

CH2 Markers
1: -14.828 dB
1.80000 GHz

START 1 600.000 000 MHz

STOP 2 000.000 000 MHz



Accredited by the Swiss Accreditation Service (SAS)
The Swiss Accreditation Service is one of the signatories to the EA
Multilateral Agreement for the recognition of calibration certificates

Accreditation No.: **SCS 108**

Client **PC Test**

Certificate No: **D2450V2-719_Aug09**

CALIBRATION CERTIFICATE

Object **D2450V2 - SN: 719**

Calibration procedure(s) **QA CAL-05.v7
Calibration procedure for dipole validation kits**

Calibration date: **August 27, 2009**

Condition of the calibrated item **In Tolerance**

This calibration certificate documents the traceability to national standards, which realize the physical units of measurements (SI).
The measurements and the uncertainties with confidence probability are given on the following pages and are part of the certificate.

*✓ OK
S
8/31/09*

All calibrations have been conducted in the closed laboratory facility: environment temperature (22 ± 3)°C and humidity < 70%.

Calibration Equipment used (M&TE critical for calibration)

Primary Standards	ID #	Cal Date (Calibrated by, Certificate No.)	Scheduled Calibration
Power meter EPM-442A	GB37480704	08-Oct-08 (No. 217-00898)	Oct-09
Power sensor HP 8481A	US37292783	08-Oct-08 (No. 217-00898)	Oct-09
Reference 20 dB Attenuator	SN: 5086 (20g)	31-Mar-09 (No. 217-01025)	Mar-10
Type-N mismatch combination	SN: 5047.2 / 06327	31-Mar-09 (No. 217-01029)	Mar-10
Reference Probe ES3DV3	SN: 3205	26-Jun-09 (No. ES3-3205_Jun09)	Jun-10
DAE4	SN: 601	07-Mar-09 (No. DAE4-601_Mar09)	Mar-10
Secondary Standards	ID #	Check Date (in house)	Scheduled Check
Power sensor HP 8481A	MY41092317	18-Oct-02 (in house check Oct-07)	In house check: Oct-09
RF generator R&S SMT-06	100005	4-Aug-99 (in house check Oct-07)	In house check: Oct-09
Network Analyzer HP 8753E	US37390585 S4206	18-Oct-01 (in house check Oct-08)	In house check: Oct-09

	Name	Function	Signature
Calibrated by:	Jeton Kastrali	Laboratory Technician	<i>[Signature]</i>
Approved by:	Katja Pokovic	Technical Manager	<i>[Signature]</i>

Issued: August 27, 2009

This calibration certificate shall not be reproduced except in full without written approval of the laboratory.



Accredited by the Swiss Accreditation Service (SAS)
The Swiss Accreditation Service is one of the signatories to the EA
Multilateral Agreement for the recognition of calibration certificates

Accreditation No.: **SCS 108**

Glossary:

TSL	tissue simulating liquid
ConvF	sensitivity in TSL / NORM x,y,z
N/A	not applicable or not measured

Calibration is Performed According to the Following Standards:

- IEEE Std 1528-2003, "IEEE Recommended Practice for Determining the Peak Spatial-Averaged Specific Absorption Rate (SAR) in the Human Head from Wireless Communications Devices: Measurement Techniques", December 2003
- IEC 62209-1, "Procedure to measure the Specific Absorption Rate (SAR) for hand-held devices used in close proximity to the ear (frequency range of 300 MHz to 3 GHz)", February 2005
- Federal Communications Commission Office of Engineering & Technology (FCC OET), "Evaluating Compliance with FCC Guidelines for Human Exposure to Radiofrequency Electromagnetic Fields; Additional Information for Evaluating Compliance of Mobile and Portable Devices with FCC Limits for Human Exposure to Radiofrequency Emissions", Supplement C (Edition 01-01) to Bulletin 65

Additional Documentation:

- DASY4/5 System Handbook

Methods Applied and Interpretation of Parameters:

- Measurement Conditions:** Further details are available from the Validation Report at the end of the certificate. All figures stated in the certificate are valid at the frequency indicated.
- Antenna Parameters with TSL:** The dipole is mounted with the spacer to position its feed point exactly below the center marking of the flat phantom section, with the arms oriented parallel to the body axis.
- Feed Point Impedance and Return Loss:** These parameters are measured with the dipole positioned under the liquid filled phantom. The impedance stated is transformed from the measurement at the SMA connector to the feed point. The Return Loss ensures low reflected power. No uncertainty required.
- Electrical Delay:** One-way delay between the SMA connector and the antenna feed point. No uncertainty required.
- SAR measured:** SAR measured at the stated antenna input power.
- SAR normalized:** SAR as measured, normalized to an input power of 1 W at the antenna connector.
- SAR for nominal TSL parameters:** The measured TSL parameters are used to calculate the nominal SAR result.

Measurement Conditions

DASY system configuration, as far as not given on page 1.

DASY Version	DASY5	V5.0
Extrapolation	Advanced Extrapolation	
Phantom	Modular Flat Phantom V5.0	
Distance Dipole Center - TSL	10 mm	with Spacer
Zoom Scan Resolution	dx, dy, dz = 5 mm	
Frequency	2450 MHz ± 1 MHz	

Head TSL parameters

The following parameters and calculations were applied.

	Temperature	Permittivity	Conductivity
Nominal Head TSL parameters	22.0 °C	39.2	1.80 mho/m
Measured Head TSL parameters	(22.0 ± 0.2) °C	40.1 ± 6 %	1.80 mho/m ± 6 %
Head TSL temperature during test	(22.3 ± 0.2) °C	----	----

SAR result with Head TSL

SAR averaged over 1 cm³ (1 g) of Head TSL	Condition	
SAR measured	250 mW input power	13.3 mW / g
SAR normalized	normalized to 1W	53.2 mW / g
SAR for nominal Head TSL parameters ¹	normalized to 1W	53.5 mW / g ± 17.0 % (k=2)

SAR averaged over 10 cm³ (10 g) of Head TSL	condition	
SAR measured	250 mW input power	6.23 mW / g
SAR normalized	normalized to 1W	24.9 mW / g
SAR for nominal Head TSL parameters ¹	normalized to 1W	25.0 mW / g ± 16.5 % (k=2)

¹ Correction to nominal TSL parameters according to d), chapter "SAR Sensitivities"

Body TSL parameters

The following parameters and calculations were applied.

	Temperature	Permittivity	Conductivity
Nominal Body TSL parameters	22.0 °C	52.7	1.95 mho/m
Measured Body TSL parameters	(22.0 ± 0.2) °C	53.2 ± 6 %	2.01 mho/m ± 6 %
Body TSL temperature during test	(22.5 ± 0.2) °C	----	----

SAR result with Body TSL

SAR averaged over 1 cm ³ (1 g) of Body TSL	Condition	
SAR measured	250 mW input power	13.0 mW / g
SAR normalized	normalized to 1W	52.0 mW / g
SAR for nominal Body TSL parameters ²	normalized to 1W	51.4 mW /g ± 17.0 % (k=2)

SAR averaged over 10 cm ³ (10 g) of Body TSL	condition	
SAR measured	250 mW input power	6.00 mW / g
SAR normalized	normalized to 1W	24.0 mW / g
SAR for nominal Body TSL parameters ²	normalized to 1W	23.9 mW /g ± 16.5 % (k=2)

² Correction to nominal TSL parameters according to d), chapter "SAR Sensitivities"

Appendix

Antenna Parameters with Head TSL

Impedance, transformed to feed point	53.4 Ω + 1.8 j Ω
Return Loss	- 28.6 dB

Antenna Parameters with Body TSL

Impedance, transformed to feed point	48.2 Ω + 3.9 j Ω
Return Loss	- 27.2 dB

General Antenna Parameters and Design

Electrical Delay (one direction)	1.150 ns
----------------------------------	----------

After long term use with 100W radiated power, only a slight warming of the dipole near the feedpoint can be measured.

The dipole is made of standard semirigid coaxial cable. The center conductor of the feeding line is directly connected to the second arm of the dipole. The antenna is therefore short-circuited for DC-signals.

No excessive force must be applied to the dipole arms, because they might bend or the soldered connections near the feedpoint may be damaged.

Additional EUT Data

Manufactured by	SPEAG
Manufactured on	September 10, 2002

DASY5 Validation Report for Head TSL

Date/Time: 27.08.2009 11:14:47

Test Laboratory: SPEAG, Zurich, Switzerland

DUT: Dipole 2450 MHz; Type: D2450V2; Serial: D2450V2 - SN719

Communication System: CW; Frequency: 2450 MHz; Duty Cycle: 1:1

Medium: HSL U11 BB

Medium parameters used: $f = 2450$ MHz; $\sigma = 1.8$ mho/m; $\epsilon_r = 40.1$; $\rho = 1000$ kg/m³

Phantom section: Flat Section

Measurement Standard: DASY5 (IEEE/IEC)

DASY5 Configuration:

- Probe: ES3DV3 - SN3205; ConvF(4.53, 4.53, 4.53); Calibrated: 26.06.2009
- Sensor-Surface: 3mm (Mechanical Surface Detection)
- Electronics: DAE4 Sn601; Calibrated: 07.03.2009
- Phantom: Flat Phantom 5.0 (front); Type: QD000P50AA; Serial: 1001
- Measurement SW: DASY5, V5.0 Build 120; SEMCAD X Version 13.4 Build 45

Pin = 250 mW; d = 10 mm/Zoom Scan (7x7x7)/Cube 0: Measurement grid: dx=5mm, dy=5mm, dz=5mm

Reference Value = 101.4 V/m; Power Drift = 0.025 dB

Peak SAR (extrapolated) = 27 W/kg

SAR(1 g) = 13.3 mW/g; SAR(10 g) = 6.23 mW/g

Maximum value of SAR (measured) = 17.2 mW/g

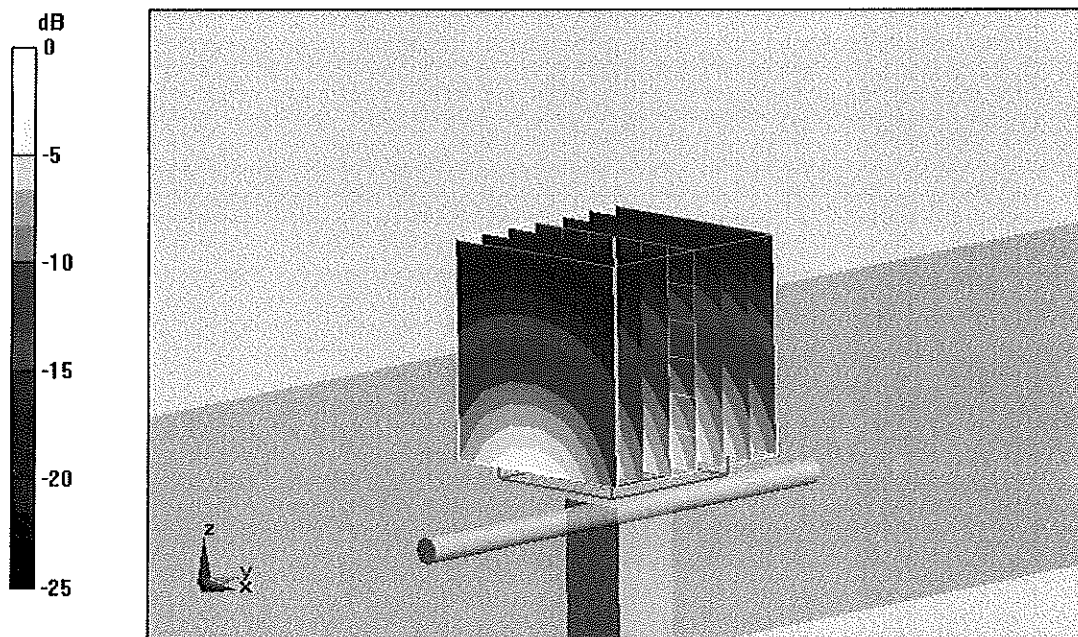

0 dB = 17.2mW/g

Impedance Measurement Plot for Head TSL

27 Aug 2009 09:14:09

[CH1] S11 1 U FS 1: 53.385 Ω 1.7910 Ω 116.35 pF 2 450.000 000 MHz

*
Del
Cor

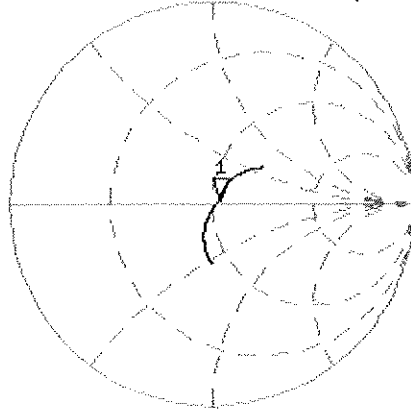

↑

CH2 S11 LOG 5 dB/REF -20 dB 1: -28.624 dB 2 450.000 000 MHz

Cor

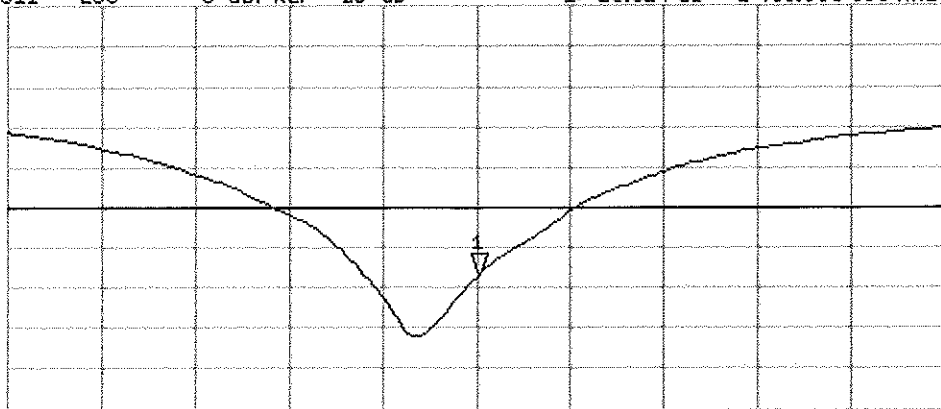

↑

START 2 250.000 000 MHz

STOP 2 650.000 000 MHz

DASY5 Validation Report for Body TSL

Date/Time: 17.08.2009 15:35:28

Test Laboratory: SPEAG, Zurich, Switzerland

DUT: Dipole 2450 MHz; Type: D2450V2; Serial: D2450V2 - SN:719

Communication System: CW; Frequency: 2450 MHz; Duty Cycle: 1:1

Medium: MSL U10 BB

Medium parameters used: $f = 2450$ MHz; $\sigma = 2.01$ mho/m; $\epsilon_r = 53.1$; $\rho = 1000$ kg/m³

Phantom section: Flat Section

Measurement Standard: DASY5 (IEEE/IEC)

DASY5 Configuration:

- Probe: ES3DV3 - SN3205; ConvF(4.31, 4.31, 4.31); Calibrated: 26.06.2009
- Sensor-Surface: 3mm (Mechanical Surface Detection)
- Electronics: DAE4 Sn601; Calibrated: 07.03.2009
- Phantom: Flat Phantom 5.0 (back); Type: QD000P50AA; Serial: 1002
- Measurement SW: DASY5, V5.0 Build 120; SEMCAD X Version 13.4 Build 45

Pin = 250 mW; d = 10 mm/Zoom Scan (7x7x7)/Cube 0: Measurement grid: dx=5mm, dy=5mm, dz=5mm

Reference Value = 94.8 V/m; Power Drift = -0.00649 dB

Peak SAR (extrapolated) = 27.2 W/kg

SAR(1 g) = 13 mW/g; SAR(10 g) = 6 mW/g

Maximum value of SAR (measured) = 17 mW/g

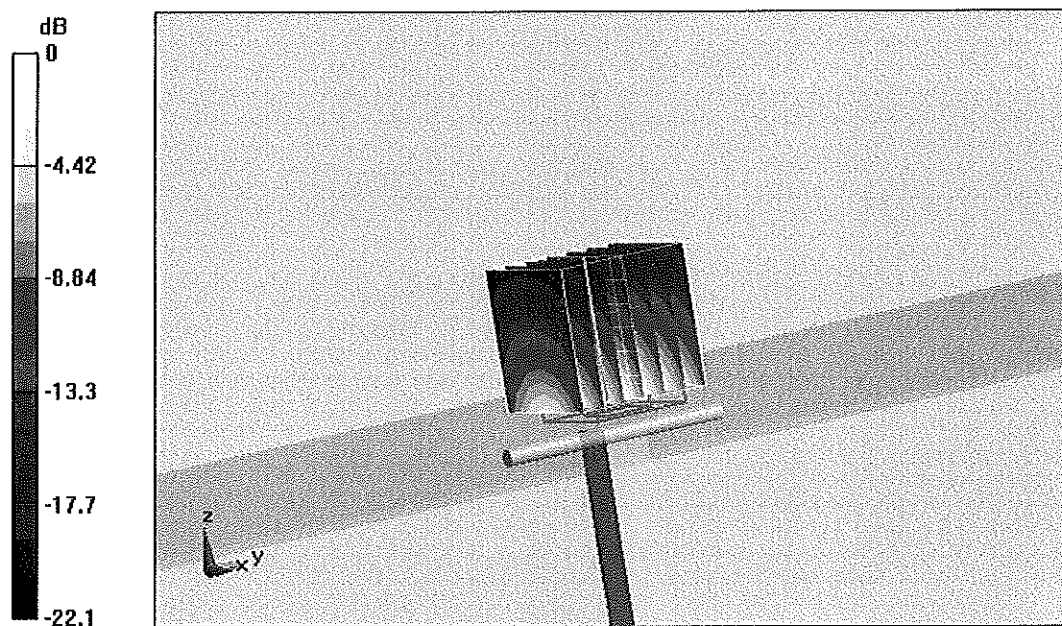

0 dB = 17mW/g

Impedance Measurement Plot for Body TSL

17 Aug 2009 15:56:32

CH1 S11 1 U FS 1: 48.221 Ω 3.9004 Ω 253.37 pF 2 450.000 000 MHz

*
De1
Cor
Avg
16
↑

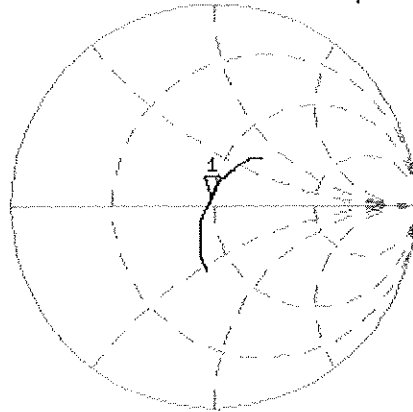

CH2 S11 LOG 5 dB/REF -20 dB 1: -27.205 dB 2 450.000 000 MHz

