



## SAR EVALUATION REPORT

**Applicant Name:**

Samsung Electronics, Co. Ltd.  
129, Samsung-ro, Maetan dong,  
Yeongtong-gu, Suwon-si  
Gyeonggi-do 443-742, Korea

**Date of Testing:**

08/19/13-08/21/2013

**Test Site/Location:**

PCTEST Lab, Columbia, MD, USA

**Document Serial No.:**

0Y1308141619-R1.A3L

**FCC ID:**

**A3LGTS6792L**

**APPLICANT:**

**SAMSUNG ELECTRONICS, CO. LTD.**

**DUT Type:**

Portable Handset

**Application Type:**

Certification

**FCC Rule Part(s):**

CFR §2.1093

**Model(s):**

GT-S6792L

Equipment Class	Band & Mode	Tx Frequency	Measured Conducted Power [dBm]	SAR		
				1 gm Head (W/kg)	1 gm Body-Worn (W/kg)	1 gm Hotspot (W/kg)
PCE	GSM/GPRS/EDGE Rx Only	824.20 - 848.80 MHz	32.49	0.44	0.65	0.71
PCE	UMTS 850	826.40 - 846.60 MHz	22.87	0.23	0.54	0.54
PCE	GSM/GPRS/EDGE Rx Only	1850.20 - 1909.80 MHz	29.47	0.49	0.49	0.59
PCE	UMTS 1900	1852.4 - 1907.6 MHz	22.98	0.78	0.52	0.52
DTS	2.4 GHz WLAN	2412 - 2462 MHz	16.24	0.13	< 0.1	0.10
DSS/DTS	Bluetooth	2402 - 2480 MHz	9.30	N/A		
<b>Simultaneous SAR per KDB 690783 D01v01r02:</b>				0.85	0.86	0.77

Note: Powers in the above table represent output powers for the SAR test configurations and may not represent the highest output powers for all configurations for each mode.

Note: This revised test report (S/N: 0Y1308141619-R1.A3L) supersedes and replaces the previously issued test report on the same subject DUT for the same type of testing indicated. Please discard or destroy the previously issued test report(s) and dispose of accordingly.



This wireless portable device has been shown to be capable of compliance for localized specific absorption rate (SAR) for uncontrolled environment/general population exposure limits specified in ANSI/IEEE C95.1-1992 and has been tested in accordance with the measurement procedures specified in Section 1.7 of this report; for North American frequency bands only.

I attest to the accuracy of data. All measurements reported herein were performed by me or were made under my supervision and are correct to the best of my knowledge and belief. I assume full responsibility for the completeness of these measurements and vouch for the qualifications of all persons taking them. Test results reported herein relate only to the item(s) tested.





Randy Ortanez  
President



FCC ID: A3LGTS6792L		<b>SAR EVALUATION REPORT</b>		<b>Reviewed by:</b> Quality Manager
<b>Document S/N:</b> 0Y1308141619-R1.A3L	<b>Test Dates:</b> 08/19/13 - 08/21/13	<b>DUT Type:</b> Portable Handset	Page 1 of 34	

# T A B L E O F C O N T E N T S

1	DEVICE UNDER TEST .....	3
2	INTRODUCTION .....	7
3	DOSIMETRIC ASSESSMENT .....	8
4	DEFINITION OF REFERENCE POINTS .....	9
5	TEST CONFIGURATION POSITIONS FOR HANDSETS .....	10
6	RF EXPOSURE LIMITS .....	14
7	FCC MEASUREMENT PROCEDURES.....	15
8	RF CONDUCTED POWERS.....	18
9	SYSTEM VERIFICATION.....	21
10	SAR DATA SUMMARY .....	23
11	FCC MULTI-TX AND ANTENNA SAR CONSIDERATIONS.....	27
12	SAR MEASUREMENT VARIABILITY .....	29
13	EQUIPMENT LIST.....	30
14	MEASUREMENT UNCERTAINTIES .....	31
15	CONCLUSION.....	32
16	REFERENCES .....	33
APPENDIX A: SAR TEST PLOTS		
APPENDIX B: SAR DIPOLE VERIFICATION PLOTS		
APPENDIX C: PROBE AND DIPOLE CALIBRATION CERTIFICATES		
APPENDIX D: SAR TISSUE SPECIFICATIONS		
APPENDIX E: SAR SYSTEM VALIDATION		
APPENDIX F: SAR TEST SETUP PHOTOGRAPHS		

FCC ID: A3LGTS6792L		SAR EVALUATION REPORT		Reviewed by: Quality Manager
Document S/N: OY1308141619-R1.A3L	Test Dates: 08/19/13 - 08/21/13	DUT Type: Portable Handset	Page 2 of 34	

# 1 DEVICE UNDER TEST

## 1.1 Device Overview

Band & Mode	Operating Modes	Tx Frequency
GSM/GPRS/EDGE Rx Only	Voice/Data	824.20 - 848.80 MHz
UMTS 850	Voice/Data	826.40 - 846.60 MHz
GSM/GPRS/EDGE Rx Only	Voice/Data	1850.20 - 1909.80 MHz
UMTS 1900	Voice/Data	1852.4 - 1907.6 MHz
2.4 GHz WLAN	Data	2412 - 2462 MHz
Bluetooth	Data	2402 - 2480 MHz



## 1.2 Nominal and Maximum Output Power Specifications

This device operates using the following maximum and nominal output power specifications. SAR values were scaled to the maximum allowed power to determine compliance per KDB Publication 447498 D01v05r01.

Mode / Band		Voice (dBm)	Burst Average GMSK (dBm)			
		1 TX Slot	1 TX Slots	2 TX Slots	3 TX Slots	4 TX Slots
GSM/GPRS 850	Maximum	<b>33.0</b>	<b>33.0</b>	<b>30.5</b>	<b>28.5</b>	<b>27.5</b>
	Nominal	<b>32.5</b>	<b>32.5</b>	<b>30.0</b>	<b>28.0</b>	<b>27.0</b>
GSM/GPRS 1900	Maximum	<b>29.5</b>	<b>29.5</b>	<b>27.5</b>	<b>25.5</b>	<b>24.5</b>
	Nominal	<b>29.0</b>	<b>29.0</b>	<b>27.0</b>	<b>25.0</b>	<b>24.0</b>

Mode / Band		Modulated Average (dBm)		
		3GPP RMC	3GPP HSDPA	3GPP HSUPA
UMTS Band 5 (850 MHz)	Maximum	<b>23.0</b>	<b>23.0</b>	<b>21.5</b>
	Nominal	<b>22.5</b>	<b>22.5</b>	<b>21.0</b>
UMTS Band 2 (1900 MHz)	Maximum	<b>23.0</b>	<b>23.0</b>	<b>21.5</b>
	Nominal	<b>22.5</b>	<b>22.5</b>	<b>21.0</b>

Mode / Band	Modulated Average (dBm)	
IEEE 802.11b (2.4 GHz)	Maximum	<b>16.5</b>
	Nominal	<b>16.0</b>
IEEE 802.11g (2.4 GHz)	Maximum	<b>13.5</b>
	Nominal	<b>13.0</b>
IEEE 802.11n (2.4 GHz)	Maximum	<b>11.5</b>
	Nominal	<b>11.0</b>
Bluetooth	Maximum	<b>10.0</b>
	Nominal	<b>9.5</b>
Bluetooth LE	Maximum	<b>6.5</b>
	Nominal	<b>6.0</b>

FCC ID: A3LGT56792L	 <b>PCTEST</b> ENGINEERING LABORATORY, INC.	<b>SAR EVALUATION REPORT</b>		Reviewed by: Quality Manager
Document S/N: OY1308141619-R1.A3L	Test Dates: 08/19/13 - 08/21/13	DUT Type: Portable Handset	Page 3 of 34	

### 1.3 DUT Antenna Locations

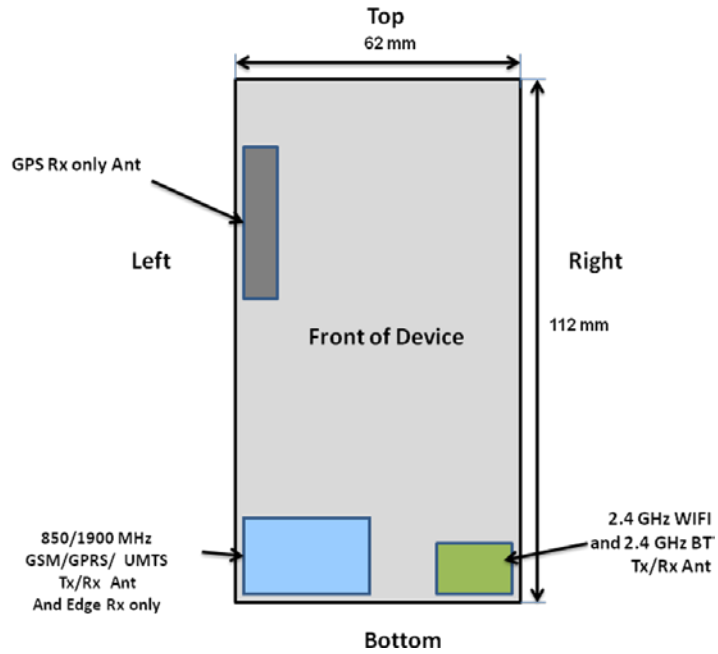



Note: Exact antenna dimensions and separation distances are shown in the Technical Descriptions in the FCC Filing.

**Figure 1-1**  
**DUT Antenna Locations**

**Table 1-1**  
**Mobile Hotspot Sides for SAR Testing**

Mobile Hotspot Sides for SAR Testing						
Mode	Back	Front	Top	Bottom	Right	Left
GPRS 850	Yes	Yes	No	Yes	No	Yes
UMTS 850	Yes	Yes	No	Yes	No	Yes
GPRS 1900	Yes	Yes	No	Yes	No	Yes
UMTS 1900	Yes	Yes	No	Yes	No	Yes
2.4 GHz WLAN	Yes	Yes	No	Yes	Yes	No

Note: Particular DUT edges were not required to be evaluated for Wireless Router SAR if the edges were greater than 2.5 cm from the transmitting antenna according to FCC KDB Publication 941225 D06v01r01 guidance, page 2. The FCC Filing shows the distance between the transmit antennas and the edges of the device.

FCC ID: A3LGTS6792L		<b>SAR EVALUATION REPORT</b>		Reviewed by: Quality Manager
Document S/N: OY1308141619-R1.A3L	Test Dates: 08/19/13 - 08/21/13	DUT Type: Portable Handset		Page 4 of 34

## 1.4 Simultaneous Transmission Capabilities

According to FCC KDB Publication 447498 D05v01r01, transmitters are considered to be transmitting simultaneously when there is overlapping transmission, with the exception of transmissions during network hand-offs with maximum hand-off duration less than 30 seconds. This device contains multiple transmitters that may operate simultaneously, and therefore requires a simultaneous transmission analysis according to FCC KDB Publication 447498 D01v05r01 3) procedures.

**Table 1-2  
Simultaneous Transmission Scenarios**

No.	Capable Transmit Configurations	Head	Body-Worn Accessory	Hot Spot	Note
		IEEE 1528, Supplement C	Supplement C	FCC KDB 941225 D06 Edges/Sides	
1	GSM 850/1900 MHz Voice + WiFi 2.4GHz	Yes	Yes	N/A	
2	850/1900 UMTS Voice + WiFi 2.4GHz	Yes	Yes	Yes	
3	850/1900 GPRS/EDGE Rx only + WIFI 2.4 GHz	N/A	N/A	Yes	2G Hotspot
4	850/1900 MHz UMTS Data + WIFI 2.4 GHz	Yes	Yes	Yes	3G Hotspot
5	850/1900 MHz GSM Voice + Bluetooth 2.4 GHz	N/A	Yes	N/A	
6	850/1900 MHz UMTS Voice + Bluetooth 2.4 GHz	N/A	Yes	N/A	

Notes:

- GSM/WCDMA use one modem and transceiver IC. The signals can not be transmitted simultaneously.

### Notes:

- When the user utilizes multiple services in UMTS 3G mode it uses multi-Radio Access Bearer or multi-RAB. The power control is based on a physical control channel (Dedicated Physical Control Channel [DPCCH]) and power control will be adjusted to meet the needs of both services. Therefore, the UMTS+WLAN scenario also represents the UMTS Voice/DATA + WLAN Hotspot scenario.
- Per the manufacturer, WIFI Direct is not expected to be used in conjunction with a held-to-ear or body-worn accessory voice call. Therefore, there are no simultaneous transmission scenarios involving WIFI direct beyond that listed in the above table.

## 1.5 SAR Test Exclusions Applied

### (A) WIFI/BT

Per FCC KDB 447498 D01v05r01, the SAR exclusion threshold for distances <50mm is defined by the following equation:



$$\frac{\text{Max Power of Channel (mW)}}{\text{Test Separation Dist (mm)}} * \sqrt{\text{Frequency(GHz)}} \leq 3.0$$

Based on the maximum conducted power of Bluetooth (rounded to the nearest mW) and the antenna to user separation distance, Bluetooth SAR was not required;  $[(10/10) * \sqrt{2.441}] = 1.6 < 3.0$ . Per KDB Publication 447498 D01v05r01, the maximum power of the channel was rounded to the nearest mW before calculation.

### (B) Licensed Transmitter(s)

GSM/GPRS DTM is not supported for US bands. Therefore, the GSM Voice modes in this report do not transmit simultaneously with GPRS Data.

This device is only capable of QPSK HSUPA in the uplink. Therefore, no additional SAR tests are required beyond that described for devices with HSUPA in KDB 941225 D01v02.

FCC ID: A3LGT56792L		SAR EVALUATION REPORT			Reviewed by: Quality Manager
Document S/N: OY1308141619-R1.A3L	Test Dates: 08/19/13 - 08/21/13	DUT Type: Portable Handset		Page 5 of 34	

## 1.6 Power Reduction for SAR

There is no power reduction used for any band/mode implemented in this device for SAR purposes.



## 1.7 Guidance Applied

- FCC OET Bulletin 65 Supplement C [June 2001]
- IEEE 1528-2003
- FCC KDB Publication 941225 D01-D06 (2G/3G and Hotspot)
- FCC KDB Publication 248227 D01v01r02 (SAR Considerations for 802.11 Devices)
- FCC KDB Publication 447498 D01v05r01 (General SAR Guidance)
- FCC KDB Publication 865664 D01-D02 (SAR Measurements up to 6 GHz)

## 1.8 Device Serial Numbers

Several samples were used with identical hardware to support SAR testing. The manufacturer has confirmed that the device(s) tested have the same physical, mechanical and thermal characteristics and are within operational tolerances expected for production units.

	Head Serial Number	Body-Worn Serial Number	Hotspot Serial Number
GSM/GPRS/EDGE Rx Only 850	FK-249-B	FK-249-B	FK-249-B
UMTS 850	FK-249-B	FK-249-B	FK-249-B
GSM/GPRS/EDGE Rx Only 1900	FK-249-B	FK-249-B	FK-249-B
UMTS 1900	FK-249-B	FK-249-C	FK-249-C
2.4 GHz WLAN	FK-249-C	FK-249-B	FK-249-B

FCC ID: A3LGTS6792L	 <b>PCTEST</b> ENGINEERING LABORATORY, INC.	<b>SAR EVALUATION REPORT</b>		<b>Reviewed by:</b> Quality Manager
<b>Document S/N:</b> 0Y1308141619-R1.A3L	<b>Test Dates:</b> 08/19/13 - 08/21/13	<b>DUT Type:</b> Portable Handset		Page 6 of 34

## 2 INTRODUCTION

The FCC and Industry Canada have adopted the guidelines for evaluating the environmental effects of radio frequency (RF) radiation in ET Docket 93-62 on Aug. 6, 1996 and Health Canada Safety Code 6 to protect the public and workers from the potential hazards of RF emissions due to FCC-regulated portable devices. [1]

The safety limits used for the environmental evaluation measurements are based on the criteria published by the American National Standards Institute (ANSI) for localized specific absorption rate (SAR) in IEEE/ANSI C95.1-1992 Standard for Safety Levels with Respect to Human Exposure to Radio Frequency Electromagnetic Fields, 3 kHz to 300 GHz [3] and Health Canada RF Exposure Guidelines Safety Code 6 [24]. The measurement procedure described in IEEE/ANSI C95.3-2002 Recommended Practice for the Measurement of Potentially Hazardous Electromagnetic Fields - RF and Microwave [4] is used for guidance in measuring the Specific Absorption Rate (SAR) due to the RF radiation exposure from the Equipment Under Test (EUT). These criteria for SAR evaluation are similar to those recommended by the International Committee for Non-Ionizing Radiation Protection (ICNIRP) in Biological Effects and Exposure Criteria for Radiofrequency Electromagnetic Fields,” Report No. Vol 74. SAR is a measure of the rate of energy absorption due to exposure to an RF transmitting source. SAR values have been related to threshold levels for potential biological hazards.

### 2.1 SAR Definition

Specific Absorption Rate is defined as the time derivative (rate) of the incremental energy (dU) absorbed by (dissipated in) an incremental mass (dm) contained in a volume element (dV) of a given density ( $\rho$ ). It is also defined as the rate of RF energy absorption per unit mass at a point in an absorbing body (see Equation 2-1).

**Equation 2-1**  
**SAR Mathematical Equation**

$$SAR = \frac{d}{dt} \left( \frac{dU}{dm} \right) = \frac{d}{dt} \left( \frac{dU}{\rho dv} \right)$$



**SAR is expressed in units of Watts per Kilogram (W/kg).**

$$SAR = \frac{\sigma \cdot E^2}{\rho}$$

where:

- $\sigma$  = conductivity of the tissue-simulating material (S/m)
- $\rho$  = mass density of the tissue-simulating material (kg/m<sup>3</sup>)
- E = Total RMS electric field strength (V/m)

NOTE: The primary factors that control rate of energy absorption were found to be the wavelength of the incident field in relation to the dimensions and geometry of the irradiated organism, the orientation of the organism in relation to the polarity of field vectors, the presence of reflecting surfaces, and whether conductive contact is made by the organism with a ground plane.[6]

FCC ID: A3LGTS6792L	 <b>PCTEST</b> ENGINEERING LABORATORY, INC.	<b>SAR EVALUATION REPORT</b>		Reviewed by: Quality Manager
Document S/N: OY1308141619-R1.A3L	Test Dates: 08/19/13 - 08/21/13	DUT Type: Portable Handset	Page 7 of 34	

### 3 DOSIMETRIC ASSESSMENT

#### 3.1 Measurement Procedure

The evaluation was performed using the following procedure:

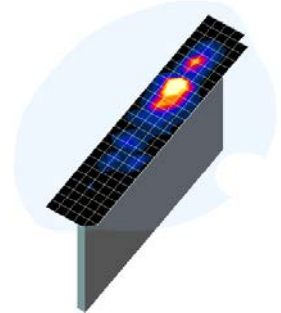

1. The SAR distribution at the exposed side of the head or body was measured at a distance no greater than 5.0 mm from the inner surface of the shell. The area covered the entire dimension of the device-head and body interface and the horizontal grid resolution was determined per FCC KDB Publication 865664 D01v01r01 (See Table 3-1).
2. The point SAR measurement was taken at the maximum SAR region determined from Step 1 to enable the monitoring of SAR fluctuations/drifts during the 1g/10g cube evaluation. SAR at this fixed point was measured and used as a reference value.
3. Based on the area scan data, the peak of the region with maximum SAR was determined by spline interpolation. Around this point, a volume was assessed according to the measurement resolution and volume size requirements of FCC KDB Publication 865664 D01v01r01 (See Table 3-1). On the basis of this data set, the spatial peak SAR value was evaluated with the following procedure (see references or the DASYS manual online for more details):
  - a. The data was extrapolated to the surface of the outer-shell of the phantom. The combined distance extrapolated was the combined distance from the center of the dipoles 2.7mm away from the tip of the probe housing plus the 1.2 mm distance between the surface and the lowest measuring point. The extrapolation was based on a least-squares algorithm. A polynomial of the fourth order was calculated through the points in the z-axis (normal to the phantom shell).
  - b. After the maximum interpolated values were calculated between the points in the cube, the SAR was averaged over the spatial volume (1g or 10g) using a 3D-Spline interpolation algorithm. The 3D-spline is composed of three one-dimensional splines with the “Not a knot” condition (in x, y, and z directions). The volume was then integrated with the trapezoidal algorithm. One thousand points (10 x 10 x 10) were obtained through interpolation, in order to calculate the averaged SAR.
  - c. All neighboring volumes were evaluated until no neighboring volume with a higher average value was found.
4. The SAR reference value, at the same location as step 2, was re-measured after the zoom scan was complete to calculate the SAR drift. If the drift deviated by more than 5%, the SAR test and drift measurements were repeated.



**Figure 3-1**  
**Sample SAR Area Scan**

**Table 3-1**  
**Area and Zoom Scan Resolutions per FCC KDB Publication 865664 D01v01r01**

Frequency	Maximum Area Scan Resolution (mm) ( $\Delta x_{area}, \Delta y_{area}$ )	Maximum Zoom Scan Resolution (mm) ( $\Delta x_{zoom}, \Delta y_{zoom}$ )	Maximum Zoom Scan Spatial Resolution (mm)			Minimum Zoom Scan Volume (mm) (x,y,z)
			Uniform Grid	Graded Grid		
			$\Delta z_{zoom}(n)$	$\Delta z_{zoom}(1)^*$	$\Delta z_{zoom}(n>1)^*$	
≤ 2 GHz	≤ 15	≤ 8	≤ 5	≤ 4	≤ 1.5* $\Delta z_{zoom}(n-1)$	≥ 30
2-3 GHz	≤ 12	≤ 5	≤ 5	≤ 4	≤ 1.5* $\Delta z_{zoom}(n-1)$	≥ 30
3-4 GHz	≤ 12	≤ 5	≤ 4	≤ 3	≤ 1.5* $\Delta z_{zoom}(n-1)$	≥ 28
4-5 GHz	≤ 10	≤ 4	≤ 3	≤ 2.5	≤ 1.5* $\Delta z_{zoom}(n-1)$	≥ 25
5-6 GHz	≤ 10	≤ 4	≤ 2	≤ 2	≤ 1.5* $\Delta z_{zoom}(n-1)$	≥ 22

FCC ID: A3LGTS6792L		<b>SAR EVALUATION REPORT</b>			Reviewed by: Quality Manager
Document S/N: OY1308141619-R1.A3L	Test Dates: 08/19/13 - 08/21/13	DUT Type: Portable Handset		Page 8 of 34	

# 4 DEFINITION OF REFERENCE POINTS

## 4.1 EAR REFERENCE POINT

Figure 4-2 shows the front, back and side views of the SAM Twin Phantom. The point “M” is the reference point for the center of the mouth, “LE” is the left ear reference point (ERP), and “RE” is the right ERP. The ERP is 15mm posterior to the entrance to the ear canal (EEC) along the B-M line (Back-Mouth), as shown in Figure 4-1. The plane passing through the two ear canals and M is defined as the Reference Plane. The line N-F (Neck-Front) is perpendicular to the reference plane and passing through the RE (or LE) is called the Reference Pivoting Line (see Figure 4-1). Line B-M is perpendicular to the N-F line. Both N-F and B-M lines are marked on the external phantom shell to facilitate handset positioning [5].

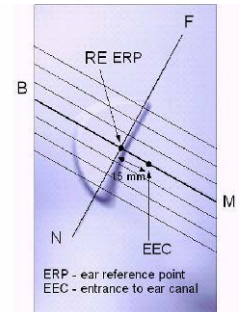

**Figure 4-1**  
Close-Up Side view of ERP

## 4.2 HANDSET REFERENCE POINTS



Two imaginary lines on the handset were established: the vertical centerline and the horizontal line. The test device was placed in a normal operating position with the “test device reference point” located along the “vertical centerline” on the front of the device aligned to the “ear reference point” (See Figure 4-3). The “test device reference point” was then located at the same level as the center of the ear reference point. The test device was positioned so that the “vertical centerline” was bisecting the front surface of the handset at its top and bottom edges, positioning the “ear reference point” on the outer surface of the both the left and right head phantoms on the ear reference point.

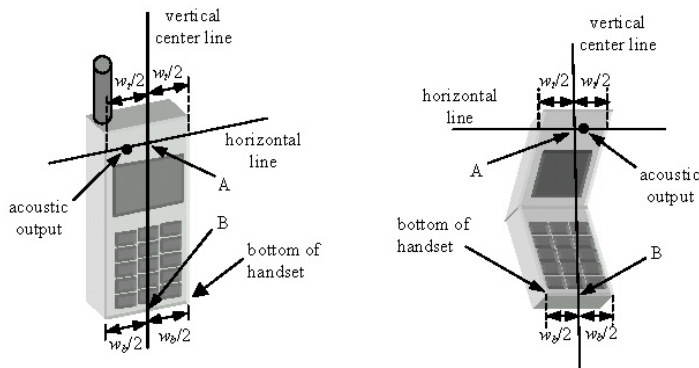

**Figure 4-2**  
Front, back and side view of SAM Twin Phantom



**Figure 4-3**  
Handset Vertical Center & Horizontal Line Reference Points

FCC ID: A3LGTS6792L		SAR EVALUATION REPORT		Reviewed by: Quality Manager
Document S/N: OY1308141619-R1.A3L	Test Dates: 08/19/13 - 08/21/13	DUT Type: Portable Handset		Page 9 of 34

## 5 TEST CONFIGURATION POSITIONS FOR HANDSETS

### 5.1 Device Holder

The device holder is made out of low-loss POM material having the following dielectric parameters: relative permittivity  $\epsilon = 3$  and loss tangent  $\delta = 0.02$ .

### 5.2 Positioning for Cheek

1. The test device was positioned with the device close to the surface of the phantom such that point A is on the (virtual) extension of the line passing through points RE and LE on the phantom (see Figure 5-1), such that the plane defined by the vertical center line and the horizontal line of the phone is approximately parallel to the sagittal plane of the phantom.

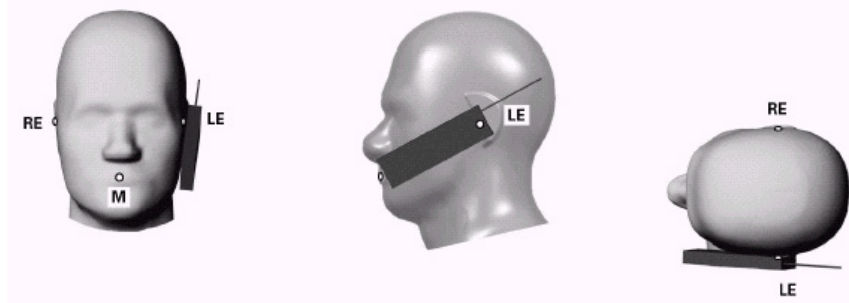



**Figure 5-1 Front, Side and Top View of Cheek Position**

2. The handset was translated towards the phantom along the line passing through RE & LE until the handset touches the ear.
3. While maintaining the handset in this plane, the handset was rotated around the LE-RE line until the vertical centerline was in the plane normal to MB-NF including the line MB (reference plane).
4. The phone was then rotated around the vertical centerline until the phone (horizontal line) was symmetrical with respect to the line NF.
5. While maintaining the vertical centerline in the reference plane, keeping point A on the line passing through RE and LE, and maintaining the device contact with the ear, the device was rotated about the NF line until any point on the handset made contact with a phantom point below the ear (cheek) (See Figure 5-2).

### 5.3 Positioning for Ear / 15° Tilt

With the test device aligned in the “Cheek Position”:

1. While maintaining the orientation of the phone, the phone was retracted parallel to the reference plane far enough to enable a rotation of the phone by 15 degrees.
2. The phone was then rotated around the horizontal line by 15 degrees.
3. While maintaining the orientation of the phone, the phone was moved parallel to the reference plane until any part of the handset touched the head. (In this position, point A was located on the line RE-LE). The tilted position is obtained when the contact is on the pinna. If the contact was at any location other than the pinna, the angle of the phone would then be reduced. The tilted position was obtained when any part of the phone was in contact of the ear as well as a second part of the phone was in contact with the head (see Figure 5-2).

FCC ID: A3LGTS6792L		SAR EVALUATION REPORT		Reviewed by: Quality Manager
Document S/N: OY1308141619-R1.A3L	Test Dates: 08/19/13 - 08/21/13	DUT Type: Portable Handset	Page 10 of 34	

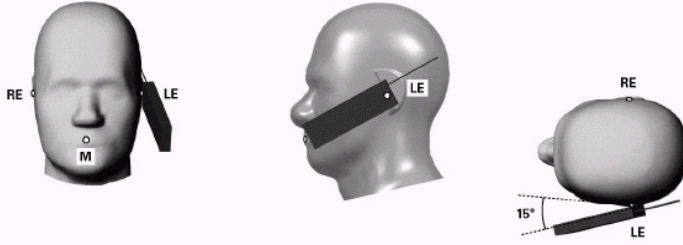

**Figure 5-2 Front, Side and Top View of Ear/15° Tilt Position**

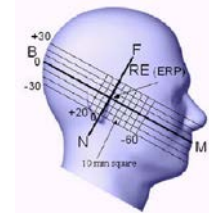

**Figure 5-3 Side view w/ relevant markings**

#### 5.4 SAR Evaluations near the Mouth/Jaw Regions of the SAM Phantom



Antennas located near the bottom of a phone may require SAR measurements around the mouth and jaw regions of the SAM head phantom. This typically applies to clam-shell style phones that are generally longer in the unfolded normal use positions or to certain older style long rectangular phones.

Under these circumstances, the following procedures apply, adopted from the FCC guidance on SAR handsets document FCC KDB Publication 648474 D04v01r01. The SAR required in these regions of SAM should be measured using a flat phantom. The phone should be positioned with a separation distance of 4 mm between the ear reference point (ERP) and the outer surface of the flat phantom shell. While maintaining this distance at the ERP location, the low (bottom) edge of the phone should be lowered from the phantom to establish the same separation distance between the peak SAR location identified by the truncated partial SAR distribution measured with the SAM phantom. The distance from the peak SAR location to the phone is determined by the straight line passing perpendicularly through the phantom surface. When it is not feasible to maintain 4 mm separation at the ERP while also establishing the required separation at the peak SAR location, the top edge of the phone will be allowed to touch the phantom with a separation < 4 mm at the ERP. The phone should not be tilted to the left or right while placed in this inclined position to the flat phantom.

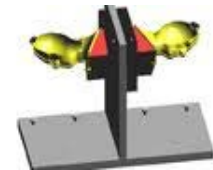
The latest IEEE 1528 committee developments propose the usage of a tilted phantom when the antenna of the phone is mounted at the bottom or in all cases the peak absorption is in the chin region. Both SAM heads of the TwinSAM-Chin20 are rotated 20 degrees around the NF line. Each head can be removed individually from the table for emptying and cleaning.

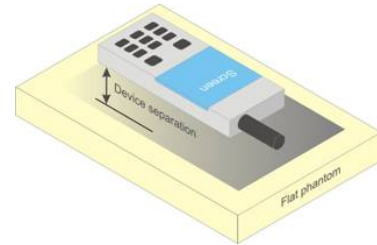

**Figure 5-4 Twin SAM Chin20**

FCC ID: A3LGTS6792L	 PCTEST ENGINEERING LABORATORY, INC.	SAR EVALUATION REPORT	 SAMSUNG	Reviewed by: Quality Manager
Document S/N: OY1308141619-R1.A3L	Test Dates: 08/19/13 - 08/21/13	DUT Type: Portable Handset		Page 11 of 34

## 5.5 Body-Worn Accessory Configurations

Body-worn operating configurations are tested with the belt-clips and holsters attached to the device and positioned against a flat phantom in a normal use configuration (see Figure 6-5). Per FCC KDB Publication 648474 D04v01r01, Body-worn accessory exposure is typically related to voice mode operations when handsets are carried in body-worn accessories. The body-worn accessory procedures in FCC KDB Publication 447498 D01v05r01 should be used to test for body-worn accessory SAR compliance, without a headset connected to it. This enables the test results for such configuration to be compatible with that required for hotspot mode when the body-worn accessory test separation distance is greater than or equal to that required for hotspot mode, when applicable. When the reported SAR for a body-worn accessory, measured without a headset connected to the handset, is  $> 1.2 \text{ W/kg}$ , the highest reported SAR configuration for that wireless mode and frequency band should be repeated for that body-worn accessory with a headset attached to the handset.



**Figure 6-5**  
**Sample Body-Worn Diagram**



Accessories for Body-worn operation configurations are divided into two categories: those that do not contain metallic components and those that do contain metallic components. When multiple accessories that do not contain metallic components are supplied with the device, the device is tested with only the accessory that dictates the closest spacing to the body. Then multiple accessories that contain metallic components are tested with the device with each accessory. If multiple accessories share an identical metallic component (i.e. the same metallic belt-clip used with different holsters with no other metallic components) only the accessory that dictates the closest spacing to the body is tested.

Body-worn accessories may not always be supplied or available as options for some devices intended to be authorized for body-worn use. In this case, a test configuration with a separation distance between the back of the device and the flat phantom is used. Test position spacing was documented. Transmitters that are designed to operate in front of a person's face, as in push-to-talk configurations, are tested for SAR compliance with the front of the device positioned to face the flat phantom in head fluid. For devices that are carried next to the body such as a shoulder, waist or chest-worn transmitters, SAR compliance is tested with the accessories, including headsets and microphones, attached to the device and positioned against a flat phantom in a normal use configuration.

## 5.6 Extremity Exposure Configurations

Devices that are designed or intended for use on extremities or mainly operated in extremity only exposure conditions; i.e., hands, wrists, feet and ankles, may require extremity SAR evaluation. When the device also operates in close proximity to the user's body, SAR compliance for the body is also required. The 1-g body and 10-g extremity SAR Exclusion Thresholds found in KDB Publication 44798 D01v05 should be applied to determine SAR test requirements.



Per KDB Publication 44798 D01v05, Cell phones (handsets) are not normally designed to be used on extremities or operated in extremity only exposure conditions. The maximum output power levels of handsets generally do not require extremity SAR testing to show compliance. Therefore, extremity SAR was not evaluated for this device.

FCC ID: A3LGTS6792L	 <b>SAR EVALUATION REPORT</b> 		Reviewed by: Quality Manager
Document S/N: OY1308141619-R1.A3L	Test Dates: 08/19/13 - 08/21/13	DUT Type: Portable Handset	Page 12 of 34

## 5.7 Wireless Router Configurations

Some battery-operated handsets have the capability to transmit and receive user data through simultaneous transmission of WIFI simultaneously with a separate licensed transmitter. The FCC has provided guidance in FCC KDB Publication 941225 D06 v01r01 where SAR test considerations for handsets (L x W  $\geq$  9 cm x 5 cm) are based on a composite test separation distance of 10 mm from the front, back and edges of the device containing transmitting antennas within 2.5 cm of their edges, determined from general mixed use conditions for this type of devices. Since the hotspot SAR results may overlap with the body-worn accessory SAR requirements, the more conservative configurations can be considered, thus excluding some body-worn accessory SAR tests.

When the user enables the personal wireless router functions for the handset, actual operations include simultaneous transmission of both the WIFI transmitter and another licensed transmitter. Both transmitters often do not transmit at the same transmitting frequency and thus cannot be evaluated for SAR under actual use conditions due to the limitations of the SAR assessment probes. Therefore, SAR must be evaluated for each frequency transmission and mode separately and spatially summed with the WIFI transmitter according to FCC KDB Publication 447498 D01v05r01 publication procedures. The "Portable Hotspot" feature on the handset was NOT activated during SAR assessments, to ensure the SAR measurements were evaluated for a single transmission frequency RF signal at a time.

FCC ID: A3LGTS6792L	 <b>SAR EVALUATION REPORT</b> 		Reviewed by: Quality Manager
Document S/N: OY1308141619-R1.A3L	Test Dates: 08/19/13 - 08/21/13	DUT Type: Portable Handset	Page 13 of 34

## 6 RF EXPOSURE LIMITS

### 6.1 Uncontrolled Environment

UNCONTROLLED ENVIRONMENTS are defined as locations where there is the exposure of individuals who have no knowledge or control of their exposure. The general population/uncontrolled exposure limits are applicable to situations in which the general public may be exposed or in which persons who are exposed as a consequence of their employment may not be made fully aware of the potential for exposure or cannot exercise control over their exposure. Members of the general public would come under this category when exposure is not employment-related; for example, in the case of a wireless transmitter that exposes persons in its vicinity.



### 6.2 Controlled Environment

CONTROLLED ENVIRONMENTS are defined as locations where there is exposure that may be incurred by persons who are aware of the potential for exposure, (i.e. as a result of employment or occupation). In general, occupational/controlled exposure limits are applicable to situations in which persons are exposed as a consequence of their employment, who have been made fully aware of the potential for exposure and can exercise control over their exposure. This exposure category is also applicable when the exposure is of a transient nature due to incidental passage through a location where the exposure levels may be higher than the general population/uncontrolled limits, but the exposed person is fully aware of the potential for exposure and can exercise control over his or her exposure by leaving the area or by some other appropriate means.

**Table 6-1**  
**SAR Human Exposure Specified in ANSI/IEEE C95.1-1992 and Health Canada Safety Code 6**

HUMAN EXPOSURE LIMITS		
	UNCONTROLLED ENVIRONMENT <i>General Population</i> (W/kg) or (mW/g)	CONTROLLED ENVIRONMENT <i>Occupational</i> (W/kg) or (mW/g)
<b>Peak Spatial Average SAR</b> Head	1.6	8.0
<b>Whole Body SAR</b>	0.08	0.4
<b>Peak Spatial Average SAR</b> Hands, Feet, Ankle, Wrists, etc.	4.0	20

1. The Spatial Peak value of the SAR averaged over any 1 gram of tissue (defined as a tissue volume in the shape of a cube) and over the appropriate averaging time.
2. The Spatial Average value of the SAR averaged over the whole body.
3. The Spatial Peak value of the SAR averaged over any 10 grams of tissue (defined as a tissue volume in the shape of a cube) and over the appropriate averaging time.

FCC ID: A3LGTS6792L	 PCTEST ENGINEERING LABORATORY, INC.	SAR EVALUATION REPORT	 SAMSUNG	Reviewed by: Quality Manager
Document S/N: OY1308141619-R1.A3L	Test Dates: 08/19/13 - 08/21/13	DUT Type: Portable Handset		Page 14 of 34

## 7 FCC MEASUREMENT PROCEDURES

Power measurements were performed using a base station simulator under digital average power.

### 7.1 Measured and Reported SAR

Per FCC KDB Publication 447498 D01v05r01, When SAR is not measured at the maximum power level allowed for production units, the results must be scaled to the maximum tune-up tolerance limit according to the power applied to the individual channels tested to determine compliance. For simultaneous transmission, the measured aggregate SAR must be scaled according to the sum of the differences between the maximum tune-up tolerance and actual power used to test each transmitter. When SAR is measured at or scaled to the maximum tune-up tolerance limit, the results are referred to as *reported* SAR. The highest *reported* SAR results are identified on the grant of equipment authorization according to procedures in KDB 690783 D01v01r02.

### 7.2 Procedures Used to Establish RF Signal for SAR

The following procedures are according to FCC KDB Publication 941225 D01 "SAR Measurement Procedures for 3G Devices" v02, October 2007.

The device was placed into a simulated call using a base station simulator in a RF shielded chamber. Establishing connections in this manner ensure a consistent means for testing SAR and are recommended for evaluating SAR [4]. Devices under test were evaluated prior to testing, with a fully charged battery and were configured to operate at maximum output power. In order to verify that the device was tested throughout the SAR test at maximum output power, the SAR measurement system measures a "point SAR" at an arbitrary reference point at the start and end of the 1 gram SAR evaluation, to assess for any power drifts during the evaluation. If the power drift deviated by more than 5%, the SAR test and drift measurements were repeated.

### 7.3 SAR Measurement Conditions for UMTS



#### 7.3.1 Output Power Verification

Maximum output power is measured on the High, Middle and Low channels for each applicable transmission band according to the general descriptions in section 5.2 of 3GPP TS 34.121, using the appropriate RMC or AMR with TPC (transmit power control) set to all "1s".

Maximum output power is verified on the High, Middle and Low channels according to the general descriptions in section 5.2 of 3GPP TS 34.121 (release 5), using the appropriate RMC with TPC (transmit power control) set to all "1s" or applying the required inner loop power control procedures to maintain maximum output power while HSUPA is active. Results for all applicable physical channel configurations (DPCCH, DPDCHe and spreading codes, HS-DPCCH etc) are tabulated in this test report. All configurations that are not supported by the DUT or cannot be measured due to technical or equipment limitations are identified.

#### 7.3.2 Head SAR Measurements for Handsets

SAR for head exposure configurations is measured using the 12.2 kbps RMC with TPC bits configured to all "1s". SAR in AMR configurations is not required when the maximum average output of each RF channel for 12.2 kbps AMR is less than 0.25 dB higher than that measured in 12.2 kbps RMC. Otherwise, SAR is measured on the maximum output channel in 12.2 AMR with a 3.4 kbps SRB (signaling radio bearer) using the exposure configuration that resulted in the highest SAR for that RF channel in the 12.2 kbps RMC mode.

FCC ID: A3LGTS6792L		SAR EVALUATION REPORT		Reviewed by: Quality Manager
Document S/N: OY1308141619-R1.A3L	Test Dates: 08/19/13 - 08/21/13	DUT Type: Portable Handset		Page 15 of 34

### 7.3.3 Body SAR Measurements

SAR for body exposure configurations is measured using the 12.2 kbps RMC with the TPC bits all “1s”.

### 7.3.4 SAR Measurements for Handsets with Rel 5 HSDPA

Body SAR for HSDPA is not required for handsets with HSDPA capabilities when the maximum average output power of each RF channel with HSDPA active is less than 0.25 dB higher than that measured without HSDPA using 12.2 kbps RMC and the maximum SAR for 12.2 kbps RMC is  $\leq 75\%$  of the SAR limit.

Otherwise, SAR is measured for HSDPA, using an FRC with H-Set 1 in Sub-test 1 and a 12.2 kbps RMC configured in Test Loop Mode 1, using the highest body SAR configuration measured in 12.2 kbps RMC without HSDPA, on the maximum output channel with the body exposure configuration that resulted in the highest SAR in 12.2 kbps RMC mode for that RF channel.

The H-set used in FRC for HSDPA should be configured according to the UE category of a test device. The number of HS-DSCH/HSPDSCHs, HARQ processes, minimum inter-TTI interval, transport block sizes and RV coding sequence are defined by the applicable H-set. To maintain a consistent test configuration and stable transmission conditions, QPSK is used in the FRC for SAR testing. HS-DPCCH should be configured with a CQI feedback cycle of 2 ms to maintain a constant rate of active CQI slots. DPCCH and DPDCH gain factors of  $\beta_c=9$  and  $\beta_d=15$ , and power offset parameters of  $\Delta_{ACK} = \Delta_{NACK} = 5$  and  $\Delta_{CQI}=2$  is used. The CQI value is determined by the UE category, transport block size, number of HS-PDSCHs and modulation used in the FRC.

Sub-Test	$\beta_c$	$\beta_d$	$\beta_d$ (SF)	$\beta_c/\beta_d$	$\beta_{HS}$ (Note 2)	CM (dB) (Note 3)	MPR (dB) (Note 3)
1	2/15	15/15	64	2/15	4/15	0.0	0.0
2	12/15 (Note 4)	15/15 (Note 4)	64	12/15 (Note 4)	24/15	1.0	0.0
3	15/15	8/15	64	15/8	30/15	1.5	0.5
4	15/15	4/15	64	15/4	30/15	1.5	0.5

Note 1:  $\Delta_{ACK}, \Delta_{NACK}$  and  $\Delta_{CQI} = 8 \Rightarrow A_{HS} = \beta_d/\beta_c = 30/15 \Rightarrow \beta_{HS} = 30/15 * \beta_c$ .  
 Note 2: For the HS-DPCCH power mask requirement test in clause 5.2C, 5.7A, and the Error Vector Magnitude (EVM) with HS-DPCCH test in clause 5.13.1A, and HSDPA EVM with phase discontinuity in clause 5.13.1AA,  $\Delta_{ACK}$  and  $\Delta_{NACK} = 8$  ( $A_{HS} = 30/15$ ) with  $\beta_{HS} = 30/15 * \beta_c$ , and  $\Delta_{CQI} = 7$  ( $A_{HS} = 24/15$ ) with  $\beta_{HS} = 24/15 * \beta_c$ .  
 Note 3: CM = 1 for  $\beta_c/\beta_d = 12/15$ ,  $\beta_d/\beta_c = 24/15$ . For all other combinations of DPDCH, DPCCH and HS-DPCCH the MPR is based on the relative CM difference. This is applicable for only UEs that support HSDPA in release 6 and later releases.

Figure 7-1  
Table C.10.1.4 of TS 234.121-1



### 7.3.5 SAR Measurements for Handsets with Rel 6 HSUPA

Body SAR for HSUPA is not required when the maximum average output of each RF channel with HSUPA/HSDPA active is less than 0.25 dB higher than as measured without HSUPA/HSDPA using 12.2 kbps RMC and maximum SAR for 12.2 kbps RMC is  $\leq 75\%$  of the SAR limit. Otherwise SAR is measured on the maximum output channel for the body exposure configuration produced highest SAR in 12.2 kbps RMC for that RF channel, using the additional procedures under “Release 6 HSPA data devices”

Head SAR for VOIP operations under HSPA is not required when maximum average output of each RF channel with HSPA is less than 0.25 dB higher than as measured using 12.2 kbps RMC. Otherwise SAR is measured using same HSPA configuration as used for body SAR.

Sub-test	$\beta_c$	$\beta_d$	$\beta_d$ (SF)	$\beta_c/\beta_d$	$\beta_{HS}^{(1)}$	$\beta_{EC}$	$\beta_{ED}$	$\beta_{ED}$ (SF)	$\beta_{ED}$ (codes)	CM <sup>(2)</sup> (dB)	MPR (dB)	AG <sup>(4)</sup> Index	E-TFC1
1	11/15 <sup>(3)</sup>	15/15 <sup>(3)</sup>	64	11/15 <sup>(3)</sup>	22/15	209/225	1039/225	4	1	1.0	0.0	20	75
2	6/15	15/15	64	6/15	12/15	12/15	94/75	4	1	3.0	2.0	12	67
3	15/15	9/15	64	15/9	30/15	30/15	$\beta_{ED} = 47/15$ $\beta_{ED} = 47/15$	4	2	2.0	1.0	15	92
4	2/15	15/15	64	2/15	4/15	2/15	56/75	4	1	3.0	2.0	17	71
5	15/15 <sup>(4)</sup>	15/15 <sup>(4)</sup>	64	15/15 <sup>(4)</sup>	30/15	24/15	134/15	4	1	1.0	0.0	21	81

Note 1:  $\Delta_{ACK}, \Delta_{NACK}$  and  $\Delta_{CQI} = 8 \Rightarrow A_{HS} = \beta_d/\beta_c = 30/15 \Rightarrow \beta_{HS} = 30/15 * \beta_c$ .  
 Note 2: CM = 1 for  $\beta_c/\beta_d = 12/15$ ,  $\beta_d/\beta_c = 24/15$ . For all other combinations of DPDCH, DPCCH, HS-DPCCH, E-DPDCH and E-DPCCH the MPR is based on the relative CM difference.  
 Note 3: For subtest 1 the  $\beta_c/\beta_d$  ratio of 11/15 for the TFC during the measurement period (TF1, TF0) is achieved by setting the signaled gain factors for the reference TFC (TF1, TF1) to  $\beta_c = 10/15$  and  $\beta_d = 15/15$ .  
 Note 4: For subtest 5 the  $\beta_c/\beta_d$  ratio of 15/15 for the TFC during the measurement period (TF1, TF0) is achieved by setting the signaled gain factors for the reference TFC (TF1, TF1) to  $\beta_c = 14/15$  and  $\beta_d = 15/15$ .  
 Note 5: Testing UE using E-DPDCH Physical Layer category 1 Sub-test 3 is not required according to TS 25.306 Table 5.1g.  
 Note 6:  $\beta_{ED}$  can not be set directly; it is set by Absolute Grant Value.

FCC ID: A3LGTS6792L	 PCTEST Engineering Laboratory, Inc.	SAR EVALUATION REPORT		Reviewed by: Quality Manager
Document S/N: OY1308141619-R1.A3L	Test Dates: 08/19/13 - 08/21/13	DUT Type: Portable Handset		Page 16 of 34

## 7.4 SAR Testing with 802.11 Transmitters

Normal network operating configurations are not suitable for measuring the SAR of 802.11 b/g/n transmitters. Unpredictable fluctuations in network traffic and antenna diversity conditions can introduce undesirable variations in SAR results. The SAR for these devices should be measured using chipset based test mode software to ensure the results are consistent and reliable. See KDB Publication 248227 D01v01r02 for more details.



### 7.4.1 General Device Setup

Chipset based test mode software is hardware dependent and generally varies among manufacturers. The device operating parameters established in test mode for SAR measurements must be identical to those programmed in production units, including output power levels, amplifier gain settings and other RF performance tuning parameters. The test frequencies should correspond to actual channel frequencies defined for domestic use. SAR for devices with switched diversity should be measured with only one antenna transmitting at a time during each SAR measurement, according to a fixed modulation and data rate. The same data pattern should be used for all measurements.

### 7.4.2 Frequency Channel Configurations [27]

For 2.4 GHz, the highest average RF output power channel between the low, mid and high channel at the lowest data rate was selected for SAR evaluation in 802.11b mode. 802.11g/n modes and higher data rates for 802.11b were additionally evaluated for SAR if the output power of the respective mode was 0.25 dB or higher than the powers of the SAR configurations tested in the 802.11b mode.

If the maximum extrapolated peak SAR of the zoom scan for the highest output channel was less than 1.6 W/kg and if the 1g averaged SAR was less than 0.8 W/kg, SAR testing was not required for the other test channels in the band.

FCC ID: A3LGTS6792L	 <b>PCTEST</b> ENGINEERING LABORATORY, INC.	<b>SAR EVALUATION REPORT</b>		Reviewed by: Quality Manager
Document S/N: OY1308141619-R1.A3L	Test Dates: 08/19/13 - 08/21/13	DUT Type: Portable Handset		Page 17 of 34

# 8 RF CONDUCTED POWERS

## 8.1 GSM Conducted Powers

		Maximum Burst-Averaged Output Power				
		Voice	GPRS/EDGE Data (GMSK)			
Band	Channel	GSM [dBm] CS (1 Slot)	GPRS [dBm] 1 Tx Slot	GPRS [dBm] 2 Tx Slot	GPRS [dBm] 3 Tx Slot	GPRS [dBm] 4 Tx Slot
<b>GSM 850</b>	128	32.50	32.56	<b>30.13</b>	28.11	<b>27.10</b>
	190	32.49	32.57	<b>30.13</b>	28.13	<b>27.12</b>
	251	32.46	32.47	<b>30.02</b>	28.02	<b>27.01</b>
<b>GSM 1900</b>	512	29.50	29.49	26.81	24.86	<b>23.79</b>
	661	29.47	29.46	27.05	25.09	<b>24.07</b>
	810	29.48	29.48	27.27	25.40	<b>24.41</b>

		Calculated Maximum Frame-Averaged Output Power				
		Voice	GPRS/EDGE Data (GMSK)			
Band	Channel	GSM [dBm] CS (1 Slot)	GPRS [dBm] 1 Tx Slot	GPRS [dBm] 2 Tx Slot	GPRS [dBm] 3 Tx Slot	GPRS [dBm] 4 Tx Slot
<b>GSM 850</b>	128	23.47	23.53	<b>24.11</b>	23.85	<b>24.09</b>
	190	23.46	23.54	<b>24.11</b>	23.87	<b>24.11</b>
	251	23.43	23.44	<b>24.00</b>	23.76	<b>24.00</b>
<b>GSM 1900</b>	512	20.47	20.46	20.79	20.60	<b>20.78</b>
	661	20.44	20.43	21.03	20.83	<b>21.06</b>
	810	20.45	20.45	21.25	21.14	<b>21.40</b>



Note:

- Both burst-averaged and calculated frame-averaged powers are included. Frame-averaged power was calculated from the measured burst-averaged power by converting the slot powers into linear units and calculating the energy over 8 timeslots.
- The bolded GPRS modes were selected for SAR testing according to the highest frame-averaged output power table according to KDB 941225 D03v01.
- GPRS (GMSK) output powers were measured with coding scheme setting of 1 (CS1) on the base station simulator. CS1 was configured to measure GPRS output power measurements and SAR to ensure GMSK modulation in the signal. Our Investigation has shown that CS1 - CS4 settings do not have any impact on the output levels or modulation in the GPRS modes.

**GSM Class: B**  
**GPRS Multislot class: 12 (Max 4 Tx uplink slots)**  
**EDGE Multislot class: Rx Only**  
**DTM Multislot Class: N/A**



**Figure 8-1  
Power Measurement Setup**

FCC ID: A3LGT56792L		<b>SAR EVALUATION REPORT</b>		Reviewed by: Quality Manager
Document S/N: OY1308141619-R1.A3L	Test Dates: 08/19/13 - 08/21/13	DUT Type: Portable Handset		Page 18 of 34

## 8.2 UMTS Conducted Powers

3GPP Release Version	Mode	3GPP 34.121 Subtest	Cellular Band [dBm]			PCS Band [dBm]			3GPP MPR [dB]
			4132	4183	4233	9262	9400	9538	
99	WCDMA	12.2 kbps RMC	22.99	22.87	22.98	22.66	22.98	22.93	-
99		12.2 kbps AMR	22.75	22.75	22.98	22.84	22.97	22.93	-
6	HSDPA	Subtest 1	22.72	22.74	22.78	22.21	22.53	22.60	0
6		Subtest 2	22.40	22.38	22.48	22.46	22.38	22.34	0
6		Subtest 3	22.92	22.82	22.61	22.40	22.50	22.45	0.5
6		Subtest 4	22.61	22.95	22.57	22.52	22.60	22.38	0.5
6	HSUPA	Subtest 1	21.17	21.15	20.75	20.43	20.75	20.83	0
6		Subtest 2	19.64	19.19	19.21	18.86	18.99	18.29	2
6		Subtest 3	20.93	20.94	20.43	20.19	19.82	20.45	1
6		Subtest 4	19.84	19.93	19.69	19.48	19.45	19.55	2
6		Subtest 5	21.19	21.28	21.04	20.77	21.22	21.17	0



UMTS SAR was tested under RMC 12.2 kbps with HSPA Inactive per KDB Publication 941225 D01v02. HSPA SAR was not required since the average output power of the HSPA subtests was not more than 0.25 dB higher than the RMC level and SAR was less than 1.2 W/kg.

This device does not support DC-HSDPA.

It is expected by the manufacturer that MPR for some HSUPA subtests may be up to 1 dB more than specified by 3GPP, but also as low as 0 dB according to the chipset implementation in this model.



**Figure 8-2**  
**Power Measurement Setup**

FCC ID: A3LGTS6792L	 <b>SAR EVALUATION REPORT</b> 		Reviewed by: Quality Manager
Document S/N: OY1308141619-R1.A3L	Test Dates: 08/19/13 - 08/21/13	DUT Type: Portable Handset	Page 19 of 34

### 8.3 WLAN Conducted Powers

**Table 8-1**  
**IEEE 802.11b Average RF Power**

Mode	Freq	Channel	802.11b (2.4 GHz) Conducted Power [dBm]			
	[MHz]		Data Rate [Mbps]			
			1	2	5.5	11
802.11b	2412	1	15.66	15.65	15.65	15.61
802.11b	2437	6	15.92	15.96	15.94	15.88
802.11b	2462	11*	<b>16.24</b>	16.27	16.21	16.16

**Table 8-2**  
**IEEE 802.11g Average RF Power**

Mode	Freq	Channel	802.11g (2.4 GHz) Conducted Power [dBm]							
	[MHz]		Data Rate [Mbps]							
			6	9	12	18	24	36	48	54
802.11g	2412	1	11.64	11.62	11.66	11.56	11.51	11.56	11.55	11.45
802.11g	2437	6	11.91	11.87	11.82	11.76	11.85	11.85	11.90	11.84
802.11g	2462	11	12.09	12.05	12.06	12.02	12.12	12.12	12.00	12.05

**Table 8-3**  
**IEEE 802.11n Average RF Power**

Mode	Freq	Channel	802.11n (2.4 GHz) Conducted Power [dBm]							
	[MHz]		Data Rate [Mbps]							
			6.5	13	20	26	39	52	58	65
802.11n	2412	1	10.67	10.71	10.73	10.71	10.71	10.62	10.67	10.63
802.11n	2437	6	10.93	10.93	10.90	10.88	10.92	10.86	10.84	10.84
802.11n	2462	11	11.13	11.13	11.15	11.14	11.13	11.10	11.15	11.15

Justification for reduced test configurations for WIFI channels per KDB Publication 248227 D01v01r02 and October 2012/April 2013 FCC/TCB Meeting Notes:

- For 2.4 GHz, highest average RF output power channel for the lowest data rate for IEEE 802.11b were selected for SAR evaluation. Other IEEE 802.11 modes (including 802.11g/n) were not investigated since the average output powers over all channels and data rates were not more than 0.25 dB higher than the tested channel in the lowest data rate of IEEE 802.11b mode.
- The maximum extrapolated peak SAR of the zoom scan for the maximum output channel is <1.6 W/kg and the reported 1g averaged SAR is <0.8 W/kg, SAR testing on other channels is not required.
- The bolded data rate and channel above were tested for SAR.



**Figure 8-3**  
**Power Measurement Setup**

FCC ID: A3LGT56792L	PCTEST ENGINEERING LABORATORY, INC.	SAR EVALUATION REPORT	SAMSUNG	Reviewed by: Quality Manager
Document S/N: OY1308141619-R1.A3L	Test Dates: 08/19/13 - 08/21/13	DUT Type: Portable Handset		Page 20 of 34



# 9 SYSTEM VERIFICATION

## 9.1 Tissue Verification

**Table 9-1  
Measured Tissue Properties**

Calibrated for Tests Performed on:	Tissue Type	Tissue Temp During Calibration (C°)	Measured Frequency (MHz)	Measured Conductivity, $\sigma$ (S/m)	Measured Dielectric Constant, $\epsilon$	TARGET Conductivity, $\sigma$ (S/m)	TARGET Dielectric Constant, $\epsilon$	% dev $\sigma$	% dev $\epsilon$
08/21/2013	835H	22.3	820	0.875	40.822	0.898	41.571	-2.56%	-1.80%
			835	0.886	40.641	0.900	41.500	-1.56%	-2.07%
			850	0.899	40.564	0.916	41.500	-1.86%	-2.26%
08/21/2013	1900H	22.6	1850	1.369	38.578	1.400	40.000	-2.21%	-3.55%
			1880	1.396	38.428	1.400	40.000	-0.29%	-3.93%
			1910	1.424	38.343	1.400	40.000	1.71%	-4.14%
08/19/2013	2450H	24.0	2401	1.815	38.455	1.758	39.298	3.24%	-2.15%
			2450	1.874	38.250	1.800	39.200	4.11%	-2.42%
			2499	1.927	38.024	1.852	39.135	4.05%	-2.84%
08/19/2013	835B	22.8	820	0.988	55.313	0.969	55.258	1.96%	0.10%
			835	1.014	55.115	0.970	55.200	4.54%	-0.15%
			850	1.031	54.724	0.988	55.154	4.35%	-0.78%
08/19/2013	1900B	22.0	1850	1.491	54.818	1.520	53.300	-1.91%	2.85%
			1880	1.528	54.724	1.520	53.300	0.53%	2.67%
			1910	1.560	54.670	1.520	53.300	2.63%	2.57%
08/21/2013	1900B	22.9	1850	1.501	52.177	1.520	53.300	-1.25%	-2.11%
			1880	1.531	52.073	1.520	53.300	0.72%	-2.30%
			1910	1.561	51.969	1.520	53.300	2.70%	-2.50%
08/19/2013	2450B	22.1	2401	1.964	50.961	1.903	52.765	3.21%	-3.42%
			2450	2.030	50.700	1.950	52.700	4.10%	-3.80%
			2499	2.110	52.561	2.019	52.638	4.51%	-0.15%

The above measured tissue parameters were used in the DASY software. The DASY software was used to perform interpolation to determine the dielectric parameters at the SAR test device frequencies (per IEEE 1528 6.6.1.2). The tissue parameters listed in the SAR test plots may slightly differ from the table above due to significant digit rounding in the software.

FCC ID: A3LGT56792L			SAR EVALUATION REPORT			Reviewed by: Quality Manager
Document S/N: OY1308141619-R1.A3L	Test Dates: 08/19/13 - 08/21/13	DUT Type: Portable Handset		Page 21 of 34		

## 9.2 Test System Verification

Prior to SAR assessment, the system is verified to  $\pm 10\%$  of the SAR measurement on the reference dipole at the time of calibration by the calibration facility. Full system validation status and result summary can be found in Appendix E.

**Table 9-2  
System Verification Results**

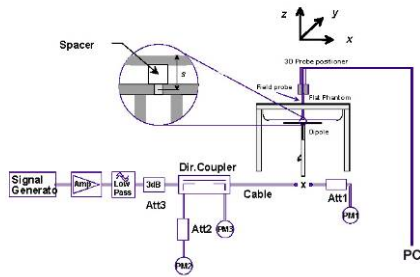

System Verification TARGET & MEASURED												
SAR System #	Tissue Frequency (MHz)	Tissue Type	Date:	Amb. Temp (°C)	Liquid Temp (°C)	Input Power (W)	Dipole SN	Probe SN	Measured SAR <sub>1g</sub> (W/kg)	1 W Target SAR <sub>1g</sub> (W/kg)	1 W Normalized SAR <sub>1g</sub> (W/kg)	Deviation <sub>1g</sub> (%)
H	835	HEAD	08/21/2013	22.6	22.3	0.100	4d119	3318	0.943	9.680	9.430	-2.58%
G	1900	HEAD	08/21/2013	23.4	22.6	0.100	5d148	3209	3.910	39.700	39.100	-1.51%
C	2450	HEAD	08/19/2013	23.5	23.5	0.100	882	3263	5.440	51.700	54.400	5.22%
G	835	BODY	08/19/2013	24.1	22.8	0.100	4d026	3209	0.998	9.580	9.980	4.18%
B	1900	BODY	08/19/2013	23.5	22.0	0.100	5d141	3287	4.320	41.500	43.200	4.10%
E	1900	BODY	08/21/2013	24.1	23.0	0.100	5d148	3920	4.360	40.800	43.600	6.86%
H	2450	BODY	08/19/2013	22.8	22.1	0.040	797	3318	2.150	49.600	53.750	8.37%



**Figure 9-1  
System Verification Setup Diagram**



**Figure 9-2  
System Verification Setup Photo**

FCC ID: A3LGTS6792L		SAR EVALUATION REPORT		Reviewed by: Quality Manager
Document S/N: OY1308141619-R1.A3L	Test Dates: 08/19/13 - 08/21/13	DUT Type: Portable Handset		Page 22 of 34

# 10 SAR DATA SUMMARY

## 10.1 Standalone Head SAR Data

**Table 10-1  
GSM 850 Head SAR**



MEASUREMENT RESULTS														
FREQUENCY		Mode/Band	Service	Maximum Allowed Power [dBm]	Conducted Power [dBm]	Power Drift [dB]	Side	Test Position	Device Serial Number	Duty Cycle	SAR (1g)	Scaling Factor	Scaled SAR (1g)	Plot #
MHz	Ch.										(W/kg)		(W/kg)	
836.60	190	GSM 850	GSM	33.0	32.49	0.01	Right	Cheek	FK-249-B	1:8.3	0.300	1.125	0.338	
836.60	190	GSM 850	GSM	33.0	32.49	0.07	Right	Tilt	FK-249-B	1:8.3	0.212	1.125	0.239	
836.60	190	GSM 850	GSM	33.0	32.49	0.05	Left	Cheek	FK-249-B	1:8.3	0.390	1.125	0.439	A1
836.60	190	GSM 850	GSM	33.0	32.49	-0.04	Left	Tilt	FK-249-B	1:8.3	0.210	1.125	0.236	
ANSI / IEEE C95.1 1992 - SAFETY LIMIT Spatial Peak Uncontrolled Exposure/General Population							Head 1.6 W/kg (mW/g) averaged over 1 gram							

**Table 10-2  
UMTS 850 Head SAR**

MEASUREMENT RESULTS														
FREQUENCY		Mode/Band	Service	Maximum Allowed Power [dBm]	Conducted Power [dBm]	Power Drift [dB]	Side	Test Position	Device Serial Number	Duty Cycle	SAR (1g)	Scaling Factor	Scaled SAR (1g)	Plot #
MHz	Ch.										(W/kg)		(W/kg)	
836.60	4183	UMTS 850	RMC	23.0	22.87	-0.06	Right	Cheek	FK-249-B	1:1	0.161	1.030	0.166	
836.60	4183	UMTS 850	RMC	23.0	22.87	0.05	Right	Tilt	FK-249-B	1:1	0.111	1.030	0.114	
836.60	4183	UMTS 850	RMC	23.0	22.87	-0.04	Left	Cheek	FK-249-B	1:1	0.226	1.030	0.233	A2
836.60	4183	UMTS 850	RMC	23.0	22.87	0.02	Left	Tilt	FK-249-B	1:1	0.139	1.030	0.143	
ANSI / IEEE C95.1 1992 - SAFETY LIMIT Spatial Peak Uncontrolled Exposure/General Population							Head 1.6 W/kg (mW/g) averaged over 1 gram							

**Table 10-3  
GSM 1900 Head SAR**

MEASUREMENT RESULTS														
FREQUENCY		Mode/Band	Service	Maximum Allowed Power [dBm]	Conducted Power [dBm]	Power Drift [dB]	Side	Test Position	Device Serial Number	Duty Cycle	SAR (1g)	Scaling Factor	Scaled SAR (1g)	Plot #
MHz	Ch.										(W/kg)		(W/kg)	
1880.00	661	GSM 1900	GSM	29.5	29.47	0.03	Right	Cheek	FK-249-B	1:8.3	0.327	1.007	0.329	
1880.00	661	GSM 1900	GSM	29.5	29.47	0.08	Right	Tilt	FK-249-B	1:8.3	0.155	1.007	0.156	
1880.00	661	GSM 1900	GSM	29.5	29.47	0.00	Left	Cheek	FK-249-B	1:8.3	0.482	1.007	0.485	A3
1880.00	661	GSM 1900	GSM	29.5	29.47	0.05	Left	Tilt	FK-249-B	1:8.3	0.163	1.007	0.164	
ANSI / IEEE C95.1 1992 - SAFETY LIMIT Spatial Peak Uncontrolled Exposure/General Population							Head 1.6 W/kg (mW/g) averaged over 1 gram							

FCC ID: A3LGT56792L		SAR EVALUATION REPORT		Reviewed by: Quality Manager
Document S/N: OY1308141619-R1.A3L	Test Dates: 08/19/13 - 08/21/13	DUT Type: Portable Handset		Page 23 of 34

**Table 10-4  
UMTS 1900 Head SAR**

MEASUREMENT RESULTS														
FREQUENCY		Mode/Band	Service	Maximum Allowed Power [dBm]	Conducted Power [dBm]	Power Drift [dB]	Side	Test Position	Device Serial Number	Duty Cycle	SAR (1g)	Scaling Factor	Scaled SAR (1g)	Plot #
MHz	Ch.										(W/kg)		(W/kg)	
1880.00	9400	UMTS 1900	RMC	23.0	22.98	0.12	Right	Cheek	FK-249-B	1:1	0.488	1.005	0.490	
1880.00	9400	UMTS 1900	RMC	23.0	22.98	-0.02	Right	Tilt	FK-249-B	1:1	0.218	1.005	0.219	
1880.00	9400	UMTS 1900	RMC	23.0	22.98	0.01	Left	Cheek	FK-249-B	1:1	0.776	1.005	0.780	A4
1880.00	9400	UMTS 1900	RMC	23.0	22.98	-0.01	Left	Tilt	FK-249-B	1:1	0.246	1.005	0.247	
ANSI / IEEE C95.1 1992 - SAFETY LIMIT Spatial Peak Uncontrolled Exposure/General Population									Head 1.6 W/kg (mW/g) averaged over 1 gram					

**Table 10-5  
DTS Head SAR**

MEASUREMENT RESULTS															
FREQUENCY		Mode	Service	Maximum Allowed Power [dBm]	Conducted Power [dBm]	Power Drift [dB]	Side	Test Position	Device Serial Number	Data Rate (Mbps)	Duty Cycle	SAR (1g)	Scaling Factor	Scaled SAR (1g)	Plot #
MHz	Ch.											(W/kg)		(W/kg)	
2462	11	IEEE 802.11b	DSSS	16.5	16.24	0.07	Right	Cheek	FK-249-C	1	1:1	0.124	1.062	0.132	A5
2462	11	IEEE 802.11b	DSSS	16.5	16.24	0.18	Right	Tilt	FK-249-C	1	1:1	0.025	1.062	0.027	
2462	11	IEEE 802.11b	DSSS	16.5	16.24	-0.01	Left	Cheek	FK-249-C	1	1:1	0.063	1.062	0.067	
2462	11	IEEE 802.11b	DSSS	16.5	16.24	0.09	Left	Tilt	FK-249-C	1	1:1	0.029	1.062	0.031	
ANSI / IEEE C95.1 1992 - SAFETY LIMIT Spatial Peak Uncontrolled Exposure/General Population									Head 1.6 W/kg (mW/g) averaged over 1 gram						



## 10.2 Standalone Body-Worn SAR Data

**Table 10-6  
GSM/UMTS Body-Worn SAR Data**

MEASUREMENT RESULTS															
FREQUENCY		Mode	Service	Maximum Allowed Power [dBm]	Conducted Power [dBm]	Power Drift [dB]	Spacing	Device Serial Number	# of Time Slots	Duty Cycle	Side	SAR (1g)	Scaling Factor	Scaled SAR (1g)	Plot #
MHz	Ch.											(W/kg)		(W/kg)	
836.60	190	GSM 850	GSM	33.0	32.49	0.03	10 mm	FK-249-B	1	1:8.3	back	0.579	1.125	0.651	A6
836.60	4183	UMTS 850	RMC	23.0	22.87	-0.03	10 mm	FK-249-B	N/A	1:1	back	0.525	1.030	0.541	A8
1880.00	661	GSM 1900	GSM	29.5	29.47	-0.05	10 mm	FK-249-B	1	1:8.3	back	0.485	1.007	0.488	A9
1880.00	9400	UMTS 1900	RMC	23.0	22.98	-0.10	10 mm	FK-249-C	N/A	1:1	back	0.521	1.005	0.524	A11
ANSI / IEEE C95.1 1992 - SAFETY LIMIT Spatial Peak Uncontrolled Exposure/General Population									Body 1.6 W/kg (mW/g) averaged over 1 gram						

**Table 10-7  
DTS Body-Worn SAR**

MEASUREMENT RESULTS															
FREQUENCY		Mode	Service	Maximum Allowed Power [dBm]	Conducted Power [dBm]	Power Drift [dB]	Spacing	Device Serial Number	Data Rate (Mbps)	Side	Duty Cycle	SAR (1g)	Scaling Factor	Scaled SAR (1g)	Plot #
MHz	Ch.											(W/kg)		(W/kg)	
2462	11	IEEE 802.11b	DSSS	16.5	16.24	-0.13	10 mm	FK-249-B	1	back	1:1	0.060	1.062	0.064	A12
ANSI / IEEE C95.1 1992 - SAFETY LIMIT Spatial Peak Uncontrolled Exposure/General Population									Body 1.6 W/kg (mW/g) averaged over 1 gram						

FCC ID: A3LGT56792L		<b>SAR EVALUATION REPORT</b>		Reviewed by: Quality Manager
Document S/N: OY1308141619-R1.A3L	Test Dates: 08/19/13 - 08/21/13	DUT Type: Portable Handset		Page 24 of 34

## 10.3 Standalone Wireless Router SAR Data

Table 10-8  
GPRS/UMTS Hotspot SAR Data

MEASUREMENT RESULTS															
FREQUENCY		Mode	Service	Maximum Allowed Power [dBm]	Conducted Power [dBm]	Power Drift [dB]	Spacing	Device Serial Number	# of GPRS Slots	Duty Cycle	Side	SAR (1g)	Scaling Factor	Scaled SAR (1g)	Plot #
MHz	Ch.											(W/kg)		(W/kg)	
836.60	190	GSM 850	GPRS	30.5	30.13	0.00	10 mm	FK-249-B	2	1:4.15	back	0.621	1.089	0.676	
836.60	190	GSM 850	GPRS	27.5	27.12	0.02	10 mm	FK-249-B	4	1:2.076	back	0.648	1.091	0.707	A7
836.60	190	GSM 850	GPRS	27.5	27.12	0.02	10 mm	FK-249-B	4	1:2.076	front	0.444	1.091	0.484	
836.60	190	GSM 850	GPRS	27.5	27.12	0.00	10 mm	FK-249-B	4	1:2.076	bottom	0.151	1.091	0.165	
836.60	190	GSM 850	GPRS	27.5	27.12	0.04	10 mm	FK-249-B	4	1:2.076	left	0.458	1.091	0.500	
836.60	4183	UMTS 850	RMC	23.0	22.87	-0.03	10 mm	FK-249-B	N/A	1:1	back	0.525	1.030	0.541	A8
836.60	4183	UMTS 850	RMC	23.0	22.87	0.03	10 mm	FK-249-B	N/A	1:1	front	0.327	1.030	0.337	
836.60	4183	UMTS 850	RMC	23.0	22.87	0.00	10 mm	FK-249-B	N/A	1:1	bottom	0.089	1.030	0.092	
836.60	4183	UMTS 850	RMC	23.0	22.87	-0.01	10 mm	FK-249-B	N/A	1:1	left	0.293	1.030	0.302	
1909.80	810	GSM 1900	GPRS	24.5	24.41	0.00	10 mm	FK-249-B	4	1:2.076	back	0.575	1.021	0.587	A10
1909.80	810	GSM 1900	GPRS	24.5	24.41	-0.02	10 mm	FK-249-B	4	1:2.076	front	0.478	1.021	0.488	
1909.80	810	GSM 1900	GPRS	24.5	24.41	0.01	10 mm	FK-249-B	4	1:2.076	bottom	0.429	1.021	0.438	
1909.80	810	GSM 1900	GPRS	24.5	24.41	0.01	10 mm	FK-249-B	4	1:2.076	left	0.118	1.021	0.120	
1880.00	9400	UMTS 1900	RMC	23.0	22.98	-0.10	10 mm	FK-249-C	N/A	1:1	back	0.521	1.005	0.524	A11
1880.00	9400	UMTS 1900	RMC	23.0	22.98	-0.08	10 mm	FK-249-C	N/A	1:1	front	0.445	1.005	0.447	
1880.00	9400	UMTS 1900	RMC	23.0	22.98	-0.12	10 mm	FK-249-C	N/A	1:1	bottom	0.512	1.005	0.515	
1880.00	9400	UMTS 1900	RMC	23.0	22.98	0.13	10 mm	FK-249-C	N/A	1:1	left	0.144	1.005	0.145	
ANSI / IEEE C95.1 1992 - SAFETY LIMIT Spatial Peak Uncontrolled Exposure/General Population							Body 1.6 W/kg (mW/g) averaged over 1 gram								



Table 10-9  
WLAN Hotspot SAR

MEASUREMENT RESULTS															
FREQUENCY		Mode	Service	Maximum Allowed Power [dBm]	Conducted Power [dBm]	Power Drift [dB]	Spacing	Device Serial Number	Data Rate (Mbps)	Side	Duty Cycle	SAR (1g)	Scaling Factor	Scaled SAR (1g)	Plot #
MHz	Ch.											(W/kg)		(W/kg)	
2462	11	IEEE 802.11b	DSSS	16.5	16.24	-0.13	10 mm	FK-249-B	1	back	1:1	0.060	1.062	0.064	
2462	11	IEEE 802.11b	DSSS	16.5	16.24	0.06	10 mm	FK-249-B	1	front	1:1	0.062	1.062	0.066	
2462	11	IEEE 802.11b	DSSS	16.5	16.24	0.01	10 mm	FK-249-B	1	bottom	1:1	0.091	1.062	0.097	A13
2462	11	IEEE 802.11b	DSSS	16.5	16.24	0.16	10 mm	FK-249-B	1	right	1:1	0.078	1.062	0.083	
ANSI / IEEE C95.1 1992 - SAFETY LIMIT Spatial Peak Uncontrolled Exposure/General Population							Body 1.6 W/kg (mW/g) averaged over 1 gram								

## 10.4 SAR Test Notes

### General Notes:

1. The test data reported are the worst-case SAR values according to test procedures specified in IEEE 1528-2003, FCC/OET Bulletin 65, Supplement C [June 2001] and FCC KDB Publication 447498 D01v05r01.
2. Batteries are fully charged at the beginning of the SAR measurements. A standard battery was used for all SAR measurements.
3. Liquid tissue depth was at least 15.0 cm for all frequencies.
4. The manufacturer has confirmed that the device(s) tested have the same physical, mechanical and thermal characteristics and are within operational tolerances expected for production units.
5. SAR results were scaled to the maximum allowed power to demonstrate compliance per FCC KDB Publication 447498 D01v05r01.

FCC ID: A3LGTS6792L		SAR EVALUATION REPORT		Reviewed by: Quality Manager
Document S/N: OY1308141619-R1.A3L	Test Dates: 08/19/13 - 08/21/13	DUT Type: Portable Handset		Page 25 of 34

6. Device was tested using a fixed spacing for body-worn accessory testing. A separation distance of 10 mm was considered because the manufacturer has determined that there will be body-worn accessories available in the marketplace for users to support this separation distance.
7. Per FCC KDB Publication 648474 D04v01r01, Body Worn accessory SAR was evaluated without a headset connected to the device. Since the standalone reported SAR was  $\leq 1.2$  W/kg, no additional SAR evaluations using a headset cable were required.
8. Per FCC KDB 865664 D01v01r01, variability SAR tests were not required because the measured SAR results were less than 0.8 W/kg. Please see Section 12 for variability analysis.
9. During SAR Testing for the Wireless Router conditions per FCC KDB Publication 941225 D06v01r01, the actual Portable Hotspot operation (with actual simultaneous transmission of a transmitter with WIFI) was not activated (See Section 5.7 for more details).

**GSM Test Notes:**



1. Body-Worn accessory testing is typically associated with voice operations. Therefore, GSM voice was evaluated for body-worn SAR.
2. Justification for reduced test configurations per KDB Publication 941225 D03v01: The source-based time-averaged output power was evaluated for all multi-slot operations. The multi-slot configuration with the highest frame averaged output power was evaluated for SAR for hotspot SAR.
3. Per FCC KDB Publication 447498 D01v05r01, since the reported (scaled) SAR measured at the middle channel or highest output power channel for each test configuration is  $\leq 0.8$  W/kg testing at the other channels is not required for such test configuration(s). When the maximum output power variation across the required test channels is  $> \frac{1}{2}$  dB, instead of the middle channel, the highest output power channel was used.

**UMTS Notes:**

1. UMTS mode in Body SAR was tested under RMC 12.2 kbps with HSPA Inactive per KDB Publication 941225 D01v02. HSPA SAR was not required since the average output power of the HSPA subtests was not more than 0.25 dB higher than the RMC level and SAR was less than 1.2 W/kg.
2. Per FCC KDB Publication 447498 D01v05r01, since the reported (scaled) SAR measured at the middle channel or highest output power channel for each test configuration is  $\leq 0.8$  W/kg, testing at the other channels is not required for such test configuration(s). Since the maximum output power variation across the required test channels is  $\leq \frac{1}{2}$  dB, middle channel was the default channel used.

**WLAN Notes:**

1. Justification for reduced test configurations for WIFI channels per KDB Publication 248227 D01v01r02 and October 2012 FCC/TCB Meeting Notes for 2.4 GHz WIFI: Highest average RF output power channel for the lowest data rate was selected for SAR evaluation in 802.11b. Other IEEE 802.11 modes (including 802.11g/n) were not investigated since the average output powers over all channels and data rates were not more than 0.25 dB higher than the tested channel in the lowest data rate of IEEE 802.11b mode.
2. WIFI transmission was verified using an uncalibrated spectrum analyzer.
3. Since the maximum extrapolated peak SAR of the zoom scan for the maximum output channel is  $< 1.6$  W/kg and the reported 1g averaged SAR is  $< 0.8$  W/kg, SAR testing on other default channels was not required.

FCC ID: A3LGTS6792L	 <b>SAR EVALUATION REPORT</b> 		Reviewed by: Quality Manager
Document S/N: OY1308141619-R1.A3L	Test Dates: 08/19/13 - 08/21/13	DUT Type: Portable Handset	Page 26 of 34

# 11 FCC MULTI-TX AND ANTENNA SAR CONSIDERATIONS

## 11.1 Introduction

The following procedures adopted from FCC KDB Publication 447498 D01v05r01 are applicable to handsets with built-in unlicensed transmitters such as 802.11b/g/n and Bluetooth devices which may simultaneously transmit with the licensed transmitter.

## 11.2 Simultaneous Transmission Procedures

This device contains transmitters that may operate simultaneously. Therefore simultaneous transmission analysis is required. Per FCC KDB 447498 D01v05r01 IV.C.1.iii, simultaneous transmission SAR test exclusion may be applied when the sum of the 1-g SAR for all the simultaneous transmitting antennas in a specific a physical test configuration is  $\leq 1.6$  W/kg. When standalone SAR is not required to be measured, per FCC KDB 447498 D01v05r01 4.3.2 2), the following equation must be used to estimate the standalone 1-g SAR for simultaneous transmission assessment involving that transmitter.

$$\text{Estimated SAR} = \frac{\sqrt{f(\text{GHz})}}{7.5} * \frac{(\text{Max Power of channel, mW})}{\text{Min. Separation Distance, mm}}$$

**Table 11-1  
Estimated SAR**



Mode	Frequency	Maximum Allowed Power	Separation Distance (Body)	Estimated SAR (Body)
	[MHz]	[dBm]	[mm]	[W/kg]
Bluetooth	2441	10.00	10	<b>0.208</b>

Note: Held-to ear configurations are not applicable to Bluetooth operations and therefore were not considered for simultaneous transmission. Per KDB Publication 447498 D01v05r01, the maximum power of the channel was rounded to the nearest mW before calculation.

## 11.3 Head SAR Simultaneous Transmission Analysis

**Table 11-2  
Simultaneous Transmission Scenario with 2.4 GHz WLAN (Held to Ear)**

Simult Tx	Configuration	GSM 850 SAR (W/kg)	2.4 GHz WLAN SAR (W/kg)	Σ SAR (W/kg)	Simult Tx	Configuration	UMTS 850 SAR (W/kg)	2.4 GHz WLAN SAR (W/kg)	Σ SAR (W/kg)
Head SAR	Right Cheek	0.338	0.132	0.470	Head SAR	Right Cheek	0.166	0.132	0.298
	Right Tilt	0.239	0.027	0.266		Right Tilt	0.114	0.027	0.141
	Left Cheek	0.439	0.067	0.506		Left Cheek	0.233	0.067	0.300
	Left Tilt	0.236	0.031	0.267		Left Tilt	0.143	0.031	0.174
Simult Tx	Configuration	GSM 1900 SAR (W/kg)	2.4 GHz WLAN SAR (W/kg)	Σ SAR (W/kg)	Simult Tx	Configuration	UMTS 1900 SAR (W/kg)	2.4 GHz WLAN SAR (W/kg)	Σ SAR (W/kg)
Head SAR	Right Cheek	0.329	0.132	0.461	Head SAR	Right Cheek	0.490	0.132	0.622
	Right Tilt	0.156	0.027	0.183		Right Tilt	0.219	0.027	0.246
	Left Cheek	0.485	0.067	0.552		Left Cheek	0.780	0.067	0.847
	Left Tilt	0.164	0.031	0.195		Left Tilt	0.247	0.031	0.278

FCC ID: A3LGT56792L		<b>SAR EVALUATION REPORT</b>		Reviewed by: Quality Manager
Document S/N: OY1308141619-R1.A3L	Test Dates: 08/19/13 - 08/21/13	DUT Type: Portable Handset		Page 27 of 34

## 11.4 Body-Worn Simultaneous Transmission Analysis

**Table 11-3**  
Simultaneous Transmission Scenario with 2.4 GHz WLAN (Body-Worn at 10 mm)

Configuration	Mode	2G/3G SAR (W/kg)	2.4 GHz WLAN SAR (W/kg)	Σ SAR (W/kg)
Back Side	GSM 850	0.651	0.064	0.715
Back Side	UMTS 850	0.541	0.064	0.605
Back Side	GSM 1900	0.488	0.064	0.552
Back Side	UMTS 1900	0.524	0.064	0.588

**Table 11-4**  
Simultaneous Transmission Scenario with Bluetooth (Body-Worn at 10 mm)

Configuration	Mode	2G/3G SAR (W/kg)	Bluetooth SAR (W/kg)	Σ SAR (W/kg)
Back Side	GSM 850	0.651	0.208	0.859
Back Side	UMTS 850	0.541	0.208	0.749
Back Side	GSM 1900	0.488	0.208	0.696
Back Side	UMTS 1900	0.524	0.208	0.732

Note: Bluetooth SAR was not required to be measured per FCC KDB 447498. Estimated SAR results were used in the above table to determine simultaneous transmission SAR test exclusion.

## 11.5 Hotspot SAR Simultaneous Transmission Analysis



Per FCC KDB Publication 941225 D06v01r01, the devices edges with antennas more than 2.5 cm from edge are not required to be evaluated for SAR (“-”).

**Table 11-5**  
Simultaneous Transmission Scenario (2.4 GHz Hotspot at 1.0 cm)

Simult Tx	Configuration	GPRS 850 SAR (W/kg)	2.4 GHz WLAN SAR (W/kg)	Σ SAR (W/kg)	Simult Tx	Configuration	UMTS 850 SAR (W/kg)	2.4 GHz WLAN SAR (W/kg)	Σ SAR (W/kg)
Body SAR	Back	0.707	0.064	0.771	Body SAR	Back	0.541	0.064	0.605
	Front	0.484	0.066	0.550		Front	0.337	0.066	0.403
	Top	-	-	0.000		Top	-	-	0.000
	Bottom	0.165	0.097	0.262		Bottom	0.092	0.097	0.189
	Right	-	0.083	0.083		Right	-	0.083	0.083
	Left	0.500	-	0.500		Left	0.302	-	0.302
Simult Tx	Configuration	GPRS 1900 SAR (W/kg)	2.4 GHz WLAN SAR (W/kg)	Σ SAR (W/kg)	Simult Tx	Configuration	UMTS 1900 SAR (W/kg)	2.4 GHz WLAN SAR (W/kg)	Σ SAR (W/kg)
Body SAR	Back	0.587	0.064	0.651	Body SAR	Back	0.524	0.064	0.588
	Front	0.488	0.066	0.554		Front	0.447	0.066	0.513
	Top	-	-	0.000		Top	-	-	0.000
	Bottom	0.438	0.097	0.535		Bottom	0.515	0.097	0.612
	Right	-	0.083	0.083		Right	-	0.083	0.083
	Left	0.120	-	0.120		Left	0.145	-	0.145

## 11.6 Simultaneous Transmission Conclusion

The above numerical summed SAR results for all the worst-case simultaneous transmission conditions were below the SAR limit. Therefore, the above analysis is sufficient to determine that simultaneous transmission cases will not exceed the SAR limit and therefore no measured volumetric simultaneous SAR summation is required per FCC KDB Publication 447498 D01v05r01.

FCC ID: A3LGT6792L		SAR EVALUATION REPORT		Reviewed by: Quality Manager
Document S/N: OY1308141619-R1.A3L	Test Dates: 08/19/13 - 08/21/13	DUT Type: Portable Handset		Page 28 of 34



## 12 SAR MEASUREMENT VARIABILITY

### 12.1 Measurement Variability

Per FCC KDB Publication 865664 D01v01r01, SAR measurement variability is assessed when 1 gram SAR is  $> 0.8$  W/kg. Since all measured 1 gram SAR values are  $< 0.8$  W/kg for this device, SAR measurement variability was not assessed.

### 12.2 Measurement Uncertainty



The measured SAR was  $< 1.5$  W/kg for all frequency bands. Therefore, per KDB Publication 865664 D01v01r01, the extended measurement uncertainty analysis per IEEE 1528-2003 was not required.

FCC ID: A3LGTS6792L	 <b>PCTEST</b> ENGINEERING LABORATORY, INC.	<b>SAR EVALUATION REPORT</b>		<b>Reviewed by:</b> Quality Manager
<b>Document S/N:</b> 0Y1308141619-R1.A3L	<b>Test Dates:</b> 08/19/13 - 08/21/13	<b>DUT Type:</b> Portable Handset		Page 29 of 34

# 13 EQUIPMENT LIST

Manufacturer	Model	Description	Cal Date	Cal Interval	Cal Due	Serial Number
Agilent	E8257D	(250kHz-20GHz) Signal Generator	4/16/2013	Annual	4/16/2014	MY45470194
Agilent	8753E	(30kHz-6GHz) Network Analyzer	4/16/2013	Annual	4/16/2014	JP38020182
Agilent	8594A	(9kHz-2.9GHz) Spectrum Analyzer	N/A	N/A	N/A	3051A00187
Agilent	8648D	(9kHz-4GHz) Signal Generator	4/17/2013	Annual	4/17/2014	3629U00687
Agilent	85070C	Dielectric Probe Kit	2/14/2013	Annual	2/14/2014	MY44300633
Agilent	85047A	S-Parameter Test Set	N/A	N/A	N/A	2904A00579
Amplifier Research	5S1G4	5W, 800MHz-4.2GHz	CBT	N/A	CBT	21910
Anritsu	ML2495A	Power Meter	10/11/2012	Annual	10/11/2013	1039008
Anritsu	ML2496A	Power Meter	11/28/2012	Annual	11/28/2013	1138001
Anritsu	ML2438A	Power Meter	12/4/2012	Annual	12/4/2013	1070030
Anritsu	ML2438A	Power Meter	2/14/2013	Annual	2/14/2014	1190013
Anritsu	MA2411B	Pulse Power Sensor	12/4/2012	Annual	12/4/2013	1207364
Anritsu	MA2411B	Pulse Power Sensor	12/5/2012	Annual	12/5/2013	1126066
Anritsu	MA2411B	Pulse Sensor	9/19/2012	Annual	9/19/2013	1027293
Anritsu	MT8820C	Radio Communication Analyzer	6/28/2013	Annual	6/28/2014	6201240328
Anritsu	MA24106A	USB Power Sensor	12/6/2012	Annual	12/6/2013	1248508
Anritsu	MA24106A	USB Power Sensor	12/7/2012	Annual	12/7/2013	1244524
COMTECH	AR85729-5/5759B	Solid State Amplifier	CB T	N/A	CBT	M3W1A00-1002
Fisher Scientific	15-078J	Long Stem Thermometer	10/30/2012	Biennial	10/30/2014	122626059
Gigatronics	8651A	Universal Power Meter	10/10/2012	Annual	10/10/2013	8650319
MCL	BW-N6W5+	6dB Attenuator	CBT	N/A	CBT	1139
MiniCircuits	VLF-6000+	Low Pass Filter	CBT	N/A	CBT	N/A
MiniCircuits	SLP-2400+	Low Pass Filter	CBT	N/A	CBT	R8979500903
Mini-Circuits	BW-N20W5+	DC to 18 GHz Precision Fixed 20 dB Attenuator	CBT	N/A	CBT	N/A
Mini-Circuits	NLP-1200+	Low Pass Filter DC to 1000 MHz	CBT	N/A	CBT	N/A
Mini-Circuits	NLP-2950+	Low Pass Filter DC to 2700 MHz	CBT	N/A	CBT	N/A
Narda	4014C-6	4 - 8 GHz SMA 6 dB Directional Coupler	CBT	N/A	CBT	N/A
Narda	4772-3	Attenuator (3dB)	CBT	N/A	CBT	9406
Pasternack	PE2208-6	Bidirectional Coupler	CBT	N/A	CBT	N/A
Pasternack	PE2209-10	Bidirectional Coupler	CBT	N/A	CBT	N/A
Rohde & Schwarz	CMU200	Base Station Simulator	5/3/2013	Annual	5/3/2014	836371/0079
Rohde & Schwarz	CMU200	Base Station Simulator	8/9/2013	Annual	8/9/2014	109892
Rohde & Schwarz	SMIQ03B	Signal Generator	4/17/2013	Annual	4/17/2014	DE27259
Seekonk	NC-100	Torque Wrench (8" lb)	11/29/2011	Triennial	11/29/2014	21053
SPEAG	D1900V2	1900 MHz SAR Dipole	2/6/2013	Annual	2/6/2014	5d148
SPEAG	D1900V2	1900 MHz SAR Dipole	5/2/2013	Annual	5/2/2014	5d141
SPEAG	D2450V2	2450 MHz SAR Dipole	1/8/2013	Annual	1/8/2014	797
SPEAG	D2450V2	2450 MHz SAR Dipole	2/11/2013	Annual	2/11/2014	882
SPEAG	D835V2	835 MHz SAR Dipole	8/23/2012	Annual	8/23/2013	4d026
SPEAG	D835V2	835 MHz SAR Dipole	4/25/2013	Annual	4/25/2014	4d119
SPEAG	DAE4	Dasy Data Acquisition Electronics	4/22/2013	Annual	4/22/2014	1364
SPEAG	DAE4	Dasy Data Acquisition Electronics	11/13/2012	Annual	11/13/2013	1333
SPEAG	DAE4	Dasy Data Acquisition Electronics	2/6/2013	Annual	2/6/2014	649
SPEAG	DAE4	Dasy Data Acquisition Electronics	3/8/2013	Annual	3/8/2014	1334
SPEAG	DAE4	Dasy Data Acquisition Electronics	5/13/2013	Annual	5/13/2014	859
SPEAG	DAK-3.5	Dielectric Assessment Kit	12/11/2012	Annual	12/11/2013	1091
SPEAG	DAK-3.5	Dielectric Assessment Kit	5/14/2013	Annual	5/14/2014	1070
SPEAG	ES3DV3	SAR Probe	5/16/2013	Annual	5/16/2014	3263
SPEAG	ES3DV3	SAR Probe	11/15/2012	Annual	11/15/2013	3287
SPEAG	EX3DV4	SAR Probe	2/27/2013	Annual	2/27/2014	3920
SPEAG	ES3DV3	SAR Probe	3/15/2013	Annual	3/15/2014	3209
SPEAG	ES3DV3	SAR Probe	4/29/2013	Annual	4/29/2014	3318
Tektronix	RSA6114A	Real Time Spectrum Analyzer	4/17/2013	Annual	4/17/2014	B010177
VWR	23226-658	Long Stem Thermometer	7/11/2012	Biennial	7/11/2014	122389330
VWR	36934-158	Wall-Mounted Thermometer	9/30/2011	Biennial	9/30/2013	111859332

Note: CBT (Calibrated Before Testing). Prior to testing, the measurement paths containing a cable, amplifier, attenuator, coupler or filter were connected to a calibrated source (i.e. a signal generator) to determine the losses of the measurement path. The power meter offset was then adjusted to compensate for the measurement system losses. This level offset is stored within the power meter before measurements are made. This calibration verification procedure applies to the system verification and output power measurements. The calibrated reading is then taken directly from the power meter after compensation of the losses for all final power measurements.



FCC ID: A3LGT56792L	 <b>PCTEST</b> ENGINEERING LABORATORY, INC.	<b>SAR EVALUATION REPORT</b>		Reviewed by: Quality Manager
Document S/N: OY1308141619-R1.A3L	Test Dates: 08/19/13 - 08/21/13	DUT Type: Portable Handset	Page 30 of 34	

# 14 MEASUREMENT UNCERTAINTIES

Applicable for frequencies up to 3 GHz

a	b	c	d	e= f(d,k)	f	g	h = c x f/e	i = c x g/e	k
Uncertainty Component	IEEE 1528 Sec.	Tol. (± %)	Prob. Dist.	Div.	c <sub>i</sub> 1gm	c <sub>i</sub> 10 gms	1gm u <sub>i</sub> (± %)	10gms u <sub>i</sub> (± %)	v <sub>i</sub>
<b>Measurement System</b>									
Probe Calibration	E.2.1	6.0	N	1	1.0	1.0	6.0	6.0	∞
Axial Isotropy	E.2.2	0.25	N	1	0.7	0.7	0.2	0.2	∞
Hemishperical Isotropy	E.2.2	1.3	N	1	1.0	1.0	1.3	1.3	∞
Boundary Effect	E.2.3	0.4	N	1	1.0	1.0	0.4	0.4	∞
Linearity	E.2.4	0.3	N	1	1.0	1.0	0.3	0.3	∞
System Detection Limits	E.2.5	5.1	N	1	1.0	1.0	5.1	5.1	∞
Readout Electronics	E.2.6	1.0	N	1	1.0	1.0	1.0	1.0	∞
Response Time	E.2.7	0.8	R	1.73	1.0	1.0	0.5	0.5	∞
Integration Time	E.2.8	2.6	R	1.73	1.0	1.0	1.5	1.5	∞
RF Ambient Conditions	E.6.1	3.0	R	1.73	1.0	1.0	1.7	1.7	∞
Probe Positioner Mechanical Tolerance	E.6.2	0.4	R	1.73	1.0	1.0	0.2	0.2	∞
Probe Positioning w/ respect to Phantom	E.6.3	2.9	R	1.73	1.0	1.0	1.7	1.7	∞
Extrapolation, Interpolation & Integration algorithms for Max. SAR Evaluation	E.5	1.0	R	1.73	1.0	1.0	0.6	0.6	∞
<b>Test Sample Related</b>									
Test Sample Positioning	E.4.2	6.0	N	1	1.0	1.0	6.0	6.0	287
Device Holder Uncertainty	E.4.1	3.32	R	1.73	1.0	1.0	1.9	1.9	∞
Output Power Variation - SAR drift measurement	6.6.2	5.0	R	1.73	1.0	1.0	2.9	2.9	∞
<b>Phantom &amp; Tissue Parameters</b>									
Phantom Uncertainty (Shape & Thickness tolerances)	E.3.1	4.0	R	1.73	1.0	1.0	2.3	2.3	∞
Liquid Conductivity - deviation from target values	E.3.2	5.0	R	1.73	0.64	0.43	1.8	1.2	∞
Liquid Conductivity - measurement uncertainty	E.3.3	3.8	N	1	0.64	0.43	2.4	1.6	6
Liquid Permittivity - deviation from target values	E.3.2	5.0	R	1.73	0.60	0.49	1.7	1.4	∞
Liquid Permittivity - measurement uncertainty	E.3.3	4.5	N	1	0.60	0.49	2.7	2.2	6
<b>Combined Standard Uncertainty (k=1)</b>				RSS			12.1	11.7	299
<b>Expanded Uncertainty (95% CONFIDENCE LEVEL)</b>				k=2			24.2	23.5	

The above measurement uncertainties are according to IEEE Std. 1528-2003



FCC ID: A3LGT56792L	 <b>SAR EVALUATION REPORT</b> 		Reviewed by: Quality Manager
Document S/N: OY1308141619-R1.A3L	Test Dates: 08/19/13 - 08/21/13	DUT Type: Portable Handset	Page 31 of 34

# 15 CONCLUSION

## 15.1 Measurement Conclusion



The SAR evaluation indicates that the EUT complies with the RF radiation exposure limits of the FCC and Industry Canada, with respect to all parameters subject to this test. These measurements were taken to simulate the RF effects of RF exposure under worst-case conditions. Precise laboratory measures were taken to assure repeatability of the tests. The results and statements relate only to the item(s) tested.

Please note that the absorption and distribution of electromagnetic energy in the body are very complex phenomena that depend on the mass, shape, and size of the body, the orientation of the body with respect to the field vectors, and the electrical properties of both the body and the environment. Other variables that may play a substantial role in possible biological effects are those that characterize the environment (e.g. ambient temperature, air velocity, relative humidity, and body insulation) and those that characterize the individual (e.g. age, gender, activity level, debilitation, or disease). Because various factors may interact with one another to vary the specific biological outcome of an exposure to electromagnetic fields, any protection guide should consider maximal amplification of biological effects as a result of field-body interactions, environmental conditions, and physiological variables. [3]



<b>FCC ID:</b> A3LGTS6792L	 <b>PCTEST</b> ENGINEERING LABORATORY, INC.	<b>SAR EVALUATION REPORT</b>		<b>Reviewed by:</b> Quality Manager
<b>Document S/N:</b> OY1308141619-R1.A3L	<b>Test Dates:</b> 08/19/13 - 08/21/13	<b>DUT Type:</b> Portable Handset		Page 32 of 34

## 16 REFERENCES

- [1] Federal Communications Commission, ET Docket 93-62, Guidelines for Evaluating the Environmental Effects of Radiofrequency Radiation, Aug. 1996.
- [2] ANSI/IEEE C95.1-2005, American National Standard safety levels with respect to human exposure to radio frequency electromagnetic fields, 3kHz to 300GHz, New York: IEEE, 2006.
- [3] ANSI/IEEE C95.1-1992, American National Standard safety levels with respect to human exposure to radio frequency electromagnetic fields, 3kHz to 300GHz, New York: IEEE, Sept. 1992.
- [4] ANSI/IEEE C95.3-2002, IEEE Recommended Practice for the Measurement of Potentially Hazardous Electromagnetic Fields - RF and Microwave, New York: IEEE, December 2002.
- [5] Federal Communications Commission, OET Bulletin 65 (Edition 97-01), Supplement C (Edition 01-01), Evaluating Compliance with FCC Guidelines for Human Exposure to Radiofrequency Electromagnetic Fields, June 2001.
- [6] IEEE Standards Coordinating Committee 34 – IEEE Std. 1528-2003, Recommended Practice for Determining the Peak Spatial-Average Specific Absorption Rate (SAR) in the Human Body Due to Wireless Communications Devices.
- [7] NCRP, National Council on Radiation Protection and Measurements, Biological Effects and Exposure Criteria for RadioFrequency Electromagnetic Fields, NCRP Report No. 86, 1986. Reprinted Feb. 1995.
- [8] T. Schmid, O. Egger, N. Kuster, Automated E-field scanning system for dosimetric assessments, IEEE Transaction on Microwave Theory and Techniques, vol. 44, Jan. 1996, pp. 105-113.
- [9] K. Pokovic, T. Schmid, N. Kuster, Robust setup for precise calibration of E-field probes in tissue simulating liquids at mobile communications frequencies, ICECOM97, Oct. 1997, pp. -124.
- [10] K. Pokovic, T. Schmid, and N. Kuster, E-field Probe with improved isotropy in brain simulating liquids, Proceedings of the ELMAR, Zadar, Croatia, June 23-25, 1996, pp. 172-175.
- [11] Schmid & Partner Engineering AG, Application Note: Data Storage and Evaluation, June 1998, p2.
- [12] V. Hombach, K. Meier, M. Burkhardt, E. Kuhn, N. Kuster, The Dependence of EM Energy Absorption upon Human Modeling at 900 MHz, IEEE Transaction on Microwave Theory and Techniques, vol. 44 no. 10, Oct. 1996, pp. 1865-1873.
- [13] N. Kuster and Q. Balzano, Energy absorption mechanism by biological bodies in the near field of dipole antennas above 300MHz, IEEE Transaction on Vehicular Technology, vol. 41, no. 1, Feb. 1992, pp. 17-23.
- [14] G. Hartsgrrove, A. Kraszewski, A. Surowiec, Simulated Biological Materials for Electromagnetic Radiation Absorption Studies, University of Ottawa, Bioelectromagnetics, Canada: 1987, pp. 29-36.
- [15] Q. Balzano, O. Garay, T. Manning Jr., Electromagnetic Energy Exposure of Simulated Users of Portable Cellular Telephones, IEEE Transactions on Vehicular Technology, vol. 44, no.3, Aug. 1995.
- [16] W. Gander, Computermathematik, Birkhaeuser, Basel, 1992.
- [17] W.H. Press, S.A. Teukolsky, W.T. Vetterling, and B.P. Flannery, Numerical Recipes in C, The Art of Scientific Computing, Second edition, Cambridge University Press, 1992.

<b>FCC ID:</b> A3LGTS6792L	 <b>PCTEST</b> ENGINEERING LABORATORY, INC.	<b>SAR EVALUATION REPORT</b>		<b>Reviewed by:</b> Quality Manager
<b>Document S/N:</b> OY1308141619-R1.A3L	<b>Test Dates:</b> 08/19/13 - 08/21/13	<b>DUT Type:</b> Portable Handset	Page 33 of 34	

- [18] Federal Communications Commission, OET Bulletin 65, Evaluating Compliance with FCC Guidelines for Human Exposure to Radiofrequency Electromagnetic Fields. Supplement C, Dec. 1997.
- [19] N. Kuster, R. Kastle, T. Schmid, Dosimetric evaluation of mobile communications equipment with known precision, IEEE Transaction on Communications, vol. E80-B, no. 5, May 1997, pp. 645-652.
- [20] CENELEC CLC/SC111B, European Prestandard (prENV 50166-2), Human Exposure to Electromagnetic Fields High-frequency: 10kHz-300GHz, Jan. 1995.
- [21] Prof. Dr. Niels Kuster, ETH, Eidgenössische Technische Hochschule Zürich, Dosimetric Evaluation of the Cellular Phone.
- [22] IEC 62209-1, Human exposure to radio frequency fields from hand-held and body-mounted wireless communication devices - Human models, instrumentation, and procedures - Part 1: Procedure to determine the specific absorption rate (SAR) for hand-held devices used in close proximity to the ear (frequency range of 300 MHz to 3 GHz), Feb. 2005.
- [23] Industry Canada RSS-102 Radio Frequency Exposure Compliance of Radiocommunication Apparatus (All Frequency Bands) Issue 4, March 2010.
- [24] Health Canada Safety Code 6 Limits of Human Exposure to Radio Frequency Electromagnetic Fields in the Frequency Range from 3 kHz – 300 GHz, 2009
- [25] FCC Public Notice DA-02-1438. Office of Engineering and Technology Announces a Transition Period for the Phantom Requirements of Supplement C to OET Bulletin 65, June 19, 2002
- [26] FCC SAR Test Procedures for 2G-3G Devices, Mobile Hotspot and UMPC Devices KDB Publications 941225, D01-D07
- [27] SAR Measurement procedures for IEEE 802.11a/b/g KDB Publication 248227 D01v01r02
- [28] FCC SAR Considerations for Handsets with Multiple Transmitters and Antennas, KDB Publications 648474 D02-D04
- [29] FCC SAR Evaluation Considerations for Laptop, Notebook, Netbook and Tablet Computers, FCC KDB Publication 616217 D04
- [30] FCC SAR Measurement and Reporting Requirements for 100MHz – 6 GHz, KDB Publications 865664 D01-D02
- [31] FCC General RF Exposure Guidance and SAR Procedures for Dongles, KDB Publication 447498, D01-D02
- [32] Anexo à Resolução No. 533, de 10 de Setembro de 2009.
- [33] IEC 62209-2, Human exposure to radio frequency fields from hand-held and body-mounted wireless communication devices - Human models, instrumentation, and procedures - Part 2: Procedure to determine the specific absorption rate (SAR) for wireless communication devices used in close proximity to the human body (frequency range of 30 MHz to 6 GHz), Mar. 2010.

FCC ID: A3LGT56792L	 <b>SAR EVALUATION REPORT</b> 		Reviewed by: Quality Manager
Document S/N: OY1308141619-R1.A3L	Test Dates: 08/19/13 - 08/21/13	DUT Type: Portable Handset	Page 34 of 34

## APPENDIX A: SAR TEST DATA

# PCTEST ENGINEERING LABORATORY, INC.

**DUT: A3LGTS6792L; Type: Portable Handset; Serial: FK-249-B**

Communication System: GSM; Frequency: 836.6 MHz; Duty Cycle: 1:8.3

Medium: 835 Head Medium parameters used (interpolated):

$f = 836.6 \text{ MHz}$ ;  $\sigma = 0.887 \text{ S/m}$ ;  $\epsilon_r = 40.633$ ;  $\rho = 1000 \text{ kg/m}^3$

Phantom section: Left Section

Test Date: 08-21-2013; Ambient Temp: 22.6°C; Tissue Temp: 22.3°C

Probe: ES3DV3 - SN3318; ConvF(6.33, 6.33, 6.33); Calibrated: 4/29/2013;

Sensor-Surface: 4mm (Mechanical Surface Detection)

Electronics: DAE4 Sn1364; Calibrated: 4/22/2013

Phantom: SAM; Type: QD000P40CD; Serial: TP:1758

Measurement SW: DASY52, Version 52.8 (7); SEMCAD X Version 14.6.10 (7164)

**Mode: GSM 850, Left Head, Cheek, Mid.ch**

**Area Scan (8x13x1):** Measurement grid: dx=15mm, dy=15mm

**Zoom Scan (5x5x7)/Cube 0:** Measurement grid: dx=8mm, dy=8mm, dz=5mm

Reference Value = 21.137 V/m; Power Drift = 0.05 dB

Peak SAR (extrapolated) = 0.504 W/kg

**SAR(1 g) = 0.390 W/kg**

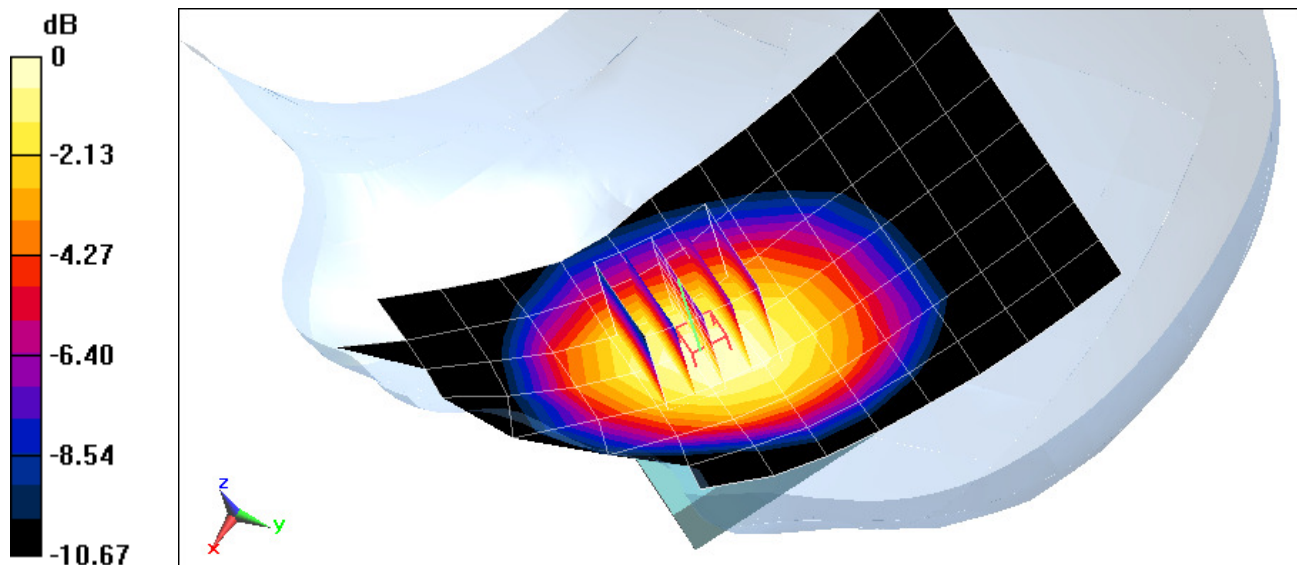

0 dB = 0.411 W/kg = -3.86 dBW/kg

# PCTEST ENGINEERING LABORATORY, INC.

**DUT: A3LGTS6792L; Type: Portable Handset; Serial: FK-249-B**

Communication System: UMTS; Frequency: 836.6 MHz; Duty Cycle: 1:1

Medium: 835 Head Medium parameters used (interpolated):

$f = 836.6 \text{ MHz}$ ;  $\sigma = 0.887 \text{ S/m}$ ;  $\epsilon_r = 40.633$ ;  $\rho = 1000 \text{ kg/m}^3$

Phantom section: Left Section

Test Date: 08-21-2013; Ambient Temp: 22.6°C; Tissue Temp: 22.3°C

Probe: ES3DV3 - SN3318; ConvF(6.33, 6.33, 6.33); Calibrated: 4/29/2013;

Sensor-Surface: 4mm (Mechanical Surface Detection)

Electronics: DAE4 Sn1364; Calibrated: 4/22/2013

Phantom: SAM; Type: QD000P40CD; Serial: TP:1758

Measurement SW: DASY52, Version 52.8 (7); SEMCAD X Version 14.6.10 (7164)

**Mode: UMTS 850, Left Head, Cheek, Mid.ch**

**Area Scan (7x10x1):** Measurement grid: dx=15mm, dy=15mm

**Zoom Scan (5x5x7)/Cube 0:** Measurement grid: dx=8mm, dy=8mm, dz=5mm

Reference Value = 16.534 V/m; Power Drift = -0.04 dB

Peak SAR (extrapolated) = 0.295 W/kg

**SAR(1 g) = 0.226 W/kg**

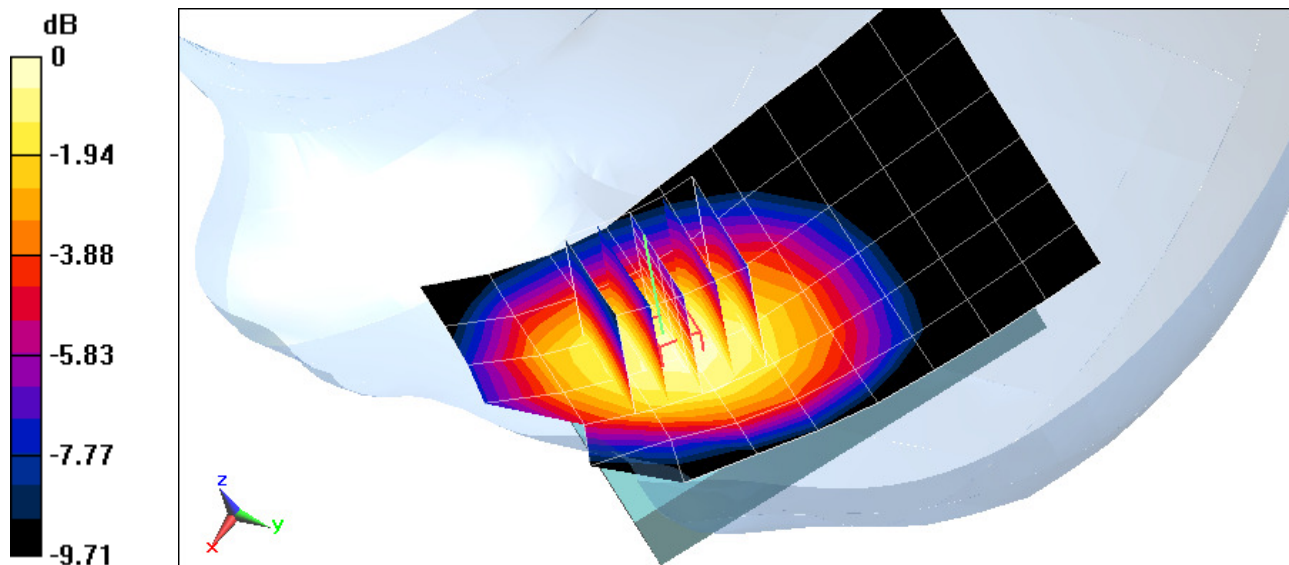

0 dB = 0.235 W/kg = -6.29 dBW/kg

# PCTEST ENGINEERING LABORATORY, INC.

**DUT: A3LGTS6792L; Type: Portable Handset; Serial: FK-249-B**

Communication System: GSM; Frequency: 1880 MHz; Duty Cycle: 1:8.3

Medium: 1900 Head Medium parameters used:

$f = 1880 \text{ MHz}$ ;  $\sigma = 1.396 \text{ S/m}$ ;  $\epsilon_r = 38.428$ ;  $\rho = 1000 \text{ kg/m}^3$

Phantom section: Left Section

Test Date: 08-21-2013; Ambient Temp: 23.4°C; Tissue Temp: 22.6°C

Probe: ES3DV3 - SN3209; ConvF(5.21, 5.21, 5.21); Calibrated: 3/15/2013;

Sensor-Surface: 4mm (Mechanical Surface Detection)

Electronics: DAE4 Sn1334; Calibrated: 3/8/2013

Phantom: SAM Right; Type: QD000P40CD; Serial: 1686

Measurement SW: DASY52, Version 52.8 (7); SEMCAD X Version 14.6.10 (7164)

**Mode: GSM 1900, Left Head, Cheek, Mid.ch**

**Area Scan (7x12x1):** Measurement grid: dx=15mm, dy=15mm

**Zoom Scan (5x5x7)/Cube 0:** Measurement grid: dx=8mm, dy=8mm, dz=5mm

Reference Value = 17.574 V/m; Power Drift = 0.00 dB

Peak SAR (extrapolated) = 0.812 W/kg

**SAR(1 g) = 0.482 W/kg**

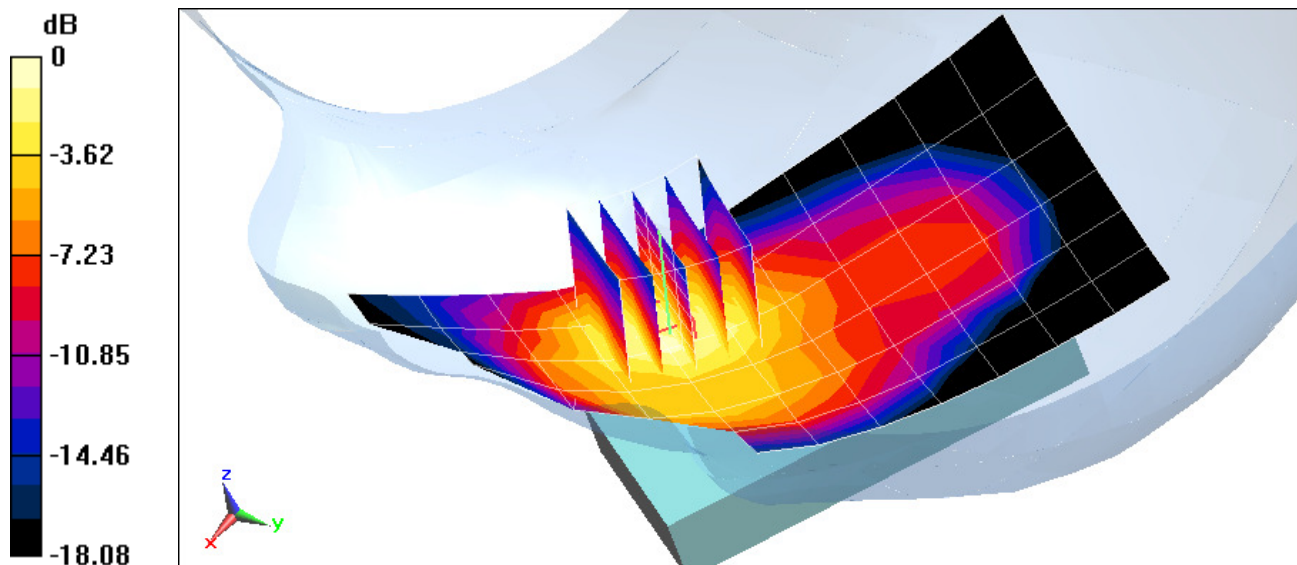

0 dB = 0.545 W/kg = -2.64 dBW/kg

# PCTEST ENGINEERING LABORATORY, INC.

**DUT: A3LGTS6792L; Type: Portable Handset; Serial: FK-249-B**

Communication System: UMTS; Frequency: 1880 MHz; Duty Cycle: 1:1

Medium: 1900 Head Medium parameters used:

$f = 1880 \text{ MHz}$ ;  $\sigma = 1.396 \text{ S/m}$ ;  $\epsilon_r = 38.428$ ;  $\rho = 1000 \text{ kg/m}^3$

Phantom section: Left Section

Test Date: 08-21-2013; Ambient Temp: 23.4°C; Tissue Temp: 22.6°C

Probe: ES3DV3 - SN3209; ConvF(5.21, 5.21, 5.21); Calibrated: 3/15/2013;

Sensor-Surface: 4mm (Mechanical Surface Detection)

Electronics: DAE4 Sn1334; Calibrated: 3/8/2013

Phantom: SAM Right; Type: QD000P40CD; Serial: 1686

Measurement SW: DASY52, Version 52.8 (7); SEMCAD X Version 14.6.10 (7164)

**Mode: UMTS 1900, Left Head, Cheek, Mid.ch**

**Area Scan (7x12x1):** Measurement grid: dx=15mm, dy=15mm

**Zoom Scan (5x5x7)/Cube 0:** Measurement grid: dx=8mm, dy=8mm, dz=5mm

Reference Value = 22.579 V/m; Power Drift = 0.01 dB

Peak SAR (extrapolated) = 1.35 W/kg

**SAR(1 g) = 0.776 W/kg**

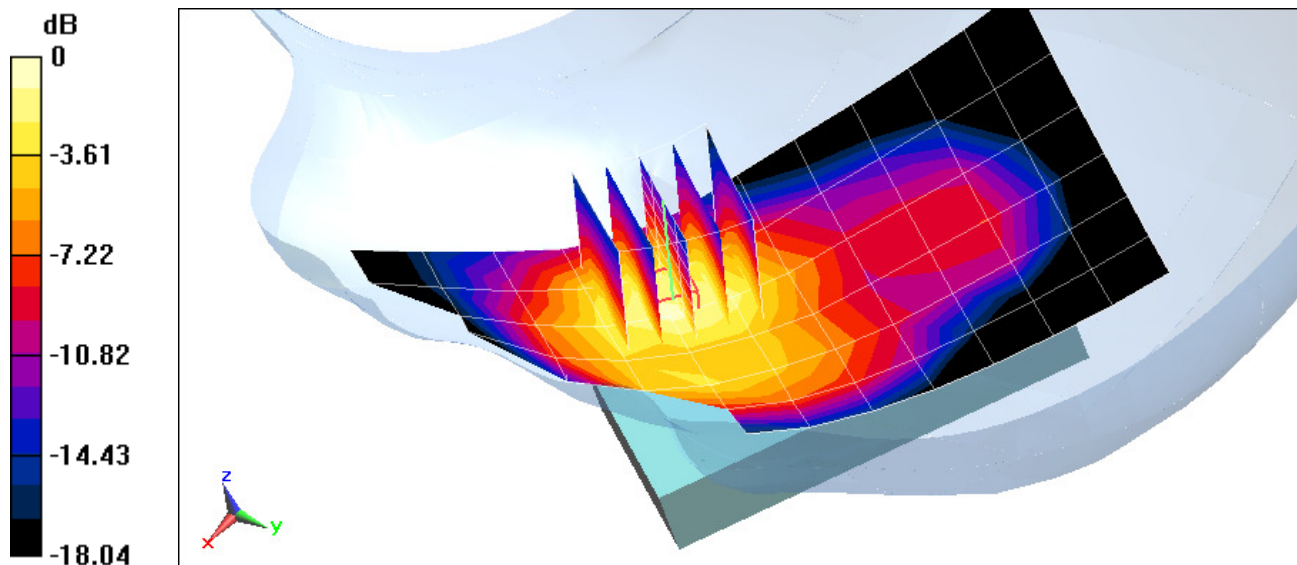

0 dB = 0.881 W/kg = -0.55 dBW/kg

# PCTEST ENGINEERING LABORATORY, INC.

**DUT: A3LGTS6792L; Type: Portable Hotspot; Serial: FK-249-C**

Communication System: IEEE 802.11b; Frequency: 2462 MHz; Duty Cycle: 1:1

Medium: 2450 Head Medium parameters used (interpolated):

$f = 2462 \text{ MHz}$ ;  $\sigma = 1.887 \text{ S/m}$ ;  $\epsilon_r = 38.195$ ;  $\rho = 1000 \text{ kg/m}^3$

Phantom section: Right Section

Test Date: 08-19-2013; Ambient Temp: 23.5°C; Tissue Temp: 23.5°C

Probe: ES3DV3 - SN3263; ConvF(4.47, 4.47, 4.47); Calibrated: 5/16/2013;

Sensor-Surface: 3mm (Mechanical Surface Detection)

Electronics: DAE4 Sn859; Calibrated: 5/13/2013

Phantom: SAM Main; Type: SAM 4.0; Serial: TP-1406

Measurement SW: DASY4, Version 4.7 (80); SEMCAD X Version 14.6.10 (7164)

**Mode: IEEE 802.11b, Right Head, Cheek, Ch 11, 1 Mbps**

**Area Scan (8x17x1):** Measurement grid: dx=12mm, dy=12mm

**Zoom Scan (7x7x7)/Cube 0:** Measurement grid: dx=5mm, dy=5mm, dz=5mm

Reference Value = 7.982 V/m; Power Drift = 0.07 dB

Peak SAR (extrapolated) = 0.240 W/kg

**SAR(1 g) = 0.124 W/kg**

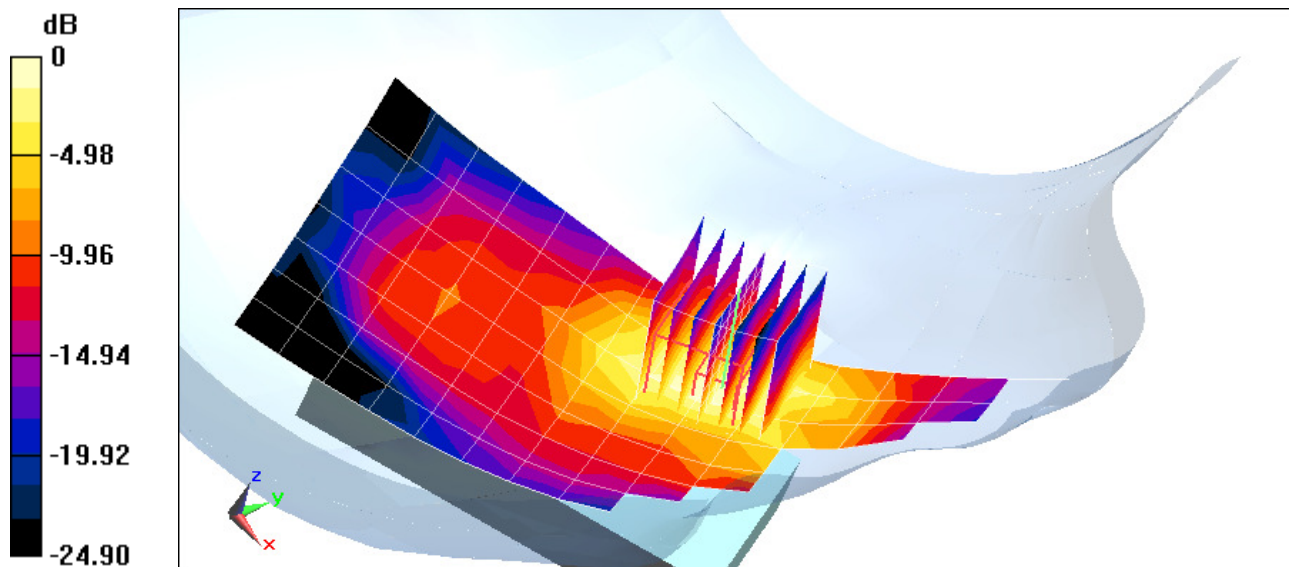

0 dB = 0.160 W/kg = -7.96 dBW/kg

# PCTEST ENGINEERING LABORATORY, INC.

**DUT: A3LGTS6792L; Type: Portable Handset; Serial: FK-249-B**

Communication System: GSM; Frequency: 836.6 MHz; Duty Cycle: 1:8.3

Medium: 835 Body Medium parameters used (interpolated):

$f = 836.6 \text{ MHz}$ ;  $\sigma = 1.016 \text{ S/m}$ ;  $\epsilon_r = 55.073$ ;  $\rho = 1000 \text{ kg/m}^3$

Phantom section: Flat Section; Space: 1.0 cm

Test Date: 08-19-2013; Ambient Temp: 24.1°C; Tissue Temp: 22.8°C

Probe: ES3DV3 - SN3209; ConvF(6.28, 6.28, 6.28); Calibrated: 3/15/2013;

Sensor-Surface: 4mm (Mechanical Surface Detection)

Electronics: DAE4 Sn1334; Calibrated: 3/8/2013

Phantom: ELI v5.0; Type: QDOVA002AA; Serial: TP-1158

Measurement SW: DASY52, Version 52.8 (7); SEMCAD X Version 14.6.10 (7164)

**Mode: GSM 850, Body SAR, Back side, Mid.ch**

**Area Scan (7x10x1):** Measurement grid: dx=15mm, dy=15mm

**Zoom Scan (5x5x7)/Cube 0:** Measurement grid: dx=8mm, dy=8mm, dz=5mm

Reference Value = 24.742 V/m; Power Drift = 0.03 dB

Peak SAR (extrapolated) = 0.792 W/kg

**SAR(1 g) = 0.579 W/kg**

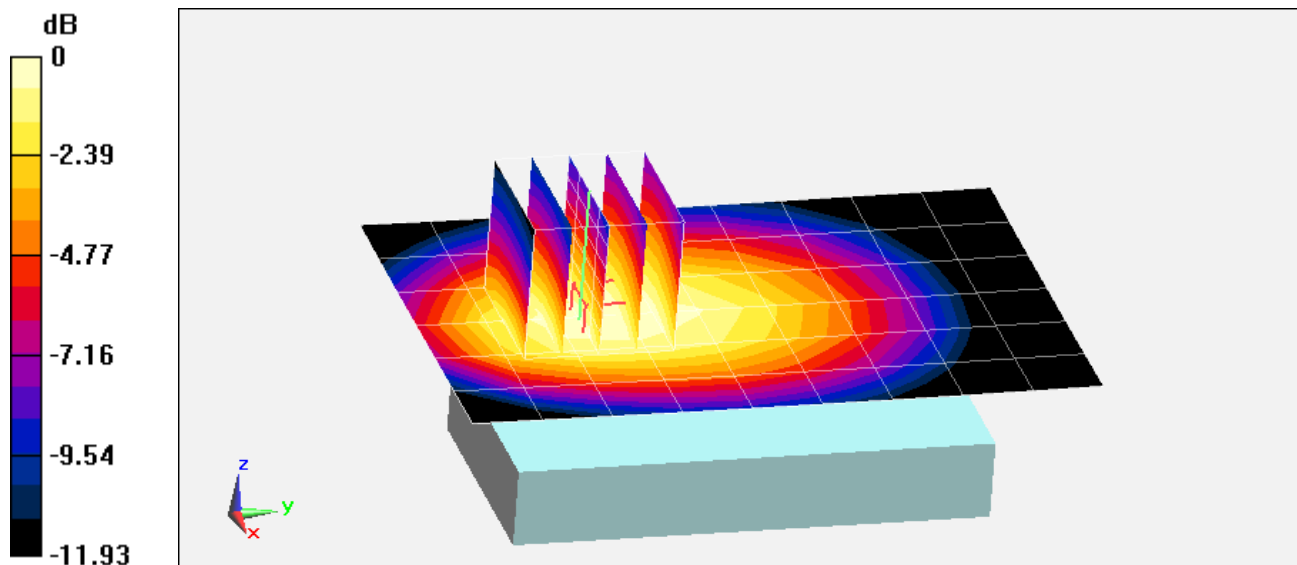

0 dB = 0.612 W/kg = -2.13 dBW/kg

# PCTEST ENGINEERING LABORATORY, INC.

**DUT: A3LGTS6792L; Type: Portable Handset; Serial: Fk-249-B**

Communication System: GSM GPRS; 4 Tx slots; Frequency: 836.6 MHz; Duty Cycle: 1:2.076

Medium: 835 Body Medium parameters used (interpolated):

$f = 836.6 \text{ MHz}$ ;  $\sigma = 1.016 \text{ S/m}$ ;  $\epsilon_r = 55.073$ ;  $\rho = 1000 \text{ kg/m}^3$

Phantom section: Flat Section; Space: 1.0 cm

Test Date: 08-19-2013; Ambient Temp: 24.1°C; Tissue Temp: 22.8°C

Probe: ES3DV3 - SN3209; ConvF(6.28, 6.28, 6.28); Calibrated: 3/15/2013;

Sensor-Surface: 4mm (Mechanical Surface Detection)

Electronics: DAE4 Sn1334; Calibrated: 3/8/2013

Phantom: ELI v5.0; Type: QDOVA002AA; Serial: TP-1158

Measurement SW: DASY52, Version 52.8 (7); SEMCAD X Version 14.6.10 (7164)

**Mode: GPRS 850, Body SAR, Back side, Mid.ch, 4 Tx Slots**

**Area Scan (7x12x1):** Measurement grid: dx=15mm, dy=15mm

**Zoom Scan (5x5x7)/Cube 0:** Measurement grid: dx=8mm, dy=8mm, dz=5mm

Reference Value = 26.243 V/m; Power Drift = 0.02 dB

Peak SAR (extrapolated) = 0.866 W/kg

**SAR(1 g) = 0.648 W/kg**

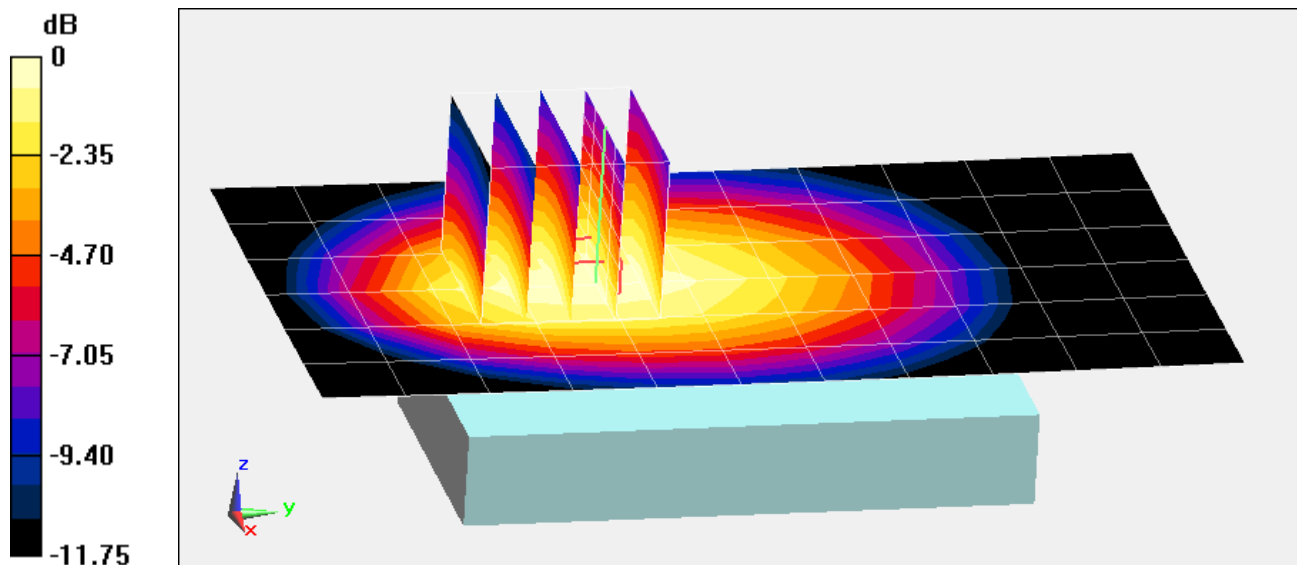

0 dB = 0.686 W/kg = -1.64 dBW/kg

# PCTEST ENGINEERING LABORATORY, INC.

**DUT: A3LGTS6792L; Type: Portable Handset; Serial: FK-249-B**

Communication System: UMTS; Frequency: 836.6 MHz; Duty Cycle: 1:1

Medium: 835 Body Medium parameters used (interpolated):

$f = 836.6 \text{ MHz}$ ;  $\sigma = 1.016 \text{ S/m}$ ;  $\epsilon_r = 55.073$ ;  $\rho = 1000 \text{ kg/m}^3$

Phantom section: Flat Section; Space: 1.0 cm

Test Date: 08-19-2013; Ambient Temp: 24.1°C; Tissue Temp: 22.8°C

Probe: ES3DV3 - SN3209; ConvF(6.28, 6.28, 6.28); Calibrated: 3/15/2013;

Sensor-Surface: 4mm (Mechanical Surface Detection)

Electronics: DAE4 Sn1334; Calibrated: 3/8/2013

Phantom: ELI v5.0; Type: QDOVA002AA; Serial: TP-1158

Measurement SW: DASY52, Version 52.8 (7); SEMCAD X Version 14.6.10 (7164)

**Mode: UMTS 850, Body SAR, Back side, Mid.ch**

**Area Scan (7x12x1):** Measurement grid: dx=15mm, dy=15mm

**Zoom Scan (5x5x7)/Cube 0:** Measurement grid: dx=8mm, dy=8mm, dz=5mm

Reference Value = 23.708 V/m; Power Drift = -0.03 dB

Peak SAR (extrapolated) = 0.723 W/kg

**SAR(1 g) = 0.525 W/kg**

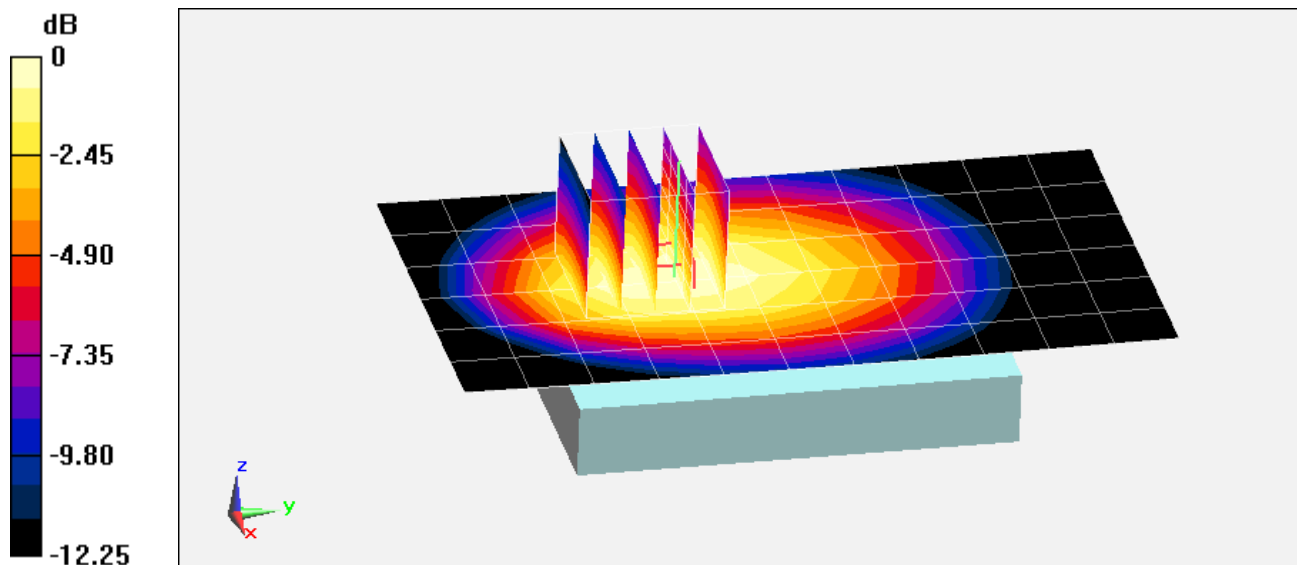

0 dB = 0.554 W/kg = -2.56 dBW/kg

# PCTEST ENGINEERING LABORATORY, INC.

**DUT: A3LGTS6792L; Type: Portable Handset; Serial: FK-249-B**

Communication System: GSM; Frequency: 1880 MHz; Duty Cycle: 1:8.3

Medium: 1900 Body Medium parameters used:

$f = 1880 \text{ MHz}$ ;  $\sigma = 1.531 \text{ S/m}$ ;  $\epsilon_r = 52.073$ ;  $\rho = 1000 \text{ kg/m}^3$

Phantom section: Flat Section; Space: 1.0 cm

Test Date: 08-21-2013; Ambient Temp: 24.1°C; Tissue Temp: 23.0°C

Probe: EX3DV4 - SN3920; ConvF(7.38, 7.38, 7.38); Calibrated: 2/27/2013;

Sensor-Surface: 4mm (Mechanical Surface Detection)

Electronics: DAE4 Sn649; Calibrated: 2/6/2013

Phantom: SAM 5.0 front; Type: QD000P40CD; Serial: TP:-1648

Measurement SW: DASY52, Version 52.8 (7); SEMCAD X Version 14.6.10 (7164)

**Mode: GSM 1900, Body SAR, Back side, Mid.ch**

**Area Scan (7x11x1):** Measurement grid: dx=15mm, dy=15mm

**Zoom Scan (5x5x7)/Cube 0:** Measurement grid: dx=8mm, dy=8mm, dz=5mm

Reference Value = 17.512 V/m; Power Drift = -0.05 dB

Peak SAR (extrapolated) = 0.779 W/kg

**SAR(1 g) = 0.485 W/kg**

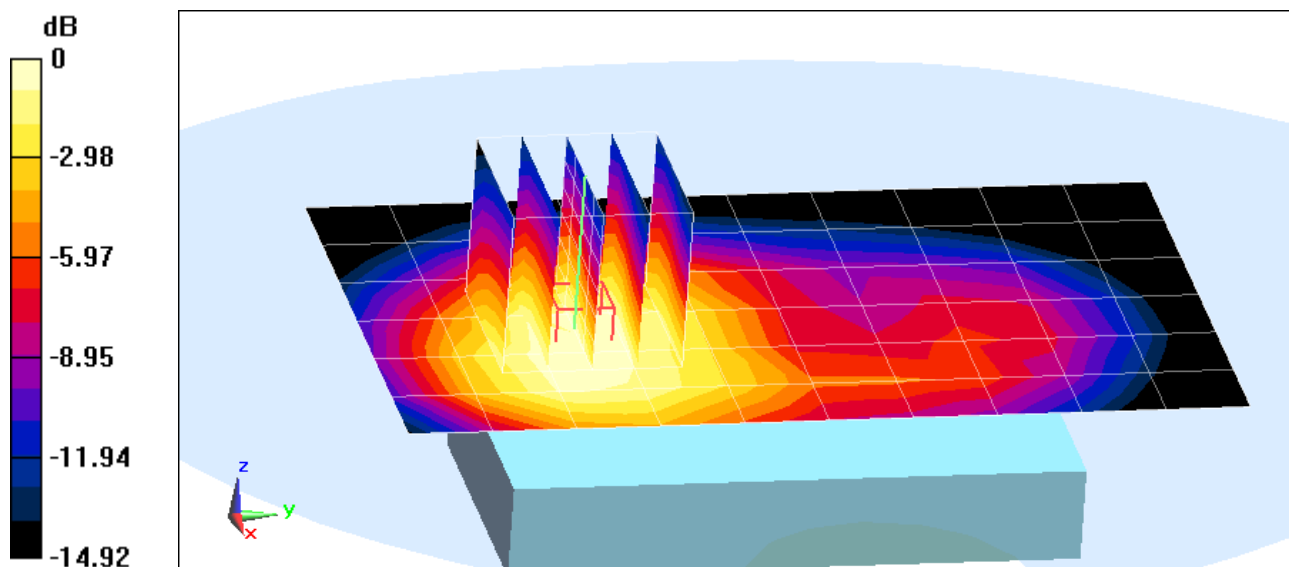

0 dB = 0.528 W/kg = -2.77 dBW/kg

# PCTEST ENGINEERING LABORATORY, INC.

**DUT: A3LGTS6792L; Type: Portable Handset; Serial: FK-249-B**

Communication System: GSM GPRS; 4 Tx slots; Frequency: 1909.8 MHz; Duty Cycle: 1:2.076

.....Medium: 1900 Body Medium parameters used:

..... $f = 1910 \text{ MHz}$ ;  $\sigma = 1.561 \text{ S/m}$ ;  $\epsilon_r = 51.969$ ;  $\rho = 1000 \text{ kg/m}^3$

Rhantom section: Flat Section; Space: 1.0 cm

Test Date: 08-21-2013; Ambient Temp: 24.1°C; Tissue Temp: 23.0°C

Probe: EX3DV4 - SN3920; ConvF(7.38, 7.38, 7.38); Calibrated: 2/27/2013;

Sensor-Surface: 4mm (Mechanical Surface Detection)

Electronics: DAE4 Sn649; Calibrated: 2/6/2013

Phantom: SAM 5.0 front; Type: QD000P40CD; Serial: TP:-1648

Measurement SW: DASY52, Version 52.8 (7); SEMCAD X Version 14.6.10 (7164)

**Mode: GPRS 1900, Body SAR, Back side, High.ch, 4 Tx Slots**

**Area Scan (7x11x1):** Measurement grid: dx=15mm, dy=15mm

**Zoom Scan (5x5x7)/Cube 0:** Measurement grid: dx=8mm, dy=8mm, dz=5mm

Reference Value = 19.142 V/m; Power Drift = 0.00 dB

Peak SAR (extrapolated) = 0.913 W/kg

**SAR(1 g) = 0.575 W/kg**

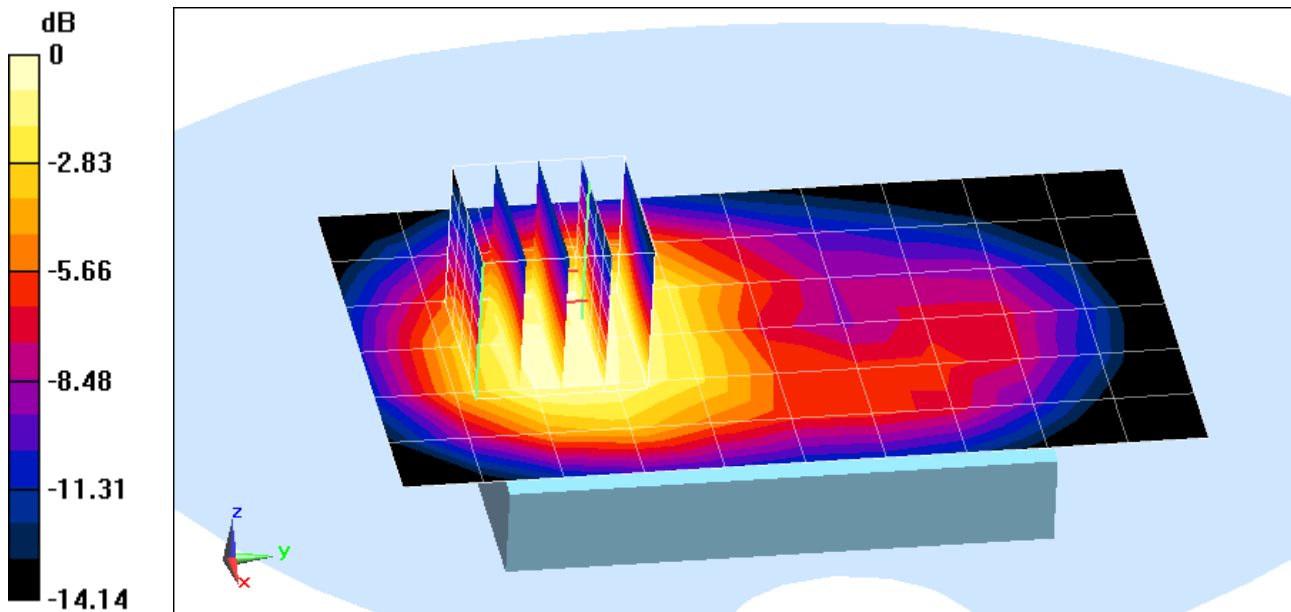

0 dB = 0.623 W/kg = -2.06 dBW/kg

# PCTEST ENGINEERING LABORATORY, INC.

**DUT: A3LGTS6792L; Type: Portable Handset; Serial: FK-249-C**

Communication System: UMTS; Frequency: 1880 MHz; Duty Cycle: 1:1

Medium: 1900 Body Medium parameters used:

$f = 1880 \text{ MHz}$ ;  $\sigma = 1.528 \text{ S/m}$ ;  $\epsilon_r = 54.724$ ;  $\rho = 1000 \text{ kg/m}^3$

Phantom section: Flat Section; Space: 1.0 cm

Test Date: 08-19-2013; Ambient Temp: 23.5°C; Tissue Temp: 22.0°C

Probe: ES3DV3 - SN3287; ConvF(4.69, 4.69, 4.69); Calibrated: 11/15/2012;

Sensor-Surface: 4mm (Mechanical Surface Detection)

Electronics: DAE4 Sn1333; Calibrated: 11/13/2012

Phantom: SAM with CRP; Type: SAM 4.0; Serial: TP1375

Measurement SW: DASY4, Version 4.7 (80); SEMCAD X Version 14.6.10 (7164)

**Mode: UMTS 1900, Body SAR, Back side, Mid.ch**

**Area Scan (7x12x1):** Measurement grid: dx=15mm, dy=15mm

**Zoom Scan (5x5x7)/Cube 0:** Measurement grid: dx=8mm, dy=8mm, dz=5mm

Reference Value = 19.626 V/m; Power Drift = -0.10 dB

Peak SAR (extrapolated) = 0.853 W/kg

**SAR(1 g) = 0.521 W/kg**

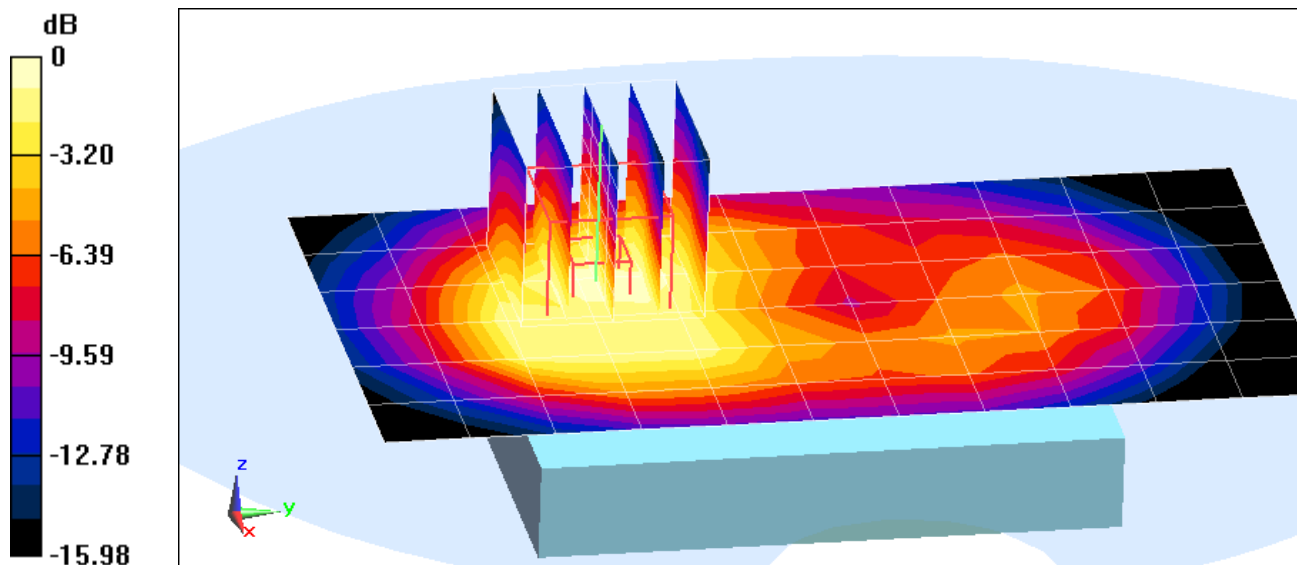

0 dB = 0.570 W/kg = -2.44 dBW/kg

# PCTEST ENGINEERING LABORATORY, INC.

**DUT: A3LGTS6792L; Type: Portable Handset; Serial: FK-249-B**

Communication System: IEEE 802.11b; Frequency: 2462 MHz; Duty Cycle: 1:1

Medium: 2450 Body Medium parameters used (interpolated):

$f = 2462 \text{ MHz}$ ;  $\sigma = 2.05 \text{ S/m}$ ;  $\epsilon_r = 50.666$ ;  $\rho = 1000 \text{ kg/m}^3$

Phantom section: Flat Section; Space: 1.0 cm

Test Date: 08-19-2013; Ambient Temp: 22.8°C; Tissue Temp: 22.1°C

Probe: ES3DV3 - SN3318; ConvF(4.31, 4.31, 4.31); Calibrated: 4/29/2013;

Sensor-Surface: 3mm (Mechanical Surface Detection)

Electronics: DAE4 Sn1364; Calibrated: 4/22/2013

Phantom: ELI left; Type: QDOVA002AA; Serial: TP:1202

Measurement SW: DASY52, Version 52.8 (7); SEMCAD X Version 14.6.10 (7164)

**Mode: IEEE 802.11b, Body SAR, Ch 11, 1 Mbps, Back Side**

**Area Scan (9x14x1):** Measurement grid: dx=12mm, dy=12mm

**Zoom Scan (9x9x7)/Cube 0:** Measurement grid: dx=7mm, dy=7mm, dz=5mm

Reference Value = 3.010 V/m; Power Drift = -0.13 dB

Peak SAR (extrapolated) = 0.121 W/kg

**SAR(1 g) = 0.060 W/kg**

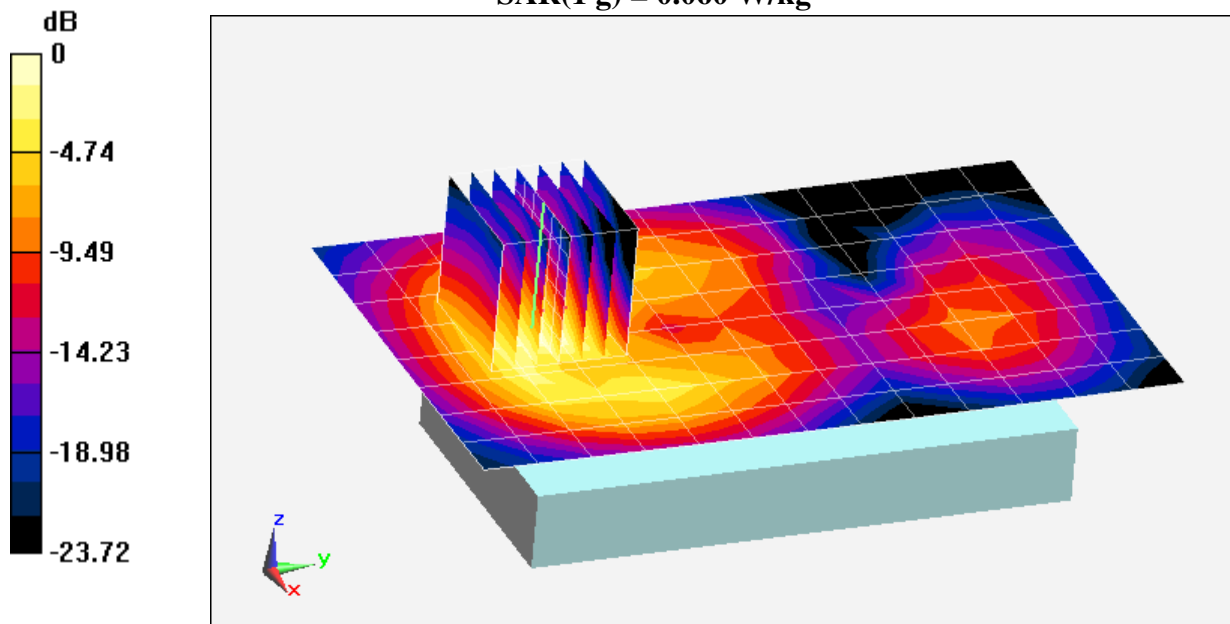

0 dB = 0.0749 W/kg = -11.26 dBW/kg

# PCTEST ENGINEERING LABORATORY, INC.

**DUT: A3LGTS6792L; Type: Portable Handset; Serial: FK-249-B**

Communication System: IEEE 802.11b; Frequency: 2462 MHz; Duty Cycle: 1:1

Medium: 2450 Body Medium parameters used (interpolated):

$f = 2462 \text{ MHz}$ ;  $\sigma = 2.05 \text{ S/m}$ ;  $\epsilon_r = 50.666$ ;  $\rho = 1000 \text{ kg/m}^3$

Phantom section: Flat Section; Space: 1.0 cm

Test Date: 08-19-2013; Ambient Temp: 22.8°C; Tissue Temp: 22.1°C

Probe: ES3DV3 - SN3318; ConvF(4.31, 4.31, 4.31); Calibrated: 4/29/2013;

Sensor-Surface: 3mm (Mechanical Surface Detection)

Electronics: DAE4 Sn1364; Calibrated: 4/22/2013

Phantom: ELI left; Type: QDOVA002AA; Serial: TP:1202

Measurement SW: DASY52, Version 52.8 (7); SEMCAD X Version 14.6.10 (7164)

**Mode: IEEE 802.11b, Body SAR, Ch 11, 1 Mbps, Bottom Edge**

**Area Scan (10x7x1):** Measurement grid: dx=5mm, dy=12mm

**Zoom Scan (7x7x7)/Cube 0:** Measurement grid: dx=5mm, dy=5mm, dz=5mm

Reference Value = 7.128 V/m; Power Drift = 0.01 dB

Peak SAR (extrapolated) = 0.177 W/kg

**SAR(1 g) = 0.091 W/kg**

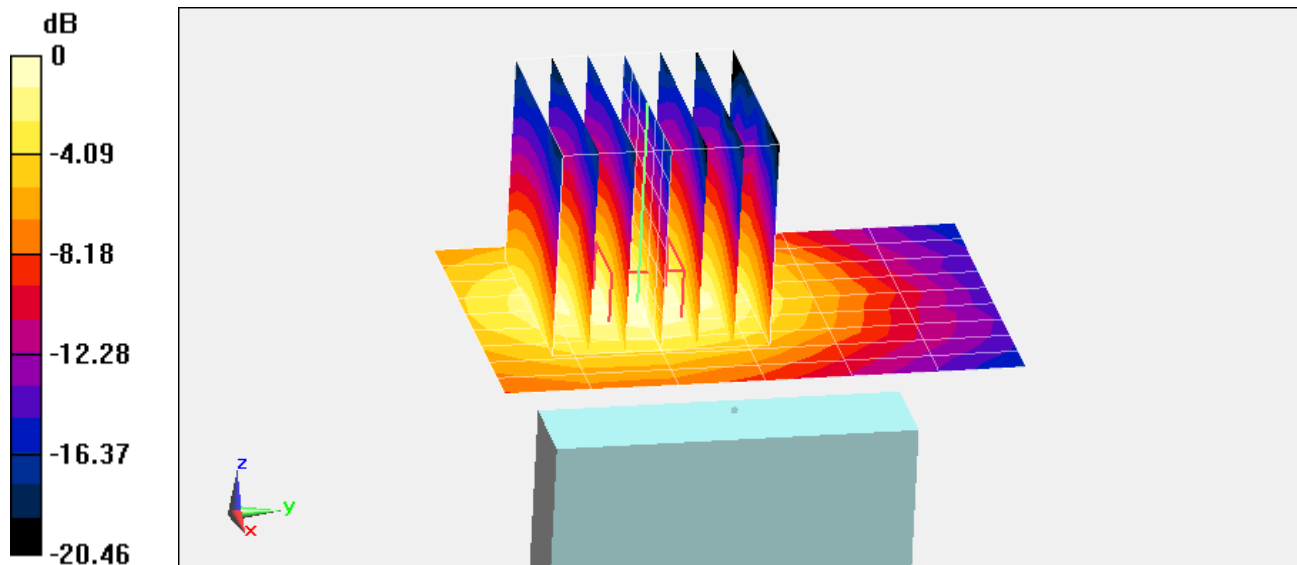

0 dB = 0.116 W/kg = -9.36 dBW/kg

## APPENDIX B: SYSTEM VERIFICATION



Accredited by the Swiss Accreditation Service (SAS)  
The Swiss Accreditation Service is one of the signatories to the EA  
Multilateral Agreement for the recognition of calibration certificates

Accreditation No.: **SCS 108**

Client **PC Test**

Certificate No: **D835V2-4d119\_Apr13**

## CALIBRATION CERTIFICATE

Object **D835V2 - SN: 4d119**

Calibration procedure(s) **QA CAL-05.v9  
Calibration procedure for dipole validation kits above 700 MHz**

Calibration date: **April 25, 2013**

✓  
KOK  
5/8/13

This calibration certificate documents the traceability to national standards, which realize the physical units of measurements (SI).  
The measurements and the uncertainties with confidence probability are given on the following pages and are part of the certificate.

All calibrations have been conducted in the closed laboratory facility: environment temperature ( $22 \pm 3$ )°C and humidity < 70%.

Calibration Equipment used (M&TE critical for calibration)

Primary Standards	ID #	Cal Date (Certificate No.)	Scheduled Calibration
Power meter EPM-442A	GB37480704	01-Nov-12 (No. 217-01640)	Oct-13
Power sensor HP 8481A	US37292783	01-Nov-12 (No. 217-01640)	Oct-13
Reference 20 dB Attenuator	SN: 5058 (20k)	04-Apr-13 (No. 217-01736)	Apr-14
Type-N mismatch combination	SN: 5047.3 / 06327	04-Apr-13 (No. 217-01739)	Apr-14
Reference Probe ES3DV3	SN: 3205	28-Dec-12 (No. ES3-3205_Dec12)	Dec-13
DAE4	SN: 909	11-Sep-12 (No. DAE4-909_Sep12)	Sep-13
Secondary Standards	ID #	Check Date (in house)	Scheduled Check
Power sensor HP 8481A	MY41092317	18-Oct-02 (in house check Oct-11)	In house check: Oct-13
RF generator R&S SMT-06	100005	04-Aug-99 (in house check Oct-11)	In house check: Oct-13
Network Analyzer HP 8753E	US37390585 S4206	18-Oct-01 (in house check Oct-12)	In house check: Oct-13

Calibrated by: **Claudio Leubler**      Name: Claudio Leubler      Function: Laboratory Technician

Approved by: **Katja Pokovic**      Name: Katja Pokovic      Technical Manager

Signature

Issued: April 26, 2013

This calibration certificate shall not be reproduced except in full without written approval of the laboratory.



Accredited by the Swiss Accreditation Service (SAS)  
The Swiss Accreditation Service is one of the signatories to the EA  
Multilateral Agreement for the recognition of calibration certificates

Accreditation No.: **SCS 108**

### Glossary:

TSL	tissue simulating liquid
ConvF	sensitivity in TSL / NORM x,y,z
N/A	not applicable or not measured

### Calibration is Performed According to the Following Standards:

- IEEE Std 1528-2003, "IEEE Recommended Practice for Determining the Peak Spatial-Averaged Specific Absorption Rate (SAR) in the Human Head from Wireless Communications Devices: Measurement Techniques", December 2003
- IEC 62209-1, "Procedure to measure the Specific Absorption Rate (SAR) for hand-held devices used in close proximity to the ear (frequency range of 300 MHz to 3 GHz)", February 2005
- Federal Communications Commission Office of Engineering & Technology (FCC OET), "Evaluating Compliance with FCC Guidelines for Human Exposure to Radiofrequency Electromagnetic Fields; Additional Information for Evaluating Compliance of Mobile and Portable Devices with FCC Limits for Human Exposure to Radiofrequency Emissions", Supplement C (Edition 01-01) to Bulletin 65

### Additional Documentation:

- DASY4/5 System Handbook

### Methods Applied and Interpretation of Parameters:

- Measurement Conditions:** Further details are available from the Validation Report at the end of the certificate. All figures stated in the certificate are valid at the frequency indicated.
- Antenna Parameters with TSL:** The dipole is mounted with the spacer to position its feed point exactly below the center marking of the flat phantom section, with the arms oriented parallel to the body axis.
- Feed Point Impedance and Return Loss:** These parameters are measured with the dipole positioned under the liquid filled phantom. The impedance stated is transformed from the measurement at the SMA connector to the feed point. The Return Loss ensures low reflected power. No uncertainty required.
- Electrical Delay:** One-way delay between the SMA connector and the antenna feed point. No uncertainty required.
- SAR measured:** SAR measured at the stated antenna input power.
- SAR normalized:** SAR as measured, normalized to an input power of 1 W at the antenna connector.
- SAR for nominal TSL parameters:** The measured TSL parameters are used to calculate the nominal SAR result.

The reported uncertainty of measurement is stated as the standard uncertainty of measurement multiplied by the coverage factor  $k=2$ , which for a normal distribution corresponds to a coverage probability of approximately 95%.

## Measurement Conditions

DASY system configuration, as far as not given on page 1.

DASY Version	DASY5	V52.8.6
Extrapolation	Advanced Extrapolation	
Phantom	Modular Flat Phantom	
Distance Dipole Center - TSL	15 mm	with Spacer
Zoom Scan Resolution	dx, dy, dz = 5 mm	
Frequency	835 MHz $\pm$ 1 MHz	

## Head TSL parameters

The following parameters and calculations were applied.

	Temperature	Permittivity	Conductivity
Nominal Head TSL parameters	22.0 °C	41.5	0.90 mho/m
Measured Head TSL parameters	(22.0 $\pm$ 0.2) °C	40.8 $\pm$ 6 %	0.94 mho/m $\pm$ 6 %
Head TSL temperature change during test	< 0.5 °C	----	----

## SAR result with Head TSL

SAR averaged over 1 cm <sup>3</sup> (1 g) of Head TSL	Condition	
SAR measured	250 mW input power	2.51 W/kg
SAR for nominal Head TSL parameters	normalized to 1W	<b>9.68 W/kg <math>\pm</math> 17.0 % (k=2)</b>

SAR averaged over 10 cm <sup>3</sup> (10 g) of Head TSL	condition	
SAR measured	250 mW input power	1.62 W/kg
SAR for nominal Head TSL parameters	normalized to 1W	<b>6.30 W/kg <math>\pm</math> 16.5 % (k=2)</b>

## Body TSL parameters

The following parameters and calculations were applied.

	Temperature	Permittivity	Conductivity
Nominal Body TSL parameters	22.0 °C	55.2	0.97 mho/m
Measured Body TSL parameters	(22.0 $\pm$ 0.2) °C	54.0 $\pm$ 6 %	1.01 mho/m $\pm$ 6 %
Body TSL temperature change during test	< 0.5 °C	----	----

## SAR result with Body TSL

SAR averaged over 1 cm <sup>3</sup> (1 g) of Body TSL	Condition	
SAR measured	250 mW input power	2.47 W/kg
SAR for nominal Body TSL parameters	normalized to 1W	<b>9.54 W/kg <math>\pm</math> 17.0 % (k=2)</b>

SAR averaged over 10 cm <sup>3</sup> (10 g) of Body TSL	condition	
SAR measured	250 mW input power	1.62 W/kg
SAR for nominal Body TSL parameters	normalized to 1W	<b>6.31 W/kg <math>\pm</math> 16.5 % (k=2)</b>

## Appendix

### Antenna Parameters with Head TSL

Impedance, transformed to feed point	50.1 $\Omega$ - 4.7 j $\Omega$
Return Loss	- 26.6 dB

### Antenna Parameters with Body TSL

Impedance, transformed to feed point	45.8 $\Omega$ - 6.3 j $\Omega$
Return Loss	- 22.1 dB

### General Antenna Parameters and Design

Electrical Delay (one direction)	1.385 ns
----------------------------------	----------

After long term use with 100W radiated power, only a slight warming of the dipole near the feedpoint can be measured.

The dipole is made of standard semirigid coaxial cable. The center conductor of the feeding line is directly connected to the second arm of the dipole. The antenna is therefore short-circuited for DC-signals. On some of the dipoles, small end caps are added to the dipole arms in order to improve matching when loaded according to the position as explained in the "Measurement Conditions" paragraph. The SAR data are not affected by this change. The overall dipole length is still according to the Standard.

No excessive force must be applied to the dipole arms, because they might bend or the soldered connections near the feedpoint may be damaged.

### Additional EUT Data

Manufactured by	SPEAG
Manufactured on	June 29, 2010

## DASY5 Validation Report for Head TSL

Date: 25.04.2013

Test Laboratory: SPEAG, Zurich, Switzerland

**DUT: Dipole 835 MHz; Type: D835V2; Serial: D835V2 - SN: 4d119**

Communication System: UID 0 - CW; Frequency: 835 MHz

Medium parameters used:  $f = 835$  MHz;  $\sigma = 0.94$  S/m;  $\epsilon_r = 40.8$ ;  $\rho = 1000$  kg/m<sup>3</sup>

Phantom section: Flat Section

Measurement Standard: DASY5 (IEEE/IEC/ANSI C63.19-2007)

DASY52 Configuration:

- Probe: ES3DV3 - SN3205; ConvF(6.05, 6.05, 6.05); Calibrated: 28.12.2012;
- Sensor-Surface: 3mm (Mechanical Surface Detection)
- Electronics: DAE4 Sn909; Calibrated: 11.09.2012
- Phantom: Flat Phantom 4.9L; Type: QD000P49AA; Serial: 1001
- DASY52 52.8.6(1115); SEMCAD X 14.6.9(7117)

**Dipole Calibration for Head Tissue/Pin=250 mW, d=15mm/Zoom Scan (7x7x7)/Cube 0:**

Measurement grid: dx=5mm, dy=5mm, dz=5mm

Reference Value = 57.387 V/m; Power Drift = 0.03 dB

Peak SAR (extrapolated) = 3.86 W/kg

**SAR(1 g) = 2.51 W/kg; SAR(10 g) = 1.62 W/kg**

Maximum value of SAR (measured) = 2.93 W/kg

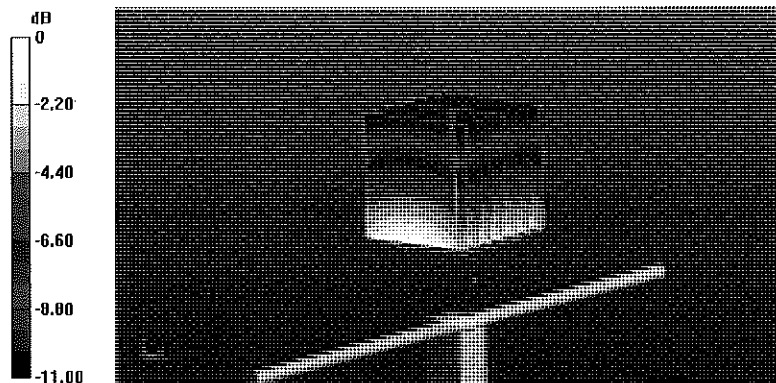

0 dB = 2.93 W/kg = 4.67 dBW/kg

# Impedance Measurement Plot for Head TSL

25 Apr 2013 09:11:06

CH1 S11 1 U FS

1: 50.061  $\Omega$  -4.6621  $\Omega$  40.884 pF

835.000 000 MHz

\*  
Del

CA

Avg  
16

H1 d

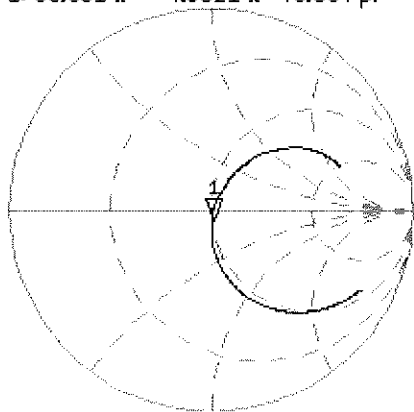

CH2 S11 LOG 5 dB/REF -20 dB 1: -26.641 dB 835.000 000 MHz

CA

Avg  
16

H1 d

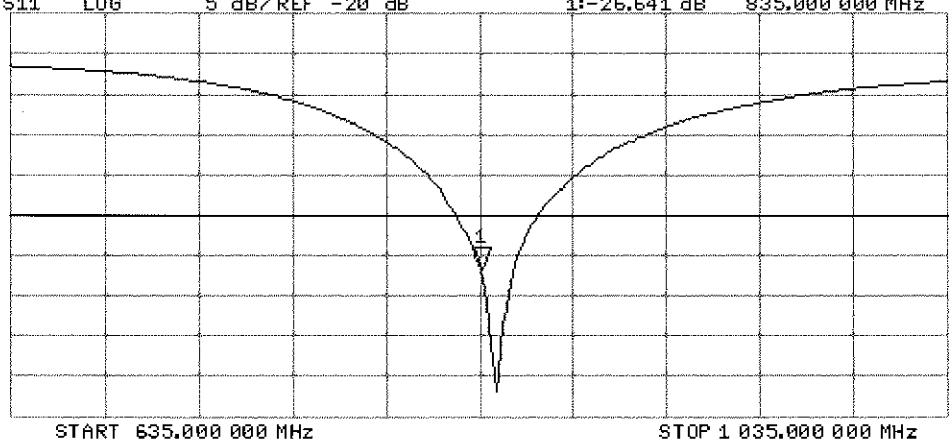

## DASY5 Validation Report for Body TSL

Date: 24.04.2013

Test Laboratory: SPEAG, Zurich, Switzerland

**DUT: Dipole 835 MHz; Type: D835V2; Serial: D835V2 - SN: 4d119**

Communication System: UID 0 - CW; Frequency: 835 MHz

Medium parameters used:  $f = 835$  MHz;  $\sigma = 1.01$  S/m;  $\epsilon_r = 54$ ;  $\rho = 1000$  kg/m<sup>3</sup>

Phantom section: Flat Section

Measurement Standard: DASY5 (IEEE/IEC/ANSI C63.19-2007)

DASY52 Configuration:

- Probe: ES3DV3 - SN3205; ConvF(6.04, 6.04, 6.04); Calibrated: 28.12.2012;
- Sensor-Surface: 3mm (Mechanical Surface Detection)
- Electronics: DAE4 Sn909; Calibrated: 11.09.2012
- Phantom: Flat Phantom 4.9L; Type: QD000P49AA; Serial: 1001
- DASY52 52.8.6(1115); SEMCAD X 14.6.9(7117)

### **Dipole Calibration for Body Tissue/Pin=250 mW, d=15mm/Zoom Scan (7x7x7)/Cube 0:**

Measurement grid: dx=5mm, dy=5mm, dz=5mm

Reference Value = 55.178 V/m; Power Drift = 0.03 dB

Peak SAR (extrapolated) = 3.68 W/kg

**SAR(1 g) = 2.47 W/kg; SAR(10 g) = 1.62 W/kg**

Maximum value of SAR (measured) = 2.89 W/kg

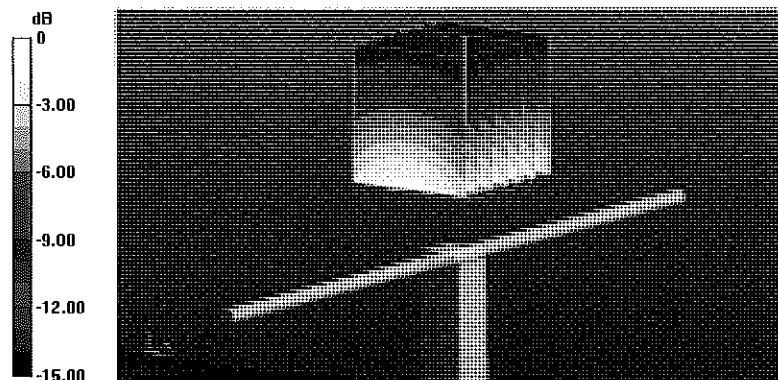

0 dB = 2.89 W/kg = 4.61 dBW/kg

# Impedance Measurement Plot for Body TSL

24 Apr 2013 11:33:44

CH1 S11 1 U FS

2: 45.773  $\Omega$  -6.2773  $\Delta$  30.364 pF

835.000 000 MHz

\*  
DeI  
CA

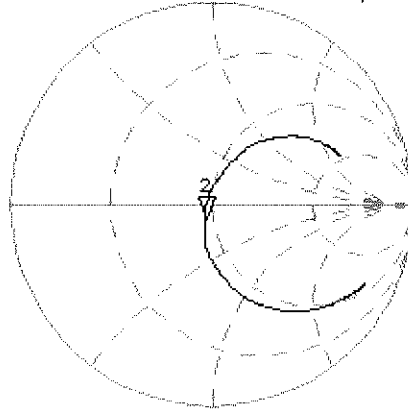

Avg  
16

H1d

CH2 S11 LOG

5 dB/REF -20 dB

2: -22.065 dB

835.000 000 MHz

CA

Avg  
16

H1d

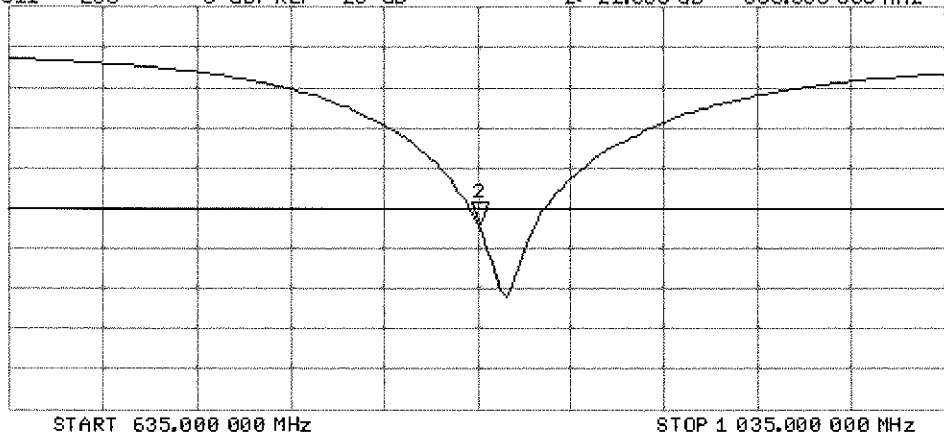



Accredited by the Swiss Accreditation Service (SAS)  
The Swiss Accreditation Service is one of the signatories to the EA  
Multilateral Agreement for the recognition of calibration certificates

Accreditation No.: **SCS 108**

Client **PC Test**

Certificate No: **D1900V2-5d148\_Feb13**

## CALIBRATION CERTIFICATE

Object **D1900V2 - SN: 5d148**

Calibration procedure(s) **QA CAL-05.v9  
Calibration procedure for dipole validation kits above 700 MHz**

Calibration date: **February 06, 2013**

*KOK  
2/21/13*

This calibration certificate documents the traceability to national standards, which realize the physical units of measurements (SI).  
The measurements and the uncertainties with confidence probability are given on the following pages and are part of the certificate.

All calibrations have been conducted in the closed laboratory facility: environment temperature ( $22 \pm 3$ )°C and humidity < 70%.

Calibration Equipment used (M&TE critical for calibration)

Primary Standards	ID #	Cal Date (Certificate No.)	Scheduled Calibration
Power meter EPM-442A	GB37480704	01-Nov-12 (No. 217-01640)	Oct-13
Power sensor HP 8481A	US37292783	01-Nov-12 (No. 217-01640)	Oct-13
Reference 20 dB Attenuator	SN: 5058 (20k)	27-Mar-12 (No. 217-01530)	Apr-13
Type-N mismatch combination	SN: 5047.3 / 06327	27-Mar-12 (No. 217-01533)	Apr-13
Reference Probe ES3DV3	SN: 3205	28-Dec-12 (No. ES3-3205_Dec12)	Dec-13
DAE4	SN: 601	27-Jun-12 (No. DAE4-601_Jun12)	Jun-13
Secondary Standards	ID #	Check Date (in house)	Scheduled Check
Power sensor HP 8481A	MY41092317	18-Oct-02 (in house check Oct-11)	In house check: Oct-13
RF generator R&S SMT-06	100005	04-Aug-99 (in house check Oct-11)	In house check: Oct-13
Network Analyzer HP 8753E	US37390585 S4206	18-Oct-01 (in house check Oct-12)	In house check: Oct-13

Calibrated by: **Leif Klysner**      Name: **Leif Klysner**      Function: **Laboratory Technician**      Signature: *Leif Klysner*

Approved by: **Katja Pokovic**      Name: **Katja Pokovic**      Function: **Technical Manager**      Signature: *Katja Pokovic*

Issued: February 6, 2013

This calibration certificate shall not be reproduced except in full without written approval of the laboratory.



Accredited by the Swiss Accreditation Service (SAS)

The Swiss Accreditation Service is one of the signatories to the EA Multilateral Agreement for the recognition of calibration certificates

Accreditation No.: **SCS 108**

### Glossary:

TSL	tissue simulating liquid
ConvF	sensitivity in TSL / NORM x,y,z
N/A	not applicable or not measured

### Calibration is Performed According to the Following Standards:

- IEEE Std 1528-2003, "IEEE Recommended Practice for Determining the Peak Spatial-Averaged Specific Absorption Rate (SAR) in the Human Head from Wireless Communications Devices: Measurement Techniques", December 2003
- IEC 62209-1, "Procedure to measure the Specific Absorption Rate (SAR) for hand-held devices used in close proximity to the ear (frequency range of 300 MHz to 3 GHz)", February 2005
- Federal Communications Commission Office of Engineering & Technology (FCC OET), "Evaluating Compliance with FCC Guidelines for Human Exposure to Radiofrequency Electromagnetic Fields; Additional Information for Evaluating Compliance of Mobile and Portable Devices with FCC Limits for Human Exposure to Radiofrequency Emissions", Supplement C (Edition 01-01) to Bulletin 65

### Additional Documentation:

- DASY4/5 System Handbook

### Methods Applied and Interpretation of Parameters:

- Measurement Conditions:* Further details are available from the Validation Report at the end of the certificate. All figures stated in the certificate are valid at the frequency indicated.
- Antenna Parameters with TSL:* The dipole is mounted with the spacer to position its feed point exactly below the center marking of the flat phantom section, with the arms oriented parallel to the body axis.
- Feed Point Impedance and Return Loss:* These parameters are measured with the dipole positioned under the liquid filled phantom. The impedance stated is transformed from the measurement at the SMA connector to the feed point. The Return Loss ensures low reflected power. No uncertainty required.
- Electrical Delay:* One-way delay between the SMA connector and the antenna feed point. No uncertainty required.
- SAR measured:* SAR measured at the stated antenna input power.
- SAR normalized:* SAR as measured, normalized to an input power of 1 W at the antenna connector.
- SAR for nominal TSL parameters:* The measured TSL parameters are used to calculate the nominal SAR result.

The reported uncertainty of measurement is stated as the standard uncertainty of measurement multiplied by the coverage factor  $k=2$ , which for a normal distribution corresponds to a coverage probability of approximately 95%.

## Measurement Conditions

DASY system configuration, as far as not given on page 1.

<b>DASY Version</b>	DASY5	V52.8.5
<b>Extrapolation</b>	Advanced Extrapolation	
<b>Phantom</b>	Modular Flat Phantom	
<b>Distance Dipole Center - TSL</b>	10 mm	with Spacer
<b>Zoom Scan Resolution</b>	dx, dy, dz = 5 mm	
<b>Frequency</b>	1900 MHz $\pm$ 1 MHz	

## Head TSL parameters

The following parameters and calculations were applied.

	Temperature	Permittivity	Conductivity
<b>Nominal Head TSL parameters</b>	22.0 °C	40.0	1.40 mho/m
<b>Measured Head TSL parameters</b>	(22.0 $\pm$ 0.2) °C	39.4 $\pm$ 6 %	1.38 mho/m $\pm$ 6 %
<b>Head TSL temperature change during test</b>	< 0.5 °C	----	----

## SAR result with Head TSL

<b>SAR averaged over 1 cm<sup>3</sup> (1 g) of Head TSL</b>	Condition	
SAR measured	250 mW input power	9.87 W/kg
SAR for nominal Head TSL parameters	normalized to 1W	<b>39.7 W/kg <math>\pm</math> 17.0 % (k=2)</b>

<b>SAR averaged over 10 cm<sup>3</sup> (10 g) of Head TSL</b>	condition	
SAR measured	250 mW input power	5.18 W/kg
SAR for nominal Head TSL parameters	normalized to 1W	<b>20.8 W/kg <math>\pm</math> 16.5 % (k=2)</b>

## Body TSL parameters

The following parameters and calculations were applied.

	Temperature	Permittivity	Conductivity
<b>Nominal Body TSL parameters</b>	22.0 °C	53.3	1.52 mho/m
<b>Measured Body TSL parameters</b>	(22.0 $\pm$ 0.2) °C	51.9 $\pm$ 6 %	1.53 mho/m $\pm$ 6 %
<b>Body TSL temperature change during test</b>	< 0.5 °C	----	----

## SAR result with Body TSL

<b>SAR averaged over 1 cm<sup>3</sup> (1 g) of Body TSL</b>	Condition	
SAR measured	250 mW input power	10.3 W/kg
SAR for nominal Body TSL parameters	normalized to 1W	<b>40.8 W/kg <math>\pm</math> 17.0 % (k=2)</b>

<b>SAR averaged over 10 cm<sup>3</sup> (10 g) of Body TSL</b>	condition	
SAR measured	250 mW input power	5.45 W/kg
SAR for nominal Body TSL parameters	normalized to 1W	<b>21.7 W/kg <math>\pm</math> 16.5 % (k=2)</b>

## Appendix

### Antenna Parameters with Head TSL

Impedance, transformed to feed point	52.1 $\Omega$ + 5.9 j $\Omega$
Return Loss	- 24.3 dB

### Antenna Parameters with Body TSL

Impedance, transformed to feed point	48.3 $\Omega$ + 6.3 j $\Omega$
Return Loss	- 23.6 dB

### General Antenna Parameters and Design

Electrical Delay (one direction)	1.199 ns
----------------------------------	----------

After long term use with 100W radiated power, only a slight warming of the dipole near the feedpoint can be measured.

The dipole is made of standard semirigid coaxial cable. The center conductor of the feeding line is directly connected to the second arm of the dipole. The antenna is therefore short-circuited for DC-signals. On some of the dipoles, small end caps are added to the dipole arms in order to improve matching when loaded according to the position as explained in the "Measurement Conditions" paragraph. The SAR data are not affected by this change. The overall dipole length is still according to the Standard.

No excessive force must be applied to the dipole arms, because they might bend or the soldered connections near the feedpoint may be damaged.

### Additional EUT Data

Manufactured by	SPEAG
Manufactured on	March 11, 2011

## DASY5 Validation Report for Head TSL

Date: 06.02.2013

Test Laboratory: SPEAG, Zurich, Switzerland

**DUT: Dipole 1900 MHz; Type: D1900V2; Serial: D1900V2 - SN: 5d148**

Communication System: CW; Frequency: 1900 MHz

Medium parameters used:  $f = 1900$  MHz;  $\sigma = 1.38$  S/m;  $\epsilon_r = 39.4$ ;  $\rho = 1000$  kg/m<sup>3</sup>

Phantom section: Flat Section

Measurement Standard: DASY5 (IEEE/IEC/ANSI C63.19-2007)

DASY52 Configuration:

- Probe: ES3DV3 - SN3205; ConvF(4.98, 4.98, 4.98); Calibrated: 28.12.2012;
- Sensor-Surface: 3mm (Mechanical Surface Detection)
- Electronics: DAE4 Sn601; Calibrated: 27.06.2012
- Phantom: Flat Phantom 5.0 (front); Type: QD000P50AA; Serial: 1001
- DASY52 52.8.5(1059); SEMCAD X 14.6.8(7028)

### Dipole Calibration for Head Tissue/Pin=250 mW, d=10mm/Zoom Scan (7x7x7)/Cube 0:

Measurement grid: dx=5mm, dy=5mm, dz=5mm

Reference Value = 96.534 V/m; Power Drift = 0.05 dB

Peak SAR (extrapolated) = 17.8 W/kg

**SAR(1 g) = 9.87 W/kg; SAR(10 g) = 5.18 W/kg**

Maximum value of SAR (measured) = 12.1 W/kg

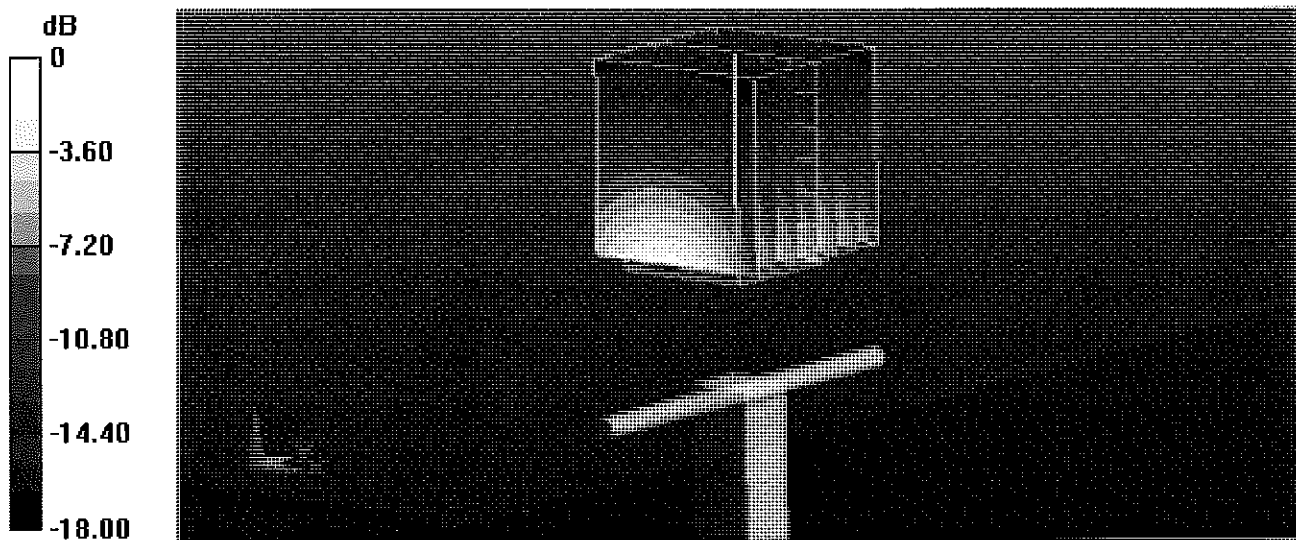

0 dB = 12.1 W/kg = 10.83 dBW/kg

# Impedance Measurement Plot for Head TSL

6 Feb 2013 09:25:10

CH1 S11 1 U FS

1: 52.125  $\Omega$  5.8711  $\Omega$  491.80  $\mu$ H

1 900.000 000 MHz

\*  
Del  
CA  
Avg  
16  
H1d

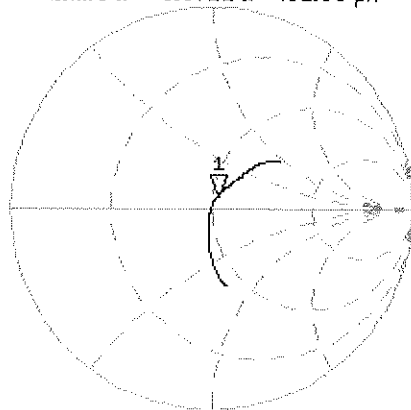

CH2 S11 LOG

5 dB/REF -20 dB

1: -24.287 dB 1 900.000 000 MHz

CA  
Avg  
16  
H1d

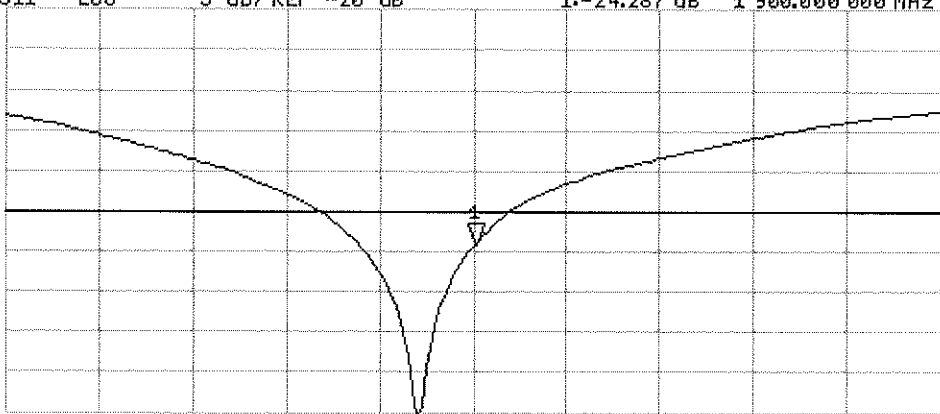

START 1 700.000 000 MHz

STOP 2 100.000 000 MHz

## DASY5 Validation Report for Body TSL

Date: 06.02.2013

Test Laboratory: SPEAG, Zurich, Switzerland

**DUT: Dipole 1900 MHz; Type: D1900V2; Serial: D1900V2 - SN: 5d148**

Communication System: CW; Frequency: 1900 MHz

Medium parameters used:  $f = 1900$  MHz;  $\sigma = 1.53$  S/m;  $\epsilon_r = 51.9$ ;  $\rho = 1000$  kg/m<sup>3</sup>

Phantom section: Flat Section

Measurement Standard: DASY5 (IEEE/IEC/ANSI C63.19-2007)

DASY52 Configuration:

- Probe: ES3DV3 - SN3205; ConvF(4.6, 4.6, 4.6); Calibrated: 28.12.2012;
- Sensor-Surface: 3mm (Mechanical Surface Detection)
- Electronics: DAE4 Sn601; Calibrated: 27.06.2012
- Phantom: Flat Phantom 5.0 (back); Type: QD000P50AA; Serial: 1002
- DASY52 52.8.5(1059); SEMCAD X 14.6.8(7028)

### Dipole Calibration for Body Tissue/Pin=250 mW, d=10mm/Zoom Scan (7x7x7)/Cube 0:

Measurement grid: dx=5mm, dy=5mm, dz=5mm

Reference Value = 96.534 V/m; Power Drift = -0.02 dB

Peak SAR (extrapolated) = 17.9 W/kg

**SAR(1 g) = 10.3 W/kg; SAR(10 g) = 5.45 W/kg**

Maximum value of SAR (measured) = 13.1 W/kg

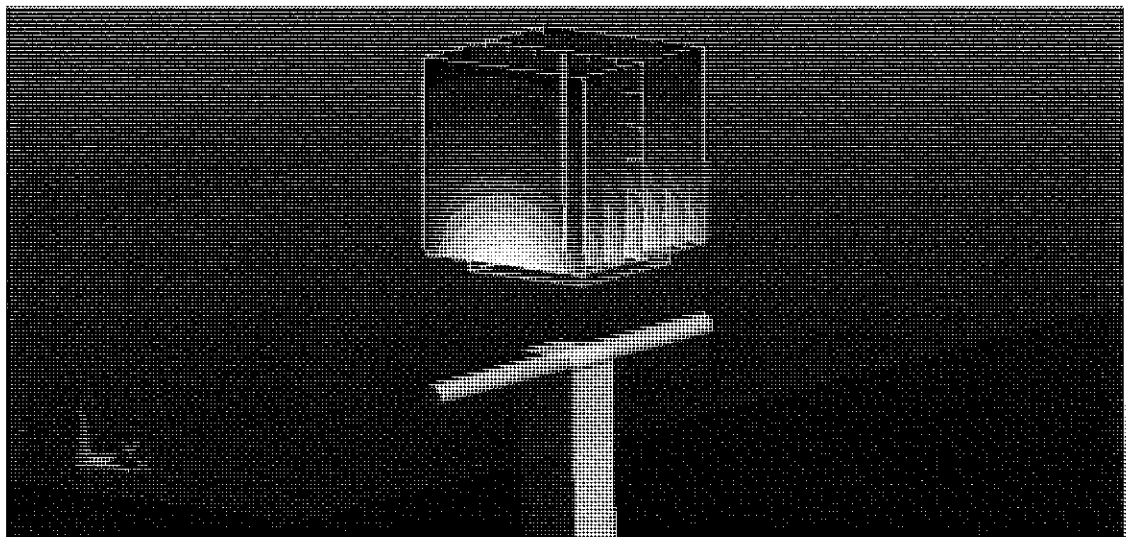
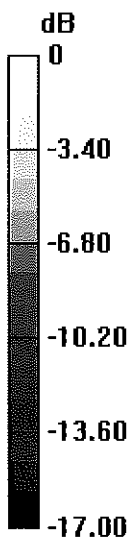

0 dB = 13.1 W/kg = 11.17 dBW/kg

# Impedance Measurement Plot for Body TSL

6 Feb 2013 09:24:17

CH1 S11 1 U FS 1: 48.344  $\Omega$  6.2715  $\Omega$  525.34  $\mu$ H 1 900.000 000 MHz

\*  
De1

CA

Avg  
16

H1d

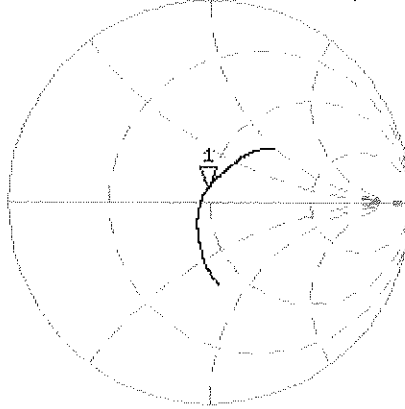

CH2 S11 LOG 5 dB/REF -20 dB 1:-23.628 dB 1 900.000 000 MHz

CA

Avg  
16

H1d

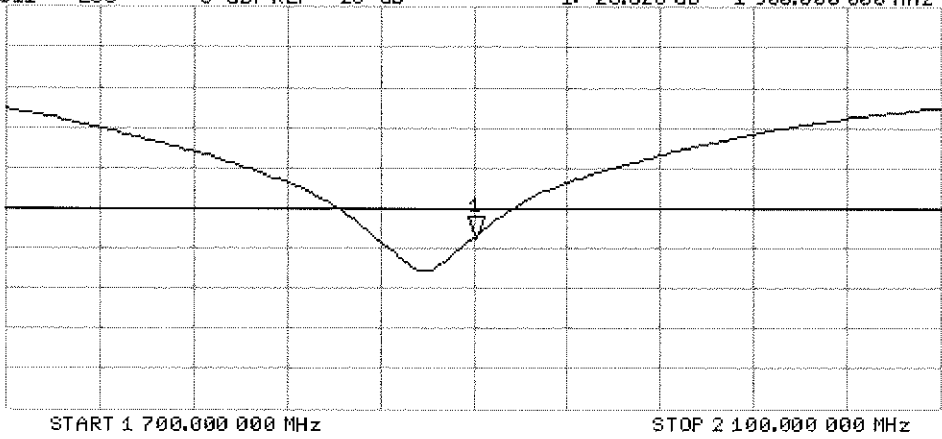



Accredited by the Swiss Accreditation Service (SAS)  
The Swiss Accreditation Service is one of the signatories to the EA  
Multilateral Agreement for the recognition of calibration certificates

Accreditation No.: **SCS 108**

Client **PC Test**

Certificate No: **D2450V2-882\_Feb13**

## CALIBRATION CERTIFICATE

Object **D2450V2 - SN: 882**

Calibration procedure(s) **QA CAL-05.v9  
Calibration procedure for dipole validation kits above 700 MHz**

Calibration date: **February 11, 2013**

*KOK  
2/21/13*

This calibration certificate documents the traceability to national standards, which realize the physical units of measurements (SI).  
The measurements and the uncertainties with confidence probability are given on the following pages and are part of the certificate.

All calibrations have been conducted in the closed laboratory facility: environment temperature ( $22 \pm 3$ )°C and humidity < 70%.

Calibration Equipment used (M&TE critical for calibration)

Primary Standards	ID #	Cal Date (Certificate No.)	Scheduled Calibration
Power meter EPM-442A	GB37480704	01-Nov-12 (No. 217-01640)	Oct-13
Power sensor HP 8481A	US37292783	01-Nov-12 (No. 217-01640)	Oct-13
Reference 20 dB Attenuator	SN: 5058 (20k)	27-Mar-12 (No. 217-01530)	Apr-13
Type-N mismatch combination	SN: 5047.3 / 06327	27-Mar-12 (No. 217-01533)	Apr-13
Reference Probe ES3DV3	SN: 3205	28-Dec-12 (No. ES3-3205_Dec12)	Dec-13
DAE4	SN: 601	27-Jun-12 (No. DAE4-601_Jun12)	Jun-13
Secondary Standards	ID #	Check Date (in house)	Scheduled Check
Power sensor HP 8481A	MY41092317	18-Oct-02 (in house check Oct-11)	In house check: Oct-13
RF generator R&S SMT-06	100005	04-Aug-99 (in house check Oct-11)	In house check: Oct-13
Network Analyzer HP 8753E	US37390585 S4206	18-Oct-01 (in house check Oct-12)	In house check: Oct-13

Calibrated by: **Israe El-Naouq**      Name: **Israe El-Naouq**      Function: **Laboratory Technician**

Approved by: **Katja Pokovic**      Name: **Katja Pokovic**      Technical Manager

Signature  
*Israe El-Naouq*  
*Katja Pokovic*

Issued: February 11, 2013

This calibration certificate shall not be reproduced except in full without written approval of the laboratory.



Accredited by the Swiss Accreditation Service (SAS)  
The Swiss Accreditation Service is one of the signatories to the EA  
Multilateral Agreement for the recognition of calibration certificates

Accreditation No.: **SCS 108**

**Glossary:**

TSL	tissue simulating liquid
ConvF	sensitivity in TSL / NORM x,y,z
N/A	not applicable or not measured

**Calibration is Performed According to the Following Standards:**

- a) IEEE Std 1528-2003, "IEEE Recommended Practice for Determining the Peak Spatial-Averaged Specific Absorption Rate (SAR) in the Human Head from Wireless Communications Devices: Measurement Techniques", December 2003
- b) IEC 62209-1, "Procedure to measure the Specific Absorption Rate (SAR) for hand-held devices used in close proximity to the ear (frequency range of 300 MHz to 3 GHz)", February 2005
- c) Federal Communications Commission Office of Engineering & Technology (FCC OET), "Evaluating Compliance with FCC Guidelines for Human Exposure to Radiofrequency Electromagnetic Fields; Additional Information for Evaluating Compliance of Mobile and Portable Devices with FCC Limits for Human Exposure to Radiofrequency Emissions", Supplement C (Edition 01-01) to Bulletin 65

**Additional Documentation:**

- d) DASY4/5 System Handbook

**Methods Applied and Interpretation of Parameters:**

- *Measurement Conditions:* Further details are available from the Validation Report at the end of the certificate. All figures stated in the certificate are valid at the frequency indicated.
- *Antenna Parameters with TSL:* The dipole is mounted with the spacer to position its feed point exactly below the center marking of the flat phantom section, with the arms oriented parallel to the body axis.
- *Feed Point Impedance and Return Loss:* These parameters are measured with the dipole positioned under the liquid filled phantom. The impedance stated is transformed from the measurement at the SMA connector to the feed point. The Return Loss ensures low reflected power. No uncertainty required.
- *Electrical Delay:* One-way delay between the SMA connector and the antenna feed point. No uncertainty required.
- *SAR measured:* SAR measured at the stated antenna input power.
- *SAR normalized:* SAR as measured, normalized to an input power of 1 W at the antenna connector.
- *SAR for nominal TSL parameters:* The measured TSL parameters are used to calculate the nominal SAR result.

The reported uncertainty of measurement is stated as the standard uncertainty of measurement multiplied by the coverage factor  $k=2$ , which for a normal distribution corresponds to a coverage probability of approximately 95%.

## Measurement Conditions

DASY system configuration, as far as not given on page 1.

<b>DASY Version</b>	DASY5	V52.8.5
<b>Extrapolation</b>	Advanced Extrapolation	
<b>Phantom</b>	Modular Flat Phantom	
<b>Distance Dipole Center - TSL</b>	10 mm	with Spacer
<b>Zoom Scan Resolution</b>	dx, dy, dz = 5 mm	
<b>Frequency</b>	2450 MHz $\pm$ 1 MHz	

## Head TSL parameters

The following parameters and calculations were applied.

	Temperature	Permittivity	Conductivity
<b>Nominal Head TSL parameters</b>	22.0 °C	39.2	1.80 mho/m
<b>Measured Head TSL parameters</b>	(22.0 $\pm$ 0.2) °C	37.9 $\pm$ 6 %	1.85 mho/m $\pm$ 6 %
<b>Head TSL temperature change during test</b>	< 0.5 °C	----	----

## SAR result with Head TSL

<b>SAR averaged over 1 cm<sup>3</sup> (1 g) of Head TSL</b>	Condition	
SAR measured	250 mW input power	13.2 W/kg
SAR for nominal Head TSL parameters	normalized to 1W	<b>51.7 W/kg <math>\pm</math> 17.0 % (k=2)</b>

<b>SAR averaged over 10 cm<sup>3</sup> (10 g) of Head TSL</b>	condition	
SAR measured	250 mW input power	6.07 W/kg
SAR for nominal Head TSL parameters	normalized to 1W	<b>24.0 W/kg <math>\pm</math> 16.5 % (k=2)</b>

## Body TSL parameters

The following parameters and calculations were applied.

	Temperature	Permittivity	Conductivity
<b>Nominal Body TSL parameters</b>	22.0 °C	52.7	1.95 mho/m
<b>Measured Body TSL parameters</b>	(22.0 $\pm$ 0.2) °C	50.9 $\pm$ 6 %	2.02 mho/m $\pm$ 6 %
<b>Body TSL temperature change during test</b>	< 0.5 °C	----	----

## SAR result with Body TSL

<b>SAR averaged over 1 cm<sup>3</sup> (1 g) of Body TSL</b>	Condition	
SAR measured	250 mW input power	12.8 W/kg
SAR for nominal Body TSL parameters	normalized to 1W	<b>49.9 W/kg <math>\pm</math> 17.0 % (k=2)</b>

<b>SAR averaged over 10 cm<sup>3</sup> (10 g) of Body TSL</b>	condition	
SAR measured	250 mW input power	5.91 W/kg
SAR for nominal Body TSL parameters	normalized to 1W	<b>23.3 W/kg <math>\pm</math> 16.5 % (k=2)</b>

## Appendix

### Antenna Parameters with Head TSL

Impedance, transformed to feed point	53.6 $\Omega$ - 0.4 j $\Omega$
Return Loss	- 29.0 dB

### Antenna Parameters with Body TSL

Impedance, transformed to feed point	49.5 $\Omega$ + 1.2 j $\Omega$
Return Loss	- 37.4 dB

### General Antenna Parameters and Design

Electrical Delay (one direction)	1.157 ns
----------------------------------	----------

After long term use with 100W radiated power, only a slight warming of the dipole near the feedpoint can be measured.

The dipole is made of standard semirigid coaxial cable. The center conductor of the feeding line is directly connected to the second arm of the dipole. The antenna is therefore short-circuited for DC-signals. On some of the dipoles, small end caps are added to the dipole arms in order to improve matching when loaded according to the position as explained in the "Measurement Conditions" paragraph. The SAR data are not affected by this change. The overall dipole length is still according to the Standard.

No excessive force must be applied to the dipole arms, because they might bend or the soldered connections near the feedpoint may be damaged.

### Additional EUT Data

Manufactured by	SPEAG
Manufactured on	October 06, 2011

## DASY5 Validation Report for Head TSL

Date: 11.02.2013

Test Laboratory: SPEAG, Zurich, Switzerland

**DUT: Dipole 2450 MHz; Type: D2450V2; Serial: D2450V2 - SN: 882**

Communication System: CW; Frequency: 2450 MHz

Medium parameters used:  $f = 2450$  MHz;  $\sigma = 1.85$  S/m;  $\epsilon_r = 37.9$ ;  $\rho = 1000$  kg/m<sup>3</sup>

Phantom section: Flat Section

Measurement Standard: DASY5 (IEEE/IEC/ANSI C63.19-2007)

DASY52 Configuration:

- Probe: ES3DV3 - SN3205; ConvF(4.52, 4.52, 4.52); Calibrated: 28.12.2012;
- Sensor-Surface: 3mm (Mechanical Surface Detection)
- Electronics: DAE4 Sn601; Calibrated: 27.06.2012
- Phantom: Flat Phantom 5.0 (front); Type: QD000P50AA; Serial: 1001
- DASY52 52.8.5(1059); SEMCAD X 14.6.8(7028)

### Dipole Calibration for Head Tissue/Pin=250 mW, d=10mm/Zoom Scan (7x7x7)/Cube 0:

Measurement grid: dx=5mm, dy=5mm, dz=5mm

Reference Value = 97.806 V/m; Power Drift = 0.05 dB

Peak SAR (extrapolated) = 27.6 W/kg

**SAR(1 g) = 13.2 W/kg; SAR(10 g) = 6.07 W/kg**

Maximum value of SAR (measured) = 16.7 W/kg

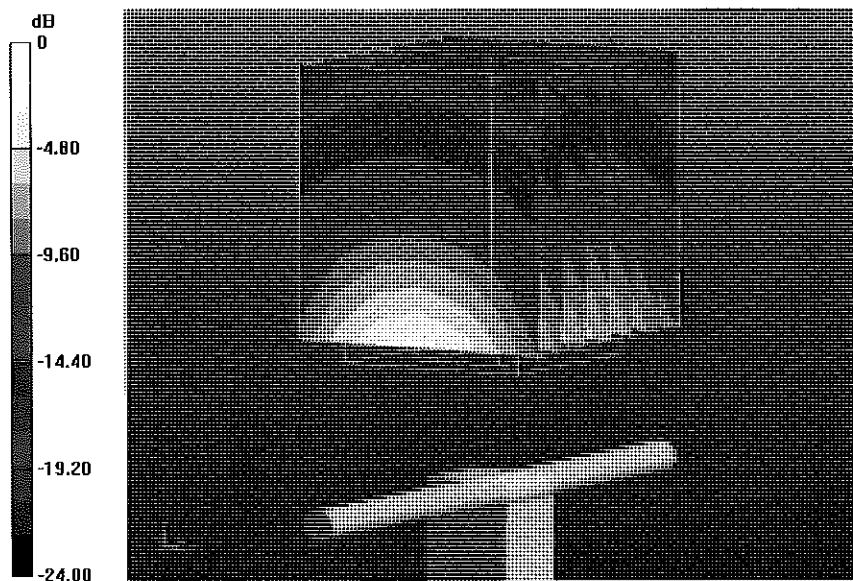

0 dB = 16.7 W/kg = 12.23 dBW/kg

# Impedance Measurement Plot for Head TSL

11 Feb 2013 11:51:51

CH1 S11 1 U FS 1: 53.639  $\Omega$  -363.28  $m\Omega$  178.82  $\mu F$  2 450.000 000 MHz

\*  
Del  
Cor  
Avg  
16  
H1d

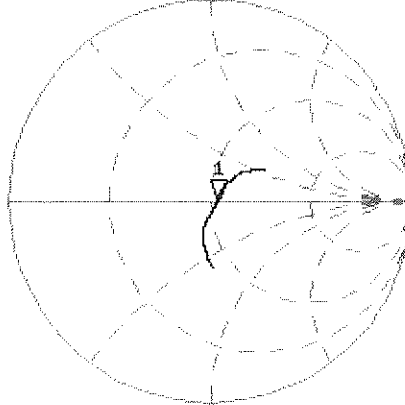

CH2 S11 LOG 5 dB/REF -20 dB 1:-29.047 dB 2 450.000 000 MHz

Cor  
Avg  
16  
H1d

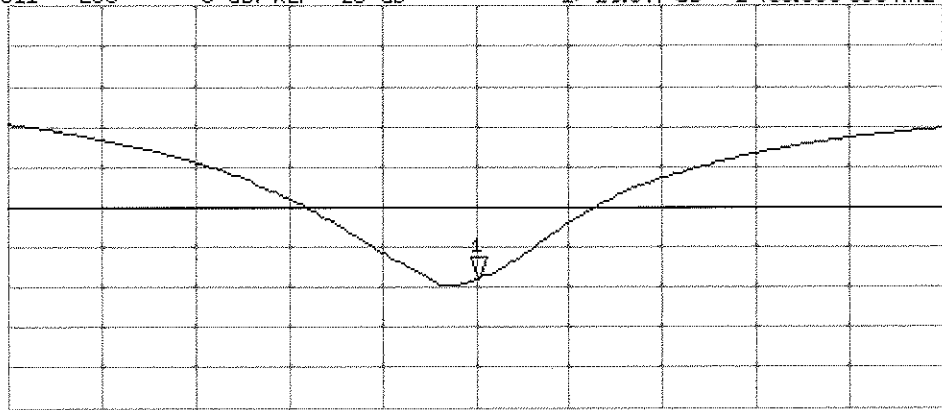

START 2 250.000 000 MHz

STOP 2 650.000 000 MHz

# DASY5 Validation Report for Body TSL

Date: 11.02.2013

Test Laboratory: SPEAG, Zurich, Switzerland

**DUT: Dipole 2450 MHz; Type: D2450V2; Serial: D2450V2 - SN: 882**

Communication System: CW; Frequency: 2450 MHz

Medium parameters used:  $f = 2450$  MHz;  $\sigma = 2.02$  S/m;  $\epsilon_r = 50.9$ ;  $\rho = 1000$  kg/m<sup>3</sup>

Phantom section: Flat Section

Measurement Standard: DASY5 (IEEE/IEC/ANSI C63.19-2007)

DASY52 Configuration:

- Probe: ES3DV3 - SN3205; ConvF(4.42, 4.42, 4.42); Calibrated: 28.12.2012;
- Sensor-Surface: 3mm (Mechanical Surface Detection)
- Electronics: DAE4 Sn601; Calibrated: 27.06.2012
- Phantom: Flat Phantom 5.0 (back); Type: QD000P50AA; Serial: 1002
- DASY52 52.8.5(1059); SEMCAD X 14.6.8(7028)

## Dipole Calibration for Body Tissue/Pin=250 mW, d=10mm/Zoom Scan (7x7x7)/Cube 0:

Measurement grid: dx=5mm, dy=5mm, dz=5mm

Reference Value = 94.474 V/m; Power Drift = 0.03 dB

Peak SAR (extrapolated) = 27.1 W/kg

**SAR(1 g) = 12.8 W/kg; SAR(10 g) = 5.91 W/kg**

Maximum value of SAR (measured) = 16.9 W/kg

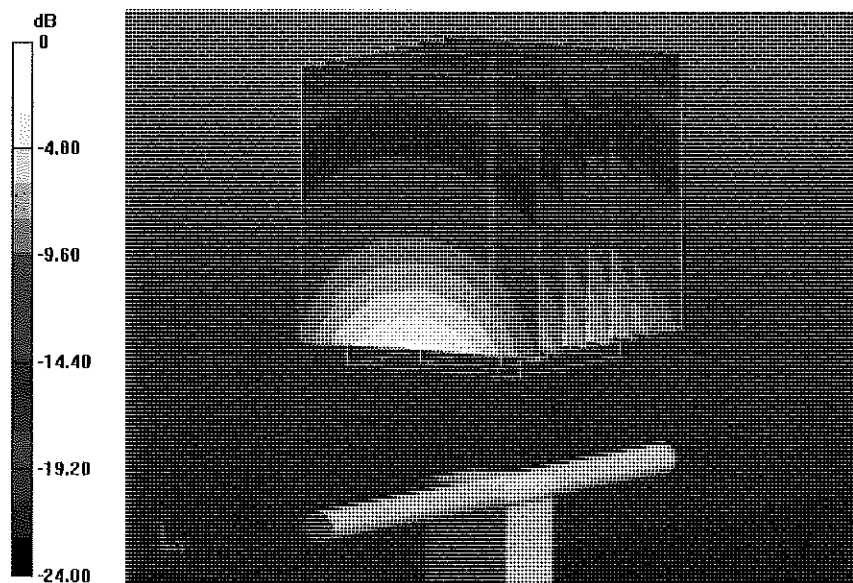

0 dB = 16.9 W/kg = 12.28 dBW/kg

# Impedance Measurement Plot for Body TSL

11 Feb 2013 11:51:25

CH1 S11 1 U FS 1: 49.500  $\Omega$  1.2461  $\mu$  80.948 pF 2 450.000 000 MHz

\*  
De1  
Cor  
Avg  
16  
H1d

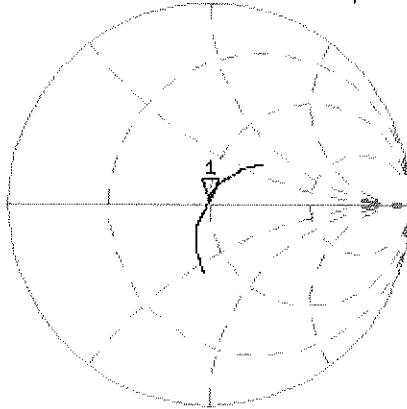

CH2 S11 LOG 5 dB/REF -20 dB 1: -37.374 dB 2 450.000 000 MHz

Cor  
Avg  
16  
H1d

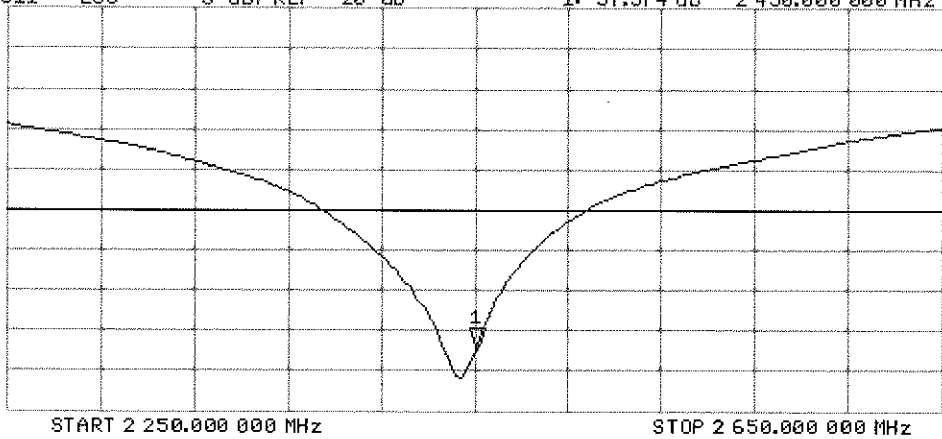

**Calibration Laboratory of  
Schmid & Partner  
Engineering AG**  
Zeughausstrasse 43, 8004 Zurich, Switzerland



**S** Schweizerischer Kalibrierdienst  
**C** Service suisse d'étalonnage  
**S** Servizio svizzero di taratura  
**S** Swiss Calibration Service

Accredited by the Swiss Accreditation Service (SAS)  
The Swiss Accreditation Service is one of the signatories to the EA  
Multilateral Agreement for the recognition of calibration certificates

Accreditation No.: **SCS 108**

Client **PC Test**

Certificate No: **D835V2-4d026\_Aug12**

## CALIBRATION CERTIFICATE

Object **D835V2 - SN: 4d026**

Calibration procedure(s) **QA CAL-05.v8  
Calibration procedure for dipole validation kits above 700 MHz**

Calibration date: **August 23, 2012**

*1/10K  
9/17/12*

This calibration certificate documents the traceability to national standards, which realize the physical units of measurements (SI).  
The measurements and the uncertainties with confidence probability are given on the following pages and are part of the certificate.

All calibrations have been conducted in the closed laboratory facility: environment temperature (22 ± 3)°C and humidity < 70%.

Calibration Equipment used (M&TE critical for calibration)

Primary Standards	ID #	Cal Date (Certificate No.)	Scheduled Calibration
Power meter EPM-442A	GB37480704	05-Oct-11 (No. 217-01451)	Oct-12
Power sensor HP 8481A	US37292783	05-Oct-11 (No. 217-01451)	Oct-12
Reference 20 dB Attenuator	SN: 5058 (20k)	27-Mar-12 (No. 217-01530)	Apr-13
Type-N mismatch combination	SN: 5047.2 / 06327	27-Mar-12 (No. 217-01533)	Apr-13
Reference Probe ES3DV3	SN: 3205	30-Dec-11 (No. ES3-3205_Dec11)	Dec-12
DAE4	SN: 601	27-Jun-12 (No. DAE4-601_Jun12)	Jun-13
Secondary Standards	ID #	Check Date (in house)	Scheduled Check
Power sensor HP 8481A	MY41092317	18-Oct-02 (in house check Oct-11)	In house check: Oct-13
RF generator R&S SMT-06	100005	04-Aug-99 (in house check Oct-11)	In house check: Oct-13
Network Analyzer HP 8753E	US37390585 S4206	18-Oct-01 (in house check Oct-11)	In house check: Oct-12

Calibrated by: **Israe El-Naouq**      Name: **Israe El-Naouq**      Function: **Laboratory Technician**

Approved by: **Katja Pokovic**      Name: **Katja Pokovic**      Function: **Technical Manager**

Signature  
*Israe El-Naouq*  
*Katja Pokovic*

Issued: August 23, 2012

This calibration certificate shall not be reproduced except in full without written approval of the laboratory.

**Calibration Laboratory of  
Schmid & Partner  
Engineering AG**  
Zeughausstrasse 43, 8004 Zurich, Switzerland



**S** Schweizerischer Kalibrierdienst  
**C** Service suisse d'étalonnage  
**S** Servizio svizzero di taratura  
**S** Swiss Calibration Service

Accredited by the Swiss Accreditation Service (SAS)  
The Swiss Accreditation Service is one of the signatories to the EA  
Multilateral Agreement for the recognition of calibration certificates

Accreditation No.: **SCS 108**

### Glossary:

TSL	tissue simulating liquid
ConvF	sensitivity in TSL / NORM x,y,z
N/A	not applicable or not measured

### Calibration is Performed According to the Following Standards:

- IEEE Std 1528-2003, "IEEE Recommended Practice for Determining the Peak Spatial-Averaged Specific Absorption Rate (SAR) in the Human Head from Wireless Communications Devices: Measurement Techniques", December 2003
- IEC 62209-1, "Procedure to measure the Specific Absorption Rate (SAR) for hand-held devices used in close proximity to the ear (frequency range of 300 MHz to 3 GHz)", February 2005
- Federal Communications Commission Office of Engineering & Technology (FCC OET), "Evaluating Compliance with FCC Guidelines for Human Exposure to Radiofrequency Electromagnetic Fields; Additional Information for Evaluating Compliance of Mobile and Portable Devices with FCC Limits for Human Exposure to Radiofrequency Emissions", Supplement C (Edition 01-01) to Bulletin 65

### Additional Documentation:

- DASY4/5 System Handbook

### Methods Applied and Interpretation of Parameters:

- Measurement Conditions:** Further details are available from the Validation Report at the end of the certificate. All figures stated in the certificate are valid at the frequency indicated.
- Antenna Parameters with TSL:** The dipole is mounted with the spacer to position its feed point exactly below the center marking of the flat phantom section, with the arms oriented parallel to the body axis.
- Feed Point Impedance and Return Loss:** These parameters are measured with the dipole positioned under the liquid filled phantom. The impedance stated is transformed from the measurement at the SMA connector to the feed point. The Return Loss ensures low reflected power. No uncertainty required.
- Electrical Delay:** One-way delay between the SMA connector and the antenna feed point. No uncertainty required.
- SAR measured:** SAR measured at the stated antenna input power.
- SAR normalized:** SAR as measured, normalized to an input power of 1 W at the antenna connector.
- SAR for nominal TSL parameters:** The measured TSL parameters are used to calculate the nominal SAR result.

The reported uncertainty of measurement is stated as the standard uncertainty of measurement multiplied by the coverage factor  $k=2$ , which for a normal distribution corresponds to a coverage probability of approximately 95%.

## Measurement Conditions

DASY system configuration, as far as not given on page 1.

DASY Version	DASY5	V52.8.2
Extrapolation	Advanced Extrapolation	
Phantom	Modular Flat Phantom	
Distance Dipole Center - TSL	15 mm	with Spacer
Zoom Scan Resolution	dx, dy, dz = 5 mm	
Frequency	835 MHz $\pm$ 1 MHz	

## Head TSL parameters

The following parameters and calculations were applied.

	Temperature	Permittivity	Conductivity
Nominal Head TSL parameters	22.0 °C	41.5	0.90 mho/m
Measured Head TSL parameters	(22.0 $\pm$ 0.2) °C	41.3 $\pm$ 6 %	0.90 mho/m $\pm$ 6 %
Head TSL temperature change during test	< 0.5 °C	---	---

## SAR result with Head TSL

SAR averaged over 1 cm <sup>3</sup> (1 g) of Head TSL	Condition	
SAR measured	250 mW input power	2.35 mW / g
SAR for nominal Head TSL parameters	normalized to 1W	<b>9.39 mW / g <math>\pm</math> 17.0 % (k=2)</b>

SAR averaged over 10 cm <sup>3</sup> (10 g) of Head TSL	condition	
SAR measured	250 mW input power	1.53 mW / g
SAR for nominal Head TSL parameters	normalized to 1W	<b>6.12 mW / g <math>\pm</math> 16.5 % (k=2)</b>

## Body TSL parameters

The following parameters and calculations were applied.

	Temperature	Permittivity	Conductivity
Nominal Body TSL parameters	22.0 °C	55.2	0.97 mho/m
Measured Body TSL parameters	(22.0 $\pm$ 0.2) °C	53.2 $\pm$ 6 %	1.00 mho/m $\pm$ 6 %
Body TSL temperature change during test	< 0.5 °C	---	---

## SAR result with Body TSL

SAR averaged over 1 cm <sup>3</sup> (1 g) of Body TSL	Condition	
SAR measured	250 mW input power	2.47 mW / g
SAR for nominal Body TSL parameters	normalized to 1W	<b>9.58 mW / g <math>\pm</math> 17.0 % (k=2)</b>

SAR averaged over 10 cm <sup>3</sup> (10 g) of Body TSL	condition	
SAR measured	250 mW input power	1.62 mW / g
SAR for nominal Body TSL parameters	normalized to 1W	<b>6.33 mW / g <math>\pm</math> 16.5 % (k=2)</b>

## Appendix

### Antenna Parameters with Head TSL

Impedance, transformed to feed point	53.7 $\Omega$ - 3.4 j $\Omega$
Return Loss	- 26.4 dB

### Antenna Parameters with Body TSL

Impedance, transformed to feed point	49.6 $\Omega$ - 4.8 j $\Omega$
Return Loss	- 26.4 dB

### General Antenna Parameters and Design

Electrical Delay (one direction)	1.389 ns
----------------------------------	----------

After long term use with 100W radiated power, only a slight warming of the dipole near the feedpoint can be measured.

The dipole is made of standard semirigid coaxial cable. The center conductor of the feeding line is directly connected to the second arm of the dipole. The antenna is therefore short-circuited for DC-signals. On some of the dipoles, small end caps are added to the dipole arms in order to improve matching when loaded according to the position as explained in the "Measurement Conditions" paragraph. The SAR data are not affected by this change. The overall dipole length is still according to the Standard.

No excessive force must be applied to the dipole arms, because they might bend or the soldered connections near the feedpoint may be damaged.

### Additional EUT Data

Manufactured by	SPEAG
Manufactured on	December 17, 2004

## DASY5 Validation Report for Head TSL

Date: 23.08.2012

Test Laboratory: SPEAG, Zurich, Switzerland

**DUT: Dipole 835 MHz; Type: D835V2; Serial: D835V2 - SN: 4d026**

Communication System: CW; Frequency: 835 MHz

Medium parameters used:  $f = 835$  MHz;  $\sigma = 0.9$  mho/m;  $\epsilon_r = 41.3$ ;  $\rho = 1000$  kg/m<sup>3</sup>

Phantom section: Flat Section

Measurement Standard: DASY5 (IEEE/IEC/ANSI C63.19-2007)

DASY52 Configuration:

- Probe: ES3DV3 - SN3205; ConvF(6.07, 6.07, 6.07); Calibrated: 30.12.2011;
- Sensor-Surface: 3mm (Mechanical Surface Detection)
- Electronics: DAE4 Sn601; Calibrated: 27.06.2012
- Phantom: Flat Phantom 4.9L; Type: QD000P49AA; Serial: 1001
- DASY52 52.8.2(969); SEMCAD X 14.6.6(6824)

### Dipole Calibration for Head Tissue/Pin=250 mW, d=15mm 2/Zoom Scan (7x7x7)/Cube 0:

Measurement grid: dx=5mm, dy=5mm, dz=5mm

Reference Value = 56.824 V/m; Power Drift = 0.01 dB

Peak SAR (extrapolated) = 3.482 mW/g

**SAR(1 g) = 2.35 mW/g; SAR(10 g) = 1.53 mW/g**

Maximum value of SAR (measured) = 2.72 W/kg

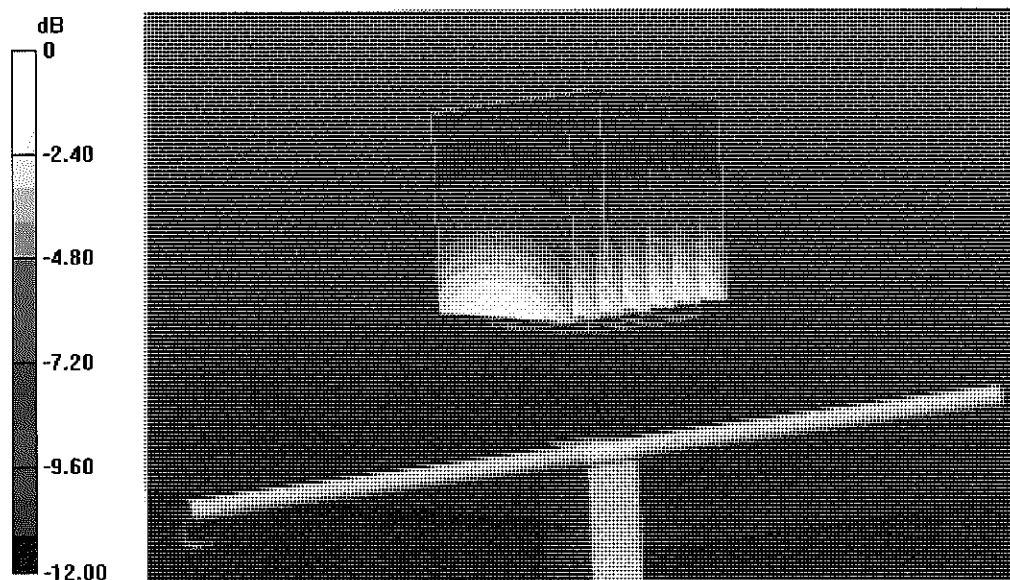

0 dB = 2.72 W/kg = 8.69 dB W/kg

# Impedance Measurement Plot for Head TSL

23 Aug 2012 12:19:04

CH1 S11 1 U FS

1: 53.662  $\Delta$  -3.3516  $\Delta$  56.870 pF

835.000 000 MHz

\*  
De1  
Cor

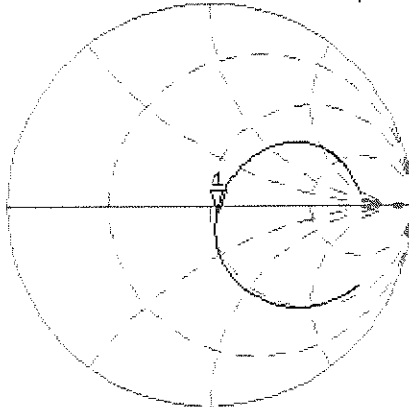

Avg  
15

H1d

CH2 S11 LOG 5 dB/REF -20 dB 1:-25.390 dB 835.000 000 MHz

Cor

Avg  
15

H1d

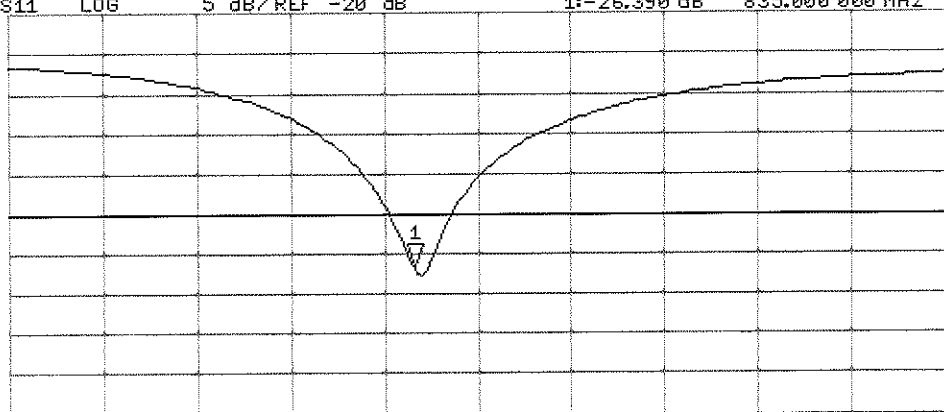

START 635.000 000 MHz

STOP 1 100.000 000 MHz

## DASY5 Validation Report for Body TSL

Date: 23.08.2012

Test Laboratory: SPEAG, Zurich, Switzerland

**DUT: Dipole 835 MHz; Type: D835V2; Serial: D835V2 - SN: 4d026**

Communication System: CW; Frequency: 835 MHz

Medium parameters used:  $f = 835$  MHz;  $\sigma = 1$  mho/m;  $\epsilon_r = 53.2$ ;  $\rho = 1000$  kg/m<sup>3</sup>

Phantom section: Flat Section

Measurement Standard: DASY5 (IEEE/IEC/ANSI C63.19-2007)

DASY52 Configuration:

- Probe: ES3DV3 - SN3205; ConvF(6.02, 6.02, 6.02); Calibrated: 30.12.2011;
- Sensor-Surface: 3mm (Mechanical Surface Detection)
- Electronics: DAE4 Sn601; Calibrated: 27.06.2012
- Phantom: Flat Phantom 4.9L; Type: QD000P49AA; Serial: 1001
- DASY52 52.8.2(969); SEMCAD X 14.6.6(6824)

### Dipole Calibration for Body Tissue/Pin=250 mW, d=15mm/Zoom Scan (7x7x7)/Cube 0:

Measurement grid: dx=5mm, dy=5mm, dz=5mm

Reference Value = 55.339 V/m; Power Drift = 0.04 dB

Peak SAR (extrapolated) = 3.592 mW/g

**SAR(1 g) = 2.47 mW/g; SAR(10 g) = 1.62 mW/g**

Maximum value of SAR (measured) = 2.87 W/kg

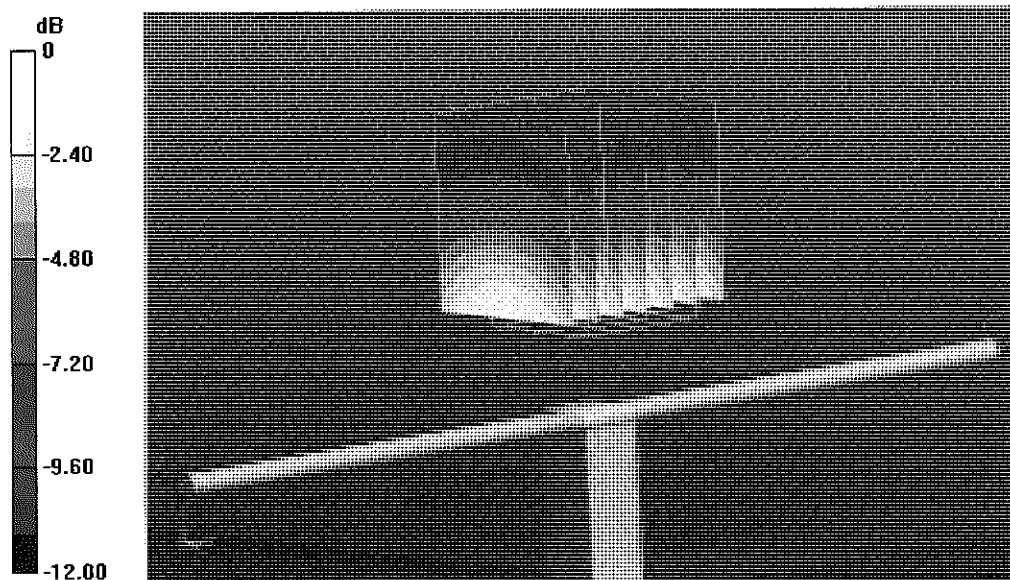

# Impedance Measurement Plot for Body TSL

23 Aug 2012 10:54:42

[CH1] S11 1 U FS

1: 49.557  $\angle$  -4.7500  $\angle$  40.127 pF

835.000 000 MHz

\*  
Del  
Cor

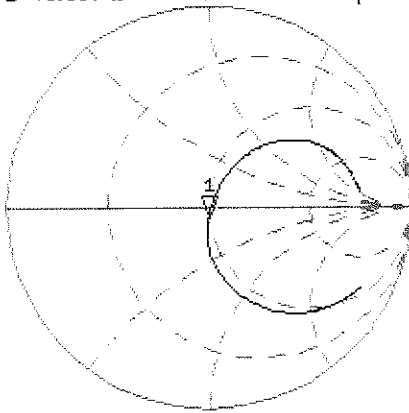

Avg  
16

H1d

CH2 S11 LOG 5 dB/REF -20 dB 1:-26.405 dB 835.000 000 MHz

Cor

Avg  
16

H1d

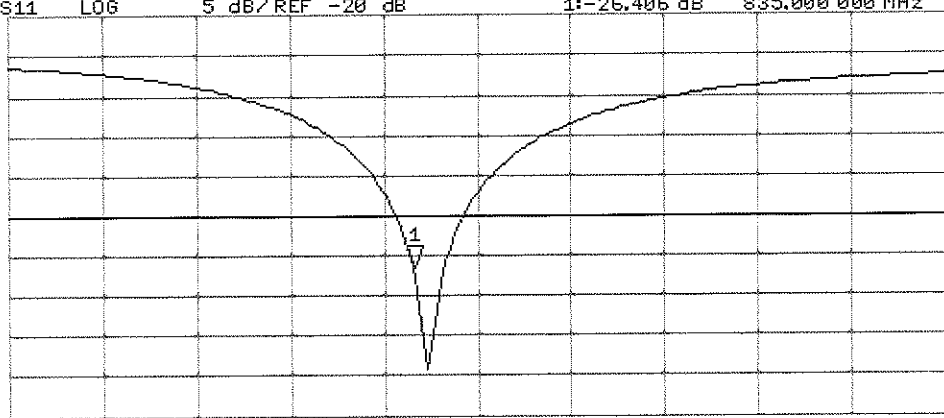

START 635.000 000 MHz

STOP 1 100.000 000 MHz



Accredited by the Swiss Accreditation Service (SAS)  
The Swiss Accreditation Service is one of the signatories to the EA  
Multilateral Agreement for the recognition of calibration certificates

Accreditation No.: **SCS 108**

Client **PC Test**

Certificate No: **D1900V2-5d141\_May13**

## CALIBRATION CERTIFICATE

Object **D1900V2 - SN: 5d141**

Calibration procedure(s) **QA CAL-05.v9  
Calibration procedure for dipole validation kits above 700 MHz**

Calibration date: **May 02, 2013** ✓ 5/8/13

This calibration certificate documents the traceability to national standards, which realize the physical units of measurements (SI).  
The measurements and the uncertainties with confidence probability are given on the following pages and are part of the certificate.

All calibrations have been conducted in the closed laboratory facility: environment temperature ( $22 \pm 3$ )°C and humidity < 70%.

Calibration Equipment used (M&TE critical for calibration)

Primary Standards	ID #	Cal Date (Certificate No.)	Scheduled Calibration
Power meter EPM-442A	GB37480704	01-Nov-12 (No. 217-01640)	Oct-13
Power sensor HP 8481A	US37292783	01-Nov-12 (No. 217-01640)	Oct-13
Reference 20 dB Attenuator	SN: 5058 (20k)	04-Apr-13 (No. 217-01736)	Apr-14
Type-N mismatch combination	SN: 5047.3 / 06327	04-Apr-13 (No. 217-01739)	Apr-14
Reference Probe ES3DV3	SN: 3205	28-Dec-12 (No. ES3-3205_Dec12)	Dec-13
DAE4	SN: 601	25-Apr-13 (No. DAE4-601_Apr13)	Apr-14

Secondary Standards	ID #	Check Date (in house)	Scheduled Check
Power sensor HP 8481A	MY41092317	18-Oct-02 (in house check Oct-11)	In house check: Oct-13
RF generator R&S SMT-06	100005	04-Aug-99 (in house check Oct-11)	In house check: Oct-13
Network Analyzer HP 8753E	US37390585 S4206	18-Oct-01 (in house check Oct-12)	In house check: Oct-13

Calibrated by: **Claudio Leubler**      Name: Claudio Leubler      Function: Laboratory Technician

Signature

Approved by: **Katja Pokovic**      Name: Katja Pokovic      Function: Technical Manager

Issued: May 2, 2013

This calibration certificate shall not be reproduced except in full without written approval of the laboratory.



Accredited by the Swiss Accreditation Service (SAS)

The Swiss Accreditation Service is one of the signatories to the EA  
Multilateral Agreement for the recognition of calibration certificates

Accreditation No.: **SCS 108**

### Glossary:

TSL	tissue simulating liquid
ConvF	sensitivity in TSL / NORM x,y,z
N/A	not applicable or not measured

### Calibration is Performed According to the Following Standards:

- IEEE Std 1528-2003, "IEEE Recommended Practice for Determining the Peak Spatial-Averaged Specific Absorption Rate (SAR) in the Human Head from Wireless Communications Devices: Measurement Techniques", December 2003
- IEC 62209-1, "Procedure to measure the Specific Absorption Rate (SAR) for hand-held devices used in close proximity to the ear (frequency range of 300 MHz to 3 GHz)", February 2005
- Federal Communications Commission Office of Engineering & Technology (FCC OET), "Evaluating Compliance with FCC Guidelines for Human Exposure to Radiofrequency Electromagnetic Fields; Additional Information for Evaluating Compliance of Mobile and Portable Devices with FCC Limits for Human Exposure to Radiofrequency Emissions", Supplement C (Edition 01-01) to Bulletin 65

### Additional Documentation:

- DASY4/5 System Handbook

### Methods Applied and Interpretation of Parameters:

- Measurement Conditions:** Further details are available from the Validation Report at the end of the certificate. All figures stated in the certificate are valid at the frequency indicated.
- Antenna Parameters with TSL:** The dipole is mounted with the spacer to position its feed point exactly below the center marking of the flat phantom section, with the arms oriented parallel to the body axis.
- Feed Point Impedance and Return Loss:** These parameters are measured with the dipole positioned under the liquid filled phantom. The impedance stated is transformed from the measurement at the SMA connector to the feed point. The Return Loss ensures low reflected power. No uncertainty required.
- Electrical Delay:** One-way delay between the SMA connector and the antenna feed point. No uncertainty required.
- SAR measured:** SAR measured at the stated antenna input power.
- SAR normalized:** SAR as measured, normalized to an input power of 1 W at the antenna connector.
- SAR for nominal TSL parameters:** The measured TSL parameters are used to calculate the nominal SAR result.

The reported uncertainty of measurement is stated as the standard uncertainty of measurement multiplied by the coverage factor  $k=2$ , which for a normal distribution corresponds to a coverage probability of approximately 95%.

## Measurement Conditions

DASY system configuration, as far as not given on page 1.

DASY Version	DASY5	V52.8.6
Extrapolation	Advanced Extrapolation	
Phantom	Modular Flat Phantom	
Distance Dipole Center - TSL	10 mm	with Spacer
Zoom Scan Resolution	dx, dy, dz = 5 mm	
Frequency	1900 MHz $\pm$ 1 MHz	

## Head TSL parameters

The following parameters and calculations were applied.

	Temperature	Permittivity	Conductivity
Nominal Head TSL parameters	22.0 °C	40.0	1.40 mho/m
Measured Head TSL parameters	(22.0 $\pm$ 0.2) °C	39.3 $\pm$ 6 %	1.37 mho/m $\pm$ 6 %
Head TSL temperature change during test	< 0.5 °C	----	----

## SAR result with Head TSL

SAR averaged over 1 cm <sup>3</sup> (1 g) of Head TSL	Condition	
SAR measured	250 mW input power	10.1 W/kg
SAR for nominal Head TSL parameters	normalized to 1W	<b>40.8 W/kg <math>\pm</math> 17.0 % (k=2)</b>

SAR averaged over 10 cm <sup>3</sup> (10 g) of Head TSL	condition	
SAR measured	250 mW input power	5.30 W/kg
SAR for nominal Head TSL parameters	normalized to 1W	<b>21.3 W/kg <math>\pm</math> 16.5 % (k=2)</b>

## Body TSL parameters

The following parameters and calculations were applied.

	Temperature	Permittivity	Conductivity
Nominal Body TSL parameters	22.0 °C	53.3	1.52 mho/m
Measured Body TSL parameters	(22.0 $\pm$ 0.2) °C	54.0 $\pm$ 6 %	1.51 mho/m $\pm$ 6 %
Body TSL temperature change during test	< 0.5 °C	----	----

## SAR result with Body TSL

SAR averaged over 1 cm <sup>3</sup> (1 g) of Body TSL	Condition	
SAR measured	250 mW input power	10.3 W/kg
SAR for nominal Body TSL parameters	normalized to 1W	<b>41.5 W/kg <math>\pm</math> 17.0 % (k=2)</b>

SAR averaged over 10 cm <sup>3</sup> (10 g) of Body TSL	condition	
SAR measured	250 mW input power	5.51 W/kg
SAR for nominal Body TSL parameters	normalized to 1W	<b>22.1 W/kg <math>\pm</math> 16.5 % (k=2)</b>

## Appendix

### Antenna Parameters with Head TSL

Impedance, transformed to feed point	52.6 $\Omega$ + 4.9 j $\Omega$
Return Loss	- 25.3 dB

### Antenna Parameters with Body TSL

Impedance, transformed to feed point	48.3 $\Omega$ + 5.9 j $\Omega$
Return Loss	- 24.1 dB

### General Antenna Parameters and Design

Electrical Delay (one direction)	1.199 ns
----------------------------------	----------

After long term use with 100W radiated power, only a slight warming of the dipole near the feedpoint can be measured.

The dipole is made of standard semirigid coaxial cable. The center conductor of the feeding line is directly connected to the second arm of the dipole. The antenna is therefore short-circuited for DC-signals. On some of the dipoles, small end caps are added to the dipole arms in order to improve matching when loaded according to the position as explained in the "Measurement Conditions" paragraph. The SAR data are not affected by this change. The overall dipole length is still according to the Standard.

No excessive force must be applied to the dipole arms, because they might bend or the soldered connections near the feedpoint may be damaged.

### Additional EUT Data

Manufactured by	SPEAG
Manufactured on	March 11, 2011

## DASY5 Validation Report for Head TSL

Date: 02.05.2013

Test Laboratory: SPEAG, Zurich, Switzerland

**DUT: Dipole 1900 MHz; Type: D1900V2; Serial: D1900V2 - SN: 5d141**

Communication System: UID 0 - CW; Frequency: 1900 MHz

Medium parameters used:  $f = 1900$  MHz;  $\sigma = 1.37$  S/m;  $\epsilon_r = 39.3$ ;  $\rho = 1000$  kg/m<sup>3</sup>

Phantom section: Flat Section

Measurement Standard: DASY5 (IEEE/IEC/ANSI C63.19-2007)

DASY52 Configuration:

- Probe: ES3DV3 - SN3205; ConvF(4.98, 4.98, 4.98); Calibrated: 28.12.2012;
- Sensor-Surface: 3mm (Mechanical Surface Detection)
- Electronics: DAE4 Sn601; Calibrated: 25.04.2013
- Phantom: Flat Phantom 5.0 (front); Type: QD000P50AA; Serial: 1001
- DASY52 52.8.6(1115); SEMCAD X 14.6.9(7117)

### **Dipole Calibration for Head Tissue/Pin=250 mW, d=10mm/Zoom Scan (7x7x7)/Cube 0:**

Measurement grid: dx=5mm, dy=5mm, dz=5mm

Reference Value = 97.124 V/m; Power Drift = 0.05 dB

Peak SAR (extrapolated) = 18.2 W/kg

**SAR(1 g) = 10.1 W/kg; SAR(10 g) = 5.3 W/kg**

Maximum value of SAR (measured) = 12.5 W/kg

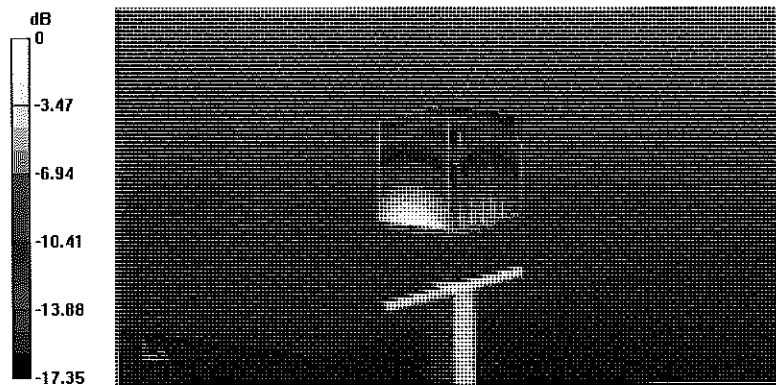

0 dB = 12.5 W/kg = 10.97 dBW/kg

# Impedance Measurement Plot for Head TSL

2 May 2013 15:38:50

CH1 S11 1 U FS 1: 52.600  $\Omega$  4.9375  $\Omega$  413.59  $\mu$ H 1 900.000 000 MHz

\*  
Del  
Cor  
Avg  
4

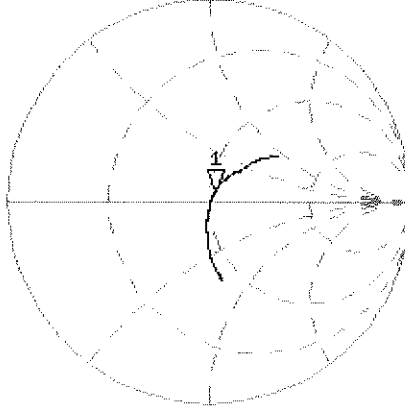

H1d

CH2 S11 LOG 5 dB/REF -20 dB 1:-25.293 dB 1 900.000 000 MHz

Cor  
Avg  
4

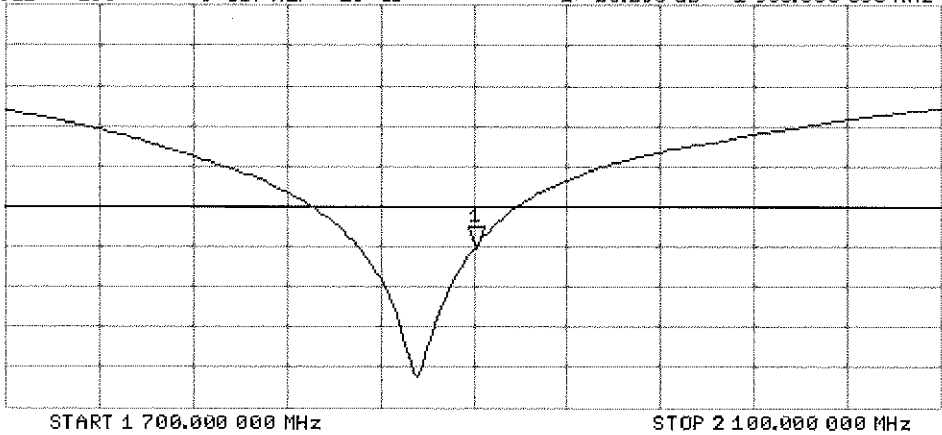

H1d

## DASY5 Validation Report for Body TSL

Date: 02.05.2013

Test Laboratory: SPEAG, Zurich, Switzerland

**DUT: Dipole 1900 MHz; Type: D1900V2; Serial: D1900V2 - SN: 5d141**

Communication System: UID 0 - CW; Frequency: 1900 MHz

Medium parameters used:  $f = 1900$  MHz;  $\sigma = 1.51$  S/m;  $\epsilon_r = 54$ ;  $\rho = 1000$  kg/m<sup>3</sup>

Phantom section: Flat Section

Measurement Standard: DASY5 (IEEE/IEC/ANSI C63.19-2007)

DASY52 Configuration:

- Probe: ES3DV3 - SN3205; ConvF(4.6, 4.6, 4.6); Calibrated: 28.12.2012;
- Sensor-Surface: 3mm (Mechanical Surface Detection)
- Electronics: DAE4 Sn601; Calibrated: 25.04.2013
- Phantom: Flat Phantom 5.0 (back); Type: QD000P50AA; Serial: 1002
- DASY52 52.8.6(1115); SEMCAD X 14.6.9(7117)

### Dipole Calibration for Body Tissue/Pin=250 mW, d=10mm/Zoom Scan (7x7x7)/Cube 0:

Measurement grid: dx=5mm, dy=5mm, dz=5mm

Reference Value = 97.124 V/m; Power Drift = -0.00 dB

Peak SAR (extrapolated) = 17.6 W/kg

**SAR(1 g) = 10.3 W/kg; SAR(10 g) = 5.51 W/kg**

Maximum value of SAR (measured) = 13.0 W/kg

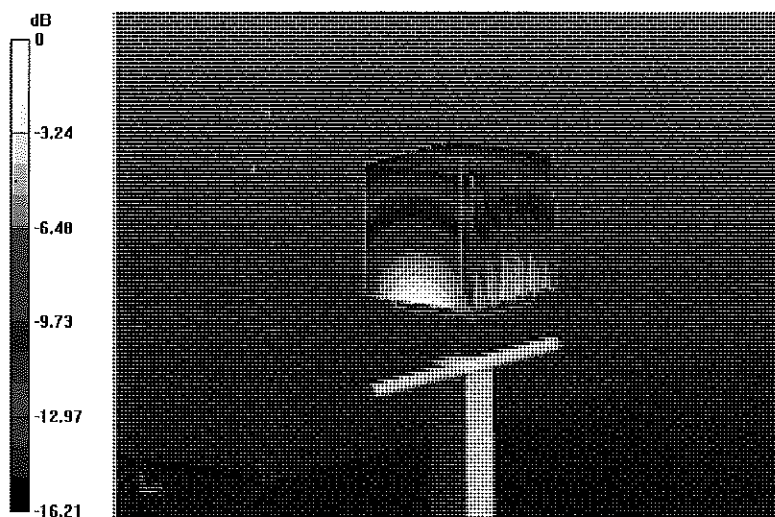

0 dB = 13.0 W/kg = 11.14 dBW/kg

# Impedance Measurement Plot for Body TSL

2 May 2013 15:38:04

[CH1] S11 1 U FS 1: 48.273  $\Omega$  5.9121  $\Omega$  495.23  $\mu$ H 1 900.000 000 MHz

\*  
De1  
Cor  
Avg  
16  
H1d

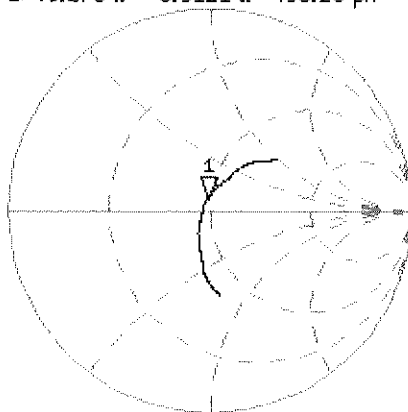

CH2 S11 LOG 5 dB/REF -20 dB 1:-24.074 dB 1 900.000 000 MHz

Cor  
Avg  
16  
H1d

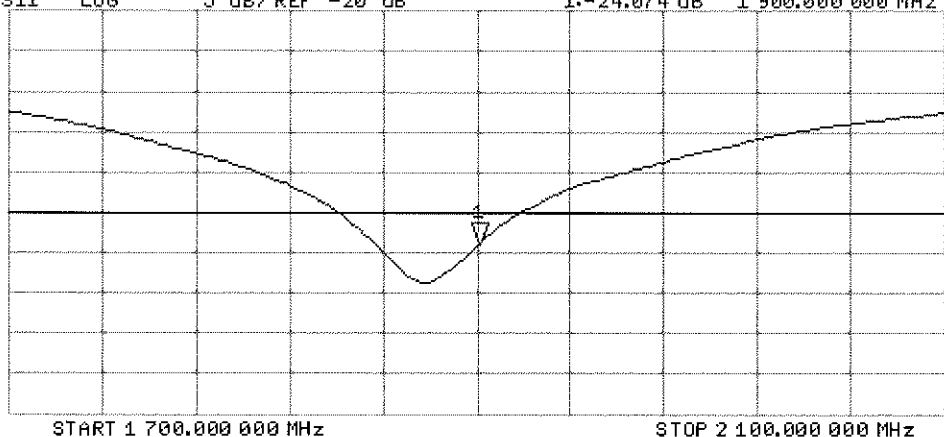



Accredited by the Swiss Accreditation Service (SAS)  
The Swiss Accreditation Service is one of the signatories to the EA  
Multilateral Agreement for the recognition of calibration certificates

Accreditation No.: **SCS 108**

Client **PC Test**

Certificate No: **D2450V2-797\_Jan13**

**CALIBRATION CERTIFICATE**

Object **D2450V2 - SN: 797**

Calibration procedure(s) **QA CAL-05.v9  
Calibration procedure for dipole validation kits above 700 MHz**

Calibration date: **January 08, 2013**

*✓ KOK  
1/28/13*

This calibration certificate documents the traceability to national standards, which realize the physical units of measurements (SI).  
The measurements and the uncertainties with confidence probability are given on the following pages and are part of the certificate.

All calibrations have been conducted in the closed laboratory facility: environment temperature (22 ± 3)°C and humidity < 70%.

Calibration Equipment used (M&TE critical for calibration)

Primary Standards	ID #	Cal Date (Certificate No.)	Scheduled Calibration
Power meter EPM-442A	GB37480704	01-Nov-12 (No. 217-01640)	Oct-13
Power sensor HP 8481A	US37292783	01-Nov-12 (No. 217-01640)	Oct-13
Reference 20 dB Attenuator	SN: 5058 (20k)	27-Mar-12 (No. 217-01530)	Apr-13
Type-N mismatch combination	SN: 5047.3 / 06327	27-Mar-12 (No. 217-01533)	Apr-13
Reference Probe ES3DV3	SN: 3205	28-Dec-12 (No. ES3-3205_Dec12)	Dec-13
DAE4	SN: 601	27-Jun-12 (No. DAE4-601_Jun12)	Jun-13
Secondary Standards	ID #	Check Date (in house)	Scheduled Check
Power sensor HP 8481A	MY41092317	18-Oct-02 (in house check Oct-11)	In house check: Oct-13
RF generator R&S SMT-06	100005	04-Aug-99 (in house check Oct-11)	In house check: Oct-13
Network Analyzer HP 8753E	US37390585 S4206	18-Oct-01 (in house check Oct-12)	In house check: Oct-13

Calibrated by: **Israe El-Naouq**      Name: **Israe El-Naouq**      Function: **Laboratory Technician**      Signature: *Israe El-Naouq*

Approved by: **Katja Pokovic**      Name: **Katja Pokovic**      Function: **Technical Manager**      Signature: *Katja Pokovic*

Issued: January 8, 2013

This calibration certificate shall not be reproduced except in full without written approval of the laboratory.



Accredited by the Swiss Accreditation Service (SAS)

The Swiss Accreditation Service is one of the signatories to the EA  
Multilateral Agreement for the recognition of calibration certificates

Accreditation No.: **SCS 108**

### Glossary:

TSL	tissue simulating liquid
ConvF	sensitivity in TSL / NORM x,y,z
N/A	not applicable or not measured

### Calibration is Performed According to the Following Standards:

- IEEE Std 1528-2003, "IEEE Recommended Practice for Determining the Peak Spatial-Averaged Specific Absorption Rate (SAR) in the Human Head from Wireless Communications Devices: Measurement Techniques", December 2003
- IEC 62209-1, "Procedure to measure the Specific Absorption Rate (SAR) for hand-held devices used in close proximity to the ear (frequency range of 300 MHz to 3 GHz)", February 2005
- Federal Communications Commission Office of Engineering & Technology (FCC OET), "Evaluating Compliance with FCC Guidelines for Human Exposure to Radiofrequency Electromagnetic Fields; Additional Information for Evaluating Compliance of Mobile and Portable Devices with FCC Limits for Human Exposure to Radiofrequency Emissions", Supplement C (Edition 01-01) to Bulletin 65

### Additional Documentation:

- DASY4/5 System Handbook

### Methods Applied and Interpretation of Parameters:

- Measurement Conditions:** Further details are available from the Validation Report at the end of the certificate. All figures stated in the certificate are valid at the frequency indicated.
- Antenna Parameters with TSL:** The dipole is mounted with the spacer to position its feed point exactly below the center marking of the flat phantom section, with the arms oriented parallel to the body axis.
- Feed Point Impedance and Return Loss:** These parameters are measured with the dipole positioned under the liquid filled phantom. The impedance stated is transformed from the measurement at the SMA connector to the feed point. The Return Loss ensures low reflected power. No uncertainty required.
- Electrical Delay:** One-way delay between the SMA connector and the antenna feed point. No uncertainty required.
- SAR measured:** SAR measured at the stated antenna input power.
- SAR normalized:** SAR as measured, normalized to an input power of 1 W at the antenna connector.
- SAR for nominal TSL parameters:** The measured TSL parameters are used to calculate the nominal SAR result.

The reported uncertainty of measurement is stated as the standard uncertainty of measurement multiplied by the coverage factor  $k=2$ , which for a normal distribution corresponds to a coverage probability of approximately 95%.

## Measurement Conditions

DASY system configuration, as far as not given on page 1.

DASY Version	DASY5	V52.8.4
Extrapolation	Advanced Extrapolation	
Phantom	Modular Flat Phantom	
Distance Dipole Center - TSL	10 mm	with Spacer
Zoom Scan Resolution	dx, dy, dz = 5 mm	
Frequency	2450 MHz ± 1 MHz	

## Head TSL parameters

The following parameters and calculations were applied.

	Temperature	Permittivity	Conductivity
Nominal Head TSL parameters	22.0 °C	39.2	1.80 mho/m
Measured Head TSL parameters	(22.0 ± 0.2) °C	37.9 ± 6 %	1.85 mho/m ± 6 %
Head TSL temperature change during test	< 0.5 °C	----	----

## SAR result with Head TSL

SAR averaged over 1 cm <sup>3</sup> (1 g) of Head TSL	Condition	
SAR measured	250 mW input power	13.4 W/kg
SAR for nominal Head TSL parameters	normalized to 1W	<b>52.5 W/kg ± 17.0 % (k=2)</b>

SAR averaged over 10 cm <sup>3</sup> (10 g) of Head TSL	condition	
SAR measured	250 mW input power	6.20 W/kg
SAR for nominal Head TSL parameters	normalized to 1W	<b>24.5 W/kg ± 16.5 % (k=2)</b>

## Body TSL parameters

The following parameters and calculations were applied.

	Temperature	Permittivity	Conductivity
Nominal Body TSL parameters	22.0 °C	52.7	1.95 mho/m
Measured Body TSL parameters	(22.0 ± 0.2) °C	50.5 ± 6 %	2.01 mho/m ± 6 %
Body TSL temperature change during test	< 0.5 °C	----	----

## SAR result with Body TSL

SAR averaged over 1 cm <sup>3</sup> (1 g) of Body TSL	Condition	
SAR measured	250 mW input power	12.7 W/kg
SAR for nominal Body TSL parameters	normalized to 1W	<b>49.6 W/kg ± 17.0 % (k=2)</b>

SAR averaged over 10 cm <sup>3</sup> (10 g) of Body TSL	condition	
SAR measured	250 mW input power	5.88 W/kg
SAR for nominal Body TSL parameters	normalized to 1W	<b>23.2 W/kg ± 16.5 % (k=2)</b>

## Appendix

### Antenna Parameters with Head TSL

Impedance, transformed to feed point	53.3 $\Omega$ + 3.1 j $\Omega$
Return Loss	- 27.1 dB

### Antenna Parameters with Body TSL

Impedance, transformed to feed point	49.1 $\Omega$ + 4.9 j $\Omega$
Return Loss	- 26.0 dB

### General Antenna Parameters and Design

Electrical Delay (one direction)	1.152 ns
----------------------------------	----------

After long term use with 100W radiated power, only a slight warming of the dipole near the feedpoint can be measured.

The dipole is made of standard semirigid coaxial cable. The center conductor of the feeding line is directly connected to the second arm of the dipole. The antenna is therefore short-circuited for DC-signals. On some of the dipoles, small end caps are added to the dipole arms in order to improve matching when loaded according to the position as explained in the "Measurement Conditions" paragraph. The SAR data are not affected by this change. The overall dipole length is still according to the Standard.

No excessive force must be applied to the dipole arms, because they might bend or the soldered connections near the feedpoint may be damaged.

### Additional EUT Data

Manufactured by	SPEAG
Manufactured on	January 24, 2006

## DASY5 Validation Report for Head TSL

Date: 08.01.2013

Test Laboratory: SPEAG, Zurich, Switzerland

**DUT: Dipole 2450 MHz; Type: D2450V2; Serial: D2450V2 - SN: 797**

Communication System: CW; Frequency: 2450 MHz

Medium parameters used:  $f = 2450$  MHz;  $\sigma = 1.85$  S/m;  $\epsilon_r = 37.9$ ;  $\rho = 1000$  kg/m<sup>3</sup>

Phantom section: Flat Section

Measurement Standard: DASY5 (IEEE/IEC/ANSI C63.19-2007)

DASY52 Configuration:

- Probe: ES3DV3 - SN3205; ConvF(4.52, 4.52, 4.52); Calibrated: 28.12.2012;
- Sensor-Surface: 3mm (Mechanical Surface Detection)
- Electronics: DAE4 Sn601; Calibrated: 27.06.2012
- Phantom: Flat Phantom 5.0 (front); Type: QD000P50AA; Serial: 1001
- DASY52 52.8.4(1052); SEMCAD X 14.6.8(7028)

### Dipole Calibration for Head Tissue/ $P_{in}=250$ mW, $d=10$ mm/Zoom Scan (7x7x7)/Cube 0:

Measurement grid:  $dx=5$ mm,  $dy=5$ mm,  $dz=5$ mm

Reference Value = 99.154 V/m; Power Drift = 0.06 dB

Peak SAR (extrapolated) = 27.8 W/kg

**SAR(1 g) = 13.4 W/kg; SAR(10 g) = 6.2 W/kg**

Maximum value of SAR (measured) = 17.0 W/kg

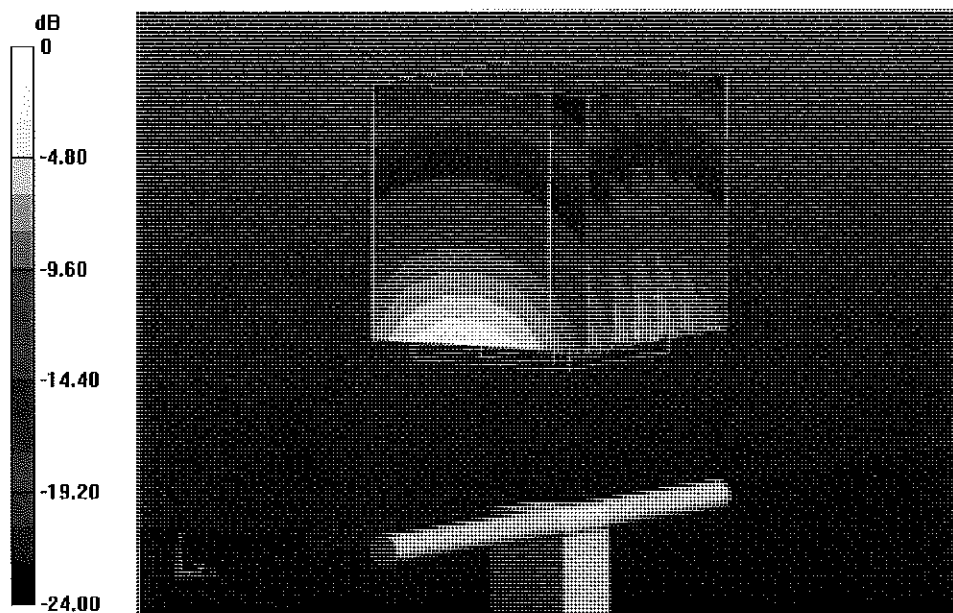

0 dB = 17.0 W/kg = 12.30 dBW/kg

# Impedance Measurement Plot for Head TSL

8 Jan 2013 12:37:14

CH1 S11 1 U FS 1: 53.346  $\Delta$  3.0762  $\Delta$  199.83 pF 2 450.000 000 MHz

#  
De1  
Cor

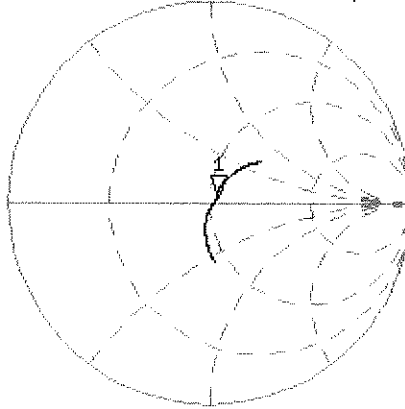

Avg  
16

H1d

CH2 S11 LOG 5 dB/REF -20 dB 1: -27.136 dB 2 450.000 000 MHz

Cor

Avg  
16

H1d

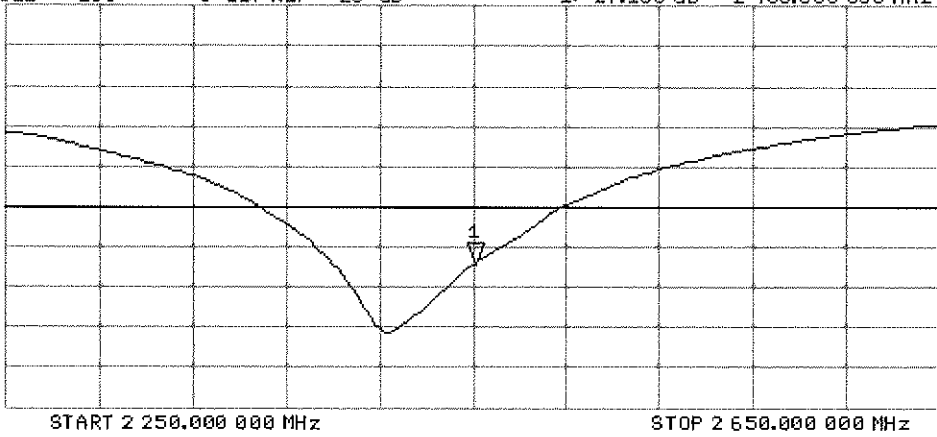

## DASY5 Validation Report for Body TSL

Date: 08.01.2013

Test Laboratory: SPEAG, Zurich, Switzerland

**DUT: Dipole 2450 MHz; Type: D2450V2; Serial: D2450V2 - SN: 797**

Communication System: CW; Frequency: 2450 MHz

Medium parameters used:  $f = 2450$  MHz;  $\sigma = 2.01$  S/m;  $\epsilon_r = 50.5$ ;  $\rho = 1000$  kg/m<sup>3</sup>

Phantom section: Flat Section

Measurement Standard: DASY5 (IEEE/IEC/ANSI C63.19-2007)

DASY52 Configuration:

- Probe: ES3DV3 - SN3205; ConvF(4.42, 4.42, 4.42); Calibrated: 28.12.2012;
- Sensor-Surface: 3mm (Mechanical Surface Detection)
- Electronics: DAE4 Sn601; Calibrated: 27.06.2012
- Phantom: Flat Phantom 5.0 (back); Type: QD000P50AA; Serial: 1002
- DASY52 52.8.4(1052); SEMCAD X 14.6.8(7028)

### **Dipole Calibration for Body Tissue/Pin=250 mW, d=10mm/Zoom Scan (7x7x7)/Cube 0:**

Measurement grid: dx=5mm, dy=5mm, dz=5mm

Reference Value = 93.935 V/m; Power Drift = 0.01 dB

Peak SAR (extrapolated) = 26.7 W/kg

**SAR(1 g) = 12.7 W/kg; SAR(10 g) = 5.88 W/kg**

Maximum value of SAR (measured) = 16.7 W/kg

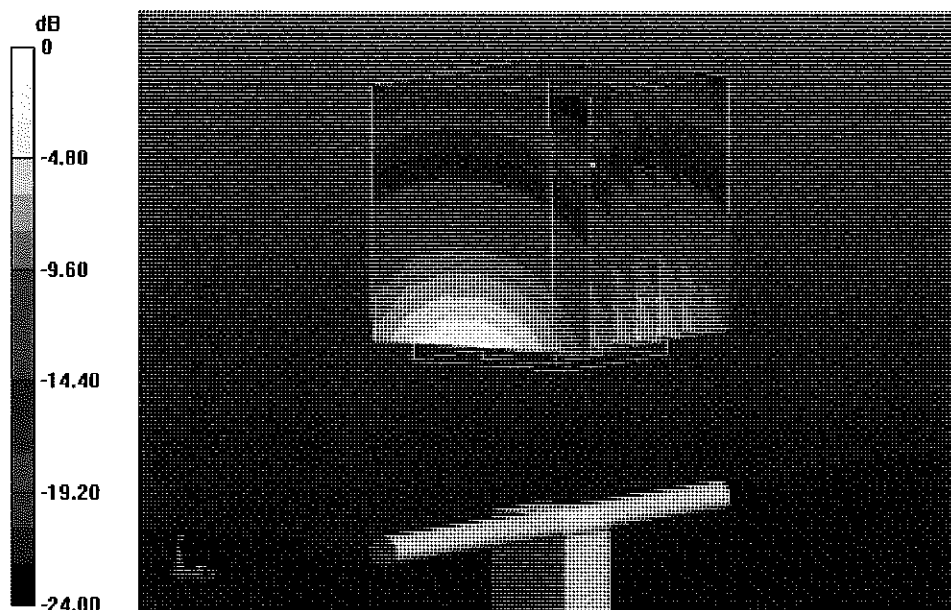

0 dB = 16.7 W/kg = 12.23 dBW/kg

# Impedance Measurement Plot for Body TSL

8 Jan 2013 12:36:45

CH1 S11 1 U FS

1: 49.090  $\angle$  4.9102  $\angle$  318.97  $\mu$ H

2 450.000 000 MHz

\*  
De1

Cor

Avg  
16

H1d

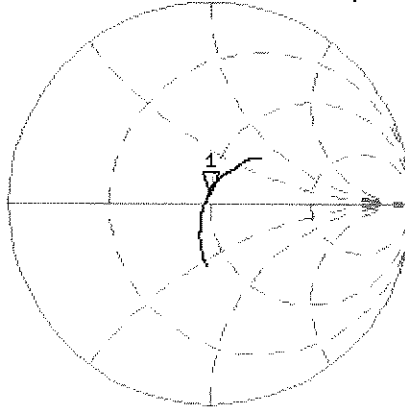

CH2 S11 LOG

5 dB/REF -20 dB

1: -25.963 dB

2 450.000 000 MHz

Cor

Avg  
16

H1d

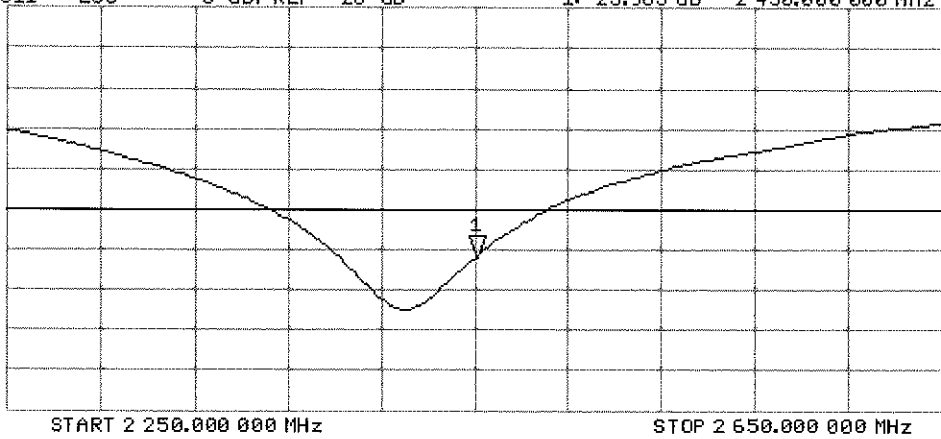

START 2 250.000 000 MHz

STOP 2 650.000 000 MHz



Accredited by the Swiss Accreditation Service (SAS)  
The Swiss Accreditation Service is one of the signatories to the EA  
Multilateral Agreement for the recognition of calibration certificates

Accreditation No.: **SCS 108**

Client **PC Test**

Certificate No: **ES3-3318\_Apr13**

**CALIBRATION CERTIFICATE**

Object: **ES3DV3 - SN:3318**

Calibration procedure(s): **QA CAL-01.v8, QA CAL-23.v4, QA CAL-25.v4  
Calibration procedure for dosimetric E-field probes**

Calibration date: **April 29, 2013**

This calibration certificate documents the traceability to national standards, which realize the physical units of measurements (SI).  
The measurements and the uncertainties with confidence probability are given on the following pages and are part of the certificate.

All calibrations have been conducted in the closed laboratory facility: environment temperature (22 ± 3)°C and humidity < 70%.

Calibration Equipment used (M&TE critical for calibration)

VCC  
6/14/13

Primary Standards	ID	Cal Date (Certificate No.)	Scheduled Calibration
Power meter E4419B	GB41293874	04-Apr-13 (No. 217-01733)	Apr-14
Power sensor E4412A	MY41498087	04-Apr-13 (No. 217-01733)	Apr-14
Reference 3 dB Attenuator	SN: S5054 (3c)	04-Apr-13 (No. 217-01737)	Apr-14
Reference 20 dB Attenuator	SN: S5277 (20x)	04-Apr-13 (No. 217-01735)	Apr-14
Reference 30 dB Attenuator	SN: S5129 (30b)	04-Apr-13 (No. 217-01738)	Apr-14
Reference Probe ES3DV2	SN: 3013	28-Dec-12 (No. ES3-3013_Dec12)	Dec-13
DAE4	SN: 660	31-Jan-13 (No. DAE4-660_Jan13)	Jan-14
Secondary Standards	ID	Check Date (in house)	Scheduled Check
RF generator HP 8648C	US3642U01700	4-Aug-99 (in house check Apr-13)	In house check: Apr-15
Network Analyzer HP 8753E	US37390585	18-Oct-01 (in house check Oct-12)	In house check: Oct-13

	Name	Function	Signature
Calibrated by:	Dimce Iliev	Laboratory Technician	
Approved by:	Katja Pokovic	Technical Manager	

Issued: April 29, 2013

This calibration certificate shall not be reproduced except in full without written approval of the laboratory.



Accredited by the Swiss Accreditation Service (SAS)

Accreditation No.: **SCS 108**

The Swiss Accreditation Service is one of the signatories to the EA  
 Multilateral Agreement for the recognition of calibration certificates

**Glossary:**

TSL	tissue simulating liquid
NORM <sub>x,y,z</sub>	sensitivity in free space
ConvF	sensitivity in TSL / NORM <sub>x,y,z</sub>
DCP	diode compression point
CF	crest factor (1/duty_cycle) of the RF signal
A, B, C, D	modulation dependent linearization parameters
Polarization $\phi$	$\phi$ rotation around probe axis
Polarization $\vartheta$	$\vartheta$ rotation around an axis that is in the plane normal to probe axis (at measurement center), i.e., $\vartheta = 0$ is normal to probe axis

**Calibration is Performed According to the Following Standards:**

- a) IEEE Std 1528-2003, "IEEE Recommended Practice for Determining the Peak Spatial-Averaged Specific Absorption Rate (SAR) in the Human Head from Wireless Communications Devices: Measurement Techniques", December 2003
- b) IEC 62209-1, "Procedure to measure the Specific Absorption Rate (SAR) for hand-held devices used in close proximity to the ear (frequency range of 300 MHz to 3 GHz)", February 2005

**Methods Applied and Interpretation of Parameters:**

- **NORM<sub>x,y,z</sub>**: Assessed for E-field polarization  $\vartheta = 0$  ( $f \leq 900$  MHz in TEM-cell;  $f > 1800$  MHz: R22 waveguide). NORM<sub>x,y,z</sub> are only intermediate values, i.e., the uncertainties of NORM<sub>x,y,z</sub> does not affect the E<sup>2</sup>-field uncertainty inside TSL (see below ConvF).
- **NORM(f)<sub>x,y,z</sub>** = NORM<sub>x,y,z</sub> \* frequency\_response (see Frequency Response Chart). This linearization is implemented in DASY4 software versions later than 4.2. The uncertainty of the frequency response is included in the stated uncertainty of ConvF.
- **DCP<sub>x,y,z</sub>**: DCP are numerical linearization parameters assessed based on the data of power sweep with CW signal (no uncertainty required). DCP does not depend on frequency nor media.
- **PAR**: PAR is the Peak to Average Ratio that is not calibrated but determined based on the signal characteristics
- **A<sub>x,y,z</sub>; B<sub>x,y,z</sub>; C<sub>x,y,z</sub>; D<sub>x,y,z</sub>; VR<sub>x,y,z</sub>; A, B, C, D** are numerical linearization parameters assessed based on the data of power sweep for specific modulation signal. The parameters do not depend on frequency nor media. VR is the maximum calibration range expressed in RMS voltage across the diode.
- **ConvF and Boundary Effect Parameters**: Assessed in flat phantom using E-field (or Temperature Transfer Standard for  $f \leq 800$  MHz) and inside waveguide using analytical field distributions based on power measurements for  $f > 800$  MHz. The same setups are used for assessment of the parameters applied for boundary compensation (alpha, depth) of which typical uncertainty values are given. These parameters are used in DASY4 software to improve probe accuracy close to the boundary. The sensitivity in TSL corresponds to NORM<sub>x,y,z</sub> \* ConvF whereby the uncertainty corresponds to that given for ConvF. A frequency dependent ConvF is used in DASY version 4.4 and higher which allows extending the validity from  $\pm 50$  MHz to  $\pm 100$  MHz.
- **Spherical isotropy (3D deviation from isotropy)**: in a field of low gradients realized using a flat phantom exposed by a patch antenna.
- **Sensor Offset**: The sensor offset corresponds to the offset of virtual measurement center from the probe tip (on probe axis). No tolerance required.

# Probe ES3DV3

## SN:3318

Manufactured: January 10, 2012  
Calibrated: April 29, 2013

**Calibrated for DASV/EASY Systems**  
(Note: non-compatible with DASV2 system!)

## DASY/EASY - Parameters of Probe: ES3DV3 - SN:3318

### Basic Calibration Parameters

	Sensor X	Sensor Y	Sensor Z	Unc (k=2)
Norm ( $\mu\text{V}/(\text{V}/\text{m})^2$ ) <sup>A</sup>	1.15	0.92	1.29	± 10.1 %
DCP (mV) <sup>B</sup>	102.6	105.4	100.8	

### Modulation Calibration Parameters

UID	Communication System Name		A dB	B dB/ $\mu\text{V}$	C	D dB	VR mV	Unc <sup>E</sup> (k=2)
0	CW	X	0.0	0.0	1.0	0.00	153.6	±3.5 %
		Y	0.0	0.0	1.0		133.8	
		Z	0.0	0.0	1.0		154.8	

The reported uncertainty of measurement is stated as the standard uncertainty of measurement multiplied by the coverage factor k=2, which for a normal distribution corresponds to a coverage probability of approximately 95%.

<sup>A</sup> The uncertainties of NormX,Y,Z do not affect the E<sup>2</sup>-field uncertainty inside TSL (see Pages 5 and 6).

<sup>B</sup> Numerical linearization parameter: uncertainty not required.

<sup>E</sup> Uncertainty is determined using the max. deviation from linear response applying rectangular distribution and is expressed for the square of the field value.

## DASY/EASY - Parameters of Probe: ES3DV3 - SN:3318

### Calibration Parameter Determined in Head Tissue Simulating Media

f (MHz) <sup>C</sup>	Relative Permittivity <sup>F</sup>	Conductivity (S/m) <sup>F</sup>	ConvF X	ConvF Y	ConvF Z	Alpha	Depth (mm)	Unct. (k=2)
750	41.9	0.89	6.59	6.59	6.59	0.25	2.12	± 12.0 %
850	41.5	0.92	6.33	6.33	6.33	0.57	1.25	± 12.0 %
1900	40.0	1.40	5.22	5.22	5.22	0.79	1.25	± 12.0 %
2450	39.2	1.80	4.59	4.59	4.59	0.80	1.30	± 12.0 %

<sup>C</sup> Frequency validity of ± 100 MHz only applies for DASY v4.4 and higher (see Page 2), else it is restricted to ± 50 MHz. The uncertainty is the RSS of the ConvF uncertainty at calibration frequency and the uncertainty for the indicated frequency band.

<sup>F</sup> At frequencies below 3 GHz, the validity of tissue parameters ( $\epsilon$  and  $\sigma$ ) can be relaxed to ± 10% if liquid compensation formula is applied to measured SAR values. At frequencies above 3 GHz, the validity of tissue parameters ( $\epsilon$  and  $\sigma$ ) is restricted to ± 5%. The uncertainty is the RSS of the ConvF uncertainty for indicated target tissue parameters.

## DASY/EASY - Parameters of Probe: ES3DV3 - SN:3318

### Calibration Parameter Determined in Body Tissue Simulating Media

f (MHz) <sup>C</sup>	Relative Permittivity <sup>F</sup>	Conductivity (S/m) <sup>F</sup>	ConvF X	ConvF Y	ConvF Z	Alpha	Depth (mm)	Unct. (k=2)
750	55.5	0.96	6.35	6.35	6.35	0.53	1.42	± 12.0 %
850	55.2	0.99	6.21	6.21	6.21	0.57	1.38	± 12.0 %
1900	53.3	1.52	4.79	4.79	4.79	0.46	1.77	± 12.0 %
2450	52.7	1.95	4.31	4.31	4.31	0.80	1.09	± 12.0 %

<sup>C</sup> Frequency validity of ± 100 MHz only applies for DASY v4.4 and higher (see Page 2), else it is restricted to ± 50 MHz. The uncertainty is the RSS of the ConvF uncertainty at calibration frequency and the uncertainty for the indicated frequency band.

<sup>F</sup> At frequencies below 3 GHz, the validity of tissue parameters ( $\epsilon$  and  $\sigma$ ) can be relaxed to ± 10% if liquid compensation formula is applied to measured SAR values. At frequencies above 3 GHz, the validity of tissue parameters ( $\epsilon$  and  $\sigma$ ) is restricted to ± 5%. The uncertainty is the RSS of the ConvF uncertainty for indicated target tissue parameters.

### Frequency Response of E-Field (TEM-Cell:ifi110 EXX, Waveguide: R22)

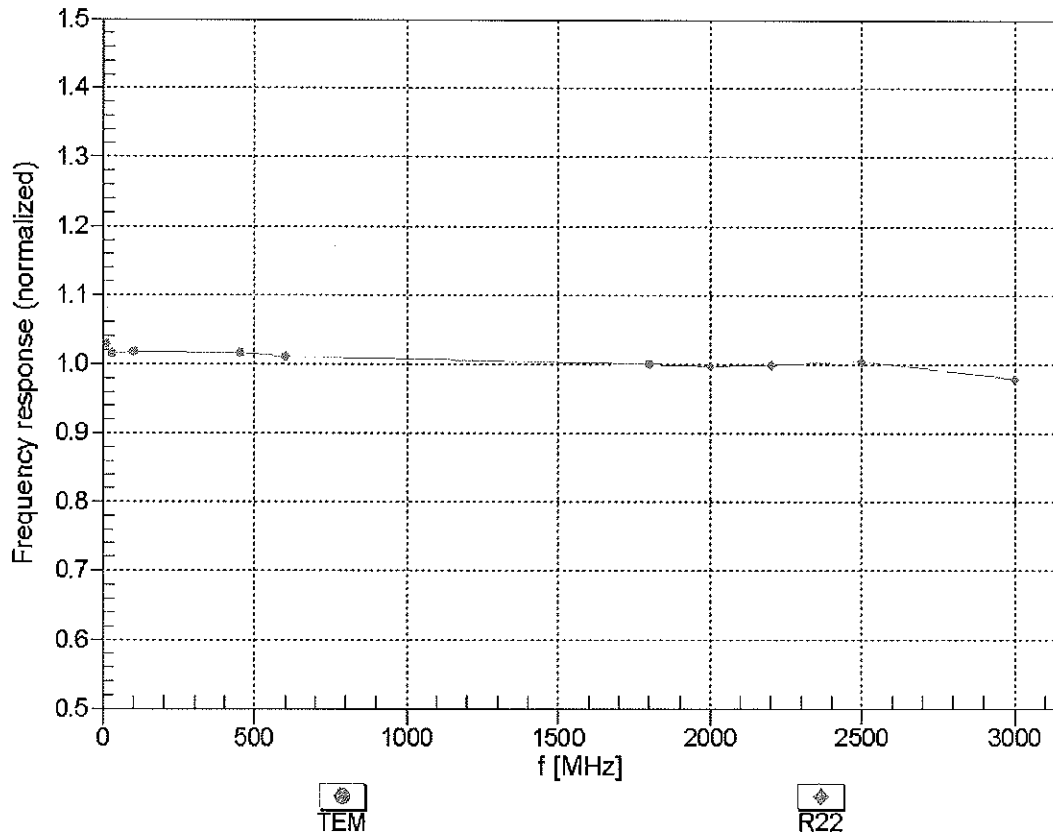

Uncertainty of Frequency Response of E-field:  $\pm 6.3\%$  (k=2)

### Receiving Pattern ( $\phi$ ), $\theta = 0^\circ$

f=600 MHz,TEM

f=1800 MHz,R22

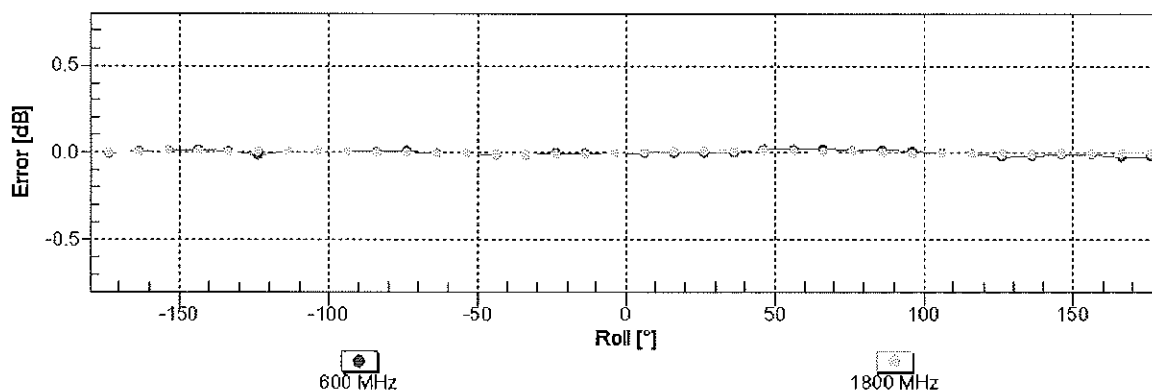
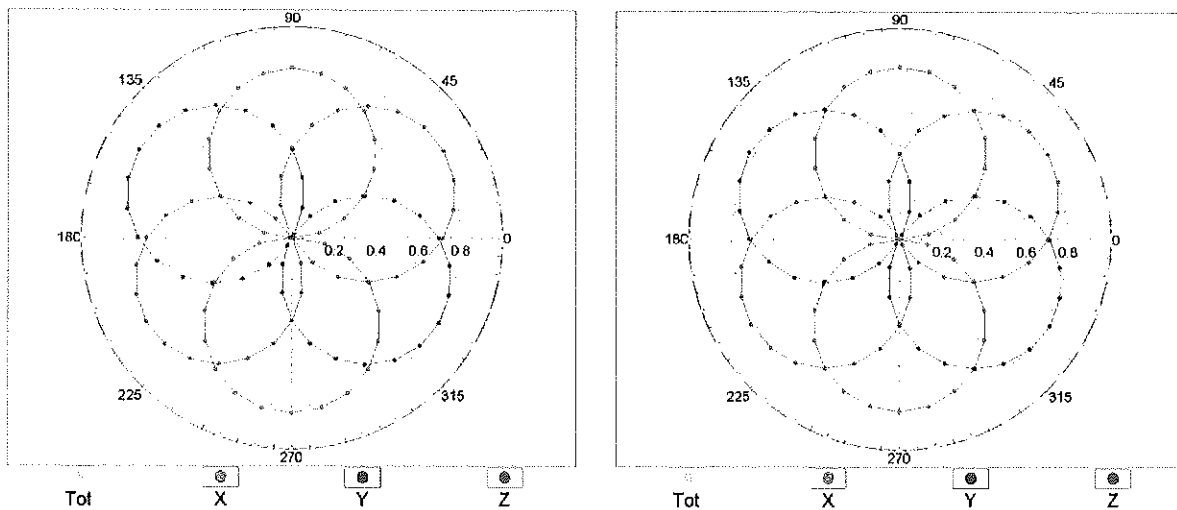

Uncertainty of Axial Isotropy Assessment:  $\pm 0.5\%$  ( $k=2$ )

### Dynamic Range $f(\text{SAR}_{\text{head}})$ (TEM cell , $f = 900 \text{ MHz}$ )

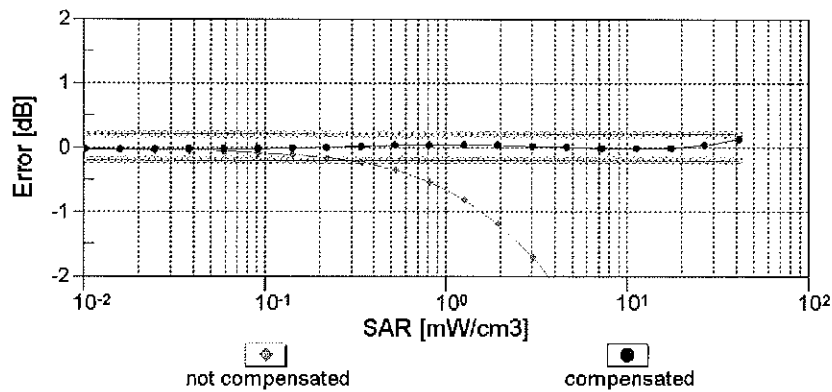
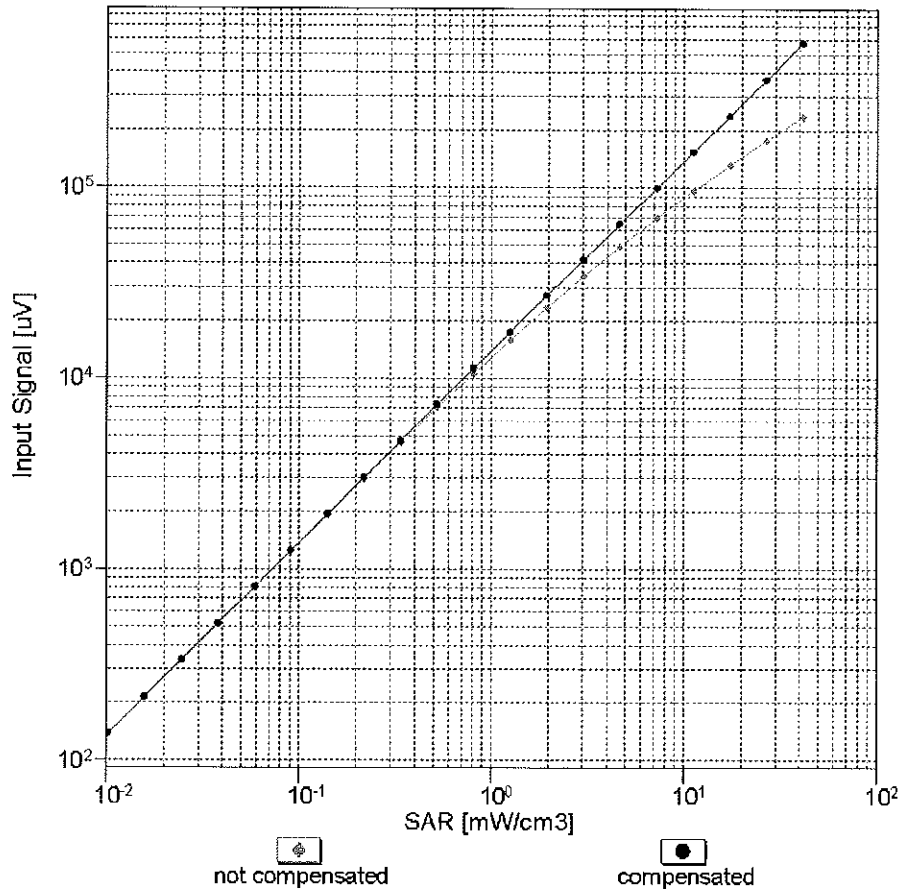

Uncertainty of Linearity Assessment:  $\pm 0.6\%$  ( $k=2$ )

# Conversion Factor Assessment

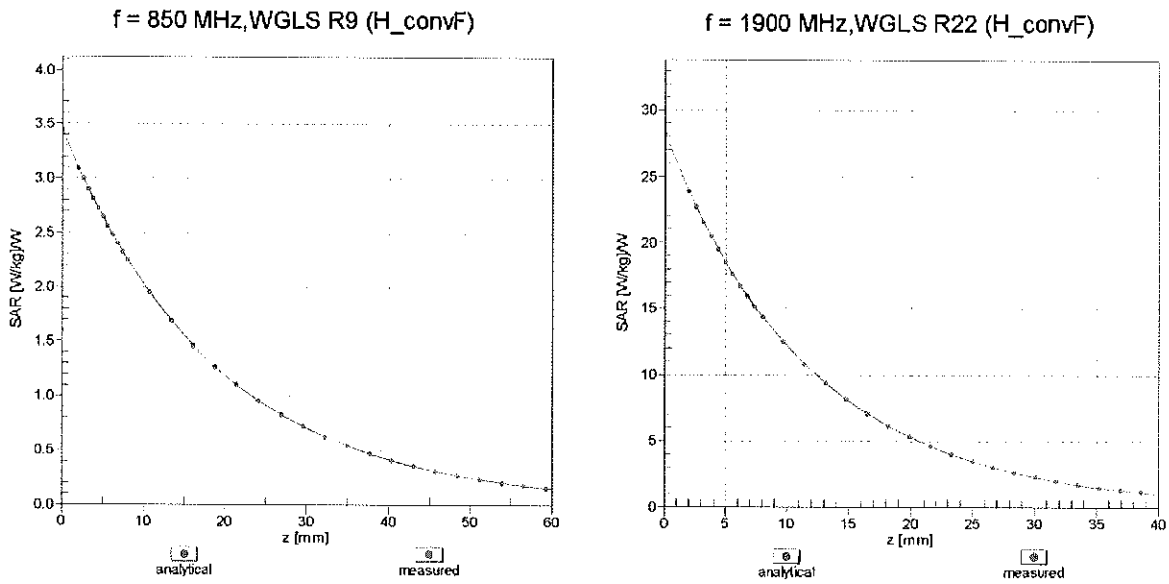

## Deviation from Isotropy in Liquid Error ( $\phi, \theta$ ), f = 900 MHz

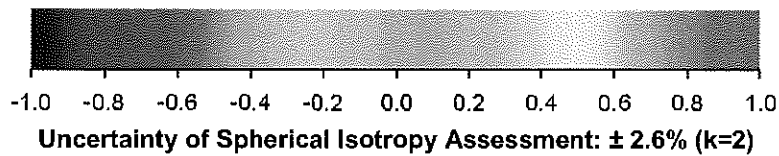
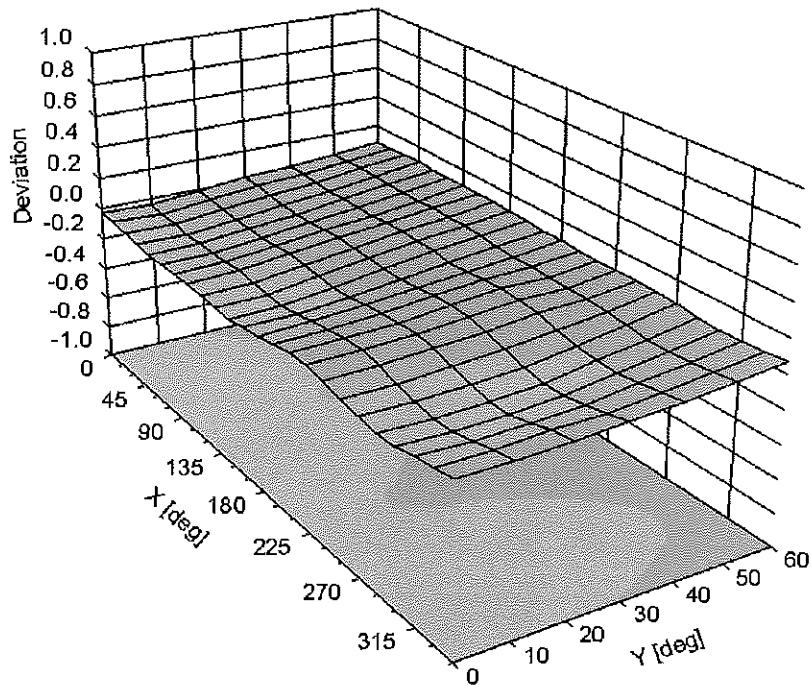

## DASY/EASY - Parameters of Probe: ES3DV3 - SN:3318

### Other Probe Parameters

Sensor Arrangement	Triangular
Connector Angle (°)	-103.8
Mechanical Surface Detection Mode	enabled
Optical Surface Detection Mode	disabled
Probe Overall Length	337 mm
Probe Body Diameter	10 mm
Tip Length	10 mm
Tip Diameter	4 mm
Probe Tip to Sensor X Calibration Point	2 mm
Probe Tip to Sensor Y Calibration Point	2 mm
Probe Tip to Sensor Z Calibration Point	2 mm
Recommended Measurement Distance from Surface	3 mm

## Additional Conversion Factors for Dosimetric E-Field Probe

Type:	<b>ES3DV3</b>
Serial Number:	<b>3318</b>
Place of Assessment:	<b>Zurich</b>
Date of Assessment:	<b>June 19, 2013</b>
Probe Calibration Date:	<b>April 29, 2013</b>

✓  
Kox  
6/25/13

Schmid & Partner Engineering AG hereby certifies that conversion factor(s) of this probe have been evaluated on the date indicated above. The assessment was performed using the FDTD numerical code SEMCAD of Schmid & Partner Engineering AG. The evaluation is coupled with measured conversion factors (probe calibration date indicated above). The uncertainty of the numerical assessment is based on the extrapolation from measured value at 835 MHz or at 1900 MHz.

Assessed by: 

## Dosimetric E-Field Probe ES3DV3 SN:3318

Conversion factor ( $\pm$  standard deviation)

1750  $\pm$  50 MHz      *ConvF*      5.59  $\pm$  7%

$\epsilon_r = 40.1 \pm 5\%$   
 $\sigma = 1.37 \pm 5\%$  mho/m  
(head tissue)

1750  $\pm$  50 MHz      *ConvF*      5.22  $\pm$  7%

$\epsilon_r = 53.4 \pm 5\%$   
 $\sigma = 1.49 \pm 5\%$  mho/m  
(body tissue)

### Important Note:

For numerically assessed probe conversion factors, parameters Alpha and Delta in the DASY software must have the following entries: Alpha = 0 and Delta = 1.

**Please see also DASY Manual.**



Accredited by the Swiss Accreditation Service (SAS)  
The Swiss Accreditation Service is one of the signatories to the EA  
Multilateral Agreement for the recognition of calibration certificates

Accreditation No.: **SCS 108**

Client **PC Test**

Certificate No: **ES3-3209\_Mar13**

**CALIBRATION CERTIFICATE**

Object **ES3DV3 - SN:3209**

Calibration procedure(s) **QA CAL-01.v8, QA CAL-23.v4, QA CAL-25.v4  
Calibration procedure for dosimetric E-field probes**

Calibration date: **March 15, 2013**

This calibration certificate documents the traceability to national standards, which realize the physical units of measurements (SI).  
The measurements and the uncertainties with confidence probability are given on the following pages and are part of the certificate.

All calibrations have been conducted in the closed laboratory facility: environment temperature (22 ± 3)°C and humidity < 70%.

*✓ KOK 3/22/13*

Calibration Equipment used (M&TE critical for calibration)

Primary Standards	ID	Cal Date (Certificate No.)	Scheduled Calibration
Power meter E4419B	GB41293874	29-Mar-12 (No. 217-01508)	Apr-13
Power sensor E4412A	MY41498087	29-Mar-12 (No. 217-01508)	Apr-13
Reference 3 dB Attenuator	SN: S5054 (3c)	27-Mar-12 (No. 217-01531)	Apr-13
Reference 20 dB Attenuator	SN: S5086 (20b)	27-Mar-12 (No. 217-01529)	Apr-13
Reference 30 dB Attenuator	SN: S5129 (30b)	27-Mar-12 (No. 217-01532)	Apr-13
Reference Probe ES3DV2	SN: 3013	28-Dec-12 (No. ES3-3013_Dec12)	Dec-13
DAE4	SN: 660	31-Jan-13 (No. DAE4-660_Jan13)	Jan-14
Secondary Standards	ID	Check Date (in house)	Scheduled Check
RF generator HP 8648C	US3642U01700	4-Aug-99 (in house check Apr-11)	In house check: Apr-13
Network Analyzer HP 8753E	US37390585	18-Oct-01 (in house check Oct-12)	In house check: Oct-13

	Name	Function	Signature
Calibrated by:	Israe El-Naouq	Laboratory Technician	<i>Israe El-Naouq</i>
Approved by:	Katja Pokovic	Technical Manager	<i>Katja Pokovic</i>

Issued: March 15, 2013

This calibration certificate shall not be reproduced except in full without written approval of the laboratory.

80242



Accredited by the Swiss Accreditation Service (SAS)

Accreditation No.: **SCS 108**

The Swiss Accreditation Service is one of the signatories to the EA Multilateral Agreement for the recognition of calibration certificates

### Glossary:

TSL	tissue simulating liquid
NORM <sub>x,y,z</sub>	sensitivity in free space
ConvF	sensitivity in TSL / NORM <sub>x,y,z</sub>
DCP	diode compression point
CF	crest factor (1/duty_cycle) of the RF signal
A, B, C, D	modulation dependent linearization parameters
Polarization $\varphi$	$\varphi$ rotation around probe axis
Polarization $\vartheta$	$\vartheta$ rotation around an axis that is in the plane normal to probe axis (at measurement center), i.e., $\vartheta = 0$ is normal to probe axis

### Calibration is Performed According to the Following Standards:

- IEEE Std 1528-2003, "IEEE Recommended Practice for Determining the Peak Spatial-Averaged Specific Absorption Rate (SAR) in the Human Head from Wireless Communications Devices: Measurement Techniques", December 2003
- IEC 62209-1, "Procedure to measure the Specific Absorption Rate (SAR) for hand-held devices used in close proximity to the ear (frequency range of 300 MHz to 3 GHz)", February 2005

### Methods Applied and Interpretation of Parameters:

- NORM<sub>x,y,z</sub>**: Assessed for E-field polarization  $\vartheta = 0$  ( $f \leq 900$  MHz in TEM-cell;  $f > 1800$  MHz: R22 waveguide). NORM<sub>x,y,z</sub> are only intermediate values, i.e., the uncertainties of NORM<sub>x,y,z</sub> does not affect the E<sup>2</sup>-field uncertainty inside TSL (see below ConvF).
- NORM(f)<sub>x,y,z</sub>** = NORM<sub>x,y,z</sub> \* frequency\_response (see Frequency Response Chart). This linearization is implemented in DASY4 software versions later than 4.2. The uncertainty of the frequency response is included in the stated uncertainty of ConvF.
- DCP<sub>x,y,z</sub>**: DCP are numerical linearization parameters assessed based on the data of power sweep with CW signal (no uncertainty required). DCP does not depend on frequency nor media.
- PAR**: PAR is the Peak to Average Ratio that is not calibrated but determined based on the signal characteristics
- A<sub>x,y,z</sub>; B<sub>x,y,z</sub>; C<sub>x,y,z</sub>; D<sub>x,y,z</sub>; VR<sub>x,y,z</sub>; A, B, C, D** are numerical linearization parameters assessed based on the data of power sweep for specific modulation signal. The parameters do not depend on frequency nor media. VR is the maximum calibration range expressed in RMS voltage across the diode.
- ConvF and Boundary Effect Parameters**: Assessed in flat phantom using E-field (or Temperature Transfer Standard for  $f \leq 800$  MHz) and inside waveguide using analytical field distributions based on power measurements for  $f > 800$  MHz. The same setups are used for assessment of the parameters applied for boundary compensation (alpha, depth) of which typical uncertainty values are given. These parameters are used in DASY4 software to improve probe accuracy close to the boundary. The sensitivity in TSL corresponds to NORM<sub>x,y,z</sub> \* ConvF whereby the uncertainty corresponds to that given for ConvF. A frequency dependent ConvF is used in DASY version 4.4 and higher which allows extending the validity from  $\pm 50$  MHz to  $\pm 100$  MHz.
- Spherical isotropy (3D deviation from isotropy)**: in a field of low gradients realized using a flat phantom exposed by a patch antenna.
- Sensor Offset**: The sensor offset corresponds to the offset of virtual measurement center from the probe tip (on probe axis). No tolerance required.

# Probe ES3DV3

## SN:3209

Manufactured: October 14, 2008  
Calibrated: March 15, 2013

Calibrated for DASY/EASY Systems  
(Note: non-compatible with DASY2 system!)

## DASY/EASY - Parameters of Probe: ES3DV3 - SN:3209

### Basic Calibration Parameters

	Sensor X	Sensor Y	Sensor Z	Unc (k=2)
Norm ( $\mu\text{V}/(\text{V}/\text{m})^2$ ) <sup>A</sup>	1.35	1.33	1.14	$\pm 10.1 \%$
DCP (mV) <sup>B</sup>	99.2	97.8	98.3	

### Modulation Calibration Parameters

UID	Communication System Name		A dB	B dB $\sqrt{\mu\text{V}}$	C	D dB	VR mV	Unc <sup>E</sup> (k=2)
0	CW	X	0.0	0.0	1.0	0.00	163.6	$\pm 3.5 \%$
		Y	0.0	0.0	1.0		170.3	
		Z	0.0	0.0	1.0		158.7	

The reported uncertainty of measurement is stated as the standard uncertainty of measurement multiplied by the coverage factor  $k=2$ , which for a normal distribution corresponds to a coverage probability of approximately 95%.

<sup>A</sup> The uncertainties of NormX,Y,Z do not affect the  $E^2$ -field uncertainty inside TSL (see Pages 5 and 6).

<sup>B</sup> Numerical linearization parameter: uncertainty not required.

<sup>E</sup> Uncertainty is determined using the max. deviation from linear response applying rectangular distribution and is expressed for the square of the field value.

## DASY/EASY - Parameters of Probe: ES3DV3 - SN:3209

### Calibration Parameter Determined in Head Tissue Simulating Media

f (MHz) <sup>C</sup>	Relative Permittivity <sup>F</sup>	Conductivity (S/m) <sup>F</sup>	ConvF X	ConvF Y	ConvF Z	Alpha	Depth (mm)	Unct. (k=2)
750	41.9	0.89	6.74	6.74	6.74	0.76	1.18	± 12.0 %
835	41.5	0.90	6.46	6.46	6.46	0.31	1.81	± 12.0 %
1750	40.1	1.37	5.39	5.39	5.39	0.80	1.21	± 12.0 %
1900	40.0	1.40	5.21	5.21	5.21	0.78	1.26	± 12.0 %
2450	39.2	1.80	4.57	4.57	4.57	0.65	1.43	± 12.0 %
2600	39.0	1.96	4.43	4.43	4.43	0.75	1.36	± 12.0 %

<sup>C</sup> Frequency validity of ± 100 MHz only applies for DASY v4.4 and higher (see Page 2), else it is restricted to ± 50 MHz. The uncertainty is the RSS of the ConvF uncertainty at calibration frequency and the uncertainty for the indicated frequency band.

<sup>F</sup> At frequencies below 3 GHz, the validity of tissue parameters ( $\epsilon$  and  $\sigma$ ) can be relaxed to ± 10% if liquid compensation formula is applied to measured SAR values. At frequencies above 3 GHz, the validity of tissue parameters ( $\epsilon$  and  $\sigma$ ) is restricted to ± 5%. The uncertainty is the RSS of the ConvF uncertainty for indicated target tissue parameters.

## DASY/EASY - Parameters of Probe: ES3DV3 - SN:3209

### Calibration Parameter Determined in Body Tissue Simulating Media

f (MHz) <sup>C</sup>	Relative Permittivity <sup>F</sup>	Conductivity (S/m) <sup>F</sup>	ConvF X	ConvF Y	ConvF Z	Alpha	Depth (mm)	Unct. (k=2)
750	55.5	0.96	6.38	6.38	6.38	0.80	1.16	± 12.0 %
835	55.2	0.97	6.28	6.28	6.28	0.52	1.45	± 12.0 %
1750	53.4	1.49	5.03	5.03	5.03	0.58	1.45	± 12.0 %
1900	53.3	1.52	4.77	4.77	4.77	0.70	1.36	± 12.0 %
2450	52.7	1.95	4.34	4.34	4.34	0.80	1.15	± 12.0 %
2600	52.5	2.16	4.11	4.11	4.11	0.80	1.00	± 12.0 %

<sup>C</sup> Frequency validity of ± 100 MHz only applies for DASY v4.4 and higher (see Page 2), else it is restricted to ± 50 MHz. The uncertainty is the RSS of the ConvF uncertainty at calibration frequency and the uncertainty for the indicated frequency band.

<sup>F</sup> At frequencies below 3 GHz, the validity of tissue parameters ( $\epsilon$  and  $\sigma$ ) can be relaxed to ± 10% if liquid compensation formula is applied to measured SAR values. At frequencies above 3 GHz, the validity of tissue parameters ( $\epsilon$  and  $\sigma$ ) is restricted to ± 5%. The uncertainty is the RSS of the ConvF uncertainty for indicated target tissue parameters.

# Frequency Response of E-Field (TEM-Cell:ifi110 EXX, Waveguide: R22)

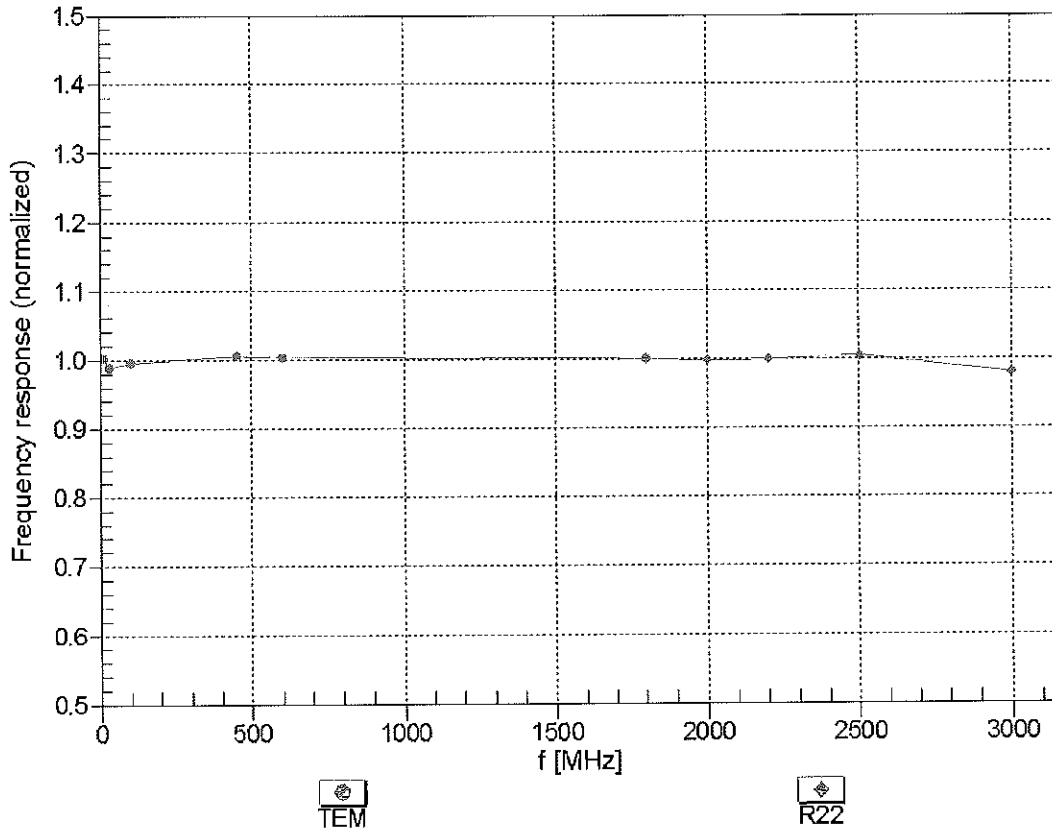

Uncertainty of Frequency Response of E-field:  $\pm 6.3\%$  (k=2)

### Receiving Pattern ( $\phi$ ), $\theta = 0^\circ$

f=600 MHz,TEM

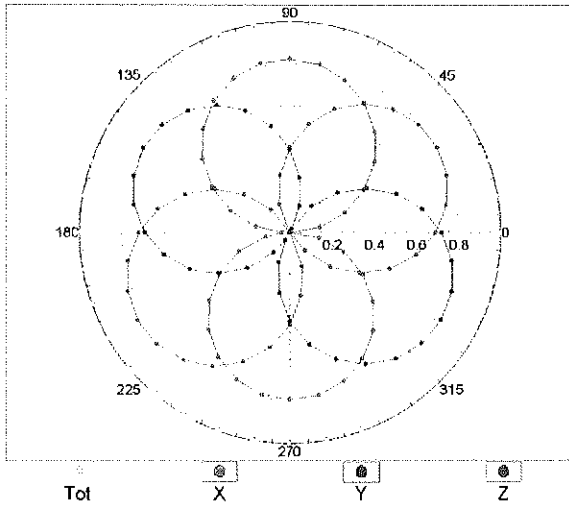

f=1800 MHz,R22

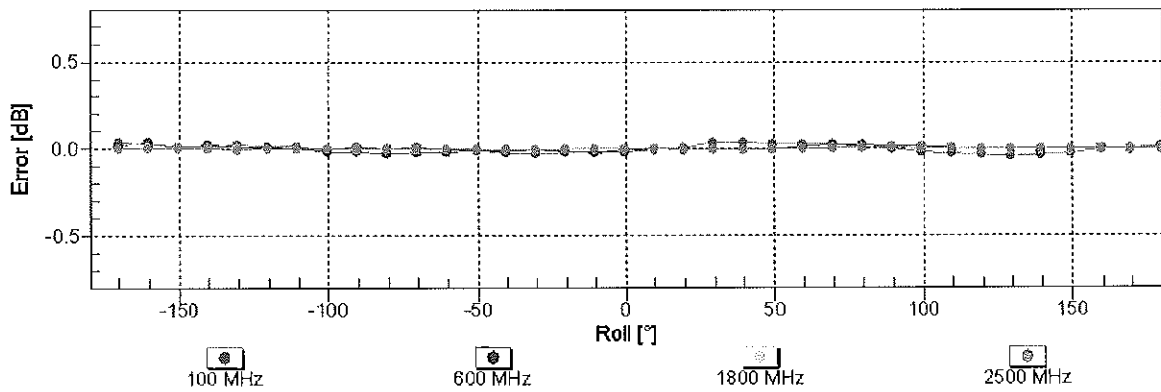
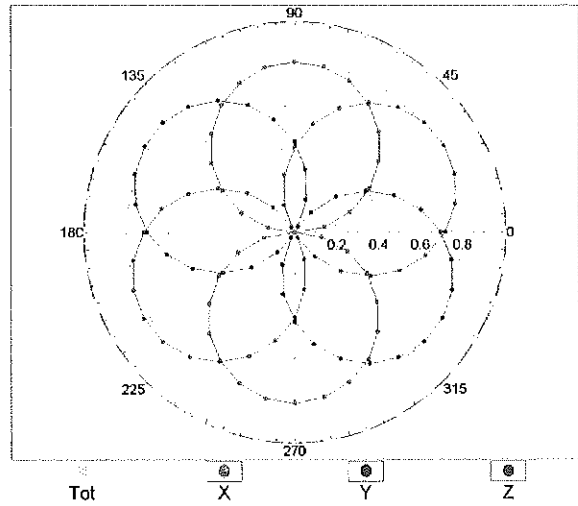

Uncertainty of Axial Isotropy Assessment:  $\pm 0.5\%$  (k=2)

### Dynamic Range $f(SAR_{head})$ (TEM cell , $f = 900$ MHz)

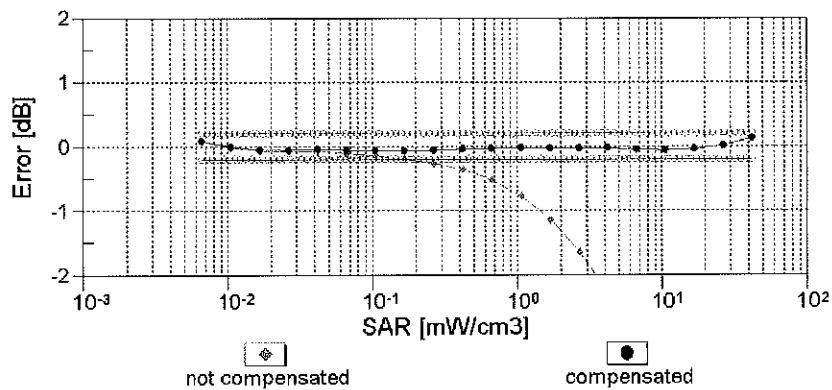
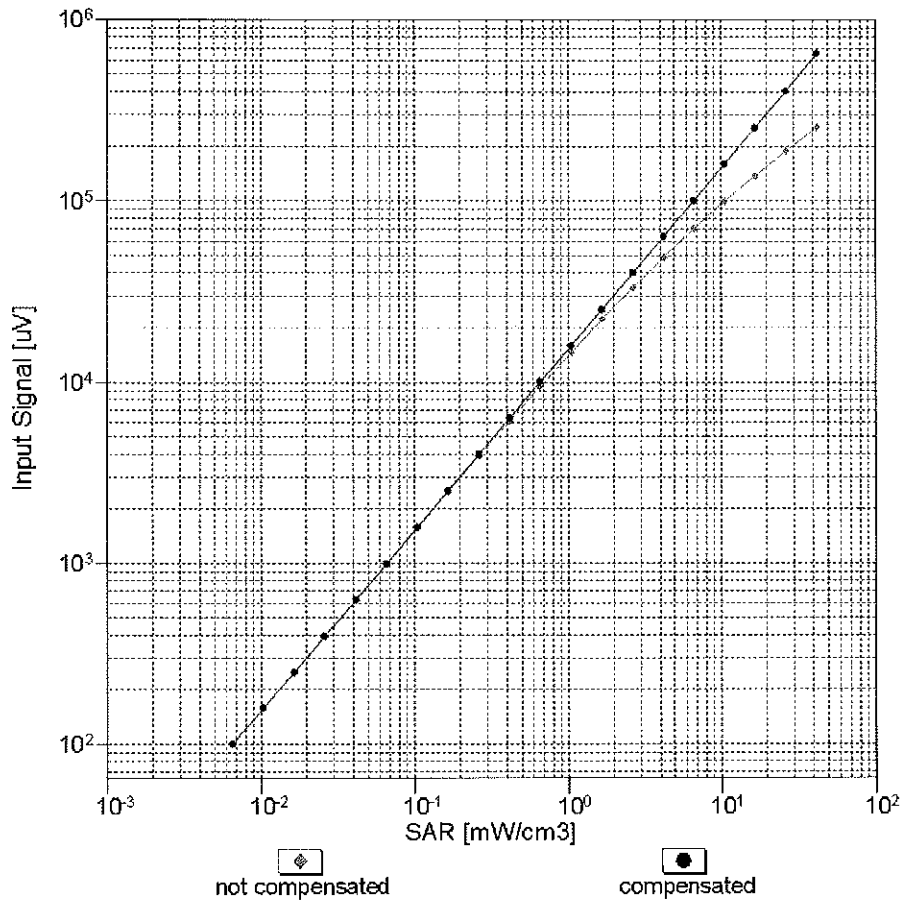

Uncertainty of Linearity Assessment:  $\pm 0.6\%$  ( $k=2$ )

# Conversion Factor Assessment

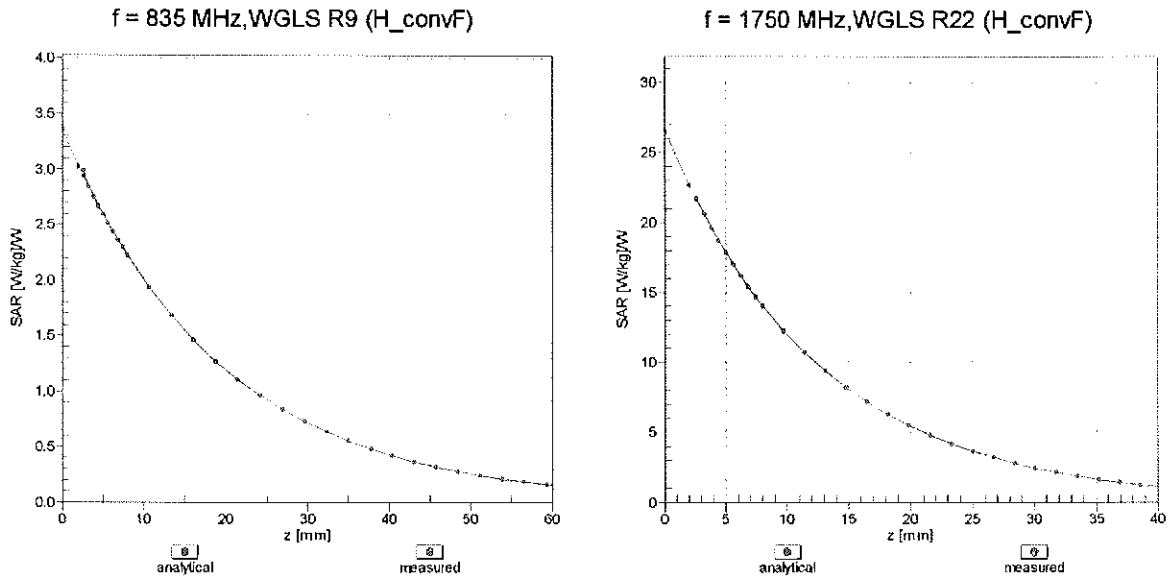

## Deviation from Isotropy in Liquid Error ( $\phi, \theta$ ), f = 900 MHz

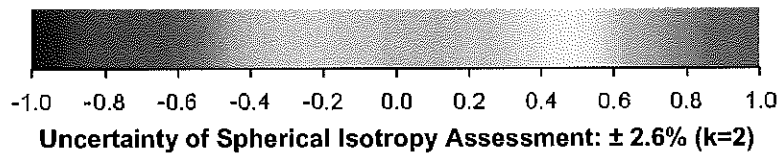
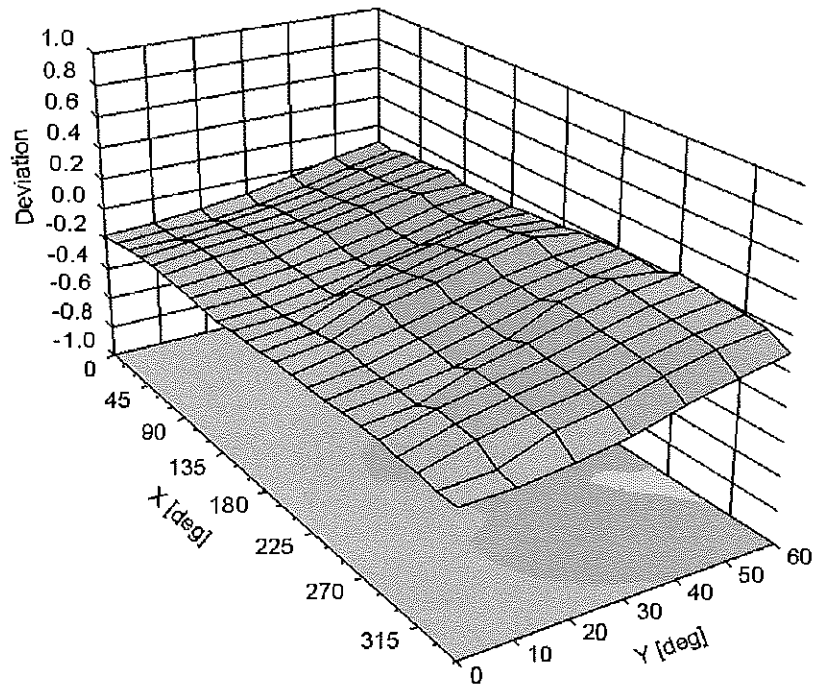

## DASY/EASY - Parameters of Probe: ES3DV3 - SN:3209

### Other Probe Parameters

Sensor Arrangement	Triangular
Connector Angle (°)	-40.6
Mechanical Surface Detection Mode	enabled
Optical Surface Detection Mode	disabled
Probe Overall Length	337 mm
Probe Body Diameter	10 mm
Tip Length	10 mm
Tip Diameter	4 mm
Probe Tip to Sensor X Calibration Point	2 mm
Probe Tip to Sensor Y Calibration Point	2 mm
Probe Tip to Sensor Z Calibration Point	2 mm
Recommended Measurement Distance from Surface	3 mm



Accredited by the Swiss Accreditation Service (SAS)  
The Swiss Accreditation Service is one of the signatories to the EA  
Multilateral Agreement for the recognition of calibration certificates

Accreditation No.: **SCS 108**

Client **PC Test**

Certificate No: **ES3-3263\_May13**

## CALIBRATION CERTIFICATE

Object **ES3DV3 - SN:3263**

Calibration procedure(s) **QA CAL-01.v8, QA CAL-23.v4, QA CAL-25.v4  
Calibration procedure for dosimetric E-field probes**

Calibration date: **May 16, 2013**

*✓ KOK  
5/23/13*

This calibration certificate documents the traceability to national standards, which realize the physical units of measurements (SI).  
The measurements and the uncertainties with confidence probability are given on the following pages and are part of the certificate.

All calibrations have been conducted in the closed laboratory facility: environment temperature (22 ± 3)°C and humidity < 70%.

Calibration Equipment used (M&TE critical for calibration)

Primary Standards	ID	Cal Date (Certificate No.)	Scheduled Calibration
Power meter E4419B	GB41293874	04-Apr-13 (No. 217-01733)	Apr-14
Power sensor E4412A	MY41498087	04-Apr-13 (No. 217-01733)	Apr-14
Reference 3 dB Attenuator	SN: S5054 (3c)	04-Apr-13 (No. 217-01737)	Apr-14
Reference 20 dB Attenuator	SN: S5277 (20x)	04-Apr-13 (No. 217-01735)	Apr-14
Reference 30 dB Attenuator	SN: S5129 (30b)	04-Apr-13 (No. 217-01738)	Apr-14
Reference Probe ES3DV2	SN: 3013	28-Dec-12 (No. ES3-3013_Dec12)	Dec-13
DAE4	SN: 660	31-Jan-13 (No. DAE4-660_Jan13)	Jan-14
Secondary Standards	ID	Check Date (in house)	Scheduled Check
RF generator HP 8648C	US3642U01700	4-Aug-99 (in house check Apr-13)	In house check: Apr-15
Network Analyzer HP 8753E	US37390585	18-Oct-01 (in house check Oct-12)	In house check: Oct-13

	Name	Function	Signature
Calibrated by:	Leif Klysner	Laboratory Technician	<i>Leif Klysner</i>
Approved by:	Katja Pokovic	Technical Manager	<i>Katja Pokovic</i>
			Issued: May 17, 2013

This calibration certificate shall not be reproduced except in full without written approval of the laboratory.



Accredited by the Swiss Accreditation Service (SAS)

Accreditation No.: **SCS 108**

The Swiss Accreditation Service is one of the signatories to the EA  
Multilateral Agreement for the recognition of calibration certificates

### Glossary:

TSL	tissue simulating liquid
NORM <sub>x,y,z</sub>	sensitivity in free space
ConvF	sensitivity in TSL / NORM <sub>x,y,z</sub>
DCP	diode compression point
CF	crest factor (1/duty_cycle) of the RF signal
A, B, C, D	modulation dependent linearization parameters
Polarization $\varphi$	$\varphi$ rotation around probe axis
Polarization $\vartheta$	$\vartheta$ rotation around an axis that is in the plane normal to probe axis (at measurement center), i.e., $\vartheta = 0$ is normal to probe axis

### Calibration is Performed According to the Following Standards:

- IEEE Std 1528-2003, "IEEE Recommended Practice for Determining the Peak Spatial-Averaged Specific Absorption Rate (SAR) in the Human Head from Wireless Communications Devices: Measurement Techniques", December 2003
- IEC 62209-1, "Procedure to measure the Specific Absorption Rate (SAR) for hand-held devices used in close proximity to the ear (frequency range of 300 MHz to 3 GHz)", February 2005

### Methods Applied and Interpretation of Parameters:

- NORM<sub>x,y,z</sub>**: Assessed for E-field polarization  $\vartheta = 0$  ( $f \leq 900$  MHz in TEM-cell;  $f > 1800$  MHz: R22 waveguide). NORM<sub>x,y,z</sub> are only intermediate values, i.e., the uncertainties of NORM<sub>x,y,z</sub> does not affect the E<sup>2</sup>-field uncertainty inside TSL (see below ConvF).
- NORM(f)<sub>x,y,z</sub>** = NORM<sub>x,y,z</sub> \* frequency\_response (see Frequency Response Chart). This linearization is implemented in DASY4 software versions later than 4.2. The uncertainty of the frequency response is included in the stated uncertainty of ConvF.
- DCP<sub>x,y,z</sub>**: DCP are numerical linearization parameters assessed based on the data of power sweep with CW signal (no uncertainty required). DCP does not depend on frequency nor media.
- PAR**: PAR is the Peak to Average Ratio that is not calibrated but determined based on the signal characteristics
- A<sub>x,y,z</sub>; B<sub>x,y,z</sub>; C<sub>x,y,z</sub>; D<sub>x,y,z</sub>; VR<sub>x,y,z</sub>**: A, B, C, D are numerical linearization parameters assessed based on the data of power sweep for specific modulation signal. The parameters do not depend on frequency nor media. VR is the maximum calibration range expressed in RMS voltage across the diode.
- ConvF and Boundary Effect Parameters**: Assessed in flat phantom using E-field (or Temperature Transfer Standard for  $f \leq 800$  MHz) and inside waveguide using analytical field distributions based on power measurements for  $f > 800$  MHz. The same setups are used for assessment of the parameters applied for boundary compensation (alpha, depth) of which typical uncertainty values are given. These parameters are used in DASY4 software to improve probe accuracy close to the boundary. The sensitivity in TSL corresponds to NORM<sub>x,y,z</sub> \* ConvF whereby the uncertainty corresponds to that given for ConvF. A frequency dependent ConvF is used in DASY version 4.4 and higher which allows extending the validity from  $\pm 50$  MHz to  $\pm 100$  MHz.
- Spherical isotropy (3D deviation from isotropy)**: in a field of low gradients realized using a flat phantom exposed by a patch antenna.
- Sensor Offset**: The sensor offset corresponds to the offset of virtual measurement center from the probe tip (on probe axis). No tolerance required.

# Probe ES3DV3

## SN:3263

Manufactured: January 25, 2010  
Calibrated: May 16, 2013

Calibrated for DASY/EASY Systems  
(Note: non-compatible with DASY2 system!)

## DASY/EASY - Parameters of Probe: ES3DV3 - SN:3263

### Basic Calibration Parameters

	Sensor X	Sensor Y	Sensor Z	Unc (k=2)
Norm ( $\mu\text{V}/(\text{V}/\text{m})^2$ ) <sup>A</sup>	1.21	1.25	1.12	$\pm 10.1 \%$
DCP (mV) <sup>B</sup>	101.2	100.2	103.7	

### Modulation Calibration Parameters

UID	Communication System Name		A dB	B dB $\sqrt{\mu\text{V}}$	C	D dB	VR mV	Unc <sup>E</sup> (k=2)
0	CW	X	0.0	0.0	1.0	0.00	156.5	$\pm 2.5 \%$
		Y	0.0	0.0	1.0		153.2	
		Z	0.0	0.0	1.0		147.2	

The reported uncertainty of measurement is stated as the standard uncertainty of measurement multiplied by the coverage factor  $k=2$ , which for a normal distribution corresponds to a coverage probability of approximately 95%.

<sup>A</sup> The uncertainties of NormX,Y,Z do not affect the  $E^2$ -field uncertainty inside TSL (see Pages 5 and 6).

<sup>B</sup> Numerical linearization parameter: uncertainty not required.

<sup>E</sup> Uncertainty is determined using the max. deviation from linear response applying rectangular distribution and is expressed for the square of the field value.

## DASY/EASY - Parameters of Probe: ES3DV3 - SN:3263

### Calibration Parameter Determined in Head Tissue Simulating Media

f (MHz) <sup>C</sup>	Relative Permittivity <sup>F</sup>	Conductivity (S/m) <sup>F</sup>	ConvF X	ConvF Y	ConvF Z	Alpha	Depth (mm)	Unct. (k=2)
750	41.9	0.89	6.51	6.51	6.51	0.21	2.29	± 12.0 %
835	41.5	0.90	6.29	6.29	6.29	0.50	1.38	± 12.0 %
1750	40.1	1.37	5.30	5.30	5.30	0.45	1.54	± 12.0 %
1900	40.0	1.40	5.11	5.11	5.11	0.57	1.38	± 12.0 %
2450	39.2	1.80	4.47	4.47	4.47	0.59	1.49	± 12.0 %
2600	39.0	1.96	4.31	4.31	4.31	0.80	1.28	± 12.0 %

<sup>C</sup> Frequency validity of ± 100 MHz only applies for DASY v4.4 and higher (see Page 2), else it is restricted to ± 50 MHz. The uncertainty is the RSS of the ConvF uncertainty at calibration frequency and the uncertainty for the indicated frequency band.

<sup>F</sup> At frequencies below 3 GHz, the validity of tissue parameters ( $\epsilon$  and  $\sigma$ ) can be relaxed to ± 10% if liquid compensation formula is applied to measured SAR values. At frequencies above 3 GHz, the validity of tissue parameters ( $\epsilon$  and  $\sigma$ ) is restricted to ± 5%. The uncertainty is the RSS of the ConvF uncertainty for indicated target tissue parameters.

## DASY/EASY - Parameters of Probe: ES3DV3 - SN:3263

### Calibration Parameter Determined in Body Tissue Simulating Media

f (MHz) <sup>C</sup>	Relative Permittivity <sup>F</sup>	Conductivity (S/m) <sup>F</sup>	ConvF X	ConvF Y	ConvF Z	Alpha	Depth (mm)	Unct. (k=2)
750	55.5	0.96	6.37	6.37	6.37	0.34	1.82	± 12.0 %
835	55.2	0.97	6.29	6.29	6.29	0.54	1.39	± 12.0 %
1750	53.4	1.49	5.01	5.01	5.01	0.72	1.27	± 12.0 %
1900	53.3	1.52	4.78	4.78	4.78	0.53	1.56	± 12.0 %
2450	52.7	1.95	4.33	4.33	4.33	0.80	1.14	± 12.0 %
2600	52.5	2.16	4.14	4.14	4.14	0.80	1.02	± 12.0 %

<sup>C</sup> Frequency validity of ± 100 MHz only applies for DASY v4.4 and higher (see Page 2), else it is restricted to ± 50 MHz. The uncertainty is the RSS of the ConvF uncertainty at calibration frequency and the uncertainty for the indicated frequency band.

<sup>F</sup> At frequencies below 3 GHz, the validity of tissue parameters ( $\epsilon$  and  $\sigma$ ) can be relaxed to ± 10% if liquid compensation formula is applied to measured SAR values. At frequencies above 3 GHz, the validity of tissue parameters ( $\epsilon$  and  $\sigma$ ) is restricted to ± 5%. The uncertainty is the RSS of the ConvF uncertainty for indicated target tissue parameters.

### Frequency Response of E-Field (TEM-Cell:ifi110 EXX, Waveguide: R22)

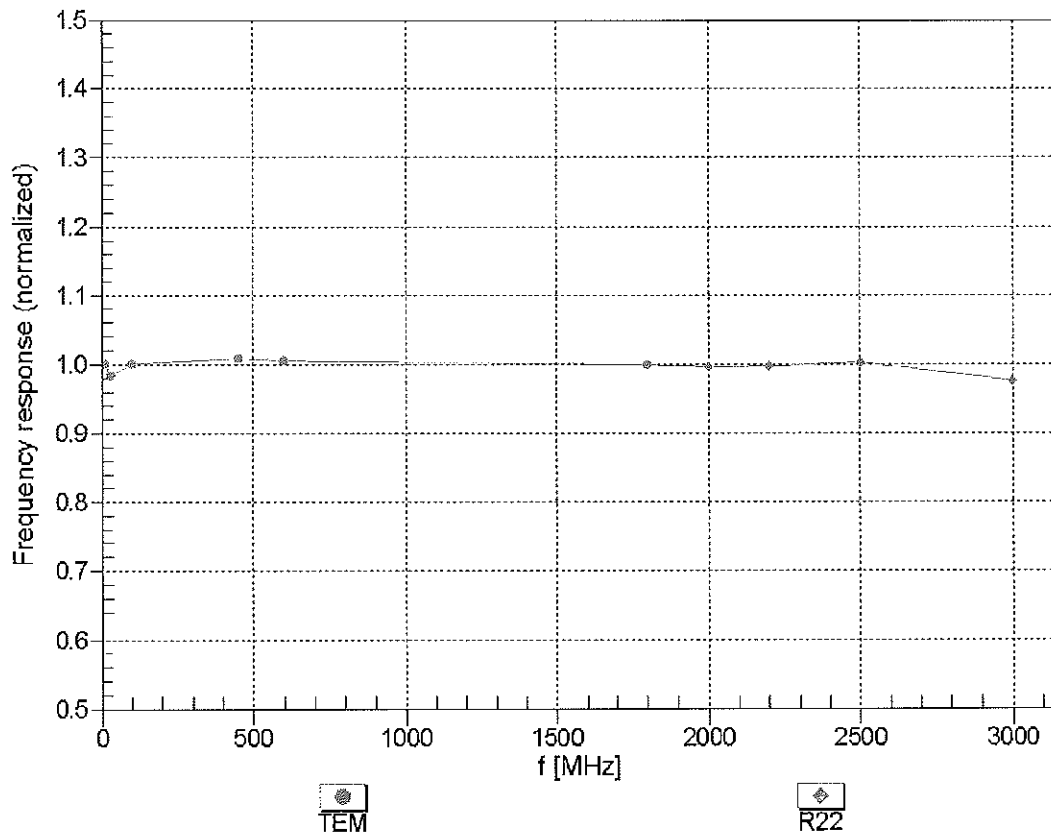

Uncertainty of Frequency Response of E-field:  $\pm 6.3\%$  (k=2)

### Receiving Pattern ( $\phi$ ), $\theta = 0^\circ$

f=600 MHz,TEM

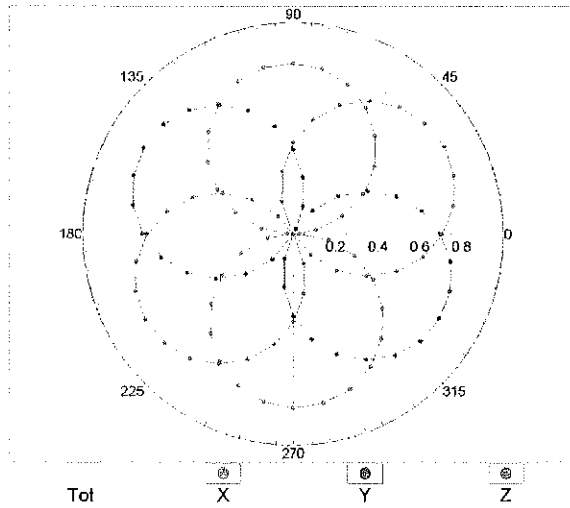

f=1800 MHz,R22

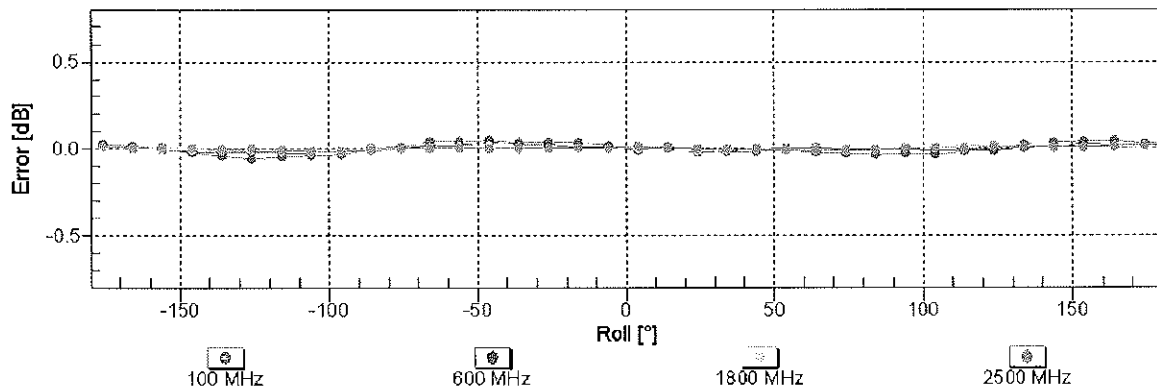
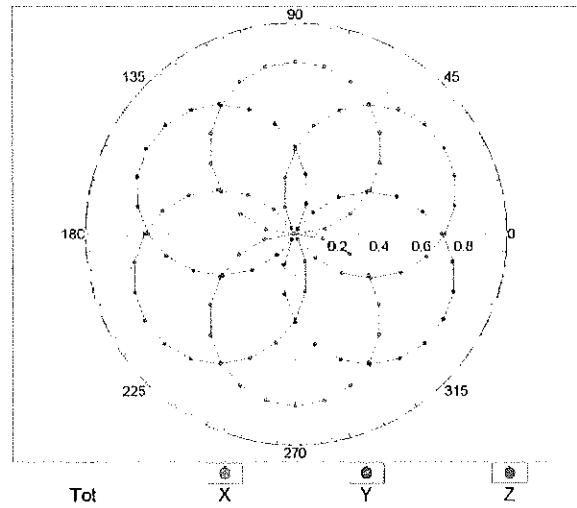

Uncertainty of Axial Isotropy Assessment:  $\pm 0.5\%$  (k=2)

### Dynamic Range $f(SAR_{head})$ (TEM cell , $f = 900$ MHz)

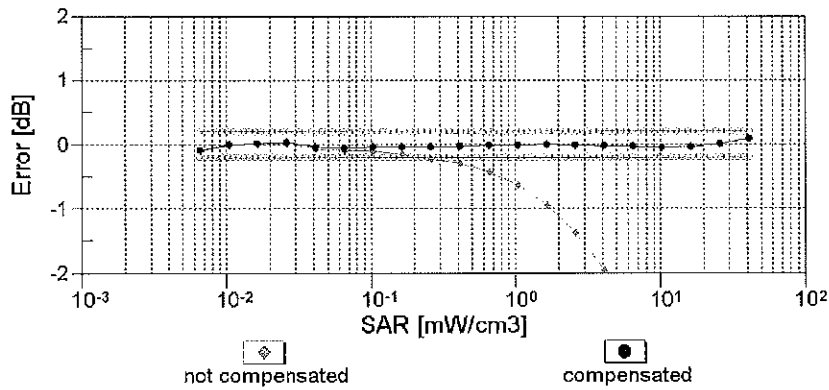
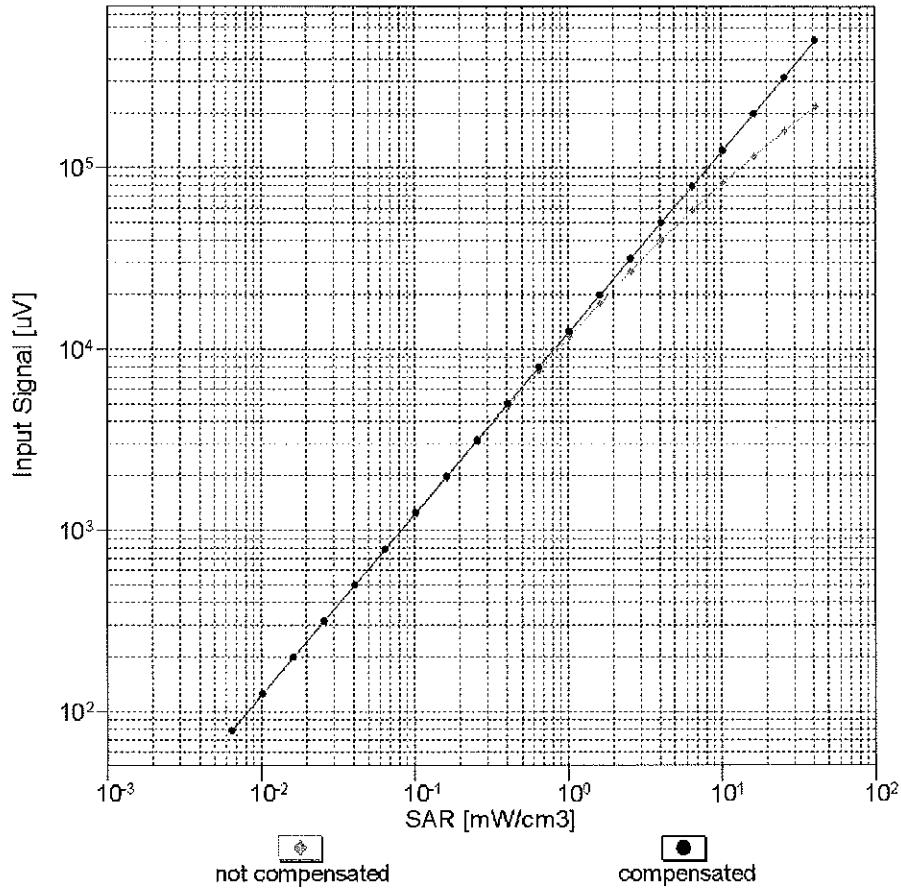

Uncertainty of Linearity Assessment:  $\pm 0.6\%$  ( $k=2$ )

# Conversion Factor Assessment

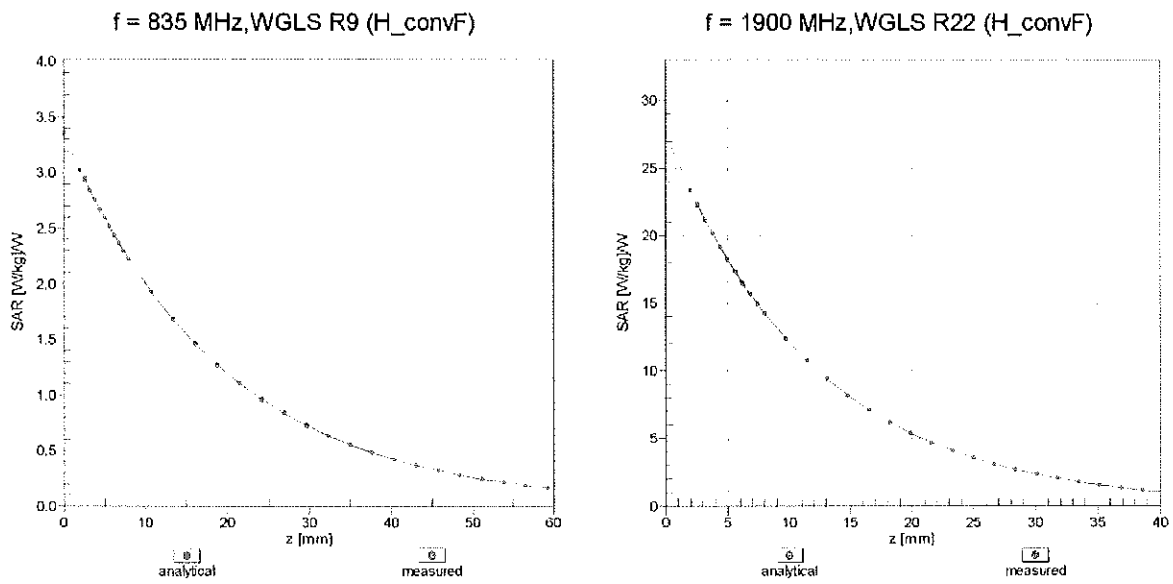

## Deviation from Isotropy in Liquid Error ( $\phi, \theta$ ), f = 900 MHz

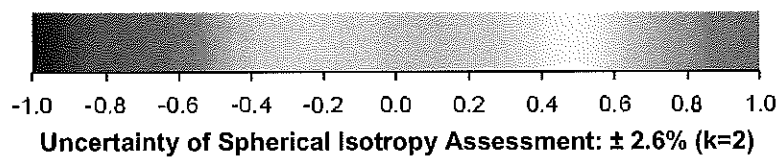
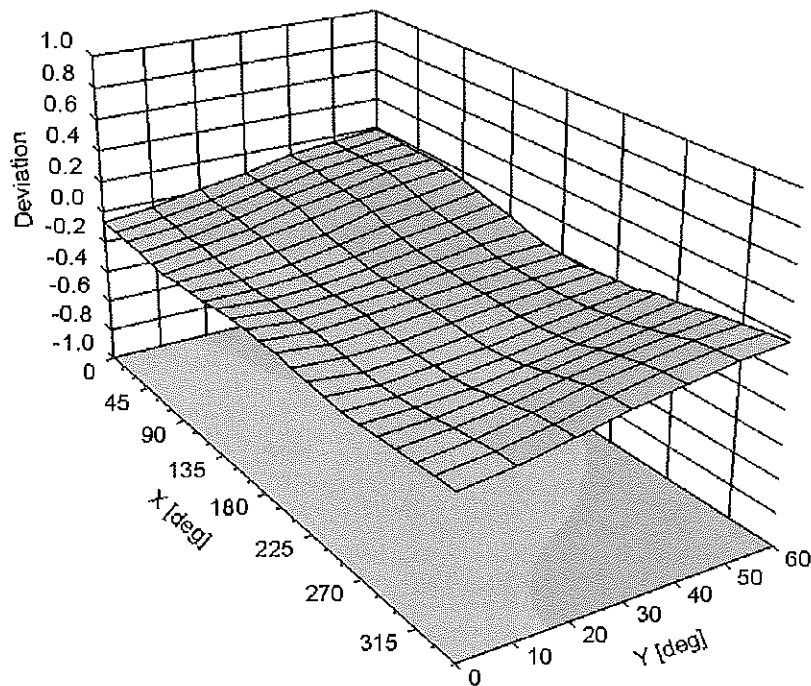

## DASY/EASY - Parameters of Probe: ES3DV3 - SN:3263

### Other Probe Parameters

Sensor Arrangement	Triangular
Connector Angle (°)	-116
Mechanical Surface Detection Mode	enabled
Optical Surface Detection Mode	disabled
Probe Overall Length	337 mm
Probe Body Diameter	10 mm
Tip Length	10 mm
Tip Diameter	4 mm
Probe Tip to Sensor X Calibration Point	2 mm
Probe Tip to Sensor Y Calibration Point	2 mm
Probe Tip to Sensor Z Calibration Point	2 mm
Recommended Measurement Distance from Surface	3 mm

**Calibration Laboratory of  
Schmid & Partner  
Engineering AG**  
Zeughausstrasse 43, 8004 Zurich, Switzerland



**S** Schweizerischer Kalibrierdienst  
**C** Service suisse d'étalonnage  
**S** Servizio svizzero di taratura  
Swiss Calibration Service

Accredited by the Swiss Accreditation Service (SAS)  
The Swiss Accreditation Service is one of the signatories to the EA  
Multilateral Agreement for the recognition of calibration certificates

Accreditation No.: **SCS 108**

Client **PC Test**

Certificate No: **ES3-3287\_Nov12**

## CALIBRATION CERTIFICATE

Object **ES3DV3 - SN:3287**

Calibration procedure(s) **QA CAL-01.v8, QA CAL-23.v4, QA CAL-25.v4  
Calibration procedure for dosimetric E-field probes**

Calibration date: **November 15, 2012**

*✓ KOK  
11/2012*

This calibration certificate documents the traceability to national standards, which realize the physical units of measurements (SI).  
The measurements and the uncertainties with confidence probability are given on the following pages and are part of the certificate.

All calibrations have been conducted in the closed laboratory facility: environment temperature (22 ± 3)°C and humidity < 70%.

Calibration Equipment used (M&TE critical for calibration)

Primary Standards	ID	Cal Date (Certificate No.)	Scheduled Calibration
Power meter E4419B	GB41293874	29-Mar-12 (No. 217-01508)	Apr-13
Power sensor E4412A	MY41498087	29-Mar-12 (No. 217-01508)	Apr-13
Reference 3 dB Attenuator	SN: S5054 (3c)	27-Mar-12 (No. 217-01531)	Apr-13
Reference 20 dB Attenuator	SN: S5086 (20b)	27-Mar-12 (No. 217-01529)	Apr-13
Reference 30 dB Attenuator	SN: S5129 (30b)	27-Mar-12 (No. 217-01532)	Apr-13
Reference Probe ES3DV2	SN: 3013	29-Dec-11 (No. ES3-3013_Dec11)	Dec-12
DAE4	SN: 660	20-Jun-12 (No. DAE4-660_Jun12)	Jun-13
Secondary Standards	ID	Check Date (in house)	Scheduled Check
RF generator HP 8648C	US3642U01700	4-Aug-99 (in house check Apr-11)	In house check: Apr-13
Network Analyzer HP 8753E	US37390585	18-Oct-01 (in house check Oct-12)	In house check: Oct-13

Calibrated by:	Name <b>Claudio Leubler</b>	Function <b>Laboratory Technician</b>	Signature 
Approved by:	Name <b>Katja Pokovic</b>	Function <b>Technical Manager</b>	Signature 

Issued: November 16, 2012

This calibration certificate shall not be reproduced except in full without written approval of the laboratory.



Accredited by the Swiss Accreditation Service (SAS)

Accreditation No.: **SCS 108**

The Swiss Accreditation Service is one of the signatories to the EA  
Multilateral Agreement for the recognition of calibration certificates

### Glossary:

TSL	tissue simulating liquid
NORM <sub>x,y,z</sub>	sensitivity in free space
ConvF	sensitivity in TSL / NORM <sub>x,y,z</sub>
DCP	diode compression point
CF	crest factor (1/duty_cycle) of the RF signal
A, B, C	modulation dependent linearization parameters
Polarization $\varphi$	$\varphi$ rotation around probe axis
Polarization $\vartheta$	$\vartheta$ rotation around an axis that is in the plane normal to probe axis (at measurement center), i.e., $\vartheta = 0$ is normal to probe axis

### Calibration is Performed According to the Following Standards:

- IEEE Std 1528-2003, "IEEE Recommended Practice for Determining the Peak Spatial-Averaged Specific Absorption Rate (SAR) in the Human Head from Wireless Communications Devices: Measurement Techniques", December 2003
- IEC 62209-1, "Procedure to measure the Specific Absorption Rate (SAR) for hand-held devices used in close proximity to the ear (frequency range of 300 MHz to 3 GHz)", February 2005

### Methods Applied and Interpretation of Parameters:

- NORM<sub>x,y,z</sub>**: Assessed for E-field polarization  $\vartheta = 0$  ( $f \leq 900$  MHz in TEM-cell;  $f > 1800$  MHz: R22 waveguide). NORM<sub>x,y,z</sub> are only intermediate values, i.e., the uncertainties of NORM<sub>x,y,z</sub> does not affect the E<sup>2</sup>-field uncertainty inside TSL (see below ConvF).
- NORM(f)<sub>x,y,z</sub>** = NORM<sub>x,y,z</sub> \* frequency\_response (see Frequency Response Chart). This linearization is implemented in DASY4 software versions later than 4.2. The uncertainty of the frequency response is included in the stated uncertainty of ConvF.
- DCP<sub>x,y,z</sub>**: DCP are numerical linearization parameters assessed based on the data of power sweep with CW signal (no uncertainty required). DCP does not depend on frequency nor media.
- PAR**: PAR is the Peak to Average Ratio that is not calibrated but determined based on the signal characteristics
- A<sub>x,y,z</sub>; B<sub>x,y,z</sub>; C<sub>x,y,z</sub>; VR<sub>x,y,z</sub>**: A, B, C are numerical linearization parameters assessed based on the data of power sweep for specific modulation signal. The parameters do not depend on frequency nor media. VR is the maximum calibration range expressed in RMS voltage across the diode.
- ConvF and Boundary Effect Parameters**: Assessed in flat phantom using E-field (or Temperature Transfer Standard for  $f \leq 800$  MHz) and inside waveguide using analytical field distributions based on power measurements for  $f > 800$  MHz. The same setups are used for assessment of the parameters applied for boundary compensation (alpha, depth) of which typical uncertainty values are given. These parameters are used in DASY4 software to improve probe accuracy close to the boundary. The sensitivity in TSL corresponds to NORM<sub>x,y,z</sub> \* ConvF whereby the uncertainty corresponds to that given for ConvF. A frequency dependent ConvF is used in DASY version 4.4 and higher which allows extending the validity from  $\pm 50$  MHz to  $\pm 100$  MHz.
- Spherical isotropy (3D deviation from isotropy)**: in a field of low gradients realized using a flat phantom exposed by a patch antenna.
- Sensor Offset**: The sensor offset corresponds to the offset of virtual measurement center from the probe tip (on probe axis). No tolerance required.

# Probe ES3DV3

## SN:3287

Manufactured: June 7, 2010  
Calibrated: November 15, 2012

Calibrated for DASY/EASY Systems  
(Note: non-compatible with DASY2 system!)

## DASY/EASY - Parameters of Probe: ES3DV3 - SN:3287

### Basic Calibration Parameters

	Sensor X	Sensor Y	Sensor Z	Unc (k=2)
Norm ( $\mu\text{V}/(\text{V}/\text{m})^2$ ) <sup>A</sup>	1.31	1.25	1.25	$\pm 10.1 \%$
DCP (mV) <sup>B</sup>	102.9	103.6	101.6	

### Modulation Calibration Parameters

UID	Communication System Name	PAR		A dB	B dB	C dB	VR mV	Unc <sup>E</sup> (k=2)
0	CW	0.00	X	0.0	0.0	1.0	116.8	$\pm 3.5 \%$
			Y	0.0	0.0	1.0	118.5	
			Z	0.0	0.0	1.0	154.1	

The reported uncertainty of measurement is stated as the standard uncertainty of measurement multiplied by the coverage factor  $k=2$ , which for a normal distribution corresponds to a coverage probability of approximately 95%.

<sup>A</sup> The uncertainties of NormX,Y,Z do not affect the  $E^2$ -field uncertainty inside TSL (see Pages 5 and 6).

<sup>B</sup> Numerical linearization parameter: uncertainty not required.

<sup>E</sup> Uncertainty is determined using the max. deviation from linear response applying rectangular distribution and is expressed for the square of the field value.

## DASY/EASY - Parameters of Probe: ES3DV3 - SN:3287

### Calibration Parameter Determined in Head Tissue Simulating Media

f (MHz) <sup>C</sup>	Relative Permittivity <sup>F</sup>	Conductivity (S/m) <sup>F</sup>	ConvF X	ConvF Y	ConvF Z	Alpha	Depth (mm)	Unct. (k=2)
750	41.9	0.89	6.40	6.40	6.40	0.20	2.54	± 12.0 %
835	41.5	0.90	6.17	6.17	6.17	0.34	1.68	± 12.0 %
1750	40.1	1.37	5.16	5.16	5.16	0.63	1.30	± 12.0 %
1900	40.0	1.40	4.96	4.96	4.96	0.48	1.55	± 12.0 %
2450	39.2	1.80	4.30	4.30	4.30	0.79	1.31	± 12.0 %
2600	39.0	1.96	4.19	4.19	4.19	0.80	1.31	± 12.0 %

<sup>C</sup> Frequency validity of ± 100 MHz only applies for DASY v4.4 and higher (see Page 2), else it is restricted to ± 50 MHz. The uncertainty is the RSS of the ConvF uncertainty at calibration frequency and the uncertainty for the indicated frequency band.

<sup>F</sup> At frequencies below 3 GHz, the validity of tissue parameters ( $\epsilon$  and  $\sigma$ ) can be relaxed to ± 10% if liquid compensation formula is applied to measured SAR values. At frequencies above 3 GHz, the validity of tissue parameters ( $\epsilon$  and  $\sigma$ ) is restricted to ± 5%. The uncertainty is the RSS of the ConvF uncertainty for indicated target tissue parameters.

## DASY/EASY - Parameters of Probe: ES3DV3 - SN:3287

### Calibration Parameter Determined in Body Tissue Simulating Media

f (MHz) <sup>C</sup>	Relative Permittivity <sup>F</sup>	Conductivity (S/m) <sup>F</sup>	ConvF X	ConvF Y	ConvF Z	Alpha	Depth (mm)	Unct. (k=2)
750	55.5	0.96	6.14	6.14	6.14	0.28	2.06	± 12.0 %
835	55.2	0.97	6.06	6.06	6.06	0.42	1.63	± 12.0 %
1750	53.4	1.49	4.86	4.86	4.86	0.43	1.64	± 12.0 %
1900	53.3	1.52	4.69	4.69	4.69	0.56	1.54	± 12.0 %
2450	52.7	1.95	4.29	4.29	4.29	0.80	1.02	± 12.0 %
2600	52.5	2.16	4.12	4.12	4.12	0.64	0.92	± 12.0 %

<sup>C</sup> Frequency validity of ± 100 MHz only applies for DASY v4.4 and higher (see Page 2), else it is restricted to ± 50 MHz. The uncertainty is the RSS of the ConvF uncertainty at calibration frequency and the uncertainty for the indicated frequency band.

<sup>F</sup> At frequencies below 3 GHz, the validity of tissue parameters ( $\epsilon$  and  $\sigma$ ) can be relaxed to ± 10% if liquid compensation formula is applied to measured SAR values. At frequencies above 3 GHz, the validity of tissue parameters ( $\epsilon$  and  $\sigma$ ) is restricted to ± 5%. The uncertainty is the RSS of the ConvF uncertainty for indicated target tissue parameters.

### Frequency Response of E-Field (TEM-Cell:ifi110 EXX, Waveguide: R22)

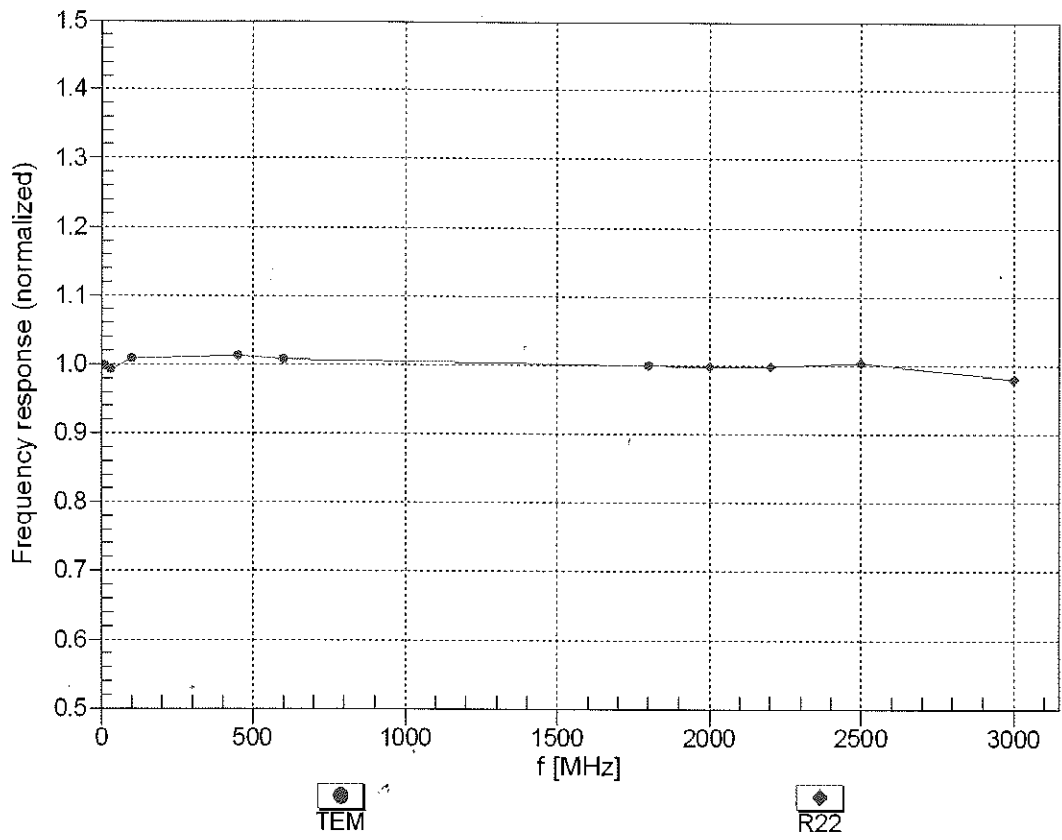

Uncertainty of Frequency Response of E-field:  $\pm 6.3\%$  (k=2)

# Receiving Pattern ( $\phi$ ), $\theta = 0^\circ$

f=600 MHz,TEM

f=1800 MHz,R22

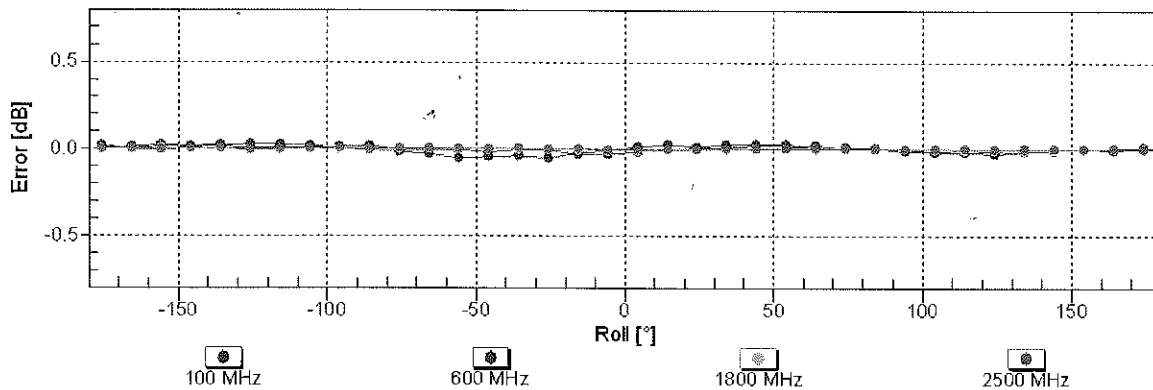
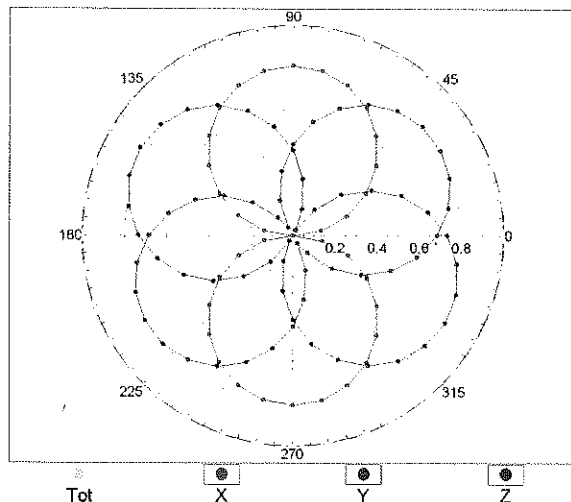
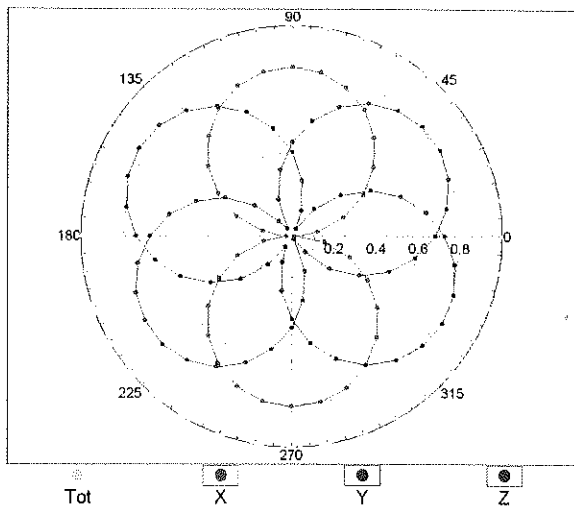

Uncertainty of Axial Isotropy Assessment:  $\pm 0.5\%$  (k=2)

## Dynamic Range f(SAR<sub>head</sub>) (TEM cell , f = 900 MHz)

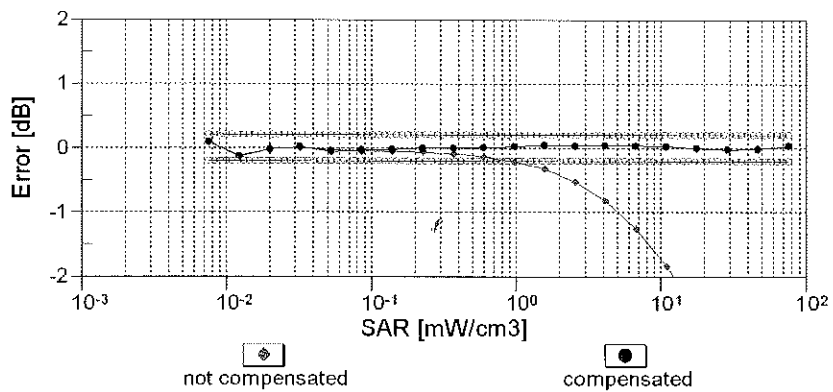
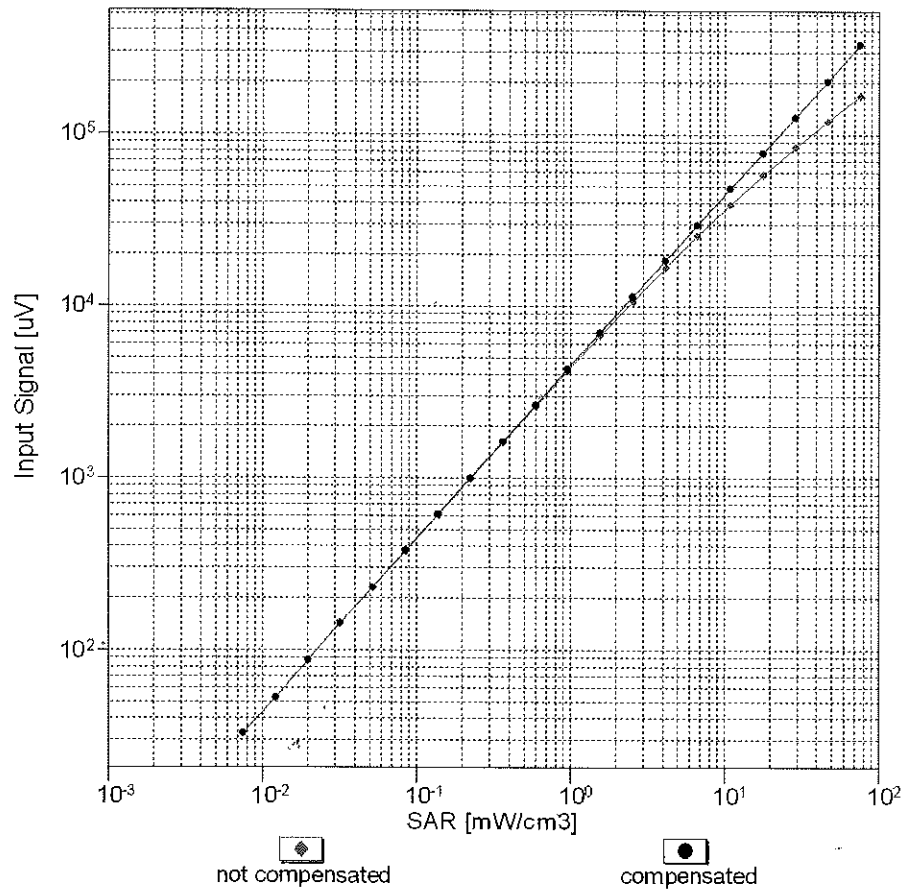

**Uncertainty of Linearity Assessment: ± 0.6% (k=2)**

# Conversion Factor Assessment

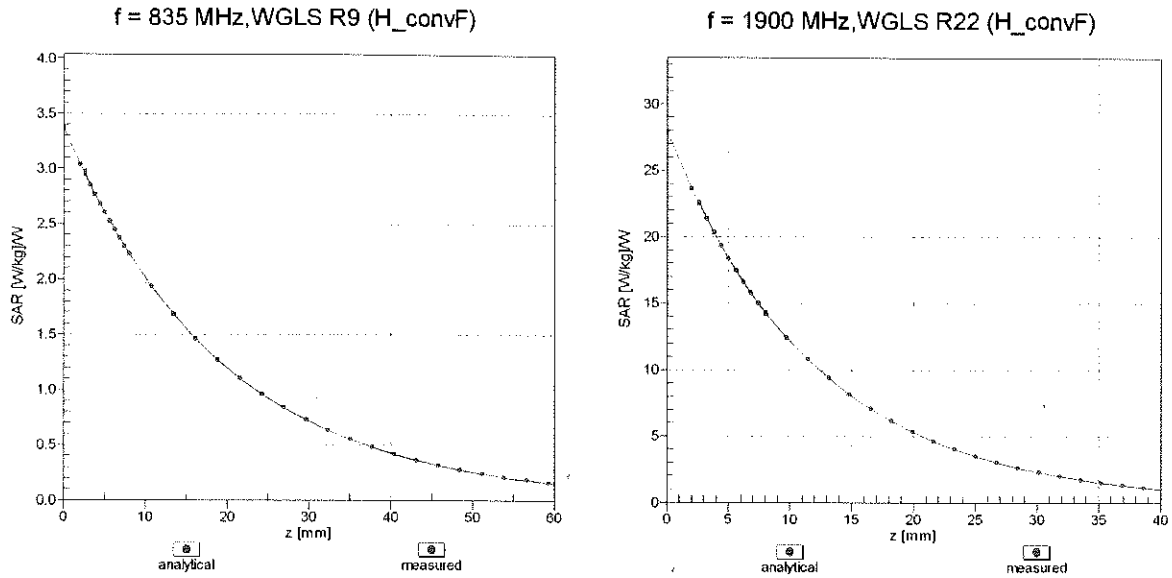

## Deviation from Isotropy in Liquid

Error ( $\phi, \theta$ ), f = 900 MHz

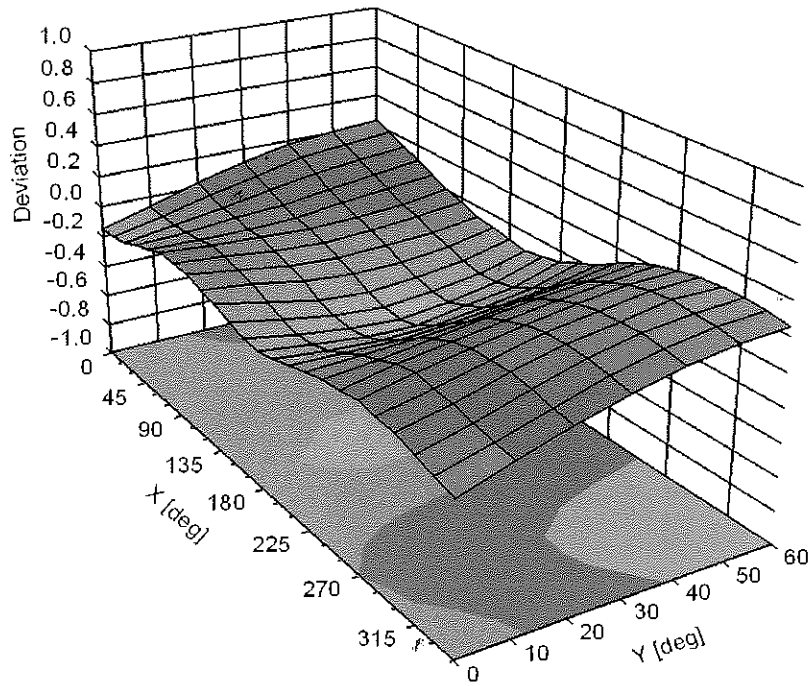

Uncertainty of Spherical Isotropy Assessment:  $\pm 2.6\%$  (k=2)

## DASY/EASY - Parameters of Probe: ES3DV3 - SN:3287

### Other Probe Parameters

Sensor Arrangement	Triangular
Connector Angle (°)	-15.9
Mechanical Surface Detection Mode	enabled
Optical Surface Detection Mode	disabled
Probe Overall Length	337 mm
Probe Body Diameter	10 mm
Tip Length	10 mm
Tip Diameter	4 mm
Probe Tip to Sensor X Calibration Point	2 mm
Probe Tip to Sensor Y Calibration Point	2 mm
Probe Tip to Sensor Z Calibration Point	2 mm
Recommended Measurement Distance from Surface	3 mm



Accredited by the Swiss Accreditation Service (SAS)  
The Swiss Accreditation Service is one of the signatories to the EA  
Multilateral Agreement for the recognition of calibration certificates

Accreditation No.: **SCS 108**

Client **PC Test**

Certificate No: **EX3-3920\_Feb13/2**

**CALIBRATION CERTIFICATE (Replacement of No: EX3-3920\_Feb13)**

Object **EX3DV4 - SN:3920**

Calibration procedure(s) **QA CAL-01.v8, QA CAL-14.v3, QA CAL-23.v4, QA CAL-25.v4  
Calibration procedure for dosimetric E-field probes**

Calibration date: **February 27, 2013**

This calibration certificate documents the traceability to national standards, which realize the physical units of measurements (SI).  
The measurements and the uncertainties with confidence probability are given on the following pages and are part of the certificate.

All calibrations have been conducted in the closed laboratory facility: environment temperature (22 ± 3)°C and humidity < 70%.

*✓ KOK 3/27/13*

Calibration Equipment used (M&TE critical for calibration)

Primary Standards	ID	Cal Date (Certificate No.)	Scheduled Calibration
Power meter E4419B	GB41293874	29-Mar-12 (No. 217-01508)	Apr-13
Power sensor E4412A	MY41498087	29-Mar-12 (No. 217-01508)	Apr-13
Reference 3 dB Attenuator	SN: S5054 (3c)	27-Mar-12 (No. 217-01531)	Apr-13
Reference 20 dB Attenuator	SN: S5086 (20b)	27-Mar-12 (No. 217-01529)	Apr-13
Reference 30 dB Attenuator	SN: S5129 (30b)	27-Mar-12 (No. 217-01532)	Apr-13
Reference Probe ES3DV2	SN: 3013	28-Dec-12 (No. ES3-3013_Dec12)	Dec-13
DAE4	SN: 660	31-Jan-13 (No. DAE4-660_Jan13)	Jan-14
Secondary Standards	ID	Check Date (in house)	Scheduled Check
RF generator HP 8648C	US3642U01700	4-Aug-99 (in house check Apr-11)	In house check: Apr-13
Network Analyzer HP 8753E	US37390585	18-Oct-01 (in house check Oct-12)	In house check: Oct-13

Calibrated by:	Name <b>Claudio Leubler</b>	Function Laboratory Technician	Signature 
Approved by:	Name <b>Katja Pokovic</b>	Function Technical Manager	Signature 

Issued: March 5, 2013

This calibration certificate shall not be reproduced except in full without written approval of the laboratory.



Accredited by the Swiss Accreditation Service (SAS)

The Swiss Accreditation Service is one of the signatories to the EA  
Multilateral Agreement for the recognition of calibration certificates

Accreditation No.: **SCS 108**

### Glossary:

TSL	tissue simulating liquid
NORM <sub>x,y,z</sub>	sensitivity in free space
ConvF	sensitivity in TSL / NORM <sub>x,y,z</sub>
DCP	diode compression point
CF	crest factor (1/duty_cycle) of the RF signal
A, B, C, D	modulation dependent linearization parameters
Polarization $\varphi$	$\varphi$ rotation around probe axis
Polarization $\vartheta$	$\vartheta$ rotation around an axis that is in the plane normal to probe axis (at measurement center), i.e., $\vartheta = 0$ is normal to probe axis

### Calibration is Performed According to the Following Standards:

- IEEE Std 1528-2003, "IEEE Recommended Practice for Determining the Peak Spatial-Averaged Specific Absorption Rate (SAR) in the Human Head from Wireless Communications Devices: Measurement Techniques", December 2003
- IEC 62209-1, "Procedure to measure the Specific Absorption Rate (SAR) for hand-held devices used in close proximity to the ear (frequency range of 300 MHz to 3 GHz)", February 2005

### Methods Applied and Interpretation of Parameters:

- NORM<sub>x,y,z</sub>**: Assessed for E-field polarization  $\vartheta = 0$  ( $f \leq 900$  MHz in TEM-cell;  $f > 1800$  MHz: R22 waveguide). NORM<sub>x,y,z</sub> are only intermediate values, i.e., the uncertainties of NORM<sub>x,y,z</sub> does not affect the E<sup>2</sup>-field uncertainty inside TSL (see below ConvF).
- NORM(f)<sub>x,y,z</sub>** = NORM<sub>x,y,z</sub> \* frequency\_response (see Frequency Response Chart). This linearization is implemented in DASY4 software versions later than 4.2. The uncertainty of the frequency response is included in the stated uncertainty of ConvF.
- DCP<sub>x,y,z</sub>**: DCP are numerical linearization parameters assessed based on the data of power sweep with CW signal (no uncertainty required). DCP does not depend on frequency nor media.
- PAR**: PAR is the Peak to Average Ratio that is not calibrated but determined based on the signal characteristics
- A<sub>x,y,z</sub>; B<sub>x,y,z</sub>; C<sub>x,y,z</sub>; D<sub>x,y,z</sub>; VR<sub>x,y,z</sub>**: A, B, C, D are numerical linearization parameters assessed based on the data of power sweep for specific modulation signal. The parameters do not depend on frequency nor media. VR is the maximum calibration range expressed in RMS voltage across the diode.
- ConvF and Boundary Effect Parameters**: Assessed in flat phantom using E-field (or Temperature Transfer Standard for  $f \leq 800$  MHz) and inside waveguide using analytical field distributions based on power measurements for  $f > 800$  MHz. The same setups are used for assessment of the parameters applied for boundary compensation (alpha, depth) of which typical uncertainty values are given. These parameters are used in DASY4 software to improve probe accuracy close to the boundary. The sensitivity in TSL corresponds to NORM<sub>x,y,z</sub> \* ConvF whereby the uncertainty corresponds to that given for ConvF. A frequency dependent ConvF is used in DASY version 4.4 and higher which allows extending the validity from  $\pm 50$  MHz to  $\pm 100$  MHz.
- Spherical isotropy (3D deviation from isotropy)**: in a field of low gradients realized using a flat phantom exposed by a patch antenna.
- Sensor Offset**: The sensor offset corresponds to the offset of virtual measurement center from the probe tip (on probe axis). No tolerance required.

# Probe EX3DV4

## SN:3920

Manufactured: December 18, 2012  
Calibrated: February 27, 2013

Calibrated for DASY/EASY Systems  
(Note: non-compatible with DASY2 system!)

## DASY/EASY - Parameters of Probe: EX3DV4 - SN:3920

### Basic Calibration Parameters

	Sensor X	Sensor Y	Sensor Z	Unc (k=2)
Norm ( $\mu\text{V}/(\text{V}/\text{m})^2$ ) <sup>A</sup>	0.34	0.50	0.50	$\pm 10.1\%$
DCP (mV) <sup>B</sup>	101.2	101.0	99.1	

### Modulation Calibration Parameters

UID	Communication System Name		A dB	B dB $\sqrt{\mu\text{V}}$	C	D dB	VR mV	Unc <sup>E</sup> (k=2)
0	CW	X	0.0	0.0	1.0	0.00	134.3	$\pm 3.3\%$
		Y	0.0	0.0	1.0		164.7	
		Z	0.0	0.0	1.0		161.4	

The reported uncertainty of measurement is stated as the standard uncertainty of measurement multiplied by the coverage factor  $k=2$ , which for a normal distribution corresponds to a coverage probability of approximately 95%.

<sup>A</sup> The uncertainties of NormX,Y,Z do not affect the  $E^2$ -field uncertainty inside TSL (see Pages 5 and 6).

<sup>B</sup> Numerical linearization parameter: uncertainty not required.

<sup>E</sup> Uncertainty is determined using the max. deviation from linear response applying rectangular distribution and is expressed for the square of the field value.

## DASY/EASY - Parameters of Probe: EX3DV4 - SN:3920

### Calibration Parameter Determined in Head Tissue Simulating Media

f (MHz) <sup>C</sup>	Relative Permittivity <sup>F</sup>	Conductivity (S/m) <sup>F</sup>	ConvF X	ConvF Y	ConvF Z	Alpha	Depth (mm)	Unct. (k=2)
750	41.9	0.89	9.86	9.86	9.86	0.19	1.39	± 12.0 %
835	41.5	0.90	9.58	9.58	9.58	0.77	0.54	± 12.0 %
1750	40.1	1.37	7.97	7.97	7.97	0.57	0.69	± 12.0 %
1900	40.0	1.40	7.73	7.73	7.73	0.54	0.73	± 12.0 %
2450	39.2	1.80	7.04	7.04	7.04	0.40	0.82	± 12.0 %
2600	39.0	1.96	6.80	6.80	6.80	0.49	0.76	± 12.0 %
5200	36.0	4.66	4.87	4.87	4.87	0.35	1.80	± 13.1 %
5300	35.9	4.76	4.73	4.73	4.73	0.37	1.80	± 13.1 %
5500	35.6	4.96	4.52	4.52	4.52	0.39	1.80	± 13.1 %
5600	35.5	5.07	4.17	4.17	4.17	0.50	1.80	± 13.1 %
5800	35.3	5.27	4.02	4.02	4.02	0.45	1.80	± 13.1 %

<sup>C</sup> Frequency validity of ± 100 MHz only applies for DASY v4.4 and higher (see Page 2), else it is restricted to ± 50 MHz. The uncertainty is the RSS of the ConvF uncertainty at calibration frequency and the uncertainty for the indicated frequency band.

<sup>F</sup> At frequencies below 3 GHz, the validity of tissue parameters ( $\epsilon$  and  $\sigma$ ) can be relaxed to ± 10% if liquid compensation formula is applied to measured SAR values. At frequencies above 3 GHz, the validity of tissue parameters ( $\epsilon$  and  $\sigma$ ) is restricted to ± 5%. The uncertainty is the RSS of the ConvF uncertainty for indicated target tissue parameters.

## DASY/EASY - Parameters of Probe: EX3DV4 - SN:3920

### Calibration Parameter Determined in Body Tissue Simulating Media

f (MHz) <sup>C</sup>	Relative Permittivity <sup>F</sup>	Conductivity (S/m) <sup>F</sup>	ConvF X	ConvF Y	ConvF Z	Alpha	Depth (mm)	Unct. (k=2)
750	55.5	0.96	9.57	9.57	9.57	0.43	0.83	± 12.0 %
835	55.2	0.97	9.42	9.42	9.42	0.36	0.98	± 12.0 %
1750	53.4	1.49	7.59	7.59	7.59	0.43	0.78	± 12.0 %
1900	53.3	1.52	7.38	7.38	7.38	0.33	0.91	± 12.0 %
2450	52.7	1.95	7.07	7.07	7.07	0.80	0.55	± 12.0 %
2600	52.5	2.16	6.73	6.73	6.73	0.80	0.56	± 12.0 %
5200	49.0	5.30	4.23	4.23	4.23	0.51	1.90	± 13.1 %
5300	48.9	5.42	4.13	4.13	4.13	0.49	1.90	± 13.1 %
5500	48.6	5.65	3.63	3.63	3.63	0.52	1.90	± 13.1 %
5600	48.5	5.77	3.62	3.62	3.62	0.49	1.90	± 13.1 %
5800	48.2	6.00	3.91	3.91	3.91	0.54	1.90	± 13.1 %

<sup>C</sup> Frequency validity of ± 100 MHz only applies for DASY v4.4 and higher (see Page 2), else it is restricted to ± 50 MHz. The uncertainty is the RSS of the ConvF uncertainty at calibration frequency and the uncertainty for the indicated frequency band.

<sup>F</sup> At frequencies below 3 GHz, the validity of tissue parameters ( $\epsilon$  and  $\sigma$ ) can be relaxed to ± 10% if liquid compensation formula is applied to measured SAR values. At frequencies above 3 GHz, the validity of tissue parameters ( $\epsilon$  and  $\sigma$ ) is restricted to ± 5%. The uncertainty is the RSS of the ConvF uncertainty for indicated target tissue parameters.

### Frequency Response of E-Field (TEM-Cell:ifi110 EXX, Waveguide: R22)

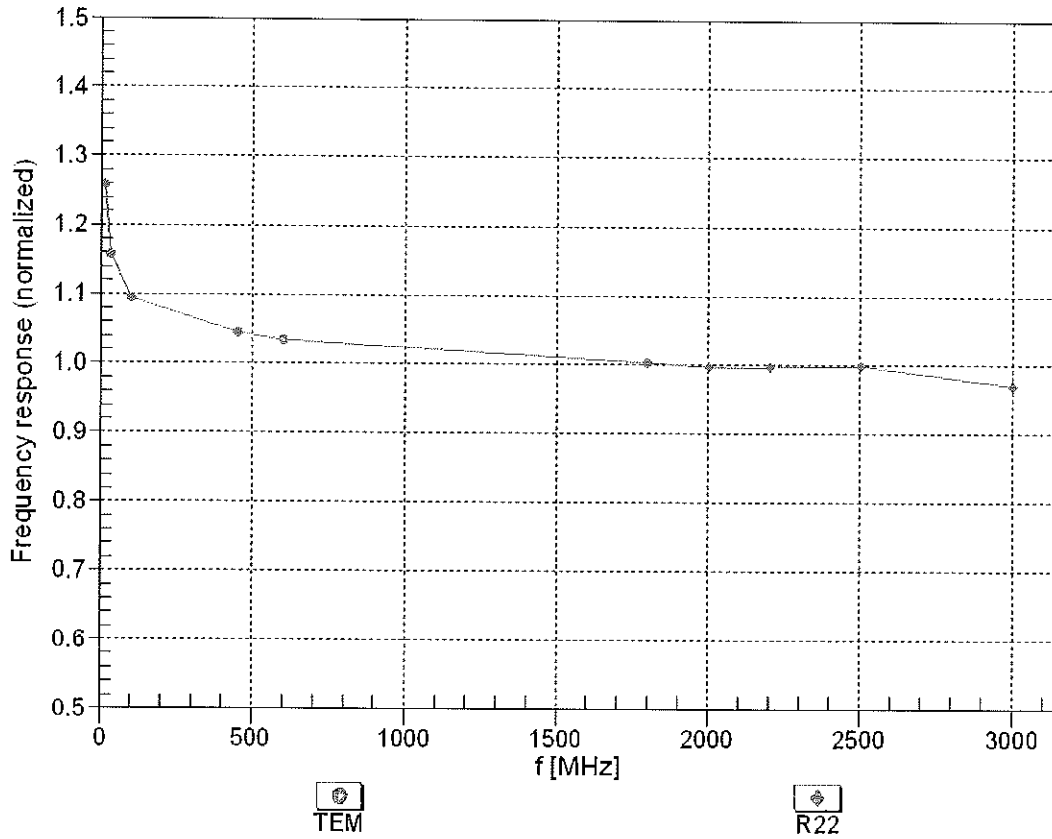

Uncertainty of Frequency Response of E-field:  $\pm 6.3\%$  (k=2)

### Receiving Pattern ( $\phi$ ), $\theta = 0^\circ$

f=600 MHz,TEM

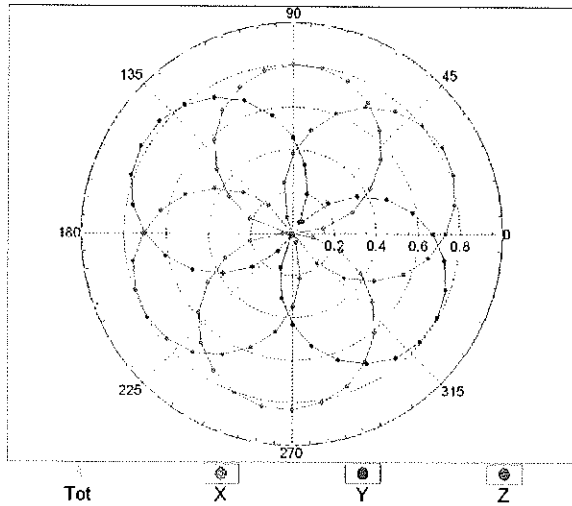

f=1800 MHz,R22

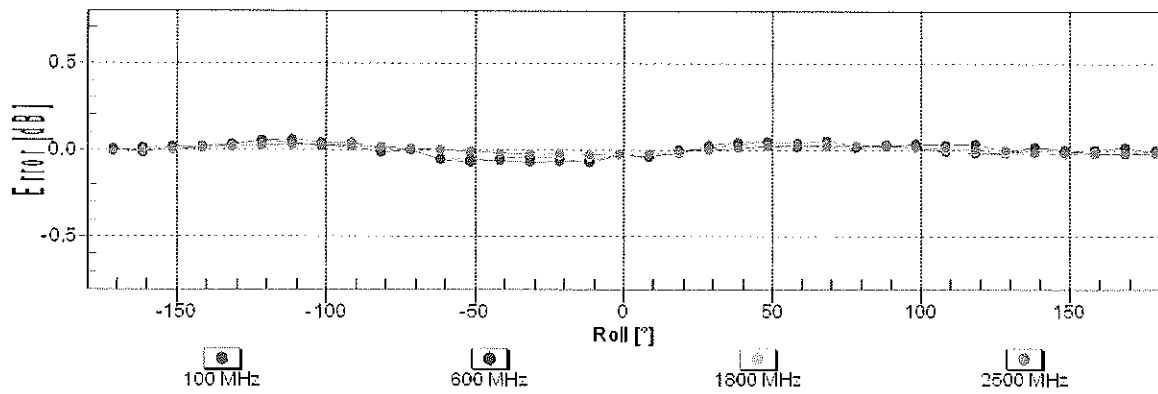
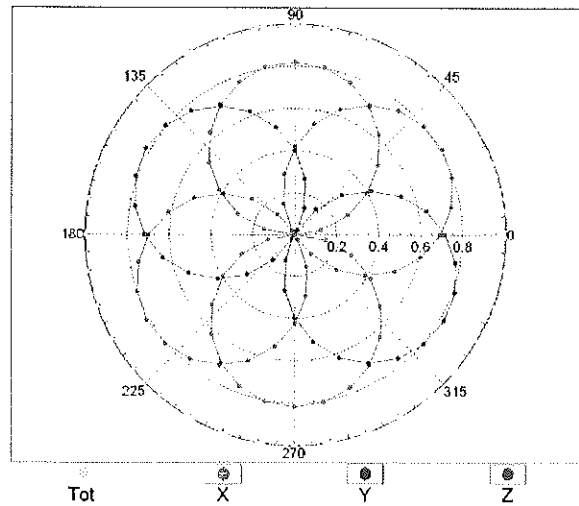

Uncertainty of Axial Isotropy Assessment:  $\pm 0.5\%$  (k=2)

### Dynamic Range f(SAR<sub>head</sub>) (TEM cell , f = 900 MHz)

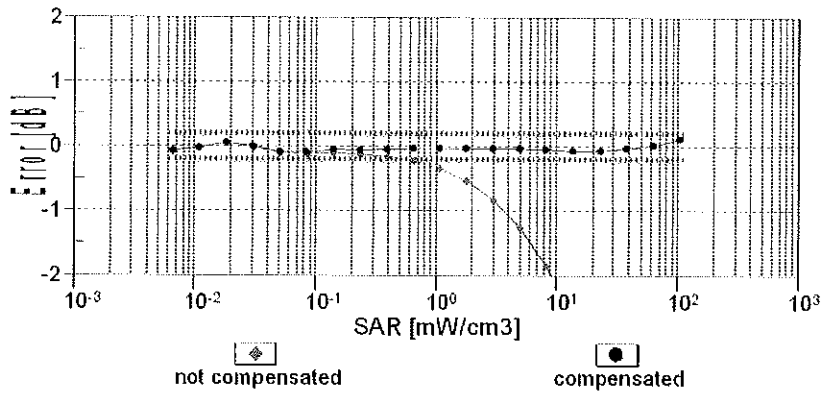
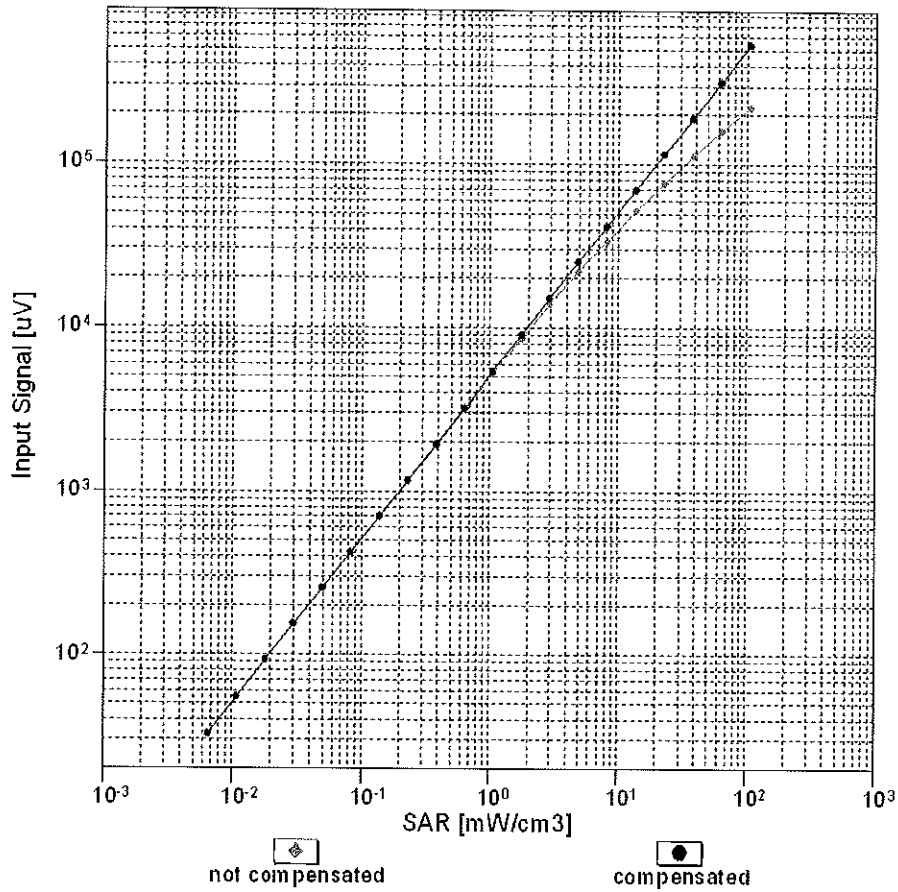

Uncertainty of Linearity Assessment: ± 0.6% (k=2)

# Conversion Factor Assessment

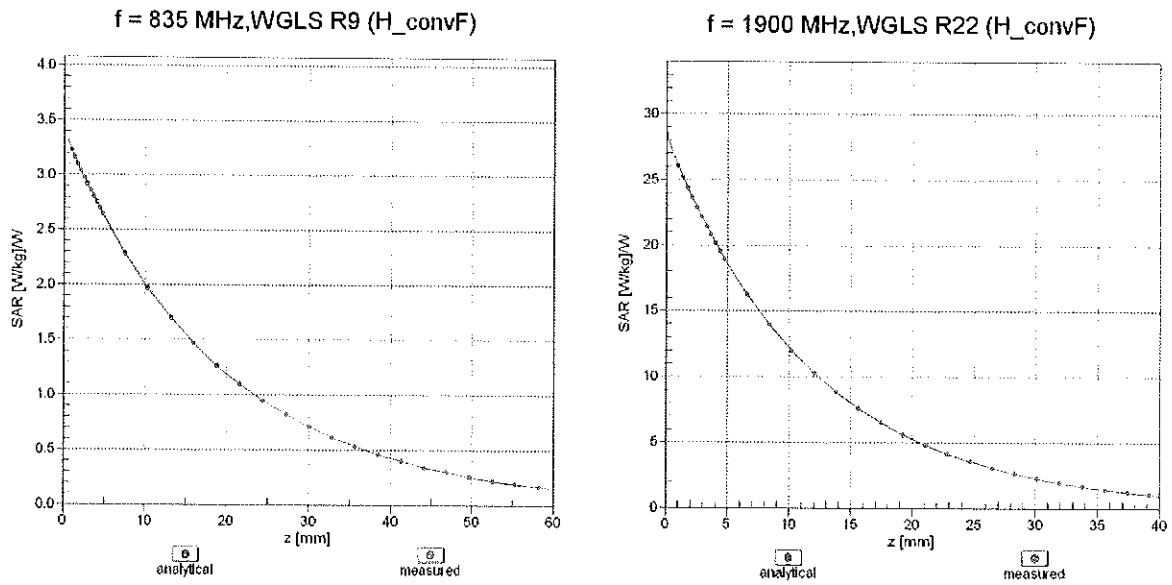

## Deviation from Isotropy in Liquid Error ( $\phi, \theta$ ), f = 900 MHz

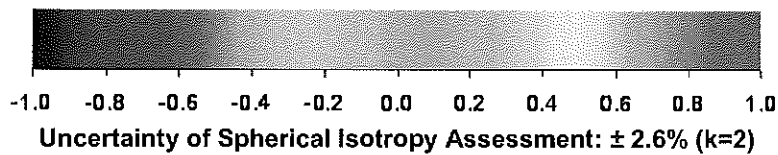
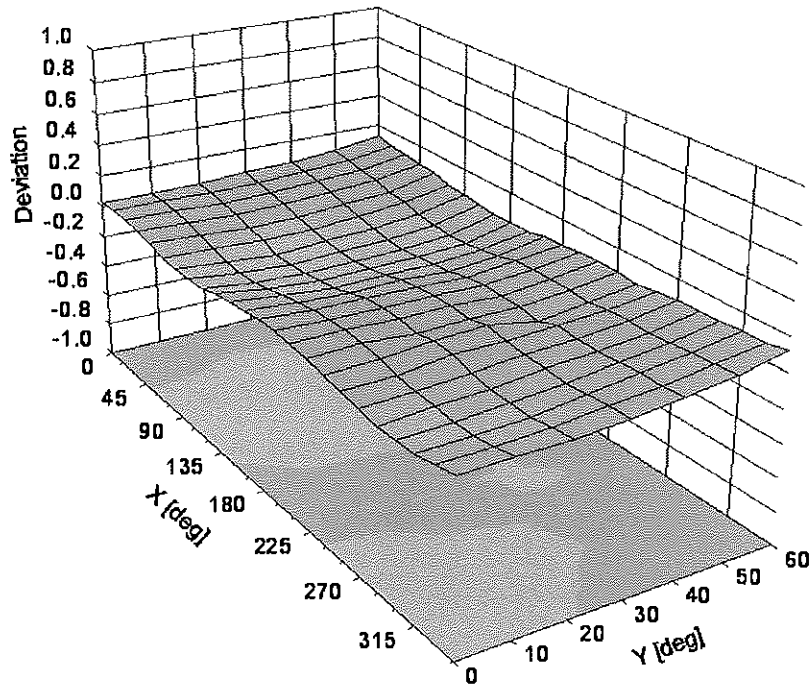

## DASY/EASY - Parameters of Probe: EX3DV4 - SN:3920

### Other Probe Parameters

Sensor Arrangement	Triangular
Connector Angle (°)	-21.6
Mechanical Surface Detection Mode	enabled
Optical Surface Detection Mode	disabled
Probe Overall Length	337 mm
Probe Body Diameter	10 mm
Tip Length	9 mm
Tip Diameter	2.5 mm
Probe Tip to Sensor X Calibration Point	1 mm
Probe Tip to Sensor Y Calibration Point	1 mm
Probe Tip to Sensor Z Calibration Point	1 mm
Recommended Measurement Distance from Surface	2 mm

## APPENDIX C: PROBE CALIBRATION



Accredited by the Swiss Accreditation Service (SAS)  
The Swiss Accreditation Service is one of the signatories to the EA  
Multilateral Agreement for the recognition of calibration certificates

Accreditation No.: **SCS 108**

Client **PC Test**

Certificate No: **D835V2-4d119\_Apr13**

## CALIBRATION CERTIFICATE

Object **D835V2 - SN: 4d119**

Calibration procedure(s) **QA CAL-05.v9  
Calibration procedure for dipole validation kits above 700 MHz**

Calibration date: **April 25, 2013**

✓  
KOK  
5/8/13

This calibration certificate documents the traceability to national standards, which realize the physical units of measurements (SI).  
The measurements and the uncertainties with confidence probability are given on the following pages and are part of the certificate.

All calibrations have been conducted in the closed laboratory facility: environment temperature ( $22 \pm 3$ )°C and humidity < 70%.

Calibration Equipment used (M&TE critical for calibration)

Primary Standards	ID #	Cal Date (Certificate No.)	Scheduled Calibration
Power meter EPM-442A	GB37480704	01-Nov-12 (No. 217-01640)	Oct-13
Power sensor HP 8481A	US37292783	01-Nov-12 (No. 217-01640)	Oct-13
Reference 20 dB Attenuator	SN: 5058 (20k)	04-Apr-13 (No. 217-01736)	Apr-14
Type-N mismatch combination	SN: 5047.3 / 06327	04-Apr-13 (No. 217-01739)	Apr-14
Reference Probe ES3DV3	SN: 3205	28-Dec-12 (No. ES3-3205_Dec12)	Dec-13
DAE4	SN: 909	11-Sep-12 (No. DAE4-909_Sep12)	Sep-13
Secondary Standards	ID #	Check Date (in house)	Scheduled Check
Power sensor HP 8481A	MY41092317	18-Oct-02 (in house check Oct-11)	In house check: Oct-13
RF generator R&S SMT-06	100005	04-Aug-99 (in house check Oct-11)	In house check: Oct-13
Network Analyzer HP 8753E	US37390585 S4206	18-Oct-01 (in house check Oct-12)	In house check: Oct-13

Calibrated by: **Claudio Leubler**      Name: Claudio Leubler      Function: Laboratory Technician

Approved by: **Katja Pokovic**      Name: Katja Pokovic      Technical Manager

Signature

Issued: April 26, 2013

This calibration certificate shall not be reproduced except in full without written approval of the laboratory.



Accredited by the Swiss Accreditation Service (SAS)  
The Swiss Accreditation Service is one of the signatories to the EA  
Multilateral Agreement for the recognition of calibration certificates

Accreditation No.: **SCS 108**

### Glossary:

TSL	tissue simulating liquid
ConvF	sensitivity in TSL / NORM x,y,z
N/A	not applicable or not measured

### Calibration is Performed According to the Following Standards:

- IEEE Std 1528-2003, "IEEE Recommended Practice for Determining the Peak Spatial-Averaged Specific Absorption Rate (SAR) in the Human Head from Wireless Communications Devices: Measurement Techniques", December 2003
- IEC 62209-1, "Procedure to measure the Specific Absorption Rate (SAR) for hand-held devices used in close proximity to the ear (frequency range of 300 MHz to 3 GHz)", February 2005
- Federal Communications Commission Office of Engineering & Technology (FCC OET), "Evaluating Compliance with FCC Guidelines for Human Exposure to Radiofrequency Electromagnetic Fields; Additional Information for Evaluating Compliance of Mobile and Portable Devices with FCC Limits for Human Exposure to Radiofrequency Emissions", Supplement C (Edition 01-01) to Bulletin 65

### Additional Documentation:

- DASY4/5 System Handbook

### Methods Applied and Interpretation of Parameters:

- Measurement Conditions:** Further details are available from the Validation Report at the end of the certificate. All figures stated in the certificate are valid at the frequency indicated.
- Antenna Parameters with TSL:** The dipole is mounted with the spacer to position its feed point exactly below the center marking of the flat phantom section, with the arms oriented parallel to the body axis.
- Feed Point Impedance and Return Loss:** These parameters are measured with the dipole positioned under the liquid filled phantom. The impedance stated is transformed from the measurement at the SMA connector to the feed point. The Return Loss ensures low reflected power. No uncertainty required.
- Electrical Delay:** One-way delay between the SMA connector and the antenna feed point. No uncertainty required.
- SAR measured:** SAR measured at the stated antenna input power.
- SAR normalized:** SAR as measured, normalized to an input power of 1 W at the antenna connector.
- SAR for nominal TSL parameters:** The measured TSL parameters are used to calculate the nominal SAR result.

The reported uncertainty of measurement is stated as the standard uncertainty of measurement multiplied by the coverage factor  $k=2$ , which for a normal distribution corresponds to a coverage probability of approximately 95%.

## Measurement Conditions

DASY system configuration, as far as not given on page 1.

DASY Version	DASY5	V52.8.6
Extrapolation	Advanced Extrapolation	
Phantom	Modular Flat Phantom	
Distance Dipole Center - TSL	15 mm	with Spacer
Zoom Scan Resolution	dx, dy, dz = 5 mm	
Frequency	835 MHz $\pm$ 1 MHz	

## Head TSL parameters

The following parameters and calculations were applied.

	Temperature	Permittivity	Conductivity
Nominal Head TSL parameters	22.0 °C	41.5	0.90 mho/m
Measured Head TSL parameters	(22.0 $\pm$ 0.2) °C	40.8 $\pm$ 6 %	0.94 mho/m $\pm$ 6 %
Head TSL temperature change during test	< 0.5 °C	----	----

## SAR result with Head TSL

SAR averaged over 1 cm <sup>3</sup> (1 g) of Head TSL	Condition	
SAR measured	250 mW input power	2.51 W/kg
SAR for nominal Head TSL parameters	normalized to 1W	<b>9.68 W/kg <math>\pm</math> 17.0 % (k=2)</b>

SAR averaged over 10 cm <sup>3</sup> (10 g) of Head TSL	condition	
SAR measured	250 mW input power	1.62 W/kg
SAR for nominal Head TSL parameters	normalized to 1W	<b>6.30 W/kg <math>\pm</math> 16.5 % (k=2)</b>

## Body TSL parameters

The following parameters and calculations were applied.

	Temperature	Permittivity	Conductivity
Nominal Body TSL parameters	22.0 °C	55.2	0.97 mho/m
Measured Body TSL parameters	(22.0 $\pm$ 0.2) °C	54.0 $\pm$ 6 %	1.01 mho/m $\pm$ 6 %
Body TSL temperature change during test	< 0.5 °C	----	----

## SAR result with Body TSL

SAR averaged over 1 cm <sup>3</sup> (1 g) of Body TSL	Condition	
SAR measured	250 mW input power	2.47 W/kg
SAR for nominal Body TSL parameters	normalized to 1W	<b>9.54 W/kg <math>\pm</math> 17.0 % (k=2)</b>

SAR averaged over 10 cm <sup>3</sup> (10 g) of Body TSL	condition	
SAR measured	250 mW input power	1.62 W/kg
SAR for nominal Body TSL parameters	normalized to 1W	<b>6.31 W/kg <math>\pm</math> 16.5 % (k=2)</b>

## Appendix

### Antenna Parameters with Head TSL

Impedance, transformed to feed point	50.1 $\Omega$ - 4.7 j $\Omega$
Return Loss	- 26.6 dB

### Antenna Parameters with Body TSL

Impedance, transformed to feed point	45.8 $\Omega$ - 6.3 j $\Omega$
Return Loss	- 22.1 dB

### General Antenna Parameters and Design

Electrical Delay (one direction)	1.385 ns
----------------------------------	----------

After long term use with 100W radiated power, only a slight warming of the dipole near the feedpoint can be measured.

The dipole is made of standard semirigid coaxial cable. The center conductor of the feeding line is directly connected to the second arm of the dipole. The antenna is therefore short-circuited for DC-signals. On some of the dipoles, small end caps are added to the dipole arms in order to improve matching when loaded according to the position as explained in the "Measurement Conditions" paragraph. The SAR data are not affected by this change. The overall dipole length is still according to the Standard.

No excessive force must be applied to the dipole arms, because they might bend or the soldered connections near the feedpoint may be damaged.

### Additional EUT Data

Manufactured by	SPEAG
Manufactured on	June 29, 2010

## DASY5 Validation Report for Head TSL

Date: 25.04.2013

Test Laboratory: SPEAG, Zurich, Switzerland

**DUT: Dipole 835 MHz; Type: D835V2; Serial: D835V2 - SN: 4d119**

Communication System: UID 0 - CW; Frequency: 835 MHz

Medium parameters used:  $f = 835$  MHz;  $\sigma = 0.94$  S/m;  $\epsilon_r = 40.8$ ;  $\rho = 1000$  kg/m<sup>3</sup>

Phantom section: Flat Section

Measurement Standard: DASY5 (IEEE/IEC/ANSI C63.19-2007)

DASY52 Configuration:

- Probe: ES3DV3 - SN3205; ConvF(6.05, 6.05, 6.05); Calibrated: 28.12.2012;
- Sensor-Surface: 3mm (Mechanical Surface Detection)
- Electronics: DAE4 Sn909; Calibrated: 11.09.2012
- Phantom: Flat Phantom 4.9L; Type: QD000P49AA; Serial: 1001
- DASY52 52.8.6(1115); SEMCAD X 14.6.9(7117)

### **Dipole Calibration for Head Tissue/Pin=250 mW, d=15mm/Zoom Scan (7x7x7)/Cube 0:**

Measurement grid: dx=5mm, dy=5mm, dz=5mm

Reference Value = 57.387 V/m; Power Drift = 0.03 dB

Peak SAR (extrapolated) = 3.86 W/kg

**SAR(1 g) = 2.51 W/kg; SAR(10 g) = 1.62 W/kg**

Maximum value of SAR (measured) = 2.93 W/kg

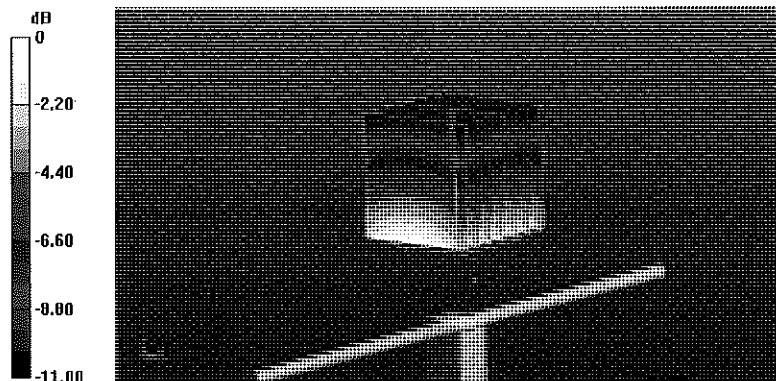

0 dB = 2.93 W/kg = 4.67 dBW/kg

# Impedance Measurement Plot for Head TSL

25 Apr 2013 09:11:06

CH1 S11 1 U FS

1: 50.061  $\Omega$  -4.6621  $\Omega$  40.884 pF

835.000 000 MHz

\*  
Del

CA

Avg  
16

H1 d

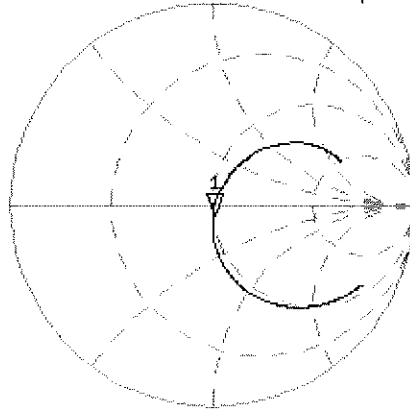

CH2 S11 LOG

5 dB/REF -20 dB

1: -26.641 dB 835.000 000 MHz

CA

Avg  
16

H1 d

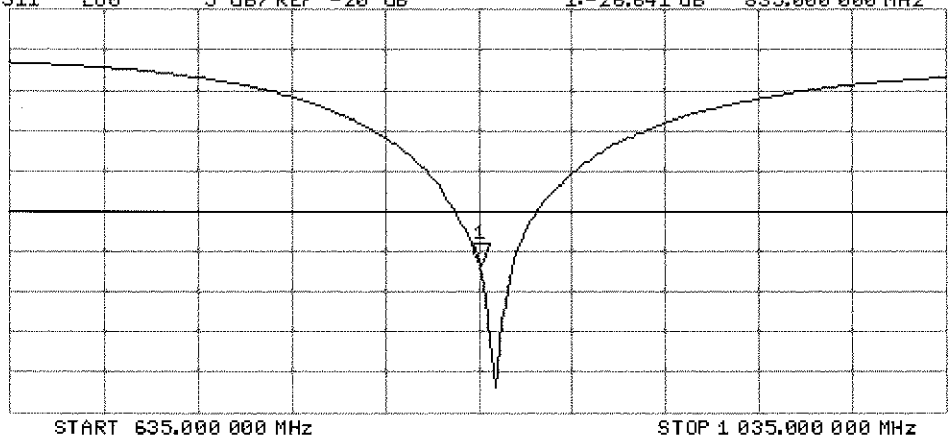

## DASY5 Validation Report for Body TSL

Date: 24.04.2013

Test Laboratory: SPEAG, Zurich, Switzerland

**DUT: Dipole 835 MHz; Type: D835V2; Serial: D835V2 - SN: 4d119**

Communication System: UID 0 - CW; Frequency: 835 MHz

Medium parameters used:  $f = 835$  MHz;  $\sigma = 1.01$  S/m;  $\epsilon_r = 54$ ;  $\rho = 1000$  kg/m<sup>3</sup>

Phantom section: Flat Section

Measurement Standard: DASY5 (IEEE/IEC/ANSI C63.19-2007)

DASY52 Configuration:

- Probe: ES3DV3 - SN3205; ConvF(6.04, 6.04, 6.04); Calibrated: 28.12.2012;
- Sensor-Surface: 3mm (Mechanical Surface Detection)
- Electronics: DAE4 Sn909; Calibrated: 11.09.2012
- Phantom: Flat Phantom 4.9L; Type: QD000P49AA; Serial: 1001
- DASY52 52.8.6(1115); SEMCAD X 14.6.9(7117)

### **Dipole Calibration for Body Tissue/Pin=250 mW, d=15mm/Zoom Scan (7x7x7)/Cube 0:**

Measurement grid: dx=5mm, dy=5mm, dz=5mm

Reference Value = 55.178 V/m; Power Drift = 0.03 dB

Peak SAR (extrapolated) = 3.68 W/kg

**SAR(1 g) = 2.47 W/kg; SAR(10 g) = 1.62 W/kg**

Maximum value of SAR (measured) = 2.89 W/kg

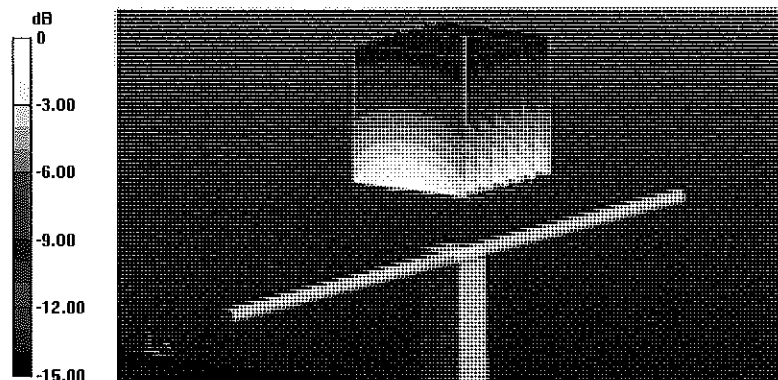

0 dB = 2.89 W/kg = 4.61 dBW/kg

# Impedance Measurement Plot for Body TSL

24 Apr 2013 11:33:44

CH1 S11 1 U FS

2: 45.773  $\Omega$  -6.2773  $\Delta$  30.364 pF

835.000 000 MHz

\*  
DeI

CΔ

Avg  
16

H1d

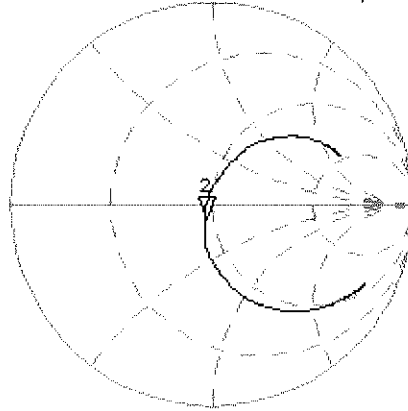

CH2 S11 LOG

5 dB/REF -20 dB

2: -22.065 dB

835.000 000 MHz

CΔ

Avg  
16

H1d

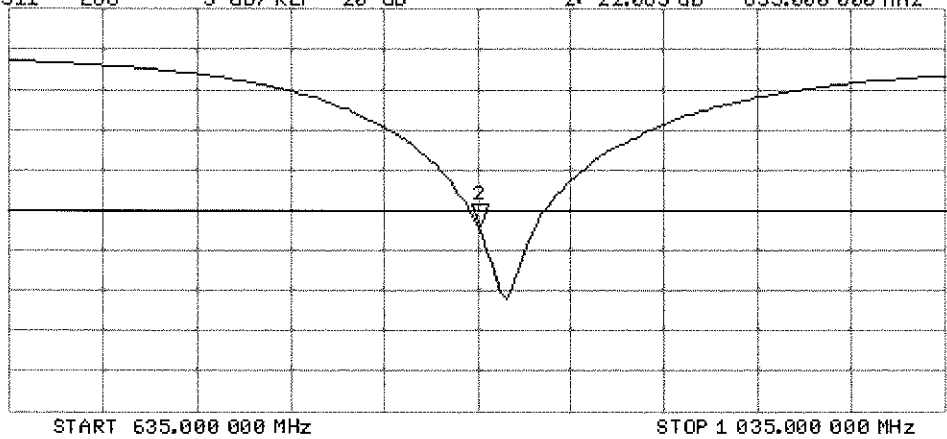



Accredited by the Swiss Accreditation Service (SAS)  
The Swiss Accreditation Service is one of the signatories to the EA  
Multilateral Agreement for the recognition of calibration certificates

Accreditation No.: **SCS 108**

Client **PC Test**

Certificate No: **D1900V2-5d148\_Feb13**

## CALIBRATION CERTIFICATE

Object **D1900V2 - SN: 5d148**

Calibration procedure(s) **QA CAL-05.v9  
Calibration procedure for dipole validation kits above 700 MHz**

Calibration date: **February 06, 2013**

*KOK  
2/21/13*

This calibration certificate documents the traceability to national standards, which realize the physical units of measurements (SI).  
The measurements and the uncertainties with confidence probability are given on the following pages and are part of the certificate.

All calibrations have been conducted in the closed laboratory facility: environment temperature ( $22 \pm 3$ )°C and humidity < 70%.

Calibration Equipment used (M&TE critical for calibration)

Primary Standards	ID #	Cal Date (Certificate No.)	Scheduled Calibration
Power meter EPM-442A	GB37480704	01-Nov-12 (No. 217-01640)	Oct-13
Power sensor HP 8481A	US37292783	01-Nov-12 (No. 217-01640)	Oct-13
Reference 20 dB Attenuator	SN: 5058 (20k)	27-Mar-12 (No. 217-01530)	Apr-13
Type-N mismatch combination	SN: 5047.3 / 06327	27-Mar-12 (No. 217-01533)	Apr-13
Reference Probe ES3DV3	SN: 3205	28-Dec-12 (No. ES3-3205_Dec12)	Dec-13
DAE4	SN: 601	27-Jun-12 (No. DAE4-601_Jun12)	Jun-13
Secondary Standards	ID #	Check Date (in house)	Scheduled Check
Power sensor HP 8481A	MY41092317	18-Oct-02 (in house check Oct-11)	In house check: Oct-13
RF generator R&S SMT-06	100005	04-Aug-99 (in house check Oct-11)	In house check: Oct-13
Network Analyzer HP 8753E	US37390585 S4206	18-Oct-01 (in house check Oct-12)	In house check: Oct-13

Calibrated by: **Leif Klysner**      Name: **Leif Klysner**      Function: **Laboratory Technician**

Signature: *Leif Klysner*

Approved by: **Katja Pokovic**      Name: **Katja Pokovic**      Technical Manager

Signature: *Katja Pokovic*

Issued: February 6, 2013

This calibration certificate shall not be reproduced except in full without written approval of the laboratory.



Accredited by the Swiss Accreditation Service (SAS)

The Swiss Accreditation Service is one of the signatories to the EA Multilateral Agreement for the recognition of calibration certificates

Accreditation No.: **SCS 108**

### Glossary:

TSL	tissue simulating liquid
ConvF	sensitivity in TSL / NORM x,y,z
N/A	not applicable or not measured

### Calibration is Performed According to the Following Standards:

- IEEE Std 1528-2003, "IEEE Recommended Practice for Determining the Peak Spatial-Averaged Specific Absorption Rate (SAR) in the Human Head from Wireless Communications Devices: Measurement Techniques", December 2003
- IEC 62209-1, "Procedure to measure the Specific Absorption Rate (SAR) for hand-held devices used in close proximity to the ear (frequency range of 300 MHz to 3 GHz)", February 2005
- Federal Communications Commission Office of Engineering & Technology (FCC OET), "Evaluating Compliance with FCC Guidelines for Human Exposure to Radiofrequency Electromagnetic Fields; Additional Information for Evaluating Compliance of Mobile and Portable Devices with FCC Limits for Human Exposure to Radiofrequency Emissions", Supplement C (Edition 01-01) to Bulletin 65

### Additional Documentation:

- DASY4/5 System Handbook

### Methods Applied and Interpretation of Parameters:

- Measurement Conditions:* Further details are available from the Validation Report at the end of the certificate. All figures stated in the certificate are valid at the frequency indicated.
- Antenna Parameters with TSL:* The dipole is mounted with the spacer to position its feed point exactly below the center marking of the flat phantom section, with the arms oriented parallel to the body axis.
- Feed Point Impedance and Return Loss:* These parameters are measured with the dipole positioned under the liquid filled phantom. The impedance stated is transformed from the measurement at the SMA connector to the feed point. The Return Loss ensures low reflected power. No uncertainty required.
- Electrical Delay:* One-way delay between the SMA connector and the antenna feed point. No uncertainty required.
- SAR measured:* SAR measured at the stated antenna input power.
- SAR normalized:* SAR as measured, normalized to an input power of 1 W at the antenna connector.
- SAR for nominal TSL parameters:* The measured TSL parameters are used to calculate the nominal SAR result.

The reported uncertainty of measurement is stated as the standard uncertainty of measurement multiplied by the coverage factor  $k=2$ , which for a normal distribution corresponds to a coverage probability of approximately 95%.

## Measurement Conditions

DASY system configuration, as far as not given on page 1.

<b>DASY Version</b>	DASY5	V52.8.5
<b>Extrapolation</b>	Advanced Extrapolation	
<b>Phantom</b>	Modular Flat Phantom	
<b>Distance Dipole Center - TSL</b>	10 mm	with Spacer
<b>Zoom Scan Resolution</b>	dx, dy, dz = 5 mm	
<b>Frequency</b>	1900 MHz $\pm$ 1 MHz	

## Head TSL parameters

The following parameters and calculations were applied.

	Temperature	Permittivity	Conductivity
<b>Nominal Head TSL parameters</b>	22.0 °C	40.0	1.40 mho/m
<b>Measured Head TSL parameters</b>	(22.0 $\pm$ 0.2) °C	39.4 $\pm$ 6 %	1.38 mho/m $\pm$ 6 %
<b>Head TSL temperature change during test</b>	< 0.5 °C	----	----

## SAR result with Head TSL

<b>SAR averaged over 1 cm<sup>3</sup> (1 g) of Head TSL</b>	Condition	
SAR measured	250 mW input power	9.87 W/kg
SAR for nominal Head TSL parameters	normalized to 1W	<b>39.7 W/kg <math>\pm</math> 17.0 % (k=2)</b>

<b>SAR averaged over 10 cm<sup>3</sup> (10 g) of Head TSL</b>	condition	
SAR measured	250 mW input power	5.18 W/kg
SAR for nominal Head TSL parameters	normalized to 1W	<b>20.8 W/kg <math>\pm</math> 16.5 % (k=2)</b>

## Body TSL parameters

The following parameters and calculations were applied.

	Temperature	Permittivity	Conductivity
<b>Nominal Body TSL parameters</b>	22.0 °C	53.3	1.52 mho/m
<b>Measured Body TSL parameters</b>	(22.0 $\pm$ 0.2) °C	51.9 $\pm$ 6 %	1.53 mho/m $\pm$ 6 %
<b>Body TSL temperature change during test</b>	< 0.5 °C	----	----

## SAR result with Body TSL

<b>SAR averaged over 1 cm<sup>3</sup> (1 g) of Body TSL</b>	Condition	
SAR measured	250 mW input power	10.3 W/kg
SAR for nominal Body TSL parameters	normalized to 1W	<b>40.8 W/kg <math>\pm</math> 17.0 % (k=2)</b>

<b>SAR averaged over 10 cm<sup>3</sup> (10 g) of Body TSL</b>	condition	
SAR measured	250 mW input power	5.45 W/kg
SAR for nominal Body TSL parameters	normalized to 1W	<b>21.7 W/kg <math>\pm</math> 16.5 % (k=2)</b>

## Appendix

### Antenna Parameters with Head TSL

Impedance, transformed to feed point	52.1 $\Omega$ + 5.9 j $\Omega$
Return Loss	- 24.3 dB

### Antenna Parameters with Body TSL

Impedance, transformed to feed point	48.3 $\Omega$ + 6.3 j $\Omega$
Return Loss	- 23.6 dB

### General Antenna Parameters and Design

Electrical Delay (one direction)	1.199 ns
----------------------------------	----------

After long term use with 100W radiated power, only a slight warming of the dipole near the feedpoint can be measured.

The dipole is made of standard semirigid coaxial cable. The center conductor of the feeding line is directly connected to the second arm of the dipole. The antenna is therefore short-circuited for DC-signals. On some of the dipoles, small end caps are added to the dipole arms in order to improve matching when loaded according to the position as explained in the "Measurement Conditions" paragraph. The SAR data are not affected by this change. The overall dipole length is still according to the Standard.

No excessive force must be applied to the dipole arms, because they might bend or the soldered connections near the feedpoint may be damaged.

### Additional EUT Data

Manufactured by	SPEAG
Manufactured on	March 11, 2011

## DASY5 Validation Report for Head TSL

Date: 06.02.2013

Test Laboratory: SPEAG, Zurich, Switzerland

**DUT: Dipole 1900 MHz; Type: D1900V2; Serial: D1900V2 - SN: 5d148**

Communication System: CW; Frequency: 1900 MHz

Medium parameters used:  $f = 1900$  MHz;  $\sigma = 1.38$  S/m;  $\epsilon_r = 39.4$ ;  $\rho = 1000$  kg/m<sup>3</sup>

Phantom section: Flat Section

Measurement Standard: DASY5 (IEEE/IEC/ANSI C63.19-2007)

DASY52 Configuration:

- Probe: ES3DV3 - SN3205; ConvF(4.98, 4.98, 4.98); Calibrated: 28.12.2012;
- Sensor-Surface: 3mm (Mechanical Surface Detection)
- Electronics: DAE4 Sn601; Calibrated: 27.06.2012
- Phantom: Flat Phantom 5.0 (front); Type: QD000P50AA; Serial: 1001
- DASY52 52.8.5(1059); SEMCAD X 14.6.8(7028)

### **Dipole Calibration for Head Tissue/Pin=250 mW, d=10mm/Zoom Scan (7x7x7)/Cube 0:**

Measurement grid: dx=5mm, dy=5mm, dz=5mm

Reference Value = 96.534 V/m; Power Drift = 0.05 dB

Peak SAR (extrapolated) = 17.8 W/kg

**SAR(1 g) = 9.87 W/kg; SAR(10 g) = 5.18 W/kg**

Maximum value of SAR (measured) = 12.1 W/kg

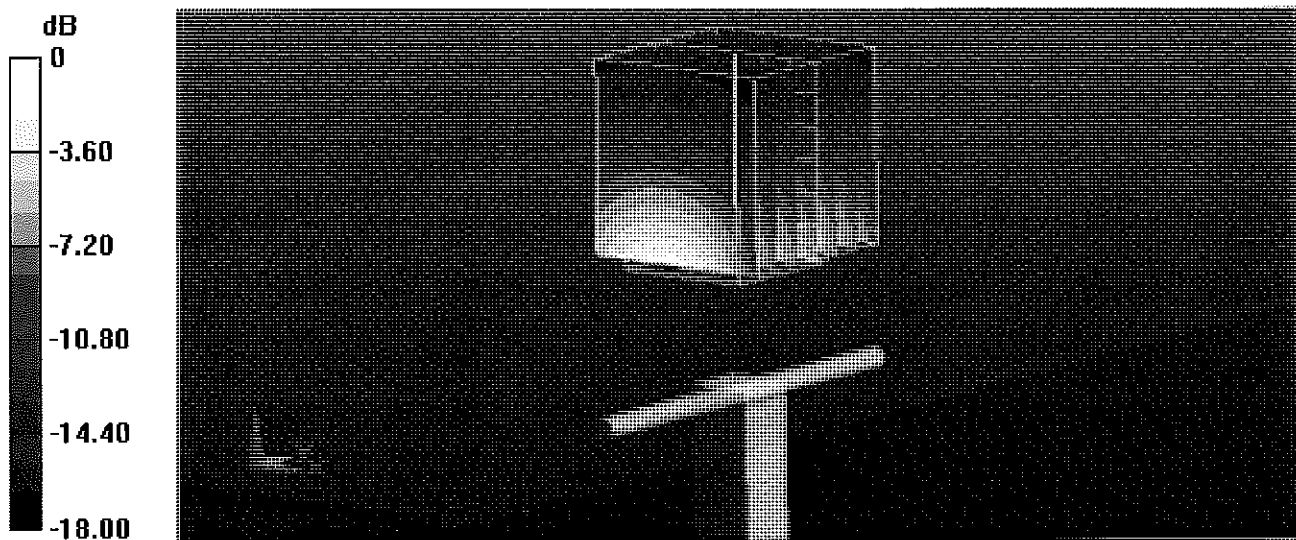

0 dB = 12.1 W/kg = 10.83 dBW/kg

# Impedance Measurement Plot for Head TSL

6 Feb 2013 09:25:10

CH1 S11 1 U FS

1: 52.125  $\Omega$  5.8711  $\Omega$  491.80  $\mu$ H

1 900.000 000 MHz

\*  
Del  
CA  
Avg  
16  
H1d

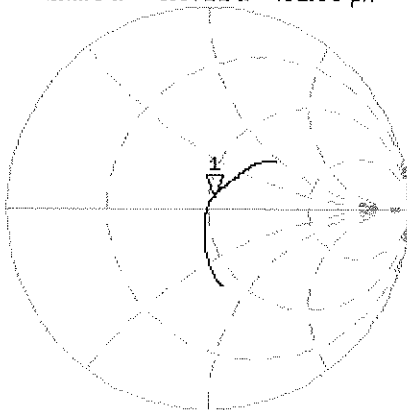

CH2 S11 LOG

5 dB/REF -20 dB

1: -24.287 dB 1 900.000 000 MHz

CA  
Avg  
16  
H1d

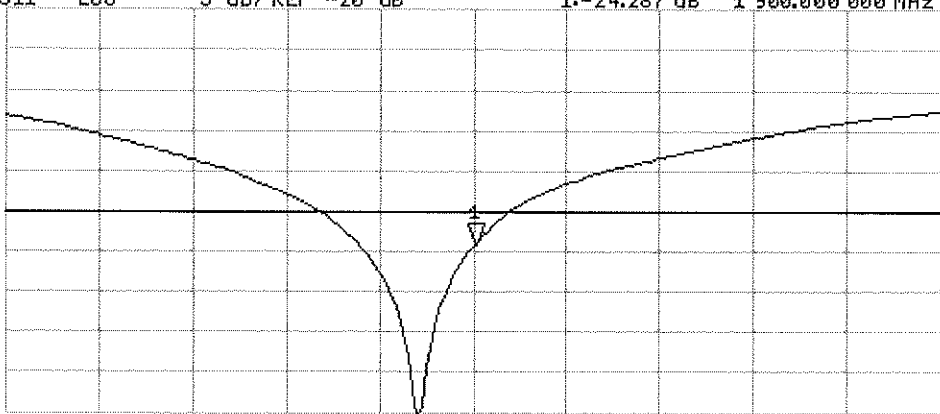

START 1 700.000 000 MHz

STOP 2 1 000.000 000 MHz

## DASY5 Validation Report for Body TSL

Date: 06.02.2013

Test Laboratory: SPEAG, Zurich, Switzerland

**DUT: Dipole 1900 MHz; Type: D1900V2; Serial: D1900V2 - SN: 5d148**

Communication System: CW; Frequency: 1900 MHz

Medium parameters used:  $f = 1900$  MHz;  $\sigma = 1.53$  S/m;  $\epsilon_r = 51.9$ ;  $\rho = 1000$  kg/m<sup>3</sup>

Phantom section: Flat Section

Measurement Standard: DASY5 (IEEE/IEC/ANSI C63.19-2007)

DASY52 Configuration:

- Probe: ES3DV3 - SN3205; ConvF(4.6, 4.6, 4.6); Calibrated: 28.12.2012;
- Sensor-Surface: 3mm (Mechanical Surface Detection)
- Electronics: DAE4 Sn601; Calibrated: 27.06.2012
- Phantom: Flat Phantom 5.0 (back); Type: QD000P50AA; Serial: 1002
- DASY52 52.8.5(1059); SEMCAD X 14.6.8(7028)

### Dipole Calibration for Body Tissue/Pin=250 mW, d=10mm/Zoom Scan (7x7x7)/Cube 0:

Measurement grid: dx=5mm, dy=5mm, dz=5mm

Reference Value = 96.534 V/m; Power Drift = -0.02 dB

Peak SAR (extrapolated) = 17.9 W/kg

**SAR(1 g) = 10.3 W/kg; SAR(10 g) = 5.45 W/kg**

Maximum value of SAR (measured) = 13.1 W/kg

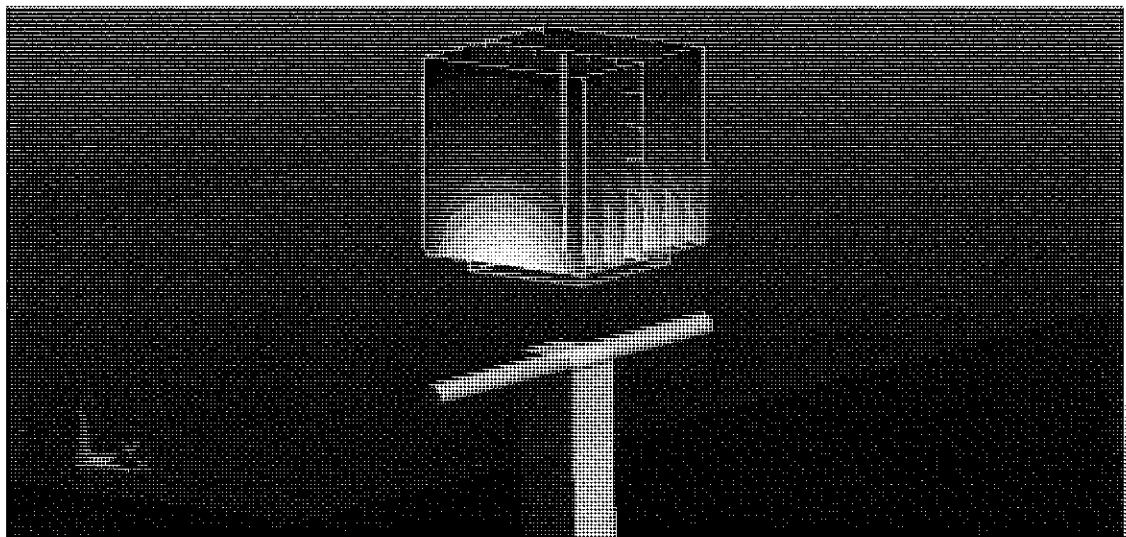
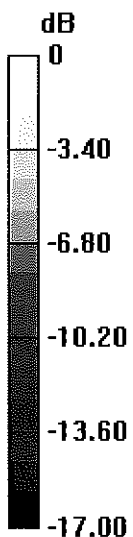

0 dB = 13.1 W/kg = 11.17 dBW/kg

# Impedance Measurement Plot for Body TSL

6 Feb 2013 09:24:17

CH1 S11 1 U FS 1: 48.344  $\Omega$  6.2715  $\Omega$  525.34  $\mu$ H 1 900.000 000 MHz

\*  
De1

CA

Avg  
16

H1d

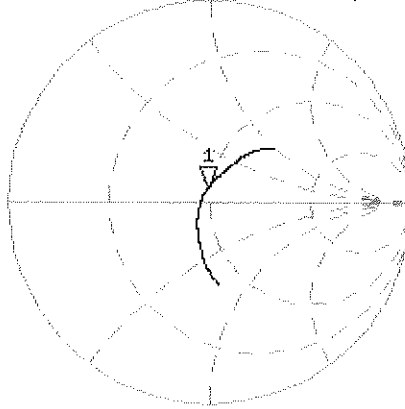

CH2 S11 LOG 5 dB/REF -20 dB 1:-23.628 dB 1 900.000 000 MHz

CA

Avg  
16

H1d

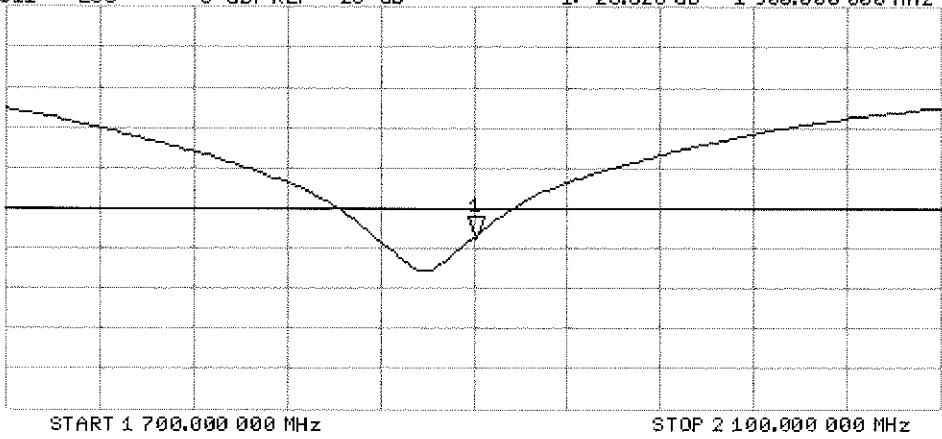



Accredited by the Swiss Accreditation Service (SAS)  
The Swiss Accreditation Service is one of the signatories to the EA  
Multilateral Agreement for the recognition of calibration certificates

Accreditation No.: **SCS 108**

Client **PC Test**

Certificate No: **D2450V2-882\_Feb13**

## CALIBRATION CERTIFICATE

Object **D2450V2 - SN: 882**

Calibration procedure(s) **QA CAL-05.v9**  
**Calibration procedure for dipole validation kits above 700 MHz**

Calibration date: **February 11, 2013**

*KOK  
2/21/13*

This calibration certificate documents the traceability to national standards, which realize the physical units of measurements (SI).  
The measurements and the uncertainties with confidence probability are given on the following pages and are part of the certificate.

All calibrations have been conducted in the closed laboratory facility: environment temperature ( $22 \pm 3$ )°C and humidity < 70%.

Calibration Equipment used (M&TE critical for calibration)

Primary Standards	ID #	Cal Date (Certificate No.)	Scheduled Calibration
Power meter EPM-442A	GB37480704	01-Nov-12 (No. 217-01640)	Oct-13
Power sensor HP 8481A	US37292783	01-Nov-12 (No. 217-01640)	Oct-13
Reference 20 dB Attenuator	SN: 5058 (20k)	27-Mar-12 (No. 217-01530)	Apr-13
Type-N mismatch combination	SN: 5047.3 / 06327	27-Mar-12 (No. 217-01533)	Apr-13
Reference Probe ES3DV3	SN: 3205	28-Dec-12 (No. ES3-3205_Dec12)	Dec-13
DAE4	SN: 601	27-Jun-12 (No. DAE4-601_Jun12)	Jun-13
Secondary Standards	ID #	Check Date (in house)	Scheduled Check
Power sensor HP 8481A	MY41092317	18-Oct-02 (in house check Oct-11)	In house check: Oct-13
RF generator R&S SMT-06	100005	04-Aug-99 (in house check Oct-11)	In house check: Oct-13
Network Analyzer HP 8753E	US37390585 S4206	18-Oct-01 (in house check Oct-12)	In house check: Oct-13

Calibrated by: **Israe El-Naouq**      Name: **Israe El-Naouq**      Function: **Laboratory Technician**

Approved by: **Katja Pokovic**      Name: **Katja Pokovic**      Technical Manager

Signature  
*Israe El-Naouq*  
*Katja Pokovic*

Issued: February 11, 2013

This calibration certificate shall not be reproduced except in full without written approval of the laboratory.



Accredited by the Swiss Accreditation Service (SAS)  
The Swiss Accreditation Service is one of the signatories to the EA  
Multilateral Agreement for the recognition of calibration certificates

Accreditation No.: **SCS 108**

**Glossary:**

TSL	tissue simulating liquid
ConvF	sensitivity in TSL / NORM x,y,z
N/A	not applicable or not measured

**Calibration is Performed According to the Following Standards:**

- a) IEEE Std 1528-2003, "IEEE Recommended Practice for Determining the Peak Spatial-Averaged Specific Absorption Rate (SAR) in the Human Head from Wireless Communications Devices: Measurement Techniques", December 2003
- b) IEC 62209-1, "Procedure to measure the Specific Absorption Rate (SAR) for hand-held devices used in close proximity to the ear (frequency range of 300 MHz to 3 GHz)", February 2005
- c) Federal Communications Commission Office of Engineering & Technology (FCC OET), "Evaluating Compliance with FCC Guidelines for Human Exposure to Radiofrequency Electromagnetic Fields; Additional Information for Evaluating Compliance of Mobile and Portable Devices with FCC Limits for Human Exposure to Radiofrequency Emissions", Supplement C (Edition 01-01) to Bulletin 65

**Additional Documentation:**

- d) DASY4/5 System Handbook

**Methods Applied and Interpretation of Parameters:**

- *Measurement Conditions:* Further details are available from the Validation Report at the end of the certificate. All figures stated in the certificate are valid at the frequency indicated.
- *Antenna Parameters with TSL:* The dipole is mounted with the spacer to position its feed point exactly below the center marking of the flat phantom section, with the arms oriented parallel to the body axis.
- *Feed Point Impedance and Return Loss:* These parameters are measured with the dipole positioned under the liquid filled phantom. The impedance stated is transformed from the measurement at the SMA connector to the feed point. The Return Loss ensures low reflected power. No uncertainty required.
- *Electrical Delay:* One-way delay between the SMA connector and the antenna feed point. No uncertainty required.
- *SAR measured:* SAR measured at the stated antenna input power.
- *SAR normalized:* SAR as measured, normalized to an input power of 1 W at the antenna connector.
- *SAR for nominal TSL parameters:* The measured TSL parameters are used to calculate the nominal SAR result.

The reported uncertainty of measurement is stated as the standard uncertainty of measurement multiplied by the coverage factor  $k=2$ , which for a normal distribution corresponds to a coverage probability of approximately 95%.

## Measurement Conditions

DASY system configuration, as far as not given on page 1.

<b>DASY Version</b>	DASY5	V52.8.5
<b>Extrapolation</b>	Advanced Extrapolation	
<b>Phantom</b>	Modular Flat Phantom	
<b>Distance Dipole Center - TSL</b>	10 mm	with Spacer
<b>Zoom Scan Resolution</b>	dx, dy, dz = 5 mm	
<b>Frequency</b>	2450 MHz $\pm$ 1 MHz	

## Head TSL parameters

The following parameters and calculations were applied.

	Temperature	Permittivity	Conductivity
<b>Nominal Head TSL parameters</b>	22.0 °C	39.2	1.80 mho/m
<b>Measured Head TSL parameters</b>	(22.0 $\pm$ 0.2) °C	37.9 $\pm$ 6 %	1.85 mho/m $\pm$ 6 %
<b>Head TSL temperature change during test</b>	< 0.5 °C	----	----

## SAR result with Head TSL

<b>SAR averaged over 1 cm<sup>3</sup> (1 g) of Head TSL</b>	Condition	
SAR measured	250 mW input power	13.2 W/kg
SAR for nominal Head TSL parameters	normalized to 1W	<b>51.7 W/kg <math>\pm</math> 17.0 % (k=2)</b>

<b>SAR averaged over 10 cm<sup>3</sup> (10 g) of Head TSL</b>	condition	
SAR measured	250 mW input power	6.07 W/kg
SAR for nominal Head TSL parameters	normalized to 1W	<b>24.0 W/kg <math>\pm</math> 16.5 % (k=2)</b>

## Body TSL parameters

The following parameters and calculations were applied.

	Temperature	Permittivity	Conductivity
<b>Nominal Body TSL parameters</b>	22.0 °C	52.7	1.95 mho/m
<b>Measured Body TSL parameters</b>	(22.0 $\pm$ 0.2) °C	50.9 $\pm$ 6 %	2.02 mho/m $\pm$ 6 %
<b>Body TSL temperature change during test</b>	< 0.5 °C	----	----

## SAR result with Body TSL

<b>SAR averaged over 1 cm<sup>3</sup> (1 g) of Body TSL</b>	Condition	
SAR measured	250 mW input power	12.8 W/kg
SAR for nominal Body TSL parameters	normalized to 1W	<b>49.9 W/kg <math>\pm</math> 17.0 % (k=2)</b>

<b>SAR averaged over 10 cm<sup>3</sup> (10 g) of Body TSL</b>	condition	
SAR measured	250 mW input power	5.91 W/kg
SAR for nominal Body TSL parameters	normalized to 1W	<b>23.3 W/kg <math>\pm</math> 16.5 % (k=2)</b>

## Appendix

### Antenna Parameters with Head TSL

Impedance, transformed to feed point	53.6 $\Omega$ - 0.4 j $\Omega$
Return Loss	- 29.0 dB

### Antenna Parameters with Body TSL

Impedance, transformed to feed point	49.5 $\Omega$ + 1.2 j $\Omega$
Return Loss	- 37.4 dB

### General Antenna Parameters and Design

Electrical Delay (one direction)	1.157 ns
----------------------------------	----------

After long term use with 100W radiated power, only a slight warming of the dipole near the feedpoint can be measured.

The dipole is made of standard semirigid coaxial cable. The center conductor of the feeding line is directly connected to the second arm of the dipole. The antenna is therefore short-circuited for DC-signals. On some of the dipoles, small end caps are added to the dipole arms in order to improve matching when loaded according to the position as explained in the "Measurement Conditions" paragraph. The SAR data are not affected by this change. The overall dipole length is still according to the Standard.

No excessive force must be applied to the dipole arms, because they might bend or the soldered connections near the feedpoint may be damaged.

### Additional EUT Data

Manufactured by	SPEAG
Manufactured on	October 06, 2011

## DASY5 Validation Report for Head TSL

Date: 11.02.2013

Test Laboratory: SPEAG, Zurich, Switzerland

**DUT: Dipole 2450 MHz; Type: D2450V2; Serial: D2450V2 - SN: 882**

Communication System: CW; Frequency: 2450 MHz

Medium parameters used:  $f = 2450$  MHz;  $\sigma = 1.85$  S/m;  $\epsilon_r = 37.9$ ;  $\rho = 1000$  kg/m<sup>3</sup>

Phantom section: Flat Section

Measurement Standard: DASY5 (IEEE/IEC/ANSI C63.19-2007)

DASY52 Configuration:

- Probe: ES3DV3 - SN3205; ConvF(4.52, 4.52, 4.52); Calibrated: 28.12.2012;
- Sensor-Surface: 3mm (Mechanical Surface Detection)
- Electronics: DAE4 Sn601; Calibrated: 27.06.2012
- Phantom: Flat Phantom 5.0 (front); Type: QD000P50AA; Serial: 1001
- DASY52 52.8.5(1059); SEMCAD X 14.6.8(7028)

### **Dipole Calibration for Head Tissue/Pin=250 mW, d=10mm/Zoom Scan (7x7x7)/Cube 0:**

Measurement grid: dx=5mm, dy=5mm, dz=5mm

Reference Value = 97.806 V/m; Power Drift = 0.05 dB

Peak SAR (extrapolated) = 27.6 W/kg

**SAR(1 g) = 13.2 W/kg; SAR(10 g) = 6.07 W/kg**

Maximum value of SAR (measured) = 16.7 W/kg

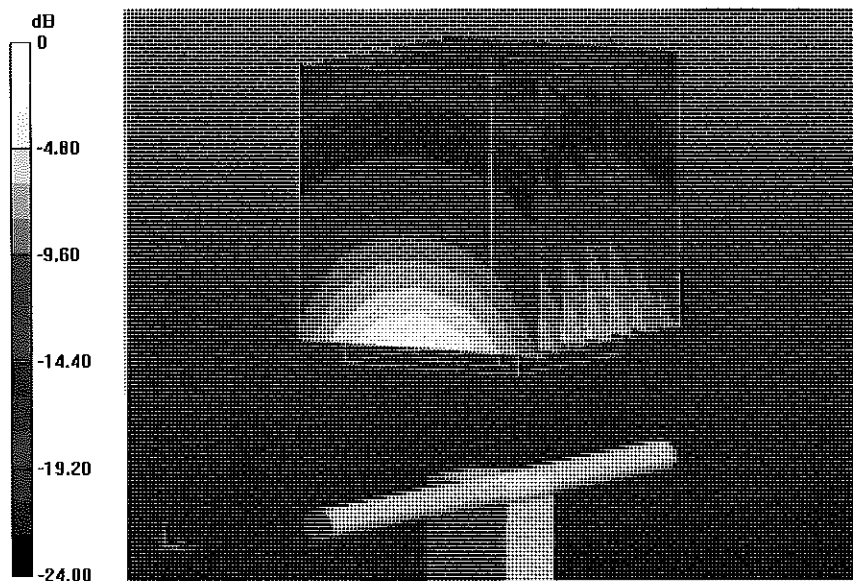

0 dB = 16.7 W/kg = 12.23 dBW/kg

# Impedance Measurement Plot for Head TSL

11 Feb 2013 11:51:51

CH1 S11 1 U FS 1: 53.639  $\Omega$  -363.28  $m\Omega$  178.82  $\mu F$  2 450.000 000 MHz

\*  
Del  
Cor  
Avg  
16  
H1d

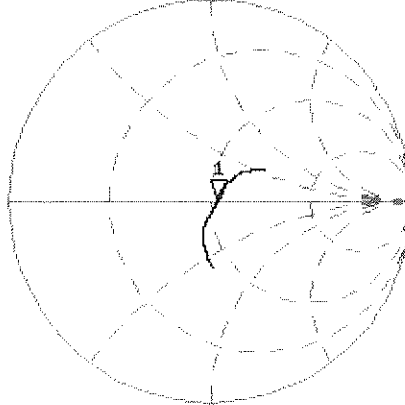

CH2 S11 LOG 5 dB/REF -20 dB 1:-29.047 dB 2 450.000 000 MHz

Cor  
Avg  
16  
H1d

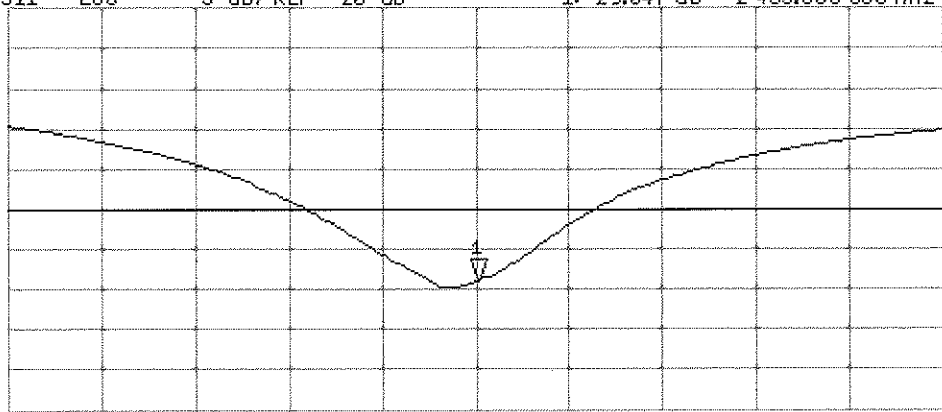

START 2 250.000 000 MHz

STOP 2 650.000 000 MHz

# DASY5 Validation Report for Body TSL

Date: 11.02.2013

Test Laboratory: SPEAG, Zurich, Switzerland

**DUT: Dipole 2450 MHz; Type: D2450V2; Serial: D2450V2 - SN: 882**

Communication System: CW; Frequency: 2450 MHz

Medium parameters used:  $f = 2450$  MHz;  $\sigma = 2.02$  S/m;  $\epsilon_r = 50.9$ ;  $\rho = 1000$  kg/m<sup>3</sup>

Phantom section: Flat Section

Measurement Standard: DASY5 (IEEE/IEC/ANSI C63.19-2007)

DASY52 Configuration:

- Probe: ES3DV3 - SN3205; ConvF(4.42, 4.42, 4.42); Calibrated: 28.12.2012;
- Sensor-Surface: 3mm (Mechanical Surface Detection)
- Electronics: DAE4 Sn601; Calibrated: 27.06.2012
- Phantom: Flat Phantom 5.0 (back); Type: QD000P50AA; Serial: 1002
- DASY52 52.8.5(1059); SEMCAD X 14.6.8(7028)

## Dipole Calibration for Body Tissue/Pin=250 mW, d=10mm/Zoom Scan (7x7x7)/Cube 0:

Measurement grid: dx=5mm, dy=5mm, dz=5mm

Reference Value = 94.474 V/m; Power Drift = 0.03 dB

Peak SAR (extrapolated) = 27.1 W/kg

**SAR(1 g) = 12.8 W/kg; SAR(10 g) = 5.91 W/kg**

Maximum value of SAR (measured) = 16.9 W/kg

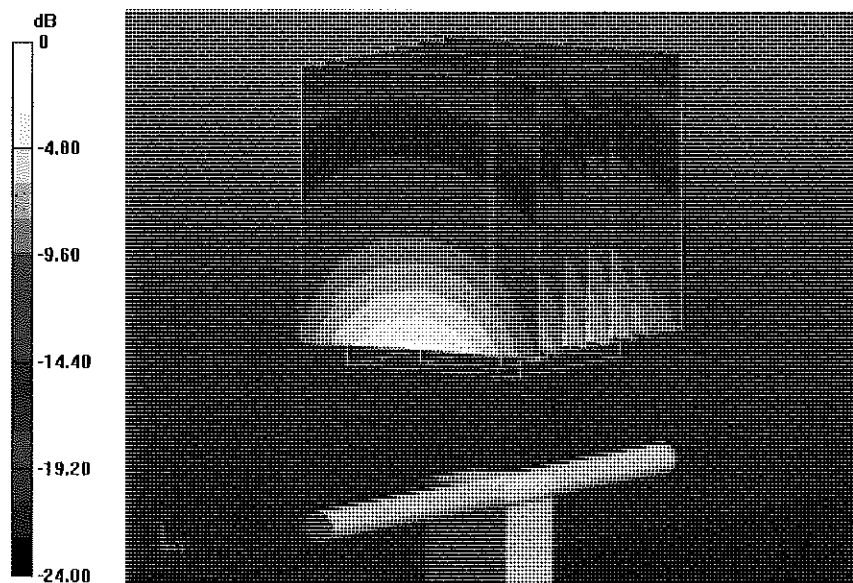

0 dB = 16.9 W/kg = 12.28 dBW/kg

# Impedance Measurement Plot for Body TSL

11 Feb 2013 11:51:25

CH1 S11 1 U FS 1: 49.500  $\Omega$  1.2461  $\mu$  80.948 pF 2 450.000 000 MHz

\*  
De1  
Cor  
Avg  
16  
H1d

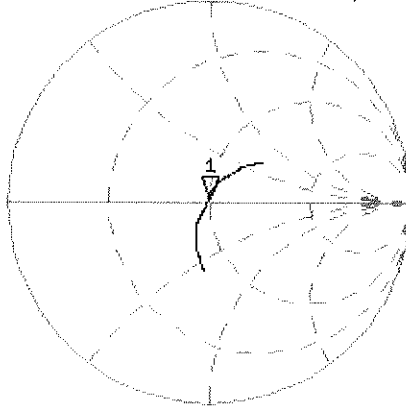

CH2 S11 LOG 5 dB/REF -20 dB 1: -37.374 dB 2 450.000 000 MHz

Cor  
Avg  
16  
H1d

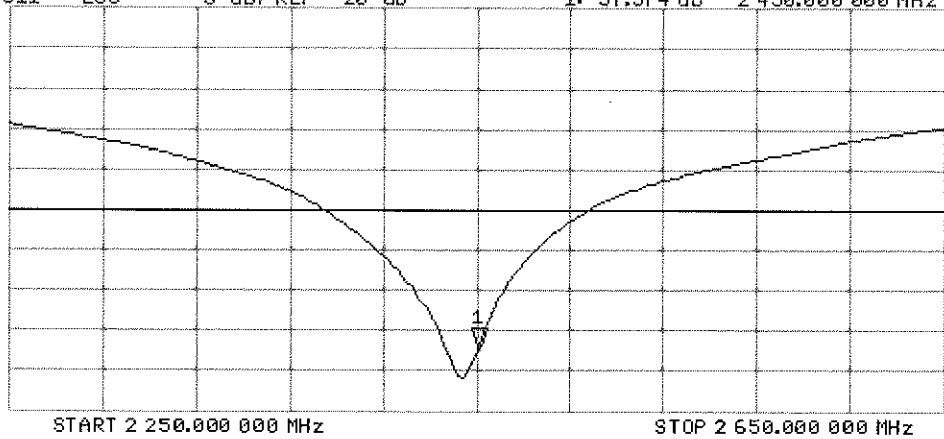

**Calibration Laboratory of  
Schmid & Partner  
Engineering AG**  
Zeughausstrasse 43, 8004 Zurich, Switzerland



**S** Schweizerischer Kalibrierdienst  
**C** Service suisse d'étalonnage  
**S** Servizio svizzero di taratura  
**S** Swiss Calibration Service

Accredited by the Swiss Accreditation Service (SAS)  
The Swiss Accreditation Service is one of the signatories to the EA  
Multilateral Agreement for the recognition of calibration certificates

Accreditation No.: **SCS 108**

Client **PC Test**

Certificate No: **D835V2-4d026\_Aug12**

## CALIBRATION CERTIFICATE

Object **D835V2 - SN: 4d026**

Calibration procedure(s) **QA CAL-05.v8  
Calibration procedure for dipole validation kits above 700 MHz**

Calibration date: **August 23, 2012**

*1/10K  
9/17/12*

This calibration certificate documents the traceability to national standards, which realize the physical units of measurements (SI).  
The measurements and the uncertainties with confidence probability are given on the following pages and are part of the certificate.

All calibrations have been conducted in the closed laboratory facility: environment temperature (22 ± 3)°C and humidity < 70%.

Calibration Equipment used (M&TE critical for calibration)

Primary Standards	ID #	Cal Date (Certificate No.)	Scheduled Calibration
Power meter EPM-442A	GB37480704	05-Oct-11 (No. 217-01451)	Oct-12
Power sensor HP 8481A	US37292783	05-Oct-11 (No. 217-01451)	Oct-12
Reference 20 dB Attenuator	SN: 5058 (20k)	27-Mar-12 (No. 217-01530)	Apr-13
Type-N mismatch combination	SN: 5047.2 / 06327	27-Mar-12 (No. 217-01533)	Apr-13
Reference Probe ES3DV3	SN: 3205	30-Dec-11 (No. ES3-3205_Dec11)	Dec-12
DAE4	SN: 601	27-Jun-12 (No. DAE4-601_Jun12)	Jun-13

Secondary Standards	ID #	Check Date (in house)	Scheduled Check
Power sensor HP 8481A	MY41092317	18-Oct-02 (in house check Oct-11)	In house check: Oct-13
RF generator R&S SMT-06	100005	04-Aug-99 (in house check Oct-11)	In house check: Oct-13
Network Analyzer HP 8753E	US37390585 S4206	18-Oct-01 (in house check Oct-11)	In house check: Oct-12

Calibrated by: **Israe El-Naouq**      Name: **Israe El-Naouq**      Function: **Laboratory Technician**

Approved by: **Katja Pokovic**      Name: **Katja Pokovic**      Function: **Technical Manager**

Signature  
*Israe El-Naouq*  
*Katja Pokovic*

Issued: August 23, 2012

This calibration certificate shall not be reproduced except in full without written approval of the laboratory.

**Calibration Laboratory of  
Schmid & Partner  
Engineering AG**  
Zeughausstrasse 43, 8004 Zurich, Switzerland



**S** Schweizerischer Kalibrierdienst  
**C** Service suisse d'étalonnage  
**S** Servizio svizzero di taratura  
**S** Swiss Calibration Service

Accredited by the Swiss Accreditation Service (SAS)  
The Swiss Accreditation Service is one of the signatories to the EA  
Multilateral Agreement for the recognition of calibration certificates

Accreditation No.: **SCS 108**

### Glossary:

TSL	tissue simulating liquid
ConvF	sensitivity in TSL / NORM x,y,z
N/A	not applicable or not measured

### Calibration is Performed According to the Following Standards:

- IEEE Std 1528-2003, "IEEE Recommended Practice for Determining the Peak Spatial-Averaged Specific Absorption Rate (SAR) in the Human Head from Wireless Communications Devices: Measurement Techniques", December 2003
- IEC 62209-1, "Procedure to measure the Specific Absorption Rate (SAR) for hand-held devices used in close proximity to the ear (frequency range of 300 MHz to 3 GHz)", February 2005
- Federal Communications Commission Office of Engineering & Technology (FCC OET), "Evaluating Compliance with FCC Guidelines for Human Exposure to Radiofrequency Electromagnetic Fields; Additional Information for Evaluating Compliance of Mobile and Portable Devices with FCC Limits for Human Exposure to Radiofrequency Emissions", Supplement C (Edition 01-01) to Bulletin 65

### Additional Documentation:

- DASY4/5 System Handbook

### Methods Applied and Interpretation of Parameters:

- Measurement Conditions:** Further details are available from the Validation Report at the end of the certificate. All figures stated in the certificate are valid at the frequency indicated.
- Antenna Parameters with TSL:** The dipole is mounted with the spacer to position its feed point exactly below the center marking of the flat phantom section, with the arms oriented parallel to the body axis.
- Feed Point Impedance and Return Loss:** These parameters are measured with the dipole positioned under the liquid filled phantom. The impedance stated is transformed from the measurement at the SMA connector to the feed point. The Return Loss ensures low reflected power. No uncertainty required.
- Electrical Delay:** One-way delay between the SMA connector and the antenna feed point. No uncertainty required.
- SAR measured:** SAR measured at the stated antenna input power.
- SAR normalized:** SAR as measured, normalized to an input power of 1 W at the antenna connector.
- SAR for nominal TSL parameters:** The measured TSL parameters are used to calculate the nominal SAR result.

The reported uncertainty of measurement is stated as the standard uncertainty of measurement multiplied by the coverage factor  $k=2$ , which for a normal distribution corresponds to a coverage probability of approximately 95%.

## Measurement Conditions

DASY system configuration, as far as not given on page 1.

DASY Version	DASY5	V52.8.2
Extrapolation	Advanced Extrapolation	
Phantom	Modular Flat Phantom	
Distance Dipole Center - TSL	15 mm	with Spacer
Zoom Scan Resolution	dx, dy, dz = 5 mm	
Frequency	835 MHz $\pm$ 1 MHz	

## Head TSL parameters

The following parameters and calculations were applied.

	Temperature	Permittivity	Conductivity
Nominal Head TSL parameters	22.0 °C	41.5	0.90 mho/m
Measured Head TSL parameters	(22.0 $\pm$ 0.2) °C	41.3 $\pm$ 6 %	0.90 mho/m $\pm$ 6 %
Head TSL temperature change during test	< 0.5 °C	---	---

## SAR result with Head TSL

SAR averaged over 1 cm <sup>3</sup> (1 g) of Head TSL	Condition	
SAR measured	250 mW input power	2.35 mW / g
SAR for nominal Head TSL parameters	normalized to 1W	<b>9.39 mW / g <math>\pm</math> 17.0 % (k=2)</b>

SAR averaged over 10 cm <sup>3</sup> (10 g) of Head TSL	condition	
SAR measured	250 mW input power	1.53 mW / g
SAR for nominal Head TSL parameters	normalized to 1W	<b>6.12 mW / g <math>\pm</math> 16.5 % (k=2)</b>

## Body TSL parameters

The following parameters and calculations were applied.

	Temperature	Permittivity	Conductivity
Nominal Body TSL parameters	22.0 °C	55.2	0.97 mho/m
Measured Body TSL parameters	(22.0 $\pm$ 0.2) °C	53.2 $\pm$ 6 %	1.00 mho/m $\pm$ 6 %
Body TSL temperature change during test	< 0.5 °C	---	---

## SAR result with Body TSL

SAR averaged over 1 cm <sup>3</sup> (1 g) of Body TSL	Condition	
SAR measured	250 mW input power	2.47 mW / g
SAR for nominal Body TSL parameters	normalized to 1W	<b>9.58 mW / g <math>\pm</math> 17.0 % (k=2)</b>

SAR averaged over 10 cm <sup>3</sup> (10 g) of Body TSL	condition	
SAR measured	250 mW input power	1.62 mW / g
SAR for nominal Body TSL parameters	normalized to 1W	<b>6.33 mW / g <math>\pm</math> 16.5 % (k=2)</b>

## Appendix

### Antenna Parameters with Head TSL

Impedance, transformed to feed point	53.7 $\Omega$ - 3.4 j $\Omega$
Return Loss	- 26.4 dB

### Antenna Parameters with Body TSL

Impedance, transformed to feed point	49.6 $\Omega$ - 4.8 j $\Omega$
Return Loss	- 26.4 dB

### General Antenna Parameters and Design

Electrical Delay (one direction)	1.389 ns
----------------------------------	----------

After long term use with 100W radiated power, only a slight warming of the dipole near the feedpoint can be measured.

The dipole is made of standard semirigid coaxial cable. The center conductor of the feeding line is directly connected to the second arm of the dipole. The antenna is therefore short-circuited for DC-signals. On some of the dipoles, small end caps are added to the dipole arms in order to improve matching when loaded according to the position as explained in the "Measurement Conditions" paragraph. The SAR data are not affected by this change. The overall dipole length is still according to the Standard.

No excessive force must be applied to the dipole arms, because they might bend or the soldered connections near the feedpoint may be damaged.

### Additional EUT Data

Manufactured by	SPEAG
Manufactured on	December 17, 2004

## DASY5 Validation Report for Head TSL

Date: 23.08.2012

Test Laboratory: SPEAG, Zurich, Switzerland

**DUT: Dipole 835 MHz; Type: D835V2; Serial: D835V2 - SN: 4d026**

Communication System: CW; Frequency: 835 MHz

Medium parameters used:  $f = 835$  MHz;  $\sigma = 0.9$  mho/m;  $\epsilon_r = 41.3$ ;  $\rho = 1000$  kg/m<sup>3</sup>

Phantom section: Flat Section

Measurement Standard: DASY5 (IEEE/IEC/ANSI C63.19-2007)

DASY52 Configuration:

- Probe: ES3DV3 - SN3205; ConvF(6.07, 6.07, 6.07); Calibrated: 30.12.2011;
- Sensor-Surface: 3mm (Mechanical Surface Detection)
- Electronics: DAE4 Sn601; Calibrated: 27.06.2012
- Phantom: Flat Phantom 4.9L; Type: QD000P49AA; Serial: 1001
- DASY52 52.8.2(969); SEMCAD X 14.6.6(6824)

### Dipole Calibration for Head Tissue/Pin=250 mW, d=15mm 2/Zoom Scan (7x7x7)/Cube 0:

Measurement grid: dx=5mm, dy=5mm, dz=5mm

Reference Value = 56.824 V/m; Power Drift = 0.01 dB

Peak SAR (extrapolated) = 3.482 mW/g

**SAR(1 g) = 2.35 mW/g; SAR(10 g) = 1.53 mW/g**

Maximum value of SAR (measured) = 2.72 W/kg

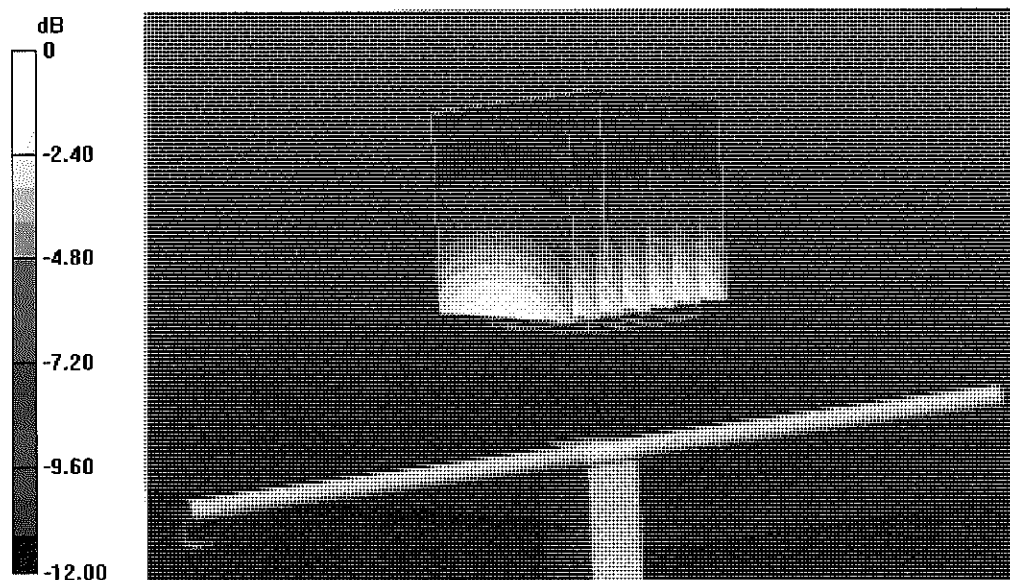

0 dB = 2.72 W/kg = 8.69 dB W/kg

# Impedance Measurement Plot for Head TSL

23 Aug 2012 12:19:04

CH1 S11 1 U FS

1: 53.662  $\Delta$  -3.3516  $\Delta$  56.870 pF

835.000 000 MHz

\*  
De1  
Cor

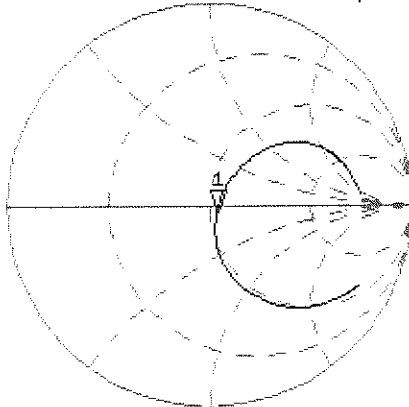

Avg  
15

H1d

CH2 S11 LOG 5 dB/REF -20 dB 1:-25.390 dB 835.000 000 MHz

Cor

Avg  
15

H1d

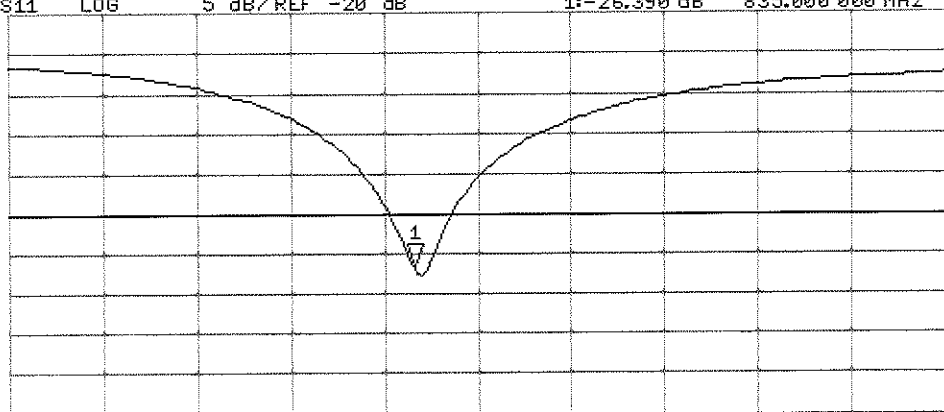

START 635.000 000 MHz

STOP 1 100.000 000 MHz

## DASY5 Validation Report for Body TSL

Date: 23.08.2012

Test Laboratory: SPEAG, Zurich, Switzerland

**DUT: Dipole 835 MHz; Type: D835V2; Serial: D835V2 - SN: 4d026**

Communication System: CW; Frequency: 835 MHz

Medium parameters used:  $f = 835$  MHz;  $\sigma = 1$  mho/m;  $\epsilon_r = 53.2$ ;  $\rho = 1000$  kg/m<sup>3</sup>

Phantom section: Flat Section

Measurement Standard: DASY5 (IEEE/IEC/ANSI C63.19-2007)

DASY52 Configuration:

- Probe: ES3DV3 - SN3205; ConvF(6.02, 6.02, 6.02); Calibrated: 30.12.2011;
- Sensor-Surface: 3mm (Mechanical Surface Detection)
- Electronics: DAE4 Sn601; Calibrated: 27.06.2012
- Phantom: Flat Phantom 4.9L; Type: QD000P49AA; Serial: 1001
- DASY52 52.8.2(969); SEMCAD X 14.6.6(6824)

### Dipole Calibration for Body Tissue/Pin=250 mW, d=15mm/Zoom Scan (7x7x7)/Cube 0:

Measurement grid: dx=5mm, dy=5mm, dz=5mm

Reference Value = 55.339 V/m; Power Drift = 0.04 dB

Peak SAR (extrapolated) = 3.592 mW/g

**SAR(1 g) = 2.47 mW/g; SAR(10 g) = 1.62 mW/g**

Maximum value of SAR (measured) = 2.87 W/kg

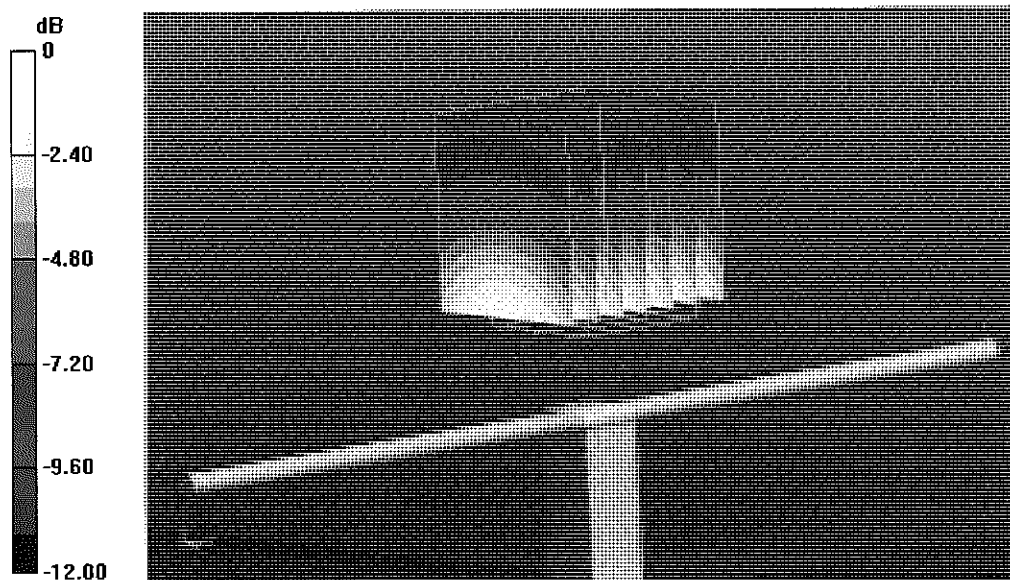

# Impedance Measurement Plot for Body TSL

23 Aug 2012 10:54:42

[CH1] S11 1 U FS

1: 49.557  $\angle$  -4.7500  $\angle$  40.127 pF

835.000 000 MHz

\*  
Del  
Cor

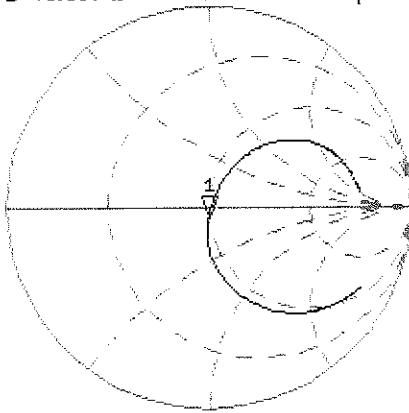

Avg  
16

H1d

CH2 S11 LOG 5 dB/REF -20 dB 1:-26.405 dB 835.000 000 MHz

Cor

Avg  
16

H1d

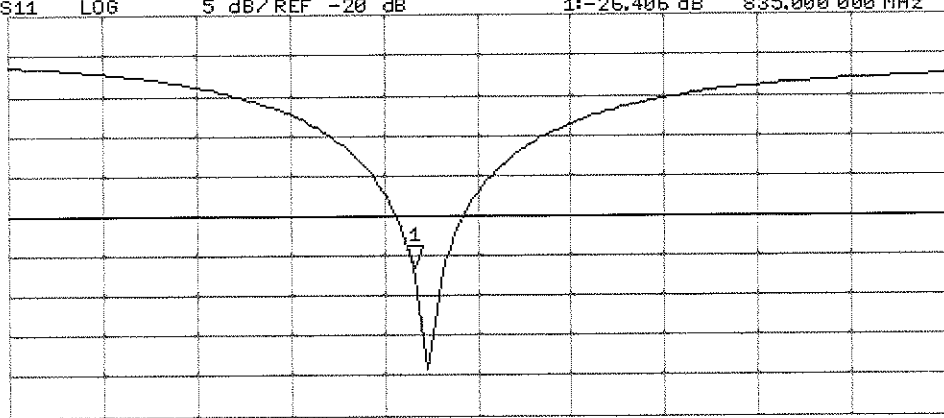

START 635.000 000 MHz

STOP 1 100.000 000 MHz



Accredited by the Swiss Accreditation Service (SAS)  
The Swiss Accreditation Service is one of the signatories to the EA  
Multilateral Agreement for the recognition of calibration certificates

Accreditation No.: **SCS 108**

Client **PC Test**

Certificate No: **D1900V2-5d141\_May13**

## CALIBRATION CERTIFICATE

Object **D1900V2 - SN: 5d141**

Calibration procedure(s) **QA CAL-05.v9  
Calibration procedure for dipole validation kits above 700 MHz**

Calibration date: **May 02, 2013**

✓  
5/8/13

This calibration certificate documents the traceability to national standards, which realize the physical units of measurements (SI).  
The measurements and the uncertainties with confidence probability are given on the following pages and are part of the certificate.

All calibrations have been conducted in the closed laboratory facility: environment temperature ( $22 \pm 3$ )°C and humidity < 70%.

Calibration Equipment used (M&TE critical for calibration)

Primary Standards	ID #	Cal Date (Certificate No.)	Scheduled Calibration
Power meter EPM-442A	GB37480704	01-Nov-12 (No. 217-01640)	Oct-13
Power sensor HP 8481A	US37292783	01-Nov-12 (No. 217-01640)	Oct-13
Reference 20 dB Attenuator	SN: 5058 (20k)	04-Apr-13 (No. 217-01736)	Apr-14
Type-N mismatch combination	SN: 5047.3 / 06327	04-Apr-13 (No. 217-01739)	Apr-14
Reference Probe ES3DV3	SN: 3205	28-Dec-12 (No. ES3-3205_Dec12)	Dec-13
DAE4	SN: 601	25-Apr-13 (No. DAE4-601_Apr13)	Apr-14
Secondary Standards	ID #	Check Date (in house)	Scheduled Check
Power sensor HP 8481A	MY41092317	18-Oct-02 (in house check Oct-11)	In house check: Oct-13
RF generator R&S SMT-06	100005	04-Aug-99 (in house check Oct-11)	In house check: Oct-13
Network Analyzer HP 8753E	US37390585 S4206	18-Oct-01 (in house check Oct-12)	In house check: Oct-13

Calibrated by: **Claudio Leubler**      Name: Claudio Leubler      Function: Laboratory Technician

Signature

Approved by: **Katja Pokovic**      Name: Katja Pokovic      Function: Technical Manager

*[Handwritten Signature]*

Issued: May 2, 2013

This calibration certificate shall not be reproduced except in full without written approval of the laboratory.



Accredited by the Swiss Accreditation Service (SAS)

The Swiss Accreditation Service is one of the signatories to the EA  
Multilateral Agreement for the recognition of calibration certificates

Accreditation No.: **SCS 108**

### Glossary:

TSL	tissue simulating liquid
ConvF	sensitivity in TSL / NORM x,y,z
N/A	not applicable or not measured

### Calibration is Performed According to the Following Standards:

- IEEE Std 1528-2003, "IEEE Recommended Practice for Determining the Peak Spatial-Averaged Specific Absorption Rate (SAR) in the Human Head from Wireless Communications Devices: Measurement Techniques", December 2003
- IEC 62209-1, "Procedure to measure the Specific Absorption Rate (SAR) for hand-held devices used in close proximity to the ear (frequency range of 300 MHz to 3 GHz)", February 2005
- Federal Communications Commission Office of Engineering & Technology (FCC OET), "Evaluating Compliance with FCC Guidelines for Human Exposure to Radiofrequency Electromagnetic Fields; Additional Information for Evaluating Compliance of Mobile and Portable Devices with FCC Limits for Human Exposure to Radiofrequency Emissions", Supplement C (Edition 01-01) to Bulletin 65

### Additional Documentation:

- DASY4/5 System Handbook

### Methods Applied and Interpretation of Parameters:

- Measurement Conditions:** Further details are available from the Validation Report at the end of the certificate. All figures stated in the certificate are valid at the frequency indicated.
- Antenna Parameters with TSL:** The dipole is mounted with the spacer to position its feed point exactly below the center marking of the flat phantom section, with the arms oriented parallel to the body axis.
- Feed Point Impedance and Return Loss:** These parameters are measured with the dipole positioned under the liquid filled phantom. The impedance stated is transformed from the measurement at the SMA connector to the feed point. The Return Loss ensures low reflected power. No uncertainty required.
- Electrical Delay:** One-way delay between the SMA connector and the antenna feed point. No uncertainty required.
- SAR measured:** SAR measured at the stated antenna input power.
- SAR normalized:** SAR as measured, normalized to an input power of 1 W at the antenna connector.
- SAR for nominal TSL parameters:** The measured TSL parameters are used to calculate the nominal SAR result.

The reported uncertainty of measurement is stated as the standard uncertainty of measurement multiplied by the coverage factor  $k=2$ , which for a normal distribution corresponds to a coverage probability of approximately 95%.

## Measurement Conditions

DASY system configuration, as far as not given on page 1.

DASY Version	DASY5	V52.8.6
Extrapolation	Advanced Extrapolation	
Phantom	Modular Flat Phantom	
Distance Dipole Center - TSL	10 mm	with Spacer
Zoom Scan Resolution	dx, dy, dz = 5 mm	
Frequency	1900 MHz $\pm$ 1 MHz	

## Head TSL parameters

The following parameters and calculations were applied.

	Temperature	Permittivity	Conductivity
Nominal Head TSL parameters	22.0 °C	40.0	1.40 mho/m
Measured Head TSL parameters	(22.0 $\pm$ 0.2) °C	39.3 $\pm$ 6 %	1.37 mho/m $\pm$ 6 %
Head TSL temperature change during test	< 0.5 °C	----	----

## SAR result with Head TSL

SAR averaged over 1 cm <sup>3</sup> (1 g) of Head TSL	Condition	
SAR measured	250 mW input power	10.1 W/kg
SAR for nominal Head TSL parameters	normalized to 1W	<b>40.8 W/kg <math>\pm</math> 17.0 % (k=2)</b>

SAR averaged over 10 cm <sup>3</sup> (10 g) of Head TSL	condition	
SAR measured	250 mW input power	5.30 W/kg
SAR for nominal Head TSL parameters	normalized to 1W	<b>21.3 W/kg <math>\pm</math> 16.5 % (k=2)</b>

## Body TSL parameters

The following parameters and calculations were applied.

	Temperature	Permittivity	Conductivity
Nominal Body TSL parameters	22.0 °C	53.3	1.52 mho/m
Measured Body TSL parameters	(22.0 $\pm$ 0.2) °C	54.0 $\pm$ 6 %	1.51 mho/m $\pm$ 6 %
Body TSL temperature change during test	< 0.5 °C	----	----

## SAR result with Body TSL

SAR averaged over 1 cm <sup>3</sup> (1 g) of Body TSL	Condition	
SAR measured	250 mW input power	10.3 W/kg
SAR for nominal Body TSL parameters	normalized to 1W	<b>41.5 W/kg <math>\pm</math> 17.0 % (k=2)</b>

SAR averaged over 10 cm <sup>3</sup> (10 g) of Body TSL	condition	
SAR measured	250 mW input power	5.51 W/kg
SAR for nominal Body TSL parameters	normalized to 1W	<b>22.1 W/kg <math>\pm</math> 16.5 % (k=2)</b>

## Appendix

### Antenna Parameters with Head TSL

Impedance, transformed to feed point	52.6 $\Omega$ + 4.9 j $\Omega$
Return Loss	- 25.3 dB

### Antenna Parameters with Body TSL

Impedance, transformed to feed point	48.3 $\Omega$ + 5.9 j $\Omega$
Return Loss	- 24.1 dB

### General Antenna Parameters and Design

Electrical Delay (one direction)	1.199 ns
----------------------------------	----------

After long term use with 100W radiated power, only a slight warming of the dipole near the feedpoint can be measured.

The dipole is made of standard semirigid coaxial cable. The center conductor of the feeding line is directly connected to the second arm of the dipole. The antenna is therefore short-circuited for DC-signals. On some of the dipoles, small end caps are added to the dipole arms in order to improve matching when loaded according to the position as explained in the "Measurement Conditions" paragraph. The SAR data are not affected by this change. The overall dipole length is still according to the Standard.

No excessive force must be applied to the dipole arms, because they might bend or the soldered connections near the feedpoint may be damaged.

### Additional EUT Data

Manufactured by	SPEAG
Manufactured on	March 11, 2011

## DASY5 Validation Report for Head TSL

Date: 02.05.2013

Test Laboratory: SPEAG, Zurich, Switzerland

**DUT: Dipole 1900 MHz; Type: D1900V2; Serial: D1900V2 - SN: 5d141**

Communication System: UID 0 - CW; Frequency: 1900 MHz

Medium parameters used:  $f = 1900$  MHz;  $\sigma = 1.37$  S/m;  $\epsilon_r = 39.3$ ;  $\rho = 1000$  kg/m<sup>3</sup>

Phantom section: Flat Section

Measurement Standard: DASY5 (IEEE/IEC/ANSI C63.19-2007)

DASY52 Configuration:

- Probe: ES3DV3 - SN3205; ConvF(4.98, 4.98, 4.98); Calibrated: 28.12.2012;
- Sensor-Surface: 3mm (Mechanical Surface Detection)
- Electronics: DAE4 Sn601; Calibrated: 25.04.2013
- Phantom: Flat Phantom 5.0 (front); Type: QD000P50AA; Serial: 1001
- DASY52 52.8.6(1115); SEMCAD X 14.6.9(7117)

### **Dipole Calibration for Head Tissue/Pin=250 mW, d=10mm/Zoom Scan (7x7x7)/Cube 0:**

Measurement grid: dx=5mm, dy=5mm, dz=5mm

Reference Value = 97.124 V/m; Power Drift = 0.05 dB

Peak SAR (extrapolated) = 18.2 W/kg

**SAR(1 g) = 10.1 W/kg; SAR(10 g) = 5.3 W/kg**

Maximum value of SAR (measured) = 12.5 W/kg

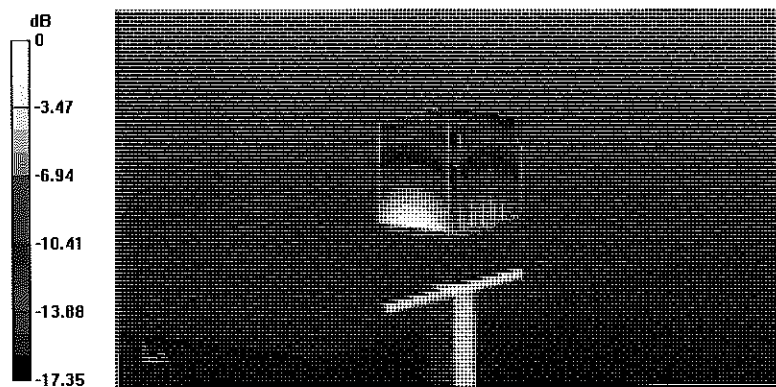

0 dB = 12.5 W/kg = 10.97 dBW/kg

# Impedance Measurement Plot for Head TSL

2 May 2013 15:38:50

CH1 S11 1 U FS 1: 52.600  $\Omega$  4.9375  $\Omega$  413.59  $\mu$ H 1 900.000 000 MHz

\*  
De1  
Cor  
Avg  
4

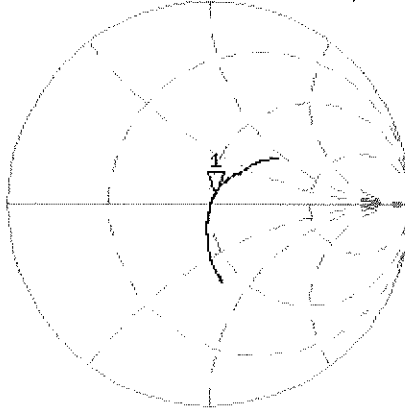

H1d

CH2 S11 LOG 5 dB/REF -20 dB 1:-25.293 dB 1 900.000 000 MHz

Cor  
Avg  
4

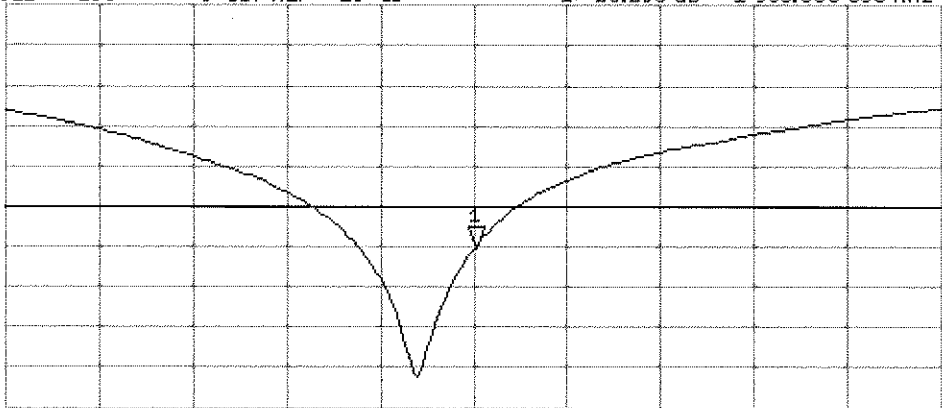

START 1 700.000 000 MHz

STOP 2 100.000 000 MHz

H1d

## DASY5 Validation Report for Body TSL

Date: 02.05.2013

Test Laboratory: SPEAG, Zurich, Switzerland

**DUT: Dipole 1900 MHz; Type: D1900V2; Serial: D1900V2 - SN: 5d141**

Communication System: UID 0 - CW; Frequency: 1900 MHz

Medium parameters used:  $f = 1900$  MHz;  $\sigma = 1.51$  S/m;  $\epsilon_r = 54$ ;  $\rho = 1000$  kg/m<sup>3</sup>

Phantom section: Flat Section

Measurement Standard: DASY5 (IEEE/IEC/ANSI C63.19-2007)

DASY52 Configuration:

- Probe: ES3DV3 - SN3205; ConvF(4.6, 4.6, 4.6); Calibrated: 28.12.2012;
- Sensor-Surface: 3mm (Mechanical Surface Detection)
- Electronics: DAE4 Sn601; Calibrated: 25.04.2013
- Phantom: Flat Phantom 5.0 (back); Type: QD000P50AA; Serial: 1002
- DASY52 52.8.6(1115); SEMCAD X 14.6.9(7117)

### Dipole Calibration for Body Tissue/Pin=250 mW, d=10mm/Zoom Scan (7x7x7)/Cube 0:

Measurement grid: dx=5mm, dy=5mm, dz=5mm

Reference Value = 97.124 V/m; Power Drift = -0.00 dB

Peak SAR (extrapolated) = 17.6 W/kg

**SAR(1 g) = 10.3 W/kg; SAR(10 g) = 5.51 W/kg**

Maximum value of SAR (measured) = 13.0 W/kg

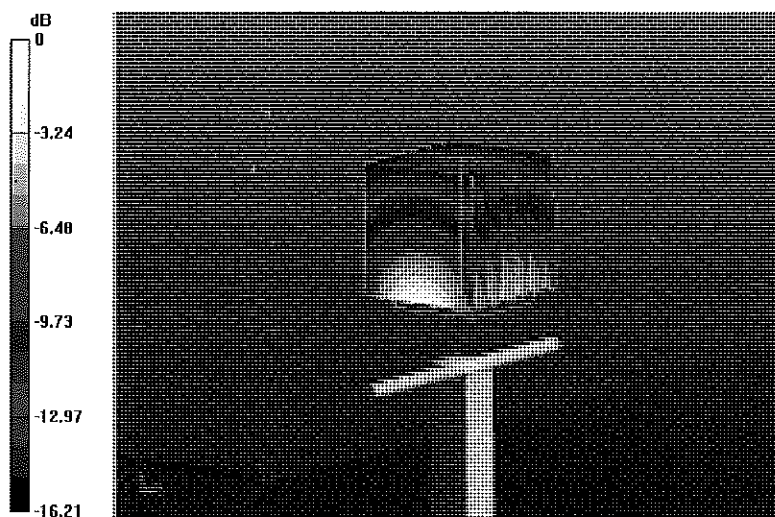

0 dB = 13.0 W/kg = 11.14 dBW/kg

# Impedance Measurement Plot for Body TSL

2 May 2013 15:38:04

[CH1] S11 1 U FS 1: 48.273  $\Omega$  5.9121  $\Omega$  495.23  $\mu$ H 1 900.000 000 MHz

\*  
De1  
Cor  
Avg  
16  
H1d

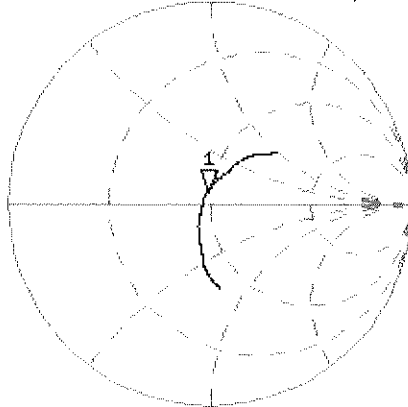

CH2 S11 LOG 5 dB/REF -20 dB 1:-24.074 dB 1 900.000 000 MHz

Cor  
Avg  
16  
H1d

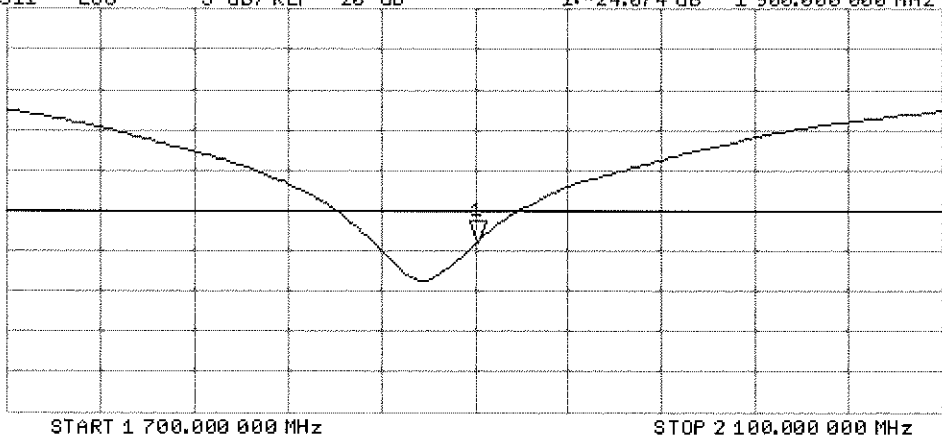



Accredited by the Swiss Accreditation Service (SAS)  
The Swiss Accreditation Service is one of the signatories to the EA  
Multilateral Agreement for the recognition of calibration certificates

Accreditation No.: **SCS 108**

Client **PC Test**

Certificate No: **D2450V2-797\_Jan13**

**CALIBRATION CERTIFICATE**

Object **D2450V2 - SN: 797**

Calibration procedure(s) **QA CAL-05.v9  
Calibration procedure for dipole validation kits above 700 MHz**

Calibration date: **January 08, 2013**

*KOK  
1/28/13*

This calibration certificate documents the traceability to national standards, which realize the physical units of measurements (SI).  
The measurements and the uncertainties with confidence probability are given on the following pages and are part of the certificate.

All calibrations have been conducted in the closed laboratory facility: environment temperature (22 ± 3)°C and humidity < 70%.

Calibration Equipment used (M&TE critical for calibration)

Primary Standards	ID #	Cal Date (Certificate No.)	Scheduled Calibration
Power meter EPM-442A	GB37480704	01-Nov-12 (No. 217-01640)	Oct-13
Power sensor HP 8481A	US37292783	01-Nov-12 (No. 217-01640)	Oct-13
Reference 20 dB Attenuator	SN: 5058 (20k)	27-Mar-12 (No. 217-01530)	Apr-13
Type-N mismatch combination	SN: 5047.3 / 06327	27-Mar-12 (No. 217-01533)	Apr-13
Reference Probe ES3DV3	SN: 3205	28-Dec-12 (No. ES3-3205_Dec12)	Dec-13
DAE4	SN: 601	27-Jun-12 (No. DAE4-601_Jun12)	Jun-13

Secondary Standards	ID #	Check Date (in house)	Scheduled Check
Power sensor HP 8481A	MY41092317	18-Oct-02 (in house check Oct-11)	In house check: Oct-13
RF generator R&S SMT-06	100005	04-Aug-99 (in house check Oct-11)	In house check: Oct-13
Network Analyzer HP 8753E	US37390585 S4206	18-Oct-01 (in house check Oct-12)	In house check: Oct-13

Calibrated by: **Israe El-Naouq** (Name) / **Laboratory Technician** (Function) / *Israe El-Naouq* (Signature)

Approved by: **Katja Pokovic** (Name) / **Technical Manager** (Function) / *Katja Pokovic* (Signature)

Issued: January 8, 2013

This calibration certificate shall not be reproduced except in full without written approval of the laboratory.



Accredited by the Swiss Accreditation Service (SAS)

The Swiss Accreditation Service is one of the signatories to the EA  
Multilateral Agreement for the recognition of calibration certificates

Accreditation No.: **SCS 108**

### Glossary:

TSL	tissue simulating liquid
ConvF	sensitivity in TSL / NORM x,y,z
N/A	not applicable or not measured

### Calibration is Performed According to the Following Standards:

- IEEE Std 1528-2003, "IEEE Recommended Practice for Determining the Peak Spatial-Averaged Specific Absorption Rate (SAR) in the Human Head from Wireless Communications Devices: Measurement Techniques", December 2003
- IEC 62209-1, "Procedure to measure the Specific Absorption Rate (SAR) for hand-held devices used in close proximity to the ear (frequency range of 300 MHz to 3 GHz)", February 2005
- Federal Communications Commission Office of Engineering & Technology (FCC OET), "Evaluating Compliance with FCC Guidelines for Human Exposure to Radiofrequency Electromagnetic Fields; Additional Information for Evaluating Compliance of Mobile and Portable Devices with FCC Limits for Human Exposure to Radiofrequency Emissions", Supplement C (Edition 01-01) to Bulletin 65

### Additional Documentation:

- DASY4/5 System Handbook

### Methods Applied and Interpretation of Parameters:

- Measurement Conditions:** Further details are available from the Validation Report at the end of the certificate. All figures stated in the certificate are valid at the frequency indicated.
- Antenna Parameters with TSL:** The dipole is mounted with the spacer to position its feed point exactly below the center marking of the flat phantom section, with the arms oriented parallel to the body axis.
- Feed Point Impedance and Return Loss:** These parameters are measured with the dipole positioned under the liquid filled phantom. The impedance stated is transformed from the measurement at the SMA connector to the feed point. The Return Loss ensures low reflected power. No uncertainty required.
- Electrical Delay:** One-way delay between the SMA connector and the antenna feed point. No uncertainty required.
- SAR measured:** SAR measured at the stated antenna input power.
- SAR normalized:** SAR as measured, normalized to an input power of 1 W at the antenna connector.
- SAR for nominal TSL parameters:** The measured TSL parameters are used to calculate the nominal SAR result.

The reported uncertainty of measurement is stated as the standard uncertainty of measurement multiplied by the coverage factor  $k=2$ , which for a normal distribution corresponds to a coverage probability of approximately 95%.

## Measurement Conditions

DASY system configuration, as far as not given on page 1.

DASY Version	DASY5	V52.8.4
Extrapolation	Advanced Extrapolation	
Phantom	Modular Flat Phantom	
Distance Dipole Center - TSL	10 mm	with Spacer
Zoom Scan Resolution	dx, dy, dz = 5 mm	
Frequency	2450 MHz $\pm$ 1 MHz	

## Head TSL parameters

The following parameters and calculations were applied.

	Temperature	Permittivity	Conductivity
Nominal Head TSL parameters	22.0 °C	39.2	1.80 mho/m
Measured Head TSL parameters	(22.0 $\pm$ 0.2) °C	37.9 $\pm$ 6 %	1.85 mho/m $\pm$ 6 %
Head TSL temperature change during test	< 0.5 °C	----	----

## SAR result with Head TSL

SAR averaged over 1 cm <sup>3</sup> (1 g) of Head TSL	Condition	
SAR measured	250 mW input power	13.4 W/kg
SAR for nominal Head TSL parameters	normalized to 1W	<b>52.5 W/kg <math>\pm</math> 17.0 % (k=2)</b>

SAR averaged over 10 cm <sup>3</sup> (10 g) of Head TSL	condition	
SAR measured	250 mW input power	6.20 W/kg
SAR for nominal Head TSL parameters	normalized to 1W	<b>24.5 W/kg <math>\pm</math> 16.5 % (k=2)</b>

## Body TSL parameters

The following parameters and calculations were applied.

	Temperature	Permittivity	Conductivity
Nominal Body TSL parameters	22.0 °C	52.7	1.95 mho/m
Measured Body TSL parameters	(22.0 $\pm$ 0.2) °C	50.5 $\pm$ 6 %	2.01 mho/m $\pm$ 6 %
Body TSL temperature change during test	< 0.5 °C	----	----

## SAR result with Body TSL

SAR averaged over 1 cm <sup>3</sup> (1 g) of Body TSL	Condition	
SAR measured	250 mW input power	12.7 W/kg
SAR for nominal Body TSL parameters	normalized to 1W	<b>49.6 W/kg <math>\pm</math> 17.0 % (k=2)</b>

SAR averaged over 10 cm <sup>3</sup> (10 g) of Body TSL	condition	
SAR measured	250 mW input power	5.88 W/kg
SAR for nominal Body TSL parameters	normalized to 1W	<b>23.2 W/kg <math>\pm</math> 16.5 % (k=2)</b>

## Appendix

### Antenna Parameters with Head TSL

Impedance, transformed to feed point	53.3 $\Omega$ + 3.1 j $\Omega$
Return Loss	- 27.1 dB

### Antenna Parameters with Body TSL

Impedance, transformed to feed point	49.1 $\Omega$ + 4.9 j $\Omega$
Return Loss	- 26.0 dB

### General Antenna Parameters and Design

Electrical Delay (one direction)	1.152 ns
----------------------------------	----------

After long term use with 100W radiated power, only a slight warming of the dipole near the feedpoint can be measured.

The dipole is made of standard semirigid coaxial cable. The center conductor of the feeding line is directly connected to the second arm of the dipole. The antenna is therefore short-circuited for DC-signals. On some of the dipoles, small end caps are added to the dipole arms in order to improve matching when loaded according to the position as explained in the "Measurement Conditions" paragraph. The SAR data are not affected by this change. The overall dipole length is still according to the Standard.

No excessive force must be applied to the dipole arms, because they might bend or the soldered connections near the feedpoint may be damaged.

### Additional EUT Data

Manufactured by	SPEAG
Manufactured on	January 24, 2006

## DASY5 Validation Report for Head TSL

Date: 08.01.2013

Test Laboratory: SPEAG, Zurich, Switzerland

**DUT: Dipole 2450 MHz; Type: D2450V2; Serial: D2450V2 - SN: 797**

Communication System: CW; Frequency: 2450 MHz

Medium parameters used:  $f = 2450$  MHz;  $\sigma = 1.85$  S/m;  $\epsilon_r = 37.9$ ;  $\rho = 1000$  kg/m<sup>3</sup>

Phantom section: Flat Section

Measurement Standard: DASY5 (IEEE/IEC/ANSI C63.19-2007)

DASY52 Configuration:

- Probe: ES3DV3 - SN3205; ConvF(4.52, 4.52, 4.52); Calibrated: 28.12.2012;
- Sensor-Surface: 3mm (Mechanical Surface Detection)
- Electronics: DAE4 Sn601; Calibrated: 27.06.2012
- Phantom: Flat Phantom 5.0 (front); Type: QD000P50AA; Serial: 1001
- DASY52 52.8.4(1052); SEMCAD X 14.6.8(7028)

### Dipole Calibration for Head Tissue/ $P_{in}=250$ mW, $d=10$ mm/Zoom Scan (7x7x7)/Cube 0:

Measurement grid:  $dx=5$ mm,  $dy=5$ mm,  $dz=5$ mm

Reference Value = 99.154 V/m; Power Drift = 0.06 dB

Peak SAR (extrapolated) = 27.8 W/kg

**SAR(1 g) = 13.4 W/kg; SAR(10 g) = 6.2 W/kg**

Maximum value of SAR (measured) = 17.0 W/kg

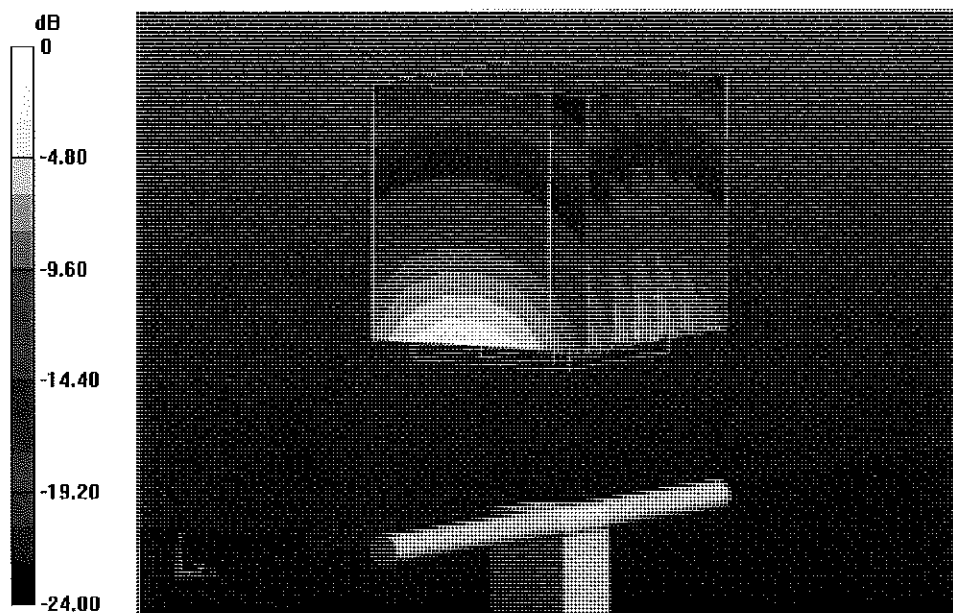

0 dB = 17.0 W/kg = 12.30 dBW/kg

# Impedance Measurement Plot for Head TSL

8 Jan 2013 12:37:14

CH1 S11 1 U FS 1: 53.346  $\Delta$  3.0762  $\Delta$  199.83 pH 2 450.000 000 MHz

#  
De1

Cor

Avg  
16

H1d

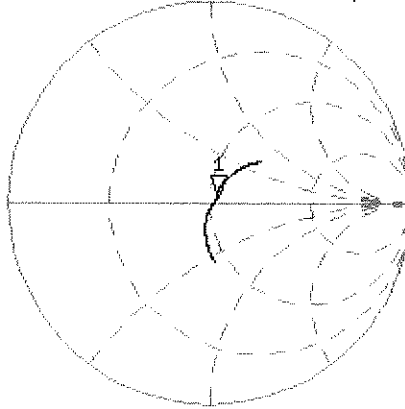

CH2 S11 LOG 5 dB/REF -20 dB 1: -27.136 dB 2 450.000 000 MHz

Cor

Avg  
16

H1d

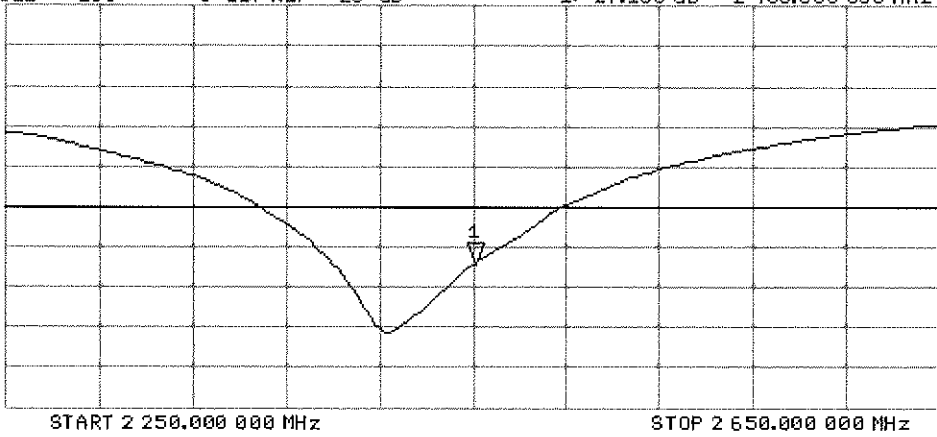

## DASY5 Validation Report for Body TSL

Date: 08.01.2013

Test Laboratory: SPEAG, Zurich, Switzerland

**DUT: Dipole 2450 MHz; Type: D2450V2; Serial: D2450V2 - SN: 797**

Communication System: CW; Frequency: 2450 MHz

Medium parameters used:  $f = 2450$  MHz;  $\sigma = 2.01$  S/m;  $\epsilon_r = 50.5$ ;  $\rho = 1000$  kg/m<sup>3</sup>

Phantom section: Flat Section

Measurement Standard: DASY5 (IEEE/IEC/ANSI C63.19-2007)

DASY52 Configuration:

- Probe: ES3DV3 - SN3205; ConvF(4.42, 4.42, 4.42); Calibrated: 28.12.2012;
- Sensor-Surface: 3mm (Mechanical Surface Detection)
- Electronics: DAE4 Sn601; Calibrated: 27.06.2012
- Phantom: Flat Phantom 5.0 (back); Type: QD000P50AA; Serial: 1002
- DASY52 52.8.4(1052); SEMCAD X 14.6.8(7028)

### **Dipole Calibration for Body Tissue/Pin=250 mW, d=10mm/Zoom Scan (7x7x7)/Cube 0:**

Measurement grid: dx=5mm, dy=5mm, dz=5mm

Reference Value = 93.935 V/m; Power Drift = 0.01 dB

Peak SAR (extrapolated) = 26.7 W/kg

**SAR(1 g) = 12.7 W/kg; SAR(10 g) = 5.88 W/kg**

Maximum value of SAR (measured) = 16.7 W/kg

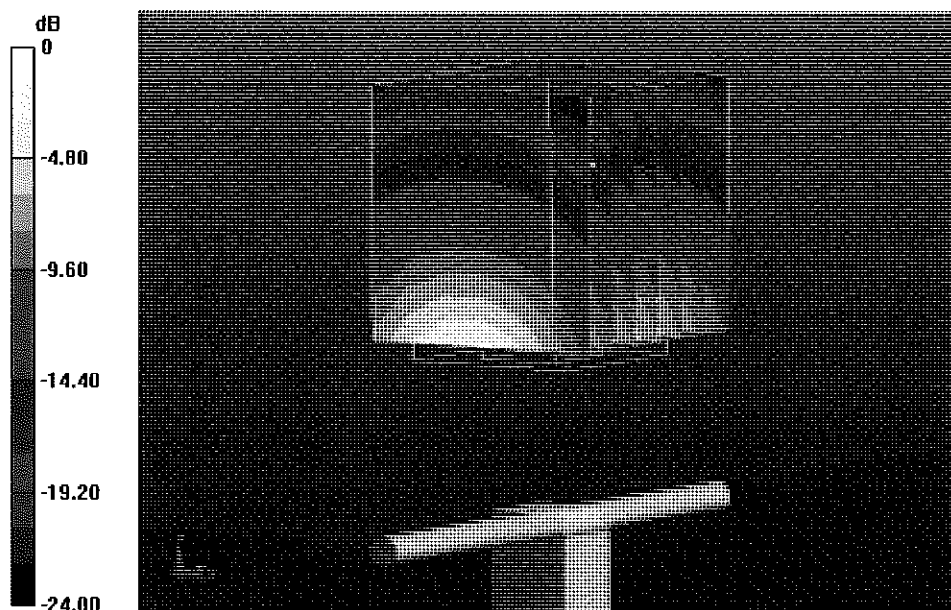

0 dB = 16.7 W/kg = 12.23 dBW/kg

# Impedance Measurement Plot for Body TSL

8 Jan 2013 12:36:45

CH1 S11 1 U FS

1: 49.090  $\angle$  4.9102  $\angle$  318.97  $\mu$ H

2 450.000 000 MHz

\*  
De1

Cor

Avg  
16

H1d

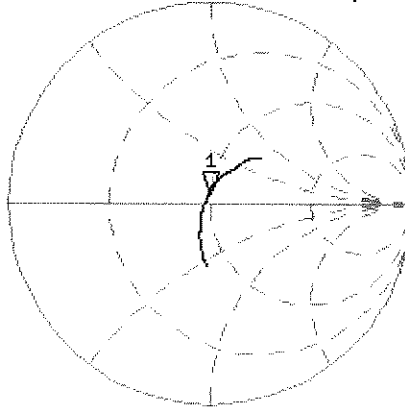

CH2 S11 LOG 5 dB/REF -20 dB 1: -25.963 dB 2 450.000 000 MHz

Cor

Avg  
16

H1d

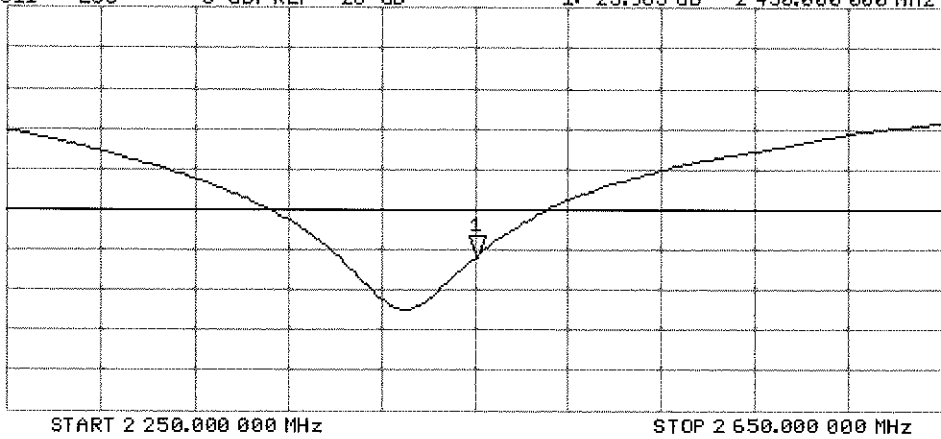



Accredited by the Swiss Accreditation Service (SAS)  
The Swiss Accreditation Service is one of the signatories to the EA  
Multilateral Agreement for the recognition of calibration certificates

Accreditation No.: **SCS 108**

Client **PC Test**

Certificate No: **ES3-3318\_Apr13**

## CALIBRATION CERTIFICATE

Object **ES3DV3 - SN:3318**

Calibration procedure(s) **QA CAL-01.v8, QA CAL-23.v4, QA CAL-25.v4  
Calibration procedure for dosimetric E-field probes**

Calibration date: **April 29, 2013**

This calibration certificate documents the traceability to national standards, which realize the physical units of measurements (SI).  
The measurements and the uncertainties with confidence probability are given on the following pages and are part of the certificate.

All calibrations have been conducted in the closed laboratory facility: environment temperature (22 ± 3)°C and humidity < 70%.

Calibration Equipment used (M&TE critical for calibration)

Primary Standards	ID	Cal Date (Certificate No.)	Scheduled Calibration
Power meter E4419B	GB41293874	04-Apr-13 (No. 217-01733)	Apr-14
Power sensor E4412A	MY41498087	04-Apr-13 (No. 217-01733)	Apr-14
Reference 3 dB Attenuator	SN: S5054 (3c)	04-Apr-13 (No. 217-01737)	Apr-14
Reference 20 dB Attenuator	SN: S5277 (20x)	04-Apr-13 (No. 217-01735)	Apr-14
Reference 30 dB Attenuator	SN: S5129 (30b)	04-Apr-13 (No. 217-01738)	Apr-14
Reference Probe ES3DV2	SN: 3013	28-Dec-12 (No. ES3-3013_Dec12)	Dec-13
DAE4	SN: 660	31-Jan-13 (No. DAE4-660_Jan13)	Jan-14
Secondary Standards	ID	Check Date (in house)	Scheduled Check
RF generator HP 8648C	US3642U01700	4-Aug-99 (in house check Apr-13)	In house check: Apr-15
Network Analyzer HP 8753E	US37390585	18-Oct-01 (in house check Oct-12)	In house check: Oct-13

	Name	Function	Signature
Calibrated by:	Dimce Iliev	Laboratory Technician	
Approved by:	Katja Pokovic	Technical Manager	
			Issued: April 29, 2013
This calibration certificate shall not be reproduced except in full without written approval of the laboratory.			



Accredited by the Swiss Accreditation Service (SAS)

Accreditation No.: **SCS 108**

The Swiss Accreditation Service is one of the signatories to the EA  
 Multilateral Agreement for the recognition of calibration certificates

### Glossary:

TSL	tissue simulating liquid
NORM <sub>x,y,z</sub>	sensitivity in free space
ConvF	sensitivity in TSL / NORM <sub>x,y,z</sub>
DCP	diode compression point
CF	crest factor (1/duty_cycle) of the RF signal
A, B, C, D	modulation dependent linearization parameters
Polarization $\varphi$	$\varphi$ rotation around probe axis
Polarization $\vartheta$	$\vartheta$ rotation around an axis that is in the plane normal to probe axis (at measurement center), i.e., $\vartheta = 0$ is normal to probe axis

### Calibration is Performed According to the Following Standards:

- IEEE Std 1528-2003, "IEEE Recommended Practice for Determining the Peak Spatial-Averaged Specific Absorption Rate (SAR) in the Human Head from Wireless Communications Devices: Measurement Techniques", December 2003
- IEC 62209-1, "Procedure to measure the Specific Absorption Rate (SAR) for hand-held devices used in close proximity to the ear (frequency range of 300 MHz to 3 GHz)", February 2005

### Methods Applied and Interpretation of Parameters:

- NORM<sub>x,y,z</sub>**: Assessed for E-field polarization  $\vartheta = 0$  ( $f \leq 900$  MHz in TEM-cell;  $f > 1800$  MHz: R22 waveguide). NORM<sub>x,y,z</sub> are only intermediate values, i.e., the uncertainties of NORM<sub>x,y,z</sub> does not affect the E<sup>2</sup>-field uncertainty inside TSL (see below ConvF).
- NORM(f)<sub>x,y,z</sub>** = NORM<sub>x,y,z</sub> \* frequency\_response (see Frequency Response Chart). This linearization is implemented in DASY4 software versions later than 4.2. The uncertainty of the frequency response is included in the stated uncertainty of ConvF.
- DCP<sub>x,y,z</sub>**: DCP are numerical linearization parameters assessed based on the data of power sweep with CW signal (no uncertainty required). DCP does not depend on frequency nor media.
- PAR**: PAR is the Peak to Average Ratio that is not calibrated but determined based on the signal characteristics
- A<sub>x,y,z</sub>; B<sub>x,y,z</sub>; C<sub>x,y,z</sub>; D<sub>x,y,z</sub>; VR<sub>x,y,z</sub>; A, B, C, D** are numerical linearization parameters assessed based on the data of power sweep for specific modulation signal. The parameters do not depend on frequency nor media. VR is the maximum calibration range expressed in RMS voltage across the diode.
- ConvF and Boundary Effect Parameters**: Assessed in flat phantom using E-field (or Temperature Transfer Standard for  $f \leq 800$  MHz) and inside waveguide using analytical field distributions based on power measurements for  $f > 800$  MHz. The same setups are used for assessment of the parameters applied for boundary compensation (alpha, depth) of which typical uncertainty values are given. These parameters are used in DASY4 software to improve probe accuracy close to the boundary. The sensitivity in TSL corresponds to NORM<sub>x,y,z</sub> \* ConvF whereby the uncertainty corresponds to that given for ConvF. A frequency dependent ConvF is used in DASY version 4.4 and higher which allows extending the validity from  $\pm 50$  MHz to  $\pm 100$  MHz.
- Spherical isotropy (3D deviation from isotropy)**: in a field of low gradients realized using a flat phantom exposed by a patch antenna.
- Sensor Offset**: The sensor offset corresponds to the offset of virtual measurement center from the probe tip (on probe axis). No tolerance required.

# Probe ES3DV3

## SN:3318

Manufactured: January 10, 2012  
Calibrated: April 29, 2013

**Calibrated for DASV/EASY Systems**  
(Note: non-compatible with DASV2 system!)

## DASY/EASY - Parameters of Probe: ES3DV3 - SN:3318

### Basic Calibration Parameters

	Sensor X	Sensor Y	Sensor Z	Unc (k=2)
Norm ( $\mu\text{V}/(\text{V}/\text{m})^2$ ) <sup>A</sup>	1.15	0.92	1.29	± 10.1 %
DCP (mV) <sup>B</sup>	102.6	105.4	100.8	

### Modulation Calibration Parameters

UID	Communication System Name		A dB	B dB/ $\mu\text{V}$	C	D dB	VR mV	Unc <sup>E</sup> (k=2)
0	CW	X	0.0	0.0	1.0	0.00	153.6	±3.5 %
		Y	0.0	0.0	1.0		133.8	
		Z	0.0	0.0	1.0		154.8	

The reported uncertainty of measurement is stated as the standard uncertainty of measurement multiplied by the coverage factor k=2, which for a normal distribution corresponds to a coverage probability of approximately 95%.

<sup>A</sup> The uncertainties of NormX,Y,Z do not affect the E<sup>2</sup>-field uncertainty inside TSL (see Pages 5 and 6).

<sup>B</sup> Numerical linearization parameter: uncertainty not required.

<sup>E</sup> Uncertainty is determined using the max. deviation from linear response applying rectangular distribution and is expressed for the square of the field value.

## DASY/EASY - Parameters of Probe: ES3DV3 - SN:3318

### Calibration Parameter Determined in Head Tissue Simulating Media

f (MHz) <sup>C</sup>	Relative Permittivity <sup>F</sup>	Conductivity (S/m) <sup>F</sup>	ConvF X	ConvF Y	ConvF Z	Alpha	Depth (mm)	Unct. (k=2)
750	41.9	0.89	6.59	6.59	6.59	0.25	2.12	± 12.0 %
850	41.5	0.92	6.33	6.33	6.33	0.57	1.25	± 12.0 %
1900	40.0	1.40	5.22	5.22	5.22	0.79	1.25	± 12.0 %
2450	39.2	1.80	4.59	4.59	4.59	0.80	1.30	± 12.0 %

<sup>C</sup> Frequency validity of ± 100 MHz only applies for DASY v4.4 and higher (see Page 2), else it is restricted to ± 50 MHz. The uncertainty is the RSS of the ConvF uncertainty at calibration frequency and the uncertainty for the indicated frequency band.

<sup>F</sup> At frequencies below 3 GHz, the validity of tissue parameters ( $\epsilon$  and  $\sigma$ ) can be relaxed to ± 10% if liquid compensation formula is applied to measured SAR values. At frequencies above 3 GHz, the validity of tissue parameters ( $\epsilon$  and  $\sigma$ ) is restricted to ± 5%. The uncertainty is the RSS of the ConvF uncertainty for indicated target tissue parameters.

## DASY/EASY - Parameters of Probe: ES3DV3 - SN:3318

### Calibration Parameter Determined in Body Tissue Simulating Media

f (MHz) <sup>C</sup>	Relative Permittivity <sup>F</sup>	Conductivity (S/m) <sup>F</sup>	ConvF X	ConvF Y	ConvF Z	Alpha	Depth (mm)	Unct. (k=2)
750	55.5	0.96	6.35	6.35	6.35	0.53	1.42	± 12.0 %
850	55.2	0.99	6.21	6.21	6.21	0.57	1.38	± 12.0 %
1900	53.3	1.52	4.79	4.79	4.79	0.46	1.77	± 12.0 %
2450	52.7	1.95	4.31	4.31	4.31	0.80	1.09	± 12.0 %

<sup>C</sup> Frequency validity of ± 100 MHz only applies for DASY v4.4 and higher (see Page 2), else it is restricted to ± 50 MHz. The uncertainty is the RSS of the ConvF uncertainty at calibration frequency and the uncertainty for the indicated frequency band.

<sup>F</sup> At frequencies below 3 GHz, the validity of tissue parameters ( $\epsilon$  and  $\sigma$ ) can be relaxed to ± 10% if liquid compensation formula is applied to measured SAR values. At frequencies above 3 GHz, the validity of tissue parameters ( $\epsilon$  and  $\sigma$ ) is restricted to ± 5%. The uncertainty is the RSS of the ConvF uncertainty for indicated target tissue parameters.

### Frequency Response of E-Field (TEM-Cell:ifi110 EXX, Waveguide: R22)

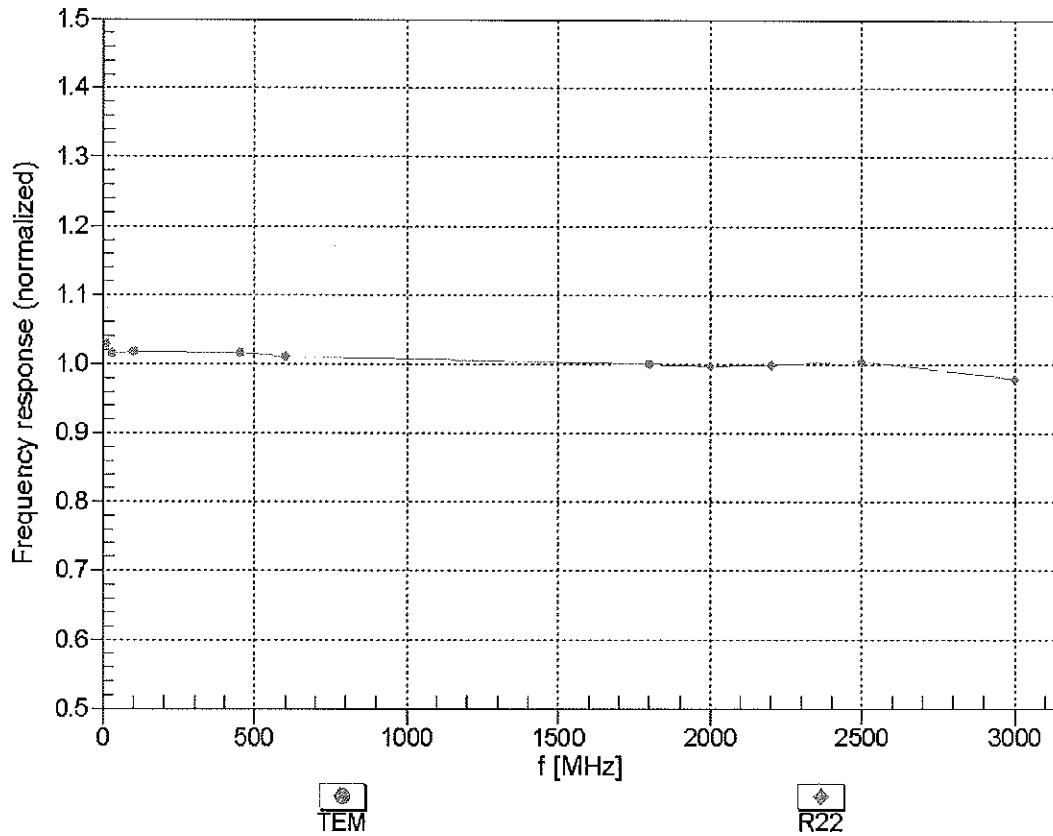

Uncertainty of Frequency Response of E-field:  $\pm 6.3\%$  (k=2)

### Receiving Pattern ( $\phi$ ), $\theta = 0^\circ$

f=600 MHz,TEM

f=1800 MHz,R22

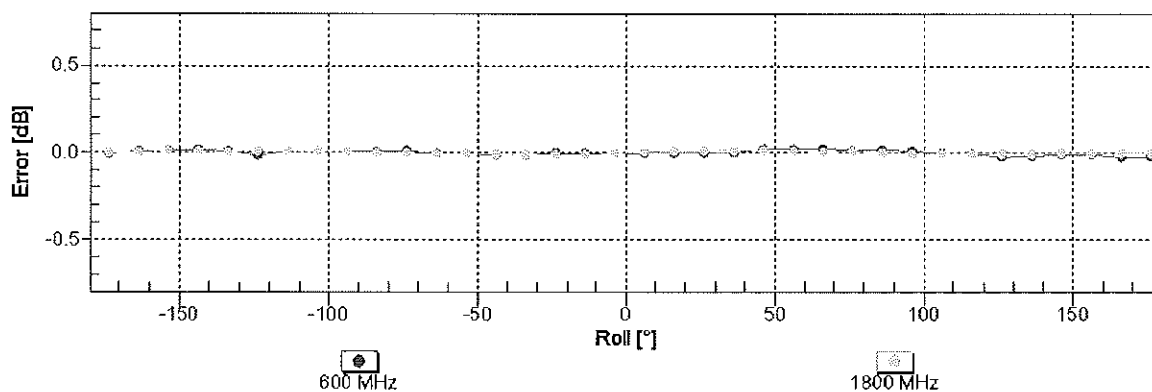
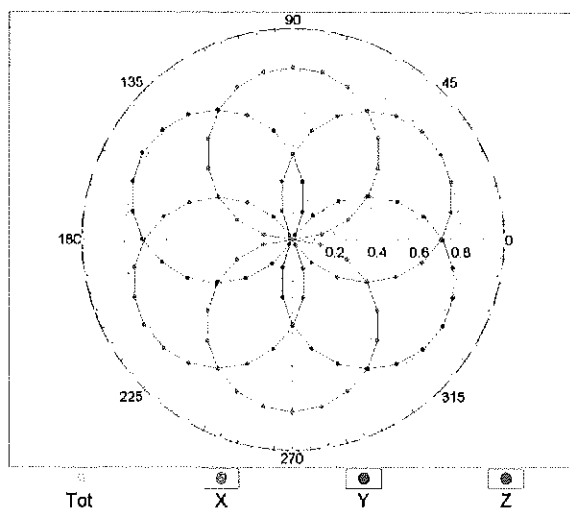
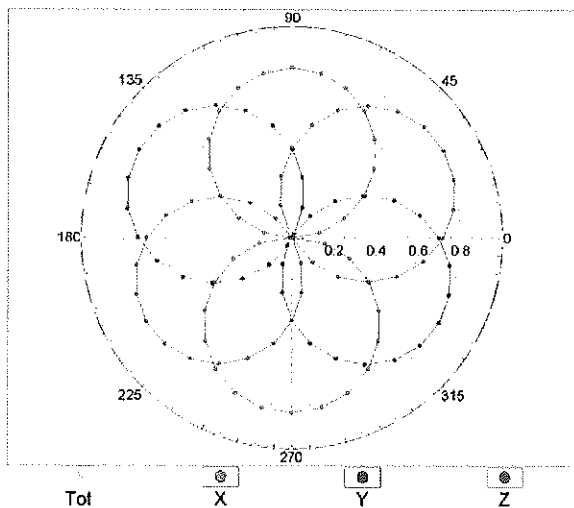

Uncertainty of Axial Isotropy Assessment:  $\pm 0.5\%$  (k=2)

### Dynamic Range f(SAR<sub>head</sub>) (TEM cell , f = 900 MHz)

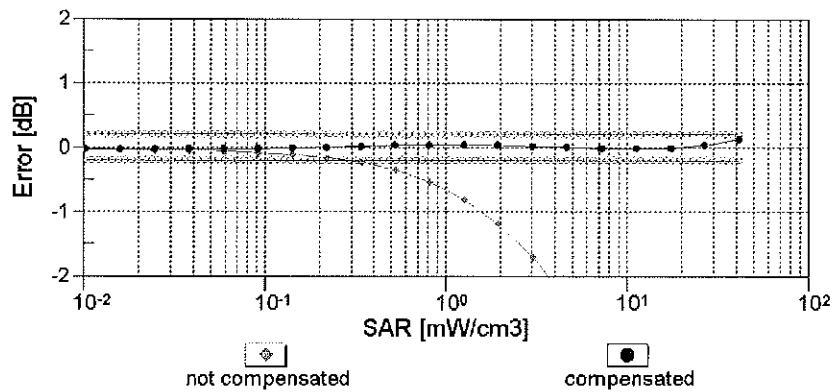
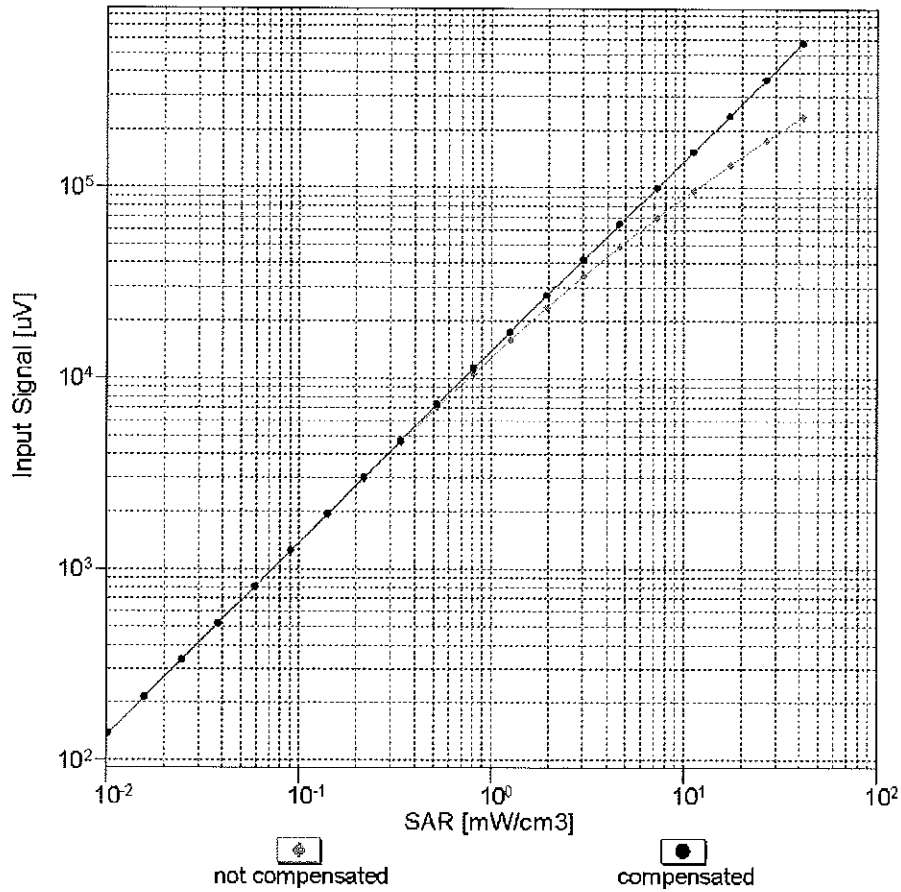

Uncertainty of Linearity Assessment: ± 0.6% (k=2)

# Conversion Factor Assessment

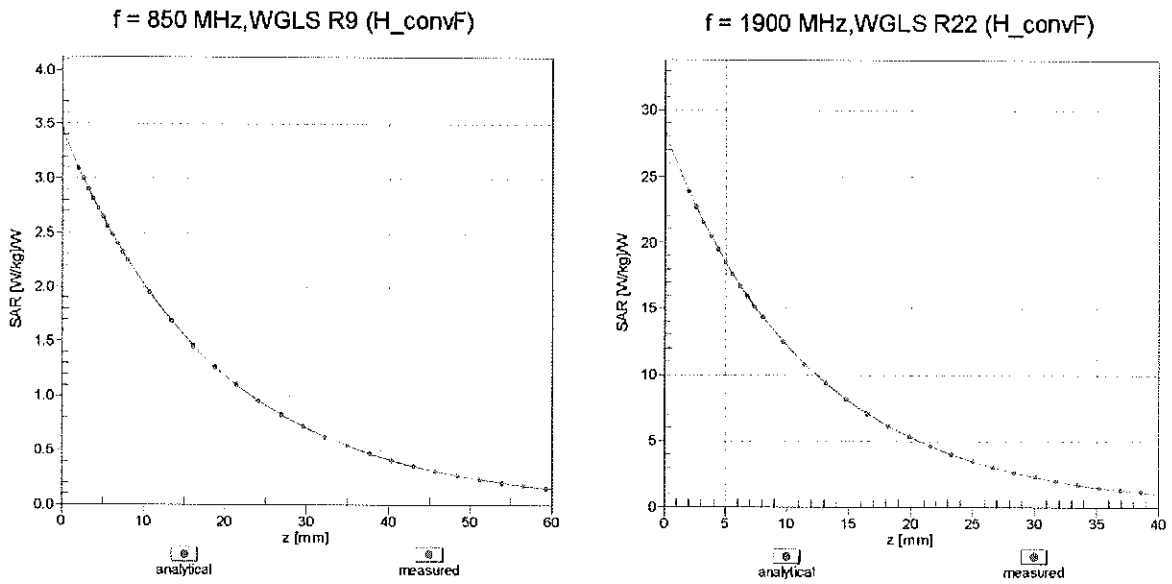

## Deviation from Isotropy in Liquid Error ( $\phi, \theta$ ), f = 900 MHz

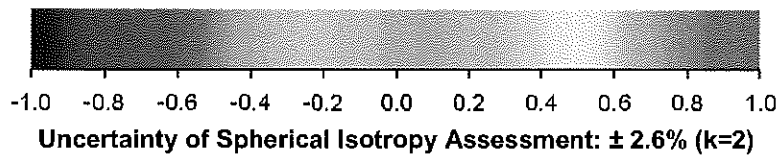
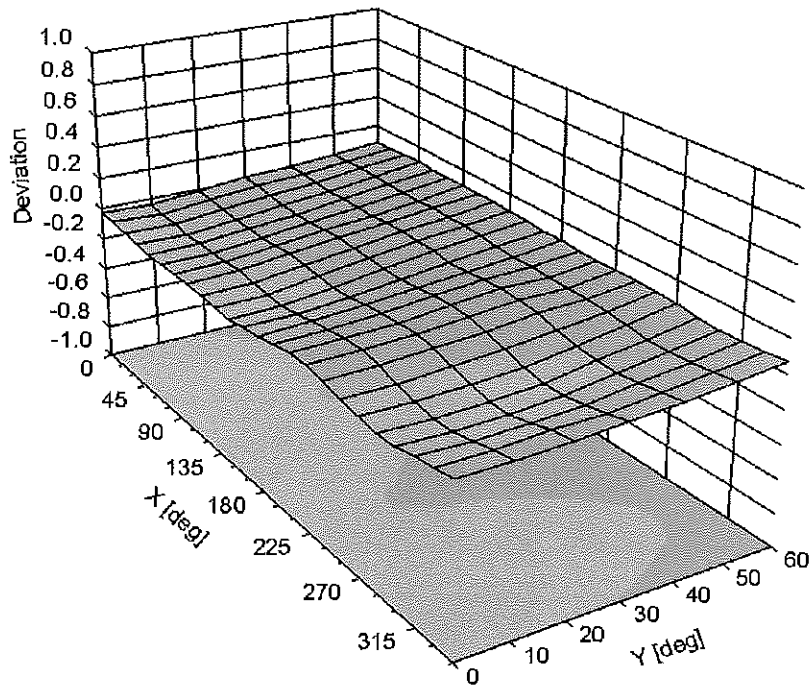

## DASY/EASY - Parameters of Probe: ES3DV3 - SN:3318

### Other Probe Parameters

Sensor Arrangement	Triangular
Connector Angle (°)	-103.8
Mechanical Surface Detection Mode	enabled
Optical Surface Detection Mode	disabled
Probe Overall Length	337 mm
Probe Body Diameter	10 mm
Tip Length	10 mm
Tip Diameter	4 mm
Probe Tip to Sensor X Calibration Point	2 mm
Probe Tip to Sensor Y Calibration Point	2 mm
Probe Tip to Sensor Z Calibration Point	2 mm
Recommended Measurement Distance from Surface	3 mm

## Additional Conversion Factors for Dosimetric E-Field Probe

Type:	<b>ES3DV3</b>
Serial Number:	<b>3318</b>
Place of Assessment:	<b>Zurich</b>
Date of Assessment:	<b>June 19, 2013</b>
Probe Calibration Date:	<b>April 29, 2013</b>

✓  
Kox  
6/25/13

Schmid & Partner Engineering AG hereby certifies that conversion factor(s) of this probe have been evaluated on the date indicated above. The assessment was performed using the FDTD numerical code SEMCAD of Schmid & Partner Engineering AG. The evaluation is coupled with measured conversion factors (probe calibration date indicated above). The uncertainty of the numerical assessment is based on the extrapolation from measured value at 835 MHz or at 1900 MHz.

Assessed by: 

## Dosimetric E-Field Probe ES3DV3 SN:3318

Conversion factor ( $\pm$  standard deviation)

1750  $\pm$  50 MHz      *ConvF*      5.59  $\pm$  7%

$\epsilon_r = 40.1 \pm 5\%$   
 $\sigma = 1.37 \pm 5\%$  mho/m  
 (head tissue)

1750  $\pm$  50 MHz      *ConvF*      5.22  $\pm$  7%

$\epsilon_r = 53.4 \pm 5\%$   
 $\sigma = 1.49 \pm 5\%$  mho/m  
 (body tissue)

### Important Note:

For numerically assessed probe conversion factors, parameters Alpha and Delta in the DASY software must have the following entries: Alpha = 0 and Delta = 1.

**Please see also DASY Manual.**



Accredited by the Swiss Accreditation Service (SAS)  
The Swiss Accreditation Service is one of the signatories to the EA  
Multilateral Agreement for the recognition of calibration certificates

Accreditation No.: **SCS 108**

Client **PC Test**

Certificate No: **ES3-3209\_Mar13**

**CALIBRATION CERTIFICATE**

Object **ES3DV3 - SN:3209**

Calibration procedure(s) **QA CAL-01.v8, QA CAL-23.v4, QA CAL-25.v4  
Calibration procedure for dosimetric E-field probes**

Calibration date: **March 15, 2013**

This calibration certificate documents the traceability to national standards, which realize the physical units of measurements (SI).  
The measurements and the uncertainties with confidence probability are given on the following pages and are part of the certificate.

All calibrations have been conducted in the closed laboratory facility: environment temperature (22 ± 3)°C and humidity < 70%.

*✓ KOK 3/22/13*

Calibration Equipment used (M&TE critical for calibration)

Primary Standards	ID	Cal Date (Certificate No.)	Scheduled Calibration
Power meter E4419B	GB41293874	29-Mar-12 (No. 217-01508)	Apr-13
Power sensor E4412A	MY41498087	29-Mar-12 (No. 217-01508)	Apr-13
Reference 3 dB Attenuator	SN: S5054 (3c)	27-Mar-12 (No. 217-01531)	Apr-13
Reference 20 dB Attenuator	SN: S5086 (20b)	27-Mar-12 (No. 217-01529)	Apr-13
Reference 30 dB Attenuator	SN: S5129 (30b)	27-Mar-12 (No. 217-01532)	Apr-13
Reference Probe ES3DV2	SN: 3013	28-Dec-12 (No. ES3-3013_Dec12)	Dec-13
DAE4	SN: 660	31-Jan-13 (No. DAE4-660_Jan13)	Jan-14
Secondary Standards	ID	Check Date (in house)	Scheduled Check
RF generator HP 8648C	US3642U01700	4-Aug-99 (in house check Apr-11)	In house check: Apr-13
Network Analyzer HP 8753E	US37390585	18-Oct-01 (in house check Oct-12)	In house check: Oct-13

	Name	Function	Signature
Calibrated by:	Israe El-Naouq	Laboratory Technician	<i>Israe El-Naouq</i>
Approved by:	Katja Pokovic	Technical Manager	<i>Katja Pokovic</i>

Issued: March 15, 2013

This calibration certificate shall not be reproduced except in full without written approval of the laboratory.

80242



Accredited by the Swiss Accreditation Service (SAS)

Accreditation No.: **SCS 108**

The Swiss Accreditation Service is one of the signatories to the EA Multilateral Agreement for the recognition of calibration certificates

### Glossary:

TSL	tissue simulating liquid
NORM <sub>x,y,z</sub>	sensitivity in free space
ConvF	sensitivity in TSL / NORM <sub>x,y,z</sub>
DCP	diode compression point
CF	crest factor (1/duty_cycle) of the RF signal
A, B, C, D	modulation dependent linearization parameters
Polarization $\varphi$	$\varphi$ rotation around probe axis
Polarization $\vartheta$	$\vartheta$ rotation around an axis that is in the plane normal to probe axis (at measurement center), i.e., $\vartheta = 0$ is normal to probe axis

### Calibration is Performed According to the Following Standards:

- IEEE Std 1528-2003, "IEEE Recommended Practice for Determining the Peak Spatial-Averaged Specific Absorption Rate (SAR) in the Human Head from Wireless Communications Devices: Measurement Techniques", December 2003
- IEC 62209-1, "Procedure to measure the Specific Absorption Rate (SAR) for hand-held devices used in close proximity to the ear (frequency range of 300 MHz to 3 GHz)", February 2005

### Methods Applied and Interpretation of Parameters:

- NORM<sub>x,y,z</sub>**: Assessed for E-field polarization  $\vartheta = 0$  ( $f \leq 900$  MHz in TEM-cell;  $f > 1800$  MHz: R22 waveguide). NORM<sub>x,y,z</sub> are only intermediate values, i.e., the uncertainties of NORM<sub>x,y,z</sub> does not affect the E<sup>2</sup>-field uncertainty inside TSL (see below ConvF).
- NORM(f)<sub>x,y,z</sub>** = NORM<sub>x,y,z</sub> \* frequency\_response (see Frequency Response Chart). This linearization is implemented in DASY4 software versions later than 4.2. The uncertainty of the frequency response is included in the stated uncertainty of ConvF.
- DCP<sub>x,y,z</sub>**: DCP are numerical linearization parameters assessed based on the data of power sweep with CW signal (no uncertainty required). DCP does not depend on frequency nor media.
- PAR**: PAR is the Peak to Average Ratio that is not calibrated but determined based on the signal characteristics
- A<sub>x,y,z</sub>; B<sub>x,y,z</sub>; C<sub>x,y,z</sub>; D<sub>x,y,z</sub>; VR<sub>x,y,z</sub>; A, B, C, D** are numerical linearization parameters assessed based on the data of power sweep for specific modulation signal. The parameters do not depend on frequency nor media. VR is the maximum calibration range expressed in RMS voltage across the diode.
- ConvF and Boundary Effect Parameters**: Assessed in flat phantom using E-field (or Temperature Transfer Standard for  $f \leq 800$  MHz) and inside waveguide using analytical field distributions based on power measurements for  $f > 800$  MHz. The same setups are used for assessment of the parameters applied for boundary compensation (alpha, depth) of which typical uncertainty values are given. These parameters are used in DASY4 software to improve probe accuracy close to the boundary. The sensitivity in TSL corresponds to NORM<sub>x,y,z</sub> \* ConvF whereby the uncertainty corresponds to that given for ConvF. A frequency dependent ConvF is used in DASY version 4.4 and higher which allows extending the validity from  $\pm 50$  MHz to  $\pm 100$  MHz.
- Spherical isotropy (3D deviation from isotropy)**: in a field of low gradients realized using a flat phantom exposed by a patch antenna.
- Sensor Offset**: The sensor offset corresponds to the offset of virtual measurement center from the probe tip (on probe axis). No tolerance required.

# Probe ES3DV3

## SN:3209

Manufactured: October 14, 2008  
Calibrated: March 15, 2013

Calibrated for DASY/EASY Systems  
(Note: non-compatible with DASY2 system!)

## DASY/EASY - Parameters of Probe: ES3DV3 - SN:3209

### Basic Calibration Parameters

	Sensor X	Sensor Y	Sensor Z	Unc (k=2)
Norm ( $\mu\text{V}/(\text{V}/\text{m})^2$ ) <sup>A</sup>	1.35	1.33	1.14	$\pm 10.1 \%$
DCP (mV) <sup>B</sup>	99.2	97.8	98.3	

### Modulation Calibration Parameters

UID	Communication System Name		A dB	B dB $\sqrt{\mu\text{V}}$	C	D dB	VR mV	Unc <sup>E</sup> (k=2)
0	CW	X	0.0	0.0	1.0	0.00	163.6	$\pm 3.5 \%$
		Y	0.0	0.0	1.0		170.3	
		Z	0.0	0.0	1.0		158.7	

The reported uncertainty of measurement is stated as the standard uncertainty of measurement multiplied by the coverage factor  $k=2$ , which for a normal distribution corresponds to a coverage probability of approximately 95%.

<sup>A</sup> The uncertainties of NormX,Y,Z do not affect the  $E^2$ -field uncertainty inside TSL (see Pages 5 and 6).

<sup>B</sup> Numerical linearization parameter: uncertainty not required.

<sup>E</sup> Uncertainty is determined using the max. deviation from linear response applying rectangular distribution and is expressed for the square of the field value.

## DASY/EASY - Parameters of Probe: ES3DV3 - SN:3209

### Calibration Parameter Determined in Head Tissue Simulating Media

f (MHz) <sup>C</sup>	Relative Permittivity <sup>F</sup>	Conductivity (S/m) <sup>F</sup>	ConvF X	ConvF Y	ConvF Z	Alpha	Depth (mm)	Unct. (k=2)
750	41.9	0.89	6.74	6.74	6.74	0.76	1.18	± 12.0 %
835	41.5	0.90	6.46	6.46	6.46	0.31	1.81	± 12.0 %
1750	40.1	1.37	5.39	5.39	5.39	0.80	1.21	± 12.0 %
1900	40.0	1.40	5.21	5.21	5.21	0.78	1.26	± 12.0 %
2450	39.2	1.80	4.57	4.57	4.57	0.65	1.43	± 12.0 %
2600	39.0	1.96	4.43	4.43	4.43	0.75	1.36	± 12.0 %

<sup>C</sup> Frequency validity of ± 100 MHz only applies for DASY v4.4 and higher (see Page 2), else it is restricted to ± 50 MHz. The uncertainty is the RSS of the ConvF uncertainty at calibration frequency and the uncertainty for the indicated frequency band.

<sup>F</sup> At frequencies below 3 GHz, the validity of tissue parameters ( $\epsilon$  and  $\sigma$ ) can be relaxed to ± 10% if liquid compensation formula is applied to measured SAR values. At frequencies above 3 GHz, the validity of tissue parameters ( $\epsilon$  and  $\sigma$ ) is restricted to ± 5%. The uncertainty is the RSS of the ConvF uncertainty for indicated target tissue parameters.

## DASY/EASY - Parameters of Probe: ES3DV3 - SN:3209

### Calibration Parameter Determined in Body Tissue Simulating Media

f (MHz) <sup>C</sup>	Relative Permittivity <sup>F</sup>	Conductivity (S/m) <sup>F</sup>	ConvF X	ConvF Y	ConvF Z	Alpha	Depth (mm)	Unct. (k=2)
750	55.5	0.96	6.38	6.38	6.38	0.80	1.16	± 12.0 %
835	55.2	0.97	6.28	6.28	6.28	0.52	1.45	± 12.0 %
1750	53.4	1.49	5.03	5.03	5.03	0.58	1.45	± 12.0 %
1900	53.3	1.52	4.77	4.77	4.77	0.70	1.36	± 12.0 %
2450	52.7	1.95	4.34	4.34	4.34	0.80	1.15	± 12.0 %
2600	52.5	2.16	4.11	4.11	4.11	0.80	1.00	± 12.0 %

<sup>C</sup> Frequency validity of ± 100 MHz only applies for DASY v4.4 and higher (see Page 2), else it is restricted to ± 50 MHz. The uncertainty is the RSS of the ConvF uncertainty at calibration frequency and the uncertainty for the indicated frequency band.

<sup>F</sup> At frequencies below 3 GHz, the validity of tissue parameters ( $\epsilon$  and  $\sigma$ ) can be relaxed to ± 10% if liquid compensation formula is applied to measured SAR values. At frequencies above 3 GHz, the validity of tissue parameters ( $\epsilon$  and  $\sigma$ ) is restricted to ± 5%. The uncertainty is the RSS of the ConvF uncertainty for indicated target tissue parameters.

# Frequency Response of E-Field (TEM-Cell:ifi110 EXX, Waveguide: R22)

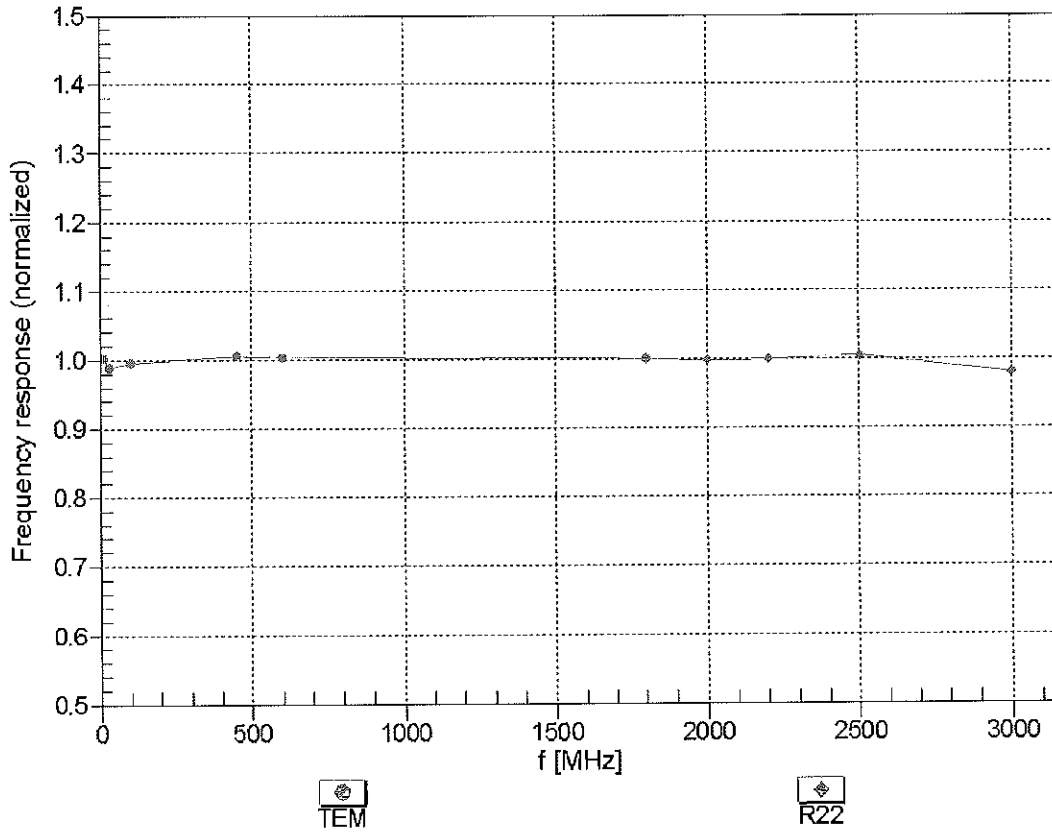

Uncertainty of Frequency Response of E-field:  $\pm 6.3\%$  (k=2)

### Receiving Pattern ( $\phi$ ), $\theta = 0^\circ$

f=600 MHz,TEM

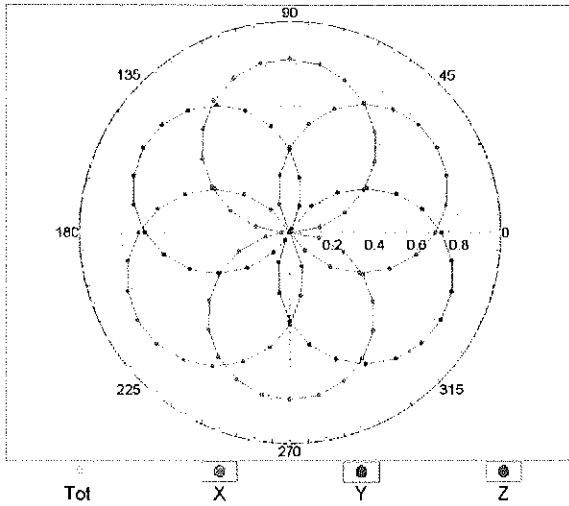

f=1800 MHz,R22

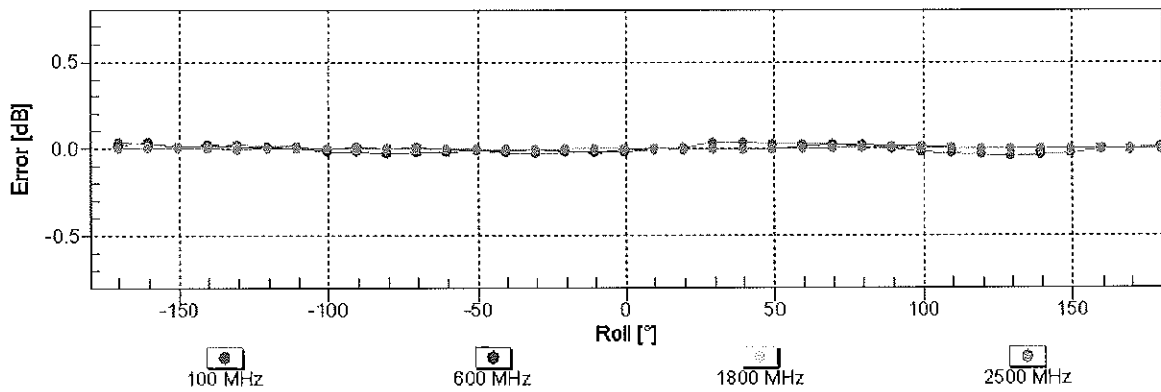
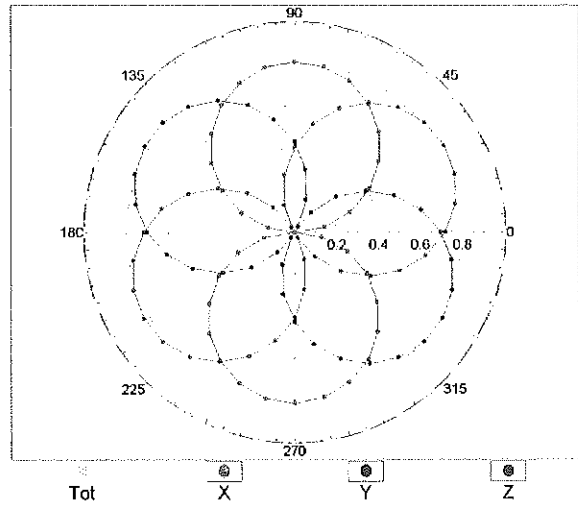

Uncertainty of Axial Isotropy Assessment:  $\pm 0.5\%$  ( $k=2$ )

### Dynamic Range $f(SAR_{head})$ (TEM cell , $f = 900$ MHz)

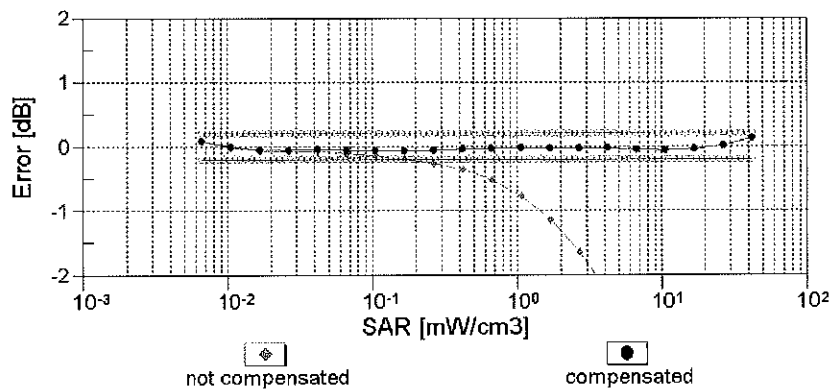
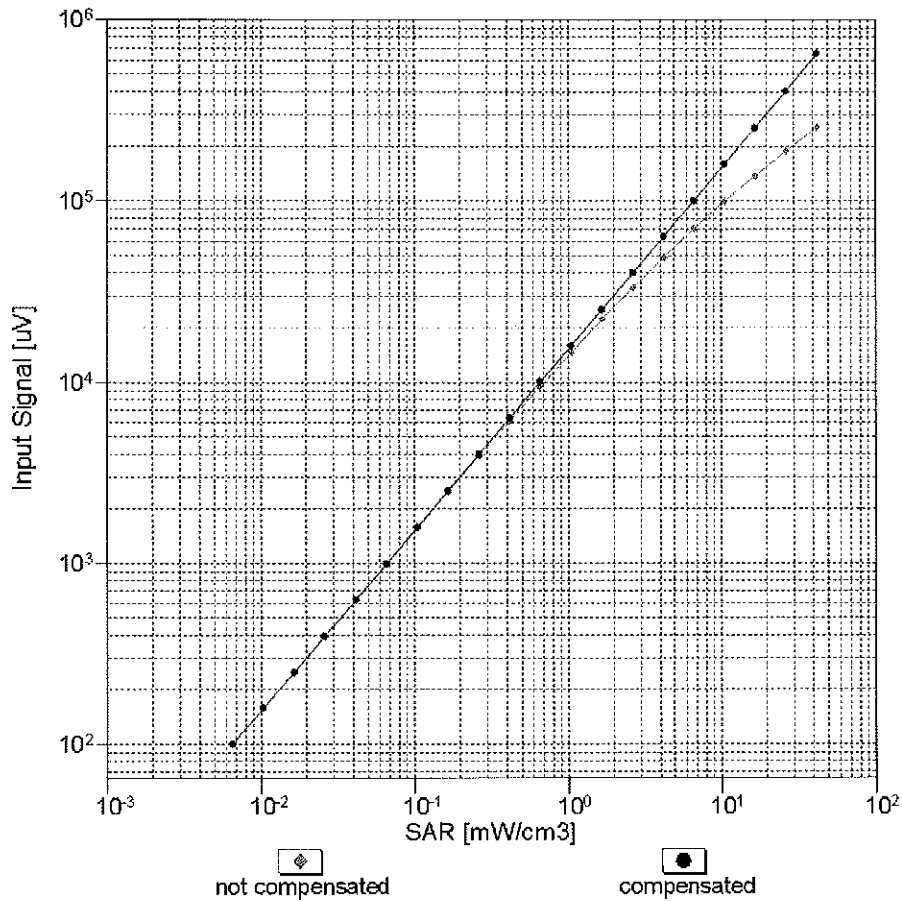

Uncertainty of Linearity Assessment:  $\pm 0.6\%$  ( $k=2$ )

# Conversion Factor Assessment

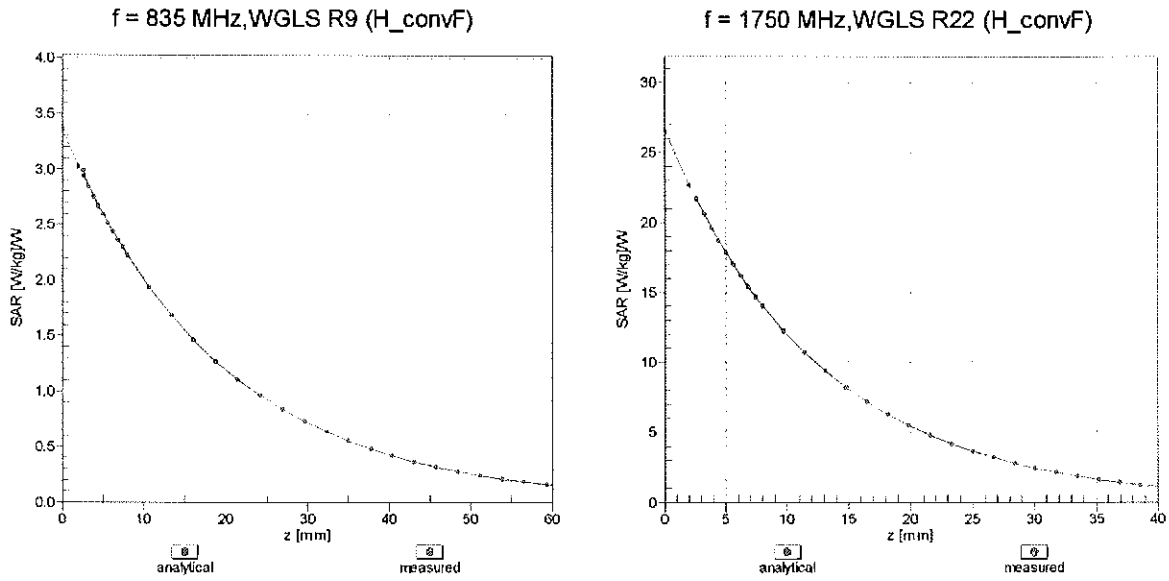

## Deviation from Isotropy in Liquid Error ( $\phi, \theta$ ), f = 900 MHz

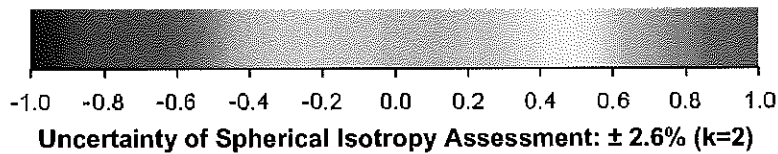
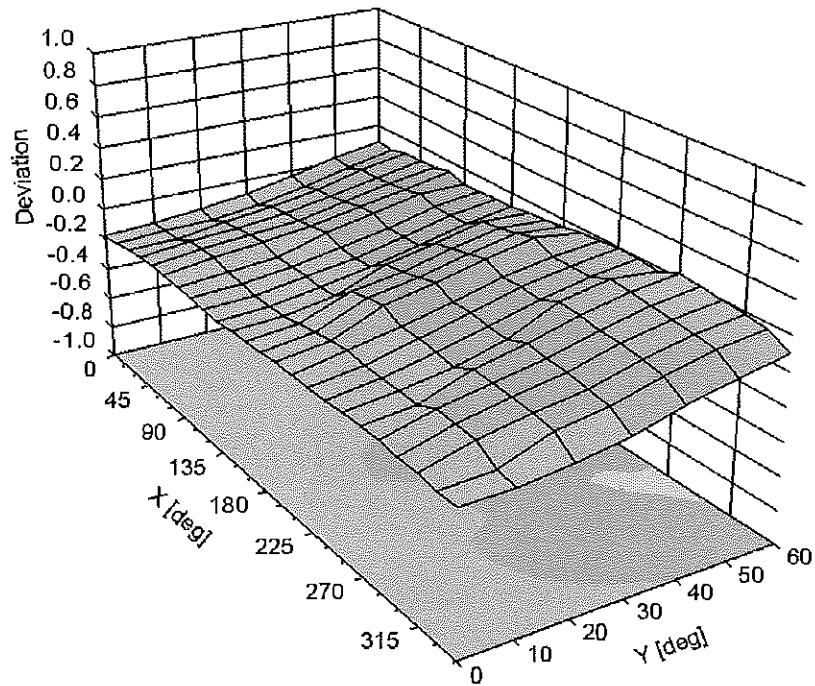

## DASY/EASY - Parameters of Probe: ES3DV3 - SN:3209

### Other Probe Parameters

Sensor Arrangement	Triangular
Connector Angle (°)	-40.6
Mechanical Surface Detection Mode	enabled
Optical Surface Detection Mode	disabled
Probe Overall Length	337 mm
Probe Body Diameter	10 mm
Tip Length	10 mm
Tip Diameter	4 mm
Probe Tip to Sensor X Calibration Point	2 mm
Probe Tip to Sensor Y Calibration Point	2 mm
Probe Tip to Sensor Z Calibration Point	2 mm
Recommended Measurement Distance from Surface	3 mm



Accredited by the Swiss Accreditation Service (SAS)  
The Swiss Accreditation Service is one of the signatories to the EA  
Multilateral Agreement for the recognition of calibration certificates

Accreditation No.: **SCS 108**

Client **PC Test**

Certificate No: **ES3-3263\_May13**

## CALIBRATION CERTIFICATE

Object **ES3DV3 - SN:3263**

Calibration procedure(s) **QA CAL-01.v8, QA CAL-23.v4, QA CAL-25.v4  
Calibration procedure for dosimetric E-field probes**

Calibration date: **May 16, 2013**

*✓ KOK  
5/23/13*

This calibration certificate documents the traceability to national standards, which realize the physical units of measurements (SI).  
The measurements and the uncertainties with confidence probability are given on the following pages and are part of the certificate.

All calibrations have been conducted in the closed laboratory facility: environment temperature (22 ± 3)°C and humidity < 70%.

Calibration Equipment used (M&TE critical for calibration)

Primary Standards	ID	Cal Date (Certificate No.)	Scheduled Calibration
Power meter E4419B	GB41293874	04-Apr-13 (No. 217-01733)	Apr-14
Power sensor E4412A	MY41498087	04-Apr-13 (No. 217-01733)	Apr-14
Reference 3 dB Attenuator	SN: S5054 (3c)	04-Apr-13 (No. 217-01737)	Apr-14
Reference 20 dB Attenuator	SN: S5277 (20x)	04-Apr-13 (No. 217-01735)	Apr-14
Reference 30 dB Attenuator	SN: S5129 (30b)	04-Apr-13 (No. 217-01738)	Apr-14
Reference Probe ES3DV2	SN: 3013	28-Dec-12 (No. ES3-3013_Dec12)	Dec-13
DAE4	SN: 660	31-Jan-13 (No. DAE4-660_Jan13)	Jan-14
Secondary Standards	ID	Check Date (in house)	Scheduled Check
RF generator HP 8648C	US3642U01700	4-Aug-99 (in house check Apr-13)	In house check: Apr-15
Network Analyzer HP 8753E	US37390585	18-Oct-01 (in house check Oct-12)	In house check: Oct-13

	Name	Function	Signature
Calibrated by:	Leif Klysner	Laboratory Technician	<i>Leif Klysner</i>
Approved by:	Katja Pokovic	Technical Manager	<i>Katja Pokovic</i>
			Issued: May 17, 2013

This calibration certificate shall not be reproduced except in full without written approval of the laboratory.



Accredited by the Swiss Accreditation Service (SAS)

Accreditation No.: **SCS 108**

The Swiss Accreditation Service is one of the signatories to the EA  
Multilateral Agreement for the recognition of calibration certificates

### Glossary:

TSL	tissue simulating liquid
NORM <sub>x,y,z</sub>	sensitivity in free space
ConvF	sensitivity in TSL / NORM <sub>x,y,z</sub>
DCP	diode compression point
CF	crest factor (1/duty_cycle) of the RF signal
A, B, C, D	modulation dependent linearization parameters
Polarization $\varphi$	$\varphi$ rotation around probe axis
Polarization $\vartheta$	$\vartheta$ rotation around an axis that is in the plane normal to probe axis (at measurement center), i.e., $\vartheta = 0$ is normal to probe axis

### Calibration is Performed According to the Following Standards:

- IEEE Std 1528-2003, "IEEE Recommended Practice for Determining the Peak Spatial-Averaged Specific Absorption Rate (SAR) in the Human Head from Wireless Communications Devices: Measurement Techniques", December 2003
- IEC 62209-1, "Procedure to measure the Specific Absorption Rate (SAR) for hand-held devices used in close proximity to the ear (frequency range of 300 MHz to 3 GHz)", February 2005

### Methods Applied and Interpretation of Parameters:

- NORM<sub>x,y,z</sub>**: Assessed for E-field polarization  $\vartheta = 0$  ( $f \leq 900$  MHz in TEM-cell;  $f > 1800$  MHz: R22 waveguide). NORM<sub>x,y,z</sub> are only intermediate values, i.e., the uncertainties of NORM<sub>x,y,z</sub> does not affect the E<sup>2</sup>-field uncertainty inside TSL (see below ConvF).
- NORM(f)<sub>x,y,z</sub>** = NORM<sub>x,y,z</sub> \* frequency\_response (see Frequency Response Chart). This linearization is implemented in DASY4 software versions later than 4.2. The uncertainty of the frequency response is included in the stated uncertainty of ConvF.
- DCP<sub>x,y,z</sub>**: DCP are numerical linearization parameters assessed based on the data of power sweep with CW signal (no uncertainty required). DCP does not depend on frequency nor media.
- PAR**: PAR is the Peak to Average Ratio that is not calibrated but determined based on the signal characteristics
- A<sub>x,y,z</sub>; B<sub>x,y,z</sub>; C<sub>x,y,z</sub>; D<sub>x,y,z</sub>; VR<sub>x,y,z</sub>; A, B, C, D** are numerical linearization parameters assessed based on the data of power sweep for specific modulation signal. The parameters do not depend on frequency nor media. VR is the maximum calibration range expressed in RMS voltage across the diode.
- ConvF and Boundary Effect Parameters**: Assessed in flat phantom using E-field (or Temperature Transfer Standard for  $f \leq 800$  MHz) and inside waveguide using analytical field distributions based on power measurements for  $f > 800$  MHz. The same setups are used for assessment of the parameters applied for boundary compensation (alpha, depth) of which typical uncertainty values are given. These parameters are used in DASY4 software to improve probe accuracy close to the boundary. The sensitivity in TSL corresponds to NORM<sub>x,y,z</sub> \* ConvF whereby the uncertainty corresponds to that given for ConvF. A frequency dependent ConvF is used in DASY version 4.4 and higher which allows extending the validity from  $\pm 50$  MHz to  $\pm 100$  MHz.
- Spherical isotropy (3D deviation from isotropy)**: in a field of low gradients realized using a flat phantom exposed by a patch antenna.
- Sensor Offset**: The sensor offset corresponds to the offset of virtual measurement center from the probe tip (on probe axis). No tolerance required.

# Probe ES3DV3

## SN:3263

Manufactured: January 25, 2010  
Calibrated: May 16, 2013

Calibrated for DASY/EASY Systems  
(Note: non-compatible with DASY2 system!)

## DASY/EASY - Parameters of Probe: ES3DV3 - SN:3263

### Basic Calibration Parameters

	Sensor X	Sensor Y	Sensor Z	Unc (k=2)
Norm ( $\mu\text{V}/(\text{V}/\text{m})^2$ ) <sup>A</sup>	1.21	1.25	1.12	$\pm 10.1 \%$
DCP (mV) <sup>B</sup>	101.2	100.2	103.7	

### Modulation Calibration Parameters

UID	Communication System Name		A dB	B dB $\sqrt{\mu\text{V}}$	C	D dB	VR mV	Unc <sup>E</sup> (k=2)
0	CW	X	0.0	0.0	1.0	0.00	156.5	$\pm 2.5 \%$
		Y	0.0	0.0	1.0		153.2	
		Z	0.0	0.0	1.0		147.2	

The reported uncertainty of measurement is stated as the standard uncertainty of measurement multiplied by the coverage factor  $k=2$ , which for a normal distribution corresponds to a coverage probability of approximately 95%.

<sup>A</sup> The uncertainties of NormX,Y,Z do not affect the  $E^2$ -field uncertainty inside TSL (see Pages 5 and 6).

<sup>B</sup> Numerical linearization parameter: uncertainty not required.

<sup>E</sup> Uncertainty is determined using the max. deviation from linear response applying rectangular distribution and is expressed for the square of the field value.

## DASY/EASY - Parameters of Probe: ES3DV3 - SN:3263

### Calibration Parameter Determined in Head Tissue Simulating Media

f (MHz) <sup>C</sup>	Relative Permittivity <sup>F</sup>	Conductivity (S/m) <sup>F</sup>	ConvF X	ConvF Y	ConvF Z	Alpha	Depth (mm)	Unct. (k=2)
750	41.9	0.89	6.51	6.51	6.51	0.21	2.29	± 12.0 %
835	41.5	0.90	6.29	6.29	6.29	0.50	1.38	± 12.0 %
1750	40.1	1.37	5.30	5.30	5.30	0.45	1.54	± 12.0 %
1900	40.0	1.40	5.11	5.11	5.11	0.57	1.38	± 12.0 %
2450	39.2	1.80	4.47	4.47	4.47	0.59	1.49	± 12.0 %
2600	39.0	1.96	4.31	4.31	4.31	0.80	1.28	± 12.0 %

<sup>C</sup> Frequency validity of ± 100 MHz only applies for DASY v4.4 and higher (see Page 2), else it is restricted to ± 50 MHz. The uncertainty is the RSS of the ConvF uncertainty at calibration frequency and the uncertainty for the indicated frequency band.

<sup>F</sup> At frequencies below 3 GHz, the validity of tissue parameters ( $\epsilon$  and  $\sigma$ ) can be relaxed to ± 10% if liquid compensation formula is applied to measured SAR values. At frequencies above 3 GHz, the validity of tissue parameters ( $\epsilon$  and  $\sigma$ ) is restricted to ± 5%. The uncertainty is the RSS of the ConvF uncertainty for indicated target tissue parameters.

## DASY/EASY - Parameters of Probe: ES3DV3 - SN:3263

### Calibration Parameter Determined in Body Tissue Simulating Media

f (MHz) <sup>C</sup>	Relative Permittivity <sup>F</sup>	Conductivity (S/m) <sup>F</sup>	ConvF X	ConvF Y	ConvF Z	Alpha	Depth (mm)	Unct. (k=2)
750	55.5	0.96	6.37	6.37	6.37	0.34	1.82	± 12.0 %
835	55.2	0.97	6.29	6.29	6.29	0.54	1.39	± 12.0 %
1750	53.4	1.49	5.01	5.01	5.01	0.72	1.27	± 12.0 %
1900	53.3	1.52	4.78	4.78	4.78	0.53	1.56	± 12.0 %
2450	52.7	1.95	4.33	4.33	4.33	0.80	1.14	± 12.0 %
2600	52.5	2.16	4.14	4.14	4.14	0.80	1.02	± 12.0 %

<sup>C</sup> Frequency validity of ± 100 MHz only applies for DASY v4.4 and higher (see Page 2), else it is restricted to ± 50 MHz. The uncertainty is the RSS of the ConvF uncertainty at calibration frequency and the uncertainty for the indicated frequency band.

<sup>F</sup> At frequencies below 3 GHz, the validity of tissue parameters ( $\epsilon$  and  $\sigma$ ) can be relaxed to ± 10% if liquid compensation formula is applied to measured SAR values. At frequencies above 3 GHz, the validity of tissue parameters ( $\epsilon$  and  $\sigma$ ) is restricted to ± 5%. The uncertainty is the RSS of the ConvF uncertainty for indicated target tissue parameters.

### Frequency Response of E-Field (TEM-Cell:ifi110 EXX, Waveguide: R22)

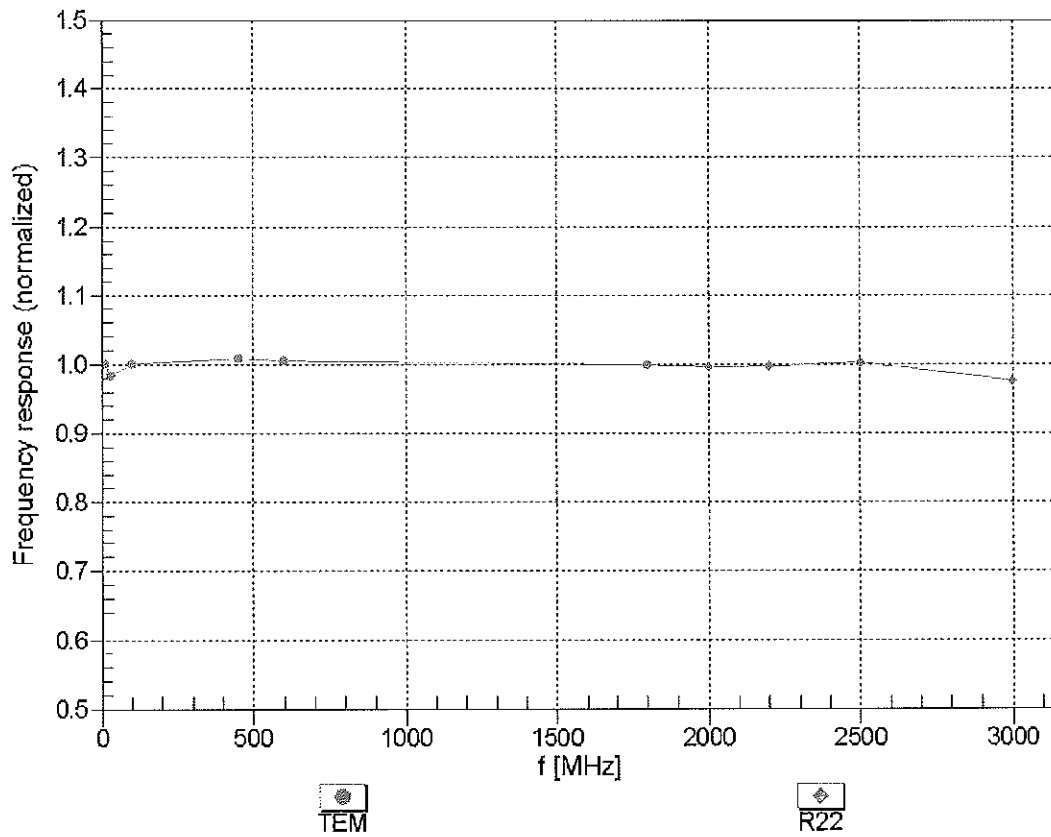

Uncertainty of Frequency Response of E-field:  $\pm 6.3\%$  (k=2)

### Receiving Pattern ( $\phi$ ), $\theta = 0^\circ$

f=600 MHz,TEM

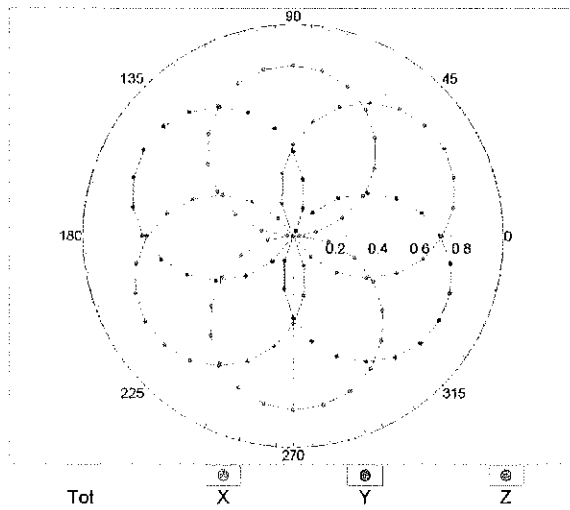

f=1800 MHz,R22

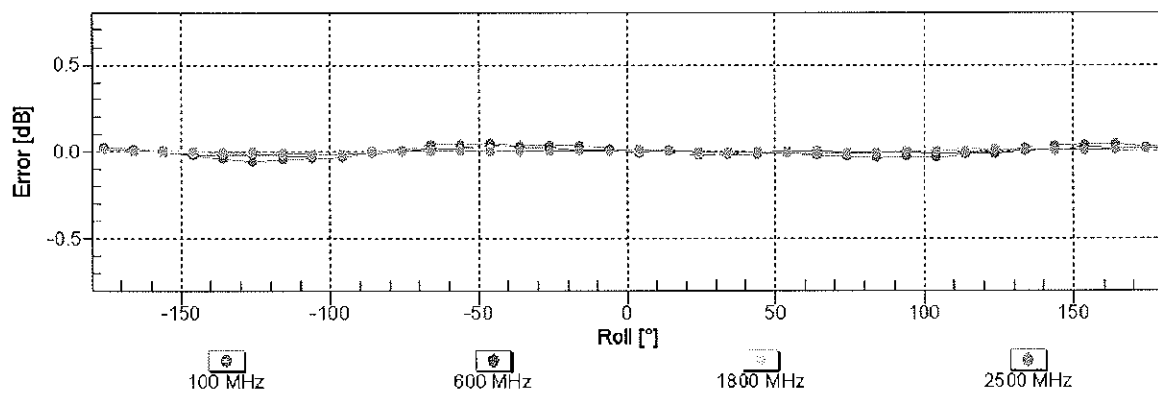
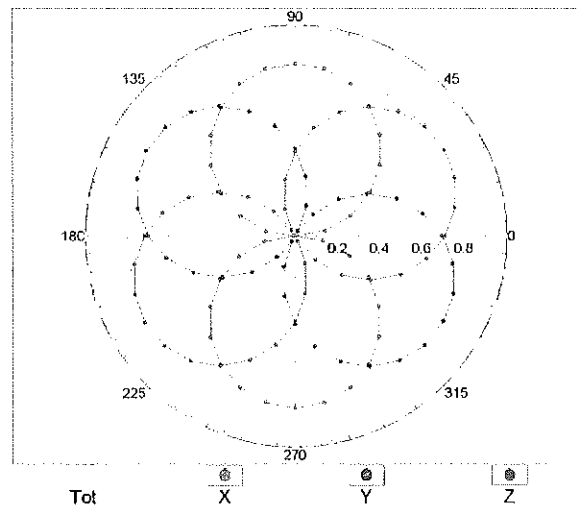

Uncertainty of Axial Isotropy Assessment:  $\pm 0.5\%$  (k=2)

### Dynamic Range f(SAR<sub>head</sub>) (TEM cell , f = 900 MHz)

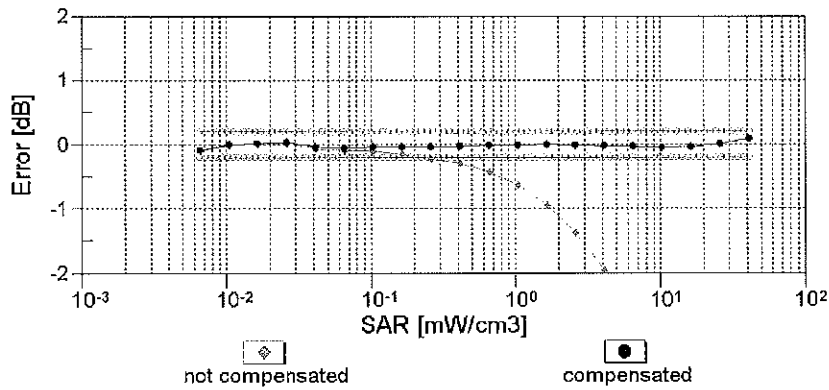
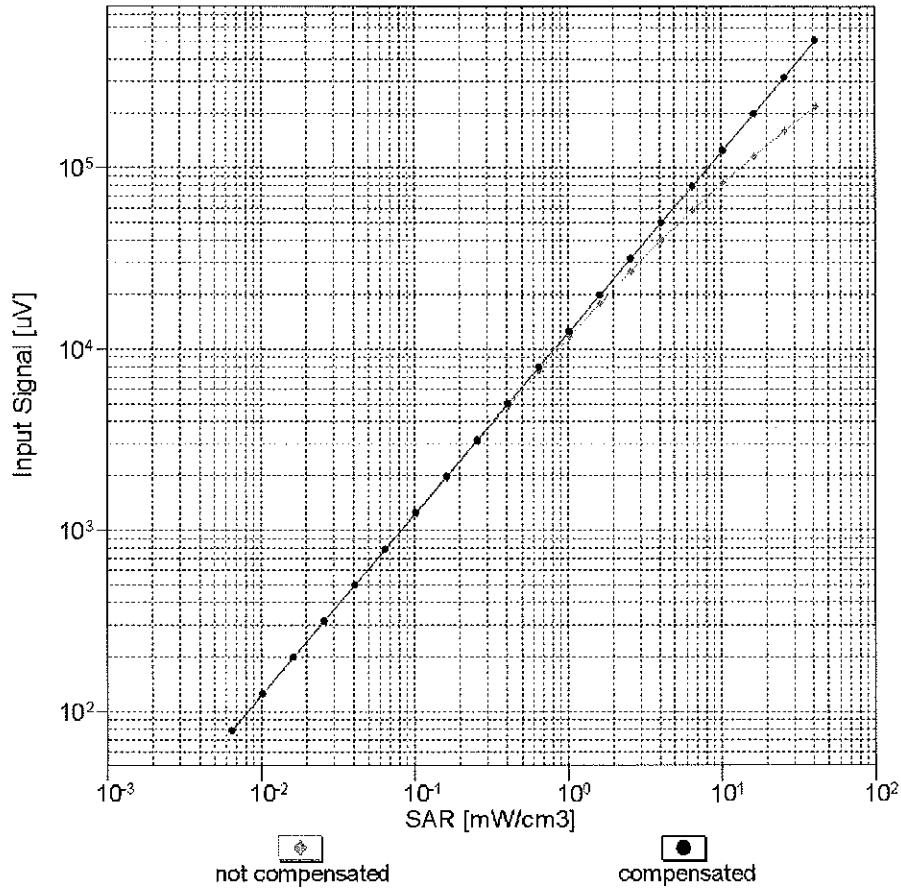

Uncertainty of Linearity Assessment: ± 0.6% (k=2)

## Conversion Factor Assessment

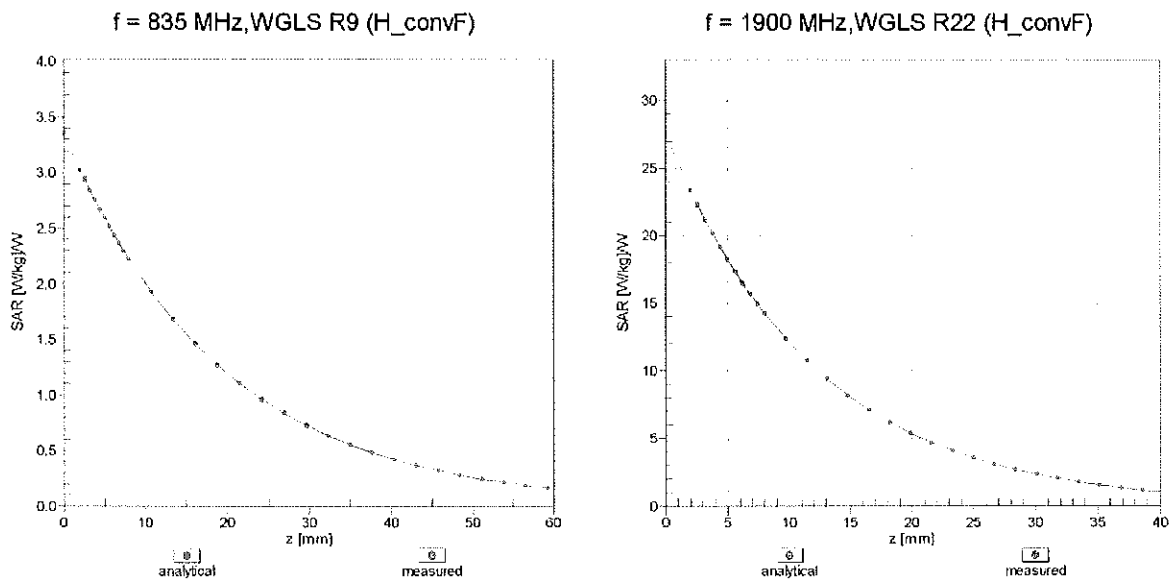

## Deviation from Isotropy in Liquid Error ( $\phi, \theta$ ), f = 900 MHz

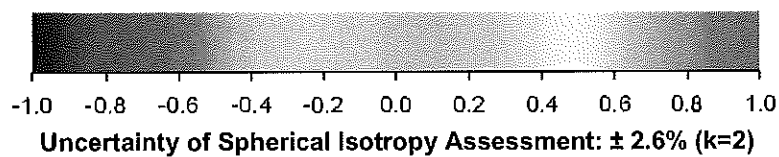
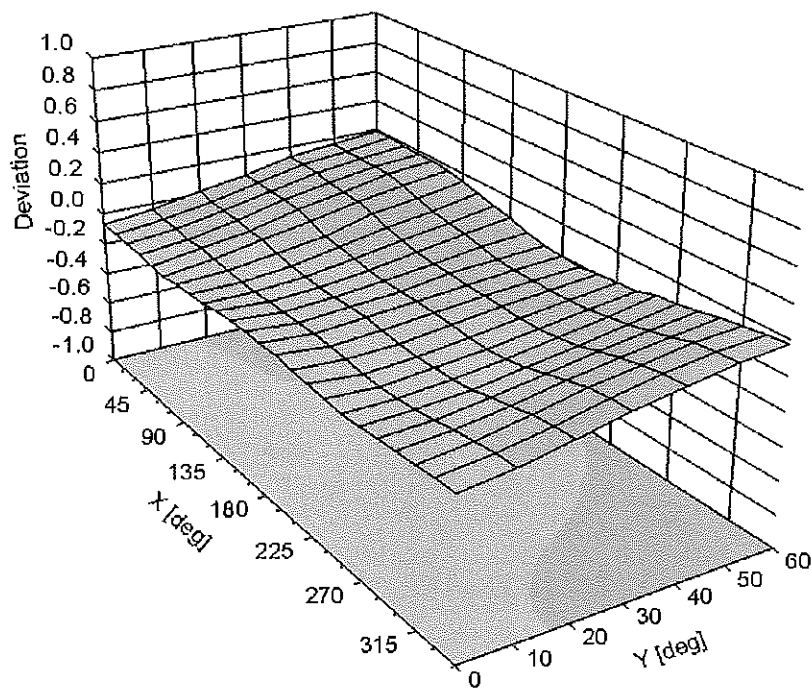

## DASY/EASY - Parameters of Probe: ES3DV3 - SN:3263

### Other Probe Parameters

Sensor Arrangement	Triangular
Connector Angle (°)	-116
Mechanical Surface Detection Mode	enabled
Optical Surface Detection Mode	disabled
Probe Overall Length	337 mm
Probe Body Diameter	10 mm
Tip Length	10 mm
Tip Diameter	4 mm
Probe Tip to Sensor X Calibration Point	2 mm
Probe Tip to Sensor Y Calibration Point	2 mm
Probe Tip to Sensor Z Calibration Point	2 mm
Recommended Measurement Distance from Surface	3 mm

**Calibration Laboratory of  
Schmid & Partner  
Engineering AG**  
Zeughausstrasse 43, 8004 Zurich, Switzerland



**S** Schweizerischer Kalibrierdienst  
**C** Service suisse d'étalonnage  
**S** Servizio svizzero di taratura  
Swiss Calibration Service

Accredited by the Swiss Accreditation Service (SAS)  
The Swiss Accreditation Service is one of the signatories to the EA  
Multilateral Agreement for the recognition of calibration certificates

Accreditation No.: **SCS 108**

Client **PC Test**

Certificate No: **ES3-3287\_Nov12**

## CALIBRATION CERTIFICATE

Object **ES3DV3 - SN:3287**

Calibration procedure(s) **QA CAL-01.v8, QA CAL-23.v4, QA CAL-25.v4  
Calibration procedure for dosimetric E-field probes**

Calibration date: **November 15, 2012**

*✓ KOK  
11/2012*

This calibration certificate documents the traceability to national standards, which realize the physical units of measurements (SI).  
The measurements and the uncertainties with confidence probability are given on the following pages and are part of the certificate.

All calibrations have been conducted in the closed laboratory facility: environment temperature (22 ± 3)°C and humidity < 70%.

Calibration Equipment used (M&TE critical for calibration)

Primary Standards	ID	Cal Date (Certificate No.)	Scheduled Calibration
Power meter E4419B	GB41293874	29-Mar-12 (No. 217-01508)	Apr-13
Power sensor E4412A	MY41498087	29-Mar-12 (No. 217-01508)	Apr-13
Reference 3 dB Attenuator	SN: S5054 (3c)	27-Mar-12 (No. 217-01531)	Apr-13
Reference 20 dB Attenuator	SN: S5086 (20b)	27-Mar-12 (No. 217-01529)	Apr-13
Reference 30 dB Attenuator	SN: S5129 (30b)	27-Mar-12 (No. 217-01532)	Apr-13
Reference Probe ES3DV2	SN: 3013	29-Dec-11 (No. ES3-3013_Dec11)	Dec-12
DAE4	SN: 660	20-Jun-12 (No. DAE4-660_Jun12)	Jun-13
Secondary Standards	ID	Check Date (in house)	Scheduled Check
RF generator HP 8648C	US3642U01700	4-Aug-99 (in house check Apr-11)	In house check: Apr-13
Network Analyzer HP 8753E	US37390585	18-Oct-01 (in house check Oct-12)	In house check: Oct-13

Calibrated by:	Name <b>Claudio Leubler</b>	Function <b>Laboratory Technician</b>	Signature 
Approved by:	Name <b>Katja Pokovic</b>	Function <b>Technical Manager</b>	Signature 

Issued: November 16, 2012

This calibration certificate shall not be reproduced except in full without written approval of the laboratory.



Accredited by the Swiss Accreditation Service (SAS)

Accreditation No.: **SCS 108**

The Swiss Accreditation Service is one of the signatories to the EA  
Multilateral Agreement for the recognition of calibration certificates

### Glossary:

TSL	tissue simulating liquid
NORM <sub>x,y,z</sub>	sensitivity in free space
ConvF	sensitivity in TSL / NORM <sub>x,y,z</sub>
DCP	diode compression point
CF	crest factor (1/duty_cycle) of the RF signal
A, B, C	modulation dependent linearization parameters
Polarization $\varphi$	$\varphi$ rotation around probe axis
Polarization $\vartheta$	$\vartheta$ rotation around an axis that is in the plane normal to probe axis (at measurement center), i.e., $\vartheta = 0$ is normal to probe axis

### Calibration is Performed According to the Following Standards:

- IEEE Std 1528-2003, "IEEE Recommended Practice for Determining the Peak Spatial-Averaged Specific Absorption Rate (SAR) in the Human Head from Wireless Communications Devices: Measurement Techniques", December 2003
- IEC 62209-1, "Procedure to measure the Specific Absorption Rate (SAR) for hand-held devices used in close proximity to the ear (frequency range of 300 MHz to 3 GHz)", February 2005

### Methods Applied and Interpretation of Parameters:

- NORM<sub>x,y,z</sub>**: Assessed for E-field polarization  $\vartheta = 0$  ( $f \leq 900$  MHz in TEM-cell;  $f > 1800$  MHz: R22 waveguide). NORM<sub>x,y,z</sub> are only intermediate values, i.e., the uncertainties of NORM<sub>x,y,z</sub> does not affect the E<sup>2</sup>-field uncertainty inside TSL (see below ConvF).
- NORM(f)<sub>x,y,z</sub>** = NORM<sub>x,y,z</sub> \* frequency\_response (see Frequency Response Chart). This linearization is implemented in DASY4 software versions later than 4.2. The uncertainty of the frequency response is included in the stated uncertainty of ConvF.
- DCP<sub>x,y,z</sub>**: DCP are numerical linearization parameters assessed based on the data of power sweep with CW signal (no uncertainty required). DCP does not depend on frequency nor media.
- PAR**: PAR is the Peak to Average Ratio that is not calibrated but determined based on the signal characteristics
- A<sub>x,y,z</sub>; B<sub>x,y,z</sub>; C<sub>x,y,z</sub>; VR<sub>x,y,z</sub>**: A, B, C are numerical linearization parameters assessed based on the data of power sweep for specific modulation signal. The parameters do not depend on frequency nor media. VR is the maximum calibration range expressed in RMS voltage across the diode.
- ConvF and Boundary Effect Parameters**: Assessed in flat phantom using E-field (or Temperature Transfer Standard for  $f \leq 800$  MHz) and inside waveguide using analytical field distributions based on power measurements for  $f > 800$  MHz. The same setups are used for assessment of the parameters applied for boundary compensation (alpha, depth) of which typical uncertainty values are given. These parameters are used in DASY4 software to improve probe accuracy close to the boundary. The sensitivity in TSL corresponds to NORM<sub>x,y,z</sub> \* ConvF whereby the uncertainty corresponds to that given for ConvF. A frequency dependent ConvF is used in DASY version 4.4 and higher which allows extending the validity from  $\pm 50$  MHz to  $\pm 100$  MHz.
- Spherical isotropy (3D deviation from isotropy)**: in a field of low gradients realized using a flat phantom exposed by a patch antenna.
- Sensor Offset**: The sensor offset corresponds to the offset of virtual measurement center from the probe tip (on probe axis). No tolerance required.

# Probe ES3DV3

## SN:3287

Manufactured: June 7, 2010  
Calibrated: November 15, 2012

Calibrated for DASY/EASY Systems  
(Note: non-compatible with DASY2 system!)

## DASY/EASY - Parameters of Probe: ES3DV3 - SN:3287

### Basic Calibration Parameters

	Sensor X	Sensor Y	Sensor Z	Unc (k=2)
Norm ( $\mu\text{V}/(\text{V}/\text{m})^2$ ) <sup>A</sup>	1.31	1.25	1.25	$\pm 10.1 \%$
DCP (mV) <sup>B</sup>	102.9	103.6	101.6	

### Modulation Calibration Parameters

UID	Communication System Name	PAR		A dB	B dB	C dB	VR mV	Unc <sup>E</sup> (k=2)
0	CW	0.00	X	0.0	0.0	1.0	116.8	$\pm 3.5 \%$
			Y	0.0	0.0	1.0	118.5	
			Z	0.0	0.0	1.0	154.1	

The reported uncertainty of measurement is stated as the standard uncertainty of measurement multiplied by the coverage factor  $k=2$ , which for a normal distribution corresponds to a coverage probability of approximately 95%.

<sup>A</sup> The uncertainties of NormX,Y,Z do not affect the  $E^2$ -field uncertainty inside TSL (see Pages 5 and 6).

<sup>B</sup> Numerical linearization parameter: uncertainty not required.

<sup>E</sup> Uncertainty is determined using the max. deviation from linear response applying rectangular distribution and is expressed for the square of the field value.

## DASY/EASY - Parameters of Probe: ES3DV3 - SN:3287

### Calibration Parameter Determined in Head Tissue Simulating Media

f (MHz) <sup>C</sup>	Relative Permittivity <sup>F</sup>	Conductivity (S/m) <sup>F</sup>	ConvF X	ConvF Y	ConvF Z	Alpha	Depth (mm)	Unct. (k=2)
750	41.9	0.89	6.40	6.40	6.40	0.20	2.54	± 12.0 %
835	41.5	0.90	6.17	6.17	6.17	0.34	1.68	± 12.0 %
1750	40.1	1.37	5.16	5.16	5.16	0.63	1.30	± 12.0 %
1900	40.0	1.40	4.96	4.96	4.96	0.48	1.55	± 12.0 %
2450	39.2	1.80	4.30	4.30	4.30	0.79	1.31	± 12.0 %
2600	39.0	1.96	4.19	4.19	4.19	0.80	1.31	± 12.0 %

<sup>C</sup> Frequency validity of ± 100 MHz only applies for DASY v4.4 and higher (see Page 2), else it is restricted to ± 50 MHz. The uncertainty is the RSS of the ConvF uncertainty at calibration frequency and the uncertainty for the indicated frequency band.

<sup>F</sup> At frequencies below 3 GHz, the validity of tissue parameters ( $\epsilon$  and  $\sigma$ ) can be relaxed to ± 10% if liquid compensation formula is applied to measured SAR values. At frequencies above 3 GHz, the validity of tissue parameters ( $\epsilon$  and  $\sigma$ ) is restricted to ± 5%. The uncertainty is the RSS of the ConvF uncertainty for indicated target tissue parameters.

## DASY/EASY - Parameters of Probe: ES3DV3 - SN:3287

### Calibration Parameter Determined in Body Tissue Simulating Media

f (MHz) <sup>C</sup>	Relative Permittivity <sup>F</sup>	Conductivity (S/m) <sup>F</sup>	ConvF X	ConvF Y	ConvF Z	Alpha	Depth (mm)	Unct. (k=2)
750	55.5	0.96	6.14	6.14	6.14	0.28	2.06	± 12.0 %
835	55.2	0.97	6.06	6.06	6.06	0.42	1.63	± 12.0 %
1750	53.4	1.49	4.86	4.86	4.86	0.43	1.64	± 12.0 %
1900	53.3	1.52	4.69	4.69	4.69	0.56	1.54	± 12.0 %
2450	52.7	1.95	4.29	4.29	4.29	0.80	1.02	± 12.0 %
2600	52.5	2.16	4.12	4.12	4.12	0.64	0.92	± 12.0 %

<sup>C</sup> Frequency validity of ± 100 MHz only applies for DASY v4.4 and higher (see Page 2), else it is restricted to ± 50 MHz. The uncertainty is the RSS of the ConvF uncertainty at calibration frequency and the uncertainty for the indicated frequency band.

<sup>F</sup> At frequencies below 3 GHz, the validity of tissue parameters ( $\epsilon$  and  $\sigma$ ) can be relaxed to ± 10% if liquid compensation formula is applied to measured SAR values. At frequencies above 3 GHz, the validity of tissue parameters ( $\epsilon$  and  $\sigma$ ) is restricted to ± 5%. The uncertainty is the RSS of the ConvF uncertainty for indicated target tissue parameters.

### Frequency Response of E-Field (TEM-Cell:ifi110 EXX, Waveguide: R22)

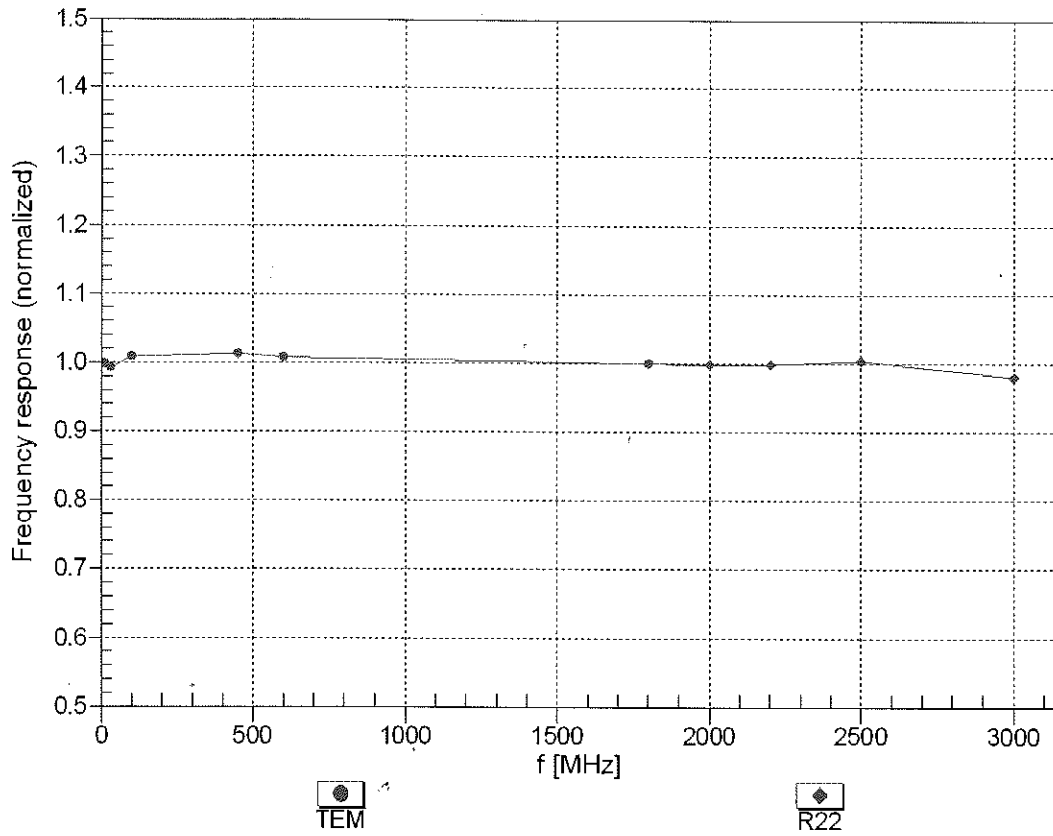

Uncertainty of Frequency Response of E-field:  $\pm 6.3\%$  (k=2)

# Receiving Pattern ( $\phi$ ), $\theta = 0^\circ$

f=600 MHz,TEM

f=1800 MHz,R22

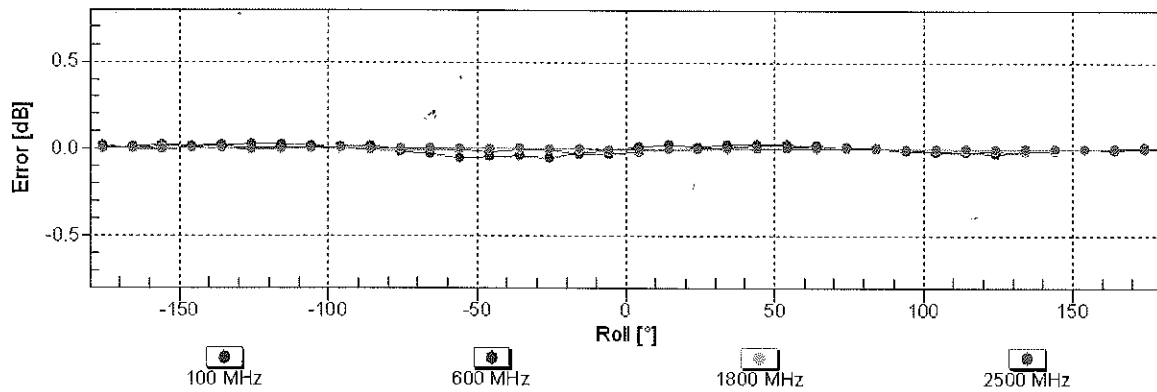
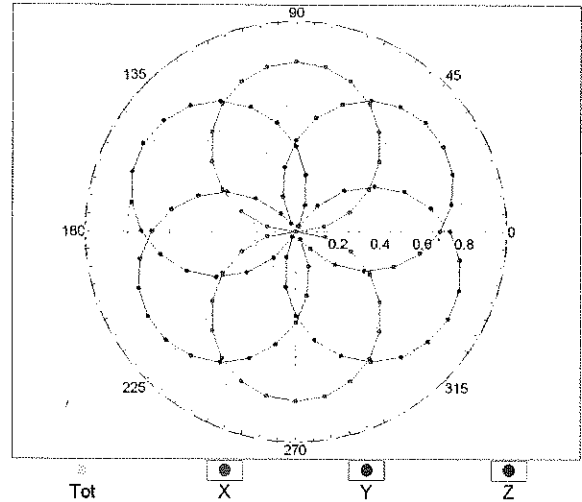
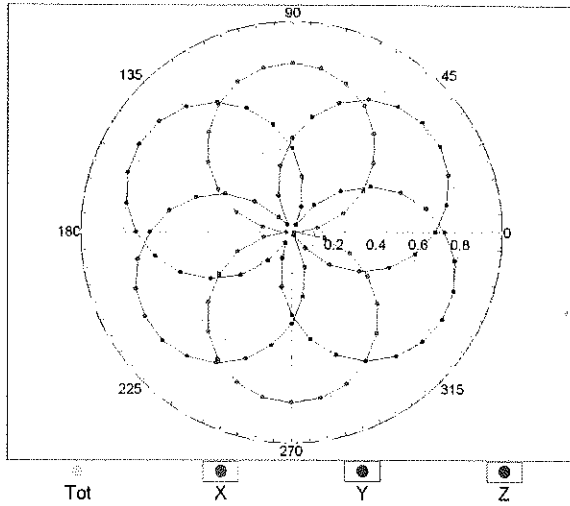

Uncertainty of Axial Isotropy Assessment:  $\pm 0.5\%$  (k=2)

## Dynamic Range f(SAR<sub>head</sub>) (TEM cell , f = 900 MHz)

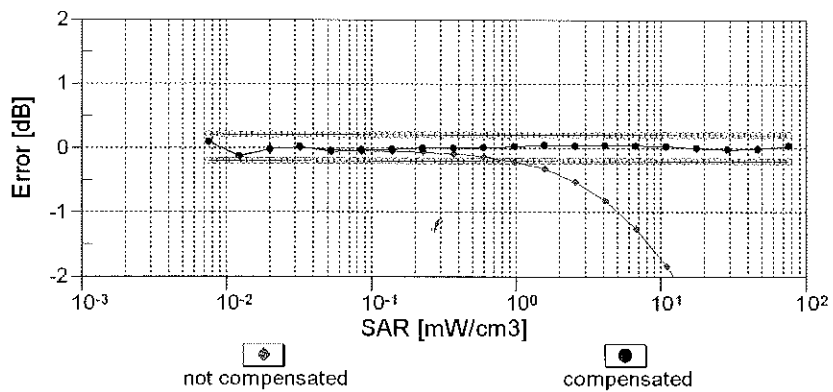
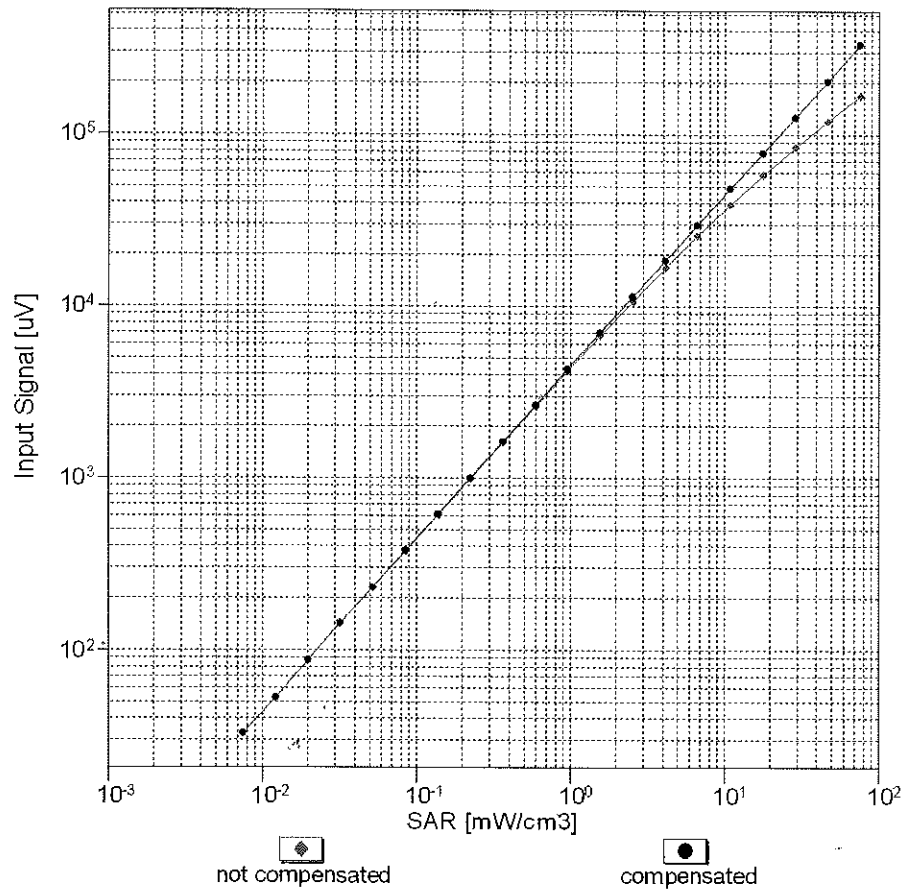

**Uncertainty of Linearity Assessment: ± 0.6% (k=2)**

# Conversion Factor Assessment

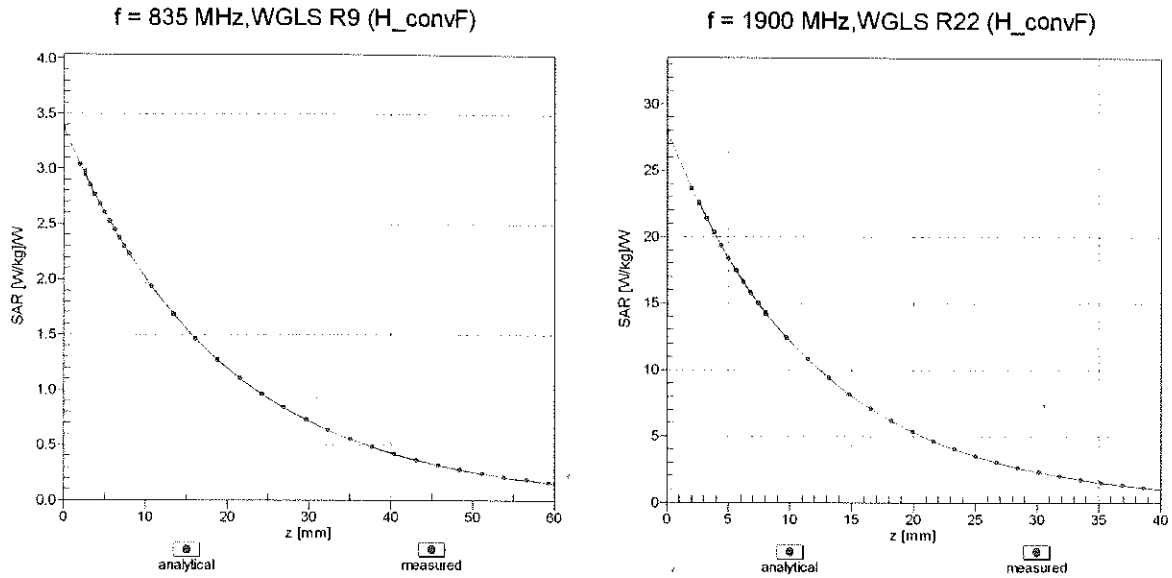

## Deviation from Isotropy in Liquid

Error ( $\phi, \theta$ ), f = 900 MHz

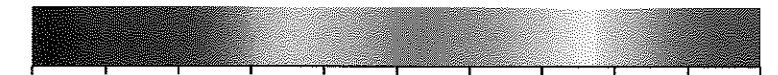
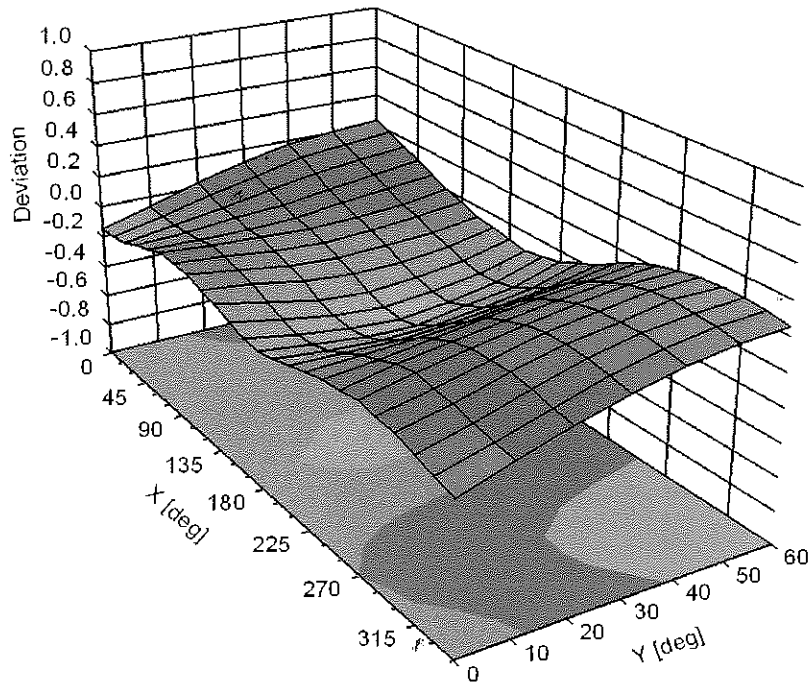

Uncertainty of Spherical Isotropy Assessment:  $\pm 2.6\%$  (k=2)

## DASY/EASY - Parameters of Probe: ES3DV3 - SN:3287

### Other Probe Parameters

Sensor Arrangement	Triangular
Connector Angle (°)	-15.9
Mechanical Surface Detection Mode	enabled
Optical Surface Detection Mode	disabled
Probe Overall Length	337 mm
Probe Body Diameter	10 mm
Tip Length	10 mm
Tip Diameter	4 mm
Probe Tip to Sensor X Calibration Point	2 mm
Probe Tip to Sensor Y Calibration Point	2 mm
Probe Tip to Sensor Z Calibration Point	2 mm
Recommended Measurement Distance from Surface	3 mm



Accredited by the Swiss Accreditation Service (SAS)  
The Swiss Accreditation Service is one of the signatories to the EA  
Multilateral Agreement for the recognition of calibration certificates

Accreditation No.: **SCS 108**

Client **PC Test**

Certificate No: **EX3-3920\_Feb13/2**

**CALIBRATION CERTIFICATE (Replacement of No: EX3-3920\_Feb13)**

Object **EX3DV4 - SN:3920**

Calibration procedure(s) **QA CAL-01.v8, QA CAL-14.v3, QA CAL-23.v4, QA CAL-25.v4  
Calibration procedure for dosimetric E-field probes**

Calibration date: **February 27, 2013**

This calibration certificate documents the traceability to national standards, which realize the physical units of measurements (SI).  
The measurements and the uncertainties with confidence probability are given on the following pages and are part of the certificate.

All calibrations have been conducted in the closed laboratory facility: environment temperature (22 ± 3)°C and humidity < 70%.

*✓ KOK 3/27/13*

Calibration Equipment used (M&TE critical for calibration)

Primary Standards	ID	Cal Date (Certificate No.)	Scheduled Calibration
Power meter E4419B	GB41293874	29-Mar-12 (No. 217-01508)	Apr-13
Power sensor E4412A	MY41498087	29-Mar-12 (No. 217-01508)	Apr-13
Reference 3 dB Attenuator	SN: S5054 (3c)	27-Mar-12 (No. 217-01531)	Apr-13
Reference 20 dB Attenuator	SN: S5086 (20b)	27-Mar-12 (No. 217-01529)	Apr-13
Reference 30 dB Attenuator	SN: S5129 (30b)	27-Mar-12 (No. 217-01532)	Apr-13
Reference Probe ES3DV2	SN: 3013	28-Dec-12 (No. ES3-3013_Dec12)	Dec-13
DAE4	SN: 660	31-Jan-13 (No. DAE4-660_Jan13)	Jan-14
Secondary Standards	ID	Check Date (in house)	Scheduled Check
RF generator HP 8648C	US3642U01700	4-Aug-99 (in house check Apr-11)	In house check: Apr-13
Network Analyzer HP 8753E	US37390585	18-Oct-01 (in house check Oct-12)	In house check: Oct-13

Calibrated by:	Name <b>Claudio Leubler</b>	Function Laboratory Technician	Signature 
Approved by:	Name <b>Katja Pokovic</b>	Function Technical Manager	Signature 

Issued: March 5, 2013

This calibration certificate shall not be reproduced except in full without written approval of the laboratory.



Accredited by the Swiss Accreditation Service (SAS)

The Swiss Accreditation Service is one of the signatories to the EA  
Multilateral Agreement for the recognition of calibration certificates

Accreditation No.: **SCS 108**

### Glossary:

TSL	tissue simulating liquid
NORM <sub>x,y,z</sub>	sensitivity in free space
ConvF	sensitivity in TSL / NORM <sub>x,y,z</sub>
DCP	diode compression point
CF	crest factor (1/duty_cycle) of the RF signal
A, B, C, D	modulation dependent linearization parameters
Polarization $\varphi$	$\varphi$ rotation around probe axis
Polarization $\vartheta$	$\vartheta$ rotation around an axis that is in the plane normal to probe axis (at measurement center), i.e., $\vartheta = 0$ is normal to probe axis

### Calibration is Performed According to the Following Standards:

- IEEE Std 1528-2003, "IEEE Recommended Practice for Determining the Peak Spatial-Averaged Specific Absorption Rate (SAR) in the Human Head from Wireless Communications Devices: Measurement Techniques", December 2003
- IEC 62209-1, "Procedure to measure the Specific Absorption Rate (SAR) for hand-held devices used in close proximity to the ear (frequency range of 300 MHz to 3 GHz)", February 2005

### Methods Applied and Interpretation of Parameters:

- NORM<sub>x,y,z</sub>**: Assessed for E-field polarization  $\vartheta = 0$  ( $f \leq 900$  MHz in TEM-cell;  $f > 1800$  MHz: R22 waveguide). NORM<sub>x,y,z</sub> are only intermediate values, i.e., the uncertainties of NORM<sub>x,y,z</sub> does not affect the E<sup>2</sup>-field uncertainty inside TSL (see below ConvF).
- NORM(f)<sub>x,y,z</sub>** = NORM<sub>x,y,z</sub> \* frequency\_response (see Frequency Response Chart). This linearization is implemented in DASY4 software versions later than 4.2. The uncertainty of the frequency response is included in the stated uncertainty of ConvF.
- DCP<sub>x,y,z</sub>**: DCP are numerical linearization parameters assessed based on the data of power sweep with CW signal (no uncertainty required). DCP does not depend on frequency nor media.
- PAR**: PAR is the Peak to Average Ratio that is not calibrated but determined based on the signal characteristics
- A<sub>x,y,z</sub>; B<sub>x,y,z</sub>; C<sub>x,y,z</sub>; D<sub>x,y,z</sub>; VR<sub>x,y,z</sub>**: A, B, C, D are numerical linearization parameters assessed based on the data of power sweep for specific modulation signal. The parameters do not depend on frequency nor media. VR is the maximum calibration range expressed in RMS voltage across the diode.
- ConvF and Boundary Effect Parameters**: Assessed in flat phantom using E-field (or Temperature Transfer Standard for  $f \leq 800$  MHz) and inside waveguide using analytical field distributions based on power measurements for  $f > 800$  MHz. The same setups are used for assessment of the parameters applied for boundary compensation (alpha, depth) of which typical uncertainty values are given. These parameters are used in DASY4 software to improve probe accuracy close to the boundary. The sensitivity in TSL corresponds to NORM<sub>x,y,z</sub> \* ConvF whereby the uncertainty corresponds to that given for ConvF. A frequency dependent ConvF is used in DASY version 4.4 and higher which allows extending the validity from  $\pm 50$  MHz to  $\pm 100$  MHz.
- Spherical isotropy (3D deviation from isotropy)**: in a field of low gradients realized using a flat phantom exposed by a patch antenna.
- Sensor Offset**: The sensor offset corresponds to the offset of virtual measurement center from the probe tip (on probe axis). No tolerance required.

# Probe EX3DV4

## SN:3920

Manufactured: December 18, 2012  
Calibrated: February 27, 2013

Calibrated for DASY/EASY Systems  
(Note: non-compatible with DASY2 system!)

## DASY/EASY - Parameters of Probe: EX3DV4 - SN:3920

### Basic Calibration Parameters

	Sensor X	Sensor Y	Sensor Z	Unc (k=2)
Norm ( $\mu\text{V}/(\text{V}/\text{m})^2$ ) <sup>A</sup>	0.34	0.50	0.50	$\pm 10.1\%$
DCP (mV) <sup>B</sup>	101.2	101.0	99.1	

### Modulation Calibration Parameters

UID	Communication System Name		A dB	B dB $\sqrt{\mu\text{V}}$	C	D dB	VR mV	Unc <sup>E</sup> (k=2)
0	CW	X	0.0	0.0	1.0	0.00	134.3	$\pm 3.3\%$
		Y	0.0	0.0	1.0		164.7	
		Z	0.0	0.0	1.0		161.4	

The reported uncertainty of measurement is stated as the standard uncertainty of measurement multiplied by the coverage factor  $k=2$ , which for a normal distribution corresponds to a coverage probability of approximately 95%.

<sup>A</sup> The uncertainties of NormX,Y,Z do not affect the  $E^2$ -field uncertainty inside TSL (see Pages 5 and 6).

<sup>B</sup> Numerical linearization parameter: uncertainty not required.

<sup>E</sup> Uncertainty is determined using the max. deviation from linear response applying rectangular distribution and is expressed for the square of the field value.

## DASY/EASY - Parameters of Probe: EX3DV4 - SN:3920

### Calibration Parameter Determined in Head Tissue Simulating Media

f (MHz) <sup>C</sup>	Relative Permittivity <sup>F</sup>	Conductivity (S/m) <sup>F</sup>	ConvF X	ConvF Y	ConvF Z	Alpha	Depth (mm)	Unct. (k=2)
750	41.9	0.89	9.86	9.86	9.86	0.19	1.39	± 12.0 %
835	41.5	0.90	9.58	9.58	9.58	0.77	0.54	± 12.0 %
1750	40.1	1.37	7.97	7.97	7.97	0.57	0.69	± 12.0 %
1900	40.0	1.40	7.73	7.73	7.73	0.54	0.73	± 12.0 %
2450	39.2	1.80	7.04	7.04	7.04	0.40	0.82	± 12.0 %
2600	39.0	1.96	6.80	6.80	6.80	0.49	0.76	± 12.0 %
5200	36.0	4.66	4.87	4.87	4.87	0.35	1.80	± 13.1 %
5300	35.9	4.76	4.73	4.73	4.73	0.37	1.80	± 13.1 %
5500	35.6	4.96	4.52	4.52	4.52	0.39	1.80	± 13.1 %
5600	35.5	5.07	4.17	4.17	4.17	0.50	1.80	± 13.1 %
5800	35.3	5.27	4.02	4.02	4.02	0.45	1.80	± 13.1 %

<sup>C</sup> Frequency validity of ± 100 MHz only applies for DASY v4.4 and higher (see Page 2), else it is restricted to ± 50 MHz. The uncertainty is the RSS of the ConvF uncertainty at calibration frequency and the uncertainty for the indicated frequency band.

<sup>F</sup> At frequencies below 3 GHz, the validity of tissue parameters ( $\epsilon$  and  $\sigma$ ) can be relaxed to ± 10% if liquid compensation formula is applied to measured SAR values. At frequencies above 3 GHz, the validity of tissue parameters ( $\epsilon$  and  $\sigma$ ) is restricted to ± 5%. The uncertainty is the RSS of the ConvF uncertainty for indicated target tissue parameters.

## DASY/EASY - Parameters of Probe: EX3DV4 - SN:3920

### Calibration Parameter Determined in Body Tissue Simulating Media

f (MHz) <sup>C</sup>	Relative Permittivity <sup>F</sup>	Conductivity (S/m) <sup>F</sup>	ConvF X	ConvF Y	ConvF Z	Alpha	Depth (mm)	Unct. (k=2)
750	55.5	0.96	9.57	9.57	9.57	0.43	0.83	± 12.0 %
835	55.2	0.97	9.42	9.42	9.42	0.36	0.98	± 12.0 %
1750	53.4	1.49	7.59	7.59	7.59	0.43	0.78	± 12.0 %
1900	53.3	1.52	7.38	7.38	7.38	0.33	0.91	± 12.0 %
2450	52.7	1.95	7.07	7.07	7.07	0.80	0.55	± 12.0 %
2600	52.5	2.16	6.73	6.73	6.73	0.80	0.56	± 12.0 %
5200	49.0	5.30	4.23	4.23	4.23	0.51	1.90	± 13.1 %
5300	48.9	5.42	4.13	4.13	4.13	0.49	1.90	± 13.1 %
5500	48.6	5.65	3.63	3.63	3.63	0.52	1.90	± 13.1 %
5600	48.5	5.77	3.62	3.62	3.62	0.49	1.90	± 13.1 %
5800	48.2	6.00	3.91	3.91	3.91	0.54	1.90	± 13.1 %

<sup>C</sup> Frequency validity of ± 100 MHz only applies for DASY v4.4 and higher (see Page 2), else it is restricted to ± 50 MHz. The uncertainty is the RSS of the ConvF uncertainty at calibration frequency and the uncertainty for the indicated frequency band.

<sup>F</sup> At frequencies below 3 GHz, the validity of tissue parameters ( $\epsilon$  and  $\sigma$ ) can be relaxed to ± 10% if liquid compensation formula is applied to measured SAR values. At frequencies above 3 GHz, the validity of tissue parameters ( $\epsilon$  and  $\sigma$ ) is restricted to ± 5%. The uncertainty is the RSS of the ConvF uncertainty for indicated target tissue parameters.

### Frequency Response of E-Field (TEM-Cell:ifi110 EXX, Waveguide: R22)

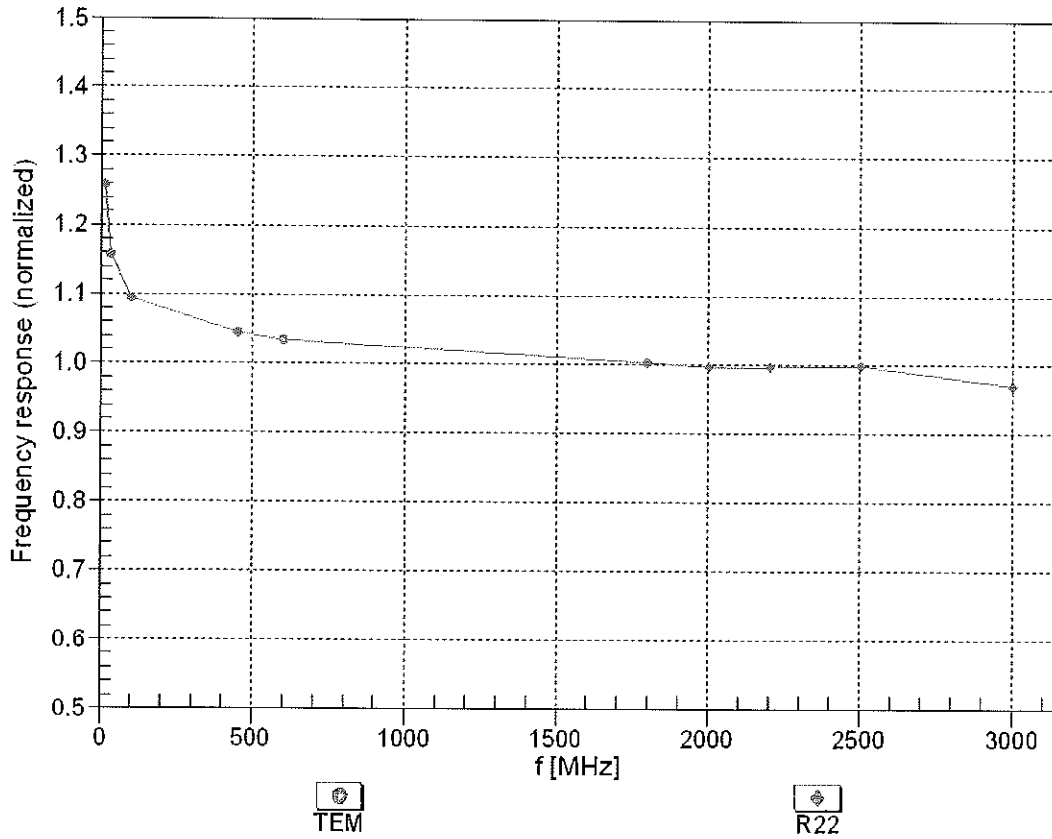

Uncertainty of Frequency Response of E-field:  $\pm 6.3\%$  (k=2)

### Receiving Pattern ( $\phi$ ), $\theta = 0^\circ$

f=600 MHz,TEM

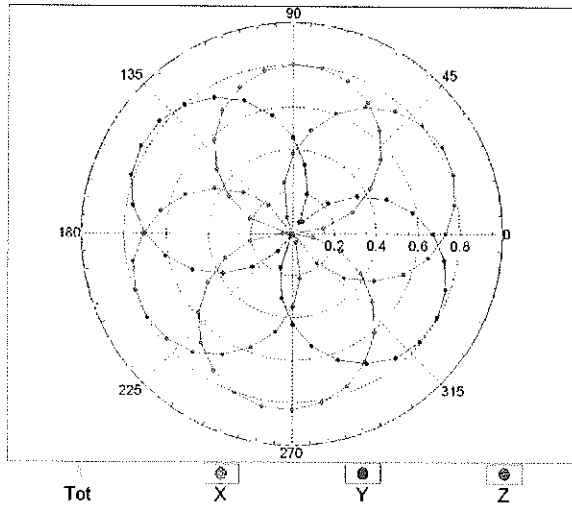

f=1800 MHz,R22

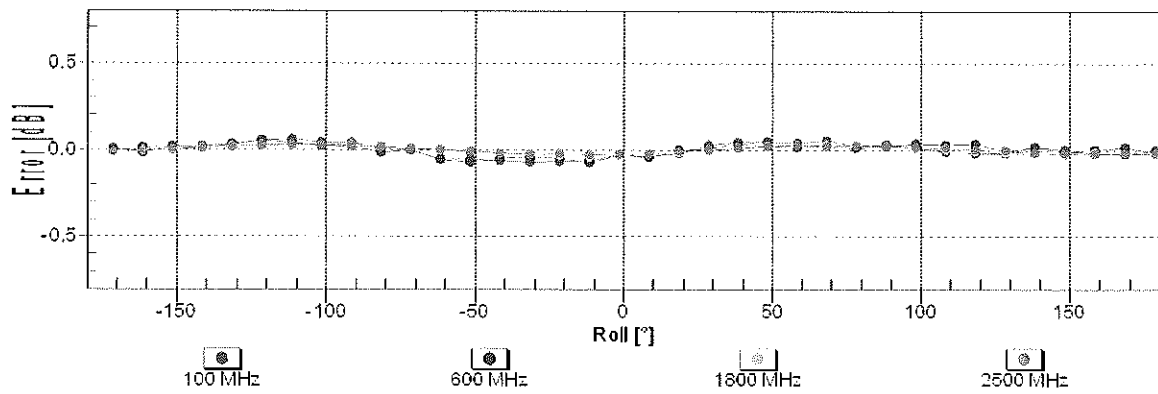
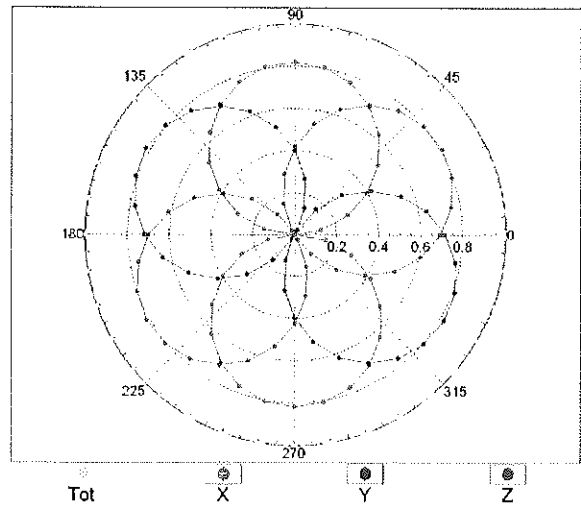

Uncertainty of Axial Isotropy Assessment:  $\pm 0.5\%$  (k=2)

### Dynamic Range f(SAR<sub>head</sub>) (TEM cell , f = 900 MHz)

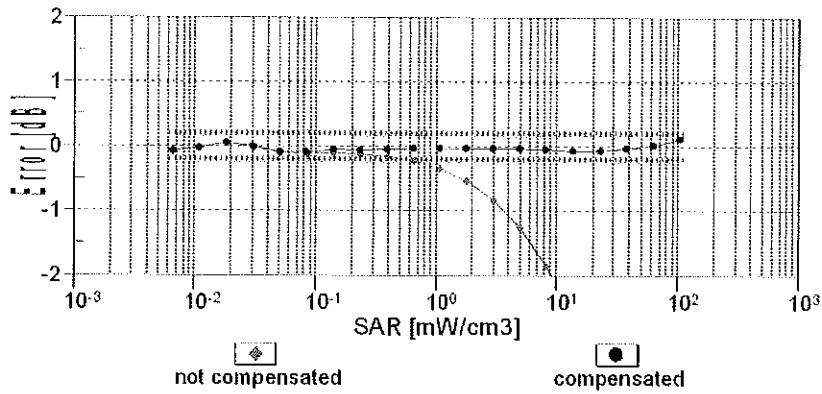
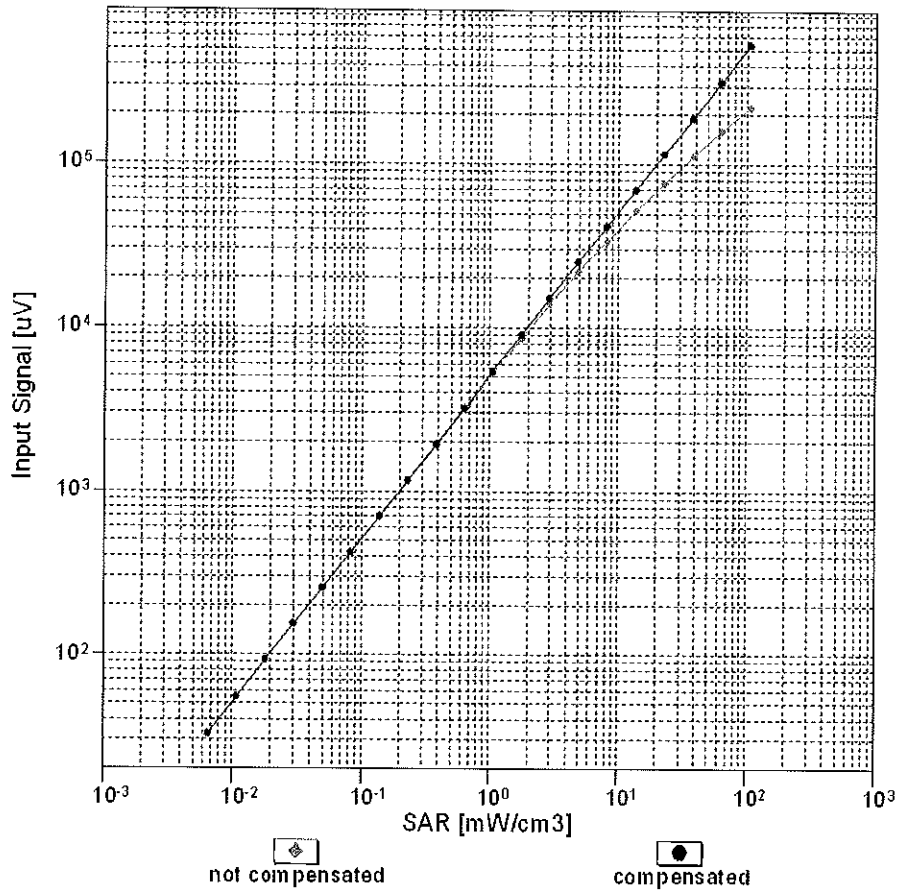

Uncertainty of Linearity Assessment: ± 0.6% (k=2)

# Conversion Factor Assessment

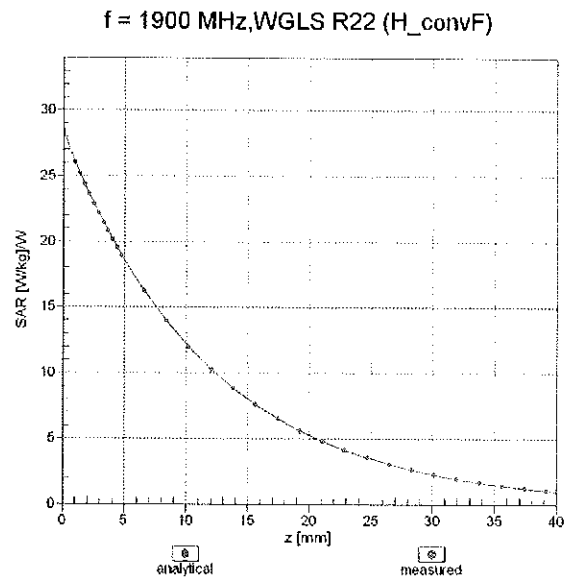
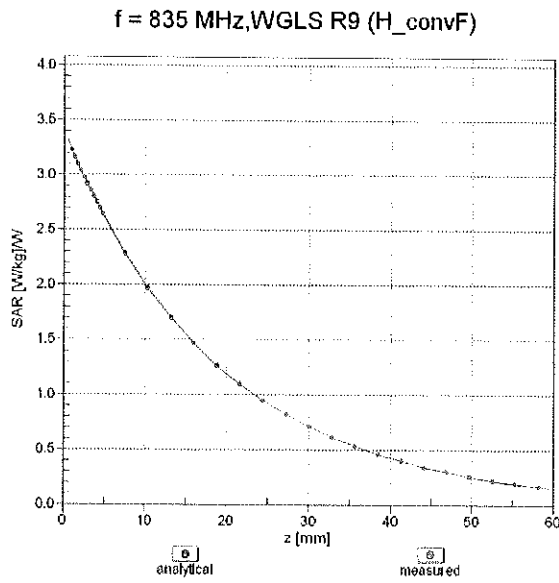

## Deviation from Isotropy in Liquid Error ( $\phi, \theta$ ), f = 900 MHz

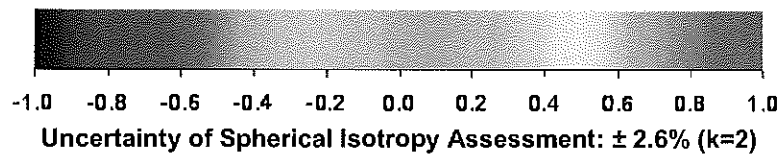
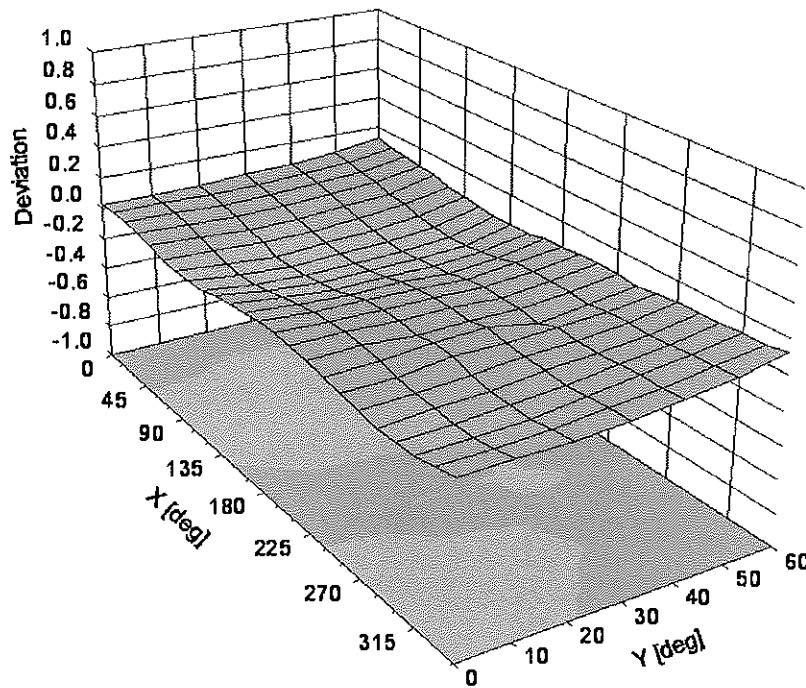

## DASY/EASY - Parameters of Probe: EX3DV4 - SN:3920

### Other Probe Parameters

Sensor Arrangement	Triangular
Connector Angle (°)	-21.6
Mechanical Surface Detection Mode	enabled
Optical Surface Detection Mode	disabled
Probe Overall Length	337 mm
Probe Body Diameter	10 mm
Tip Length	9 mm
Tip Diameter	2.5 mm
Probe Tip to Sensor X Calibration Point	1 mm
Probe Tip to Sensor Y Calibration Point	1 mm
Probe Tip to Sensor Z Calibration Point	1 mm
Recommended Measurement Distance from Surface	2 mm

**APPENDIX 8 : SAR T=GGI 9 GD9 7 = =7 5 H=CBG**

## APPENDIX D: SAR TISSUE SPECIFICATIONS

Measurement Procedure for Tissue verification:



- 1) The network analyzer and probe system was configured and calibrated.
- 2) The probe was immersed in the tissue. The tissue was placed in a nonmetallic container. Trapped air bubbles beneath the flange were minimized by placing the probe at a slight angle.
- 3) The complex admittance with respect to the probe aperture was measured
- 4) The complex relative permittivity  $\epsilon$  can be calculated from the below equation (Pournaropoulos and Misra):

$$Y = \frac{j2\omega\epsilon_r\epsilon_0}{[\ln(b/a)]^2} \int_a^b \int_a^b \int_0^\pi \cos\phi' \frac{\exp[-j\omega r(\mu_0\epsilon_r'\epsilon_0)^{1/2}]}{r} d\phi' d\rho' d\rho$$

where  $Y$  is the admittance of the probe in contact with the sample, the primed and unprimed coordinates refer to source and observation points, respectively,  $r^2 = \rho^2 + \rho'^2 - 2\rho\rho' \cos\phi'$ ,  $\omega$  is the angular frequency, and  $j = \sqrt{-1}$ .

**Table D-I  
Composition of the Tissue Equivalent Matter**

Frequency (MHz)	835	835	1900	1900	2450	2450
Tissue	Head	Body	Head	Body	Head	Body
Ingredients (% by weight)						
Bactericide	0.1	0.1			See Page 2	
DGBE			44.92	29.44		26.7
HEC	1	1				
NaCl	1.45	0.94	0.18	0.39		0.1
Sucrose	57	44.9				
Water	40.45	53.06	54.9	70.17		73.2

FCC ID: A3LGTS6792L		SAR EVALUATION REPORT		Reviewed by: Quality Manager
Test Dates: 08/19/13-8/21/2013	DUT Type: Portable Handset			APPENDIX D: Page 1 of 2

## 2 Composition / Information on ingredients

The Item is composed of the following ingredients:

H <sub>2</sub> O	Water, 52 – 75%
C <sub>8</sub> H <sub>18</sub> O <sub>3</sub>	Diethylene glycol monobutyl ether (DGBE), 25 – 48% (CAS-No. 112-34-5, EC-No. 203-961-6, EC-index-No. 603-096-00-8) Relevant for safety; Refer to the respective Safety Data Sheet*.
NaCl	Sodium Chloride, <1.0%

**Figure D-1**  
**Composition of 2.4 GHz Head Tissue Equivalent Matter**

**Note:** 2.4 GHz head liquid recipes are proprietary SPEAG. Since the composition is approximate to the actual liquids utilized, the manufacturer tissue-equivalent liquid data sheets are provided below.

### Measurement Certificate / Material Test

Item Name	Head Tissue Simulating Liquid (HSL 2450)
Product No.	SL AAH 245 BA (Charge: 120112-4)
Manufacturer	SPEAG

### Measurement Method

TSL dielectric parameters measured using calibrated OCP probe (type DAK).

### Target Parameters

Target parameters as defined in the IEEE 1528 and IEC 62209 compliance standards.

### Test Condition

Ambient Condition 22°C; 30% humidity  
TSL Temperature 23°C  
Test Date 18-Jan-12

### Additional Information



TSL Density 0.988 g/cm<sup>3</sup>  
TSL Heat-capacity 3.680 kJ/(kg\*K)

### Results

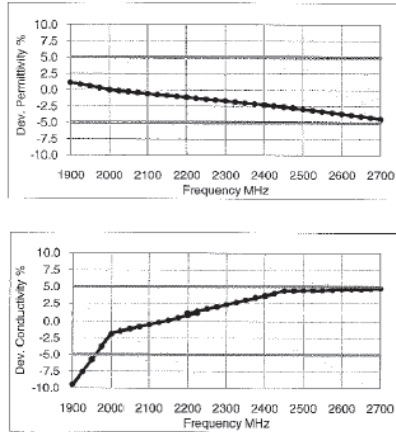
f [MHz]	Measured			Target		Diff.to Target [%]	
	HP-e'	HP-e''	sigma	eps	sigma	Δ-eps	Δ-sigma
1900	40.5	11.99	1.27	40.0	1.40	1.1	-9.5
1925	40.3	12.08	1.29	40.0	1.40	0.9	-7.6
1950	40.2	12.17	1.32	40.0	1.40	0.6	-5.7
1975	40.1	12.26	1.35	40.0	1.40	0.3	-3.8
2000	40.0	12.35	1.37	40.0	1.40	0.0	-1.9
2025	39.9	12.44	1.40	40.0	1.42	-0.1	-1.5
2050	39.8	12.53	1.43	39.9	1.44	-0.3	-1.1
2075	39.7	12.60	1.46	39.9	1.47	-0.4	-0.8
2100	39.6	12.68	1.48	39.8	1.48	-0.6	-0.5
2125	39.5	12.76	1.51	39.8	1.51	-0.7	-0.2
2150	39.4	12.84	1.54	39.7	1.53	-0.8	0.2
2175	39.3	12.93	1.56	39.7	1.56	-1.0	0.6
2200	39.2	13.02	1.59	39.6	1.58	-1.1	1.0
2225	39.1	13.09	1.62	39.6	1.60	-1.3	1.3
2250	39.0	13.17	1.65	39.6	1.62	-1.4	1.6
2275	38.9	13.25	1.68	39.5	1.64	-1.5	2.0
2300	38.8	13.33	1.71	39.5	1.67	-1.7	2.3
2325	38.7	13.40	1.73	39.4	1.69	-1.8	2.7
2350	38.6	13.48	1.76	39.4	1.71	-2.0	3.0
2375	38.5	13.56	1.79	39.3	1.73	-2.1	3.3
2400	38.4	13.63	1.82	39.3	1.76	-2.3	3.7
2425	38.3	13.71	1.85	39.2	1.78	-2.4	4.0
2450	38.2	13.78	1.88	39.2	1.80	-2.6	4.4
2475	38.1	13.85	1.91	39.2	1.83	-2.7	4.4
2500	38.0	13.93	1.94	39.1	1.85	-2.9	4.4
2525	37.9	13.99	1.97	39.1	1.88	-3.1	4.4
2550	37.8	14.06	1.99	39.1	1.91	-3.3	4.4
2575	37.7	14.13	2.02	39.0	1.94	-3.5	4.5
2600	37.6	14.20	2.05	39.0	1.96	-3.7	4.6
2625	37.5	14.28	2.08	39.0	1.99	-3.8	4.6
2650	37.4	14.32	2.11	38.9	2.02	-4.0	4.6
2675	37.3	14.39	2.14	38.9	2.05	-4.3	4.7
2700	37.1	14.46	2.17	38.9	2.07	-4.5	4.8



**Figure D-2**  
**2.4 GHz Head Tissue Equivalent Matter**

FCC ID: A3LGTS6792L		SAR EVALUATION REPORT		Reviewed by: Quality Manager
Test Dates: 08/19/13-8/21/2013	DUT Type: Portable Handset			APPENDIX D: Page 2 of 2

## APPENDIX 9: G5 F SYSTEM V5 @-8 5 H=C B

## APPENDIX E: SAR SYSTEM VALIDATION



Per FCC KDB 865664 D02v01r01, SAR system validation status should be documented to confirm measurement accuracy. The SAR systems (including SAR probes, system components and software versions) used for this device were validated against its performance specifications prior to the SAR measurements. Reference dipoles were used with the required tissue- equivalent media for system validation, according to the procedures outlined in IEEE 1528-2003 and FCC KDB 865664 D01 v01r01. Since SAR probe calibrations are frequency dependent, each probe calibration point was validated at a frequency within the valid frequency range of the probe calibration point, using the system that normally operates with the probe for routine SAR measurements and according to the required tissue-equivalent media.

A tabulated summary of the system validation status including the validation date(s), measurement frequencies, SAR probes and tissue dielectric parameters has been included.

**Table E-I**  
**SAR System Validation Summary**

SAR SYSTEM #	FREQ. [MHz]	DATE	PROBE SN	PROBE TYPE	PROBE CAL. POINT		COND.	PERM.	CW VALIDATION			MOD. VALIDATION		
							( $\sigma$ )	( $\epsilon_r$ )	SENSI-TIVITY	PROBE LINEARITY	PROBE ISOTROPY	MOD. TYPE	DUTY FACTOR	PAR
H	835	6/20/2013	3318	ES3DV3	835	Head	0.910	41.10	PASS	PASS	PASS	GMSK	PASS	PASS
G	1900	3/27/2013	3209	ES3DV3	1900	Head	1.449	39.10	PASS	PASS	PASS	GMSK	PASS	N/A
C	2450	8/12/2013	3263	ES3DV3	2450	Head	1.863	38.51	PASS	PASS	PASS	OFDM TDD	N/A	PASS
G	835	3/27/2013	3209	ES3DV3	835	Head	0.925	41.29	PASS	PASS	PASS	GMSK	PASS	PASS
B	1900	1/29/2013	3287	ES3DV3	1900	Body	1.570	51.00	PASS	PASS	PASS	GMSK	PASS	N/A
E	1900	3/5/2013	3920	EX3DV4	1900	Body	1.574	52.42	PASS	PASS	PASS	GMSK	PASS	N/A
H	2450	6/21/2013	3318	ES3DV3	2450	Body	2.006	51.66	PASS	PASS	PASS	OFDM	N/A	PASS

NOTE: All measurements were performed using probes calibrated for CW signals only. Modulations in the table above represent test configurations for which the measurement system has been validated per FCC KDB Publication 865664 D01v01r01. SAR systems were validated for modulated signals with a periodic duty cycle, such as GMSK, or with a high peak to average ratio (>5 dB), such as OFDM according to KDB 865664.

FCC ID: A3LGTS6792L	 PCTEST ENGINEERING LABORATORY, INC.	SAR EVALUATION REPORT		Reviewed by: Quality Manager
Test Dates: 08/19/13 - 08/21/13	DUT Type: Portable Handset			APPENDIX E: Page 1 of 1