



PCTEST ENGINEERING LABORATORY, INC.

6660-B Dobbin Road, Columbia, MD 21045 USA
Tel. 410.290.6652 / Fax 410.290.6554
<http://www.pctestlab.com>



CERTIFICATE OF COMPLIANCE (SAR EVALUATION)

Applicant Name:
Samsung Electronics, Co. Ltd.
18600 Broadwick St.
Rancho Dominguez, CA 90220
United States

Date of Testing:
May 04-05, 2009
Test Site/Location:
PCTEST Lab, Columbia, MD, USA
Test Report Serial No.:
0905040932.A3L

FCC ID: A3LGTS6700T

APPLICANT: SAMSUNG ELECTRONICS, CO. LTD.

EUT Type: 850/1900 GSM/GPRS/EDGE and 850 WCDMA Phone with Bluetooth
Application Type: Certification
FCC Rule Part(s): §2.1093; FCC/OET Bulletin 65 Supplement C [July 2001]
FCC Classification: Licensed Transmitter Held to Ear (PCE)
Model(s): GT-S6700T
Tx Frequency: 824.20 - 848.80 MHz (Cellular GSM)
1850.20 - 1909.80 MHz (GSM PCS)
826.4 - 846.6 MHz (Cellular WCDMA)
Conducted Power: 32.5 dBm Cellular GSM / 29.78 dBm PCS GSM
23.42 dBm Cellular WCDMA
Max. SAR Measurement: 0.440 W/kg GSM850 Head SAR / 0.989 W/kg GPRS850 Body SAR
0.135 W/kg GSM1900 Head SAR / 0.471 W/kg GPRS1900 Body SAR
0.315 W/kg WCDMA850 Head SAR / 0.432 W/kg WCDMA850 Body SAR
Test Device Serial No.: Pre-Production [S/N: FG-110-A]

This wireless portable device has been shown to be capable of compliance for localized specific absorption rate (SAR) for uncontrolled environment/general population exposure limits specified in ANSI/IEEE Std. C95.1-2005 and has been tested in accordance with the measurement procedures specified in FCC/OET Bulletin 65 Supplement C (2001) and IEEE Std. 1528-2003.

I attest to the accuracy of data. All measurements reported herein were performed by me or were made under my supervision and are correct to the best of my knowledge and belief. I assume full responsibility for the completeness of these measurements and vouch for the qualifications of all persons taking them.

Grant Conditions: Power output listed is ERP for Part 22 and EIRP for Part 24. SAR compliance for body-worn operating configuration is based on a separation distance of 1.5 cm between the device and the body of the user. End-users must be informed of the body-worn operating requirements for satisfying RF exposure compliance. Belt clips or holsters not specified in this filing may not contain metallic components.

PCTEST certifies that no party to this application has been denied the FCC benefits pursuant to Section 5301 of the Anti-Drug Abuse Act of 1988, 21 U.S.C. 862.



Randy Ortanez
President



FCC ID: A3LGTS6700T		CERTIFICATION REPORT		Reviewed by: Quality Manager
SAR Filename: 0905040932.A3L	Test Dates: May 04-05, 2009	EUT Type: 850/1900 GSM/GPRS/EDGE and 850 WCDMA Phone with Bluetooth		Page 1 of 27

T A B L E O F C O N T E N T S

1	INTRODUCTION	3
2	TEST SITE LOCATION	4
3	SAR MEASUREMENT SETUP	5
4	DASY E-FIELD PROBE SYSTEM	7
5	PROBE CALIBRATION PROCESS	8
6	PHANTOM AND EQUIVALENT TISSUES.....	9
7	DOSIMETRIC ASSESSMENT & PHANTOM SPECS.....	10
8	DEFINITION OF REFERENCE POINTS	11
9	TEST CONFIGURATION POSITIONS	12
10	ANSI/IEEE C95.1-2005 RF EXPOSURE LIMITS.....	15
11	MEASUREMENT UNCERTAINTIES	16
12	SYSTEM VERIFICATION.....	17
13	FCC MULTI-TX AND ANTENNA SAR CONSIDERATIONS.....	18
14	FCC 3G MEASUREMENT PROCEDURES.....	19
15	SAR DATA SUMMARY	20
16	EQUIPMENT LIST.....	24
17	CONCLUSION.....	25
18	REFERENCES	26

FCC ID: A3LGTS6700T	 <small>ENGINEERING LABORATORY, INC.</small>	CERTIFICATION REPORT		Reviewed by: Quality Manager
SAR Filename: 0905040932.A3L	Test Dates: May 04-05, 2009	EUT Type: 850/1900 GSM/GPRS/EDGE and 850 WCDMA Phone with Bluetooth		Page 2 of 27

1 INTRODUCTION

The FCC has adopted the guidelines for evaluating the environmental effects of radio frequency (RF) radiation in ET Docket 93-62 on Aug. 6, 1996 to protect the public and workers from the potential hazards of RF emissions due to FCC-regulated portable devices.[1]

The safety limits used for the environmental evaluation measurements are based on the criteria published by the American National Standards Institute (ANSI) for localized specific absorption rate (SAR) in IEEE/ANSI C95.1-2005 Standard for Safety Levels with Respect to Human Exposure to Radio Frequency Electromagnetic Fields, 3 kHz to 300 GHz[2] and Health Canada RF Exposure Guidelines Safety Code 6 [26]. The measurement procedure described in IEEE/ANSI C95.3-2002 Recommended Practice for the Measurement of Potentially Hazardous Electromagnetic Fields - RF and Microwave [3] is used for guidance in measuring the Specific Absorption Rate (SAR) due to the RF radiation exposure from the Equipment Under Test (EUT). These criteria for SAR evaluation are similar to those recommended by the International Committee for Non-Ionizing Radiation Protection (ICNIRP) in Biological Effects and Exposure Criteria for Radiofrequency Electromagnetic Fields,” Report No. Vol 74. SAR is a measure of the rate of energy absorption due to exposure to an RF transmitting source. SAR values have been related to threshold levels for potential biological hazards.

1.1 SAR Definition

Specific Absorption Rate is defined as the time derivative (rate) of the incremental energy (dU) absorbed by (dissipated in) an incremental mass (dm) contained in a volume element (dV) of a given density (ρ). It is also defined as the rate of RF energy absorption per unit mass at a point in an absorbing body (see Fig. 1-1).

$$SAR = \frac{d}{dt} \left(\frac{dU}{dm} \right) = \frac{d}{dt} \left(\frac{dU}{\rho dV} \right)$$

**Figure 1-1
SAR Mathematical Equation**



SAR is expressed in units of Watts per Kilogram (W/kg).

$$SAR = \frac{\sigma \cdot E^2}{\rho}$$

where:

- σ = conductivity of the tissue-simulating material (S/m)
- ρ = mass density of the tissue-simulating material (kg/m³)
- E = Total RMS electric field strength (V/m)

NOTE: The primary factors that control rate of energy absorption were found to be the wavelength of the incident field in relation to the dimensions and geometry of the irradiated organism, the orientation of the organism in relation to the polarity of field vectors, the presence of reflecting surfaces, and whether conductive contact is made by the organism with a ground plane.[6]

FCC ID: A3LGTS6700T	 PCTEST ENGINEERING LABORATORY, INC.	CERTIFICATION REPORT		Reviewed by: Quality Manager
SAR Filename: 0905040932.A3L	Test Dates: May 04-05, 2009	EUT Type: 850/1900 GSM/GPRS/EDGE and 850 WCDMA Phone with Bluetooth		Page 3 of 27

2 TEST SITE LOCATION

2.1 INTRODUCTION

The map at the right shows the location of the PCTEST LABORATORY in Columbia, Maryland. It is in proximity to the FCC Laboratory, the Baltimore-Washington International (BWI) airport, the city of Baltimore and Washington, DC (See Figure 2).

These measurement tests were conducted at the PCTEST Engineering Laboratory, Inc. facility in New Concept Business Park, Guilford Industrial Park, Columbia, Maryland. The site address is 6660-B Dobbin Road, Columbia, MD 21045. The test site is one of the highest points in the Columbia area with an elevation of 390 feet above mean sea level. The site coordinates are 39° 11'15" N latitude and 76° 49' 38" W longitude. The facility is 1.5 miles north of the FCC laboratory, and the ambient signal and ambient signal strength are approximately equal to those of the FCC laboratory. There are no FM or TV transmitters within 15 miles of the site. The detailed description of the measurement facility was found to be in compliance with the requirements of § 2.948 according to ANSI C63.4 on January 27, 2006 and Industry Canada.





Figure 2-1
Map of the Greater Baltimore and Metropolitan Washington, D.C. area

2.2 Test Facility / Accreditations:

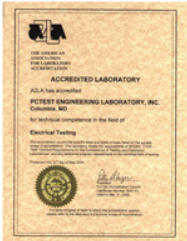
Measurements were performed at an independent accredited PCTEST Engineering Lab located in Columbia, MD 21045, U.S.A.



- PCTEST Lab is accredited to ISO 17025-2005 by the American Association for Laboratory Accreditation (A2LA) in Specific Absorption Rate (SAR) testing, Hearing-Aid Compatibility (HAC), CTIA Test Plans, and wireless testing for FCC and Industry Canada Rules.
- PCTEST Lab is accredited to ISO 17025 by U.S. National Institute of Standards and Technology (NIST) under the National Voluntary Laboratory Accreditation Program (NVLAP Lab code: 100431-0) in EMC, FCC and Telecommunications.
- PCTEST facility is an FCC registered (PCTEST Reg. No. 90864) test facility with the site description report on file and has met all the requirements specified in Section 2.948 of the FCC Rules and Industry Canada (IC-2451).
- PCTEST Lab is a recognized U.S. Conformity Assessment Body (CAB) in EMC and R&TTE (n.b. 0982) under the U.S.-EU Mutual Recognition Agreement (MRA).
- PCTEST TCB is a Telecommunication Certification Body (TCB) accredited to ISO/IEC Guide 65 by the American National Standards Institute (ANSI) in all scopes of FCC Rules and all Industry Canada Standards (RSS).
- PCTEST facility is an IC registered (IC-2451) test laboratory with the site description on file at Industry Canada.
- PCTEST is a CTIA Authorized Test Laboratory (CATL) for AMPS and CDMA, and EvDO mobile phones.
- PCTEST is a CTIA Authorized Test Laboratory (CATL) for Over-the-Air (OTA) Antenna Performance testing for AMPS, CDMA, GSM, GPRS, EGPRS, UMTS (W-CDMA), CDMA 1xEVDO Data, CDMA 1xRTT Data.

FCC ID: A3LGTS6700T		CERTIFICATION REPORT		Reviewed by: Quality Manager
SAR Filename: 0905040932.A3L	Test Dates: May 04-05, 2009	EUT Type: 850/1900 GSM/GPRS/EDGE and 850 WCDMA Phone with Bluetooth		Page 4 of 27

3 SAR MEASUREMENT SETUP

3.1 Robotic System

Measurements are performed using the DASY4 automated dosimetric assessment system. The DASY4 is made by Schmid & Partner Engineering AG (SPEAG) in Zurich, Switzerland and consists of high precision robotics system (Staubli), robot controller, Pentium 4 computer, near-field probe, probe alignment sensor, and the generic twin phantom containing the brain equivalent material. The robot is a six-axis industrial robot performing precise movements to position the probe to the location (points) of maximum electromagnetic field (EMF) (see Figure 3-1).

3.2 System Hardware

A cell controller system contains the power supply, robot controller, teach pendant (Joystick), and a remote control used to drive the robot motors. The PC consists of the Gateway Pentium 4 2.53 GHz computer with Windows XP system and SAR Measurement Software DASY4, A/D interface card, monitor, mouse, and keyboard. The Staubli Robot is connected to the cell controller to allow software manipulation of the robot. A data acquisition electronic (DAE) circuit that performs the signal amplification, signal multiplexing, AD-conversion, offset measurements, mechanical surface detection, collision detection, etc. is connected to the Electro-optical coupler (EOC). The EOC performs the conversion from the optical into digital electric signal of the DAE and transfers data to the PC plug-in card.

3.3 System Electronics

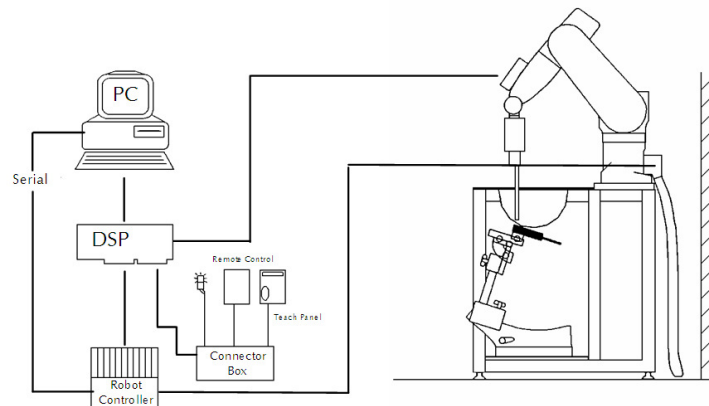



Figure 3-1
SAR Measurement System Setup

The DAE4 consists of a highly sensitive electrometer-grade preamplifier with auto-zeroing, a channel and gain-switching multiplexer, a fast 16 bit AD-converter and a command decoder and control logic unit. Transmission to the PC-card is accomplished through an optical downlink for data and status information and an optical uplink for commands and clock lines. The mechanical probe mounting device includes two different sensor systems for frontal and sidewise probe contacts. They are also used for mechanical surface detection and probe collision detection. The robot uses its own controller with a built in VME-bus computer. The system is described in detail in [7].

FCC ID: A3LGTS6700T	 PCTEST ENGINEERING LABORATORY, INC.	CERTIFICATION REPORT		Reviewed by: Quality Manager
SAR Filename: 0905040932.A3L	Test Dates: May 04-05, 2009	EUT Type: 850/1900 GSM/GPRS/EDGE and 850 WCDMA Phone with Bluetooth		Page 5 of 27

3.4 Automated Test System Specifications

Positioner

Robot: Stäubli Unimation Corp. Robot RX60L
 Repeatability: 0.02 mm
 No. of Axes: 6

Data Acquisition Electronic System (DAE)

Cell Controller

Processor: Pentium 4
 Clock Speed: 2.53 GHz
 Operating System: Windows XP Professional

Data Converter

Features: Signal Amplifier, multiplexer, A/D converter & control logic
 Software: DASY4, SEMCAD software
 Connecting Lines: Optical Downlink for data and status info
 Optical upload for commands and clock

PC Interface Card



Function: 166MHz low power Pentium MMX 32MB chipdisk
 Link to DAE
 16-bit A/D converter for surface detection system
 Two Serial & Ethernet link to robotics
 Direct emergency stop output for robot

Phantom

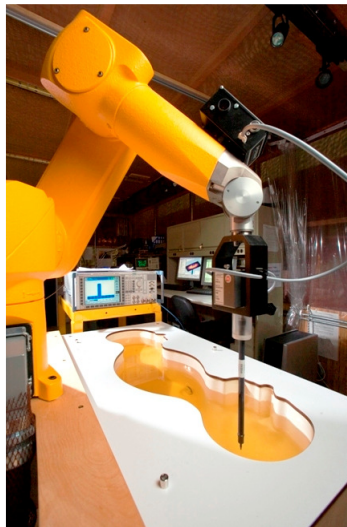
Type: SAM Twin Phantom (V4.0)
 Shell Material: Composite
 Thickness: 2.0 ± 0.2 mm



**Figure 3-2
 DASY4 SAR Measurement System**

FCC ID: A3LGTS6700T		CERTIFICATION REPORT		Reviewed by: Quality Manager
SAR Filename: 0905040932.A3L	Test Dates: May 04-05, 2009	EUT Type: 850/1900 GSM/GPRS/EDGE and 850 WCDMA Phone with Bluetooth		Page 6 of 27

4.1 Probe Measurement System



Figure 4-1
SAR System

The SAR measurements were conducted with the dosimetric probe EX3DV4, designed in the classical triangular configuration [7] (see Figure 4-3) and optimized for dosimetric evaluation. The probe is constructed using the thick film technique; with printed resistive lines on ceramic substrates. The probe is equipped with an optical multi-fiber line ending at the front of the probe tip. It is connected to the EOC box on the robot arm and provides an automatic detection of the phantom surface. Half of the fibers are connected to a pulsed infrared transmitter, the other half to a synchronized receiver. As the probe approaches the surface, the reflection from the surface produces a coupling from the transmitting to the receiving fibers. This reflection increases first during the approach, reaches maximum and then decreases. If the probe is flatly touching the surface, the coupling is zero. The distance of the coupling maximum to the surface is independent of the surface reflectivity and largely independent of the surface to probe angle. The DASY4 software reads the reflection during a software approach

and looks for the maximum using a 2nd order fitting (see Figure 5-1). The approach is stopped at reaching the maximum.

4.2 Probe Specifications



Model:	ES3DV3, EX3DV4
Frequency Range:	10 MHz – 6.0 GHz (EX3DV4) 10 MHz – 4 GHz (ES3DV3)
Calibration:	In brain and muscle simulating tissue at Frequencies from 835 up to 5800MHz
Linearity:	± 0.2 dB (30 MHz to 6 GHz) for EX3DV4 ± 0.2 dB (30 MHz to 4 GHz) for ES3DV3
Dynamic Range:	10 mW/kg – 100 W/kg
Probe Length:	330 mm
Probe Tip Length:	20 mm
Body Diameter:	12 mm
Tip Diameter:	2.5 mm (3.9mm for ES3DV3)
Tip-Center:	1 mm (2.0 mm for ES3DV3)
Application:	SAR Dosimetry Testing Compliance tests of mobile phones Dosimetry in strong gradient fields



Figure 4-2
Near-Field Probe



Figure 4-3
Triangular Probe
Configuration

FCC ID: A3LGTS6700T	 PCTEST ENGINEERING LABORATORY, INC.	CERTIFICATION REPORT		Reviewed by: Quality Manager
SAR Filename: 0905040932.A3L	Test Dates: May 04-05, 2009	EUT Type: 850/1900 GSM/GPRS/EDGE and 850 WCDMA Phone with Bluetooth		Page 7 of 27

5 PROBE CALIBRATION PROCESS

5.1 Dosimetric Assessment Procedure

Each E-Probe/Probe amplifier combination has unique calibration parameters. A TEM cell calibration procedure is conducted to determine the proper amplifier settings to enter in the probe parameters. The amplifier settings are determined for a given frequency by subjecting the probe to a known E-field density (1 mW/cm²) using an RF Signal generator, TEM cell, and RF Power Meter.

5.2 Free Space Assessment

The free space E-field from amplified probe outputs is determined in a test chamber. This calibration can be performed in a TEM cell if the frequency is below 1 GHz and in a waveguide or other methodologies above 1 GHz for free space. For the free space calibration, the probe is placed in the volumetric center of the cavity and at the proper orientation with the field. The probe is rotated 360 degrees until the three channels show the maximum reading. The power density readings equates to 1 mW/cm².

5.3 Temperature Assessment

E-field temperature correlation calibration is performed in a flat phantom filled with the appropriate simulated brain tissue. The E-field in the medium correlates with the temperature rise in the dielectric medium. For temperature correlation calibration a RF transparent thermistor-based temperature probe is used in conjunction with the E-field probe.

$$SAR = C \frac{\Delta T}{\Delta t}$$

where:

- Δt = exposure time (30 seconds),
- C = heat capacity of tissue (brain or muscle),
- ΔT = temperature increase due to RF exposure.

$$SAR = \frac{|E|^2 \cdot \sigma}{\rho}$$

where:

- σ = simulated tissue conductivity,
- ρ = Tissue density (1.25 g/cm³ for brain tissue)

SAR is proportional to $\Delta T/\Delta t$, the initial rate of tissue heating, before thermal diffusion takes place. Now it's possible to quantify the electric field in the simulated tissue by equating the thermally derived SAR to the E- field;



Figure 5-1 E-Field and Temperature measurements at 900MHz [7]

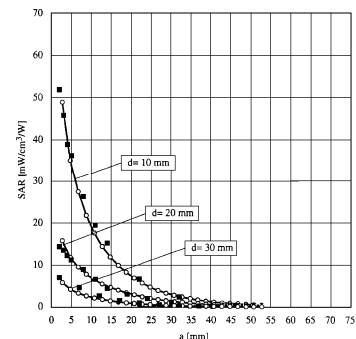



Figure 5-2 E-Field and temperature measurements at 1.9GHz [7]

FCC ID: A3LGT6700T	 PCTEST ENGINEERING LABORATORY, INC.	CERTIFICATION REPORT		Reviewed by: Quality Manager
SAR Filename: 0905040932.A3L	Test Dates: May 04-05, 2009	EUT Type: 850/1900 GSM/GPRS/EDGE and 850 WCDMA Phone with Bluetooth		Page 8 of 27

6 PHANTOM AND EQUIVALENT TISSUES

6.1 SAM Phantoms



Figure 6-1
SAM Phantoms

The SAM Twin Phantom V4.0 is constructed of a fiberglass shell integrated in a wooden table. The shape of the shell is based on data from an anatomical study designed to determine the maximum exposure in at least 90% of all users [11][12]. It enables the dosimetric evaluation of left and right hand phone usage as well as body mounted usage at the flat phantom region. A cover prevents the evaporation of the liquid. Reference markings on the Phantom allow the complete setup of all predefined phantom positions and measurement grids by manually teaching three points in the robot. (see Fig. 5.1)

6.2 Brain & Muscle Simulating Mixture Characterization

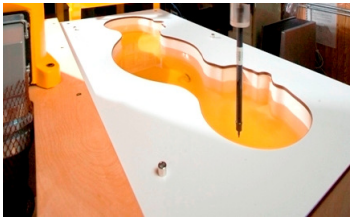

Figure 6-2
Head Simulated

The brain and muscle mixtures consist of a viscous gel using hydroxethylcellulose (HEC) gelling agent and saline solution (see Table 6-1). Preservation with a bactericide is added and visual inspection is made to make sure air bubbles are not trapped during the mixing process. The mixture is calibrated to obtain proper dielectric constant (permittivity) and conductivity of the desired tissue. The head tissue dielectric parameters recommended by the IEEE SCC-34/SC-2 have been incorporated in the following table. Other head and body tissue parameters that have not been specified in IEEE-1528 are derived from the tissue dielectric parameters computed from the 4-Cole-Cole equations. The mixture characterizations used for the brain and muscle tissue simulating liquids are according to the data by C. Gabriel and G. Hartsgrove [13]. (See Table 6-1)

Table 6-1
Composition of the Brain & Muscle Tissue Equivalent Matter

Frequency (MHz)	300			450			835			900			1450			1800				1900		1950		2000		2100		2450		3000	
Recipe #	1	1	3	1	1	2	3	1	1	2	3	1	1	2	2	3	1	2	4	1	1	2	2	3	2	2	3	2			
Ingredients: (% by weight)																															
1,3-Propanediol								64.81																							
Bactericide	0.19	0.19	0.50	0.10	0.10			0.50									0.50												0.50		
Diaceta			48.90					49.20									49.43												49.75		
DGBE								45.41	47.00	13.84	44.92						44.94	13.84	45.00	50.00	50.00	7.99	7.99					7.99			
HEC	0.98	0.98		1.00	1.00																										
NaCl	5.95	3.95	1.70	1.45	1.48	0.79	1.10	0.67	0.36	0.35	0.18	0.64	0.18	0.35												0.16	0.16	0.16			
Sucrose	55.32	56.32		57.00	56.50																										
Triton X-100														30.45						30.45						19.97	19.97		19.97		
Water	37.56	38.56	48.90	40.45	40.92	34.40	49.20	53.80	52.64	55.36	54.90	49.43	54.90	55.36	55.00	50.00	50.00	50.00	50.00	50.00	50.00	50.00	50.00	71.88	71.88	49.75	71.88				
Measured dielectric parameters																															
ϵ'_r	46.00	43.4	44.3	41.6	41.2	41.8	42.7	40.9	39.3	41	40.4	39.2	39.9	41	40.1	37	36.8	41.1	40.3	39.2	37.9										
σ (S/m)	0.86	0.87	0.9	0.9	0.98	0.97	0.99	1.21	1.39	1.38	1.4	1.42	1.38	1.41	1.4	1.51	1.53	1.88	1.82	2.46											
Temp. (°C)	22	22	20	22	22	22	20	22	22	21	22	20	21	20	21	20	22	20	20	20	20										
Target dielectric parameters (Table 2)																															
ϵ'_r	45.30	43.50	41.5	41.50	40.5								40.0				39.80	39.2	38.5												
σ (S/m)	0.87	0.87	0.9	0.97	1.2								1.4				1.49	1.8	2.4												

NOTE—Multiple columns for any single frequency are optional recipes. Recipe # reference: 1 (Kanda et al. [B85]), 2 (Vignosa [B145]), 3 (Peyman and Gabriel [B119]), 4 (Falcovaga et al. [B50]).

*The formulas containing Triton X-100 and corresponding measured parameters are under review and verification.

FCC ID: A3LGTS6700T	PCTEST ENGINEERING LABORATORY, INC.	CERTIFICATION REPORT		Reviewed by: Quality Manager
SAR Filename: 0905040932.A3L	Test Dates: May 04-05, 2009	EUT Type: 850/1900 GSM/GPRS/EDGE and 850 WCDMA Phone with Bluetooth		Page 9 of 27

7.1 Measurement Procedure

The evaluation was performed using the following procedure:

1. The SAR measurement was taken at a selected spatial reference point to monitor power variations during testing. This fixed point was measured and used as a reference value.
2. The SAR distribution at the exposed side of the head was measured at a distance of 3.0mm from the inner surface of the shell. The area covered the entire dimension of the head and the horizontal grid spacing was 15mm x 15mm.
3. Based on the area scan data, the area of the maximum absorption was determined by spline interpolation. Around this point, a volume of 32mm x 32mm x 30mm (fine resolution volume scan, zoom scan) was assessed by measuring 5 x 5 x 7 points. On this basis of this data set, the spatial peak SAR value was evaluated with the following procedure (see Figure 7-1):
 - a. The data at the surface was extrapolated, since the center of the dipoles is 2.7mm away from the tip of the probe and the distance between the surface and the lowest measuring point is 1.2mm. The extrapolation was based on a least square algorithm [15]. A polynomial of the fourth order was calculated through the points in z-axis. This polynomial was then used to evaluate the points between the surface and the probe tip.
 - b. The maximum interpolated value was searched with a straight-forward algorithm. Around this maximum the SAR values averaged over the spatial volumes (1g or 10g) were computed using the 3D-Spline interpolation algorithm. The 3D-spline is composed of three one-dimensional splines with the "Not a knot" condition (in x, y, and z directions) [15][16]. The volume was integrated with the trapezoidal algorithm. One thousand points (10 x 10 x 10) were interpolated to calculate the average.
 - c. All neighboring volumes were evaluated until no neighboring volume with a higher average value was found.
4. The SAR reference value, at the same location as step 1, was re-measured. If the value changed by more than 5%, the evaluation is repeated.

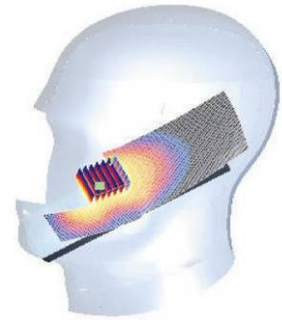



Figure 7-1
Sample SAR Area Scan

7.2 Specific Anthropomorphic Mannequin (SAM) Specifications

The phantom for handset SAR assessment testing is a low-loss dielectric shell, with shape and dimensions derived from the anthropometric data of the 90th percentile adult male head dimensions as tabulated by the US Army. The SAM Twin Phantom shell is bisected along the mid-sagittal plane into right and left halves (see Figure 7-2). The perimeter sidewalls of each phantom halves are extended to allow filling with liquid to a depth that is sufficient to minimized reflections from the upper surface. The liquid depth is maintained at a minimum depth of 15cm to minimize reflections from the upper surface.



Figure 7-2
SAM Twin Phantom Shell

FCC ID: A3LGTS6700T		CERTIFICATION REPORT		Reviewed by: Quality Manager
SAR Filename: 0905040932.A3L	Test Dates: May 04-05, 2009	EUT Type: 850/1900 GSM/GPRS/EDGE and 850 WCDMA Phone with Bluetooth		Page 10 of 27

8.1 EAR REFERENCE POINT

Figure 8-1 shows the front, back and side views of the SAM Twin Phantom. The point “M” is the reference point for the center of the mouth, “LE” is the left ear reference point (ERP), and “RE” is the right ERP. The ERP is 15mm posterior to the entrance to the ear canal (EEC) along the B-M line (Back-Mouth), as shown in Figure 8-1. The plane passing through the two ear canals and M is defined as the Reference Plane. The line N-F (Neck-Front) is perpendicular to the reference plane and passing through the RE (or LE) is called the Reference Pivoting Line (see Figure 8-2). Line B-M is perpendicular to the N-F line. Both N-F and B-M lines are marked on the external phantom shell to facilitate handset positioning [5].

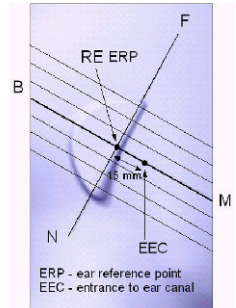

Figure 8-1
Close-Up Side view
of ERP

8.2 HANDSET REFERENCE POINTS

Two imaginary lines on the handset were established: the vertical centerline and the horizontal line. The test device was placed in a normal operating position with the “test device reference point” located along the “vertical centerline” on the front of the device aligned to the “ear reference point” (See Figure 8-3). The “test device reference point” was then located at the same level as the center of the ear reference point. The test device was positioned so that the “vertical centerline” was bisecting the front surface of the handset at its top and bottom edges, positioning the “ear reference point” on the outer surface of the both the left and right head phantoms on the ear reference point.



Figure 8-2
Front, back and side view of SAM Twin Phantom

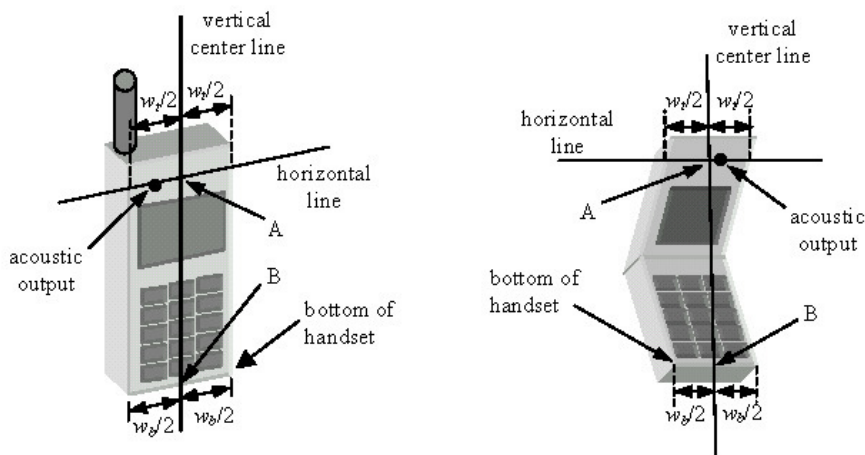



Figure 8-3
Handset Vertical Center & Horizontal Line Reference Points

FCC ID: A3LGT56700T	 PCTEST ENGINEERING LABORATORY, INC.	CERTIFICATION REPORT		Reviewed by: Quality Manager
SAR Filename: 0905040932.A3L	Test Dates: May 04-05, 2009	EUT Type: 850/1900 GSM/GPRS/EDGE and 850 WCDMA Phone with Bluetooth		Page 11 of 27

9

TEST CONFIGURATION POSITIONS

9.1 Positioning for Cheek/Touch

1. The test device was positioned with the handset close to the surface of the phantom such that point A is on the (virtual) extension of the line passing through points RE and LE on the phantom (see Figure 9-1), such that the plane defined by the vertical center line and the horizontal line of the phone is approximately parallel to the sagittal plane of the phantom.

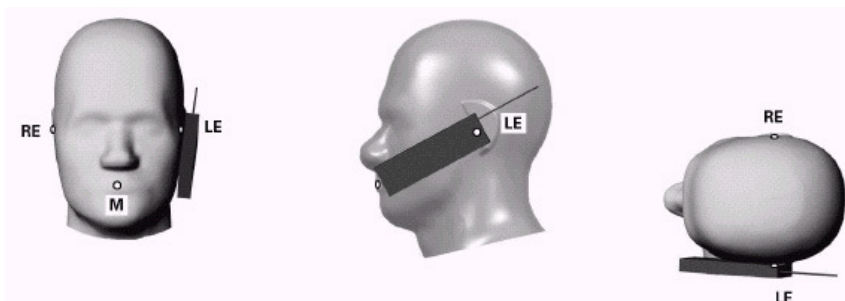



Figure 9-1 Front, Side and Top View of Cheek/Touch Position

2. The handset was translated towards the phantom along the line passing through RE & LE until the handset touches the ear.
3. While maintaining the handset in this plane, the handset was rotated around the LE-RE line until the vertical centerline was in the plane normal to MB-NF including the line MB (reference plane).
4. The phone was then rotated around the vertical centerline until the phone (horizontal line) was symmetrical with respect to the line NF.
5. While maintaining the vertical centerline in the reference plane, keeping point A on the line passing through RE and LE, and maintaining the phone contact with the ear, the handset was rotated about the line NF until any point on the handset made contact with a phantom point below the ear (cheek). See Figure 9-2)

9.2 Positioning for Ear / 15° Tilt

With the test device aligned in the “Cheek/Touch Position”:

1. While maintaining the orientation of the phone, the phone was retracted parallel to the reference plane far enough to enable a rotation of the phone by 15 degree.
2. The phone was then rotated around the horizontal line by 15 degree.
3. While maintaining the orientation of the phone, the phone was moved parallel to the reference plane until any part of the phone touches the head. (In this position, point A was located on the line RE-LE). The tilted position is obtained when the contact is on the pinna. If the contact was at any location other than the pinna, the angle of the phone would then be reduced. The tilted position was obtained when any part of the phone was in contact of the ear as well as a second part of the phone was in contact with the head (see Figure 9-3).

FCC ID: A3LGTS6700T	 PCTEST ENGINEERING LABORATORY, INC.	CERTIFICATION REPORT		Reviewed by: Quality Manager
SAR Filename: 0905040932.A3L	Test Dates: May 04-05, 2009	EUT Type: 850/1900 GSM/GPRS/EDGE and 850 WCDMA Phone with Bluetooth		Page 12 of 27

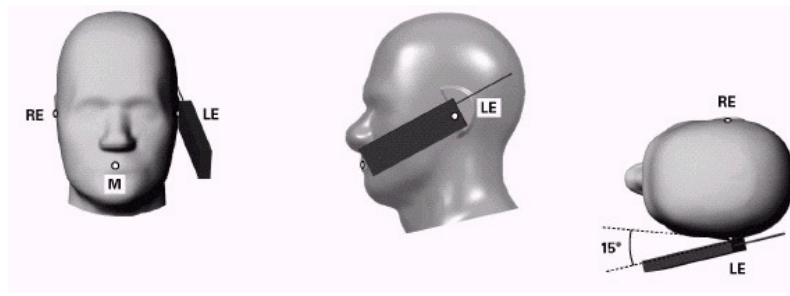

Figure 9-2 Front, Side and Top View of Ear/15° Tilt Position

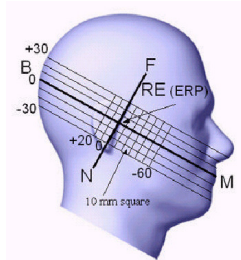

Figure 9-3 Side view w/ relevant markings



Figure 9-4 Body SAR Sample Photo (Not Actual EUT)

9.3 SAR Evaluations near the Mouth/Jaw Regions of the SAM Phantom

Antennas located near the bottom of a phone may require SAR measurements around the mouth and jaw regions of the SAM head phantom. This typically applies to clam-shell style phones that are generally longer in the unfolded normal use positions or to certain older style long rectangular phones. It has been known for some time that there are SAR measurement difficulties in these regions of the SAM phantom. SAR probes are calibrated in tissue equivalent liquids with sufficient separation between the probe sensors and nearby physical boundaries to ensure scattering does not affect probe calibration. When the probe tip is moved into tight regions with multiple boundaries surrounding its sensors, probe calibration and measurement accuracy can become questionable. In addition, these measurement locations often require a probe to be tilted at steep angles, where it may no longer comply with calibration requirements and measurement protocols, or satisfy the required measurement uncertainty. In some situations it is not feasible to tilt the probe or rotate the phantom, as suggested by measurement standards, to conduct these measurements.

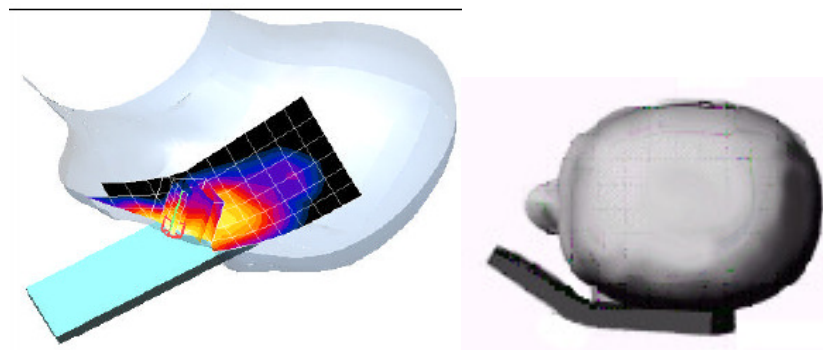



Figure 9-5 SAR Scans near the Jaw/Mouth

In order to ensure there is sufficient conservativeness for ensuring compliance until practical solutions are available, additional measurement considerations are necessary to address these technical difficulties. When measurements are required near the mouth, nose, jaw or similar tight regions of the SAM phantom,

FCC ID: A3LGTS6700T	 PCTEST ENGINEERING LABORATORY, INC.	CERTIFICATION REPORT		Reviewed by: Quality Manager
SAR Filename: 0905040932.A3L	Test Dates: May 04-05, 2009	EUT Type: 850/1900 GSM/GPRS/EDGE and 850 WCDMA Phone with Bluetooth		Page 13 of 27

area or zoom scans are often unable to fully enclose the peak SAR location as required by IEEE 1528 and Supplement C, due to probe orientation and positioning difficulties. Even when limited measurements are possible, the test results could be questionable due to probe calibration and measurement uncertainty issues. Under these circumstances, the following procedures apply, adopted from the FCC guidance on SAR handsets document publication 648474. The SAR required in these regions of SAM should be measured using a flat phantom. **Rectangular shaped phones** should be positioned with its bottom edge positioned from the flat phantom with the same distance provided by the cheek touching position using SAM. The ear reference point (ERP, as defined for SAM) of the phone should be positioned ½ cm from the flat phantom shell. **Clam-shell phones** should be positioned with the hinge against a smooth edge of the flat phantom where the upper half of the phone is unfolded and extended beyond the phantom side wall. The lower half of the phone is secured in the test device holder at a fixed distance below the flat phantom determined by the minimum separation along the lower edge of the phone in the cheek touching position using SAM. Any case with substantial variation in separation distance along the lower edge of a clam shell is discussed with the FCC for best-to-use methodology.

The flat phantom data should allow test results to be compared uniformly across measurement systems, until suitable solutions are available in measurement standards to address certain probe calibration and positioning issues, due to implementation differences between horizontal and upright SAM configurations. These flat phantom procedures are only applicable for stand-alone SAR evaluation in tight regions of the SAM phantom, where measurement is not feasible or test results can be questionable due to probe calibration and accessibility issues. Details on device positioning and photos showing how separation distances are determined are included in the SAR report Photographs. SAR for other regions of the head must be evaluated using SAM; therefore, a phone with antennas at different locations may require flat and SAM phantom evaluation for the different antennas.



9.4 Body Holster /Belt Clip Configurations

Body-worn operating configurations are tested with the belt-clips and holsters attached to the device and positioned against a flat phantom in a normal use configuration (see Figure 9-5). A device with a headset output is tested with a headset connected to the device.

Accessories for Body-worn operation configurations are divided into two categories: those that do not contain metallic components and those that do contain metallic components. When multiple accessories that do not contain metallic components are supplied with the device, the device is tested with only the accessory that dictates the closest spacing to the body. Then multiple accessories that contain metallic components are tested with the device with each accessory. If multiple accessories share an identical metallic component (i.e. the same metallic belt-clip used with different holsters with no other metallic components) only the accessory that dictates the closest spacing to the body is tested.

Body-worn accessories may not always be supplied or available as options for some devices intended to be authorized for body-worn use. In this case, a test configuration with a separation distance between the back of the device and the flat phantom is used. Test position spacing was documented. Transmitters that are designed to operate in front of a person’s face, as in push-to-talk configurations, are tested for SAR compliance with the front of the device positioned to face the flat phantom in brain fluid. For devices that are carried next to the body such as a shoulder, waist or chest-worn transmitters, SAR compliance is tested with the accessories, including headsets and microphones, attached to the device and positioned against a flat phantom in a normal use configuration.

In all cases SAR measurements are performed to investigate the worst-case positioning. Worst-case positioning is then documented and used to perform Body SAR testing.

FCC ID: A3LGT6700T	 PCTEST ENGINEERING LABORATORY, INC.	CERTIFICATION REPORT		Reviewed by: Quality Manager
SAR Filename: 0905040932.A3L	Test Dates: May 04-05, 2009	EUT Type: 850/1900 GSM/GPRS/EDGE and 850 WCDMA Phone with Bluetooth		Page 14 of 27

10 ANSI/IEEE C95.1-2005 RF EXPOSURE LIMITS

10.1 Uncontrolled Environment

UNCONTROLLED ENVIRONMENTS are defined as locations where there is the exposure of individuals who have no knowledge or control of their exposure. The general population/uncontrolled exposure limits are applicable to situations in which the general public may be exposed or in which persons who are exposed as a consequence of their employment may not be made fully aware of the potential for exposure or cannot exercise control over their exposure. Members of the general public would come under this category when exposure is not employment-related; for example, in the case of a wireless transmitter that exposes persons in its vicinity.



10.2 Controlled Environment

CONTROLLED ENVIRONMENTS are defined as locations where there is exposure that may be incurred by persons who are aware of the potential for exposure, (i.e. as a result of employment or occupation). In general, occupational/controlled exposure limits are applicable to situations in which persons are exposed as a consequence of their employment, who have been made fully aware of the potential for exposure and can exercise control over their exposure. This exposure category is also applicable when the exposure is of a transient nature due to incidental passage through a location where the exposure levels may be higher than the general population/uncontrolled limits, but the exposed person is fully aware of the potential for exposure and can exercise control over his or her exposure by leaving the area or by some other appropriate means.

Table 10-1
SAR Human Exposure Specified in ANSI/IEEE C95.1-2005 and Health Canada Safety Code 6

HUMAN EXPOSURE LIMITS		
	UNCONTROLLED ENVIRONMENT <i>General Population</i> (W/kg) or (mW/g)	CONTROLLED ENVIRONMENT <i>Occupational</i> (W/kg) or (mW/g)
SPATIAL PEAK SAR Brain	1.6	8.0
SPATIAL AVERAGE SAR Whole Body	0.08	0.4
SPATIAL PEAK SAR Hands, Feet, Ankles, Wrists	4.0	20



- 1 The Spatial Peak value of the SAR averaged over any 1 gram of tissue (defined as a tissue volume in the shape of a cube) and over the appropriate averaging time.
- 2 The Spatial Average value of the SAR averaged over the whole body.
- 3 The Spatial Peak value of the SAR averaged over any 10 grams of tissue (defined as a tissue volume in the shape of a cube) and over the appropriate averaging time.

FCC ID: A3LGT6700T	 PCTEST ENGINEERING LABORATORY, INC.	CERTIFICATION REPORT		Reviewed by: Quality Manager
SAR Filename: 0905040932.A3L	Test Dates: May 04-05, 2009	EUT Type: 850/1900 GSM/GPRS/EDGE and 850 WCDMA Phone with Bluetooth		Page 15 of 27

11 MEASUREMENT UNCERTAINTIES

a	b	c	d	e= f(d,k)	f	g	h = c x f/e	i = c x g/e	k
Uncertainty Component	IEEE 1528 Sec.	Tol. (± %)	Prob. Dist.	Div.	c _i 1gm	c _i 10 gms	1gm u _i (± %)	10gms u _i (± %)	v _i
Measurement System									
Probe Calibration	E.2.1	6.6	N	1	1.0	1.0	6.6	6.6	∞
Axial Isotropy	E.2.2	0.25	N	1	0.7	0.7	0.2	0.2	∞
Hemishperical Isotropy	E.2.2	1.3	N	1	1.0	1.0	1.3	1.3	∞
Boundary Effect	E.2.3	0.4	N	1	1.0	1.0	0.4	0.4	∞
Linearity	E.2.4	0.3	N	1	1.0	1.0	0.3	0.3	∞
System Detection Limits	E.2.5	5.1	N	1	1.0	1.0	5.1	5.1	∞
Readout Electronics	E.2.6	1.0	N	1	1.0	1.0	1.0	1.0	∞
Response Time	E.2.7	0.8	R	1.73	1.0	1.0	0.5	0.5	∞
Integration Time	E.2.8	2.6	R	1.73	1.0	1.0	1.5	1.5	∞
RF Ambient Conditions	E.6.1	3.0	R	1.73	1.0	1.0	1.7	1.7	∞
Probe Positioner Mechanical Tolerance	E.6.2	0.4	R	1.73	1.0	1.0	0.2	0.2	∞
Probe Positioning w/ respect to Phantom	E.6.3	2.9	R	1.73	1.0	1.0	1.7	1.7	∞
Extrapolation, Interpolation & Integration algorithms for Max. SAR Evaluation	E.5	1.0	R	1.73	1.0	1.0	0.6	0.6	∞
Test Sample Related									
Test Sample Positioning	E.4.2	6.0	N	1	1.0	1.0	6.0	6.0	287
Device Holder Uncertainty	E.4.1	3.32	R	1.73	1.0	1.0	1.9	1.9	∞
Output Power Variation - SAR drift measurement	6.6.2	5.0	R	1.73	1.0	1.0	2.9	2.9	∞
Phantom & Tissue Parameters									
Phantom Uncertainty (Shape & Thickness tolerances)	E.3.1	4.0	R	1.73	1.0	1.0	2.3	2.3	∞
Liquid Conductivity - deviation from target values	E.3.2	5.0	R	1.73	0.64	0.43	1.8	1.2	∞
Liquid Conductivity - measurement uncertainty	E.3.3	3.8	N	1	0.64	0.43	2.4	1.6	6
Liquid Permittivity - deviation from target values	E.3.2	5.0	R	1.73	0.60	0.49	1.7	1.4	∞
Liquid Permittivity - measurement uncertainty	E.3.3	4.5	N	1	0.60	0.49	2.7	2.2	6
Combined Standard Uncertainty (k=1)				RSS			12.4	12.0	299
Expanded Uncertainty (95% CONFIDENCE LEVEL)				k=2			24.7	24.0	

The above measurement uncertainties are according to IEEE Std. 1528-2003

FCC ID: A3LGT6700T	 PCTEST ENGINEERING LABORATORY, INC.	CERTIFICATION REPORT		Reviewed by: Quality Manager
SAR Filename: 0905040932.A3L	Test Dates: May 04-05, 2009	EUT Type: 850/1900 GSM/GPRS/EDGE and 850 WCDMA Phone with Bluetooth		Page 16 of 27

12 SYSTEM VERIFICATION

12.1 Tissue Verification

**Table 12-1
Measured Tissue Properties**

Calibrated Date:	05/04/2009		05/04/2009		05/04/2009		05/04/2009	
	835H		835M		1900H		1900M	
	Target	Measured	Target	Measured	Target	Measured	Target	Measured
Dielectric Constant	41.50	39.90	55.20	55.30	40.00	40.84	53.30	54.04
Conductivity	0.90	0.87	0.97	1.00	1.40	1.37	1.52	1.51

12.2 Test System Verification

Prior to assessment, the system is verified to $\pm 10\%$ of the specifications at 835 and 1900 MHz by using the system validation kit(s). (Graphic Plots Attached)

**Table 12-2
System Verification Results**

System Verification TARGET & MEASURED							
Date:	Amb. Temp (°C)	Liquid Temp (°C)	Input Power (W)	Tissue Frequency (MHz)	Targeted SAR _{1g} (mW)	Measured SAR _{1g} (mW)	Deviation (%)
05/04/2009	24.6	22.7	0.100	835	0.90	0.928	3.00%
05/05/2009	24.3	22.5	0.100	1900	3.99	4.17	4.51%

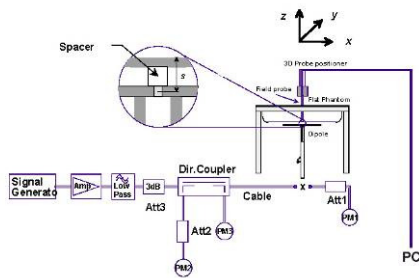

**Figure 12-1
System Verification Setup Diagram**



**Figure 12-2
System Verification Setup Photo**

FCC ID: A3LGT6700T	PCTEST ENGINEERING LABORATORY, INC.	CERTIFICATION REPORT		Reviewed by: Quality Manager
SAR Filename: 0905040932.A3L	Test Dates: May 04-05, 2009	EUT Type: 850/1900 GSM/GPRS/EDGE and 850 WCDMA Phone with Bluetooth		Page 17 of 27

13 FCC MULTI-TX AND ANTENNA SAR CONSIDERATIONS

13.1 Introduction

The following procedures adopted from “FCC SAR Considerations for Cell Phones with Multiple Transmitters” v01r03 from May 2008 are applicable to handsets with built-in unlicensed transmitters such as 802.11a/b/g and Bluetooth devices which may simultaneously transmit with the licensed transmitter.

13.2 FCC Power Tables & Conditions

	2.45	5.15 - 5.35	5.47 - 5.85	GHz
P_{Ref}	12	6	5	mW
Device output power should be rounded to the nearest mW to compare with values specified in this table.				

Figure 13-1
Output Power Thresholds for Unlicensed Transmitters

	Individual Transmitter	Simultaneous Transmission
Licensed Transmitters	Routine evaluation required	SAR not required:
Unlicensed Transmitters	<p><u>When there is no simultaneous transmission –</u></p> <ul style="list-style-type: none"> output ≤ 60/f: SAR not required output > 60/f: stand-alone SAR required <p><u>When there is simultaneous transmission –</u></p> <p><u>Stand-alone SAR not required when</u></p> <ul style="list-style-type: none"> output $\leq 2 \cdot P_{Ref}$ and antenna is ≥ 5.0 cm from other antennas output $\leq P_{Ref}$ and antenna is ≥ 2.5 cm from other antennas output $\leq P_{Ref}$ and antenna is < 2.5 cm from other antennas, each with either output power $\leq P_{Ref}$ or 1-g SAR < 1.2 W/kg <p><u>Otherwise stand-alone SAR is required</u></p> <p><u>When stand-alone SAR is required</u></p> <ul style="list-style-type: none"> test SAR on highest output channel for each wireless mode and exposure condition if SAR for highest output channel is $> 50\%$ of SAR limit, evaluate all channels according to normal procedures 	<p>Unlicensed only</p> <ul style="list-style-type: none"> when stand-alone 1-g SAR is not required and antenna is ≥ 5 cm from other antennas <p>Licensed & Unlicensed</p> <ul style="list-style-type: none"> when the sum of the 1-g SAR is < 1.6 W/kg for all simultaneous transmitting antennas when SAR to peak location separation ratio of simultaneous transmitting antenna pair is < 0.3 <p>SAR required:</p> <p>Licensed & Unlicensed</p> <p>antenna pairs with SAR to peak location separation ratio ≥ 0.3; test is only required for the configuration that results in the highest SAR in stand-alone configuration for each wireless mode and exposure condition</p> <p>Note: simultaneous transmission exposure conditions for head and body can be different for different style phones; therefore, different test requirements may apply</p>

Figure 13-2
SAR Evaluation Requirements for Multiple Transmitter Handsets



13.3 Multiple Antenna/Transmission Information for GT-S6700T

For FCC ID: A3LGTS6700T

Separation Distance of Antennas is 0.8 cm
RF Conducted Power of Secondary Tx is 4.864 mW

13.4 Conclusion

Based on the output power, antenna separation distance, and Body SAR of the dominant transmitter, a stand-alone BT SAR test is not required. The summation of BT SAR and Licensed Transmitter SAR is $0.989 + 0 = 0.989$, which is less than 1.6 W/kg therefore, a simultaneous SAR evaluation is not required.

FCC ID: A3LGTS6700T	 PCTEST ENGINEERING LABORATORY, INC.	CERTIFICATION REPORT		Reviewed by: Quality Manager
SAR Filename: 0905040932.A3L	Test Dates: May 04-05, 2009	EUT Type: 850/1900 GSM/GPRS/EDGE and 850 WCDMA Phone with Bluetooth		Page 18 of 27

14 FCC 3G MEASUREMENT PROCEDURES

Power measurements were performed using a base station simulator under digital average power.

14.1 Procedures Used to Establish RF Signal for SAR

The handset was placed into a simulated call using a base station simulator in a shielded chamber. Such test signals offer a consistent means for testing SAR and are recommended for evaluating SAR [4]. SAR measurements were taken with a fully charged battery. In order to verify that the device was tested and maintained at full power, this was configured with the base station simulator. The SAR measurement software calculates a reference point at the start and end of the test to check for power drifts. If conducted power deviations of more than 5% occurred, the tests were repeated.

14.2 SAR Measurement Conditions for UMTS

14.2.1 Output Power Verification

Maximum output power is verified on the High, Middle and Low channels according to the general descriptions in section 5.2 of 3GPP TS 34.121, using the appropriate RMC or AMR with TPC (transmit power control) set to all "1s".

14.2.2 Head SAR Measurements

SAR for head exposure configurations is measured using the 12.2 kbps RMC with TPC bits configured to all "1s". SAR in AMR configurations is not required when the maximum average output of each RF channel for 12.2 kbps AMR is less than ¼ dB higher than that measured in 12.2 kbps RMC. Otherwise, SAR is measured on the maximum output channel in 12.2 AMR with a 3.4 kbps SRB (signaling radio bearer) using the exposure configuration that results in the highest SAR for that RF channel in 12.2 RMC.

14.2.3 Body SAR Measurements



SAR for body exposure configurations is measured using the 12.2 kbps RMC with the TPC bits all "1s".

14.2.4 Handsets with HSDPA

Body SAR is not required for handsets with HSDPA capabilities when the maximum average output of each RF channel with HSDPA active is less than ¼ dB higher than that measured without HSDPA using 12.2 kbps RMC and the maximum SAR for 12.2 kbps RMC is ≤ 75% of the SAR limit. Otherwise, SAR is measured for HSDPA, using an FRC with H-Set 1 in Sub-test 1 and a 12.2 kbps RMC configured in Test Loop Mode 1, using the highest body SAR configuration in 12.2 kbps RMC without HSDPA, on the maximum output channel with the body exposure configuration that results in the highest SAR in 12.2 kbps RMC for that RF channel.

Table 14-1 Conducted Power for GT-S6700T

		RF Conducted Power Table									UMTS RF Conducted Power Table					
		Voice	GPRS Data				EDGE Data						HSDPA Inactive		HSDPA Active	
Band	Channel	GSM [dBm]	GPRS [dBm] 1 Tx Slot	GPRS [dBm] 2 Tx Slot	GPRS [dBm] 3 Tx Slot	GPRS [dBm] 4 Tx Slot	EDGE [dBm] 1 Tx Slot	EDGE [dBm] 2 Tx Slot	EDGE [dBm] 3 Tx Slot	EDGE [dBm] 4 Tx Slot	Band	Channel	12.2 kbps RMC [dBm]	12.2 kbps AMR [dBm]	12.2 kbps RMC [dBm]	12.2 kbps AMR [dBm]
Cellular	128	32.39	32.25	31.85	28.46	27.17	26.97	24.92	22.54	21.22	Cellular	4132	23.42	23.34	23.39	23.36
	190	32.40	32.27	31.87	28.44	27.16	26.98	24.86	22.48	21.29		4183	22.87	22.79	22.85	22.82
	251	32.50	32.41	31.94	28.54	27.23	27.07	24.95	22.53	21.40		4233	22.74	22.68	22.77	22.73
PCS	512	29.69	29.64	29.12	25.78	24.42	26.39	24.74	20.82	19.64	PCS	9262	na	na	na	na
	661	29.78	29.76	29.24	25.92	24.55	26.38	24.83	20.94	19.75		9400	na	na	na	na
	810	29.74	29.71	29.22	25.88	24.47	26.41	24.88	20.91	19.73		9538	na	na	na	na

FCC ID: A3LGT56700T	 PCTEST ENGINEERING LABORATORY, INC.	CERTIFICATION REPORT		Reviewed by: Quality Manager
SAR Filename: 0905040932.A3L	Test Dates: May 04-05, 2009	EUT Type: 850/1900 GSM/GPRS/EDGE and 850 WCDMA Phone with Bluetooth		Page 19 of 27



15 SAR DATA SUMMARY

15.1 GSM850 Head SAR Results

MEASUREMENT RESULTS									
FREQUENCY		Mode	C_Power[dBm]		Side	Test Position	Slider	Battery	SAR
MHz	Ch.		Start	End					(W/kg)
836.60	190	GSM	32.40	32.41	Right	Touch	In	Standard	0.440
836.60	190	GSM	32.40	32.46	Right	Tilt	In	Standard	0.204
836.60	190	GSM	32.40	32.54	Left	Touch	In	Standard	0.375
836.60	190	GSM	32.40	32.49	Left	Tilt	In	Standard	0.185
836.60	190	GSM	32.40	32.59	Right	Touch	Out	Standard	0.395
836.60	190	GSM	32.40	32.39	Right	Tilt	Out	Standard	0.203
836.60	190	GSM	32.40	32.33	Left	Touch	Out	Standard	0.434
836.60	190	GSM	32.40	32.38	Left	Tilt	Out	Standard	0.227
ANSI / IEEE C95.1 2005 - SAFETY LIMIT						Brain			
Spatial Peak						1.6 W/kg (mW/g)			
Uncontrolled Exposure/General Population						averaged over 1 gram			

Notes:

1. The test data reported are the worst-case SAR value with the position set in a typical configuration. Test procedures used are according to FCC/OET Bulletin 65, Supplement C [July 2001].
2. All modes of operation were investigated, and worst-case results are reported.
3. Batteries are fully charged for all readings. Standard batteries were investigated.
4. Tissue parameters and temperatures are listed on the SAR plots.
5. Liquid tissue depth is 15.1 cm. \pm 0.1.
6. Justification for reduced test configurations: Per FCC/OET Bulletin 65 Supplement C (July, 2001) and Public Notice DA-02-1438, if the SAR measured at the middle channel for each test configuration (left, right, cheek/touch, tilt/ear, extended and retracted) is at least 3.0 dB lower than the SAR limit, testing at the high and low channels is optional for such test configuration(s).



FCC ID: A3LGTS6700T	 PCTEST ENGINEERING LABORATORY, INC.	CERTIFICATION REPORT		Reviewed by: Quality Manager
SAR Filename: 0905040932.A3L	Test Dates: May 04-05, 2009	EUT Type: 850/1900 GSM/GPRS/EDGE and 850 WCDMA Phone with Bluetooth		Page 20 of 27

15.2 GSM PCS Head SAR Results

MEASUREMENT RESULTS									
FREQUENCY		Mode	C_Power[dBm]		Side	Test Position	Slider	Battery	SAR
MHz	Ch.		Start	End					(W/kg)
1880.00	661	PCS	29.78	29.80	Right	Touch	In	Standard	0.095
1880.00	661	PCS	29.78	29.93	Right	Tilt	In	Standard	0.074
1880.00	661	PCS	29.78	29.69	Left	Touch	In	Standard	0.135
1880.00	661	PCS	29.78	29.64	Left	Tilt	In	Standard	0.058
1880.00	661	PCS	29.78	29.94	Right	Touch	Out	Standard	0.071
1880.00	661	PCS	29.78	29.69	Right	Tilt	Out	Standard	0.053
1880.00	661	PCS	29.78	29.87	Left	Touch	Out	Standard	0.088
1880.00	661	PCS	29.78	29.67	Left	Tilt	Out	Standard	0.043
ANSI / IEEE C95.1 2005 - SAFETY LIMIT Spatial Peak Uncontrolled Exposure/General Population						Brain 1.6 W/kg (mW/g) averaged over 1 gram			

Notes:

1. The test data reported are the worst-case SAR value with the position set in a typical configuration. Test procedures used are according to FCC/OET Bulletin 65, Supplement C [July 2001].
2. All modes of operation were investigated, and worst-case results are reported.
3. Batteries are fully charged for all readings. Standard batteries were investigated.
4. Tissue parameters and temperatures are listed on the SAR plots.
5. Liquid tissue depth is 15.1 cm. \pm 0.1.
6. Justification for reduced test configurations: Per FCC/OET Bulletin 65 Supplement C (July, 2001) and Public Notice DA-02-1438, if the SAR measured at the middle channel for each test configuration (left, right, cheek/touch, tilt/ear, extended and retracted) is at least 3.0 dB lower than the SAR limit, testing at the high and low channels is optional for such test configuration(s).



FCC ID: A3LGTS6700T	 PCTEST ENGINEERING LABORATORY, INC.	CERTIFICATION REPORT		Reviewed by: Quality Manager
SAR Filename: 0905040932.A3L	Test Dates: May 04-05, 2009	EUT Type: 850/1900 GSM/GPRS/EDGE and 850 WCDMA Phone with Bluetooth		Page 21 of 27

15.3 WCDMA Band V (Cellular) Head SAR Results

MEASUREMENT RESULTS									
FREQUENCY		Mode	C_Power[dBm]		Side	Test Position	Slider	Battery	SAR
MHz	Ch.		Start	End					(W/kg)
836.60	4183	WCDMA	22.87	22.88	Right	Touch	In	Standard	0.315
836.60	4183	WCDMA	22.87	22.99	Right	Tilt	In	Standard	0.131
836.60	4183	WCDMA	22.87	23.02	Left	Touch	In	Standard	0.264
836.60	4183	WCDMA	22.87	23.03	Left	Tilt	In	Standard	0.127
836.60	4183	WCDMA	22.87	23.03	Right	Touch	Out	Standard	0.255
836.60	4183	WCDMA	22.87	23.01	Right	Tilt	Out	Standard	0.144
836.60	4183	WCDMA	22.87	23.01	Left	Touch	Out	Standard	0.284
836.60	4183	WCDMA	22.87	22.80	Left	Tilt	Out	Standard	0.153
ANSI / IEEE C95.1 2005 - SAFETY LIMIT Spatial Peak Uncontrolled Exposure/General Population						Brain 1.6 W/kg (mW/g) averaged over 1 gram			

Notes:

1. The test data reported are the worst-case SAR value with the position set in a typical configuration. Test procedures used are according to FCC/OET Bulletin 65, Supplement C [July 2001].
2. All modes of operation were investigated, and worst-case results are reported.
3. Batteries are fully charged for all readings. Standard batteries were investigated.
4. Tissue parameters and temperatures are listed on the SAR plots.
5. Liquid tissue depth is 15.1 cm. ± 0.1.
6. Justification for reduced test configurations: Per FCC/OET Bulletin 65 Supplement C (July, 2001) and Public Notice DA-02-1438, if the SAR measured at the middle channel for each test configuration (left, right, cheek/touch, tilt/ear, extended and retracted) is at least 3.0 dB lower than the SAR limit, testing at the high and low channels is optional for such test configuration(s).
7. WCDMA mode was tested under RMC 12.2kbps and HSDPA Inactive

FCC ID: A3LGTS6700T	 PCTEST ENGINEERING LABORATORY, INC.	CERTIFICATION REPORT		Reviewed by: Quality Manager
SAR Filename: 0905040932.A3L	Test Dates: May 04-05, 2009	EUT Type: 850/1900 GSM/GPRS/EDGE and 850 WCDMA Phone with Bluetooth		Page 22 of 27

15.4 Body SAR Results

15.4.1 GSM Mode



MEASUREMENT RESULTS											
FREQUENCY		Mode	C_Power[dBm]		Position	Service	Spacing	Battery	Slots	Side	SAR
MHz	Ch.		Start	End							(W/kg)
824.20	128	GSM850	31.85	31.78	Body	GPRS	1.5 cm	Standard	2	back	0.989
836.60	190		31.87	31.89	Body	GPRS	1.5 cm	Standard	2	back	0.981
848.80	251		31.94	31.94	Body	GPRS	1.5 cm	Standard	2	back	0.838
824.20	128		32.25	32.18	Body	GPRS	1.5 cm	Standard	1	back	0.493
824.20	128		28.46	28.47	Body	GPRS	1.5 cm	Standard	3	back	0.649
824.20	128		27.17	27.08	Body	GPRS	1.5 cm	Standard	4	back	0.652
836.60	190		31.87	31.70	Body	GPRS	1.5 cm	Standard	2	Front	0.399
1880.00	661	GSM1900	29.24	29.35	Body	GPRS	1.5 cm	Standard	2	back	0.471
1880.00	661		29.76	29.90	Body	GPRS	1.5 cm	Standard	1	back	0.257
1880.00	661		25.92	26.11	Body	GPRS	1.5 cm	Standard	3	back	0.338
1880.00	661		24.55	24.70	Body	GPRS	1.5 cm	Standard	4	back	0.331
1880.00	661		29.24	29.39	Body	GPRS	1.5 cm	Standard	2	Front	0.193
ANSI / IEEE C95.1 2005 - SAFETY LIMIT Spatial Peak Uncontrolled Exposure/General Population							Muscle 1.6 W/kg (mW/g) averaged over 1 gram				

15.4.2 WCDMA Mode

MEASUREMENT RESULTS											
FREQUENCY		Mode	C_Power[dBm]		Position	Service	Spacing	Battery	Side	SAR	
MHz	Ch.		Start	End						(W/kg)	
836.60	4183	WCDMA	22.87	22.93	Body	RMC	1.5 cm	Standard	back	0.432	
836.60	4183	WCDMA	22.87	22.98	Body	RMC	1.5 cm	Standard	front	0.156	
ANSI / IEEE C95.1 2005 - SAFETY LIMIT Spatial Peak Uncontrolled Exposure/General Population							Muscle 1.6 W/kg (mW/g) averaged over 1 gram				

Notes:

- The test data reported are the worst-case SAR value with the position set in a typical configuration. Test procedures used are according to FCC/OET Bulletin 65, Supplement C [July 2001].
- All modes of operation were investigated, and worst-case results are reported.
- Batteries are fully charged for all readings. Standard batteries were investigated.
- Tissue parameters and temperatures are listed on the SAR plots.
- Both sides of the phone were tested, and the worst-case is reported.
- Liquid tissue depth is 15.1 cm. \pm 0.1.
- Device was tested using a fixed spacing.
- WCDMA mode was tested under RMC 12.2 kbps and HSPDA Inactive
- EDGE mode time-average power is more than 3dB lower than the time-average power in GPRS mode; therefore only GPRS mode (worst case) is reported.



FCC ID: A3LGT56700T	 PCTEST ENGINEERING LABORATORY, INC.	CERTIFICATION REPORT		Reviewed by: Quality Manager
SAR Filename: 0905040932.A3L	Test Dates: May 04-05, 2009	EUT Type: 850/1900 GSM/GPRS/EDGE and 850 WCDMA Phone with Bluetooth	Page 23 of 27	

16 EQUIPMENT LIST

Manufacturer	Model	Description	Cal Date	Cal Interval	Cal Due	Serial Number
Agilent	8648D	(9kHz-4GHz) Signal Generator	10/11/2007	Biennial	10/11/2009	3613A00315
Agilent	8753E	(30kHz-6GHz) Network Analyzer	3/25/2009	Annual	3/25/2010	JP38020182
Agilent	E5515C	Wireless Communications Test Set	6/8/2007	Biennial	6/8/2009	GB46110872
Agilent	E5515C	Wireless Communications Test Set	6/8/2007	Biennial	6/8/2009	GB46310798
Agilent	E5515C	Wireless Communications Test Set	9/10/2008	Biennial	9/10/2010	GB41450275
Agilent	E6651A	Mobile WiMAX Tester	8/23/2007	Biennial	8/23/2009	MY47310109
Agilent	E8257D	(250kHz-20GHz) Signal Generator	3/25/2009	Biennial	3/25/2011	MY45470194
Gigatronics	80701A	(0.05-18GHz) Power Sensor	8/18/2008	Annual	8/18/2009	1833460
Gigatronics	8651A	Universal Power Meter	8/18/2008	Annual	8/18/2009	8650319
Index SAR	IXTL-010	Dielectric Measurement Kit	N/A		N/A	N/A
Index SAR	IXTL-030	30MM TEM line for 6 GHz	N/A		N/A	N/A
Rohde & Schwarz	CMU200	Base Station Simulator	5/29/2008	Annual	5/29/2009	836371/0079
Rohde & Schwarz	CMU200	Base Station Simulator	7/23/2008	Annual	7/23/2009	109892
Rohde & Schwarz	NRVD	Dual Channel Power Meter	8/20/2008	Biennial	8/20/2010	101695
Rohde & Schwarz	NRVS	Single Channel Power Meter	7/3/2007	Biennial	7/3/2009	835360/0079
Rohde & Schwarz	NRV-Z32	Peak Power Sensor (100uW-2W)	12/5/2008	Biennial	12/5/2010	100155
Rohde & Schwarz	NRV-Z33	Peak Power Sensor (1mW-20W)	12/5/2008	Biennial	12/5/2010	100004
Rohde & Schwarz	NRV-Z53	Power Sensor	7/3/2007	Biennial	7/3/2009	846076/0007
SPEAG	D1450V2	1450 MHz SAR Dipole	6/11/2007	Biennial	6/11/2009	1025
SPEAG	D1765V2	1765 MHz SAR Dipole	6/11/2007	Biennial	6/11/2009	1008
SPEAG	D1900V2	1900 MHz SAR Dipole	1/20/2009	Biennial	1/20/2011	502
SPEAG	D2300V2	2300 MHz SAR Dipole	3/6/2008	Biennial	3/6/2010	1008
SPEAG	D2450V2	2450 MHz SAR Dipole	9/26/2007	Biennial	9/26/2009	719
SPEAG	D2450V2	2450 MHz SAR Dipole	1/8/2009	Biennial	1/8/2011	797
SPEAG	D2600V2	2600 MHz SAR Dipole	1/30/2008	Biennial	1/30/2010	1004
SPEAG	D5GHzV2	5 GHz SAR Dipole	9/25/2007	Biennial	9/25/2009	1007
SPEAG	D5GHzV2	5 GHz SAR Dipole	1/15/2009	Biennial	1/15/2011	1057
SPEAG	D835V2	835 MHz SAR Dipole	1/19/2009	Biennial	1/19/2011	4d047
SPEAG	D835V2	835 MHz SAR Dipole	8/27/2007	Biennial	8/27/2009	4d026
SPEAG	DAE3	Dasy Data Acquisition Electronics	10/17/2008	Annual	10/17/2009	455
SPEAG	DAE4	Dasy Data Acquisition Electronics	6/26/2008	Annual	6/26/2009	704
SPEAG	DAE4	Dasy Data Acquisition Electronics	8/25/2008	Annual	8/25/2009	665
SPEAG	DAE4	Dasy Data Acquisition Electronics	1/21/2009	Annual	1/21/2010	649
SPEAG	ES3DV2	SAR Probe	10/21/2008	Annual	10/21/2009	3022
SPEAG	EX3DV4	SAR Probe	6/26/2008	Annual	6/26/2009	3589
SPEAG	EX3DV4	SAR Probe	8/26/2008	Annual	8/26/2009	3561
SPEAG	EX3DV4	SAR Probe	1/21/2009	Annual	1/21/2010	3550
SPEAG	DAE4	Dasy Data Acquisition Electronics	7/30/2008	Annual	7/30/2009	859
Rohde & Schwarz	CMU200	Base Station Simulator	3/11/2009	Annual	3/11/2010	836536/0005
Speag	ES3DV3	SAR Probe	4/15/2009	Annual	4/15/2010	3213
Speag	ES3DV3	SAR Probe	4/15/2009	Annual	4/15/2010	3209

Notes:

The E-field probe was calibrated by SPEAG, by the waveguide technique procedure. Dipole Validation measurement is performed by PCTEST prior to SAR evaluation. The brain simulating material is calibrated by PCTEST using the dielectric probe system and network analyzer to determine the conductivity and permittivity (dielectric constant) of the brain-equivalent material.



FCC ID: A3LGT56700T	 PCTEST ENGINEERING LABORATORY, INC.	CERTIFICATION REPORT		Reviewed by: Quality Manager
SAR Filename: 0905040932.A3L	Test Dates: May 04-05, 2009	EUT Type: 850/1900 GSM/GPRS/EDGE and 850 WCDMA Phone with Bluetooth		Page 24 of 27

17 CONCLUSION

17.1 Measurement Conclusion



The SAR evaluation indicates that the EUT complies with the RF radiation exposure limits of the FCC, with respect to all parameters subject to this test. These measurements were taken to simulate the RF effects of RF exposure under worst-case conditions. Precise laboratory measures were taken to assure repeatability of the tests. The results and statements relate only to the item(s) tested.

Please note that the absorption and distribution of electromagnetic energy in the body are very complex phenomena that depend on the mass, shape, and size of the body, the orientation of the body with respect to the field vectors, and the electrical properties of both the body and the environment. Other variables that may play a substantial role in possible biological effects are those that characterize the environment (e.g. ambient temperature, air velocity, relative humidity, and body insulation) and those that characterize the individual (e.g. age, gender, activity level, debilitation, or disease). Because various factors may interact with one another to vary the specific biological outcome of an exposure to electromagnetic fields, any protection guide should consider maximal amplification of biological effects as a result of field-body interactions, environmental conditions, and physiological variables. [3]



FCC ID: A3LGTS6700T		CERTIFICATION REPORT		Reviewed by: Quality Manager
SAR Filename: 0905040932.A3L	Test Dates: May 04-05, 2009	EUT Type: 850/1900 GSM/GPRS/EDGE and 850 WCDMA Phone with Bluetooth	Page 25 of 27	

18 REFERENCES

- [1] Federal Communications Commission, ET Docket 93-62, Guidelines for Evaluating the Environmental Effects of Radiofrequency Radiation, Aug. 1996.
- [2] ANSI/IEEE C95.1-2005, American National Standard safety levels with respect to human exposure to radio frequency electromagnetic fields, 300kHz to 100GHz, New York: IEEE, April 2006.
- [3] ANSI/IEEE C95.3-2002, IEEE Recommended Practice for the Measurement of Potentially Hazardous Electromagnetic Fields - RF and Microwave, New York: IEEE, December 2002.
- [4] Federal Communications Commission, OET Bulletin 65 (Edition 97-01), Supplement C (Edition 01-01), Evaluating Compliance with FCC Guidelines for Human Exposure to Radiofrequency Electromagnetic Fields, July 2001.
- [5] IEEE Standards Coordinating Committee 34 – IEEE Std. 1528-2003, Recommended Practice for Determining the Peak Spatial-Average Specific Absorption Rate (SAR) in the Human Body Due to Wireless Communications Devices.
- [6] NCRP, National Council on Radiation Protection and Measurements, Biological Effects and Exposure Criteria for RadioFrequency Electromagnetic Fields, NCRP Report No. 86, 1986. Reprinted Feb. 1995.
- [7] T. Schmid, O. Egger, N. Kuster, Automated E-field scanning system for dosimetric assessments, IEEE Transaction on Microwave Theory and Techniques, vol. 44, Jan. 1996, pp. 105-113.
- [8] K. Pokovic, T. Schmid, N. Kuster, Robust setup for precise calibration of E-field probes in tissue simulating liquids at mobile communications frequencies, ICECOM97, Oct. 1997, pp. 120-124.
- [9] K. Pokovic, T. Schmid, and N. Kuster, E-field Probe with improved isotropy in brain simulating liquids, Proceedings of the ELMAR, Zadar, Croatia, June 23-25, 1996, pp. 172-175.
- [10] Schmid & Partner Engineering AG, Application Note: Data Storage and Evaluation, June 1998, p2.
- [11] V. Hombach, K. Meier, M. Burkhardt, E. Kuhn, N. Kuster, The Dependence of EM Energy Absorption upon Human Head Modeling at 900 MHz, IEEE Transaction on Microwave Theory and Techniques, vol. 44 no. 10, Oct. 1996, pp. 1865-1873.
- [12] N. Kuster and Q. Balzano, Energy absorption mechanism by biological bodies in the near field of dipole antennas above 300MHz, IEEE Transaction on Vehicular Technology, vol. 41, no. 1, Feb. 1992, pp. 17-23.
- [13] G. Hartsgrove, A. Kraszewski, A. Surowiec, Simulated Biological Materials for Electromagnetic Radiation Absorption Studies, University of Ottawa, Bioelectromagnetics, Canada: 1987, pp. 29-36.
- [14] Q. Balzano, O. Garay, T. Manning Jr., Electromagnetic Energy Exposure of Simulated Users of Portable Cellular Telephones, IEEE Transactions on Vehicular Technology, vol. 44, no.3, Aug. 1995.
- [15] W. Gander, Computermathematick, Birkhaeuser, Basel, 1992.
- [16] W.H. Press, S.A. Teukolsky, W.T. Vetterling, and B.P. Flannery, Numerical Recipes in C, The Art of Scientific Computing, Second edition, Cambridge University Press, 1992.

FCC ID: A3LGT6700T		CERTIFICATION REPORT		Reviewed by: Quality Manager
SAR Filename: 0905040932.A3L	Test Dates: May 04-05, 2009	EUT Type: 850/1900 GSM/GPRS/EDGE and 850 WCDMA Phone with Bluetooth	Page 26 of 27	

- [17] Federal Communications Commission, OET Bulletin 65, Evaluating Compliance with FCC Guidelines for Human Exposure to Radiofrequency Electromagnetic Fields. Supplement C, Dec. 1997.
- [18] N. Kuster, R. Kastle, T. Schmid, Dosimetric evaluation of mobile communications equipment with known precision, IEEE Transaction on Communications, vol. E80-B, no. 5, May 1997, pp. 645-652.
- [19] CENELEC CLC/SC111B, European Prestandard (prENV 50166-2), Human Exposure to Electromagnetic Fields High-frequency: 10kHz-300GHz, Jan. 1995.
- [20] Prof. Dr. Niels Kuster, ETH, Eidgenössische Technische Hochschule Zürich, Dosimetric Evaluation of the Cellular Phone.
- [21] FCC SAR Measurement Procedures for 3G Devices v2.0, October 2007
- [22] SAR Measurement procedures for IEEE 802.11 a/b/g rev 1.2, May 2007
- [23] IEC 62209-1, Human exposure to radio frequency fields from hand-held and body-mounted wireless communication devices - Human models, instrumentation, and procedures - Part 1: Procedure to determine the specific absorption rate (SAR) for hand-held devices used in close proximity to the ear (frequency range of 300 MHz to 3 GHz), Feb. 2005.
- [24] FCC Public Notice DA-02-1438. Office of Engineering and Technology Announces a Transition Period for the Phantom Requirements of Supplement C to OET Bulletin 65, June 19, 2002
- [25] Industry Canada RSS-102 Radio Frequency Exposure Compliance of Radiocommunication Apparatus (All Frequency Bands) Issue 2, November 2005
- [26] Health Canada Safety Code 6 Limits of Human Exposure to Radio Frequency Electromagnetic Fields in the Frequency Range from 3 kHz – 300 GHz, 1999
- [27] FCC SAR Considerations for Handsets with Multiple Transmitters and Antennas v01r03 #648474, May 2008
- [28] FCC Application Note for SAR Probe Calibration and System Verification Consideration for Measurements at 150 MHz – 3 GHz, Rev 1.1, January 2007
- [29] FCC SAR Evaluation Considerations for Laptop Computers with Antennas Built-in on Display Screens, v01, December 2007
- [30] FCC SAR Measurement Requirements for 3 – 6 GHz Rev1.1, October 2006

FCC ID: A3LGTS6700T		CERTIFICATION REPORT		Reviewed by: Quality Manager
SAR Filename: 0905040932.A3L	Test Dates: May 04-05, 2009	EUT Type: 850/1900 GSM/GPRS/EDGE and 850 WCDMA Phone with Bluetooth	Page 27 of 27	

APPENDIX A: SAR TEST DATA

PCTEST ENGINEERING LABORATORY, INC.

**DUT: GT-S6700T; Type: 850/1900 GSM/GPRS/EDGE and 850 WCDMA Phone with Bluetooth
S/N: FG- 110-A**

Communication System: GSM850; Frequency: 836.6 MHz; Duty Cycle: 1:8.3

Medium: 835 Brain ($\sigma = 0.87$ mho/m, $\epsilon_r = 39.90$, $\rho = 1000$ kg/m³)

Phantom section: Right Section

Test Date: 05-04-2009; Ambient Temp: 24.6°C; Tissue Temp: 22.7 °C

Probe: ES3DV3 - SN3213; ConvF(5.94, 5.94, 5.94); Calibrated: 4/15/2009

Sensor-Surface: 3mm (Mechanical Surface Detection)

Electronics: DAE4 Sn649; Calibrated: 1/21/2009

Phantom: SAM Main; Type: SAM 4.0; Serial: TP-1114

Measurement SW: DASY4, V4.7 Build 71; Postprocessing SW: SEMCAD, V1.8 Build 172

Mode: GSM850, Right Head, Touch, Mid ch, Standard Battery, Slide In

Area Scan (7x10x1): Measurement grid: dx=15mm, dy=15mm

Zoom Scan (5x5x7)/Cube 0: Measurement grid: dx=8mm, dy=8mm, dz=5mm

Reference Value = 4.05 V/m

Peak SAR (extrapolated) = 0.633 W/kg

SAR(1 g) = 0.440 mW/g; SAR(10 g) = 0.309 mW/g

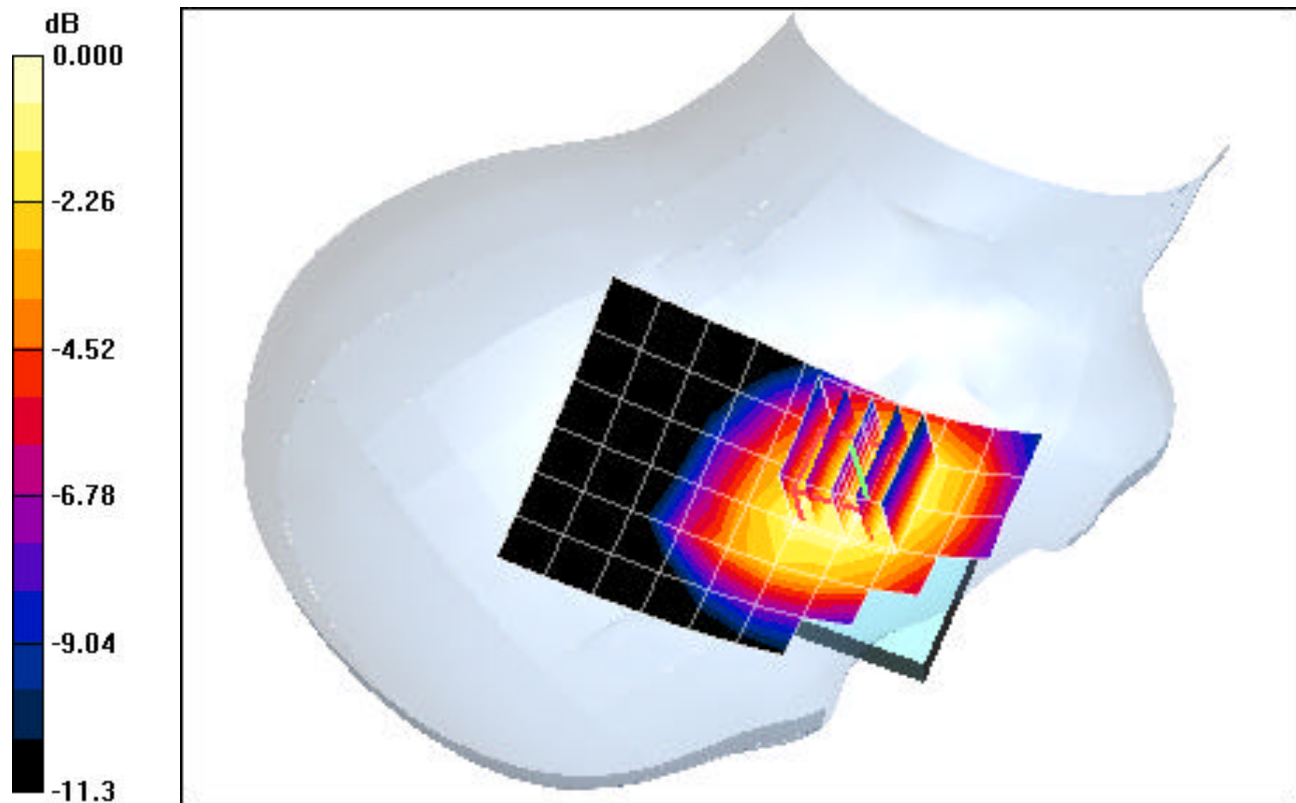

0 dB = 0.493mW/g

PCTEST ENGINEERING LABORATORY, INC.

**DUT: GT -S6700T; Type: 850/1900 GSM/GPRS/EDGE and 850 WCDMA Phone with Bluetooth
S/N: FG-110-A**

Communication System: GSM850; Frequency: 836.6 MHz; Duty Cycle: 1:8.3

Medium: 835 Brain ($\sigma = 0.87$ mho/m, $\epsilon_r = 39.90$, $\rho = 1000$ kg/m³)

Phantom section: Right Section

Test Date: 05-04-2009; Ambient Temp: 24.6°C; Tissue Temp: 22.7 °C

Probe: ES3DV3 - SN3213; ConvF(5.94, 5.94, 5.94); Calibrated: 4/15/2009

Sensor-Surface: 3mm (Mechanical Surface Detection)

Electronics: DAE4 Sn649; Calibrated: 1/21/2009

Phantom: SAM Main; Type: SAM 4.0; Serial: TP-1114

Measurement SW: DASY4, V4.7 Build 71; Postprocessing SW: SEMCAD, V1.8 Build 172

Mode: GSM850, Right Head, Tilt, Mid ch, Standard Battery, Slide In

Area Scan (7x10x1): Measurement grid: dx=15mm, dy=15mm

Zoom Scan (5x5x7)/Cube 0: Measurement grid: dx=8mm, dy=8mm, dz=5mm

Reference Value = 9.30 V/m

Peak SAR (extrapolated) = 0.254 W/kg

SAR(1 g) = 0.204 mW/g; SAR(10 g) = 0.152 mW/g

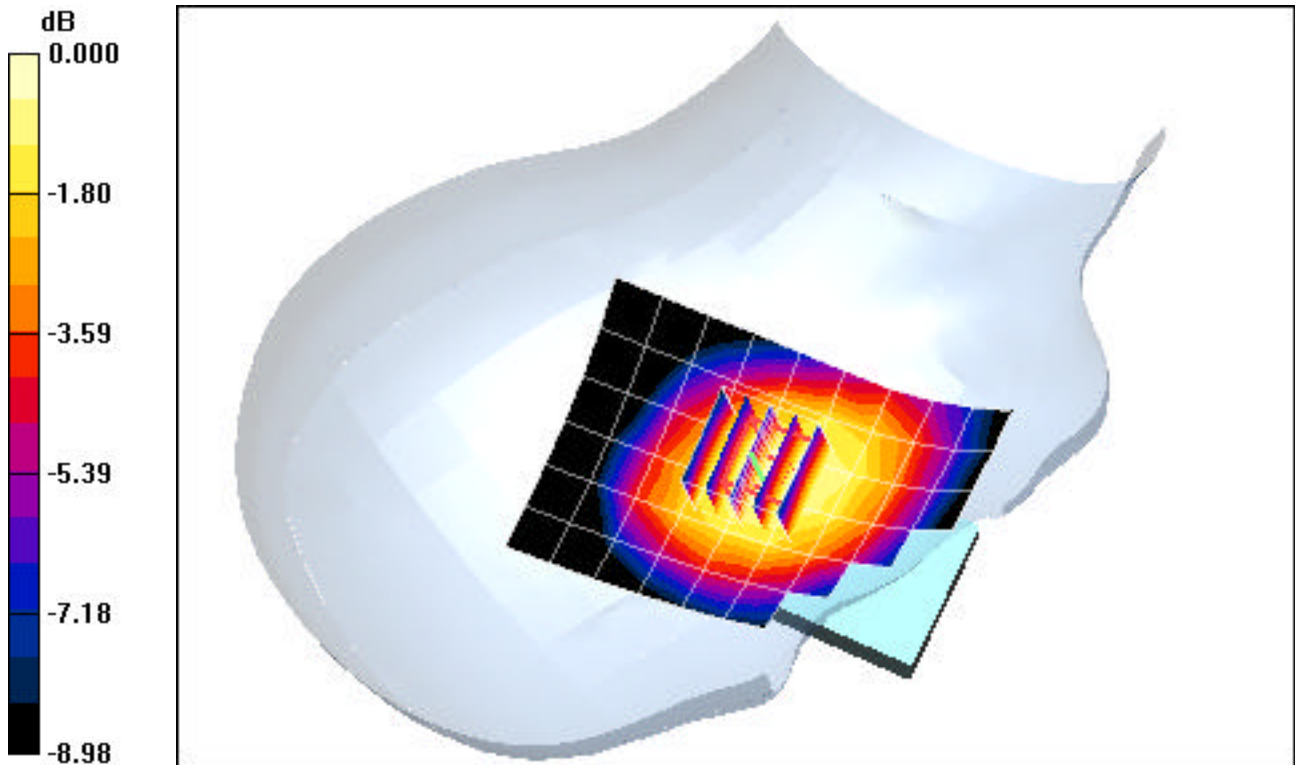

0 dB = 0.225mW/g

PCTEST ENGINEERING LABORATORY, INC.

**DUT: GT-S6700T; Type: 850/1900 GSM/GPRS/EDGE and 850 WCDMA Phone with Bluetooth
S/N: FG-110-A**

Communication System: GSM850; Frequency: 836.6 MHz; Duty Cycle: 1:8.3

Medium: 835 Brain ($\sigma = 0.87$ mho/m, $\epsilon_r = 39.90$, $\rho = 1000$ kg/m³)

Phantom section: Left Section

Test Date: 05-04-2009; Ambient Temp: 24.6°C; Tissue Temp: 22.7 °C

Probe: ES3DV3 - SN3213; ConvF(5.94, 5.94, 5.94); Calibrated: 4/15/2009

Sensor-Surface: 3mm (Mechanical Surface Detection)

Electronics: DAE4 Sn649; Calibrated: 1/21/2009

Phantom: SAM Main; Type: SAM 4.0; Serial: TP-1114

Measurement SW: DASY4, V4.7 Build 71; Postprocessing SW: SEMCAD, V1.8 Build 172

Mode: GSM850, Left Head, Touch, Mid ch, Standard Battery, Slide In

Area Scan (7x10x1): Measurement grid: dx=15mm, dy=15mm

Zoom Scan (5x5x7)/Cube 0: Measurement grid: dx=8mm, dy=8mm, dz=5mm

Reference Value = 4.09 V/m

Peak SAR (extrapolated) = 0.460 W/kg

SAR(1 g) = 0.375 mW/g; SAR(10 g) = 0.279 mW/g

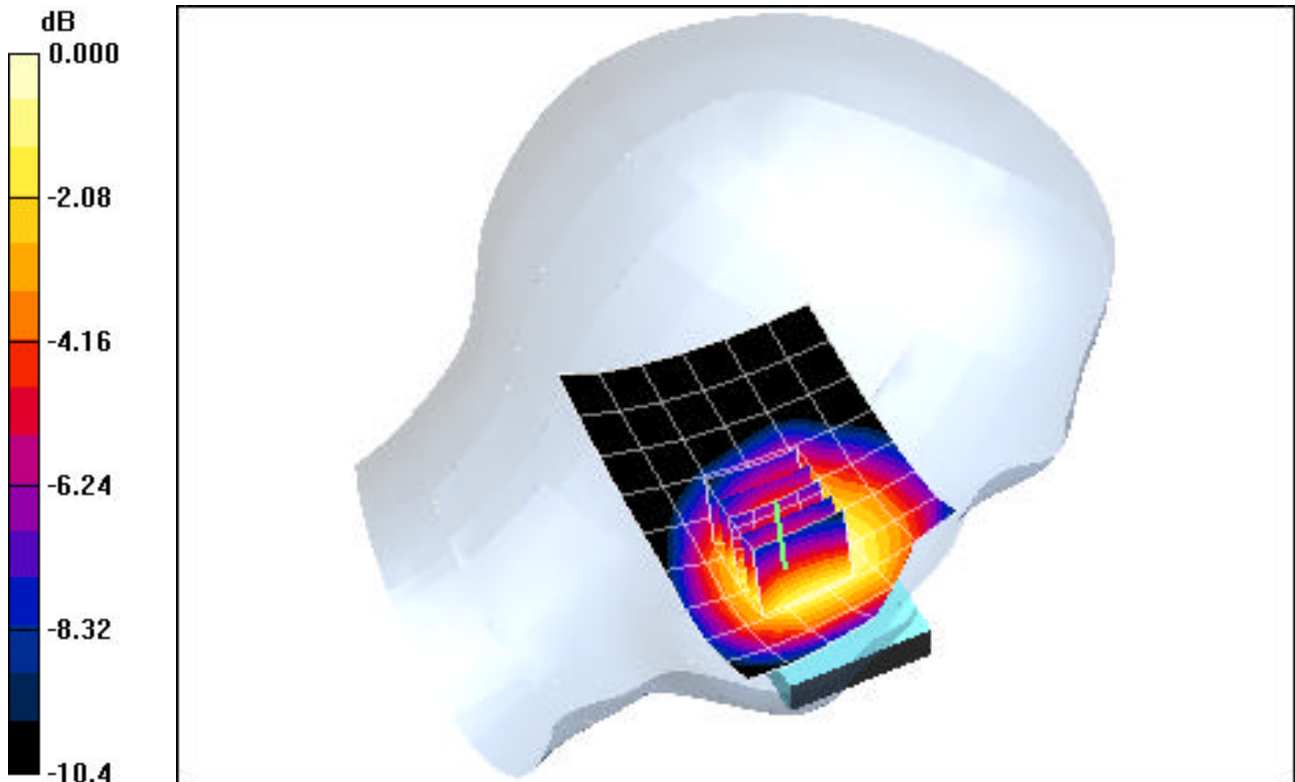

0 dB = 0.408mW/g

PCTEST ENGINEERING LABORATORY, INC.

**DUT: GT -S6700T; Type: 850/1900 GSM/GPRS/EDGE and 850 WCDMA Phone with Bluetooth
S/N: FG-110-A**

Communication System: GSM850; Frequency: 836.6 MHz; Duty Cycle: 1:8.3

Medium: 835 Brain ($\sigma = 0.87$ mho/m, $\epsilon_r = 39.90$, $\rho = 1000$ kg/m³)

Phantom section: Left Section

Test Date: 05-04-2009; Ambient Temp: 24.6°C; Tissue Temp: 22.7 °C

Probe: ES3DV3 - SN3213; ConvF(5.94, 5.94, 5.94); Calibrated: 4/15/2009

Sensor-Surface: 3mm (Mechanical Surface Detection)

Electronics: DAE4 Sn649; Calibrated: 1/21/2009

Phantom: SAM Main; Type: SAM 4.0; Serial: TP-1114

Measurement SW: DASY4, V4.7 Build 71; Postprocessing SW: SEMCAD, V1.8 Build 172

Mode: GSM850, Left Head, Tilt, Mid ch, Standard Battery, Slide In

Area Scan (7x10x1): Measurement grid: dx=15mm, dy=15mm

Zoom Scan (5x5x7)/Cube 0: Measurement grid: dx=8mm, dy=8mm, dz=5mm

Reference Value = 9.50 V/m

Peak SAR (extrapolated) = 0.234 W/kg

SAR(1 g) = 0.185 mW/g; SAR(10 g) = 0.140 mW/g

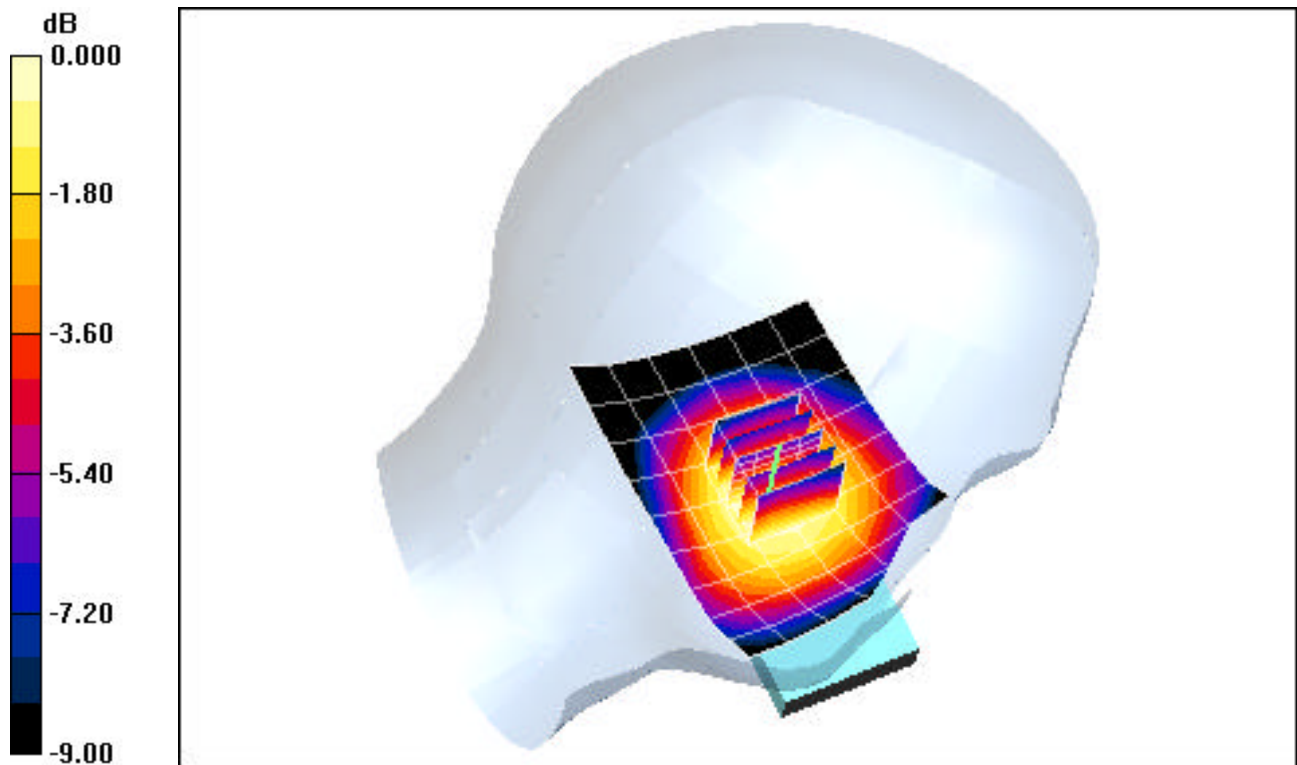

0 dB = 0.202mW/g

PCTEST ENGINEERING LABORATORY, INC.

**DUT: GT -S6700T; Type: 850/1900 GSM/GPRS/EDGE and 850 WCDMA Phone with Bluetooth
S/N: FG-110-A**

Communication System: GSM850; Frequency: 836.6 MHz; Duty Cycle: 1:8.3

Medium: 835 Brain ($\sigma = 0.87$ mho/m, $\epsilon_r = 39.90$, $\rho = 1000$ kg/m³)

Phantom section: Right Section

Test Date: 05-04-2009; Ambient Temp: 24.6°C; Tissue Temp: 22.7 °C

Probe: ES3DV3 - SN3213; ConvF(5.94, 5.94, 5.94); Calibrated: 4/15/2009

Sensor-Surface: 3mm (Mechanical Surface Detection)

Electronics: DAE4 Sn649; Calibrated: 1/21/2009

Phantom: SAM Main; Type: SAM 4.0; Serial: TP-1114

Measurement SW: DASY4, V4.7 Build 71; Postprocessing SW: SEMCAD, V1.8 Build 172

Mode: GSM850, Right Head, Touch, Mid ch, Standard Battery, Slide Out

Area Scan (7x12x1): Measurement grid: dx=15mm, dy=15mm

Zoom Scan (5x5x7)/Cube 0: Measurement grid: dx=8mm, dy=8mm, dz=5mm

Reference Value = 6.13 V/m

Peak SAR (extrapolated) = 0.524 W/kg

SAR(1 g) = 0.395 mW/g; SAR(10 g) = 0.288 mW/g

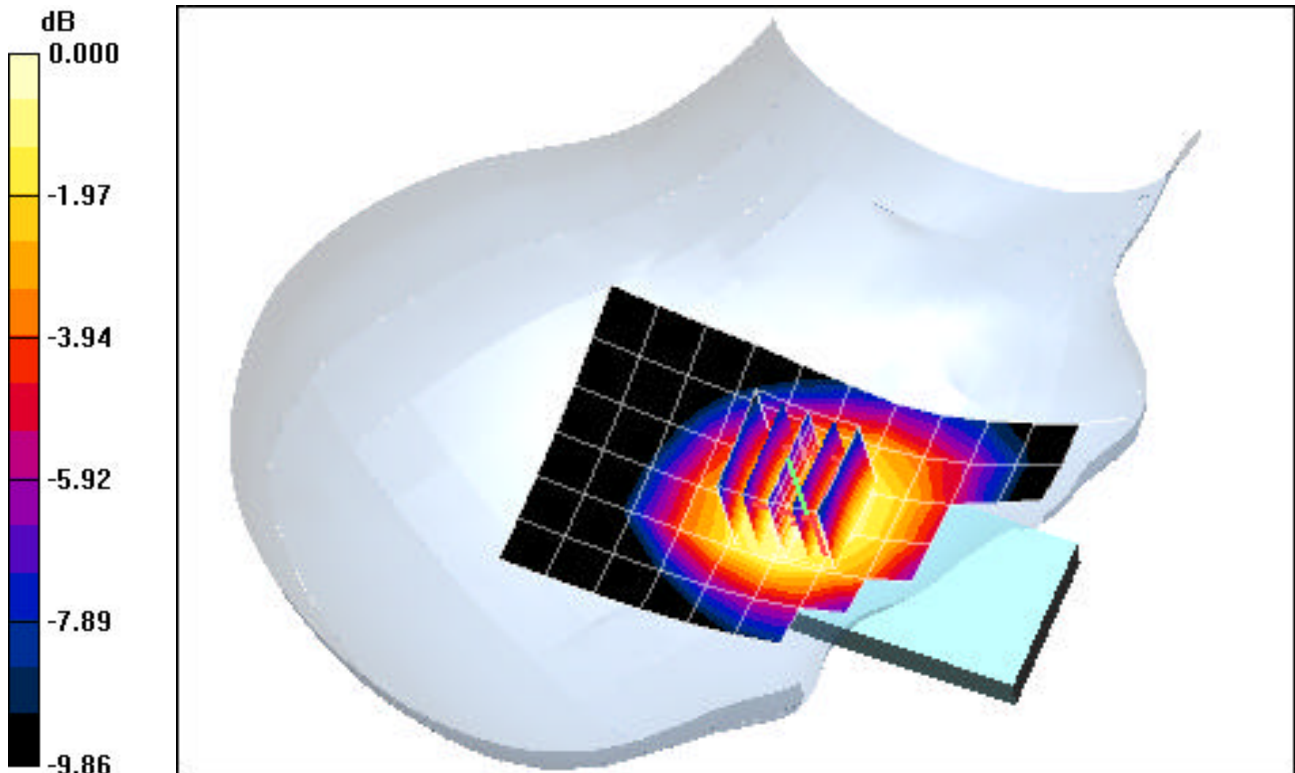

0 dB = 0.435mW/g

PCTEST ENGINEERING LABORATORY, INC.

**DUT: GT -S6700T; Type: 850/1900 GSM/GPRS/EDGE and 850 WCDMA Phone with Bluetooth
S/N: FG-110-A**

Communication System: GSM850; Frequency: 836.6 MHz; Duty Cycle: 1:8.3

Medium: 835 Brain ($\sigma = 0.87$ mho/m, $\epsilon_r = 39.90$, $\rho = 1000$ kg/m³)

Phantom section: Right Section

Test Date: 05-04-2009; Ambient Temp: 24.6°C; Tissue Temp: 22.7 °C

Probe: ES3DV3 - SN3213; ConvF(5.94, 5.94, 5.94); Calibrated: 4/15/2009

Sensor-Surface: 3mm (Mechanical Surface Detection)

Electronics: DAE4 Sn649; Calibrated: 1/21/2009

Phantom: SAM Main; Type: SAM 4.0; Serial: TP-1114

Measurement SW: DASY4, V4.7 Build 71; Postprocessing SW: SEMCAD, V1.8 Build 172

Mode: GSM850, Right Head, Tilt, Mid ch, Standard Battery, Slide Out

Area Scan (7x12x1): Measurement grid: dx=15mm, dy=15mm

Zoom Scan (5x5x7)/Cube 0: Measurement grid: dx=8mm, dy=8mm, dz=5mm

Reference Value = 9.62 V/m

Peak SAR (extrapolated) = 0.256 W/kg

SAR(1 g) = 0.203 mW/g; SAR(10 g) = 0.152 mW/g

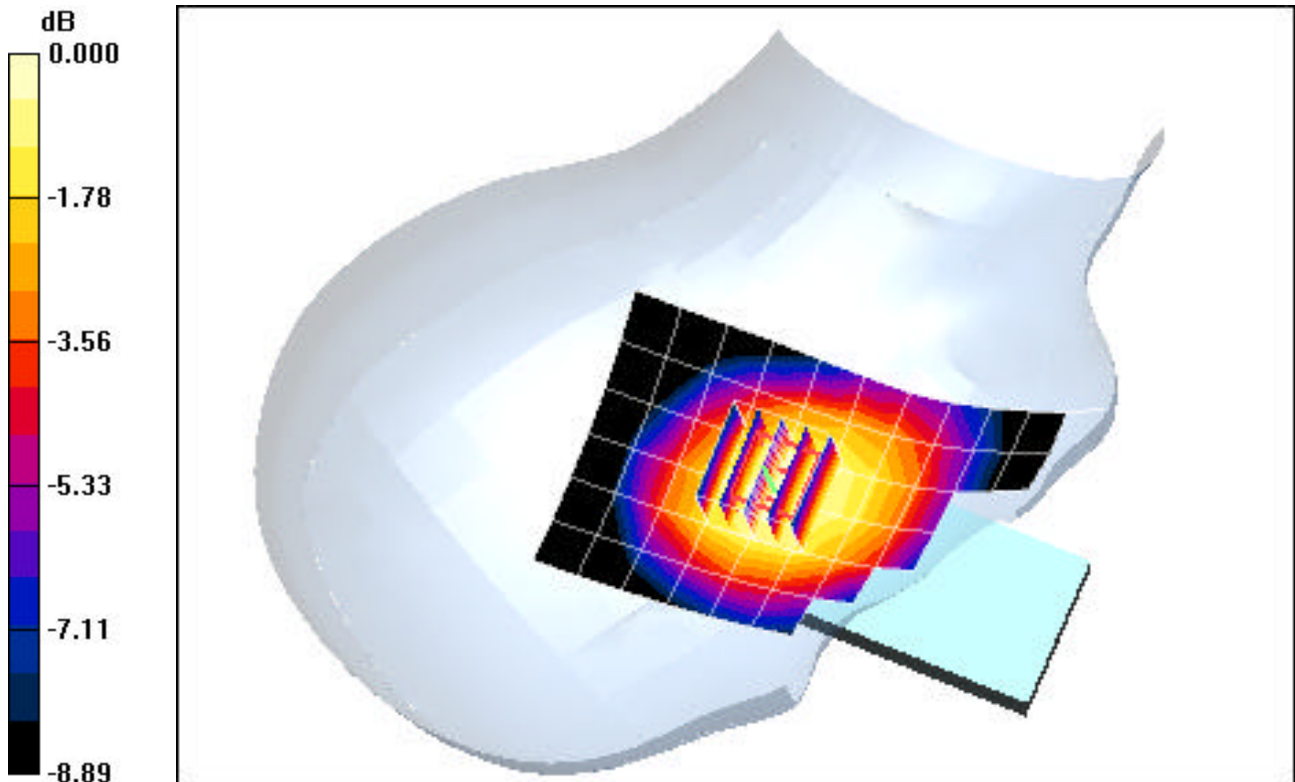

0 dB = 0.225mW/g

PCTEST ENGINEERING LABORATORY, INC.

**DUT: GT-S6700T; Type: 850/1900 GSM/GPRS/EDGE and 850 WCDMA Phone with Bluetooth
S/N: FG-110-A**

Communication System: GSM850; Frequency: 836.6 MHz; Duty Cycle: 1:8.3

Medium: 835 Brain ($\sigma = 0.87$ mho/m, $\epsilon_r = 39.90$, $\rho = 1000$ kg/m³)

Phantom section: Left Section

Test Date: 05-04-2009; Ambient Temp: 24.6°C; Tissue Temp: 22.7 °C

Probe: ES3DV3 - SN3213; ConvF(5.94, 5.94, 5.94); Calibrated: 4/15/2009

Sensor-Surface: 3mm (Mechanical Surface Detection)

Electronics: DAE4 Sn649; Calibrated: 1/21/2009

Phantom: SAM Main; Type: SAM 4.0; Serial: TP-1114

Measurement SW: DASY4, V4.7 Build 71; Postprocessing SW: SEMCAD, V1.8 Build 172

Mode: GSM850, Left Head, Touch, Mid ch, Standard Battery, Slide Out

Area Scan (7x12x1): Measurement grid: dx=15mm, dy=15mm

Zoom Scan (5x5x7)/Cube 0: Measurement grid: dx=8mm, dy=8mm, dz=5mm

Reference Value = 6.65 V/m

Peak SAR (extrapolated) = 0.568 W/kg

SAR(1 g) = 0.434 mW/g; SAR(10 g) = 0.313 mW/g

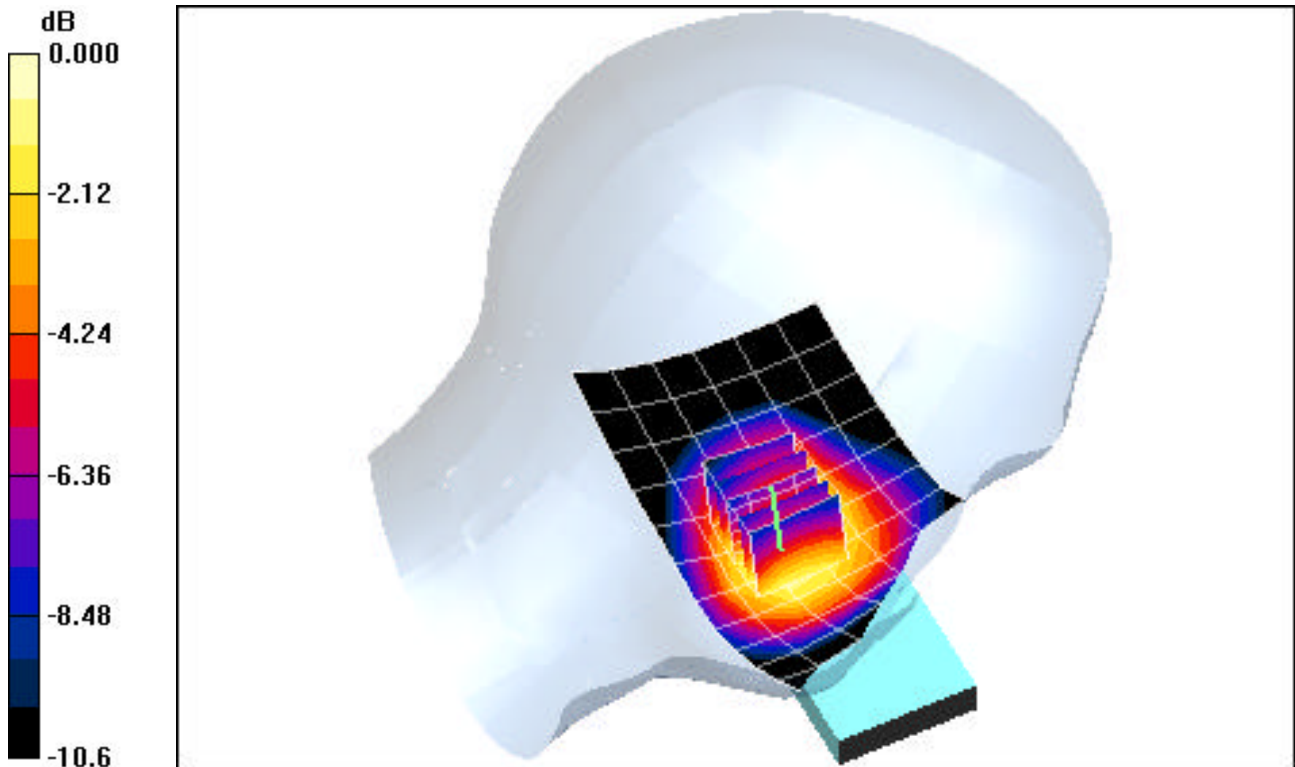

0 dB = 0.483mW/g

PCTEST ENGINEERING LABORATORY, INC.

**DUT: GT-S6700T; Type: 850/1900 GSM/GPRS/EDGE and 850 WCDMA Phone with Bluetooth
S/N: FG-110-A**

Communication System: GSM850; Frequency: 836.6 MHz; Duty Cycle: 1:8.3
Medium: 835 Brain ($\sigma = 0.87$ mho/m, $\epsilon_r = 39.90$, $\rho = 1000$ kg/m³)
Phantom section: Left Section

Test Date: 05-04-2009; Ambient Temp: 24.6°C; Tissue Temp: 22.7 °C

Probe: ES3DV3 - SN3213; ConvF(5.94, 5.94, 5.94); Calibrated: 4/15/2009
Sensor-Surface: 3mm (Mechanical Surface Detection)
Electronics: DAE4 Sn649; Calibrated: 1/21/2009
Phantom: SAM Main; Type: SAM 4.0; Serial: TP-1114
Measurement SW: DASY4, V4.7 Build 71; Postprocessing SW: SEMCAD, V1.8 Build 172

Mode: GSM850, Left Head, Tilt, Mid ch, Standard Battery, Slide Out

Area Scan (7x12x1): Measurement grid: dx=15mm, dy=15mm

Zoom Scan (5x5x7)/Cube 0: Measurement grid: dx=8mm, dy=8mm, dz=5mm

Reference Value = 11.2 V/m

Peak SAR (extrapolated) = 0.293 W/kg

SAR(1 g) = 0.227 mW/g; SAR(10 g) = 0.165 mW/g

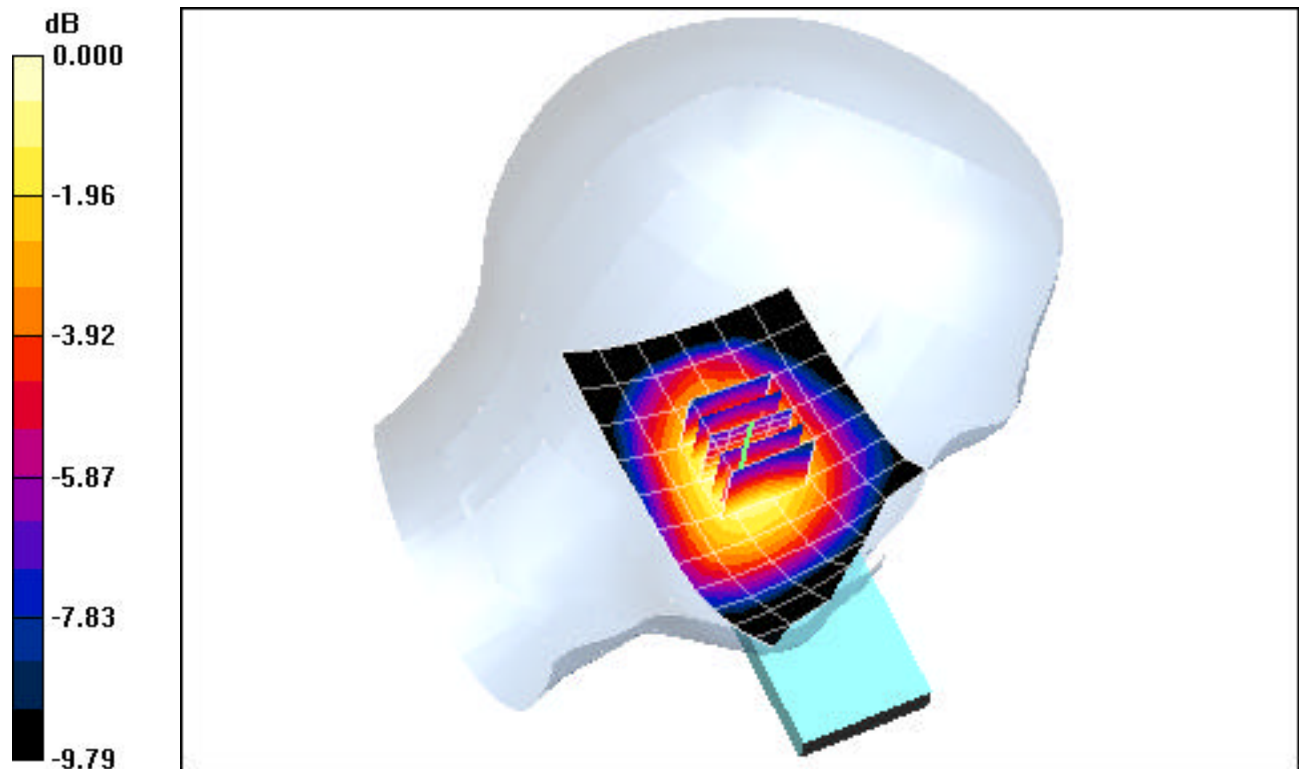

0 dB = 0.251mW/g

PCTEST ENGINEERING LABORATORY, INC.

**DUT: GT -S6700T; Type: 850/1900 GSM/GPRS/EDGE and 850 WCDMA Phone with Bluetooth
S/N: FG-110-A**

Communication System: WCDMA850; Frequency: 836.6 MHz; Duty Cycle: 1:1
Medium: 835 Brain ($\sigma = 0.87$ mho/m, $\epsilon_r = 39.90$, $\rho = 1000$ kg/m³)
Phantom section: Right Section

Test Date: 05-04-2009; Ambient Temp: 24.6°C; Tissue Temp: 22.7 °C

Probe: ES3DV3 - SN3213; ConvF(5.94, 5.94, 5.94); Calibrated: 4/15/2009
Sensor-Surface: 3mm (Mechanical Surface Detection)
Electronics: DAE4 Sn649; Calibrated: 1/21/2009
Phantom: SAM Main; Type: SAM 4.0; Serial: TP-1114
Measurement SW: DASY4, V4.7 Build 71; Postprocessing SW: SEMCAD, V1.8 Build 172

Mode: WCDMA 850, Right Head, Touch, Mid ch, Standard Battery, Slide In

Area Scan (7x10x1): Measurement grid: dx=15mm, dy=15mm
Zoom Scan (5x5x7)/Cube 0: Measurement grid: dx=8mm, dy=8mm, dz=5mm
Reference Value = 3.65 V/m
Peak SAR (extrapolated) = 0.452 W/kg
SAR(1 g) = 0.315 mW/g; SAR(10 g) = 0.222 mW/g

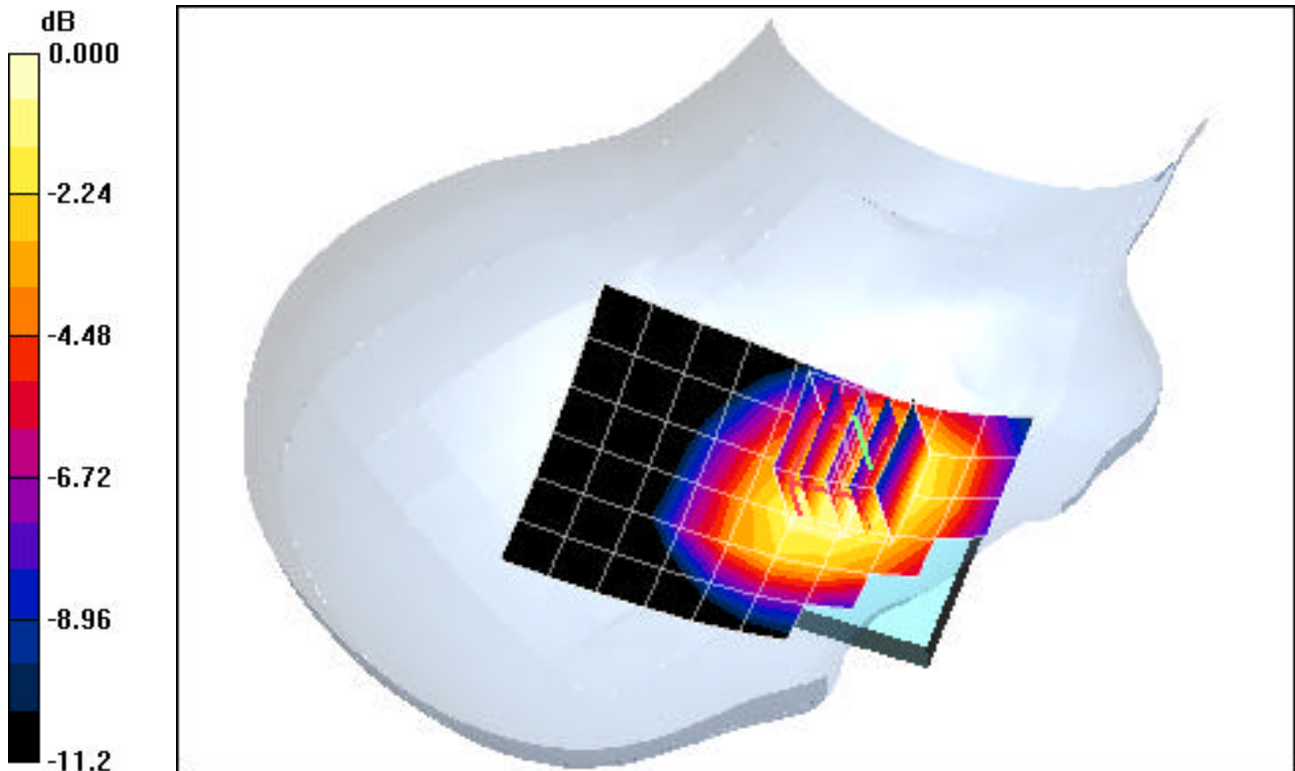

0 dB = 0.356mW/g

PCTEST ENGINEERING LABORATORY, INC.

**DUT: GT-S6700T; Type: 850/1900 GSM/GPRS/EDGE and 850 WCDMA Phone with Bluetooth
S/N: FG-110-A**

Communication System: WCDMA850; Frequency: 836.6 MHz; Duty Cycle: 1:1
Medium: 835 Brain ($\sigma = 0.87$ mho/m, $\epsilon_r = 39.90$, $\rho = 1000$ kg/m³)
Phantom section: Right Section

Test Date: 05-04-2009; Ambient Temp: 24.6°C; Tissue Temp: 22.7 °C

Probe: ES3DV3 - SN3213; ConvF(5.94, 5.94, 5.94); Calibrated: 4/15/2009
Sensor-Surface: 3mm (Mechanical Surface Detection)
Electronics: DAE4 Sn649; Calibrated: 1/21/2009
Phantom: SAM Main; Type: SAM 4.0; Serial: TP-1114
Measurement SW: DASY4, V4.7 Build 71; Postprocessing SW: SEMCAD, V1.8 Build 172

Mode: WCDMA 850, Right Head, Tilt, Mid ch, Standard Battery, Slide In

Area Scan (7x10x1): Measurement grid: dx=15mm, dy=15mm
Zoom Scan (5x5x7)/Cube 0: Measurement grid: dx=8mm, dy=8mm, dz=5mm
Reference Value = 7.36 V/m
Peak SAR (extrapolated) = 0.164 W/kg
SAR(1 g) = 0.131 mW/g; SAR(10 g) = 0.098 mW/g

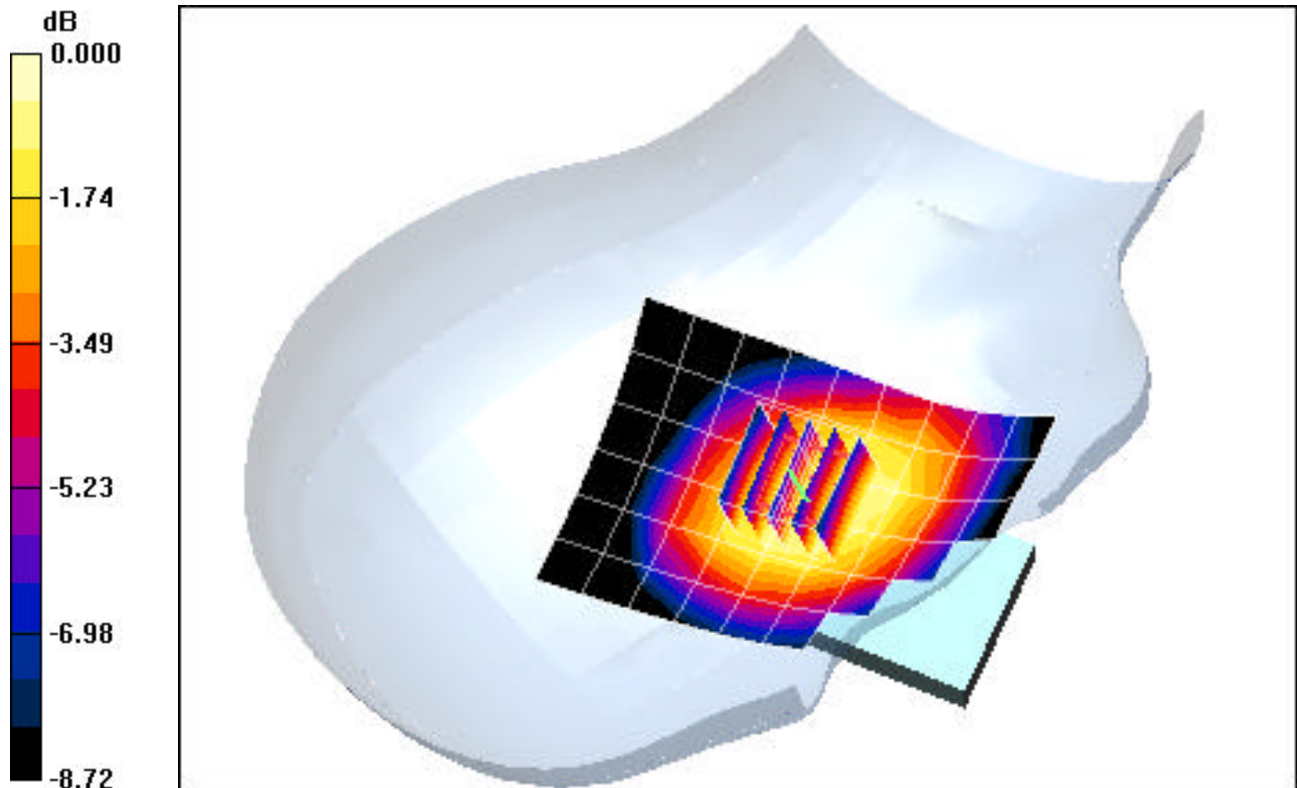

0 dB = 0.143mW/g

PCTEST ENGINEERING LABORATORY, INC.

**DUT: GT-S6700T; Type: 850/1900 GSM/GPRS/EDGE and 850 WCDMA Phone with Bluetooth
S/N: FG-110-A**

Communication System: WCDMA850; Frequency: 836.6 MHz; Duty Cycle: 1:1
Medium: 835 Brain ($\sigma = 0.87$ mho/m, $\epsilon_r = 39.90$, $\rho = 1000$ kg/m³)
Phantom section: Left Section

Test Date: 05-04-2009; Ambient Temp: 24.6°C; Tissue Temp: 22.7 °C

Probe: ES3DV3 - SN3213; ConvF(5.94, 5.94, 5.94); Calibrated: 4/15/2009
Sensor-Surface: 3mm (Mechanical Surface Detection)
Electronics: DAE4 Sn649; Calibrated: 1/21/2009
Phantom: SAM Main; Type: SAM 4.0; Serial: TP-1114
Measurement SW: DASY4, V4.7 Build 71; Postprocessing SW: SEMCAD, V1.8 Build 172

Mode: WCDMA 850, Left Head, Touch, Mid ch, Standard Battery, Slide In

Area Scan (7x10x1): Measurement grid: dx=15mm, dy=15mm
Zoom Scan (5x5x7)/Cube 0: Measurement grid: dx=8mm, dy=8mm, dz=5mm
Reference Value = 3.60 V/m
Peak SAR (extrapolated) = 0.327 W/kg
SAR(1 g) = 0.264 mW/g; SAR(10 g) = 0.196 mW/g

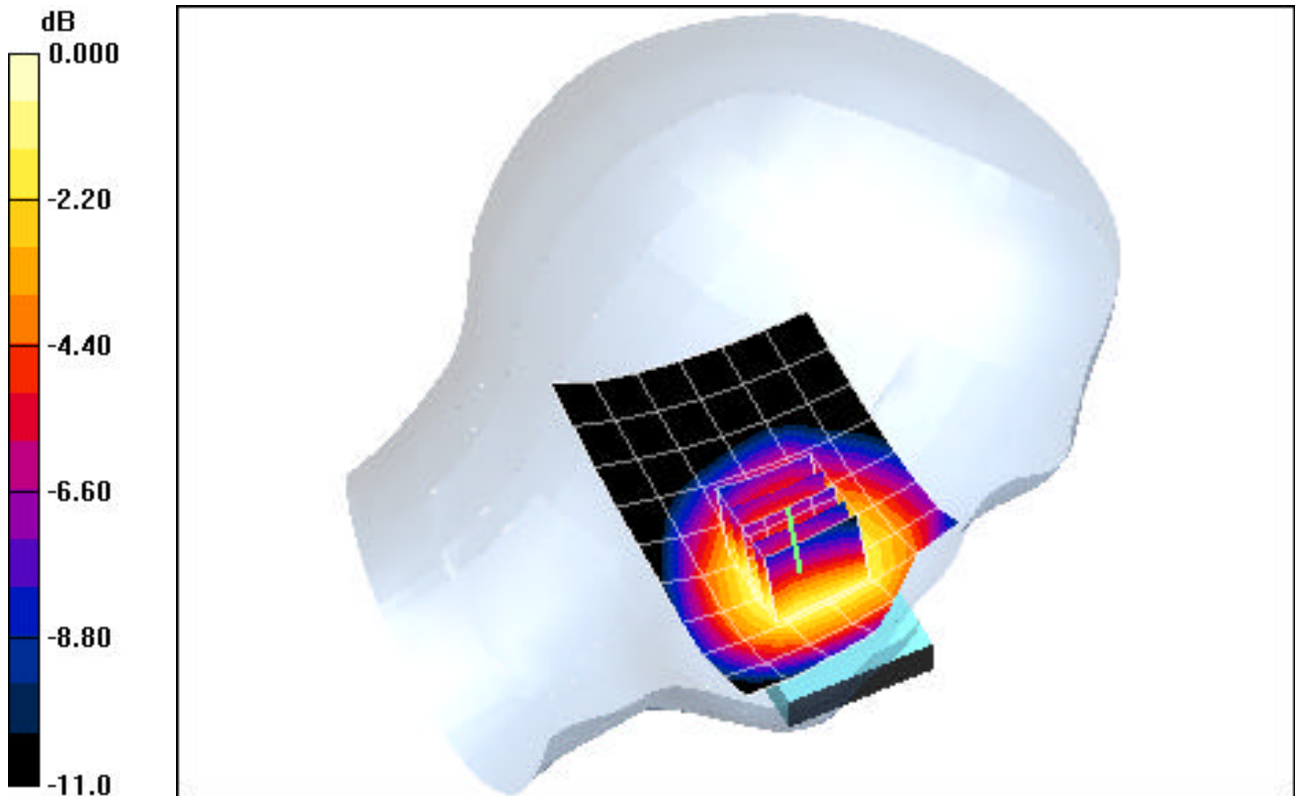

0 dB = 0.289mW/g

PCTEST ENGINEERING LABORATORY, INC.

**DUT: GT -S6700T; Type: 850/1900 GSM/GPRS/EDGE and 850 WCDMA Phone with Bluetooth
S/N: FG-110-A**

Communication System: WCDMA850; Frequency: 836.6 MHz; Duty Cycle: 1:1
Medium: 835 Brain ($\sigma = 0.87$ mho/m, $\epsilon_r = 39.90$, $\rho = 1000$ kg/m³)
Phantom section: Left Section

Test Date: 05-04-2009; Ambient Temp: 24.6°C; Tissue Temp: 22.7 °C

Probe: ES3DV3 - SN3213; ConvF(5.94, 5.94, 5.94); Calibrated: 4/15/2009
Sensor-Surface: 3mm (Mechanical Surface Detection)
Electronics: DAE4 Sn649; Calibrated: 1/21/2009
Phantom: SAM Main; Type: SAM 4.0; Serial: TP-1114
Measurement SW: DASY4, V4.7 Build 71; Postprocessing SW: SEMCAD, V1.8 Build 172

Mode: WCDMA 850, Left Head, Tilt, Mid ch, Standard Battery, Slide In

Area Scan (7x10x1): Measurement grid: dx=15mm, dy=15mm

Zoom Scan (5x5x7)/Cube 0: Measurement grid: dx=8mm, dy=8mm, dz=5mm

Reference Value = 7.57 V/m

Peak SAR (extrapolated) = 0.160 W/kg

SAR(1 g) = 0.127 mW/g; SAR(10 g) = 0.095 mW/g

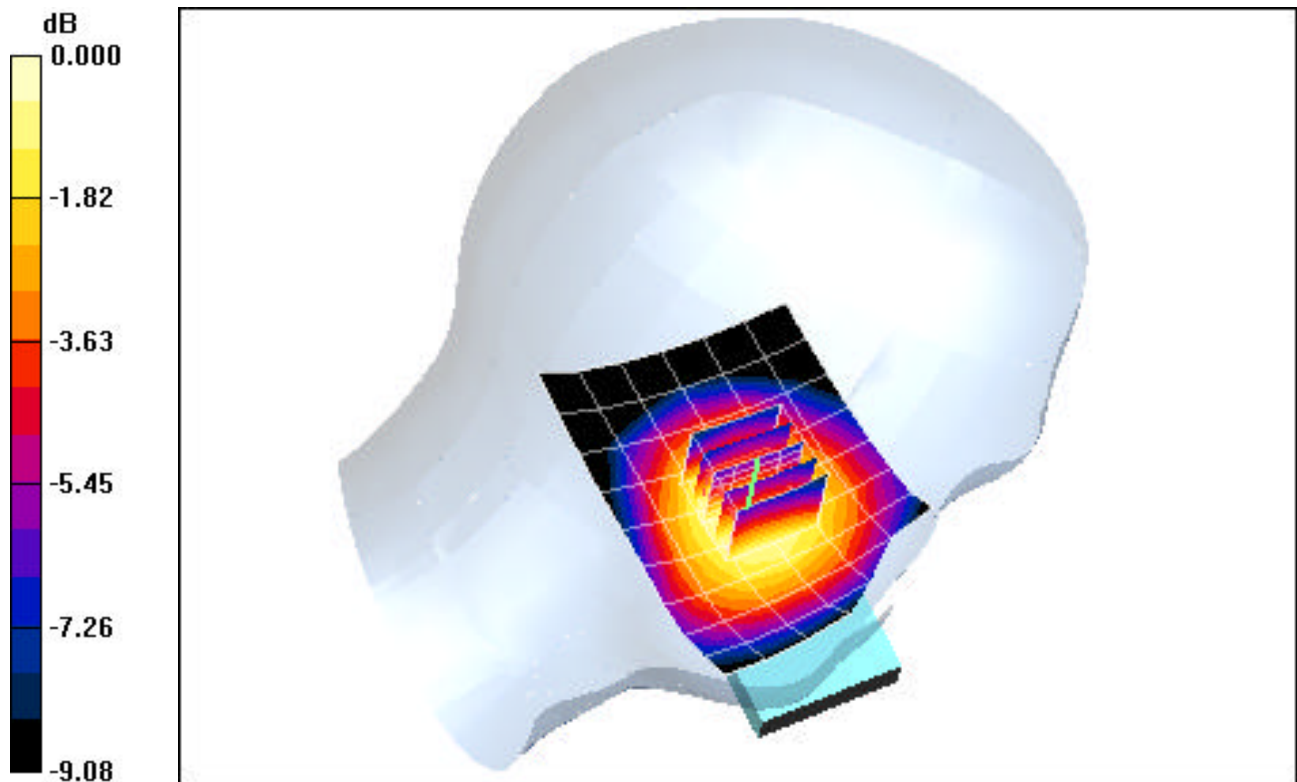

0 dB = 0.139mW/g

PCTEST ENGINEERING LABORATORY, INC.

**DUT: GT-S6700T; Type: 850/1900 GSM/GPRS/EDGE and 850 WCDMA Phone with Bluetooth
S/N: FG-110-A**

Communication System: WCDMA850; Frequency: 836.6 MHz; Duty Cycle: 1:1
Medium: 835 Brain ($\sigma = 0.87$ mho/m, $\epsilon_r = 39.90$, $\rho = 1000$ kg/m³)
Phantom section: Right Section

Test Date: 05-04-2009; Ambient Temp: 24.6°C; Tissue Temp: 22.7 °C

Probe: ES3DV3 - SN3213; ConvF(5.94, 5.94, 5.94); Calibrated: 4/15/2009

Sensor-Surface: 3mm (Mechanical Surface Detection)

Electronics: DAE4 Sn649; Calibrated: 1/21/2009

Phantom: SAM Main; Type: SAM 4.0; Serial: TP-1114

Measurement SW: DASY4, V4.7 Build 71; Postprocessing SW: SEMCAD, V1.8 Build 172

Mode: WCDMA 850, Right Head, Touch, Mid ch, Standard Battery, Slide Out

Area Scan (7x12x1): Measurement grid: dx=15mm, dy=15mm

Zoom Scan (5x5x7)/Cube 0: Measurement grid: dx=8mm, dy=8mm, dz=5mm

Reference Value = 5.49 V/m

Peak SAR (extrapolated) = 0.351 W/kg

SAR(1 g) = 0.255 mW/g; SAR(10 g) = 0.184 mW/g

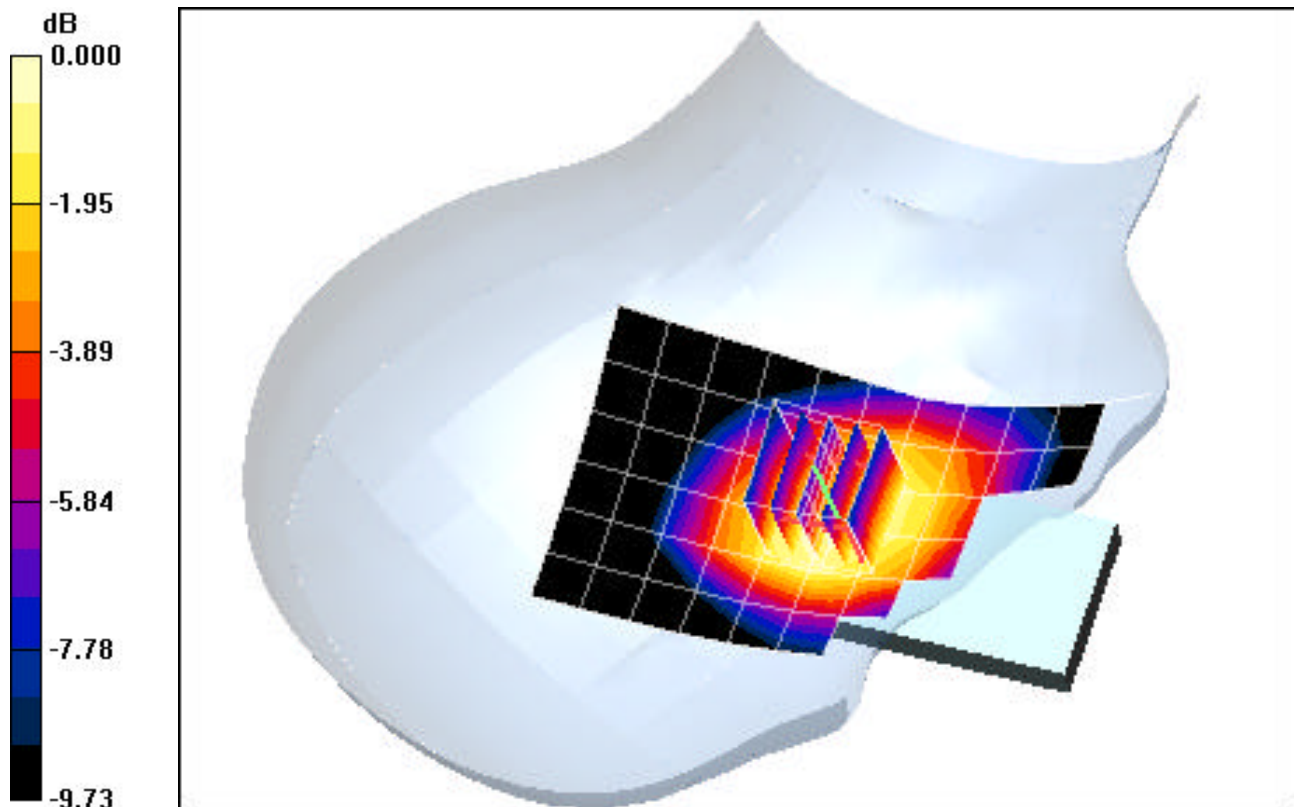

0 dB = 0.282mW/g

PCTEST ENGINEERING LABORATORY, INC.

**DUT: GT-S6700T; Type: 850/1900 GSM/GPRS/EDGE and 850 WCDMA Phone with Bluetooth
S/N: FG-110-A**

Communication System: WCDMA850; Frequency: 836.6 MHz; Duty Cycle: 1:1
Medium: 835 Brain ($\sigma = 0.87$ mho/m, $\epsilon_r = 39.90$, $\rho = 1000$ kg/m³)
Phantom section: Right Section

Test Date: 05-04-2009; Ambient Temp: 24.6°C; Tissue Temp: 22.7 °C

Probe: ES3DV3 - SN3213; ConvF(5.94, 5.94, 5.94); Calibrated: 4/15/2009
Sensor-Surface: 3mm (Mechanical Surface Detection)
Electronics: DAE4 Sn649; Calibrated: 1/21/2009
Phantom: SAM Main; Type: SAM 4.0; Serial: TP-1114
Measurement SW: DASY4, V4.7 Build 71; Postprocessing SW: SEMCAD, V1.8 Build 172

Mode: WCDMA 850, Right Head, Tilt, Mid ch, Standard Battery, Slide Out

Area Scan (7x12x1): Measurement grid: dx=15mm, dy=15mm
Zoom Scan (5x5x7)/Cube 0: Measurement grid: dx=8mm, dy=8mm, dz=5mm
Reference Value = 8.63 V/m
Peak SAR (extrapolated) = 0.185 W/kg
SAR(1 g) = 0.144 mW/g; SAR(10 g) = 0.106 mW/g

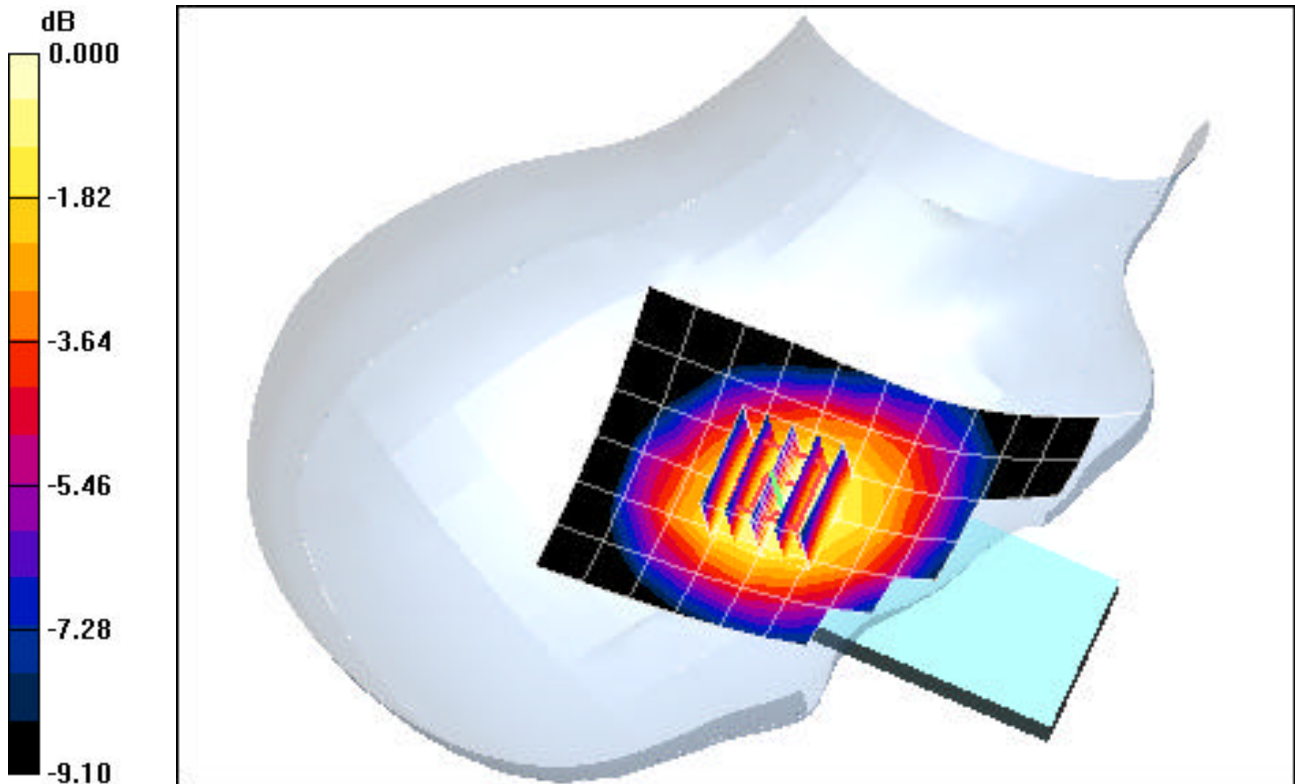

0 dB = 0.160mW/g

PCTEST ENGINEERING LABORATORY, INC.

**DUT: GT-S6700T; Type: 850/1900 GSM/GPRS/EDGE and 850 WCDMA Phone with Bluetooth
S/N: FG-110-A**

Communication System: WCDMA850; Frequency: 836.6 MHz; Duty Cycle: 1:1
Medium: 835 Brain ($\sigma = 0.87$ mho/m, $\epsilon_r = 39.90$, $\rho = 1000$ kg/m³)
Phantom section: Left Section

Test Date: 05-04-2009; Ambient Temp: 24.6°C; Tissue Temp: 22.7 °C

Probe: ES3DV3 - SN3213; ConvF(5.94, 5.94, 5.94); Calibrated: 4/15/2009

Sensor-Surface: 3mm (Mechanical Surface Detection)

Electronics: DAE4 Sn649; Calibrated: 1/21/2009

Phantom: SAM Main; Type: SAM 4.0; Serial: TP-1114

Measurement SW: DASY4, V4.7 Build 71; Postprocessing SW: SEMCAD, V1.8 Build 172

Mode: WCDMA 850, Left Head, Touch, Mid ch, Standard Battery, Slide Out

Area Scan (7x12x1): Measurement grid: dx=15mm, dy=15mm

Zoom Scan (5x5x7)/Cube 0: Measurement grid: dx=8mm, dy=8mm, dz=5mm

Reference Value = 5.44 V/m

Peak SAR (extrapolated) = 0.367 W/kg

SAR(1 g) = 0.284 mW/g; SAR(10 g) = 0.209 mW/g

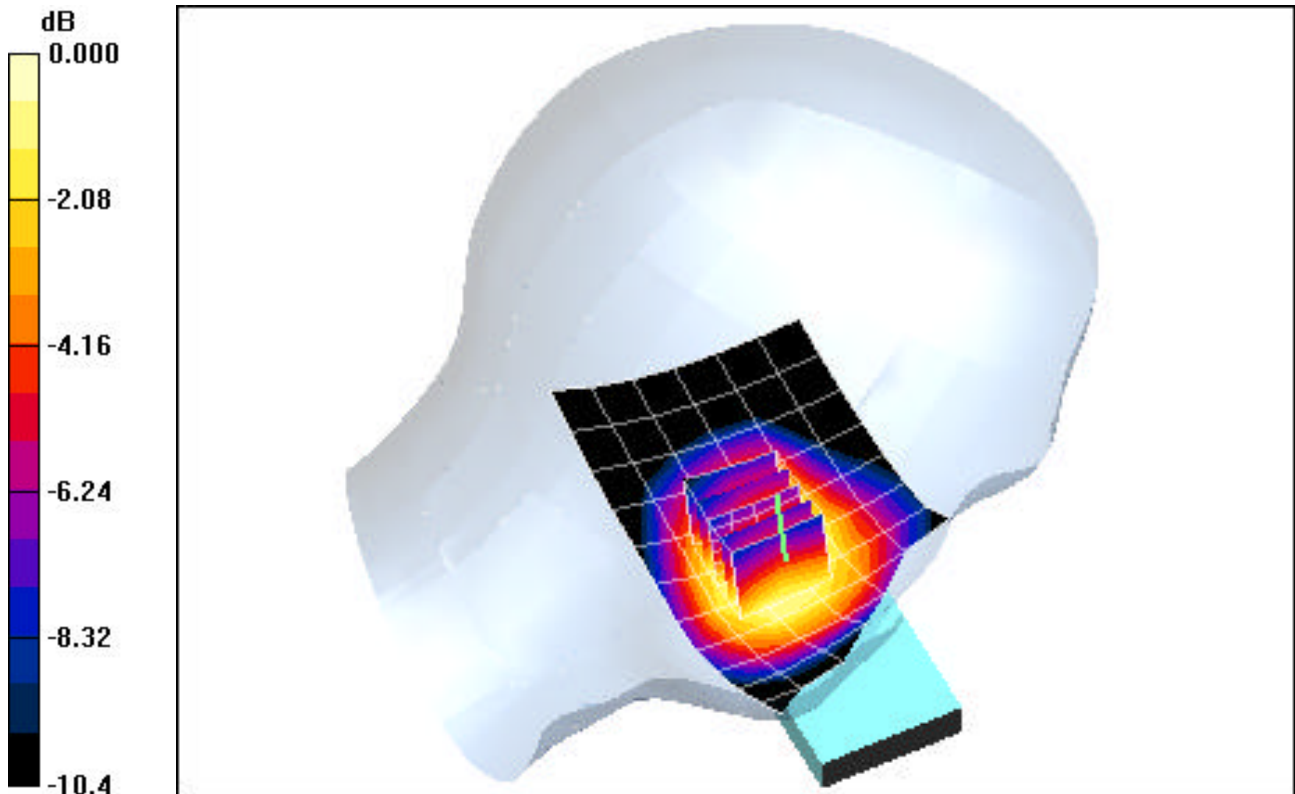

0 dB = 0.310mW/g

PCTEST ENGINEERING LABORATORY, INC.

**DUT: GT-S6700T; Type: 850/1900 GSM/GPRS/EDGE and 850 WCDMA Phone with Bluetooth
S/N: FG-110-A**

Communication System: WCDMA850; Frequency: 836.6 MHz; Duty Cycle: 1:1
Medium: 835 Brain ($\sigma = 0.87$ mho/m, $\epsilon_r = 39.90$, $\rho = 1000$ kg/m³)
Phantom section: Left Section

Test Date: 05-04-2009; Ambient Temp: 24.6°C; Tissue Temp: 22.7 °C

Probe: ES3DV3 - SN3213; ConvF(5.94, 5.94, 5.94); Calibrated: 4/15/2009
Sensor-Surface: 3mm (Mechanical Surface Detection)
Electronics: DAE4 Sn649; Calibrated: 1/21/2009
Phantom: SAM Main; Type: SAM 4.0; Serial: TP-1114
Measurement SW: DASY4, V4.7 Build 71; Postprocessing SW: SEMCAD, V1.8 Build 172

Mode: WCDMA 850, Left Head, Tilt, Mid ch, Standard Battery, Slide Out

Area Scan (7x12x1): Measurement grid: dx=15mm, dy=15mm

Zoom Scan (5x5x7)/Cube 0: Measurement grid: dx=8mm, dy=8mm, dz=5mm

Reference Value = 8.91 V/m

Peak SAR (extrapolated) = 0.198 W/kg

SAR(1 g) = 0.153 mW/g; SAR(10 g) = 0.113 mW/g

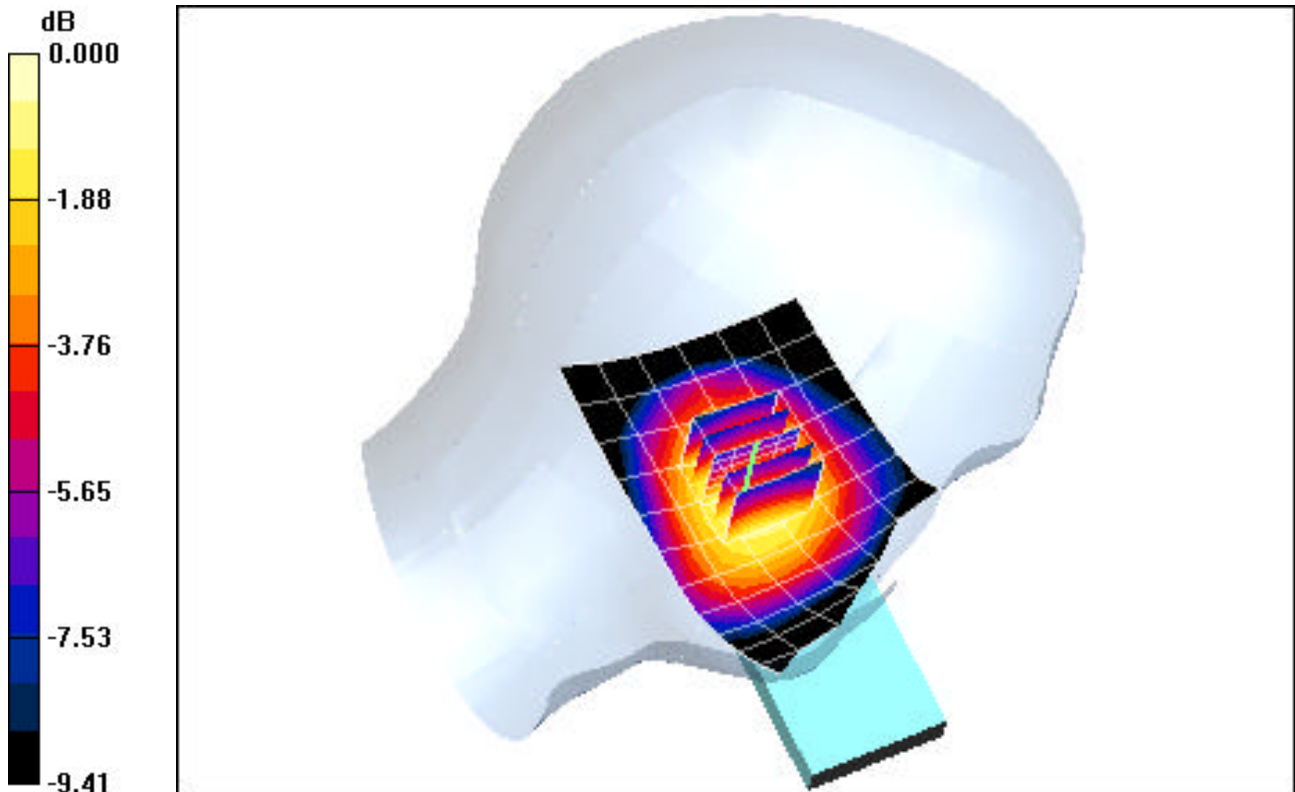

0 dB = 0.169mW/g

PCTEST ENGINEERING LABORATORY, INC.

**DUT: GT-S6700T; Type: 850/1900 GSM/GPRS/EDGE and 850 WCDMA Phone with Bluetooth
S/N: FG-110-A**

Communication System: GSM1900; Frequency: 1880 MHz; Duty Cycle: 1:8.3

Medium: 1900 Brain ($\sigma = 1.37$ mho/m, $\epsilon_r = 40.84$, $\rho = 1000$ kg/m³)

Phantom section: Right Section

Test Date: 05-05-2009; Ambient Temp: 24.3°C; Tissue Temp: 22.5 °C

Probe: ES3DV3 - SN3213; ConvF(5.02, 5.02, 5.02); Calibrated: 4/15/2009

Sensor-Surface: 3mm (Mechanical Surface Detection)

Electronics: DAE4 Sn649; Calibrated: 1/21/2009

Phantom: SAM Main; Type: SAM 4.0; Serial: TP-1114

Measurement SW: DASY4, V4.7 Build 71; Postprocessing SW: SEMCAD, V1.8 Build 172

Mode: GSM1900, Right Head, Touch, Mid ch, Standard Battery, Slide In

Area Scan (7x10x1): Measurement grid: dx=15mm, dy=15mm

Zoom Scan (5x5x7)/Cube 0: Measurement grid: dx=8mm, dy=8mm, dz=5mm

Reference Value = 2.01 V/m

Peak SAR (extrapolated) = 0.141 W/kg

SAR(1 g) = 0.095 mW/g; SAR(10 g) = 0.061 mW/g

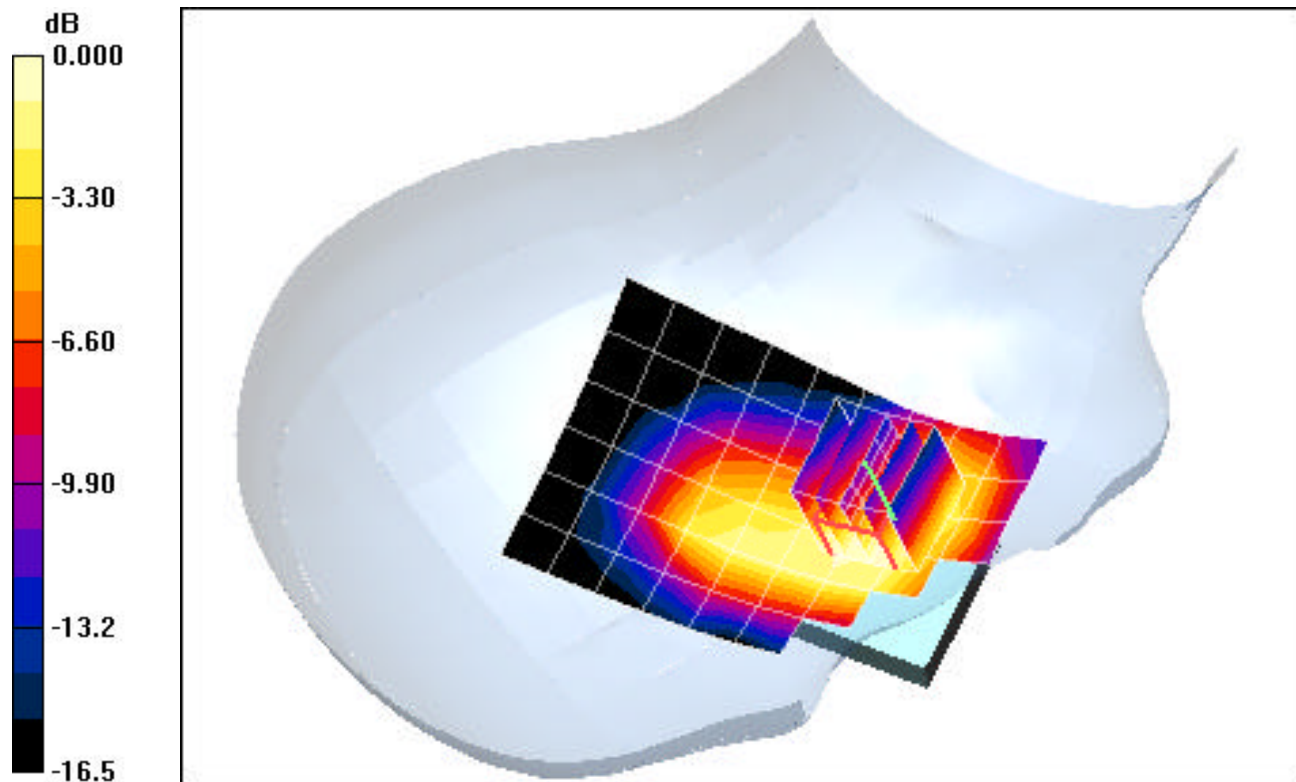

0 dB = 0.109mW/g

PCTEST ENGINEERING LABORATORY, INC.

**DUT: GT -S6700T; Type: 850/1900 GSM/GPRS/EDGE and 850 WCDMA Phone with Bluetooth
S/N: FG-110-A**

Communication System: GSM1900; Frequency: 1880 MHz; Duty Cycle: 1:8.3

Medium: 1900 Brain ($\sigma = 1.37$ mho/m, $\epsilon_r = 40.84$, $\rho = 1000$ kg/m³)

Phantom section: Right Section

Test Date: 05-05-2009; Ambient Temp: 24.3°C; Tissue Temp: 22.5 °C

Probe: ES3DV3 - SN3213; ConvF(5.02, 5.02, 5.02); Calibrated: 4/15/2009

Sensor-Surface: 3mm (Mechanical Surface Detection)

Electronics: DAE4 Sn649; Calibrated: 1/21/2009

Phantom: SAM Main; Type: SAM 4.0; Serial: TP-1114

Measurement SW: DASY4, V4.7 Build 71; Postprocessing SW: SEMCAD, V1.8 Build 172

Mode: GSM1900, Right Head, Tilt, Mid ch, Standard Battery, Slide In

Area Scan (7x10x1): Measurement grid: dx=15mm, dy=15mm

Zoom Scan (5x5x7)/Cube 0: Measurement grid: dx=8mm, dy=8mm, dz=5mm

Reference Value = 4.61 V/m

Peak SAR (extrapolated) = 0.109 W/kg

SAR(1 g) = 0.074 mW/g; SAR(10 g) = 0.044 mW/g

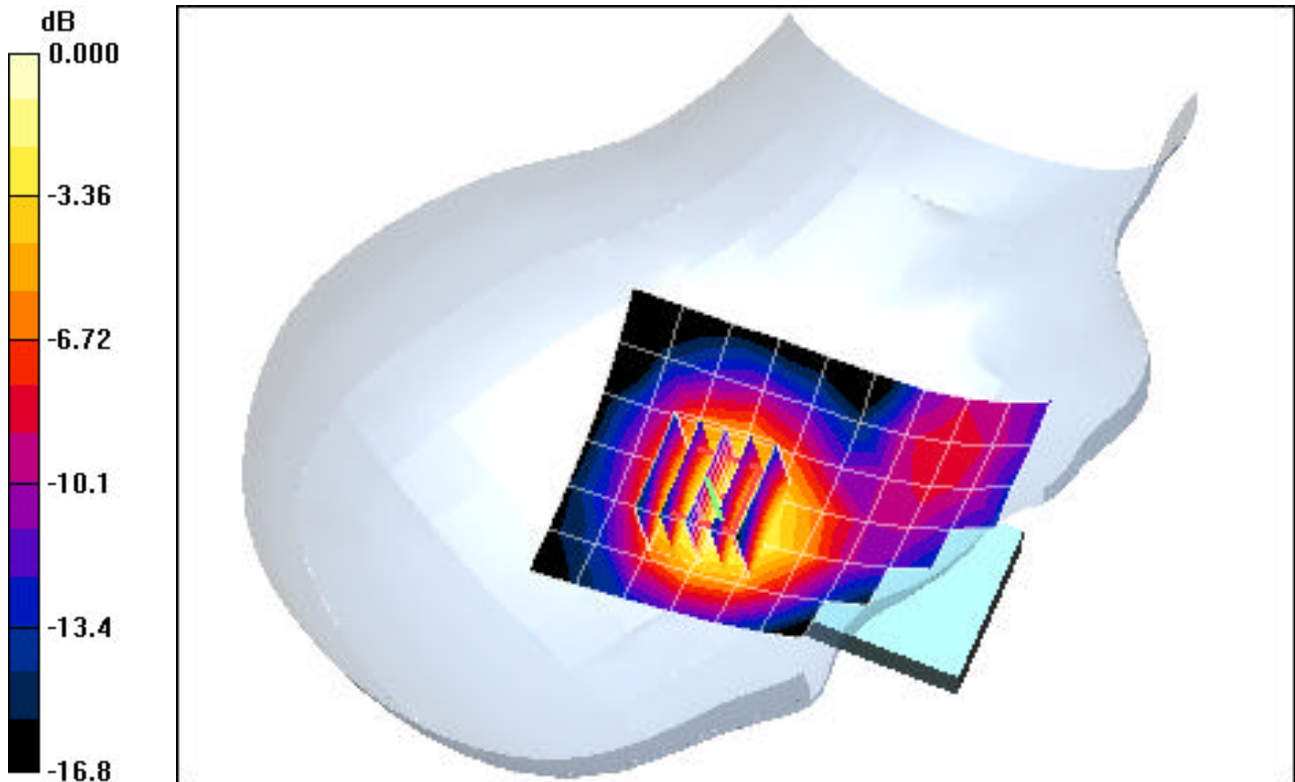

0 dB = 0.087mW/g

PCTEST ENGINEERING LABORATORY, INC.

**DUT: GT-S6700T; Type: 850/1900 GSM/GPRS/EDGE and 850 WCDMA Phone with Bluetooth
S/N: FG-110-A**

Communication System: GSM1900; Frequency: 1880 MHz; Duty Cycle: 1:8.3

Medium: 1900 Brain ($\sigma = 1.37$ mho/m, $\epsilon_r = 40.84$, $\rho = 1000$ kg/m³)

Phantom section: Left Section

Test Date: 05-05-2009; Ambient Temp: 24.3°C; Tissue Temp: 22.5 °C

Probe: ES3DV3 - SN3213; ConvF(5.02, 5.02, 5.02); Calibrated: 4/15/2009

Sensor-Surface: 3mm (Mechanical Surface Detection)

Electronics: DAE4 Sn649; Calibrated: 1/21/2009

Phantom: SAM Main; Type: SAM 4.0; Serial: TP-1114

Measurement SW: DASY4, V4.7 Build 71; Postprocessing SW: SEMCAD, V1.8 Build 172

Mode: GSM1900, Left Head, Touch, Mid ch, Standard Battery, Slide In

Area Scan (7x10x1): Measurement grid: dx=15mm, dy=15mm

Zoom Scan (5x5x7)/Cube 0: Measurement grid: dx=8mm, dy=8mm, dz=5mm

Reference Value = 3.85 V/m

Peak SAR (extrapolated) = 0.182 W/kg

SAR(1 g) = 0.135 mW/g; SAR(10 g) = 0.084 mW/g

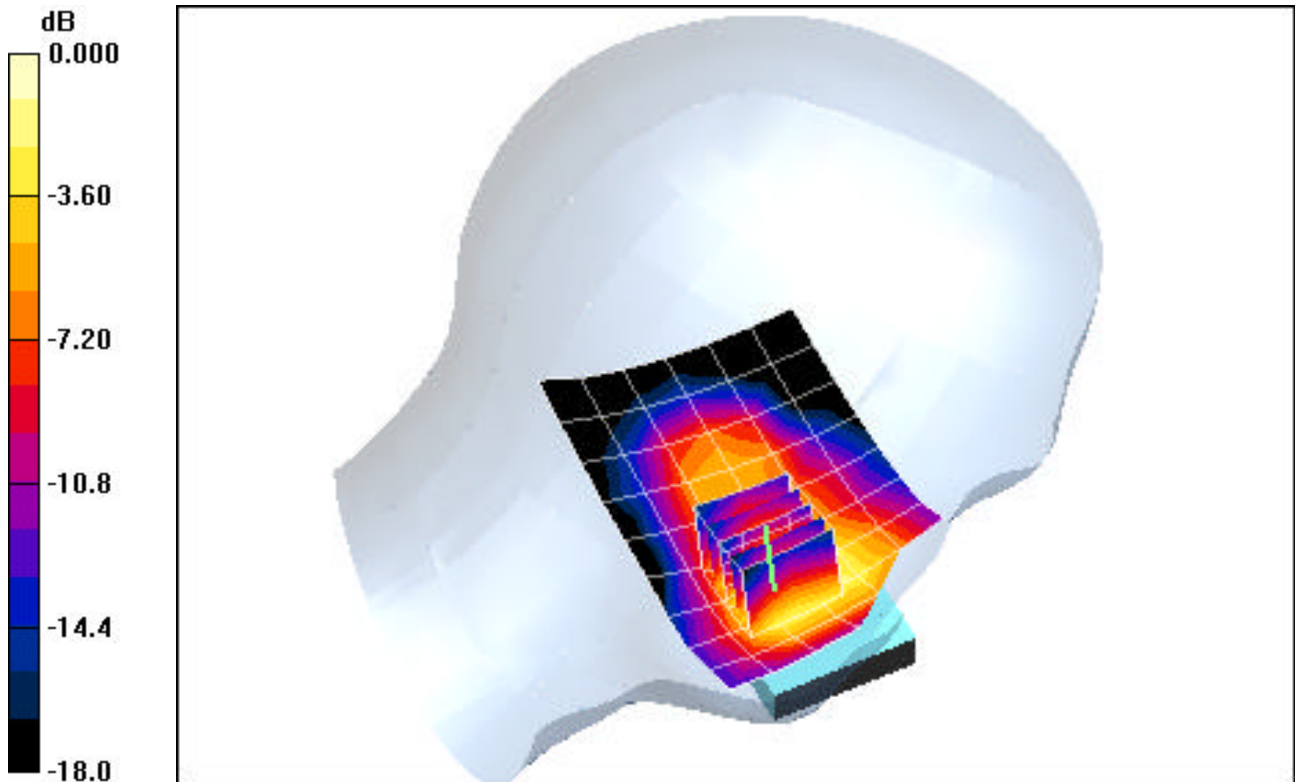

0 dB = 0.153mW/g

PCTEST ENGINEERING LABORATORY, INC.

**DUT: GT-S6700T; Type: 850/1900 GSM/GPRS/EDGE and 850 WCDMA Phone with Bluetooth
S/N: FG-110-A**

Communication System: GSM1900; Frequency: 1880 MHz; Duty Cycle: 1:8.3

Medium: 1900 Brain ($\sigma = 1.37$ mho/m, $\epsilon_r = 40.84$, $\rho = 1000$ kg/m³)

Phantom section: Left Section

Test Date: 05-05-2009; Ambient Temp: 24.3°C; Tissue Temp: 22.5 °C

Probe: ES3DV3 - SN3213; ConvF(5.02, 5.02, 5.02); Calibrated: 4/15/2009

Sensor-Surface: 3mm (Mechanical Surface Detection)

Electronics: DAE4 Sn649; Calibrated: 1/21/2009

Phantom: SAM Main; Type: SAM 4.0; Serial: TP-1114

Measurement SW: DASY4, V4.7 Build 71; Postprocessing SW: SEMCAD, V1.8 Build 172

Mode: GSM1900, Left Head, Tilt, Mid ch, Standard Battery, Slide In

Area Scan (7x10x1): Measurement grid: dx=15mm, dy=15mm

Zoom Scan (5x5x7)/Cube 0: Measurement grid: dx=8mm, dy=8mm, dz=5mm

Reference Value = 5.71 V/m

Peak SAR (extrapolated) = 0.083 W/kg

SAR(1 g) = 0.058 mW/g; SAR(10 g) = 0.036 mW/g

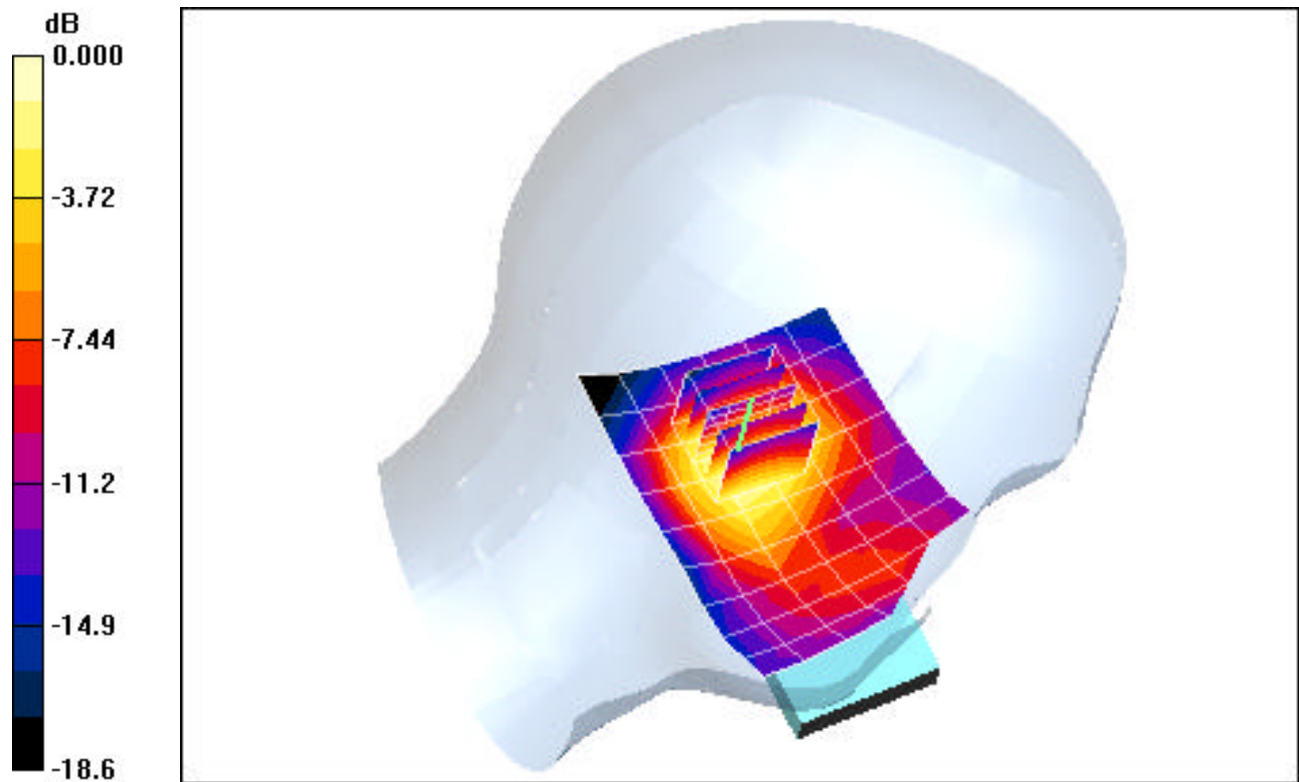

0 dB = 0.068mW/g

PCTEST ENGINEERING LABORATORY, INC.

**DUT: GT -S6700T; Type: 850/1900 GSM/GPRS/EDGE and 850 WCDMA Phone with Bluetooth
S/N: FG-110-A**

Communication System: GSM1900; Frequency: 1880 MHz; Duty Cycle: 1:8.3

Medium: 1900 Brain ($\sigma = 1.37$ mho/m, $\epsilon_r = 40.84$, $\rho = 1000$ kg/m³)

Phantom section: Right Section

Test Date: 05-05-2009; Ambient Temp: 24.3°C; Tissue Temp: 22.5 °C

Probe: ES3DV3 - SN3213; ConvF(5.02, 5.02, 5.02); Calibrated: 4/15/2009

Sensor-Surface: 3mm (Mechanical Surface Detection)

Electronics: DAE4 Sn649; Calibrated: 1/21/2009

Phantom: SAM Main; Type: SAM 4.0; Serial: TP-1114

Measurement SW: DASY4, V4.7 Build 71; Postprocessing SW: SEMCAD, V1.8 Build 172

Mode: GSM1900, Right Head, Touch, Mid ch, Standard Battery, Slide Out

Area Scan (7x12x1): Measurement grid: dx=15mm, dy=15mm

Zoom Scan (5x5x7)/Cube 0: Measurement grid: dx=8mm, dy=8mm, dz=5mm

Reference Value = 1.50 V/m

Peak SAR (extrapolated) = 0.099 W/kg

SAR(1 g) = 0.071 mW/g; SAR(10 g) = 0.046 mW/g

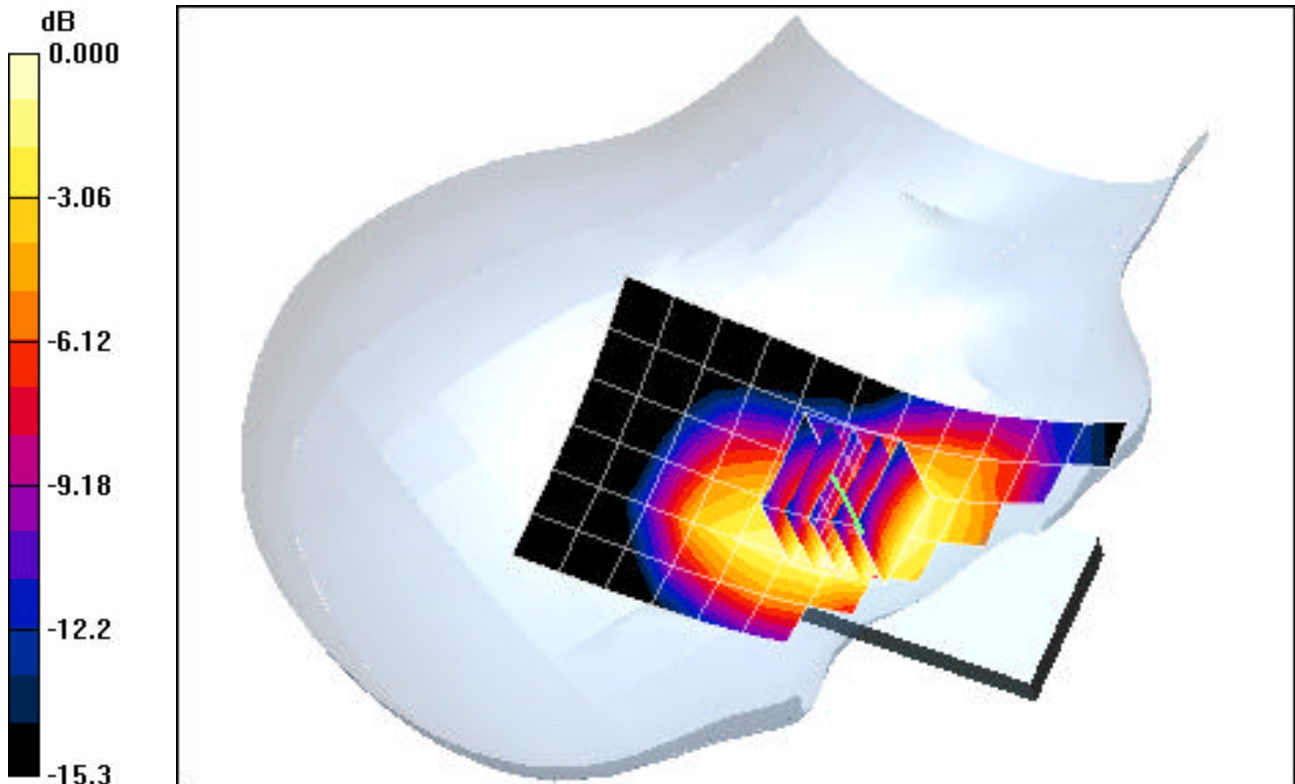

0 dB = 0.081mW/g

PCTEST ENGINEERING LABORATORY, INC.

**DUT: GT-S6700T; Type: 850/1900 GSM/GPRS/EDGE and 850 WCDMA Phone with Bluetooth
S/N: FG-110-A**

Communication System: GSM1900; Frequency: 1880 MHz; Duty Cycle: 1:8.3

Medium: 1900 Brain ($\sigma = 1.37$ mho/m, $\epsilon_r = 40.84$, $\rho = 1000$ kg/m³)

Phantom section: Right Section

Test Date: 05-05-2009; Ambient Temp: 24.3°C; Tissue Temp: 22.5 °C

Probe: ES3DV3 - SN3213; ConvF(5.02, 5.02, 5.02); Calibrated: 4/15/2009

Sensor-Surface: 3mm (Mechanical Surface Detection)

Electronics: DAE4 Sn649; Calibrated: 1/21/2009

Phantom: SAM Main; Type: SAM 4.0; Serial: TP-1114

Measurement SW: DASY4, V4.7 Build 71; Postprocessing SW: SEMCAD, V1.8 Build 172

Mode: GSM1900, Right Head, Tilt, Mid ch, Standard Battery, Slide Out

Area Scan (7x12x1): Measurement grid: dx=15mm, dy=15mm

Zoom Scan (5x5x7)/Cube 0: Measurement grid: dx=8mm, dy=8mm, dz=5mm

Reference Value = 3.79 V/m

Peak SAR (extrapolated) = 0.079 W/kg

SAR(1 g) = 0.053 mW/g; SAR(10 g) = 0.032 mW/g

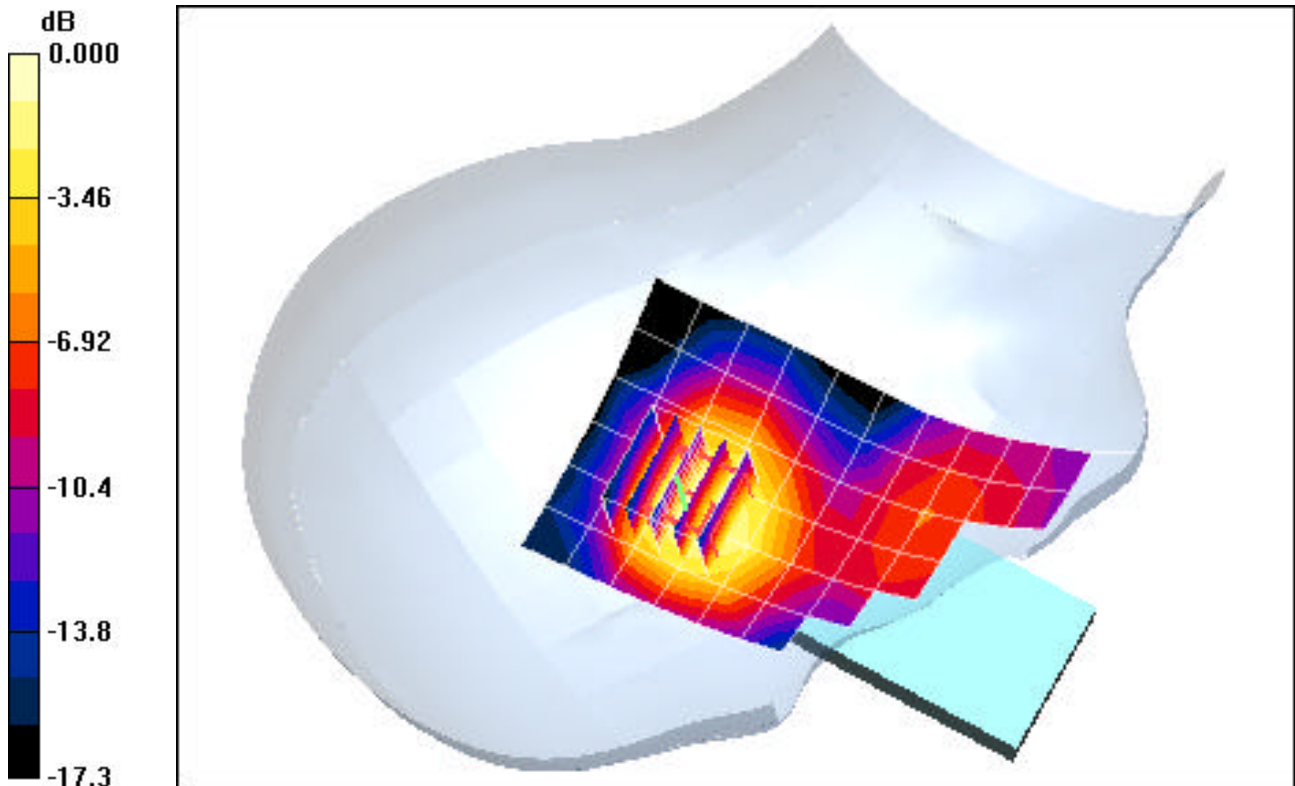

0 dB = 0.061mW/g

PCTEST ENGINEERING LABORATORY, INC.

**DUT: GT-S6700T; Type: 850/1900 GSM/GPRS/EDGE and 850 WCDMA Phone with Bluetooth
S/N: FG-110-A**

Communication System: GSM1900; Frequency: 1880 MHz; Duty Cycle: 1:8.3

Medium: 1900 Brain ($\sigma = 1.37$ mho/m, $\epsilon_r = 40.84$, $\rho = 1000$ kg/m³)

Phantom section: Left Section

Test Date: 05-05-2009; Ambient Temp: 24.3°C; Tissue Temp: 22.5 °C

Probe: ES3DV3 - SN3213; ConvF(5.02, 5.02, 5.02); Calibrated: 4/15/2009

Sensor-Surface: 3mm (Mechanical Surface Detection)

Electronics: DAE4 Sn649; Calibrated: 1/21/2009

Phantom: SAM Main; Type: SAM 4.0; Serial: TP-1114

Measurement SW: DASY4, V4.7 Build 71; Postprocessing SW: SEMCAD, V1.8 Build 172

Mode: GSM1900, Left Head, Touch, Mid ch, Standard Battery, Slide Out

Area Scan (7x12x1): Measurement grid: dx=15mm, dy=15mm

Zoom Scan (5x5x7)/Cube 0: Measurement grid: dx=8mm, dy=8mm, dz=5mm

Reference Value = 2.18 V/m

Peak SAR (extrapolated) = 0.128 W/kg

SAR(1 g) = 0.088 mW/g; SAR(10 g) = 0.054 mW/g

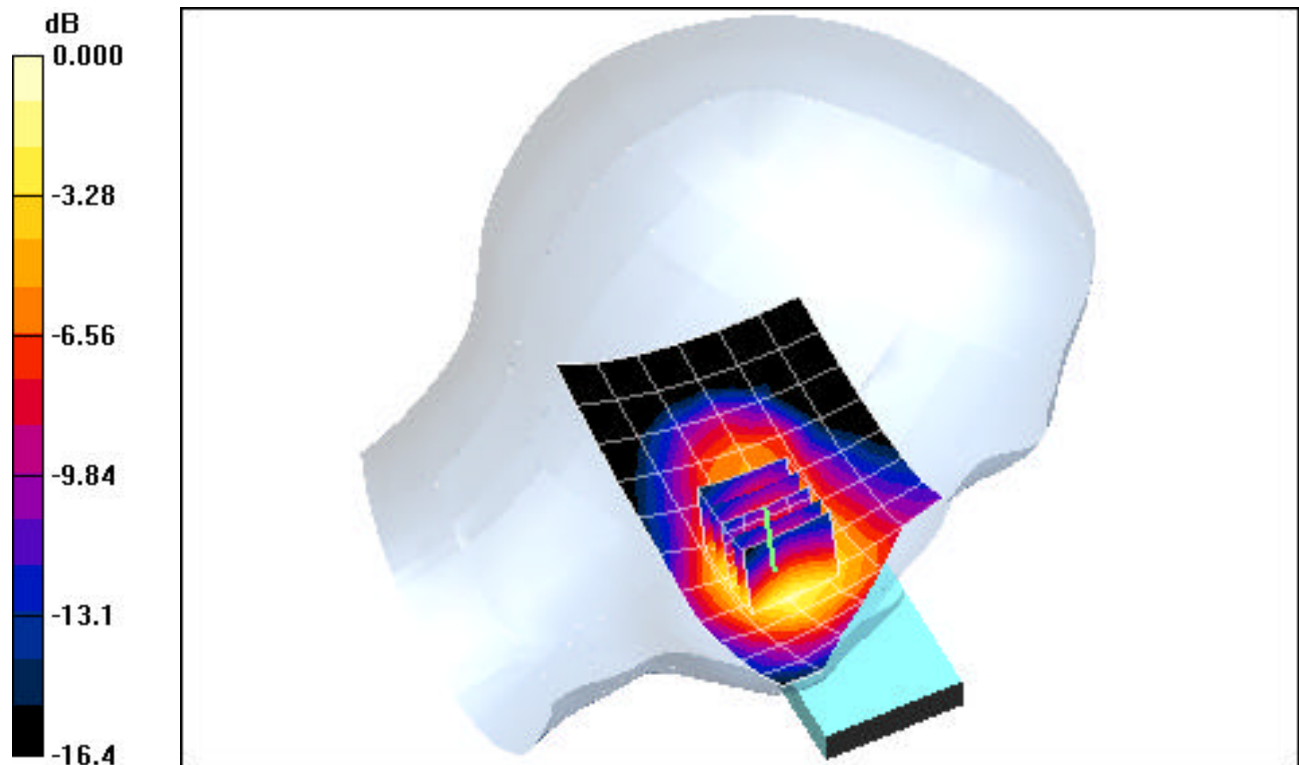

0 dB = 0.102mW/g

PCTEST ENGINEERING LABORATORY, INC.

**DUT: GT-S6700T; Type: 850/1900 GSM/GPRS/EDGE and 850 WCDMA Phone with Bluetooth
S/N: FG-110-A**

Communication System: GSM1900; Frequency: 1880 MHz; Duty Cycle: 1:8.3

Medium: 1900 Brain ($\sigma = 1.37$ mho/m, $\epsilon_r = 40.84$, $\rho = 1000$ kg/m³)

Phantom section: Left Section

Test Date: 05-05-2009; Ambient Temp: 24.3°C; Tissue Temp: 22.5 °C

Probe: ES3DV3 - SN3213; ConvF(5.02, 5.02, 5.02); Calibrated: 4/15/2009

Sensor-Surface: 3mm (Mechanical Surface Detection)

Electronics: DAE4 Sn649; Calibrated: 1/21/2009

Phantom: SAM Main; Type: SAM 4.0; Serial: TP-1114

Measurement SW: DASY4, V4.7 Build 71; Postprocessing SW: SEMCAD, V1.8 Build 172

Mode: GSM1900, Left Head, Tilt, Mid ch, Standard Battery, Slide Out

Area Scan (7x12x1): Measurement grid: dx=15mm, dy=15mm

Zoom Scan (5x5x7)/Cube 0: Measurement grid: dx=8mm, dy=8mm, dz=5mm

Reference Value = 4.35 V/m

Peak SAR (extrapolated) = 0.063 W/kg

SAR(1 g) = 0.043 mW/g; SAR(10 g) = 0.027 mW/g

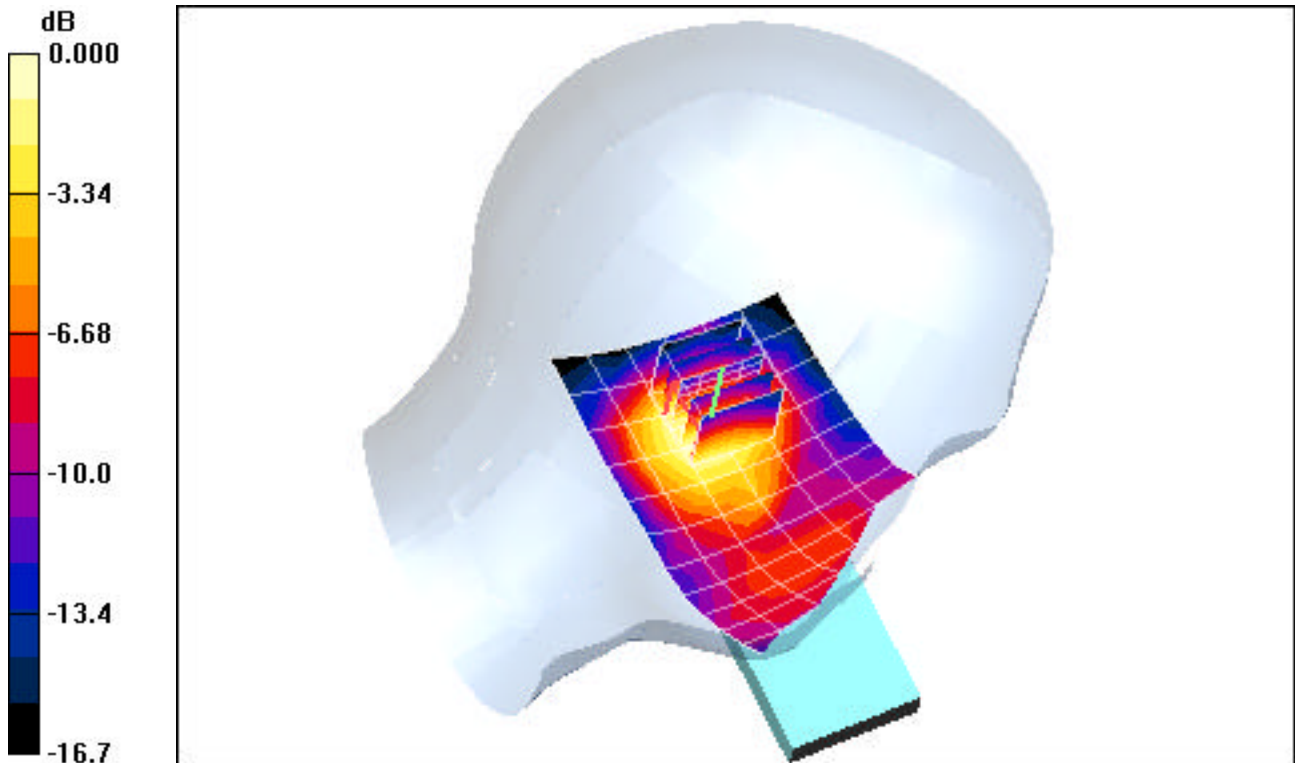

0 dB = 0.050mW/g

PCTEST ENGINEERING LABORATORY, INC.

**DUT: GT-S6700T; Type: 850/1900 GSM/GPRS/EDGE and 850 WCDMA Phone with Bluetooth
S/N: FG-110-A**

Communication System: GSM850 GPRS; 2 Tx slots; Frequency: 824.2 MHz; Duty Cycle: 1:4.15
Medium: 835 Muscle ($\sigma = 0.99$ mho/m, $\epsilon_r = 55.30$, $\rho = 1000$ kg/m³)kg/m³
Phantom section: Flat Section; Space: 1.5 cm

Test Date: 05-04-2009; Ambient Temp: 24.7°C; Tissue Temp: 22.9 °C

Probe: ES3DV3 - SN3213; ConvF(5.92, 5.92, 5.92); Calibrated: 4/15/2009

Sensor-Surface: 3mm (Mechanical Surface Detection)

Electronics: DAE4 Sn649; Calibrated: 1/21/2009

Phantom: SAM Sub; Type: SAM 4.0; Serial: TP-1357

Measurement SW: DASY4, V4.7 Build 71; Postprocessing SW: SEMCAD, V1.8 Build 172

Mode: GSM850 GPRS, Body SAR, Back Side, Low ch, Standard Battery, 2Tx Slots

Area Scan (7x10x1): Measurement grid: dx=15mm, dy=15mm

Zoom Scan (5x5x7)/Cube 0: Measurement grid: dx=8mm, dy=8mm, dz=5mm

Reference Value = 32.0 V/m

Peak SAR (extrapolated) = 1.36 W/kg

SAR(1 g) = 0.989 mW/g; SAR(10 g) = 0.698 mW/g

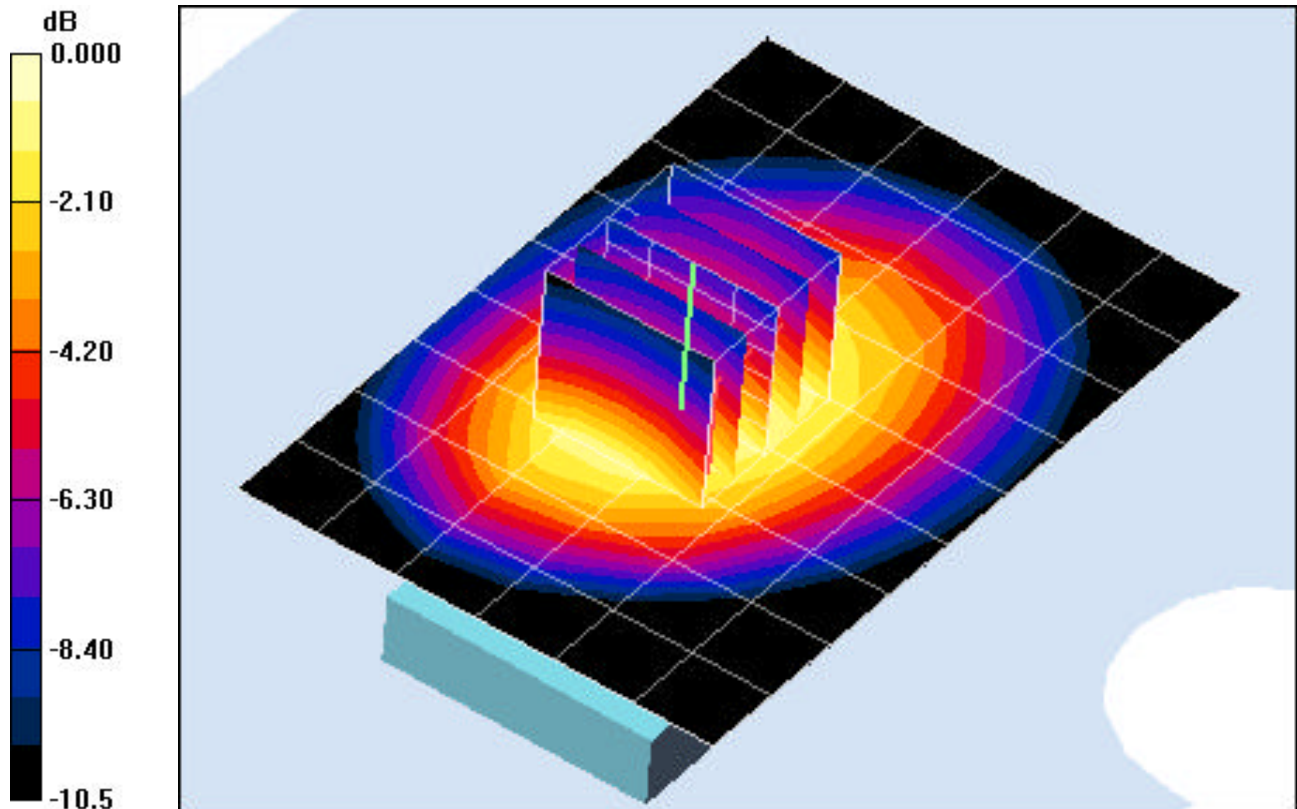

0 dB = 1.11mW/g

PCTEST ENGINEERING LABORATORY, INC.

**DUT: GT-S6700T; Type: 850/1900 GSM/GPRS/EDGE and 850 WCDMA Phone with Bluetooth
S/N: FG-110-A**

Communication System: WCDMA850; Frequency: 836.6 MHz; Duty Cycle: 1:1
Medium: 835 Muscle ($\sigma = 0.99$ mho/m, $\epsilon_r = 55.30$, $\rho = 1000$ kg/m³)
Phantom section: Flat Section; Space: 1.5 cm

Test Date: 05-04-2009; Ambient Temp: 24.7°C; Tissue Temp: 22.9 °C

Probe: ES3DV3 - SN3213; ConvF(5.92, 5.92, 5.92); Calibrated: 4/15/2009
Sensor-Surface: 3mm (Mechanical Surface Detection)
Electronics: DAE4 Sn649; Calibrated: 1/21/2009
Phantom: SAM Sub; Type: SAM 4.0; Serial: TP-1357
Measurement SW: DASY4, V4.7 Build 71; Postprocessing SW: SEMCAD, V1.8 Build 172

Mode: WCDMA 850, Body SAR, Back Side, Mid ch, Standard Battery

Area Scan (7x10x1): Measurement grid: dx=15mm, dy=15mm

Zoom Scan (5x5x7)/Cube 0: Measurement grid: dx=8mm, dy=8mm, dz=5mm

Reference Value = 21.0 V/m

Peak SAR (extrapolated) = 0.595 W/kg

SAR(1 g) = 0.432 mW/g; SAR(10 g) = 0.304 mW/g

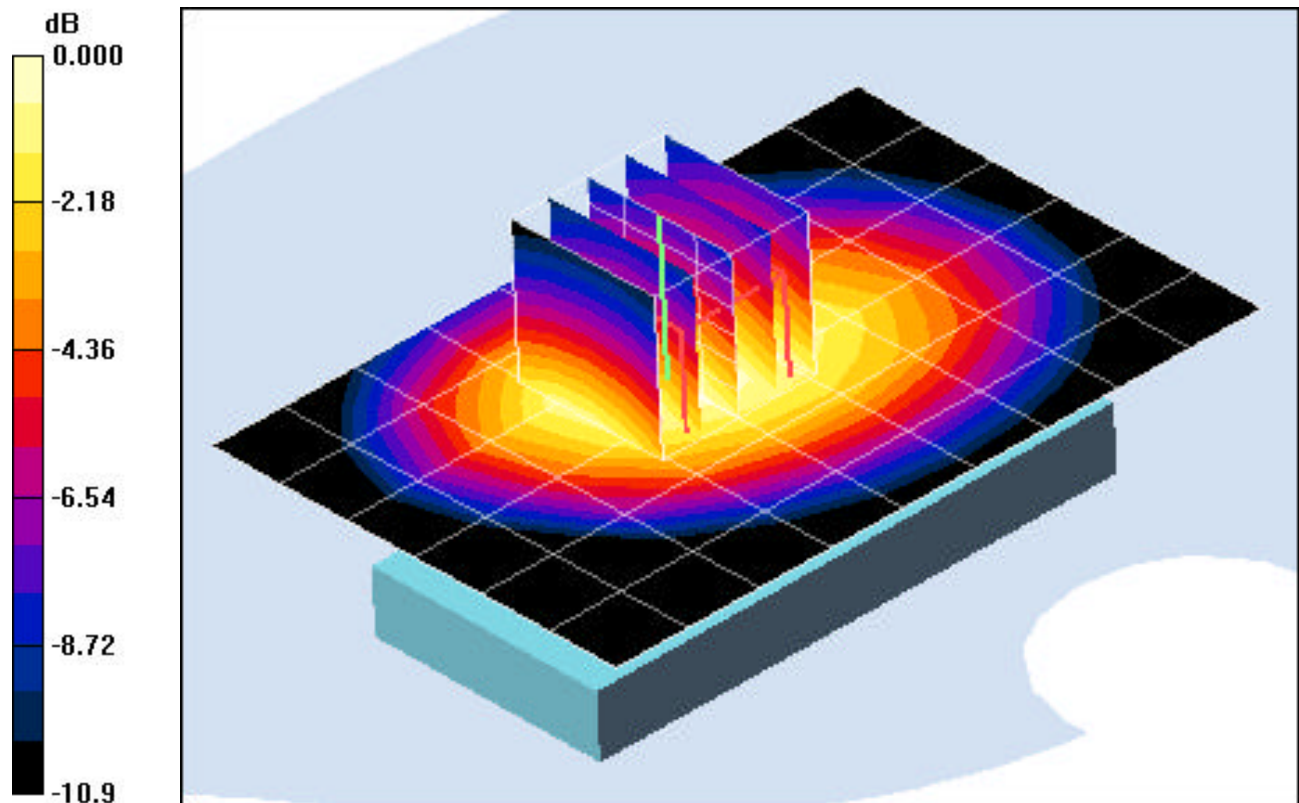

0 dB = 0.493mW/g

PCTEST ENGINEERING LABORATORY, INC.

**DUT: GT-S6700T; Type: 850/1900 GSM/GPRS/EDGE and 850 WCDMA Phone with Bluetooth
S/N: FG-110-A**

Communication System: GSM1900 GPRS; 2 Tx slots; Frequency: 1880 MHz; Duty Cycle: 1:4.15
Medium: 1900 Muscle ($\sigma = 1.51$ mho/m, $\epsilon_r = 54.04$, $\rho = 1000$ kg/m³)
Phantom section: Flat Section; Space: 1.5 cm

Test Date: 05-05-2009; Ambient Temp: 24.5°C; Tissue Temp: 22.8°C

Probe: ES3DV3 - SN3213; ConvF(4.52, 4.52, 4.52); Calibrated: 4/15/2009

Sensor-Surface: 3mm (Mechanical Surface Detection)

Electronics: DAE4 Sn649; Calibrated: 1/21/2009

Phantom: SAM Sub; Type: SAM 4.0; Serial: TP-1357

Measurement SW: DASY4, V4.7 Build 71; Postprocessing SW: SEMCAD, V1.8 Build 172

Mode: GSM1900 GPRS, Body SAR, Back Side, Mid ch, Standard Battery, 2Tx Slots

Area Scan (7x10x1): Measurement grid: dx=15mm, dy=15mm

Zoom Scan (5x5x7)/Cube 0: Measurement grid: dx=8mm, dy=8mm, dz=5mm

Reference Value = 12.1 V/m

Peak SAR (extrapolated) = 0.799 W/kg

SAR(1 g) = 0.471 mW/g; SAR(10 g) = 0.270 mW/g

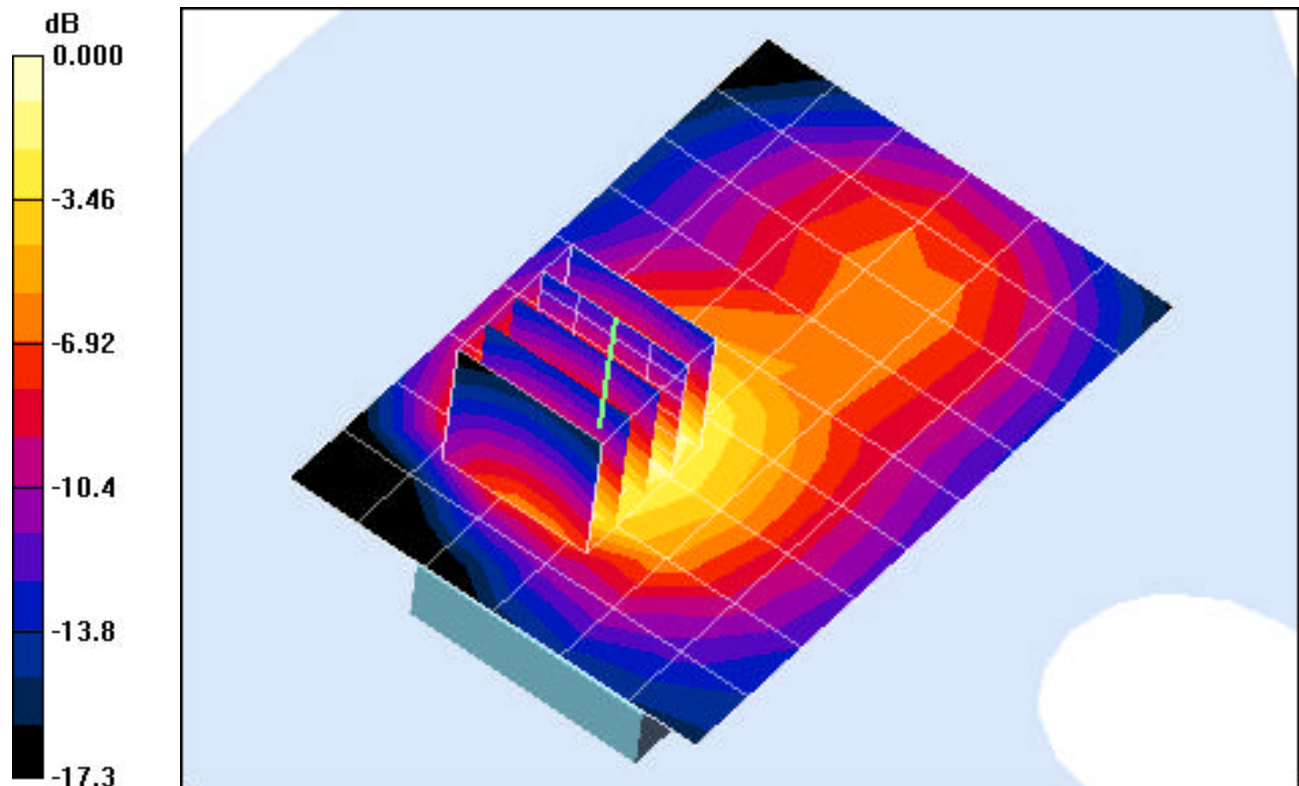

0 dB = 0.568mW/g

PCTEST ENGINEERING LABORATORY, INC.

**DUT: GT-S6700T; Type: 850/1900 GSM/GPRS/EDGE and 850 WCDMA Phone with Bluetooth
S/N: FG- 110-A**

Communication System: GSM850; Frequency: 836.6 MHz; Duty Cycle: 1:8.3

Medium: 835 Brain ($\sigma = 0.87$ mho/m, $\epsilon_r = 39.90$, $\rho = 1000$ kg/m³)

Phantom section: Right Section

Test Date: 05-04-2009; Ambient Temp: 24.6°C; Tissue Temp: 22.7 °C

Probe: ES3DV3 - SN3213; ConvF(5.94, 5.94, 5.94); Calibrated: 4/15/2009

Sensor-Surface: 3mm (Mechanical Surface Detection)

Electronics: DAE4 Sn649; Calibrated: 1/21/2009

Phantom: SAM Main; Type: SAM 4.0; Serial: TP-1114

Measurement SW: DASY4, V4.7 Build 71; Postprocessing SW: SEMCAD, V1.8 Build 172

Mode: GSM850, Right Head, Touch, Mid ch, Standard Battery, Slide In

Area Scan (7x10x1): Measurement grid: dx=15mm, dy=15mm

Zoom Scan (5x5x7)/Cube 0: Measurement grid: dx=8mm, dy=8mm, dz=5mm

Reference Value = 4.05 V/m

Peak SAR (extrapolated) = 0.633 W/kg

SAR(1 g) = 0.440 mW/g; SAR(10 g) = 0.309 mW/g

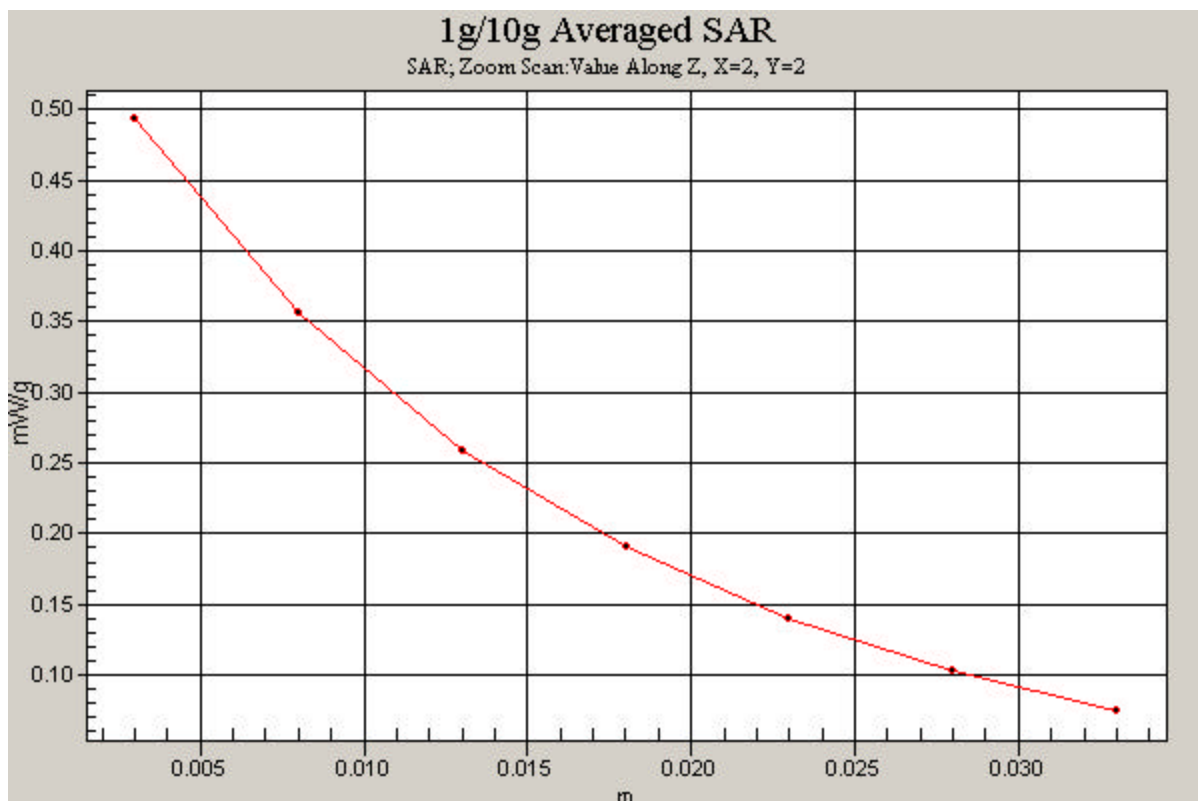

PCTEST ENGINEERING LABORATORY, INC.

**DUT: GT-S6700T; Type: 850/1900 GSM/GPRS/EDGE and 850 WCDMA Phone with Bluetooth
S/N: FG-110-A**

Communication System: GSM850 GPRS; 2 Tx slots; Frequency: 824.2 MHz; Duty Cycle: 1:4.15
Medium: 835 Muscle ($\sigma = 0.99$ mho/m, $\epsilon_r = 55.30$, $\rho = 1000$ kg/m³) kg/m³
Phantom section: Flat Section; Space: 1.5 cm

Test Date: 05-04-2009; Ambient Temp: 24.7°C; Tissue Temp: 22.9 °C

Probe: ES3DV3 - SN3213; ConvF(5.92, 5.92, 5.92); Calibrated: 4/15/2009

Sensor-Surface: 3mm (Mechanical Surface Detection)

Electronics: DAE4 Sn649; Calibrated: 1/21/2009

Phantom: SAM Sub; Type: SAM 4.0; Serial: TP-1357

Measurement SW: DASY4, V4.7 Build 71; Postprocessing SW: SEMCAD, V1.8 Build 172

Mode: GSM850 GPRS, Body SAR, Back Side, Low ch, Standard Battery, 2Tx Slots

Area Scan (7x10x1): Measurement grid: dx=15mm, dy=15mm

Zoom Scan (5x5x7)/Cube 0: Measurement grid: dx=8mm, dy=8mm, dz=5mm

Reference Value = 32.0 V/m

Peak SAR (extrapolated) = 1.36 W/kg

SAR(1 g) = 0.989 mW/g; SAR(10 g) = 0.698 mW/g

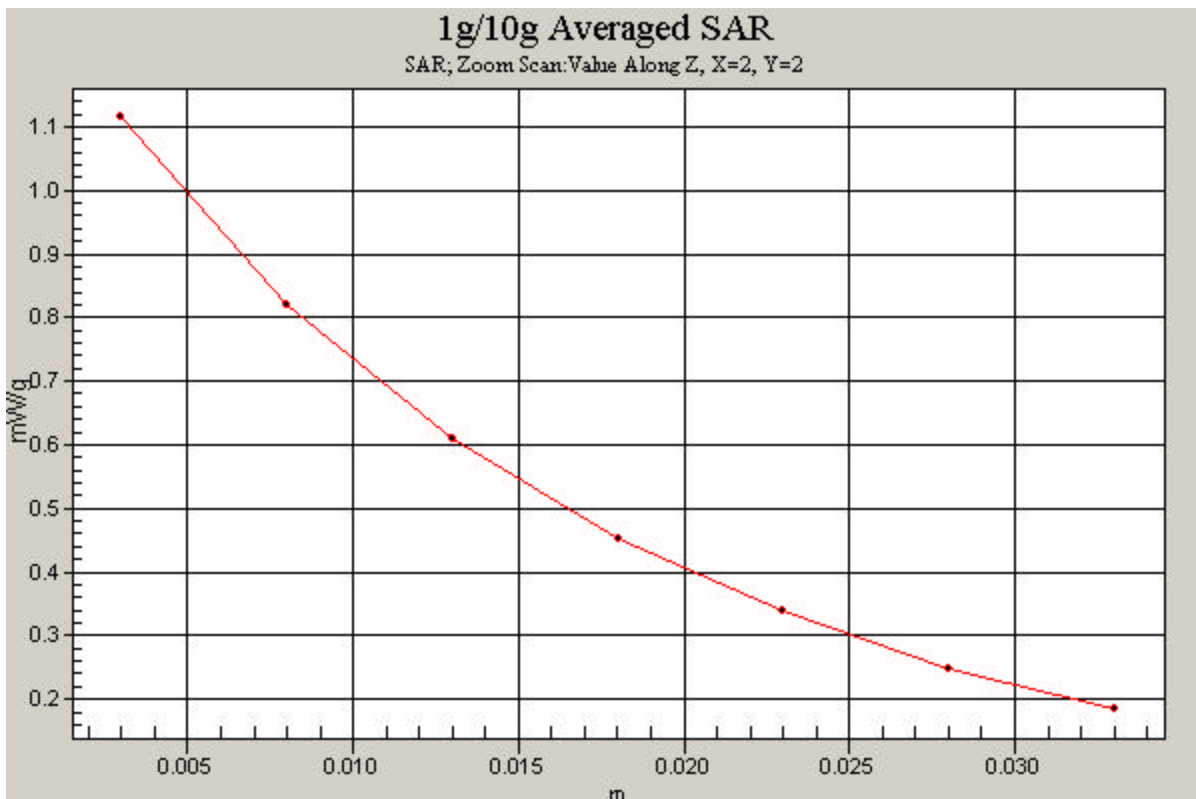

PCTEST ENGINEERING LABORATORY, INC.

**DUT: GT-S6700T; Type: 850/1900 GSM/GPRS/EDGE and 850 WCDMA Phone with Bluetooth
S/N: FG-110-A**

Communication System: GSM1900; Frequency: 1880 MHz; Duty Cycle: 1:8.3

Medium: 1900 Brain ($\sigma = 1.37$ mho/m, $\epsilon_r = 40.84$, $\rho = 1000$ kg/m³)

Phantom section: Left Section

Test Date: 05-05-2009; Ambient Temp: 24.3°C; Tissue Temp: 22.5 °C

Probe: ES3DV3 - SN3213; ConvF(5.02, 5.02, 5.02); Calibrated: 4/15/2009

Sensor-Surface: 3mm (Mechanical Surface Detection)

Electronics: DAE4 Sn649; Calibrated: 1/21/2009

Phantom: SAM Main; Type: SAM 4.0; Serial: TP-1114

Measurement SW: DASY4, V4.7 Build 71; Postprocessing SW: SEMCAD, V1.8 Build 172

Mode: GSM1900, Left Head, Touch, Mid ch, Standard Battery, Slide In

Area Scan (7x10x1): Measurement grid: dx=15mm, dy=15mm

Zoom Scan (5x5x7)/Cube 0: Measurement grid: dx=8mm, dy=8mm, dz=5mm

Reference Value = 3.85 V/m

Peak SAR (extrapolated) = 0.182 W/kg

SAR(1 g) = 0.135 mW/g; SAR(10 g) = 0.084 mW/g

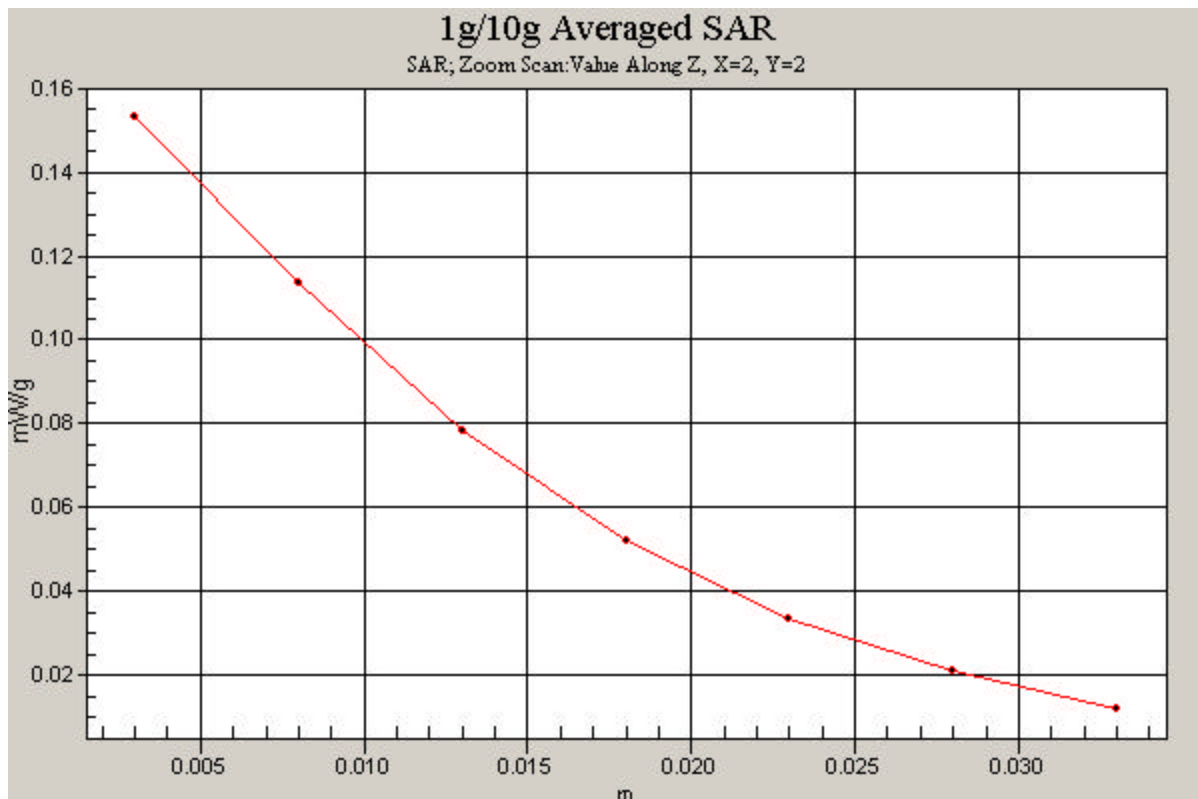

PCTEST ENGINEERING LABORATORY, INC.

**DUT: GT-S6700T; Type: 850/1900 GSM/GPRS/EDGE and 850 WCDMA Phone with Bluetooth
S/N: FG-110-A**

Communication System: GSM1900 GPRS; 2 Tx slots; Frequency: 1880 MHz; Duty Cycle: 1:4.15

Medium: 1900 Muscle ($\sigma = 1.51$ mho/m, $\epsilon_r = 54.04$, $\rho = 1000$ kg/m³)³

Phantom section: Flat Section; Space: 1.5 cm

Test Date: 05-05-2009; Ambient Temp: 24.5°C; Tissue Temp: 22.8°C

Probe: ES3DV3 - SN3213; ConvF(4.52, 4.52, 4.52); Calibrated: 4/15/2009

Sensor-Surface: 3mm (Mechanical Surface Detection)

Electronics: DAE4 Sn649; Calibrated: 1/21/2009

Phantom: SAM Sub; Type: SAM 4.0; Serial: TP-1357

Measurement SW: DASY4, V4.7 Build 71; Postprocessing SW: SEMCAD, V1.8 Build 172

Mode: GSM1900 GPRS, Body SAR, Back Side, Mid ch, Standard Battery, 2Tx Slots

Area Scan (7x10x1): Measurement grid: dx=15mm, dy=15mm

Zoom Scan (5x5x7)/Cube 0: Measurement grid: dx=8mm, dy=8mm, dz=5mm

Reference Value = 12.1 V/m

Peak SAR (extrapolated) = 0.799 W/kg

SAR(1 g) = 0.471 mW/g; SAR(10 g) = 0.270 mW/g

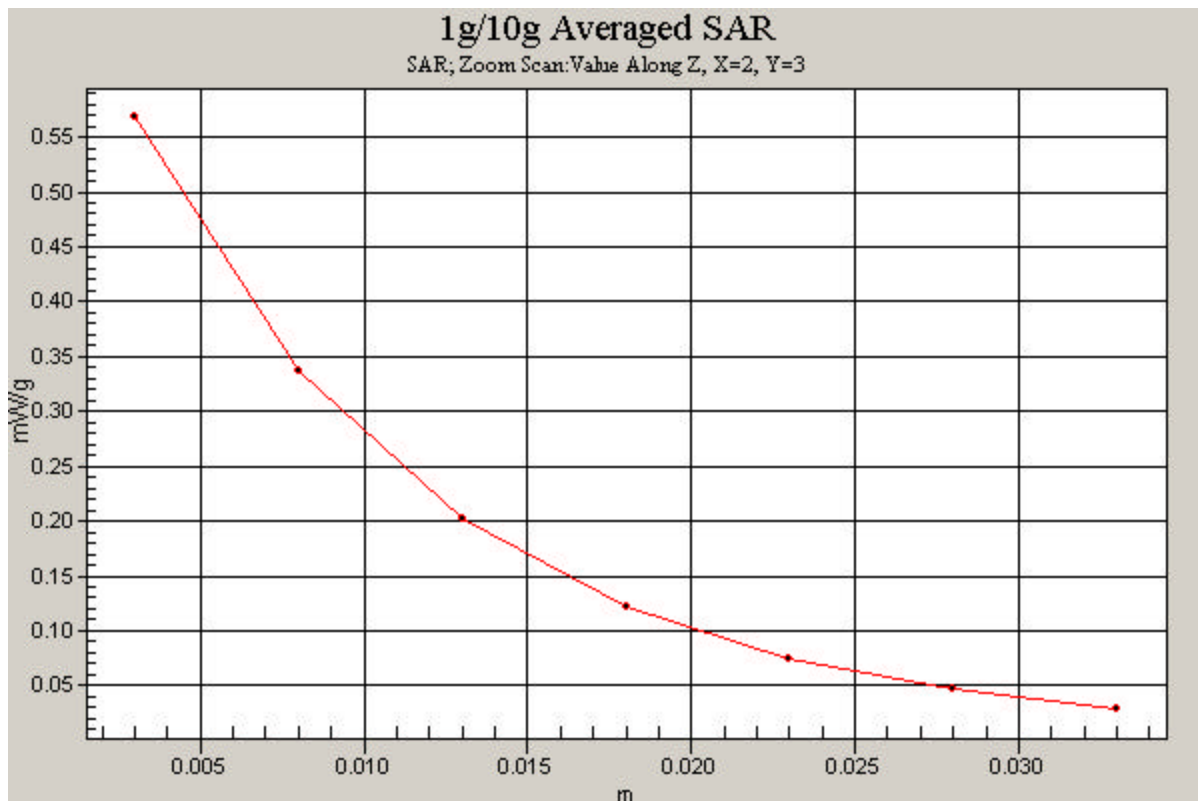

APPENDIX B: DIPOLE VALIDATION

PCTEST ENGINEERING LABORATORY, INC.

DUT: 835MHz SAR Validation Dipole; Type: D835V2; Serial: 4d026

Communication System: CW; Frequency: 835 MHz; Duty Cycle: 1:1

Medium: 835 Brain ($\sigma = 0.87$ mho/m, $\epsilon_r = 39.90$, $\rho = 1000$ kg/m³)

Phantom section: Flat Section; Space: 1.5 cm

Test Date: 05-04-2009; Ambient Temp: 24.6°C; Tissue Temp: 22.7 °C

Probe: ES3DV3 - SN3213; ConvF(5.94, 5.94, 5.94); Calibrated: 4/15/2009

Sensor-Surface: 3mm (Mechanical Surface Detection)

Electronics: DAE4 Sn649; Calibrated: 1/21/2009

Phantom: SAM Main; Type: SAM 4.0; Serial: TP-1114

Measurement SW: DASY4, V4.7 Build 71; Postprocessing SW: SEMCAD, V1.8 Build 172

835MHz SAR Dipole Validation

Area Scan (7x13x1): Measurement grid: dx=15mm, dy=15mm

Zoom Scan (5x5x7)/Cube 0: Measurement grid: dx=8mm, dy=8mm, dz=5mm

Input Power = 20.0 dBm (100 mW)

SAR(1 g) = 0.928 mW/g; SAR(10 g) = 0.601 mW/g

Deviation = 3.0 %

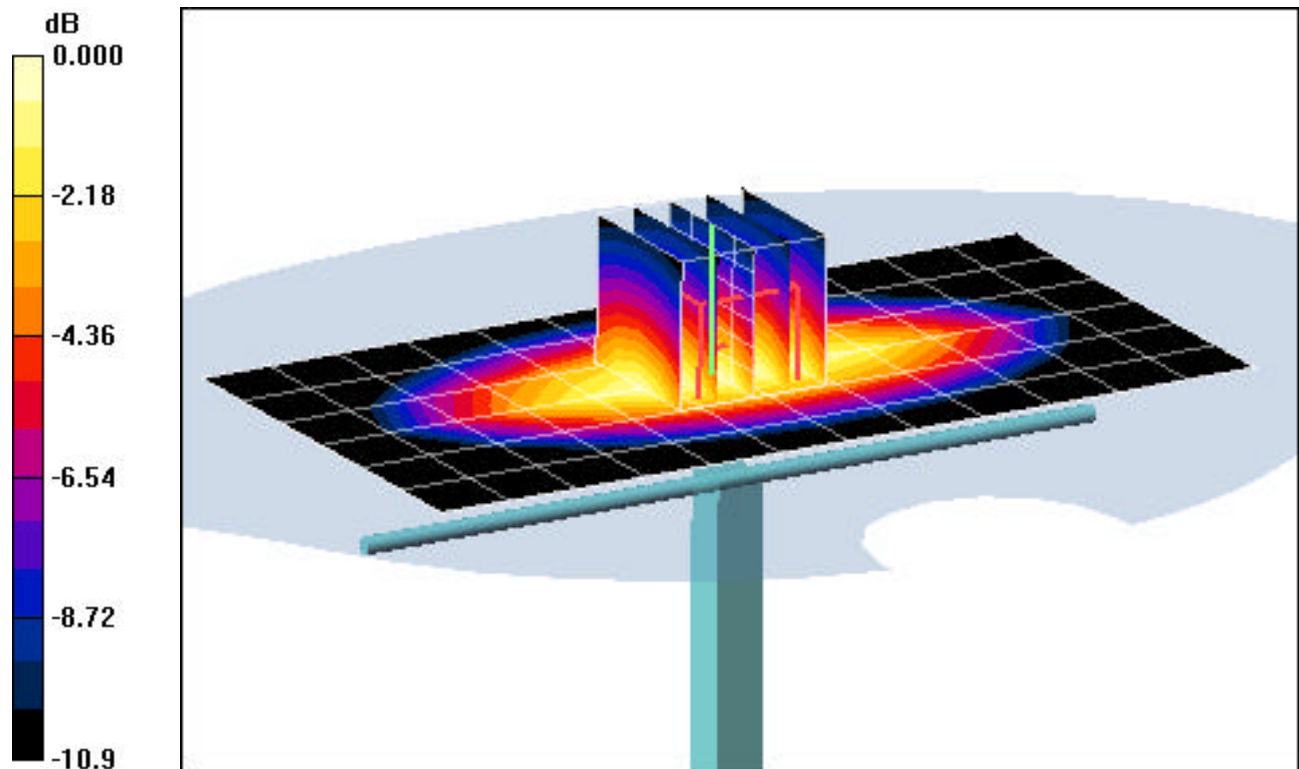

0 dB = 1.10mW/g

PCTEST ENGINEERING LABORATORY, INC.

DUT: 1900MHz SAR Validation Dipole; Type: D1900V2; Serial: 502

Communication System: CW; Frequency: 1900 MHz; Duty Cycle: 1:1

Medium: 1900 Brain ($\sigma = 1.37$ mho/m, $\epsilon_r = 40.84$, $\rho = 1000$ kg/m³)

Phantom section: Flat Section; Space: 1.0 cm

Test Date: 05-05-2009; Ambient Temp: 24.3°C; Tissue Temp: 22.5 °C

Probe: ES3DV3 - SN3213; ConvF(5.02, 5.02, 5.02); Calibrated: 4/15/2009

Sensor-Surface: 3mm (Mechanical Surface Detection)

Electronics: DAE4 Sn649; Calibrated: 1/21/2009

Phantom: SAM Main; Type: SAM 4.0; Serial: TP-1114

Measurement SW: DASY4, V4.7 Build 71; Postprocessing SW: SEMCAD, V1.8 Build 172

1900MHz SAR Dipole Validation

Area Scan (5x7x1): Measurement grid: dx=15mm, dy=15mm

Zoom Scan (5x5x7)/Cube 0: Measurement grid: dx=8mm, dy=8mm, dz=5mm

Input Power = 20.0 dBm (100 mW)

SAR(1 g) = 4.17 mW/g; SAR(10 g) = 2.15 mW/g

Deviation = 4.51 %

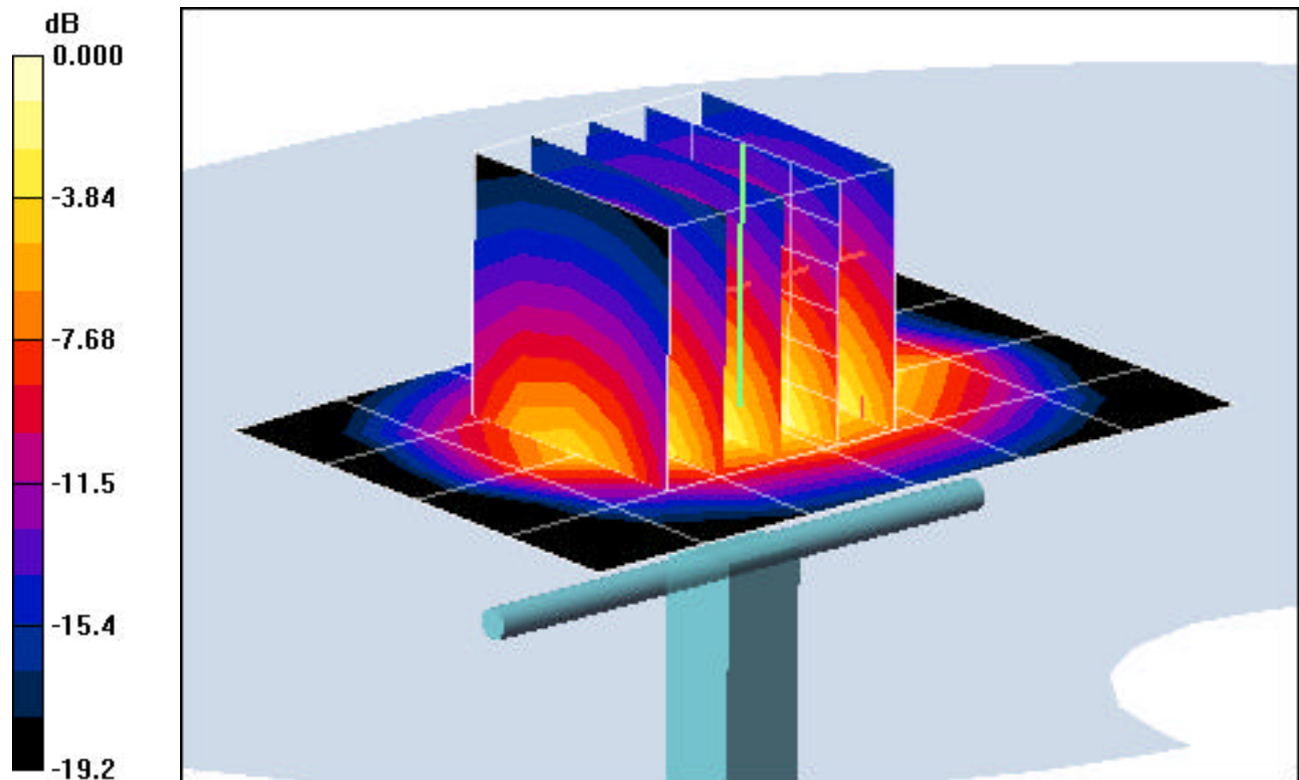

0 dB = 5.29mW/g

APPENDIX C: PROBE CALIBRATION



Accredited by the Swiss Accreditation Service (SAS)
The Swiss Accreditation Service is one of the signatories to the EA
Multilateral Agreement for the recognition of calibration certificates

Accreditation No.: SCS 108

Client **PC Test**

Certificate No: **ES3-3213_Apr09**

CALIBRATION CERTIFICATE

Object **ES3DV3 - SN:3213**

Calibration procedure(s) **QA CAL-01.v6 and QA CAL-23.v3
Calibration procedure for dosimetric E-field probes**

Calibration date: **April 15, 2009**

Condition of the calibrated item **In Tolerance**

*OK
4/23/09
SL*

This calibration certificate documents the traceability to national standards, which realize the physical units of measurements (SI).
The measurements and the uncertainties with confidence probability are given on the following pages and are part of the certificate.

All calibrations have been conducted in the closed laboratory facility: environment temperature (22 ± 3)°C and humidity < 70%.

Calibration Equipment used (M&TE critical for calibration)

Primary Standards	ID #	Cal Date (Certificate No.)	Scheduled Calibration
Power meter E4419B	GB41293874	1-Apr-09 (No. 217-01030)	Apr-10
Power sensor E4412A	MY41495277	1-Apr-09 (No. 217-01030)	Apr-10
Power sensor E4412A	MY41498087	1-Apr-09 (No. 217-01030)	Apr-10
Reference 3 dB Attenuator	SN: S5054 (3c)	31-Mar-09 (No. 217-01026)	Mar-10
Reference 20 dB Attenuator	SN: S5086 (20b)	31-Mar-09 (No. 217-01028)	Mar-10
Reference 30 dB Attenuator	SN: S5129 (30b)	31-Mar-09 (No. 217-01027)	Mar-10
Reference Probe ES3DV2	SN: 3013	2-Jan-09 (No. ES3-3013_Jan09)	Jan-10
DAE4	SN: 660	9-Sep-08 (No. DAE4-660_Sep08)	Sep-09
Secondary Standards	ID #	Check Date (in house)	Scheduled Check
RF generator HP 8648C	US3642U01700	4-Aug-99 (in house check Oct-07)	In house check: Oct-09
Network Analyzer HP 8753E	US37390585	18-Oct-01 (in house check Oct-08)	In house check: Oct-09

Calibrated by:	Name Katja Pokovic	Function Technical Manager	Signature
Approved by:	Name Fin Bornhoff	Function R&D Director	Signature

Issued: April 15, 2009

This calibration certificate shall not be reproduced except in full without written approval of the laboratory.



Accredited by the Swiss Accreditation Service (SAS)
The Swiss Accreditation Service is one of the signatories to the EA
Multilateral Agreement for the recognition of calibration certificates

Accreditation No.: **SCS 108**

Glossary:

TSL	tissue simulating liquid
NORM _{x,y,z}	sensitivity in free space
ConvF	sensitivity in TSL / NORM _{x,y,z}
DCP	diode compression point
Polarization φ	φ rotation around probe axis
Polarization ϑ	ϑ rotation around an axis that is in the plane normal to probe axis (at measurement center), i.e., $\vartheta = 0$ is normal to probe axis

Calibration is Performed According to the Following Standards:

- IEEE Std 1528-2003, "IEEE Recommended Practice for Determining the Peak Spatial-Averaged Specific Absorption Rate (SAR) in the Human Head from Wireless Communications Devices: Measurement Techniques", December 2003
- IEC 62209-1, "Procedure to measure the Specific Absorption Rate (SAR) for hand-held devices used in close proximity to the ear (frequency range of 300 MHz to 3 GHz)", February 2005

Methods Applied and Interpretation of Parameters:

- NORM_{x,y,z}**: Assessed for E-field polarization $\vartheta = 0$ ($f \leq 900$ MHz in TEM-cell; $f > 1800$ MHz: R22 waveguide). NORM_{x,y,z} are only intermediate values, i.e., the uncertainties of NORM_{x,y,z} does not effect the E^2 -field uncertainty inside TSL (see below *ConvF*).
- NORM(f)_{x,y,z}** = NORM_{x,y,z} * *frequency_response* (see Frequency Response Chart). This linearization is implemented in DASY4 software versions later than 4.2. The uncertainty of the frequency response is included in the stated uncertainty of *ConvF*.
- DCP_{x,y,z}**: DCP are numerical linearization parameters assessed based on the data of power sweep (no uncertainty required). DCP does not depend on frequency nor media.
- ConvF and Boundary Effect Parameters**: Assessed in flat phantom using E-field (or Temperature Transfer Standard for $f \leq 800$ MHz) and inside waveguide using analytical field distributions based on power measurements for $f > 800$ MHz. The same setups are used for assessment of the parameters applied for boundary compensation (alpha, depth) of which typical uncertainty values are given. These parameters are used in DASY4 software to improve probe accuracy close to the boundary. The sensitivity in TSL corresponds to NORM_{x,y,z} * *ConvF* whereby the uncertainty corresponds to that given for *ConvF*. A frequency dependent *ConvF* is used in DASY version 4.4 and higher which allows extending the validity from ± 50 MHz to ± 100 MHz.
- Spherical isotropy (3D deviation from isotropy)**: in a field of low gradients realized using a flat phantom exposed by a patch antenna.
- Sensor Offset**: The sensor offset corresponds to the offset of virtual measurement center from the probe tip (on probe axis). No tolerance required.

Probe ES3DV3

SN:3213

Manufactured: October 14, 2008
Calibrated: April 15, 2009

Calibrated for DASY Systems

(Note: non-compatible with DASY2 system!)

DASY - Parameters of Probe: ES3DV3 SN:3213

Sensitivity in Free Space^A

Diode Compression^B

NormX	1.23 ± 10.1%	$\mu\text{V}/(\text{V}/\text{m})^2$	DCP X	90 mV
NormY	1.40 ± 10.1%	$\mu\text{V}/(\text{V}/\text{m})^2$	DCP Y	92 mV
NormZ	1.36 ± 10.1%	$\mu\text{V}/(\text{V}/\text{m})^2$	DCP Z	94 mV

Sensitivity in Tissue Simulating Liquid (Conversion Factors)

Please see Page 8.

Boundary Effect

TSL 835 MHz Typical SAR gradient: 5 % per mm

Sensor Center to Phantom Surface Distance		3.0 mm	4.0 mm
SAR _{be} [%]	Without Correction Algorithm	10.4	6.1
SAR _{be} [%]	With Correction Algorithm	0.8	0.5

TSL 1750 MHz Typical SAR gradient: 10 % per mm

Sensor Center to Phantom Surface Distance		3.0 mm	4.0 mm
SAR _{be} [%]	Without Correction Algorithm	9.6	5.8
SAR _{be} [%]	With Correction Algorithm	0.8	0.6

Sensor Offset

Probe Tip to Sensor Center **2.0 mm**

The reported uncertainty of measurement is stated as the standard uncertainty of measurement multiplied by the coverage factor k=2, which for a normal distribution corresponds to a coverage probability of approximately 95%.

^A The uncertainties of NormX,Y,Z do not affect the E²-field uncertainty inside TSL (see Page 8).

^B Numerical linearization parameter: uncertainty not required.

Frequency Response of E-Field

(TEM-Cell:ifi110 EXX, Waveguide: R22)

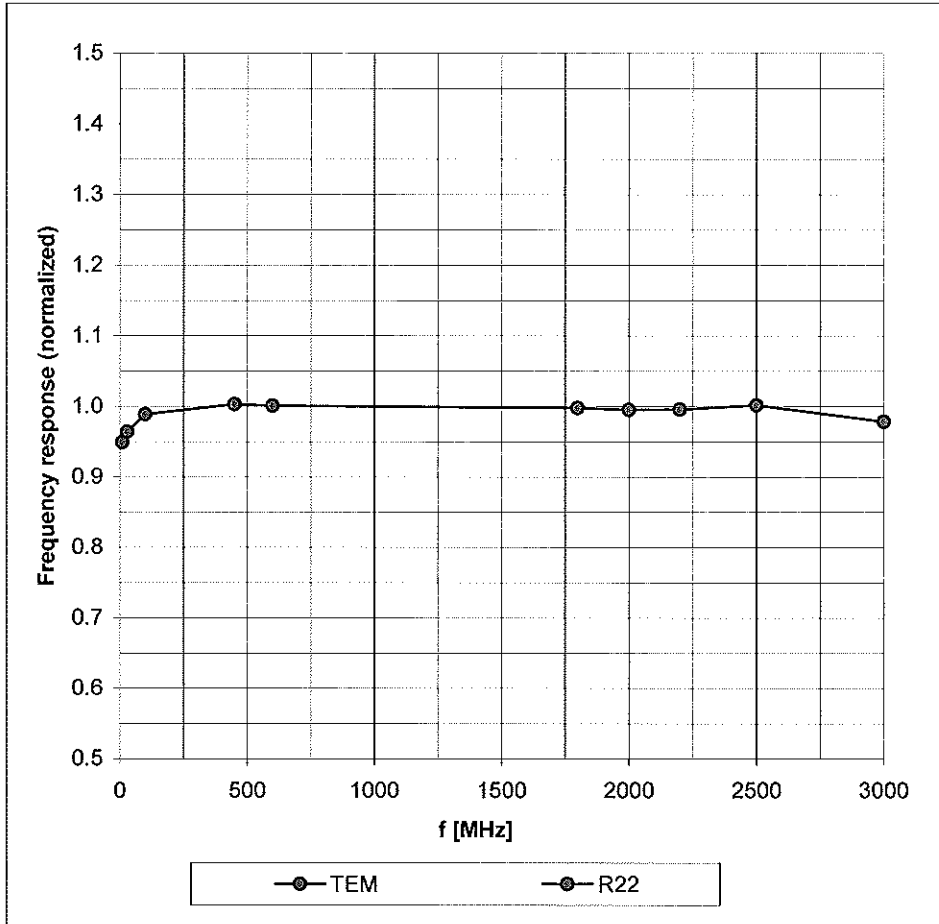

Uncertainty of Frequency Response of E-field: $\pm 6.3\%$ ($k=2$)

Receiving Pattern (ϕ), $\vartheta = 0^\circ$

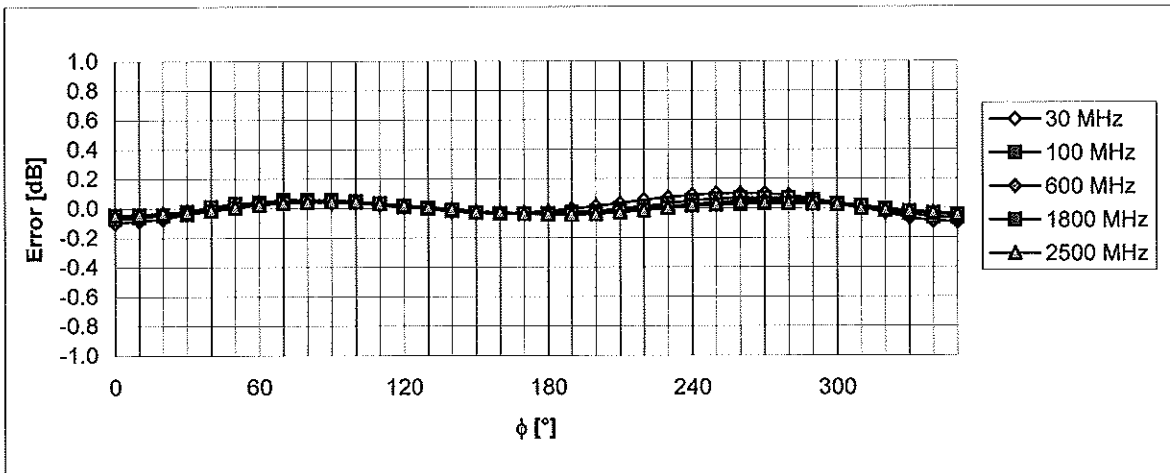
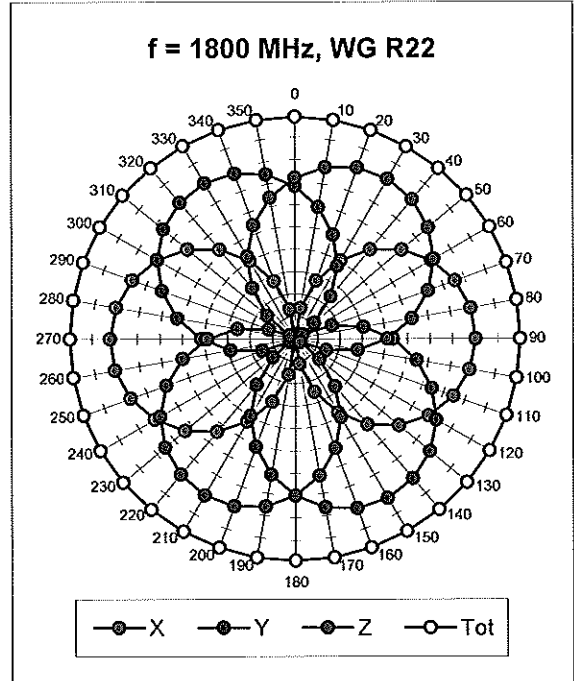
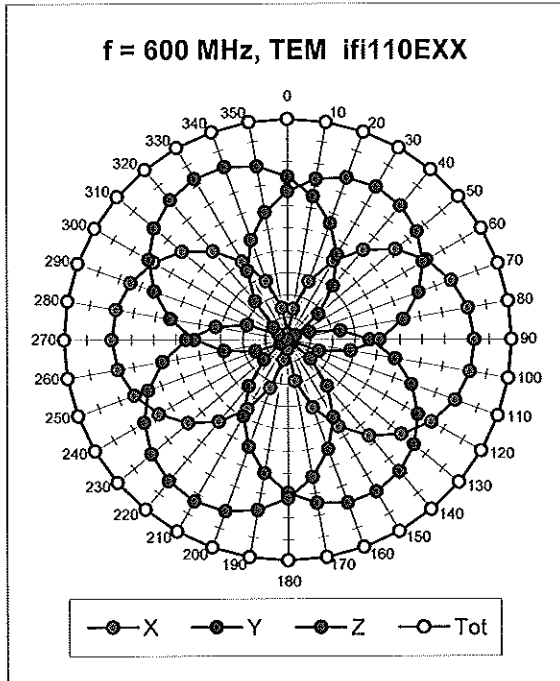

Uncertainty of Axial Isotropy Assessment: $\pm 0.5\%$ ($k=2$)

Dynamic Range $f(\text{SAR}_{\text{head}})$ (Waveguide R22, $f = 1800 \text{ MHz}$)

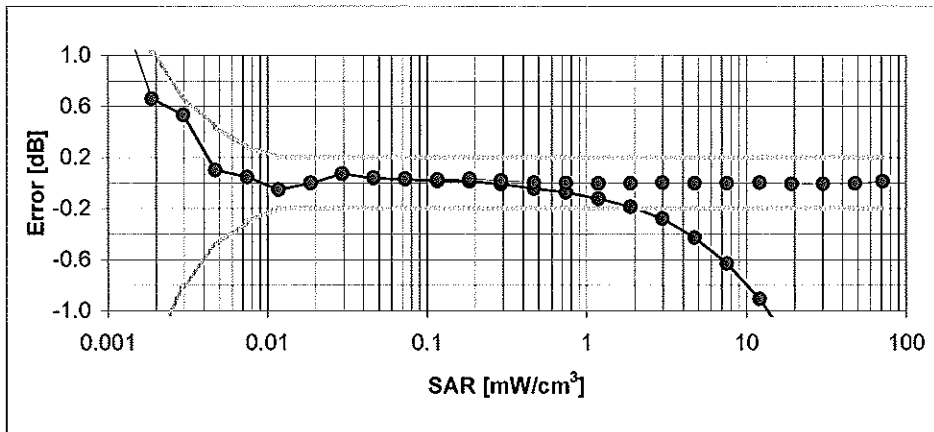
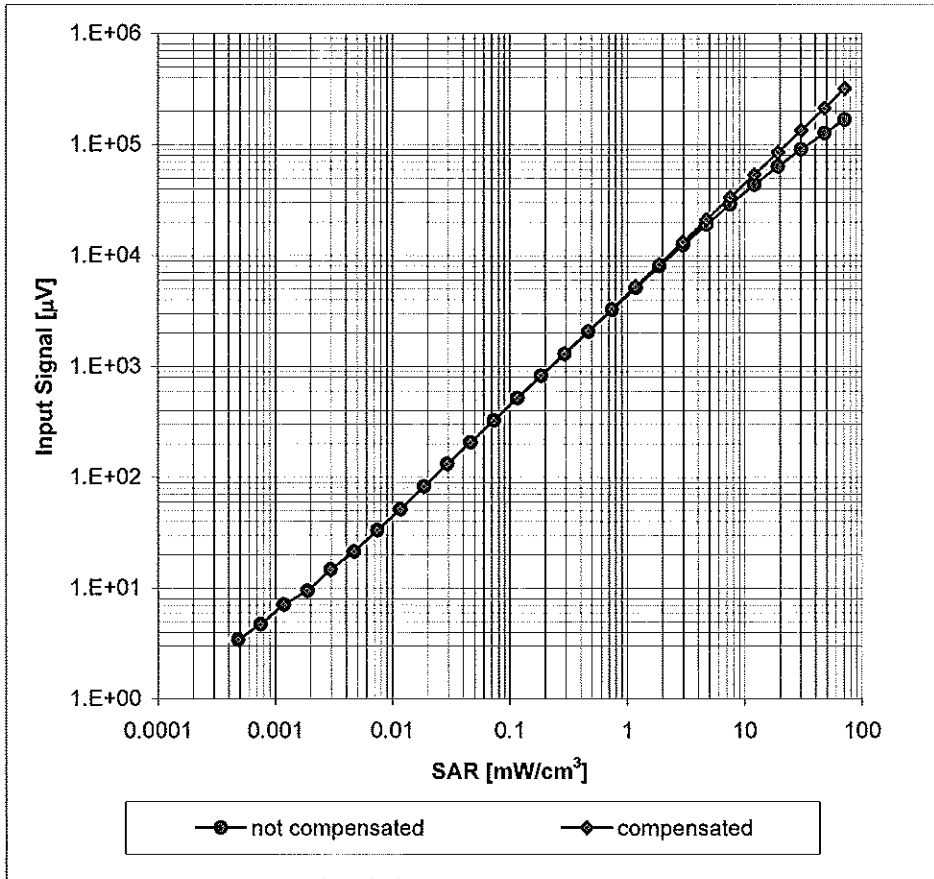

Uncertainty of Linearity Assessment: $\pm 0.6\%$ ($k=2$)

Conversion Factor Assessment

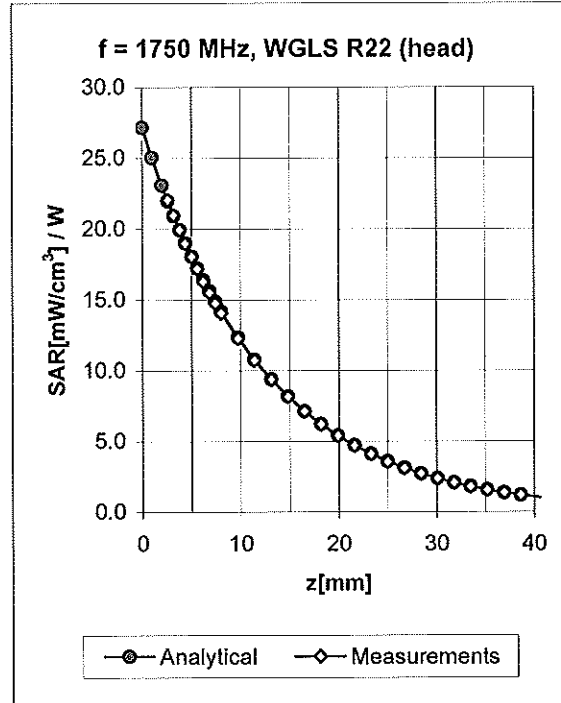
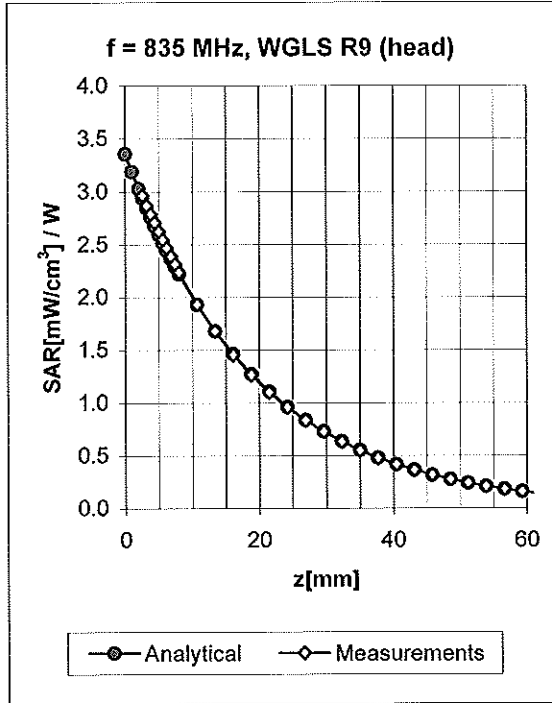

f [MHz]	Validity [MHz] ^c	TSL	Permittivity	Conductivity	Alpha	Depth	ConvF Uncertainty
835	± 50 / ± 100	Head	41.5 ± 5%	0.90 ± 5%	0.85	1.13	5.94 ± 11.0% (k=2)
1750	± 50 / ± 100	Head	40.1 ± 5%	1.37 ± 5%	0.51	1.48	5.23 ± 11.0% (k=2)
1900	± 50 / ± 100	Head	40.0 ± 5%	1.40 ± 5%	0.46	1.60	5.02 ± 11.0% (k=2)
835	± 50 / ± 100	Body	55.2 ± 5%	0.97 ± 5%	0.75	1.21	5.92 ± 11.0% (k=2)
1750	± 50 / ± 100	Body	53.4 ± 5%	1.49 ± 5%	0.35	2.08	4.82 ± 11.0% (k=2)
1900	± 50 / ± 100	Body	53.3 ± 5%	1.52 ± 5%	0.33	2.33	4.52 ± 11.0% (k=2)

^c The validity of ± 100 MHz only applies for DASY v4.4 and higher (see Page 2). The uncertainty is the RSS of the ConvF uncertainty at calibration frequency and the uncertainty for the indicated frequency band.

Deviation from Isotropy in HSL

Error (ϕ , θ), $f = 900$ MHz

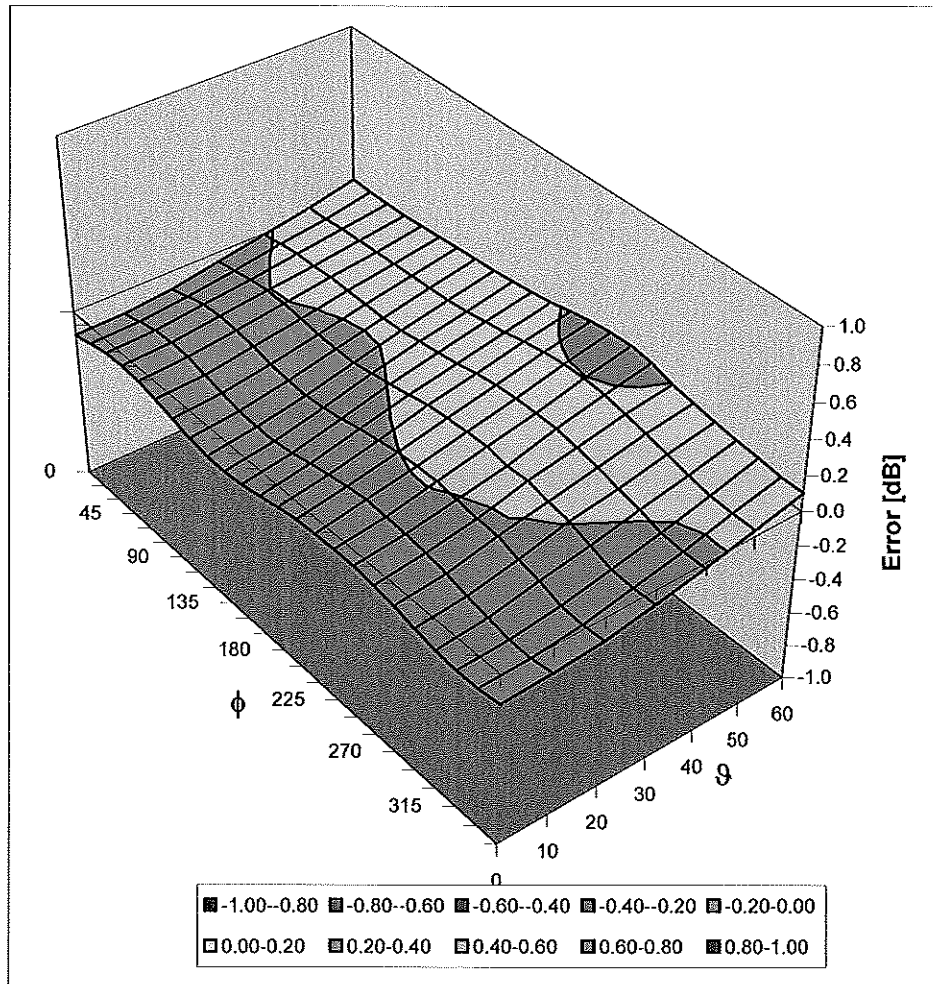

Uncertainty of Spherical Isotropy Assessment: $\pm 2.6\%$ ($k=2$)