



## SAR EVALUATION REPORT

**Applicant Name:**  
 Samsung Electronics, Co. Ltd.  
 416, Maetan 3-dong, Yeongtong-gu, Suwon-si  
 Gyeonggi-do, 443-742  
 Republic of Korea

**Date of Testing:**  
 11/14/12 - 11/16/12  
**Test Site/Location:**  
 PCTEST Lab, Columbia, MD, USA  
**Document Serial No.:**  
 0Y1211121630 – R1.A3L

<b>FCC ID:</b>	<b>A3LGTS5301B</b>
<b>APPLICANT:</b>	<b>SAMSUNG ELECTRONICS, CO. LTD.</b>

**DUT Type:** Portable Handset  
**Application Type:** Certification  
**FCC Rule Part(s):** CFR §2.1093  
**Model(s):** GT-S5301B  
**Test Device Serial No.:** Pre-Production [S/N: FJ-295-C, FJ-295-B]

Band & Mode	Tx Frequency	Conducted Power [dBm]	SAR		
			1 gm Head (W/kg)	1 gm Body-Worn (W/kg)	1 gm Hotspot (W/kg)
GSM/GPRS/EDGE Rx Only 850	824.20 - 848.80 MHz	32.83	0.55	0.64	0.64
UMTS 850	826.40 - 846.60 MHz	22.21	0.31	0.41	0.41
GSM/GPRS/EDGE Rx Only 1900	1850.20 - 1909.80 MHz	30.80	0.91	0.39	0.39
2.4 GHz WLAN	2412 - 2462 MHz	15.70	0.27	0.12	0.15
Bluetooth	2402 - 2480 MHz	9.85	N/A		
<b>Simultaneous SAR per KDB 690783 D01:</b>			1.18	0.75	0.76

Note: Powers in the above table represent output powers for the SAR test configurations and may not represent the highest output powers for all configurations for each mode.

This revised Test Report (S/N: 0Y1211121630-R1.A3L) supersedes and replaces the previously issued test report on the same subject DUT for the same type of testing as indicated. Please discard or destroy the previously issued test report(s) and dispose of it accordingly.



This wireless portable device has been shown to be capable of compliance for localized specific absorption rate (SAR) for uncontrolled environment/general population exposure limits specified in ANSI/IEEE C95.1-1992 and has been tested in accordance with the measurement procedures specified in FCC/OET Bulletin 65 Supplement C (2001), IEEE 1528-2003 and in applicable Industry Canada Radio Standards Specifications (RSS); for North American frequency bands only.

I attest to the accuracy of data. All measurements reported herein were performed by me or were made under my supervision and are correct to the best of my knowledge and belief. I assume full responsibility for the completeness of these measurements and vouch for the qualifications of all persons taking them. Test results reported herein relate only to the item(s) tested.

PCTEST certifies that no party to this application has been subject to a denial of Federal benefits that includes FCC benefits pursuant to Section 5301 of the Anti-Drug Abuse Act of 1988, 21 U.S.C. 862.



  
 Randy Ortanez  
 President



<b>FCC ID:</b> A3LGTS5301B		<b>SAR EVALUATION REPORT</b>		<b>Reviewed by:</b> Quality Manager
<b>Document S/N:</b> 0Y1211121630 – R1.A3L	<b>Test Dates:</b> 11/14/12 - 11/16/12	<b>DUT Type:</b> Portable Handset	Page 1 of 32	

# T A B L E O F C O N T E N T S

1	DEVICE UNDER TEST .....	3
2	INTRODUCTION .....	5
3	SAR MEASUREMENT SETUP .....	6
4	DOSIMETRIC ASSESSMENT .....	7
5	DEFINITION OF REFERENCE POINTS .....	8
6	TEST CONFIGURATION POSITIONS FOR HANDSETS .....	9
7	FCC RF EXPOSURE LIMITS.....	12
8	FCC MEASUREMENT PROCEDURES.....	13
9	RF CONDUCTED POWERS.....	16
10	SYSTEM VERIFICATION.....	19
11	SAR DATA SUMMARY .....	21
12	FCC MULTI-TX AND ANTENNA SAR CONSIDERATIONS.....	25
13	EQUIPMENT LIST .....	28
14	MEASUREMENT UNCERTAINTIES .....	29
15	CONCLUSION.....	30
16	REFERENCES .....	31

<b>FCC ID:</b> A3LGTS5301B		<b>SAR EVALUATION REPORT</b>		<b>Reviewed by:</b> Quality Manager
<b>Document S/N:</b> 0Y1211121630 – R1.A3L	<b>Test Dates:</b> 11/14/12 - 11/16/12	<b>DUT Type:</b> Portable Handset	Page 2 of 32	

# 1 DEVICE UNDER TEST

## 1.1 Device Overview

Band & Mode	Tx Frequency
GSM/GPRS/EDGE Rx Only 850	824.20 - 848.80 MHz
UMTS 850	826.40 - 846.60 MHz
GSM/GPRS/EDGE Rx Only 1900	1850.20 - 1909.80 MHz
2.4 GHz WLAN	2412 - 2462 MHz
Bluetooth	2402 - 2480 MHz

## 1.2 DUT Antenna Locations

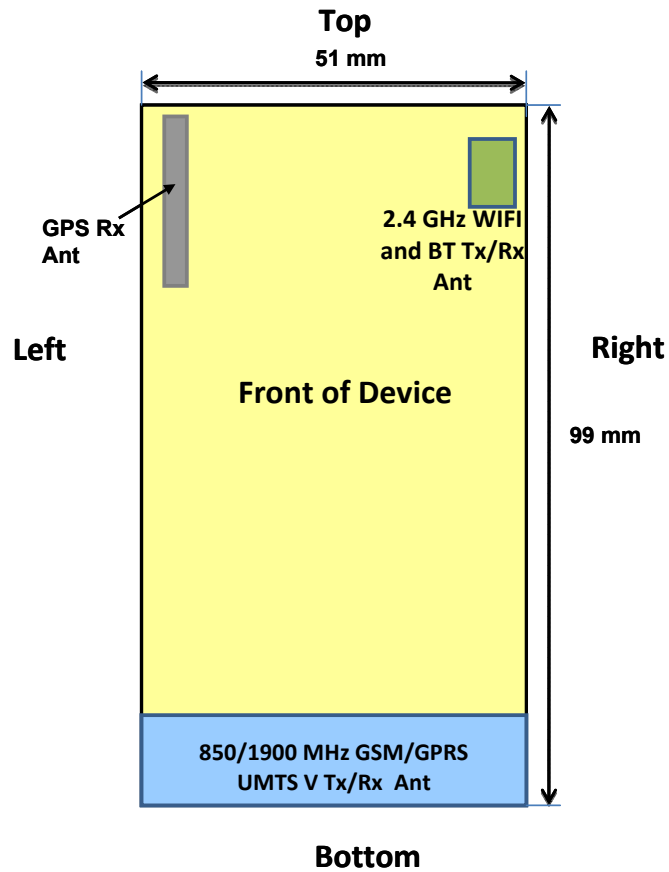

Figure 1-1  
DUT Antenna Locations

FCC ID: A3LGTS5301B	PCTEST ENGINEERING LABORATORY, INC.	SAR EVALUATION REPORT	SAMSUNG	Reviewed by: Quality Manager
Document S/N: 0Y1211121630 – R1.A3L	Test Dates: 11/14/12 - 11/16/12	DUT Type: Portable Handset		Page 3 of 32

**Table 1-1  
Mobile Hotspot Sides for SAR Testing**

Mobile Hotspot Sides for SAR Testing						
Mode	Back	Front	Top	Bottom	Right	Left
GPRS 850	Yes	Yes	No	Yes	Yes	Yes
UMTS 850	Yes	Yes	No	Yes	Yes	Yes
GPRS 1900	Yes	Yes	No	Yes	Yes	Yes
2.4 GHz WLAN	Yes	Yes	Yes	No	Yes	No

Note: Particular DUT edges were not required to be evaluated for Wireless Router SAR if the edges were greater than 2.5 cm from the transmitting antenna according to FCC KDB Publication 941225 D06 guidance, page 2. The antenna document shows the distances between the transmit antennas and the edges of the device.

### 1.3 SAR Test Exclusions Applied

#### (A) WIFI/BT

The separation between the main antenna and the Bluetooth/WLAN antenna is 74 mm. RF Conducted Power of Bluetooth Tx is 9.656 mW (Please refer to the EMC DSS Report for a full set of Bluetooth conducted powers).

2.4 GHz WIFI and Bluetooth share the same antenna path and cannot transmit simultaneously.

Per KDB Publication 648474, **Bluetooth SAR was not required** based on the maximum conducted power, the Bluetooth/WLAN to main antenna separation distance and Body-SAR of the main antenna.

#### (B) Licensed Transmitter(s)

This model does not support Simultaneous Voice and Data for the licensed transmitter in any modes except in UMTS that allows Multi-RAB transmissions that share voice and data operations on a single physical channel.



GSM/GPRS DTM is not supported. Therefore GSM Voice cannot transmit simultaneously with GPRS Data.

### 1.4 Power Reduction for SAR

There is no power reduction for any band/mode implemented in this device for SAR purposes.

### 1.5 Guidance Applied

- FCC OET Bulletin 65 Supplement C [June 2001]
- IEEE 1528-2003
- FCC KDB 941225 (2G/3G and Hotspot)
- FCC KDB 248227 (802.11)
- FCC KDB 648474 (Simultaneous)

FCC ID: A3LGT5301B	 PCTEST ENGINEERING LABORATORY, INC.	SAR EVALUATION REPORT		Reviewed by: Quality Manager
Document S/N: 0Y1211121630 – R1.A3L	Test Dates: 11/14/12 - 11/16/12	DUT Type: Portable Handset		Page 4 of 32

## 2 INTRODUCTION

The FCC has adopted the guidelines for evaluating the environmental effects of radio frequency (RF) radiation in ET Docket 93-62 on Aug. 6, 1996 to protect the public and workers from the potential hazards of RF emissions due to FCC-regulated portable devices. [1]

The safety limits used for the environmental evaluation measurements are based on the criteria published by the American National Standards Institute (ANSI) for localized specific absorption rate (SAR) in IEEE/ANSI C95.1-1992 Standard for Safety Levels with Respect to Human Exposure to Radio Frequency Electromagnetic Fields, 3 kHz to 300 GHz [3] and Health Canada RF Exposure Guidelines Safety Code 6 [24]. The measurement procedure described in IEEE/ANSI C95.3-2002 Recommended Practice for the Measurement of Potentially Hazardous Electromagnetic Fields - RF and Microwave [4] is used for guidance in measuring the Specific Absorption Rate (SAR) due to the RF radiation exposure from the Equipment Under Test (EUT). These criteria for SAR evaluation are similar to those recommended by the International Committee for Non-Ionizing Radiation Protection (ICNIRP) in Biological Effects and Exposure Criteria for Radiofrequency Electromagnetic Fields," Report No. Vol 74. SAR is a measure of the rate of energy absorption due to exposure to an RF transmitting source. SAR values have been related to threshold levels for potential biological hazards.

### 2.1 SAR Definition

Specific Absorption Rate is defined as the time derivative (rate) of the incremental energy (dU) absorbed by (dissipated in) an incremental mass (dm) contained in a volume element (dV) of a given density ( $\rho$ ). It is also defined as the rate of RF energy absorption per unit mass at a point in an absorbing body (see Equation 2-1).

Equation 2-1  
SAR Mathematical Equation

$$SAR = \frac{d}{dt} \left( \frac{dU}{dm} \right) = \frac{d}{dt} \left( \frac{dU}{\rho dV} \right)$$



SAR is expressed in units of Watts per Kilogram (W/kg).

$$SAR = \frac{\sigma \cdot E^2}{\rho}$$

where:

- $\sigma$  = conductivity of the tissue-simulating material (S/m)
- $\rho$  = mass density of the tissue-simulating material ( $\text{kg/m}^3$ )
- E = Total RMS electric field strength (V/m)

NOTE: The primary factors that control rate of energy absorption were found to be the wavelength of the incident field in relation to the dimensions and geometry of the irradiated organism, the orientation of the organism in relation to the polarity of field vectors, the presence of reflecting surfaces, and whether conductive contact is made by the organism with a ground plane.[6]

FCC ID: A3LGT5301B	 PCTEST ENGINEERING LABORATORY, INC.	SAR EVALUATION REPORT		Reviewed by: Quality Manager
Document S/N: 0Y1211121630 – R1.A3L	Test Dates: 11/14/12 - 11/16/12	DUT Type: Portable Handset		Page 5 of 32

## 3 SAR MEASUREMENT SETUP

### 3.1 Automated SAR Measurement System

Measurements are performed using the DASY automated dosimetric SAR assessment system. The DASY is made by Schmid & Partner Engineering AG (SPEAG) in Zurich, Switzerland and consists of a high precision robotics system (Staubli), robot controller, desktop computer, near-field probe, probe alignment sensor, and the SAM phantom containing the head or body equivalent material. The robot is a six-axis industrial robot, performing precise movements to position the probe to the location (points) of maximum electromagnetic field (EMF). See [www.speag.com](http://www.speag.com) for more information about the specification of the SAR assessment system.





**Figure 3-1**  
SAR Measurement System



**Figure 3-2**  
Near-Field Probe

**Table 3-1**  
Composition of the Tissue Equivalent Matter

Frequency (MHz)	835	835	1900	1900	2450	2450
Tissue	Head	Body	Head	Body	Head	Body
Ingredients (% by weight)						
Bactericide	0.1	0.1				
DGBE			44.92	29.44	7.99	26.7
HEC	1	1				
NaCl	1.45	0.94	0.18	0.39	0.16	0.1
Sucrose	57	44.9				
Triton X-100					19.97	
Water	40.45	53.06	54.9	70.17	71.88	73.2

FCC ID: A3LGT55301B		SAR EVALUATION REPORT		Reviewed by: Quality Manager
Document S/N: 0Y1211121630 – R1.A3L	Test Dates: 11/14/12 - 11/16/12	DUT Type: Portable Handset		Page 6 of 32

## 4 DOSIMETRIC ASSESSMENT



### 4.1 Measurement Procedure

The evaluation was performed using the following procedure:

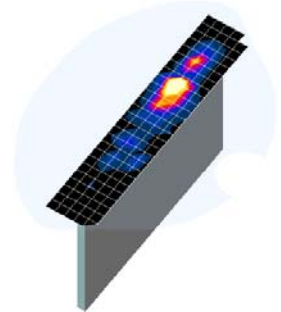
1. The SAR distribution at the exposed side of the head or body was measured at a distance no greater than 5.0 mm from the inner surface of the shell. The area covered the entire dimension of the device-head interface and the horizontal grid resolution was 15mm and 15mm for frequencies < 3 GHz in the x and y directions respectively. When applicable, for frequencies above 3 GHz, a 10 mm by 10 mm resolution was used.
2. The point SAR measurement was taken at the maximum SAR region determined from Step 1 to enable the monitoring of SAR fluctuations/drifts during the 1 gram cube evaluation. SAR at this fixed point was measured and used as a reference value.
3. Based on the area scan data, the peak area of the maximum absorption was determined by spline interpolation. Around this point, a volume of 32mm x 32mm x 30mm (fine resolution volume scan, zoom scan) was assessed by measuring at least 5 x 5 x 7 points. On this basis of this data set, the spatial peak SAR value was evaluated with the following procedure (see references or the DASY manual online for more details):
  - a. The data was extrapolated to the surface of the outer-shell of the phantom. The combined distance extrapolated was the combined distance from the center of the dipoles 2.7mm away from the tip of the probe housing plus the 1.2 mm distance between the surface and the lowest measuring point. The extrapolation was based on a least-squares algorithm. A polynomial of the fourth order was calculated through the points in the z-axis (normal to the phantom shell).
  - b. After the maximum interpolated values were calculated between the points in the cube, the SAR was averaged over the spatial volume (1g or 10g) using a 3D-Spline interpolation algorithm. The 3D-spline is composed of three one-dimensional splines with the “Not a knot” condition (in x, y, and z directions). The volume was then integrated with the trapezoidal algorithm. One thousand points (10 x 10 x 10) were obtained through interpolation, in order to calculate the averaged SAR.
  - c. All neighboring volumes were evaluated until no neighboring volume with a higher average value was found.
4. The SAR reference value, at the same location as step 2, was re-measured after the zoom scan was complete to calculate the SAR drift. If the drift deviated by more than 5%, the SAR test and drift measurements were repeated.



**Figure 4-1**  
**Sample SAR Area Scan**

<b>FCC ID:</b> A3LGTS5301B		<b>SAR EVALUATION REPORT</b>		<b>Reviewed by:</b> Quality Manager
<b>Document S/N:</b> 0Y1211121630 – R1.A3L	<b>Test Dates:</b> 11/14/12 - 11/16/12	<b>DUT Type:</b> Portable Handset		Page 7 of 32

# 5

## DEFINITION OF REFERENCE POINTS

### 5.1 EAR REFERENCE POINT

Figure 5-2 shows the front, back and side views of the SAM Twin Phantom. The point “M” is the reference point for the center of the mouth, “LE” is the left ear reference point (ERP), and “RE” is the right ERP. The ERP is 15mm posterior to the entrance to the ear canal (EEC) along the B-M line (Back-Mouth), as shown in Figure 5-1. The plane passing through the two ear canals and M is defined as the Reference Plane. The line N-F (Neck-Front) is perpendicular to the reference plane and passing through the RE (or LE) is called the Reference Pivoting Line (see Figure 5-2). Line B-M is perpendicular to the N-F line. Both N-F and B-M lines are marked on the external phantom shell to facilitate handset positioning [5].

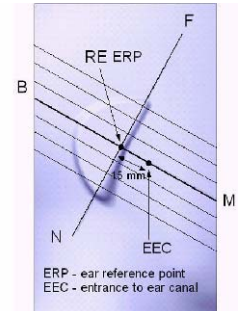

**Figure 5-1**  
Close-Up Side view of ERP

### 5.2 HANDSET REFERENCE POINTS

Two imaginary lines on the handset were established: the vertical centerline and the horizontal line. The test device was placed in a normal operating position with the “test device reference point” located along the “vertical centerline” on the front of the device aligned to the “ear reference point” (See Figure 5-3). The “test device reference point” was then located at the same level as the center of the ear reference point. The test device was positioned so that the “vertical centerline” was bisecting the front surface of the handset at its top and bottom edges, positioning the “ear reference point” on the outer surface of the both the left and right head phantoms on the ear reference point.



**Figure 5-2**  
Front, back and side view of SAM Twin Phantom

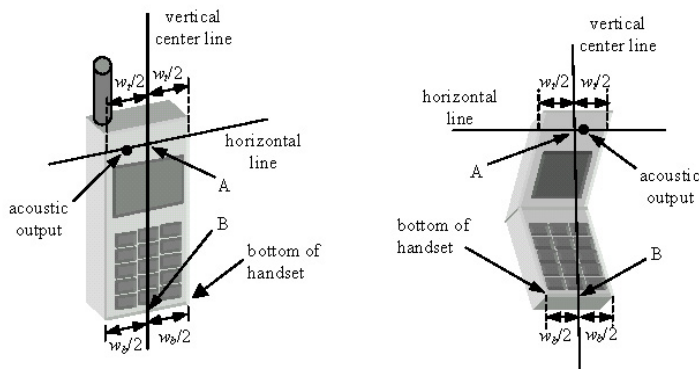

**Figure 5-3**  
Handset Vertical Center & Horizontal Line Reference Points

FCC ID: A3LGTS5301B	PCTEST ENGINEERING LABORATORY, INC.	SAR EVALUATION REPORT	SAMSUNG	Reviewed by: Quality Manager
Document S/N: 0Y1211121630 – R1.A3L	Test Dates: 11/14/12 - 11/16/12	DUT Type: Portable Handset		Page 8 of 32

## 6 TEST CONFIGURATION POSITIONS FOR HANDSETS

### 6.1 Device Holder

The DASY device holder has been made out of low-loss POM material having the following dielectric parameters: relative permittivity  $\epsilon = 3$  and loss tangent  $\delta = 0.02$ .

### 6.2 Positioning for Cheek/Touch

1. The test device was positioned with the handset close to the surface of the phantom such that point A is on the (virtual) extension of the line passing through points RE and LE on the phantom (see Figure 6-1), such that the plane defined by the vertical center line and the horizontal line of the phone is approximately parallel to the sagittal plane of the phantom.

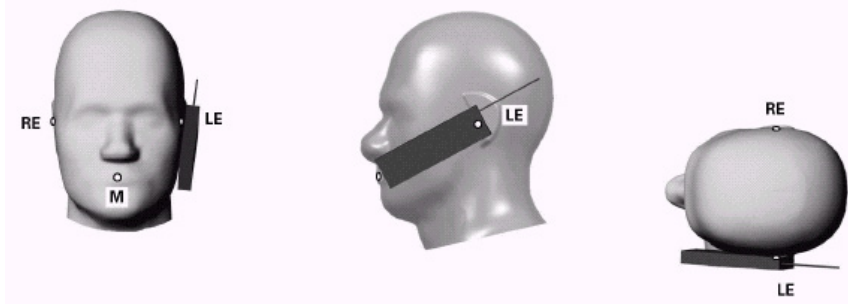



Figure 6-1 Front, Side and Top View of Cheek/Touch Position

2. The handset was translated towards the phantom along the line passing through RE & LE until the handset touches the ear.
3. While maintaining the handset in this plane, the handset was rotated around the LE-RE line until the vertical centerline was in the plane normal to MB-NF including the line MB (reference plane).
4. The phone was then rotated around the vertical centerline until the phone (horizontal line) was symmetrical with respect to the line NF.
5. While maintaining the vertical centerline in the reference plane, keeping point A on the line passing through RE and LE, and maintaining the phone contact with the ear, the handset was rotated about the line NF until any point on the handset made contact with a phantom point below the ear (cheek) (See Figure 6-2).

### 6.3 Positioning for Ear / 15° Tilt

With the test device aligned in the “Cheek/Touch Position”:

1. While maintaining the orientation of the phone, the phone was retracted parallel to the reference plane far enough to enable a rotation of the phone by 15degree.
2. The phone was then rotated around the horizontal line by 15 degree.
3. While maintaining the orientation of the phone, the phone was moved parallel to the reference plane until any part of the phone touches the head. (In this position, point A was located on the line RE-LE). The tilted position is obtained when the contact is on the pinna. If the contact was at any location other than the pinna, the angle of the phone would then be reduced. The tilted position was obtained when any part of the phone was in contact of the ear as well as a second part of the phone was in contact with the head (see Figure 6-2).

FCC ID: A3LGT55301B		SAR EVALUATION REPORT		Reviewed by: Quality Manager
Document S/N: 0Y1211121630 – R1.A3L	Test Dates: 11/14/12 - 11/16/12	DUT Type: Portable Handset		Page 9 of 32

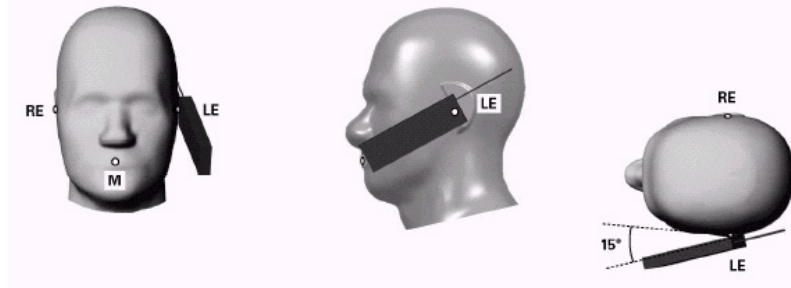

Figure 6-2 Front, Side and Top View of Ear/15° Tilt Position

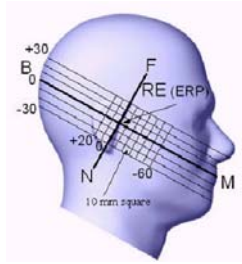

Figure 6-3 Side view w/ relevant markings



Figure 6-4 Body SAR Sample Photo (Not Actual EUT)

## 6.4 SAR Evaluations near the Mouth/Jaw Regions of the SAM Phantom

Antennas located near the bottom of a phone may require SAR measurements around the mouth and jaw regions of the SAM head phantom. This typically applies to clam-shell style phones that are generally longer in the unfolded normal use positions or to certain older style long rectangular phones.

Under these circumstances, the following procedures apply, adopted from the FCC guidance on SAR handsets document publication 648474. The SAR required in these regions of SAM should be measured using a flat phantom. **Rectangular shaped phones** should be positioned with its bottom edge positioned from the flat phantom with the same distance provided by the cheek touching position using SAM. The ear reference point (ERP, as defined for SAM) of the phone should be positioned ½ cm from the flat phantom shell. **Clam-shell phones** should be positioned with the hinge against a smooth edge of the flat phantom where the upper half of the phone is unfolded and extended beyond the phantom side wall. The lower half of the phone is secured in the test device holder at a fixed distance below the flat phantom determined by the minimum separation along the lower edge of the phone in the cheek touching position using SAM. Any case with substantial variation in separation distance along the lower edge of a clam shell is discussed with the FCC for best-to-use methodology.

The latest IEEE 1528 committee developments propose the usage of a tilted phantom when the antenna of the phone is mounted at the bottom or in all cases the peak absorption is in the chin region. Both SAM heads of the TwinSAM-Chin20 are rotated 20 degrees around the NF line. Each head can be removed individually from the table for emptying and cleaning.

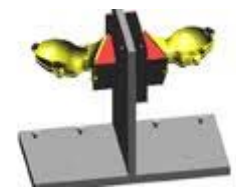

Figure 6-5 Twin SAM Chin20

## 6.5 Body-Worn Accessory Configurations

Body-worn operating configurations are tested with the belt-clips and holsters attached to the device and positioned against a flat phantom in a normal use configuration (see Figure 6-4). A device with a headset output is tested with a headset connected to the device.

FCC ID: A3LGT55301B	PCTEST ENGINEERING LABORATORY, INC.	SAR EVALUATION REPORT		Reviewed by: Quality Manager
Document S/N: 0Y1211121630 – R1.A3L	Test Dates: 11/14/12 - 11/16/12	DUT Type: Portable Handset		Page 10 of 32



Accessories for Body-worn operation configurations are divided into two categories: those that do not contain metallic components and those that do contain metallic components. When multiple accessories that do not contain metallic components are supplied with the device, the device is tested with only the accessory that dictates the closest spacing to the body. Then multiple accessories that contain metallic components are tested with the device with each accessory. If multiple accessories share an identical metallic component (i.e. the same metallic belt-clip used with different holsters with no other metallic components) only the accessory that dictates the closest spacing to the body is tested.

Body-worn accessories may not always be supplied or available as options for some devices intended to be authorized for body-worn use. In this case, a test configuration with a separation distance between the back of the device and the flat phantom is used. Test position spacing was documented. Transmitters that are designed to operate in front of a person's face, as in push-to-talk configurations, are tested for SAR compliance with the front of the device positioned to face the flat phantom in head fluid. For devices that are carried next to the body such as a shoulder, waist or chest-worn transmitters, SAR compliance is tested with the accessories, including headsets and microphones, attached to the device and positioned against a flat phantom in a normal use configuration.

## 6.6 Wireless Router Configurations

Some battery-operated handsets have the capability to transmit and receive internet connectivity through simultaneous transmission of WIFI in conjunction with a separate licensed transmitter. The FCC has provided guidance in KDB Publication 941225 D06 where SAR test considerations for handsets ( $L \times W \geq 9 \text{ cm} \times 5 \text{ cm}$ ) are based on a composite test separation distance of 10 mm from the front, back and edges of the device with antennas 2.5 cm or closer to the edge of the device, determined from general mixed use conditions for this type of devices. Since the hotspot SAR results may overlap with the body-worn accessory SAR requirements, the more conservative configurations can be considered, thus excluding some body-worn accessory SAR tests.

When the user enables the personal wireless router functions for the handset, actual operations include simultaneous transmission of both the WIFI transmitter and another licensed transmitter. Both transmitters often do not transmit at the same transmitting frequency and thus cannot be evaluated for SAR under actual use conditions. Therefore, SAR must be evaluated for each frequency transmission and mode separately and summed with the WIFI transmitter according to KDB 648474 publication procedures. The "Portable Hotspot" feature on the handset was NOT activated, to ensure the SAR measurements were evaluated for a single transmission frequency RF signal.

FCC ID: A3LGT5301B		SAR EVALUATION REPORT		Reviewed by: Quality Manager
Document S/N: 0Y1211121630 – R1.A3L	Test Dates: 11/14/12 - 11/16/12	DUT Type: Portable Handset	Page 11 of 32	

## 7 FCC RF EXPOSURE LIMITS

### 7.1 Uncontrolled Environment

UNCONTROLLED ENVIRONMENTS are defined as locations where there is the exposure of individuals who have no knowledge or control of their exposure. The general population/uncontrolled exposure limits are applicable to situations in which the general public may be exposed or in which persons who are exposed as a consequence of their employment may not be made fully aware of the potential for exposure or cannot exercise control over their exposure. Members of the general public would come under this category when exposure is not employment-related; for example, in the case of a wireless transmitter that exposes persons in its vicinity.



### 7.2 Controlled Environment

CONTROLLED ENVIRONMENTS are defined as locations where there is exposure that may be incurred by persons who are aware of the potential for exposure, (i.e. as a result of employment or occupation). In general, occupational/controlled exposure limits are applicable to situations in which persons are exposed as a consequence of their employment, who have been made fully aware of the potential for exposure and can exercise control over their exposure. This exposure category is also applicable when the exposure is of a transient nature due to incidental passage through a location where the exposure levels may be higher than the general population/uncontrolled limits, but the exposed person is fully aware of the potential for exposure and can exercise control over his or her exposure by leaving the area or by some other appropriate means.

**Table 7-1**  
**SAR Human Exposure Specified in ANSI/IEEE C95.1-1992 and Health Canada Safety Code 6**

HUMAN EXPOSURE LIMITS		
	UNCONTROLLED ENVIRONMENT <i>General Population</i> (W/kg) or (mW/g)	CONTROLLED ENVIRONMENT <i>Occupational</i> (W/kg) or (mW/g)
SPATIAL PEAK SAR Brain	1.6	8.0
SPATIAL AVERAGE SAR Whole Body	0.08	0.4
SPATIAL PEAK SAR Hands, Feet, Ankles, Wrists	4.0	20

1. The Spatial Peak value of the SAR averaged over any 1 gram of tissue (defined as a tissue volume in the shape of a cube) and over the appropriate averaging time.
2. The Spatial Average value of the SAR averaged over the whole body.
3. The Spatial Peak value of the SAR averaged over any 10 grams of tissue (defined as a tissue volume in the shape of a cube) and over the appropriate averaging time.

FCC ID: A3LGT5301B	 PCTEST ENGINEERING LABORATORY, INC.	SAR EVALUATION REPORT		Reviewed by: Quality Manager
Document S/N: 0Y1211121630 – R1.A3L	Test Dates: 11/14/12 - 11/16/12	DUT Type: Portable Handset		Page 12 of 32

Power measurements were performed using a base station simulator under digital average power.

### 8.1 Procedures Used to Establish RF Signal for SAR

The following procedures are according to FCC KDB Publication 941225 D01 “SAR Measurement Procedures for 3G Devices” v02, October 2007.

The device was placed into a simulated call using a base station simulator in a RF shielded chamber. Establishing connections in this manner ensure a consistent means for testing SAR and are recommended for evaluating SAR [4]. Devices under test were evaluated prior to testing, with a fully charged battery and were configured to operate at maximum output power. In order to verify that the device was tested throughout the SAR test at maximum output power, the SAR measurement system measures a “point SAR” at an arbitrary reference point at the start and end of the 1 gram SAR evaluation, to assess for any power drifts during the evaluation. If the power drift deviated by more than 5%, the SAR test and drift measurements were repeated.

### 8.2 SAR Measurement Conditions for UMTS

#### 8.2.1 Output Power Verification

Maximum output power is measured on the High, Middle and Low channels for each applicable transmission band according to the general descriptions in section 5.2 of 3GPP TS 34.121, using the appropriate RMC or AMR with TPC (transmit power control) set to all “1s”.

#### 8.2.2 Head SAR Measurements for Handsets



SAR for head exposure configurations is measured using the 12.2 kbps RMC with TPC bits configured to all “1s”. SAR in AMR configurations is not required when the maximum average output of each RF channel for 12.2 kbps AMR is less than 0.25 dB higher than that measured in 12.2 kbps RMC. Otherwise, SAR is measured on the maximum output channel in 12.2 AMR with a 3.4 kbps SRB (signaling radio bearer) using the exposure configuration that resulted in the highest SAR for that RF channel in the 12.2 kbps RMC mode.

#### 8.2.3 Body SAR Measurements

SAR for body exposure configurations is measured using the 12.2 kbps RMC with the TPC bits all “1s”.

#### 8.2.4 SAR Measurements for Handsets with Rel 5 HSDPA

Body SAR for HSDPA is not required for handsets with HSDPA capabilities when the maximum average output power of each RF channel with HSDPA active is less than 0.25 dB higher than that measured without HSDPA using 12.2 kbps RMC and the maximum SAR for 12.2 kbps RMC is  $\leq 75\%$  of the SAR limit. Otherwise, SAR is measured for HSDPA, using an FRC with H-Set 1 in Sub-test 1 and a 12.2 kbps RMC configured in Test Loop Mode 1, using the highest body SAR configuration measured in 12.2 kbps RMC without HSDPA, on the maximum output channel with the body exposure configuration that resulted in the highest SAR in 12.2 kbps RMC mode for that RF channel.

FCC ID: A3LGT5301B	 PCTEST ENGINEERING LABORATORY, INC.	SAR EVALUATION REPORT		Reviewed by: Quality Manager
Document S/N: 0Y1211121630 – R1.A3L	Test Dates: 11/14/12 - 11/16/12	DUT Type: Portable Handset		Page 13 of 32

The H-set used in FRC for HSDPA should be configured according to the UE category of a test device. The number of HS-DSCH/HSPDSCHs, HARQ processes, minimum inter-TTI interval, transport block sizes and RV coding sequence are defined by the applicable H-set. To maintain a consistent test configuration and stable transmission conditions, QPSK is used in the FRC for SAR testing. HS-DPCCH should be configured with a CQI feedback cycle of 2 ms to maintain a constant rate of active CQI slots. DPCCH and DPDCH gain factors of  $\beta_c=9$  and  $\beta_d=15$ , and power offset parameters of  $\Delta_{ACK} = \Delta_{NACK} = 5$  and  $\Delta_{CQI} = 2$  is used. The CQI value is determined by the UE category, transport block size, number of HS-PDSCHs and modulation used in the FRC.



### 8.2.5 SAR Measurements for Handsets with Rel 6 HSUPA

Body SAR for HSUPA is not required when the maximum average output of each RF channel with HSUPA/HSDPA active is less than 0.25 dB higher than as measured without HSUPA/HSDPA using 12.2 kbps RMC and maximum SAR for 12.2 kbps RMC is  $\leq 75\%$  of the SAR limit. Otherwise SAR is measured on the maximum output channel for the body exposure configuration produced highest SAR in 12.2 kbps RMC for that RF channel, using the additional procedures under “Release 6 HSPA data devices”

Head SAR for VOIP operations under HSPA is not required when maximum average output of each RF channel with HSPA is less than 0.25 dB higher than as measured using 12.2 kbps RMC. Otherwise SAR is measured using same HSPA configuration as used for body SAR.

Sub-test	$\beta_c$	$\beta_d$	$\beta_d$ (SF)	$\beta_c/\beta_d$	$\beta_{hs}^{(1)}$	$\beta_{ec}$	$\beta_{ed}$	$\beta_{ed}$ (SF)	$\beta_{ed}$ (codes)	CM <sup>(2)</sup> (dB)	MPR (dB)	AG <sup>(4)</sup> Index	E-TFCI
1	11/15 <sup>(3)</sup>	15/15 <sup>(3)</sup>	64	11/15 <sup>(3)</sup>	22/15	209/225	1039/225	4	1	1.0	0.0	20	75
2	6/15	15/15	64	6/15	12/15	12/15	94/75	4	1	3.0	2.0	12	67
3	15/15	9/15	64	15/9	30/15	30/15	$\beta_{d1}: 47/15$ $\beta_{d2}: 47/15$	4	2	2.0	1.0	15	92
4	2/15	15/15	64	2/15	4/15	2/15	56/75	4	1	3.0	2.0	17	71
5	15/15 <sup>(4)</sup>	15/15 <sup>(4)</sup>	64	15/15 <sup>(4)</sup>	30/15	24/15	134/15	4	1	1.0	0.0	21	81

Note 1:  $\Delta_{ACK}, \Delta_{NACK}$  and  $\Delta_{CQI} = 8 \Leftrightarrow A_{hs} = \beta_{hs}/\beta_c = 30/15 \Leftrightarrow \beta_{hs} = 30/15 * \beta_c$ .  
 Note 2: CM = 1 for  $\beta_c/\beta_d = 12/15, \beta_{hs}/\beta_c = 24/15$ . For all other combinations of DPDCH, DPCCH, HS-DPCCH, E-DPDCH and E-DPCCH the MPR is based on the relative CM difference.  
 Note 3: For subtest 1 the  $\beta_c/\beta_d$  ratio of 11/15 for the TFC during the measurement period (TF1, TF0) is achieved by setting the signaled gain factors for the reference TFC (TF1, TF1) to  $\beta_c = 10/15$  and  $\beta_d = 15/15$ .  
 Note 4: For subtest 5 the  $\beta_c/\beta_d$  ratio of 15/15 for the TFC during the measurement period (TF1, TF0) is achieved by setting the signaled gain factors for the reference TFC (TF1, TF1) to  $\beta_c = 14/15$  and  $\beta_d = 15/15$ .  
 Note 5: Testing UE using E-DPDCH Physical Layer category 1 Sub-test 3 is not required according to TS 25.306 Table 5.1g.  
 Note 6:  $\beta_{ed}$  can not be set directly; it is set by Absolute Grant Value.

FCC ID: A3LGT5301B		SAR EVALUATION REPORT		Reviewed by: Quality Manager
Document S/N: 0Y1211121630 - R1.A3L	Test Dates: 11/14/12 - 11/16/12	DUT Type: Portable Handset		Page 14 of 32

### 8.3 SAR Testing with 802.11 Transmitters

Normal network operating configurations are not suitable for measuring the SAR of 802.11 b/g/n transmitters. Unpredictable fluctuations in network traffic and antenna diversity conditions can introduce undesirable variations in SAR results. The SAR for these devices should be measured using chipset based test mode software to ensure the results are consistent and reliable. See KDB Publication 248227 for more details.



#### 8.3.1 General Device Setup

Chipset based test mode software is hardware dependent and generally varies among manufacturers. The device operating parameters established in test mode for SAR measurements must be identical to those programmed in production units, including output power levels, amplifier gain settings and other RF performance tuning parameters. The test frequencies should correspond to actual channel frequencies defined for domestic use. SAR for devices with switched diversity should be measured with only one antenna transmitting at a time during each SAR measurement, according to a fixed modulation and data rate. The same data pattern should be used for all measurements.

#### 8.3.2 Frequency Channel Configurations [27]

For 2.4 GHz, the highest average RF output power channel between the low, mid and high channel at the lowest data rate was selected for SAR evaluation in 802.11b mode. 802.11g/n modes and higher data rates for 802.11b were additionally evaluated for SAR if the output power of the respective mode was 0.25 dB or higher than the powers of the SAR configurations tested in the 802.11b mode.

If the maximum extrapolated peak SAR of the zoom scan for the highest output channel was less than 1.6 W/kg or if the 1g averaged SAR was less than 0.8 W/kg, SAR testing was not required for the other test channels in the band.

<b>FCC ID:</b> A3LGT5301B		<b>SAR EVALUATION REPORT</b>		<b>Reviewed by:</b> Quality Manager
<b>Document S/N:</b> 0Y1211121630 – R1.A3L	<b>Test Dates:</b> 11/14/12 - 11/16/12	<b>DUT Type:</b> Portable Handset	Page 15 of 32	

# 9 RF CONDUCTED POWERS

## 9.1 GSM Conducted Powers

		Maximum Burst-Averaged Output Power				
		Voice	GPRS Data (GMSK)			
Band	Channel	GSM [dBm] CS (1 Slot)	GPRS [dBm] 1 Tx Slot	GPRS [dBm] 2 Tx Slot	GPRS [dBm] 3 Tx Slot	GPRS [dBm] 4 Tx Slot
Cellular	128	32.58	32.66	<b>30.15</b>	28.12	27.11
	190	32.83	32.92	<b>30.45</b>	28.38	27.38
	251	32.68	32.73	<b>30.29</b>	28.23	27.22
PCS	512	30.80	30.82	<b>28.22</b>	26.18	25.12
	661	30.55	30.57	<b>28.01</b>	25.96	24.97
	810	30.63	30.62	<b>28.07</b>	26.07	25.07
		Calculated Maximum Frame-Averaged Output Power				
		Voice	GPRS Data (GMSK)			
Band	Channel	GSM [dBm] CS (1 Slot)	GPRS [dBm] 1 Tx Slot	GPRS [dBm] 2 Tx Slot	GPRS [dBm] 3 Tx Slot	GPRS [dBm] 4 Tx Slot
Cellular	128	23.55	23.63	<b>24.13</b>	23.86	24.10
	190	23.80	23.89	<b>24.43</b>	24.12	24.37
	251	23.65	23.70	<b>24.27</b>	23.97	24.21
PCS	512	21.77	21.79	<b>22.20</b>	21.92	22.11
	661	21.52	21.54	<b>21.99</b>	21.70	21.96
	810	21.60	21.59	<b>22.05</b>	21.81	22.06

Note:

- Both burst-averaged and calculated frame-averaged powers are included. Frame-averaged power was calculated from the measured burst-averaged power by converting the slot powers into linear units and calculating the energy over 8 timeslots.
- The bolded GPRS modes were selected according to the highest frame-averaged output power table according to KDB 941225 D03.
- CS1 coding scheme was used in GPRS output power measurements and SAR testing, as a condition where GMSK modulation was ensured. It was investigated that CS1-CS4 settings do not have any impact on the output power levels in the GPRS modes.

**GSM Class: B**  
**GPRS Multislot class: 12 (max 4 Tx Uplink slots)**  
**EDGE Multislot class: Rx Only**  
**DTM Multislot Class: N/A**



**Figure 9-1**  
**Power Measurement Setup**

FCC ID: A3LGT55301B	PCTEST ENGINEERING LABORATORY, INC.	SAR EVALUATION REPORT		Reviewed by: Quality Manager
Document S/N: 0Y1211121630 – R1.A3L	Test Dates: 11/14/12 - 11/16/12	DUT Type: Portable Handset	Page 16 of 32	

## 9.2 UMTS Conducted Powers

3GPP Release Version	Mode	3GPP 34.121 Subtest	Cellular Band [dBm]			3GPP MPR [dB]
			4132	4183	4233	
99	WCDMA	12.2 kbps RMC	22.50	22.21	22.47	-
99		12.2 kbps AMR	22.55	22.23	22.41	-
6	HSDPA	Subtest 1	22.50	22.33	22.34	0
6		Subtest 2	22.61	22.36	22.48	0
6		Subtest 3	22.39	22.08	22.37	0.5
6		Subtest 4	22.46	22.12	22.33	0.5
6	HSUPA	Subtest 1	20.82	20.78	20.81	0
6		Subtest 2	20.31	20.30	20.26	2
6		Subtest 3	20.99	20.78	20.88	1
6		Subtest 4	21.36	21.16	21.50	2
6		Subtest 5	22.28	22.16	22.17	0

UMTS SAR was tested under RMC 12.2 kbps with HSPA Inactive per KDB Publication 941225 D01. HSPA SAR was not required since the average output power of the HSPA subtests was not more than 0.25 dB higher than the RMC level and SAR was less than 1.2 W/kg.

It is expected by the manufacturer that MPR for some HSUPA subtests may be up to 2 dB more than specified by 3GPP, but also as low as 0 dB according to the chipset implementation in this model. Detailed information is included in the operational description explaining how the MPR is applied for this model.



**Figure 9-2**  
Power Measurement Setup

## 9.3 WLAN Conducted Powers

**Table 9-1**  
IEEE 802.11b Average RF Power

Mode	Freq [MHz]	Channel	802.11b Conducted Power [dBm]			
			Data Rate [Mbps]			
			1	2	5.5	11
802.11b	2412	1	15.70	15.70	15.71	15.73
802.11b	2437	6	15.64	15.68	15.71	15.66
802.11b	2462	11	15.66	15.74	15.77	15.75

**Table 9-2**  
IEEE 802.11g Average RF Power

Mode	Freq [MHz]	Channel	802.11g Conducted Power [dBm]							
			Data Rate [Mbps]							
			6	9	12	18	24	36	48	54
802.11g	2412	1	10.71	10.76	11.00	10.86	10.90	10.81	10.88	10.95
802.11g	2437	6	10.83	10.70	10.80	10.78	10.86	10.82	10.82	11.31
802.11g	2462	11	10.70	10.75	10.65	10.60	10.70	11.19	11.00	11.00

FCC ID: A3LGT5301B	PCTEST ENGINEERING LABORATORY, INC.	SAR EVALUATION REPORT		Reviewed by: Quality Manager
Document S/N: 0Y1211121630 – R1.A3L	Test Dates: 11/14/12 - 11/16/12	DUT Type: Portable Handset		Page 17 of 32

**Table 9-3  
IEEE 802.11n Average RF Power**



Mode	Freq [MHz]	Channel	802.11n (2.4GHz) Conducted Power [dBm]							
			Data Rate [Mbps]							
			6.5/7.2	13/14.4	19.5/21.7	26/28.9	39/43.4	52/57.8	58.5/65	65/72.2
802.11n	2412	1	10.85	11.00	11.10	11.20	11.00	11.10	11.10	11.00
802.11n	2437	6	10.88	11.00	10.85	11.10	11.10	11.10	11.00	11.00
802.11n	2462	11	10.88	11.10	10.99	11.08	11.00	11.00	11.00	11.00

Justification for reduced test configurations for WIFI channels per KDB Publication 248227 and April 2010 FCC/TCB Meeting Notes:

- For 2.4 GHz, highest average RF output power channel for the lowest data rate for IEEE 802.11b were selected for SAR evaluation. Other IEEE 802.11 modes (including 802.11g/n) were not investigated since the average output powers over all channels and data rates were not more than 0.25 dB higher than the tested channel in the lowest data rate of IEEE 802.11b mode.
- When the maximum extrapolated peak SAR of the zoom scan for the maximum output channel is <1.6 W/kg and the 1g averaged SAR is <0.8 W/kg, SAR testing on other channels is not required. Otherwise, the other default (or corresponding required) test channels were additionally tested using the lowest data rate.
- The bolded data rate and channel above were tested for SAR.



**Figure 9-3  
Power Measurement Setup**

FCC ID: A3LGT5301B	 PCTEST ENGINEERING LABORATORY, INC.	SAR EVALUATION REPORT		Reviewed by: Quality Manager
Document S/N: 0Y1211121630 – R1.A3L	Test Dates: 11/14/12 - 11/16/12	DUT Type: Portable Handset		Page 18 of 32

# 10 SYSTEM VERIFICATION

## 10.1 Tissue Verification

**Table 10-1  
Measured Tissue Properties**

Calibrated for Tests Performed on:	Tissue Type	Tissue Temp During Calibration (C°)	Measured Frequency (MHz)	Measured Conductivity, $\sigma$ (S/m)	Measured Dielectric Constant, $\epsilon$	TARGET Conductivity, $\sigma$ (S/m)	TARGET Dielectric Constant, $\epsilon$	% dev $\sigma$	% dev $\epsilon$
11/14/2012	835H	20.9	820	0.908	42.61	0.898	41.571	1.11%	2.50%
			835	0.913	42.19	0.900	41.500	1.44%	1.66%
			850	0.929	42.08	0.916	41.500	1.42%	1.40%
11/14/2012	1900H	23.6	1850	1.398	40.11	1.400	40.000	-0.14%	0.27%
			1880	1.432	40.01	1.400	40.000	2.29%	0.02%
			1910	1.466	39.90	1.400	40.000	4.71%	-0.25%
11/16/2012	2450H	24.8	2401	1.711	39.44	1.758	39.298	-2.67%	0.36%
			2450	1.764	39.28	1.800	39.200	-2.00%	0.20%
			2499	1.817	39.08	1.852	39.135	-1.89%	-0.14%
11/15/2012	835B	22.4	820	0.968	55.45	0.969	55.258	-0.10%	0.35%
			835	0.986	55.48	0.970	55.200	1.65%	0.51%
			850	1.007	55.20	0.988	55.154	1.92%	0.08%
11/14/2012	1900B	21.4	1850	1.506	50.99	1.520	53.300	-0.92%	-4.33%
			1880	1.568	50.87	1.520	53.300	3.16%	-4.56%
			1910	1.583	50.73	1.520	53.300	4.14%	-4.82%
11/15/2012	2450B	22.6	2401	1.974	51.51	1.903	52.765	3.73%	-2.38%
			2450	2.032	51.34	1.950	52.700	4.21%	-2.58%
			2499	2.099	51.10	2.019	52.638	3.96%	-2.92%



Note: KDB Publication 450824 was ensured to be applied for probe calibration frequencies greater than or equal to 50 MHz of the DUT frequencies.

## 10.2 Measurement Procedure for Tissue verification

- 1) The network analyzer and probe system was configured and calibrated.
- 2) The probe was immersed in the sample which was placed in a nonmetallic container. Trapped air bubbles beneath the flange were minimized by placing the probe at a slight angle.
- 3) The complex admittance with respect to the probe aperture was measured
- 4) The complex relative permittivity  $\epsilon$  can be calculated from the below equation (Pournaropoulos and Misra):

$$Y = \frac{j2\omega\epsilon_r\epsilon_0}{[\ln(b/a)]^2} \int_a^b \int_a^b \int_0^\pi \cos\phi' \frac{\exp[-j\omega r(\mu_0\epsilon_r'\epsilon_0)^{1/2}]}{r} d\phi'd\rho'd\rho$$

where Y is the admittance of the probe in contact with the sample, the primed and unprimed coordinates refer to source and observation points, respectively,  $r^2 = \rho^2 + \rho'^2 - 2\rho\rho' \cos\phi'$ ,  $\omega$  is the angular frequency, and  $j = \sqrt{-1}$ .

FCC ID: A3LGT5301B	 PCTEST ENGINEERING LABORATORY, INC.	SAR EVALUATION REPORT		Reviewed by: Quality Manager
Document S/N: 0Y1211121630 – R1.A3L	Test Dates: 11/14/12 - 11/16/12	DUT Type: Portable Handset		Page 19 of 32

### 10.3 Test System Verification

Prior to assessment, the system is verified to  $\pm 10\%$  of the manufacturer SAR measurement on the reference dipole at the time of calibration.

**Table 10-2  
System Verification Results**

System Verification TARGET & MEASURED											
Tissue Frequency (MHz)	Tissue Type	Date:	Amb. Temp (°C)	Liquid Temp (°C)	Input Power (W)	Dipole SN	Probe SN	Measured SAR <sub>1g</sub> (W/kg)	1 W Target SAR <sub>1g</sub> (W/kg)	1 W Normalized SAR <sub>1g</sub> (W/kg)	Deviation (%)
835	Head	11/14/2012	23.4	21.7	0.100	4d132	3213	0.947	9.450	9.470	0.21%
1900	Head	11/14/2012	24.8	23.4	0.100	502	3209	3.83	39.200	38.300	-2.30%
2450	Head	11/16/2012	23.3	23.0	0.100	882	3263	4.99	53.500	49.900	-6.73%
835	Body	11/15/2012	23.9	22.9	0.100	4d026	3209	0.984	9.580	9.840	2.71%
1900	Body	11/14/2012	23.5	22.1	0.100	5d149	3288	4.17	39.300	41.700	6.11%
2450	Body	11/15/2012	23.3	22.1	0.040	797	3258	2.07	50.800	51.750	1.87%

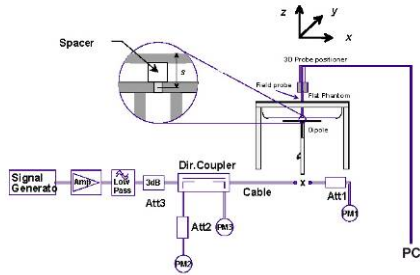

**Figure 10-1  
System Verification Setup Diagram**



**Figure 10-2  
System Verification Setup Photo**

FCC ID: A3LGT5301B	PCTEST ENGINEERING LABORATORY, INC.	SAR EVALUATION REPORT		Reviewed by: Quality Manager
Document S/N: 0Y1211121630 – R1.A3L	Test Dates: 11/14/12 - 11/16/12	DUT Type: Portable Handset		Page 20 of 32

# 11 SAR DATA SUMMARY

## 11.1 Standalone Head SAR Data

**Table 11-1  
GSM 850 Head SAR Results**



MEASUREMENT RESULTS								
FREQUENCY		Mode/Band	Conducted Power [dBm]	Power Drift [dB]	Side	Test Position	Device Serial Number	SAR (1g)
MHz	Ch.							(W/kg)
836.60	190	GSM 850	32.83	0.01	Right	Touch	FJ-295-C	0.526
836.60	190	GSM 850	32.83	-0.01	Right	Tilt	FJ-295-C	0.229
836.60	190	GSM 850	32.83	0.02	Left	Touch	FJ-295-C	0.545
836.60	190	GSM 850	32.83	0.00	Left	Tilt	FJ-295-C	0.215
ANSI / IEEE C95.1 1992 - SAFETY LIMIT Spatial Peak Uncontrolled Exposure/General Population						Head 1.6 W/kg (mW/g) averaged over 1 gram		

**Table 11-2  
UMTS 850 Head SAR Results**

MEASUREMENT RESULTS								
FREQUENCY		Mode/Band	Conducted Power [dBm]	Power Drift [dB]	Side	Test Position	Device Serial Number	SAR (1g)
MHz	Ch.							(W/kg)
836.60	4183	UMTS 850	22.21	0.06	Right	Touch	FJ-295-C	0.263
836.60	4183	UMTS 850	22.21	0.11	Right	Tilt	FJ-295-C	0.114
836.60	4183	UMTS 850	22.21	-0.05	Left	Touch	FJ-295-C	0.313
836.60	4183	UMTS 850	22.21	-0.06	Left	Tilt	FJ-295-C	0.122
ANSI / IEEE C95.1 1992 - SAFETY LIMIT Spatial Peak Uncontrolled Exposure/General Population						Head 1.6 W/kg (mW/g) averaged over 1 gram		

**Table 11-3  
GSM 1900 Head SAR Results**

MEASUREMENT RESULTS								
FREQUENCY		Mode/Band	Conducted Power [dBm]	Power Drift [dB]	Side	Test Position	Device Serial Number	SAR (1g)
MHz	Ch.							(W/kg)
1880.00	661	GSM 1900	30.55	-0.01	Right	Touch	FJ-295-C	0.598
1880.00	661	GSM 1900	30.55	-0.03	Right	Tilt	FJ-295-C	0.305
1850.20	512	GSM 1900	30.80	0.15	Left	Touch	FJ-295-C	0.910
1880.00	661	GSM 1900	30.55	0.14	Left	Touch	FJ-295-C	0.827
1909.80	810	GSM 1900	30.63	0.15	Left	Touch	FJ-295-C	0.873
1880.00	661	GSM 1900	30.55	-0.03	Left	Tilt	FJ-295-C	0.269
ANSI / IEEE C95.1 1992 - SAFETY LIMIT Spatial Peak Uncontrolled Exposure/General Population						Head 1.6 W/kg (mW/g) averaged over 1 gram		

FCC ID: A3LGT5301B	 PCTEST ENGINEERING LABORATORY, INC.	SAR EVALUATION REPORT		Reviewed by: Quality Manager
Document S/N: 0Y1211121630 – R1.A3L	Test Dates: 11/14/12 - 11/16/12	DUT Type: Portable Handset		Page 21 of 32

**Table 11-4  
2.4 GHz WLAN Head SAR Results**

MEASUREMENT RESULTS										
FREQUENCY		Mode	Service	Conducted Power [dBm]	Power Drift [dB]	Side	Test Position	Device Serial Number	Data Rate (Mbps)	SAR (1g)
MHz	Ch.									(W/kg)
2412	1	IEEE 802.11b	DSSS	15.70	0.12	Right	Touch	FJ-295-B	1	0.112
2412	1	IEEE 802.11b	DSSS	15.70	0.16	Right	Tilt	FJ-295-B	1	0.062
2412	1	IEEE 802.11b	DSSS	15.70	0.05	Left	Touch	FJ-295-B	1	0.273
2412	1	IEEE 802.11b	DSSS	15.70	-0.10	Left	Tilt	FJ-295-B	1	0.121
ANSI / IEEE C95.1 1992 - SAFETY LIMIT Spatial Peak Uncontrolled Exposure/General Population						Head 1.6 W/kg (mW/g) averaged over 1 gram				

## 11.2 Standalone Body-Worn SAR Data

**Table 11-5  
Licensed Transmitter Body-Worn SAR Results**



MEASUREMENT RESULTS										
FREQUENCY		Mode	Service	Conducted Power [dBm]	Power Drift [dB]	Spacing	Device Serial Number	# of Time Slots	Side	SAR (1g)
MHz	Ch.									(W/kg)
836.60	190	GSM 850	GSM	32.83	0.02	1.0 cm	FJ-295-C	1	back	0.622
836.60	190	GSM 850	GPRS	30.45	-0.03	1.0 cm	FJ-295-C	2	back	0.638
836.60	4183	UMTS 850	RMC	22.21	-0.02	1.0 cm	FJ-295-C	N/A	back	0.408
1880.00	661	GSM 1900	GSM	30.55	-0.03	1.0 cm	FJ-295-C	1	back	0.358
1880.00	661	GSM 1900	GPRS	28.01	0.00	1.0 cm	FJ-295-C	2	back	0.391
ANSI / IEEE C95.1 1992 - SAFETY LIMIT Spatial Peak Uncontrolled Exposure/General Population						Body 1.6 W/kg (mW/g) averaged over 1 gram				

Note: When the reported SAR measured for 1 cm air-gap without headset cable is >1.2 W/kg, the highest reported SAR configuration for the mode and band should be repeated with headset attached, per FCC guidance. Since the measured SAR was not >1.2 W/kg, GPRS and UMTS hotspot data for the back side configuration additionally shows body-worn compliance. GSM voice SAR tests were performed with headset cable connected.

**Table 11-6  
WLAN Body-Worn SAR Results**

MEASUREMENT RESULTS										
FREQUENCY		Mode	Service	Conducted Power [dBm]	Power Drift [dB]	Spacing	Device Serial Number	Data Rate (Mbps)	Side	SAR (1g)
MHz	Ch.									(W/kg)
2412	1	IEEE 802.11b	DSSS	15.70	0.04	1.0 cm	FJ-295-C	1	back	0.123
ANSI / IEEE C95.1 1992 - SAFETY LIMIT Spatial Peak Uncontrolled Exposure/General Population						Body 1.6 W/kg (mW/g) averaged over 1 gram				

Note: When the reported SAR measured for 1 cm air-gap without headset cable is >1.2 W/kg, the highest reported SAR configuration for the mode and band should be repeated with headset attached, per FCC guidance. Since the measured SAR was not >1.2 W/kg, IEEE 802.11b hotspot data for the back side configuration additionally shows body-worn compliance.

FCC ID: A3LGT5301B	 PCTEST ENGINEERING LABORATORY, INC.	SAR EVALUATION REPORT		Reviewed by: Quality Manager
Document S/N: 0Y1211121630 - R1.A3L	Test Dates: 11/14/12 - 11/16/12	DUT Type: Portable Handset		Page 22 of 32

### 11.3 Standalone Wireless Router SAR Data

**Table 11-7  
Licensed Transmitter Hotspot SAR Data**

MEASUREMENT RESULTS										
FREQUENCY		Mode	Service	Conducted Power [dBm]	Power Drift [dB]	Spacing	Device Serial Number	# of GPRS Slots	Side	SAR (1g)
MHz	Ch.									(W/kg)
836.60	190	GSM 850	GPRS	30.45	-0.03	1.0 cm	FJ-295-C	2	back	0.638
836.60	190	GSM 850	GPRS	30.45	-0.03	1.0 cm	FJ-295-C	2	front	0.443
836.60	190	GSM 850	GPRS	30.45	-0.04	1.0 cm	FJ-295-C	2	bottom	0.079
836.60	190	GSM 850	GPRS	30.45	-0.08	1.0 cm	FJ-295-C	2	right	0.197
836.60	190	GSM 850	GPRS	30.45	-0.06	1.0 cm	FJ-295-C	2	left	0.230
836.60	4183	UMTS 850	RMC	22.21	-0.02	1.0 cm	FJ-295-C	N/A	back	0.408
836.60	4183	UMTS 850	RMC	22.21	-0.04	1.0 cm	FJ-295-C	N/A	front	0.248
836.60	4183	UMTS 850	RMC	22.21	0.04	1.0 cm	FJ-295-C	N/A	bottom	0.038
836.60	4183	UMTS 850	RMC	22.21	-0.08	1.0 cm	FJ-295-C	N/A	right	0.075
836.60	4183	UMTS 850	RMC	22.21	-0.06	1.0 cm	FJ-295-C	N/A	left	0.120
1880.00	661	GSM 1900	GPRS	28.01	0.00	1.0 cm	FJ-295-C	2	back	0.391
1880.00	661	GSM 1900	GPRS	28.01	-0.02	1.0 cm	FJ-295-C	2	front	0.369
1880.00	661	GSM 1900	GPRS	28.01	0.05	1.0 cm	FJ-295-C	2	bottom	0.275
1880.00	661	GSM 1900	GPRS	28.01	0.11	1.0 cm	FJ-295-C	2	right	0.086
1880.00	661	GSM 1900	GPRS	28.01	-0.02	1.0 cm	FJ-295-C	2	left	0.130
ANSI / IEEE C95.1 1992 - SAFETY LIMIT Spatial Peak Uncontrolled Exposure/General Population						Body 1.6 W/kg (mW/g) averaged over 1 gram				



**Table 11-8  
WLAN Hotspot SAR Data**

MEASUREMENT RESULTS										
FREQUENCY		Mode	Service	Conducted Power [dBm]	Power Drift [dB]	Spacing	Device Serial Number	Data Rate (Mbps)	Side	SAR (1g)
MHz	Ch.									(W/kg)
2412	1	IEEE 802.11b	DSSS	15.70	0.04	1.0 cm	FJ-295-C	1	back	0.123
2412	1	IEEE 802.11b	DSSS	15.70	-0.04	1.0 cm	FJ-295-C	1	front	0.122
2412	1	IEEE 802.11b	DSSS	15.70	-0.03	1.0 cm	FJ-295-C	1	top	0.049
2412	1	IEEE 802.11b	DSSS	15.70	-0.02	1.0 cm	FJ-295-C	1	right	0.152
ANSI / IEEE C95.1 1992 - SAFETY LIMIT Spatial Peak Uncontrolled Exposure/General Population						Body 1.6 W/kg (mW/g) averaged over 1 gram				

### 11.4 SAR Test Notes

General Notes:

1. The test data reported are the worst-case SAR value with the position set in a typical configuration. Test procedures used were according to FCC/OET Bulletin 65, Supplement C [June 2001].
2. Batteries are fully charged for all readings. The standard battery was used.
3. Tissue parameters and temperatures are listed on the SAR plots.

FCC ID: A3LGT5301B	 PCTEST ENGINEERING LABORATORY, INC.	SAR EVALUATION REPORT		Reviewed by: Quality Manager
Document S/N: 0Y1211121630 – R1.A3L	Test Dates: 11/14/12 - 11/16/12	DUT Type: Portable Handset		Page 23 of 32

4. Liquid tissue depth was at least 15.0 cm. To confirm the proper SAR liquid depth, the z-axis plots from the system verifications were included since the system verifications were performed using the same liquid, probe and DAE as the SAR tests in the same time period.
5. The manufacturer has confirmed that the device(s) tested have the same physical, mechanical and thermal characteristics and are within operational tolerances expected for production units.
6. Per FCC/OET Bulletin 65 Supplement C and Public Notice DA-02-1438, if the SAR measured at the middle channel for each test configuration is at least 3.0 dB lower than the SAR limit, testing at the high and low channels is optional for such test configuration(s).
7. Device was tested using a fixed spacing for body-worn accessory testing. A separation distance of 10 mm was considered because the manufacturer has determined that there will be body-worn accessories available in the marketplace for users to support this separation distance.

**GSM Test Notes:**

1. Body-Worn accessory testing is typically associated with voice operations. Therefore, GSM voice was evaluated for body-worn SAR using headphones.
2. When the reported SAR measured for 1 cm air-gap without headset cable is >1.2 W/kg, the highest reported SAR configuration for the mode and band should be repeated with headset attached, per FCC guidance. Since the measured SAR was not >1.2 W/kg, GPRS hotspot data for the back side configuration additionally shows body-worn compliance.
3. Justification for reduced test configurations per KDB Publication 941225 D03: The source-based time-averaged output power was evaluated for all multi-slot operations. The worst-case source-based time-averaged powers were evaluated for SAR.

**UMTS Notes:**



1. UMTS mode in Body SAR was tested under RMC 12.2 kbps with HSPA Inactive per KDB Publication 941225 D01. HSPA SAR was not required since the average output power of the HSPA subtests was not more than 0.25 dB higher than the RMC level and SAR was less than 1.2 W/kg.
2. When the reported SAR measured for 1 cm air-gap without headset cable is >1.2 W/kg, the highest reported SAR configuration for the mode and band should be repeated with headset attached, per FCC guidance. Since the measured SAR was not >1.2 W/kg, UMTS hotspot data for the back side configuration additionally shows body-worn compliance.

**WLAN Notes:**

3. Justification for reduced test configurations for WIFI channels per KDB Publication 248227 and April 2010 FCC/TCB Meeting Notes for 2.4 GHz WIFI: Highest average RF output power channel for the lowest data rate was selected for SAR evaluation in 802.11b. Other IEEE 802.11 modes (including 802.11g/n) were not investigated since the average output powers over all channels and data rates were not more than 0.25 dB higher than the tested channel in the lowest data rate of IEEE 802.11b mode.
4. WLAN transmission was verified using an uncalibrated spectrum analyzer.
5. When the maximum extrapolated peak SAR of the zoom scan for the maximum output channel is <1.6 W/kg and the 1g averaged SAR is <0.8 W/kg, SAR testing on other channels is not required. Otherwise, the other default (or corresponding required) test channels were additionally tested using the lowest data rate.
6. When the reported SAR measured for 1 cm air-gap without headset cable is >1.2 W/kg, the highest reported SAR configuration for the mode and band should be repeated with headset attached, per FCC guidance. Since the measured SAR was not >1.2 W/kg, IEEE 802.11b hotspot data for the back side configuration additionally shows body-worn compliance..

**Hotspot Notes:**

1. Top Edge for the licensed transmitter was not tested since the antenna distance from the edge was greater than 2.5 cm per FCC KDB Publication 941225 D06 guidance (see Section 1.2).
2. Bottom and Left Edges for the WLAN transmitter were not tested since the antenna distance from the edge was greater than 2.5 cm per FCC KDB Publication 941225 D06 (see Section 1.2).
3. During SAR Testing for the Wireless Router conditions per KDB 941225 D06, the actual Portable Hotspot operation (with actual simultaneous transmission of a transmitter with WIFI) was not activated (See Section 6.6.)

<b>FCC ID:</b> A3LGT5301B		<b>SAR EVALUATION REPORT</b>		<b>Reviewed by:</b> Quality Manager
<b>Document S/N:</b> 0Y1211121630 – R1.A3L	<b>Test Dates:</b> 11/14/12 - 11/16/12	<b>DUT Type:</b> Portable Handset	Page 24 of 32	

## 12 FCC MULTI-TX AND ANTENNA SAR CONSIDERATIONS

### 12.1 Introduction

The following procedures adopted from “FCC SAR Considerations for Cell Phones with Multiple Transmitters” FCC KDB Publication 648474 are applicable to handsets with built-in unlicensed transmitters such as 802.11b/g/n and Bluetooth devices which may simultaneously transmit with the licensed transmitter.

### 12.2 FCC Power Tables & Conditions

	2.45	5.15 - 5.35	5.47 - 5.85	GHz
$P_{Ref}$	12	6	5	mW

Device output power should be rounded to the nearest mW to compare with values specified in this table.

**Figure 12-1  
Output Power Thresholds for Unlicensed Transmitters**

	Individual Transmitter	Simultaneous Transmission
<b>Licensed Transmitters</b>	<u>Routine evaluation required</u>	<b>SAR not required:</b> <u>Unlicensed only</u>
<b>Unlicensed Transmitters</b>	<p><b>When there is no simultaneous transmission –</b></p> <ul style="list-style-type: none"> <li>o output <math>\leq 60/f</math>: SAR not required</li> <li>o output <math>&gt; 60/f</math>: stand-alone SAR required</li> </ul> <p><b>When there is simultaneous transmission –</b>  <u>Stand-alone SAR not required when</u></p> <ul style="list-style-type: none"> <li>o output <math>\leq 2 \cdot P_{Ref}</math> and antenna is <math>\geq 5.0</math> cm from other antennas</li> <li>o output <math>\leq P_{Ref}</math> and antenna is <math>\geq 2.5</math> cm from other antennas</li> <li>o output <math>\leq P_{Ref}</math> and antenna is <math>&lt; 2.5</math> cm from other antennas, each with either output power <math>\leq P_{Ref}</math> or 1-g SAR <math>&lt; 1.2</math> W/kg</li> </ul> <p><u>Otherwise stand-alone SAR is required</u></p> <p><b>When stand-alone SAR is required</b></p> <ul style="list-style-type: none"> <li>o test SAR on highest output channel for each wireless mode and exposure condition</li> <li>o if SAR for highest output channel is <math>&gt; 50\%</math> of SAR limit, evaluate all channels according to normal procedures</li> </ul>	<ul style="list-style-type: none"> <li>o when stand-alone 1-g SAR is not required and antenna is <math>\geq 5</math> cm from other antennas</li> </ul> <p><u>Licensed &amp; Unlicensed</u></p> <ul style="list-style-type: none"> <li>o when the sum of the 1-g SAR is <math>&lt; 1.6</math> W/kg for all simultaneous transmitting antennas</li> <li>o when SAR to peak location separation ratio of simultaneous transmitting antenna pair is <math>&lt; 0.3</math></li> </ul> <p><b>SAR required:</b>  <u>Licensed &amp; Unlicensed</u></p> <p>antenna pairs with SAR to peak location separation ratio <math>\geq 0.3</math>; test is only required for the configuration that results in the highest SAR in stand-alone configuration for each wireless mode and exposure condition</p> <p><b>Note: simultaneous transmission exposure conditions for head and body can be different for different style phones; therefore, different test requirements may apply</b></p>

**Figure 12-2  
SAR Evaluation Requirements for Multiple Transmitter Handsets**

According to Figure 12-1 and Figure 12-2, simultaneous transmission analysis of SAR may be required for this device for the licensed and unlicensed transmitters. Possible simultaneous transmissions for this device were numerically summed using stand-alone SAR data and are shown in the following tables.

Per KDB Publication 648474, standalone Bluetooth SAR tests were not required. Standalone SAR tests for WLAN were required. See Section 1.3(A) for more information.

FCC ID: A3LGT55301B		SAR EVALUATION REPORT		Reviewed by: Quality Manager
Document S/N: 0Y1211121630 – R1.A3L	Test Dates: 11/14/12 - 11/16/12	DUT Type: Portable Handset		Page 25 of 32

## 12.3 Head SAR Simultaneous Transmission Analysis

**Table 12-1**  
**Simultaneous Transmission Scenario (Held to Ear)**

Simult Tx	Configuration	GSM 850 SAR (W/kg)	2.4 GHz WLAN SAR (W/kg)	$\Sigma$ SAR (W/kg)
Head SAR	Right Cheek	0.526	0.112	0.638
	Right Tilt	0.229	0.062	0.291
	Left Cheek	0.545	0.273	<b>0.818</b>
	Left Tilt	0.215	0.121	0.336
Simult Tx	Configuration	UMTS 850 SAR (W/kg)	2.4 GHz WLAN SAR (W/kg)	$\Sigma$ SAR (W/kg)
Head SAR	Right Cheek	0.263	0.112	0.375
	Right Tilt	0.114	0.062	0.176
	Left Cheek	0.313	0.273	<b>0.586</b>
	Left Tilt	0.122	0.121	0.243
Simult Tx	Configuration	GSM 1900 SAR (W/kg)	2.4 GHz WLAN SAR (W/kg)	$\Sigma$ SAR (W/kg)
Head SAR	Right Cheek	0.598	0.112	0.710
	Right Tilt	0.305	0.062	0.367
	Left Cheek	0.910	0.273	<b>1.183</b>
	Left Tilt	0.269	0.121	0.390



The above tables represent a held to ear voice call potentially simultaneously operating with 2.4 GHz WLAN.

## 12.4 Body-Worn Simultaneous Transmission Analysis

**Table 12-2**  
**Simultaneous Transmission Scenario (Body-Worn at 1.0 cm)**

Configuration	Mode	2G/3G SAR (W/kg)	2.4 GHz WLAN SAR (W/kg)	$\Sigma$ SAR (W/kg)
Back Side	GSM 850	0.622	0.123	<b>0.745</b>
Back Side	UMTS 850	0.408	0.123	0.531
Back Side	GSM 1900	0.358	0.123	0.481

The above tables represent a body-worn voice call potentially simultaneously operating with 2.4 GHz WLAN.

FCC ID: A3LGTS5301B	 PCTEST ENGINEERING LABORATORY, INC.	SAR EVALUATION REPORT		Reviewed by: Quality Manager
Document S/N: 0Y1211121630 – R1.A3L	Test Dates: 11/14/12 - 11/16/12	DUT Type: Portable Handset		Page 26 of 32

## 12.5 Hotspot SAR Simultaneous Transmission Analysis

**Table 12-3**  
**Simultaneous Transmission Scenario (Hotspot at 1.0 cm)**

Simult Tx	Configuration	GPRS 850 SAR (W/kg)	2.4 GHz WLAN SAR (W/kg)	Σ SAR (W/kg)	Simult Tx	Configuration	UMTS 850 SAR (W/kg)	2.4 GHz WLAN SAR (W/kg)	Σ SAR (W/kg)
Body SAR	Back	0.638	0.123	<b>0.761</b>	Body SAR	Back	0.408	0.123	<b>0.531</b>
	Front	0.443	0.122	0.565		Front	0.248	0.122	0.370
	Top	-	0.049	0.049		Top	-	0.049	0.049
	Bottom	0.079	-	0.079		Bottom	0.038	-	0.038
	Right	0.197	0.152	0.349		Right	0.075	0.152	0.227
	Left	0.230	-	0.230		Left	0.120	-	0.120



  

Simult Tx	Configuration	GPRS 1900 SAR (W/kg)	2.4 GHz WLAN SAR (W/kg)	Σ SAR (W/kg)
Body SAR	Back	0.391	0.123	<b>0.514</b>
	Front	0.369	0.122	0.491
	Top	-	0.049	0.049
	Bottom	0.275	-	0.275
	Right	0.086	0.152	0.238
	Left	0.130	-	0.130

Note: Per FCC KDB Publication 941225 D06, the edges with antennas more than 2.5 cm are not required to be evaluated for SAR (“-”). The above tables represent a portable hotspot condition.

## 12.6 Simultaneous Transmission Conclusion



The above numerical summed SAR was below the SAR limit. Therefore, the above analysis is sufficient to determine that simultaneous transmission cases will not exceed the SAR limit. No volumetric SAR summation is required per FCC KDB Publication 648474. It was confirmed that all standalone and simultaneous transmission scenarios remain compliant when scaled to the maximum allowed power level.

FCC ID: A3LGTS5301B	 <b>PCTEST</b> ENGINEERING LABORATORY, INC.	<b>SAR EVALUATION REPORT</b>		<b>Reviewed by:</b> Quality Manager
<b>Document S/N:</b> 0Y1211121630 – R1.A3L	<b>Test Dates:</b> 11/14/12 - 11/16/12	<b>DUT Type:</b> Portable Handset	Page 27 of 32	

# 13 EQUIPMENT LIST

Manufacturer	Model	Description	Cal Date	Cal Interval	Cal Due	Serial Number
Agilent	E8257D	(250kHz-20GHz) Signal Generator	4/5/2012	Annual	4/5/2013	MY45470194
Agilent	8753E	(30kHz-6GHz) Network Analyzer	4/3/2012	Annual	4/3/2013	US37390350
Agilent	8753E	(30kHz-6GHz) Network Analyzer	4/4/2012	Annual	4/4/2013	JP38020182
Agilent	8594A	(9kHz-2.9GHz) Spectrum Analyzer	N/A	N/A	N/A	3051A00187
Agilent	8648D	(9kHz-4GHz) Signal Generator	10/10/2012	Annual	10/10/2013	3613A00315
Agilent	85070E	Dielectric Probe Kit	3/8/2012	Annual	3/8/2013	MY44300633
Agilent	8648D	Signal Generator	4/3/2012	Annual	4/3/2013	3629U00687
Agilent	85047A	S-Parameter Test Set	N/A	N/A	N/A	2904A00579
Amplifier Research	5S1G4	5W, 800MHz-4.2GHz	CBT	N/A	CBT	21910
Anritsu	ML2438A	Power Meter	2/14/2012	Annual	2/14/2013	1190013
Anritsu	ML2438A	Power Meter	2/14/2012	Annual	2/14/2013	98150041
Anritsu	ML2495A	Power Meter	10/11/2012	Annual	10/11/2013	1039008
Anritsu	MA2481A	Power Sensor	2/14/2012	Annual	2/14/2013	2400
Anritsu	MA2411B	Power Sensor	3/5/2012	Annual	3/5/2013	846215
Anritsu	MA2481A	Power Sensor	4/5/2012	Annual	4/5/2013	5605
Anritsu	MA2411B	Pulse Sensor	9/19/2012	Annual	9/19/2013	1027293
Anritsu	MT8820C	Radio Communication Tester	11/6/2012	Annual	11/6/2013	6200901190
Anritsu	MA24106A	USB Power Sensor	8/22/2012	Annual	8/22/2013	1231538
Anritsu	MA24106A	USB Power Sensor	8/22/2012	Annual	8/22/2013	1231535
COMTECH	AR85729-5/5759B	Solid State Amplifier	CBT	N/A	CBT	M3W1A00-1002
COMTECH	AR85729-5	Solid State Amplifier	CBT	N/A	CBT	M1S5A00-009
Gigatronics	80701A	(0.05-18GHz) Power Sensor	10/10/2012	Annual	10/10/2013	1833460
Gigatronics	8651A	Universal Power Meter	10/10/2012	Annual	10/10/2013	8650319
Intelligent Weigh	PD-3000	Electronic Balance	3/27/2012	Annual	3/27/2013	11081534
Intelligent Weighing	PD-3000	Electronic Balance	6/29/2012	Annual	6/29/2013	120405017
MCL	BW-N6W5+	6dB Attenuator	CBT	N/A	CBT	1139
MiniCircuits	VLF-6000+	Low Pass Filter	CBT	N/A	CBT	N/A
MiniCircuits	SLP-2400+	Low Pass Filter	CBT	N/A	CBT	R8979500903
Mini-Circuits	BW-N20W5+	DC to 18 GHz Precision Fixed 20 dB Attenuator	CBT	N/A	CBT	N/A
Mini-Circuits	NLP-1200+	Low Pass Filter DC to 1000 MHz	CBT	N/A	CBT	N/A
Mini-Circuits	NLP-2950+	Low Pass Filter DC to 2700 MHz	CBT	N/A	CBT	N/A
Mini-Circuits	BW-N20W5	Power Attenuator	CBT	N/A	CBT	1226
Narda	4014C-6	4 - 8 GHz SMA 6 dB Directional Coupler	CBT	N/A	CBT	N/A
Narda	4772-3	Attenuator (3dB)	CBT	N/A	CBT	9406
Narda	BW-S3W2	Attenuator (3dB)	CBT	N/A	CBT	120
Pasternack	PE2208-6	Bidirectional Coupler	CBT	N/A	CBT	N/A
Pasternack	PE2209-10	Bidirectional Coupler	CBT	N/A	CBT	N/A
Rohde & Schwarz	CMU200	Base Station Simulator	5/22/2012	Annual	5/22/2013	109892
Rohde & Schwarz	NRVD	Dual Channel Power Meter	10/12/2012	Biennial	10/12/2014	101695
Rohde & Schwarz	NRV-Z32	Peak Power Sensor	10/12/2012	Biennial	10/12/2014	836019/013
Rohde & Schwarz	SMI003B	Signal Generator	4/5/2012	Annual	4/5/2013	DE27259
Rohde & Schwarz	SME06	Signal Generator	10/11/2012	Annual	10/11/2013	832026
Seekonk	NC-100	Torque Wrench (8" lb)	3/5/2012	Triennial	3/5/2015	N/A
SPEAG	D1900V2	1900 MHz SAR Dipole	2/22/2012	Annual	2/22/2013	502
SPEAG	D1900V2	1900 MHz SAR Dipole	2/22/2012	Annual	2/22/2013	5d149
SPEAG	D2450V2	2450 MHz SAR Dipole	1/24/2012	Annual	1/24/2013	797
SPEAG	D2450V2	2450 MHz SAR Dipole	2/7/2012	Annual	2/7/2013	882
SPEAG	D835V2	835 MHz SAR Dipole	2/3/2012	Annual	2/3/2013	4d132
SPEAG	D835V2	835 MHz SAR Dipole	8/23/2012	Annual	8/23/2013	4d026
SPEAG	DAE4	Dasy Data Acquisition Electronics	1/18/2012	Annual	1/18/2013	1272
SPEAG	DAE4	Dasy Data Acquisition Electronics	2/20/2012	Annual	2/20/2013	649
SPEAG	DAE4	Dasy Data Acquisition Electronics	4/19/2012	Annual	4/19/2013	665
SPEAG	DAE4	Dasy Data Acquisition Electronics	5/7/2012	Annual	5/7/2013	1334
SPEAG	DAE4	Dasy Data Acquisition Electronics	9/19/2012	Annual	9/19/2013	1323
SPEAG	DAK-3.5	Dielectric Assessment Kit	6/19/2012	Annual	6/19/2013	1070
SPEAG	ES3DV3	SAR Probe	2/21/2012	Annual	2/21/2013	3258
SPEAG	ES3DV3	SAR Probe	3/16/2012	Annual	3/16/2013	3209
SPEAG	ES3DV3	SAR Probe	4/24/2012	Annual	4/24/2013	3213
SPEAG	ES3DV3	SAR Probe	5/18/2012	Annual	5/18/2013	3263
SPEAG	ES3DV3	SAR Probe	9/20/2012	Annual	9/20/2013	3288
Tektronix	RSA-6114A	Real Time Spectrum Analyzer	4/5/2012	Annual	4/5/2013	B010177
VWR	23226-658	Long Stem Thermometer	3/30/2012	Biennial	3/30/2014	122179874
VWR	23226-658	Long Stem Thermometer	5/16/2012	Biennial	5/16/2014	122295544
VWR	36934-158	Wall-Mounted Thermometer	1/21/2011	Biennial	1/21/2013	111286445



Note: CBT (Calibrated Before Testing). Prior to testing, the measurement paths containing a cable, attenuator, amplifier, coupler or filter were connected to a calibrated source (i.e. a signal generator) to determine the losses of the measurement path. The power meter offset was then adjusted to compensate for the measurement system losses. This level offset is stored within the power meter before measurements are made. This calibration verification procedure applies to the system verification and output power measurements. The calibrated reading is then taken directly from the power meter after compensation of the losses for all final power measurements.

FCC ID: A3LGT5301B	 PCTEST ENGINEERING LABORATORY, INC.	SAR EVALUATION REPORT		Reviewed by: Quality Manager
Document S/N: 0Y1211121630 - R1.A3L	Test Dates: 11/14/12 - 11/16/12	DUT Type: Portable Handset	Page 28 of 32	

# 14 MEASUREMENT UNCERTAINTIES

a	b	c	d	e= f(d,k)	f	g	h = c x f/e	i = c x g/e	k	
Uncertainty Component	IEEE 1528 Sec.	Tol. (± %)	Prob. Dist.	Div.	c <sub>i</sub> 1gm	c <sub>i</sub> 10 gms	1gm u <sub>i</sub> (± %)	10gms u <sub>i</sub> (± %)	v <sub>i</sub>	
<b>Measurement System</b>										
Probe Calibration	E.2.1	6.0	N	1	1.0	1.0	6.0	6.0	∞	
Axial Isotropy	E.2.2	0.25	N	1	0.7	0.7	0.2	0.2	∞	
Hemishperical Isotropy	E.2.2	1.3	N	1	1.0	1.0	1.3	1.3	∞	
Boundary Effect	E.2.3	0.4	N	1	1.0	1.0	0.4	0.4	∞	
Linearity	E.2.4	0.3	N	1	1.0	1.0	0.3	0.3	∞	
System Detection Limits	E.2.5	5.1	N	1	1.0	1.0	5.1	5.1	∞	
Readout Electronics	E.2.6	1.0	N	1	1.0	1.0	1.0	1.0	∞	
Response Time	E.2.7	0.8	R	1.73	1.0	1.0	0.5	0.5	∞	
Integration Time	E.2.8	2.6	R	1.73	1.0	1.0	1.5	1.5	∞	
RF Ambient Conditions	E.6.1	3.0	R	1.73	1.0	1.0	1.7	1.7	∞	
Probe Positioner Mechanical Tolerance	E.6.2	0.4	R	1.73	1.0	1.0	0.2	0.2	∞	
Probe Positioning w/ respect to Phantom	E.6.3	2.9	R	1.73	1.0	1.0	1.7	1.7	∞	
Extrapolation, Interpolation & Integration algorithms for Max. SAR Evaluation	E.5	1.0	R	1.73	1.0	1.0	0.6	0.6	∞	
<b>Test Sample Related</b>										
Test Sample Positioning	E.4.2	6.0	N	1	1.0	1.0	6.0	6.0	287	
Device Holder Uncertainty	E.4.1	3.32	R	1.73	1.0	1.0	1.9	1.9	∞	
Output Power Variation - SAR drift measurement	6.6.2	5.0	R	1.73	1.0	1.0	2.9	2.9	∞	
<b>Phantom &amp; Tissue Parameters</b>										
Phantom Uncertainty (Shape & Thickness tolerances)	E.3.1	4.0	R	1.73	1.0	1.0	2.3	2.3	∞	
Liquid Conductivity - deviation from target values	E.3.2	5.0	R	1.73	0.64	0.43	1.8	1.2	∞	
Liquid Conductivity - measurement uncertainty	E.3.3	3.8	N	1	0.64	0.43	2.4	1.6	6	
Liquid Permittivity - deviation from target values	E.3.2	5.0	R	1.73	0.60	0.49	1.7	1.4	∞	
Liquid Permittivity - measurement uncertainty	E.3.3	4.5	N	1	0.60	0.49	2.7	2.2	6	
<b>Combined Standard Uncertainty (k=1)</b>							RSS	12.1	11.7	299
<b>Expanded Uncertainty</b> (95% CONFIDENCE LEVEL)							k=2	24.2	23.5	

The above measurement uncertainties are according to IEEE Std. 1528-2003



FCC ID: A3LGT5301B	 PCTEST ENGINEERING LABORATORY, INC.	SAR EVALUATION REPORT		Reviewed by: Quality Manager
Document S/N: 0Y1211121630 – R1.A3L	Test Dates: 11/14/12 - 11/16/12	DUT Type: Portable Handset		Page 29 of 32

## 15 CONCLUSION

### 15.1 Measurement Conclusion



The SAR evaluation indicates that the EUT complies with the RF radiation exposure limits of the FCC and Industry Canada, with respect to all parameters subject to this test. These measurements were taken to simulate the RF effects of RF exposure under worst-case conditions. Precise laboratory measures were taken to assure repeatability of the tests. The results and statements relate only to the item(s) tested.

Please note that the absorption and distribution of electromagnetic energy in the body are very complex phenomena that depend on the mass, shape, and size of the body, the orientation of the body with respect to the field vectors, and the electrical properties of both the body and the environment. Other variables that may play a substantial role in possible biological effects are those that characterize the environment (e.g. ambient temperature, air velocity, relative humidity, and body insulation) and those that characterize the individual (e.g. age, gender, activity level, debilitation, or disease). Because various factors may interact with one another to vary the specific biological outcome of an exposure to electromagnetic fields, any protection guide should consider maximal amplification of biological effects as a result of field-body interactions, environmental conditions, and physiological variables. [3]



<b>FCC ID:</b> A3LGT5301B	 <b>PCTEST</b> ENGINEERING LABORATORY, INC.	<b>SAR EVALUATION REPORT</b>		<b>Reviewed by:</b> Quality Manager
<b>Document S/N:</b> 0Y1211121630 – R1.A3L	<b>Test Dates:</b> 11/14/12 - 11/16/12	<b>DUT Type:</b> Portable Handset		Page 30 of 32

## 16 REFERENCES

- [1] Federal Communications Commission, ET Docket 93-62, Guidelines for Evaluating the Environmental Effects of Radiofrequency Radiation, Aug. 1996.
- [2] ANSI/IEEE C95.1-2005, American National Standard safety levels with respect to human exposure to radio frequency electromagnetic fields, 3kHz to 300GHz, New York: IEEE, 2006.
- [3] ANSI/IEEE C95.1-1992, American National Standard safety levels with respect to human exposure to radio frequency electromagnetic fields, 3kHz to 300GHz, New York: IEEE, Sept. 1992.
- [4] ANSI/IEEE C95.3-2002, IEEE Recommended Practice for the Measurement of Potentially Hazardous Electromagnetic Fields - RF and Microwave, New York: IEEE, December 2002.
- [5] Federal Communications Commission, OET Bulletin 65 (Edition 97-01), Supplement C (Edition 01-01), Evaluating Compliance with FCC Guidelines for Human Exposure to Radiofrequency Electromagnetic Fields, June 2001.
- [6] IEEE Standards Coordinating Committee 34 – IEEE Std. 1528-2003, Recommended Practice for Determining the Peak Spatial-Average Specific Absorption Rate (SAR) in the Human Body Due to Wireless Communications Devices.
- [7] NCRP, National Council on Radiation Protection and Measurements, Biological Effects and Exposure Criteria for RadioFrequency Electromagnetic Fields, NCRP Report No. 86, 1986. Reprinted Feb. 1995.
- [8] T. Schmid, O. Egger, N. Kuster, Automated E-field scanning system for dosimetric assessments, IEEE Transaction on Microwave Theory and Techniques, vol. 44, Jan. 1996, pp. 105-113.
- [9] K. Pokovic, T. Schmid, N. Kuster, Robust setup for precise calibration of E-field probes in tissue simulating liquids at mobile communications frequencies, ICECOM97, Oct. 1997, pp. 120-124.
- [10] K. Pokovic, T. Schmid, and N. Kuster, E-field Probe with improved isotropy in brain simulating liquids, Proceedings of the ELMAR, Zadar, Croatia, June 23-25, 1996, pp. 172-175.
- [11] Schmid & Partner Engineering AG, Application Note: Data Storage and Evaluation, June 1998, p2.
- [12] V. Hombach, K. Meier, M. Burkhardt, E. Kuhn, N. Kuster, The Dependence of EM Energy Absorption upon Human Head Modeling at 900 MHz, IEEE Transaction on Microwave Theory and Techniques, vol. 44 no. 10, Oct. 1996, pp. 1865-1873.
- [13] N. Kuster and Q. Balzano, Energy absorption mechanism by biological bodies in the near field of dipole antennas above 300MHz, IEEE Transaction on Vehicular Technology, vol. 41, no. 1, Feb. 1992, pp. 17-23.
- [14] G. Hartsgrove, A. Kraszewski, A. Surowiec, Simulated Biological Materials for Electromagnetic Radiation Absorption Studies, University of Ottawa, Bioelectromagnetics, Canada: 1987, pp. 29-36.
- [15] Q. Balzano, O. Garay, T. Manning Jr., Electromagnetic Energy Exposure of Simulated Users of Portable Cellular Telephones, IEEE Transactions on Vehicular Technology, vol. 44, no.3, Aug. 1995.
- [16] W. Gander, Computermathematick, Birkhaeuser, Basel, 1992.
- [17] W.H. Press, S.A. Teukolsky, W.T. Vetterling, and B.P. Flannery, Numerical Recipes in C, The Art of Scientific Computing, Second edition, Cambridge University Press, 1992.

<b>FCC ID:</b> A3LGTS5301B		<b>SAR EVALUATION REPORT</b>		<b>Reviewed by:</b> Quality Manager
<b>Document S/N:</b> 0Y1211121630 – R1.A3L	<b>Test Dates:</b> 11/14/12 - 11/16/12	<b>DUT Type:</b> Portable Handset	Page 31 of 32	

- [18] Federal Communications Commission, OET Bulletin 65, Evaluating Compliance with FCC Guidelines for Human Exposure to Radiofrequency Electromagnetic Fields. Supplement C, Dec. 1997.
- [19] N. Kuster, R. Kastle, T. Schmid, Dosimetric evaluation of mobile communications equipment with known precision, IEEE Transaction on Communications, vol. E80-B, no. 5, May 1997, pp. 645-652.
- [20] CENELEC CLC/SC111B, European Prestandard (prENV 50166-2), Human Exposure to Electromagnetic Fields High-frequency: 10kHz-300GHz, Jan. 1995.
- [21] Prof. Dr. Niels Kuster, ETH, Eidgenössische Technische Hochschule Zürich, Dosimetric Evaluation of the Cellular Phone.
- [22] IEC 62209-1, Human exposure to radio frequency fields from hand-held and body-mounted wireless communication devices - Human models, instrumentation, and procedures - Part 1: Procedure to determine the specific absorption rate (SAR) for hand-held devices used in close proximity to the ear (frequency range of 300 MHz to 3 GHz), Feb. 2005.
- [23] Industry Canada RSS-102 Radio Frequency Exposure Compliance of Radiocommunication Apparatus (All Frequency Bands) Issue 4, March 2010.
- [24] Health Canada Safety Code 6 Limits of Human Exposure to Radio Frequency Electromagnetic Fields in the Frequency Range from 3 kHz – 300 GHz, 2009
- [25] FCC Public Notice DA-02-1438. Office of Engineering and Technology Announces a Transition Period for the Phantom Requirements of Supplement C to OET Bulletin 65, June 19, 2002
- [26] FCC SAR Measurement Procedures for 3G Devices KDB Publication 941225
- [27] SAR Measurement procedures for IEEE 802.11a/b/g KDB Publication 248227
- [28] FCC SAR Considerations for Handsets with Multiple Transmitters and Antennas, KDB Publication 648474
- [29] FCC Application Note for SAR Probe Calibration and System Verification Consideration for Measurements at 150 MHz – 3 GHz, KDB Publication 450824
- [30] FCC SAR Evaluation Considerations for Laptop Computers with Antennas Built-in on Display Screens, KDB Publication 616217
- [31] FCC SAR Measurement Requirements for 3 – 6 GHz, KDB Publication 865664
- [32] FCC Mobile Portable RF Exposure Procedure, KDB Publication 447498
- [33] FCC SAR Procedures for Dongle Transmitters, KDB Publication 447498
- [34] Anexo à Resolução No. 533, de 10 de Setembro de 2009.
- [35] FCC SAR Test Considerations for LTE Handsets and Data Modems, KDB Publication 941225.
- [36] IEC 62209-2, Human exposure to radio frequency fields from hand-held and body-mounted wireless communication devices - Human models, instrumentation, and procedures - Part 2: Procedure to determine the specific absorption rate (SAR) for wireless communication devices used in close proximity to the human body (frequency range of 30 MHz to 6 GHz), Mar. 2010.
- [37] FCC Hot Spot SAR v01, KDB Publication 941225 D06.

<b>FCC ID:</b> A3LGT5301B		<b>SAR EVALUATION REPORT</b>		<b>Reviewed by:</b> Quality Manager
<b>Document S/N:</b> 0Y1211121630 – R1.A3L	<b>Test Dates:</b> 11/14/12 - 11/16/12	<b>DUT Type:</b> Portable Handset	Page 32 of 32	

## APPENDIX A: SAR TEST DATA

# PCTEST ENGINEERING LABORATORY, INC.

**DUT: A3LGTS5301B; Type: Portable Handset; Serial: FJ-295-C**

Communication System: GSM; Frequency: 836.6 MHz; Duty Cycle: 1:8.3

Medium: 835 Head; Medium parameters used (interpolated):

$f = 836.6 \text{ MHz}$ ;  $\sigma = 0.915 \text{ mho/m}$ ;  $\epsilon_r = 42.178$ ;  $\rho = 1000 \text{ kg/m}^3$

Phantom section: Right Section

Test Date: 11-14-2012; Ambient Temp: 23.4°C; Tissue Temp: 21.7°C

Probe: ES3DV3 - SN3213; ConvF(6.07, 6.07, 6.07); Calibrated: 4/24/2012;

Sensor-Surface: 4mm (Mechanical Surface Detection)

Electronics: DAE4 Sn665; Calibrated: 4/19/2012

Phantom: SAM Right; Type: QD000P40CD; Serial: 1686

Measurement SW: DASY52, Version 52.8 (3);SEMCAD X Version 14.6.7 (6848)

**Mode: GSM 850, Right Head, Cheek, Mid.ch**

**Area Scan (7x14x1):** Measurement grid: dx=15mm, dy=15mm

**Zoom Scan (5x5x7)/Cube 0:** Measurement grid: dx=8mm, dy=8mm, dz=5mm

Reference Value = 25.182 V/m; Power Drift = 0.01 dB

Peak SAR (extrapolated) = 0.747 W/kg

**SAR(1 g) = 0.526 W/kg**

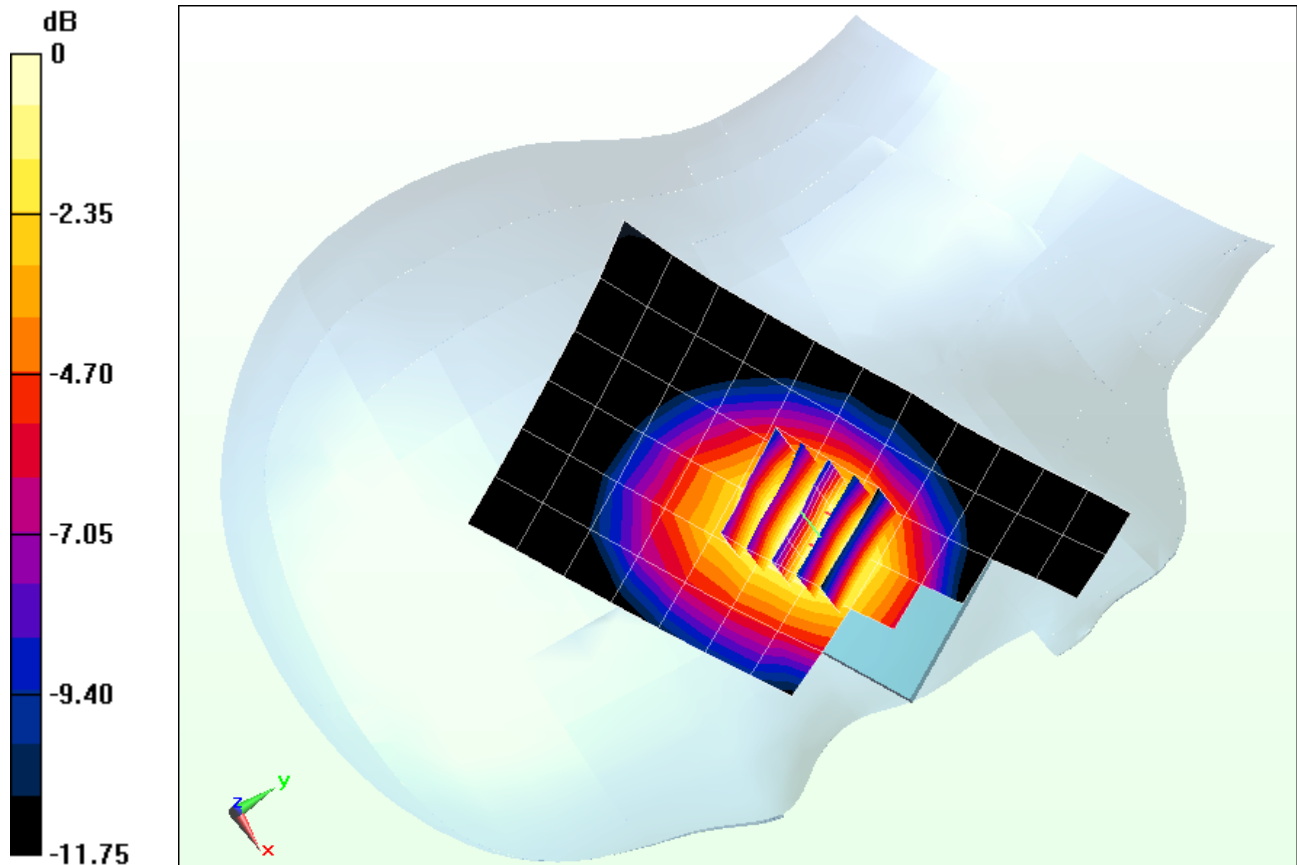

0 dB = 0.554 W/kg = -2.56 dBW/kg

# PCTEST ENGINEERING LABORATORY, INC.

**DUT: A3LGTS5301B; Type: Portable Handset; Serial: FJ-295-C**

Communication System: GSM; Frequency: 836.6 MHz; Duty Cycle: 1:8.3

Medium: 835 Head; Medium parameters used (interpolated):

$f = 836.6 \text{ MHz}$ ;  $\sigma = 0.915 \text{ mho/m}$ ;  $\epsilon_r = 42.178$ ;  $\rho = 1000 \text{ kg/m}^3$

Phantom section: Right Section

Test Date: 11-14-2012; Ambient Temp: 23.4°C; Tissue Temp: 21.7°C

Probe: ES3DV3 - SN3213; ConvF(6.07, 6.07, 6.07); Calibrated: 4/24/2012;

Sensor-Surface: 4mm (Mechanical Surface Detection)

Electronics: DAE4 Sn665; Calibrated: 4/19/2012

Phantom: SAM Right; Type: QD000P40CD; Serial: 1686

Measurement SW: DASY52, Version 52.8 (3); SEMCAD X Version 14.6.7 (6848)

**Mode: GSM 850, Right Head, Tilt, Mid.ch**

**Area Scan (7x14x1):** Measurement grid: dx=15mm, dy=15mm

**Zoom Scan (5x5x7)/Cube 0:** Measurement grid: dx=8mm, dy=8mm, dz=5mm

Reference Value = 16.614 V/m; Power Drift = -0.01 dB

Peak SAR (extrapolated) = 0.280 W/kg

**SAR(1 g) = 0.229 W/kg**

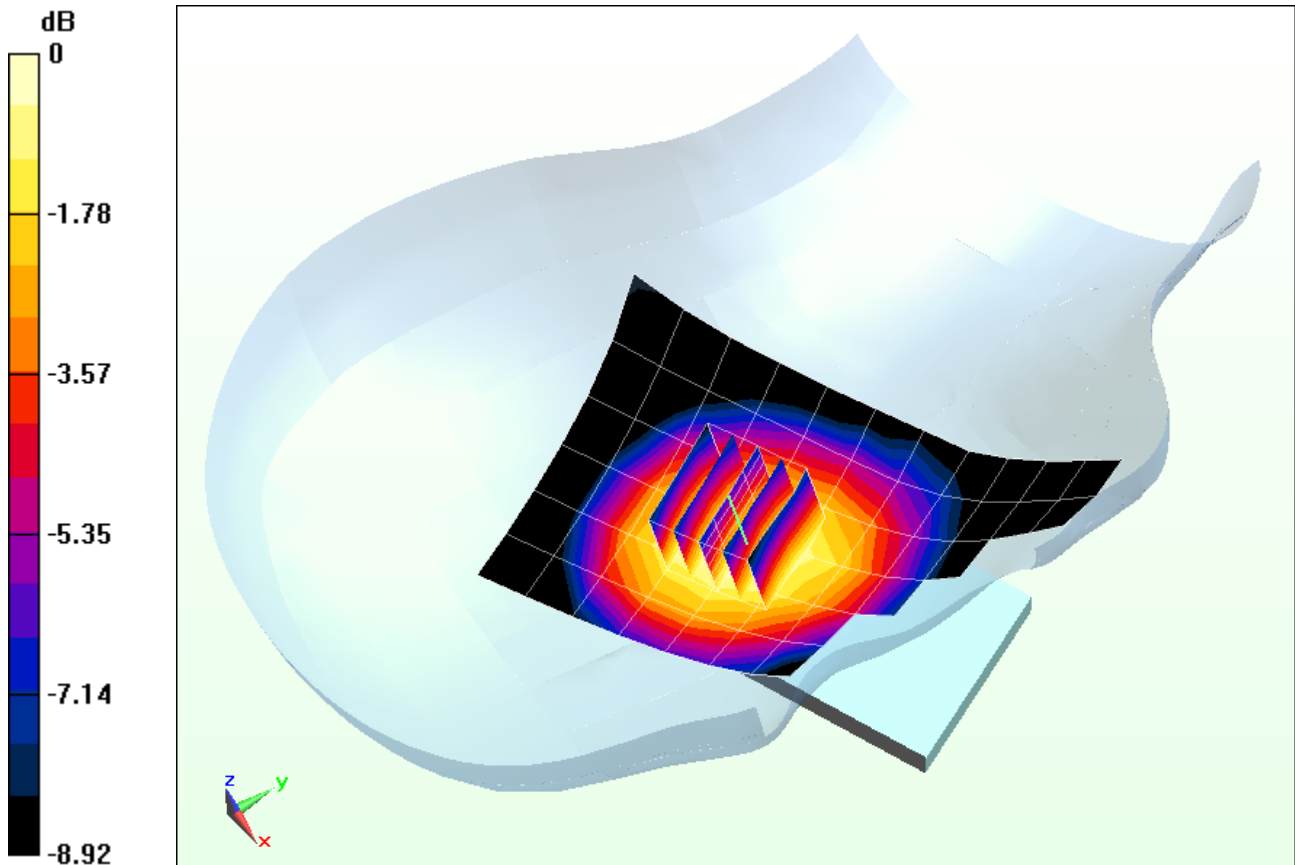

0 dB = 0.241 W/kg = -6.18 dBW/kg

# PCTEST ENGINEERING LABORATORY, INC.

**DUT: A3LGTS5301B; Type: Portable Handset; Serial: FJ-295-C**

Communication System: GSM; Frequency: 836.6 MHz; Duty Cycle: 1:8.3

Medium: 835 Head; Medium parameters used (interpolated):

$f = 836.6 \text{ MHz}$ ;  $\sigma = 0.915 \text{ mho/m}$ ;  $\epsilon_r = 42.178$ ;  $\rho = 1000 \text{ kg/m}^3$

Phantom section: Left Section

Test Date: 11-14-2012; Ambient Temp: 23.4°C; Tissue Temp: 21.7°C

Probe: ES3DV3 - SN3213; ConvF(6.07, 6.07, 6.07); Calibrated: 4/24/2012;

Sensor-Surface: 4mm (Mechanical Surface Detection)

Electronics: DAE4 Sn665; Calibrated: 4/19/2012

Phantom: SAM Right; Type: QD000P40CD; Serial: 1686

Measurement SW: DASY52, Version 52.8 (3); SEMCAD X Version 14.6.7 (6848)

**Mode: GSM 850, Left Head, Cheek, Mid.ch**

**Area Scan (7x14x1):** Measurement grid: dx=15mm, dy=15mm

**Zoom Scan (5x5x7)/Cube 0:** Measurement grid: dx=8mm, dy=8mm, dz=5mm

Reference Value = 25.431 V/m; Power Drift = 0.02 dB

Peak SAR (extrapolated) = 0.758 W/kg

**SAR(1 g) = 0.545 W/kg**

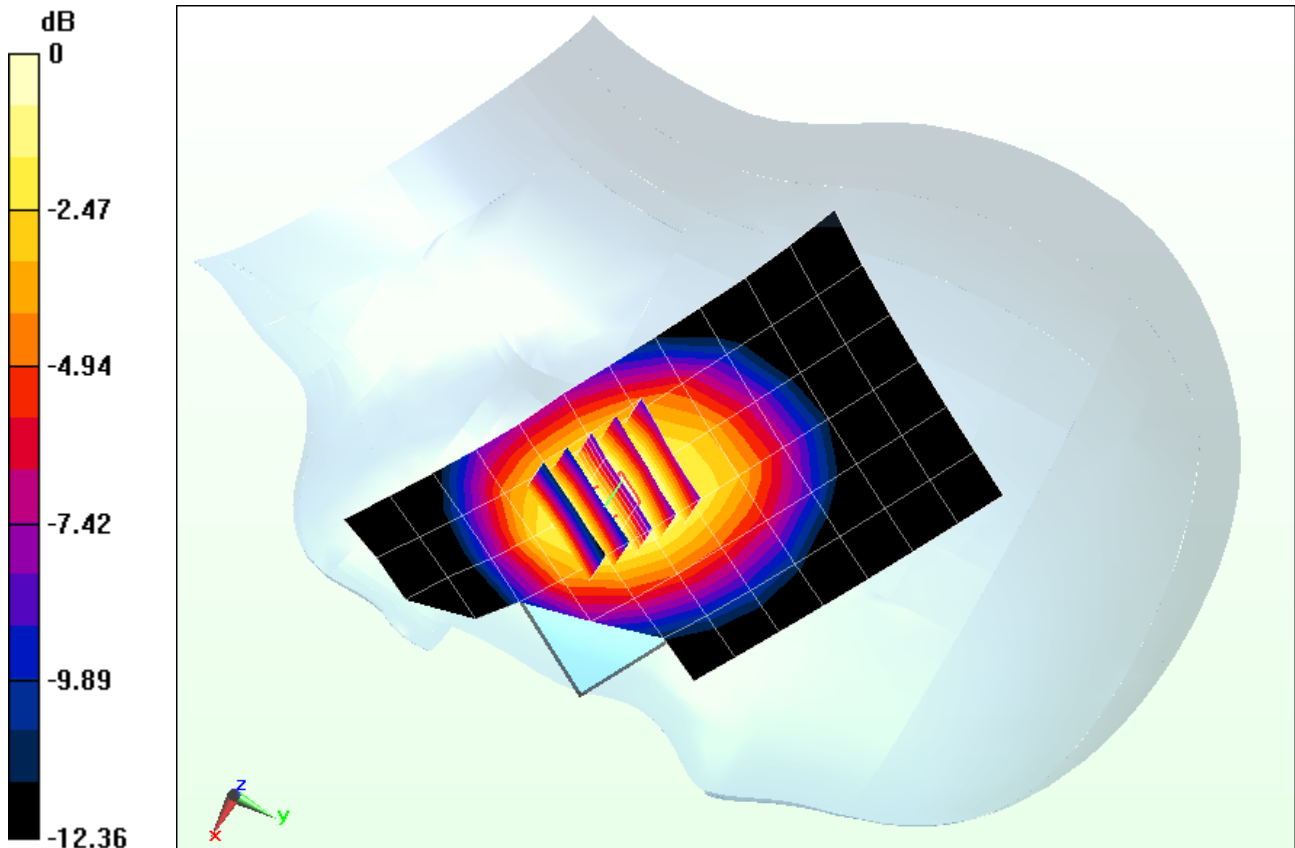

0 dB = 0.577 W/kg = -2.39 dBW/kg

# PCTEST ENGINEERING LABORATORY, INC.

**DUT: A3LGTS5301B; Type: Portable Handset; Serial: FJ-295-C**

Communication System: GSM; Frequency: 836.6 MHz; Duty Cycle: 1:8.3

Medium: 835 Head; Medium parameters used (interpolated):

$f = 836.6 \text{ MHz}$ ;  $\sigma = 0.915 \text{ mho/m}$ ;  $\epsilon_r = 42.178$ ;  $\rho = 1000 \text{ kg/m}^3$

Phantom section: Left Section

Test Date: 11-14-2012; Ambient Temp: 23.4°C; Tissue Temp: 21.7°C

Probe: ES3DV3 - SN3213; ConvF(6.07, 6.07, 6.07); Calibrated: 4/24/2012;

Sensor-Surface: 4mm (Mechanical Surface Detection)

Electronics: DAE4 Sn665; Calibrated: 4/19/2012

Phantom: SAM Right; Type: QD000P40CD; Serial: 1686

Measurement SW: DASY52, Version 52.8 (3); SEMCAD X Version 14.6.7 (6848)

**Mode: GSM 850, Left Head, Tilt, Mid.ch**

**Area Scan (7x14x1):** Measurement grid: dx=15mm, dy=15mm

**Zoom Scan (5x5x7)/Cube 0:** Measurement grid: dx=8mm, dy=8mm, dz=5mm

Reference Value = 16.079 V/m; Power Drift = 0.00 dB

Peak SAR (extrapolated) = 0.261 W/kg

**SAR(1 g) = 0.215 W/kg**

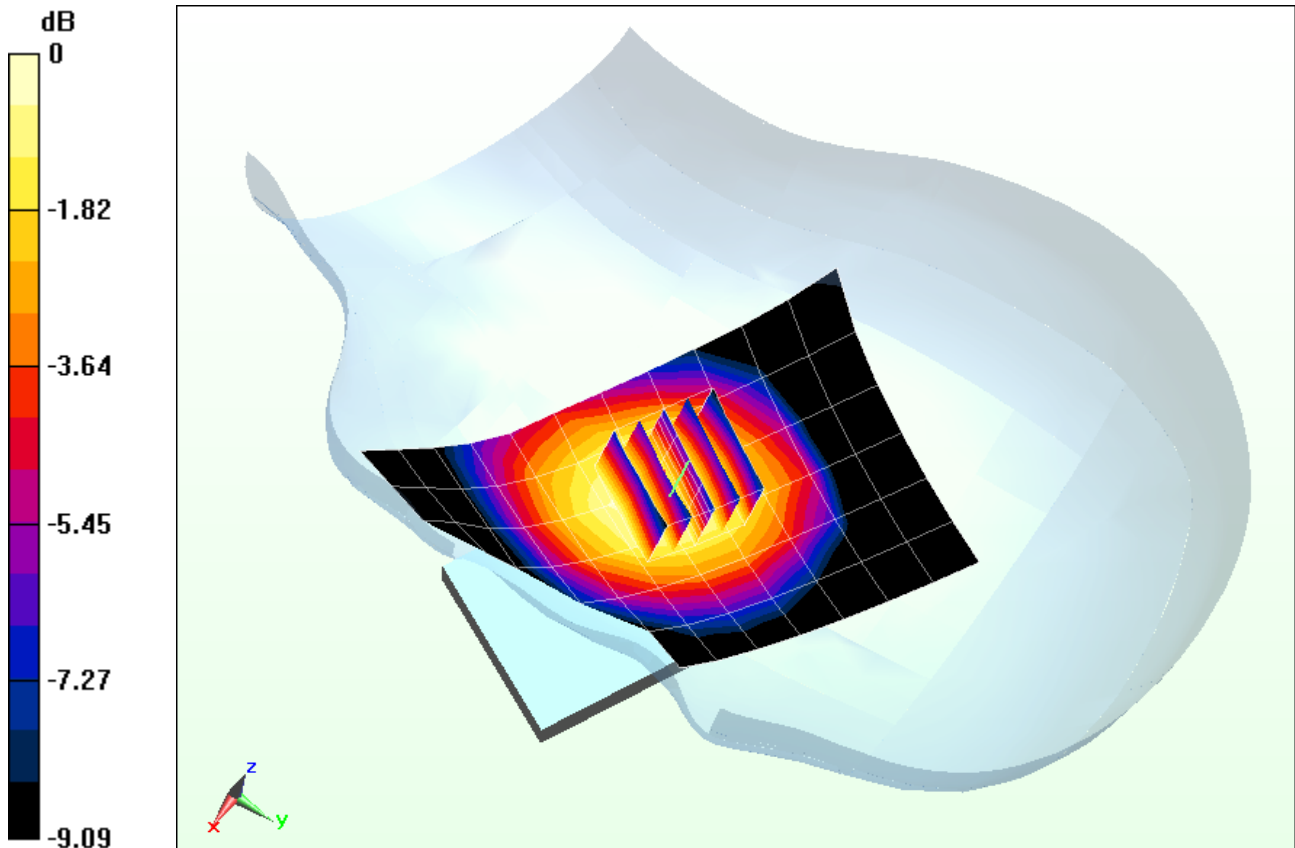

0 dB = 0.226 W/kg = -6.46 dBW/kg

# PCTEST ENGINEERING LABORATORY, INC.

**DUT: A3LGTS5301B; Type: Portable Handset; Serial: FJ-295-C**

Communication System: WCDMA; Frequency: 836.6 MHz; Duty Cycle: 1:1

Medium: 835 Head; Medium parameters used (interpolated):

$f = 836.6 \text{ MHz}$ ;  $\sigma = 0.915 \text{ mho/m}$ ;  $\epsilon_r = 42.178$ ;  $\rho = 1000 \text{ kg/m}^3$

Phantom section: Right Section

Test Date: 11-14-2012; Ambient Temp: 23.4°C; Tissue Temp: 21.7°C

Probe: ES3DV3 - SN3213; ConvF(6.07, 6.07, 6.07); Calibrated: 4/24/2012;

Sensor-Surface: 4mm (Mechanical Surface Detection)

Electronics: DAE4 Sn665; Calibrated: 4/19/2012

Phantom: SAM Right; Type: QD000P40CD; Serial: 1686

Measurement SW: DASY52, Version 52.8 (3);SEMCAD X Version 14.6.7 (6848)

**Mode: WCDMA 850, Right Head, Cheek, Mid.ch**

**Area Scan (7x12x1):** Measurement grid: dx=15mm, dy=15mm

**Zoom Scan (5x5x7)/Cube 0:** Measurement grid: dx=8mm, dy=8mm, dz=5mm

Reference Value = 17.115 V/m; Power Drift = 0.06 dB

Peak SAR (extrapolated) = 0.367 W/kg

**SAR(1 g) = 0.263 W/kg**

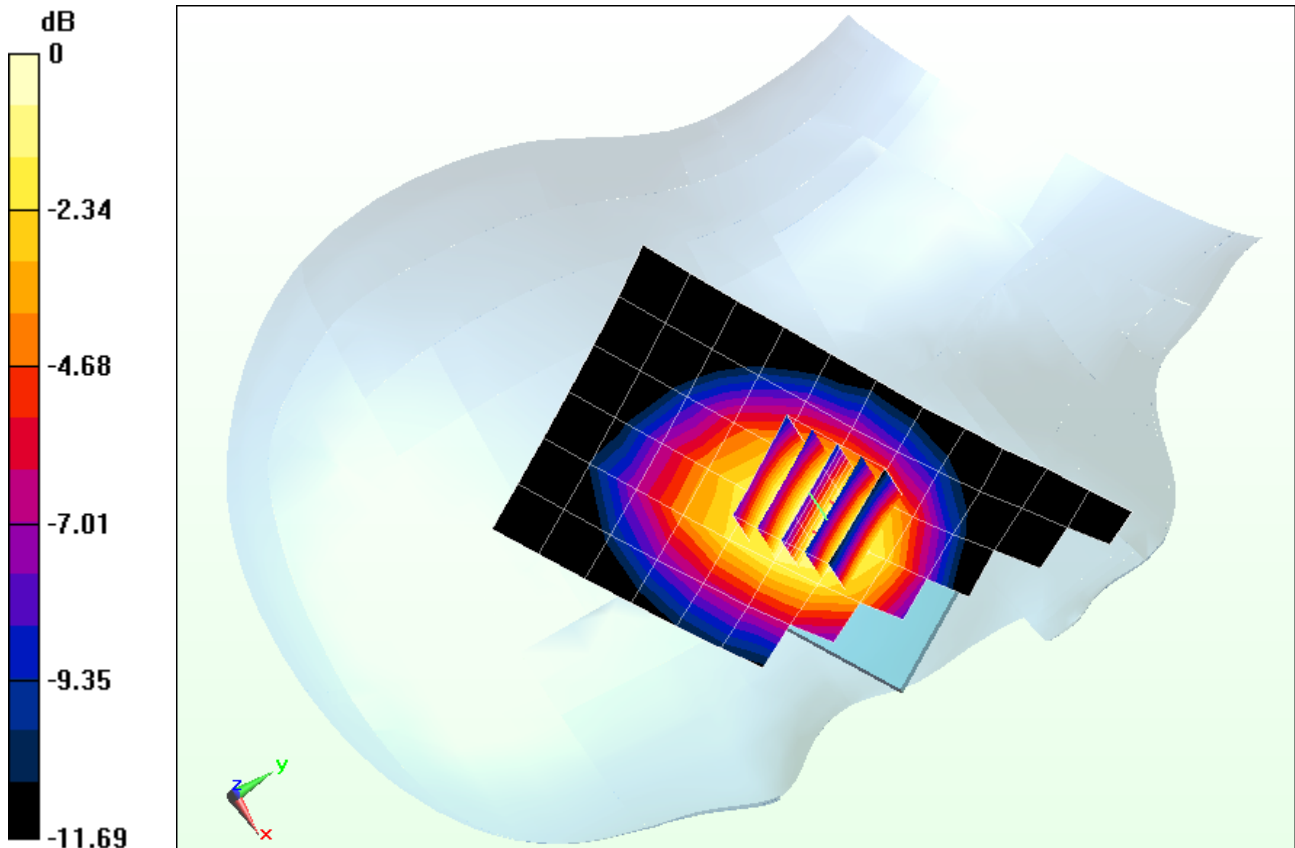

0 dB = 0.277 W/kg = -5.58 dBW/kg

# PCTEST ENGINEERING LABORATORY, INC.

**DUT: A3LGTS5301B; Type: Portable Handset; Serial: FJ-295-C**

Communication System: WCDMA; Frequency: 836.6 MHz; Duty Cycle: 1:1

Medium: 835 Head; Medium parameters used (interpolated):

$f = 836.6 \text{ MHz}$ ;  $\sigma = 0.915 \text{ mho/m}$ ;  $\epsilon_r = 42.178$ ;  $\rho = 1000 \text{ kg/m}^3$

Phantom section: Right Section

Test Date: 11-14-2012; Ambient Temp: 23.4°C; Tissue Temp: 21.7°C

Probe: ES3DV3 - SN3213; ConvF(6.07, 6.07, 6.07); Calibrated: 4/24/2012;

Sensor-Surface: 4mm (Mechanical Surface Detection)

Electronics: DAE4 Sn665; Calibrated: 4/19/2012

Phantom: SAM Right; Type: QD000P40CD; Serial: 1686

Measurement SW: DASY52, Version 52.8 (3); SEMCAD X Version 14.6.7 (6848)

**Mode: WCDMA 850, Right Head, Tilt, Mid.ch**

**Area Scan (7x12x1):** Measurement grid: dx=15mm, dy=15mm

**Zoom Scan (5x5x7)/Cube 0:** Measurement grid: dx=8mm, dy=8mm, dz=5mm

Reference Value = 11.398 V/m; Power Drift = 0.11 dB

Peak SAR (extrapolated) = 0.141 W/kg

**SAR(1 g) = 0.114 W/kg**

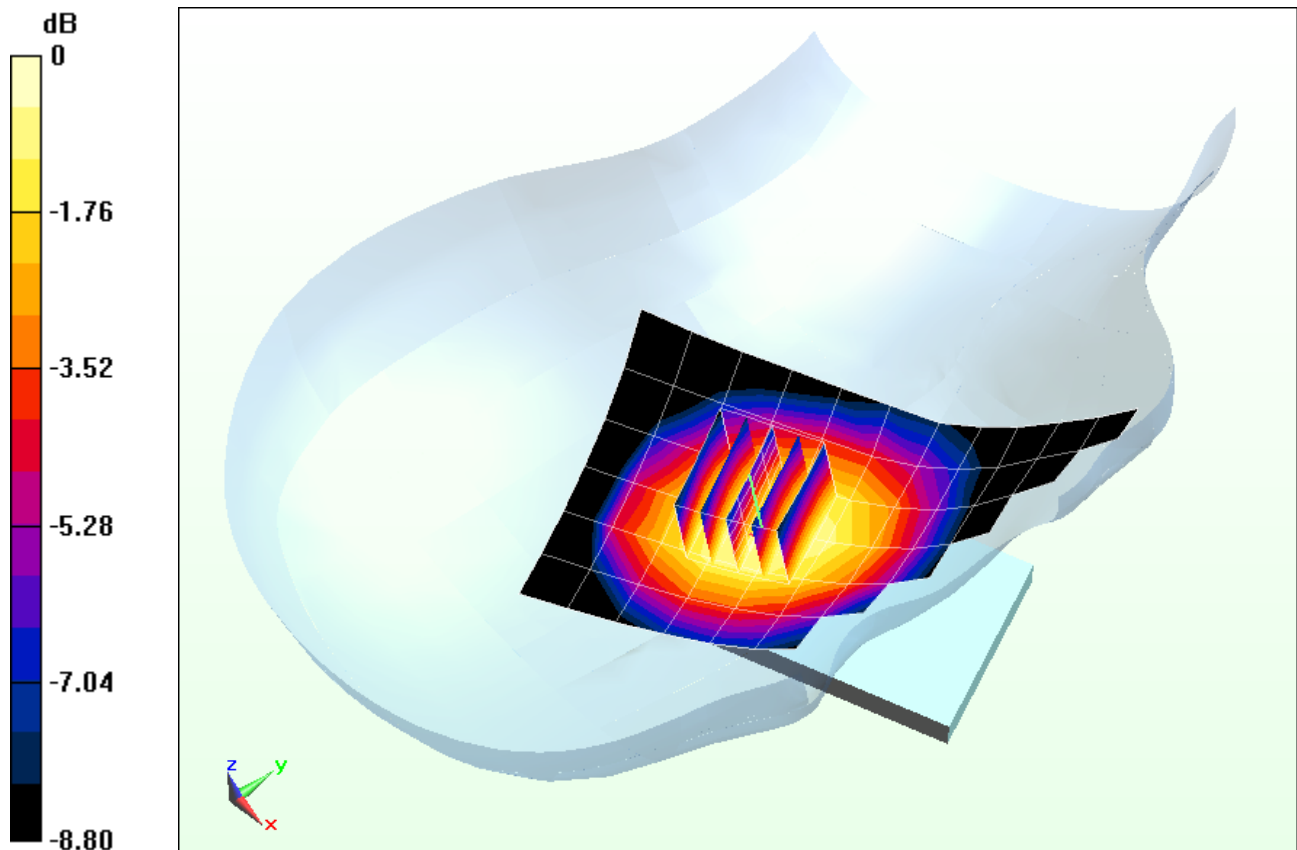

0 dB = 0.120 W/kg = -9.21 dBW/kg

# PCTEST ENGINEERING LABORATORY, INC.

**DUT: A3LGTS5301B; Type: Portable Handset; Serial: FJ-295-C**

Communication System: WCDMA; Frequency: 836.6 MHz; Duty Cycle: 1:1

Medium: 835 Head; Medium parameters used (interpolated):

$f = 836.6 \text{ MHz}$ ;  $\sigma = 0.915 \text{ mho/m}$ ;  $\epsilon_r = 42.178$ ;  $\rho = 1000 \text{ kg/m}^3$

Phantom section: Left Section

Test Date: 11-14-2012; Ambient Temp: 23.4°C; Tissue Temp: 21.7°C

Probe: ES3DV3 - SN3213; ConvF(6.07, 6.07, 6.07); Calibrated: 4/24/2012;

Sensor-Surface: 4mm (Mechanical Surface Detection)

Electronics: DAE4 Sn665; Calibrated: 4/19/2012

Phantom: SAM Right; Type: QD000P40CD; Serial: 1686

Measurement SW: DASY52, Version 52.8 (3);SEMCAD X Version 14.6.7 (6848)

**Mode: WCDMA 850, Left Head, Cheek, Mid.ch**

**Area Scan (7x10x1):** Measurement grid: dx=15mm, dy=15mm

**Zoom Scan (5x5x7)/Cube 0:** Measurement grid: dx=8mm, dy=8mm, dz=5mm

Reference Value = 19.189 V/m; Power Drift = -0.05 dB

Peak SAR (extrapolated) = 0.440 W/kg

**SAR(1 g) = 0.313 W/kg**

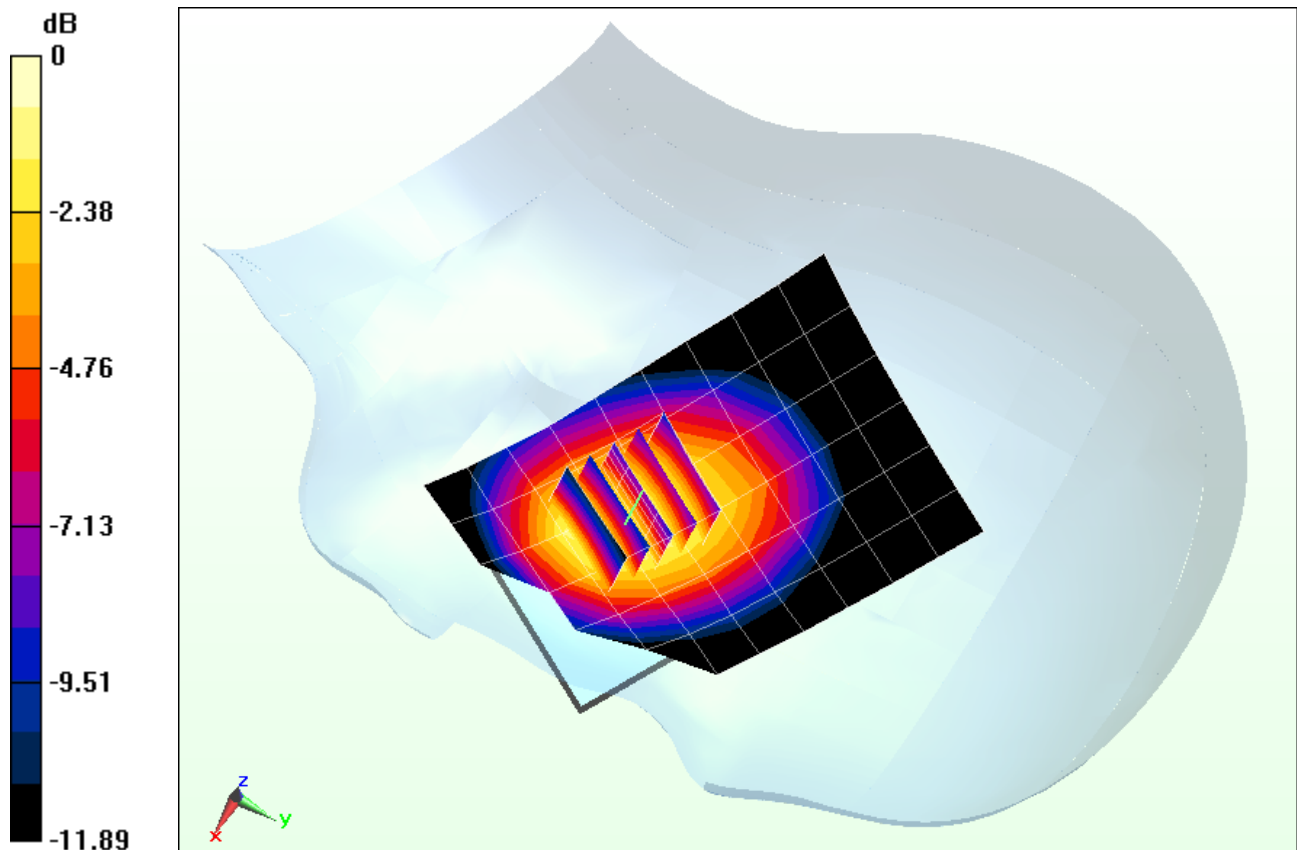

0 dB = 0.331 W/kg = -4.80 dBW/kg

# PCTEST ENGINEERING LABORATORY, INC.

**DUT: A3LGTS5301B; Type: Portable Handset; Serial: FJ-295-C**

Communication System: WCDMA; Frequency: 836.6 MHz; Duty Cycle: 1:1

Medium: 835 Head; Medium parameters used (interpolated):

$f = 836.6 \text{ MHz}$ ;  $\sigma = 0.915 \text{ mho/m}$ ;  $\epsilon_r = 42.178$ ;  $\rho = 1000 \text{ kg/m}^3$

Phantom section: Left Section

Test Date: 11-14-2012; Ambient Temp: 23.4°C; Tissue Temp: 21.7°C

Probe: ES3DV3 - SN3213; ConvF(6.07, 6.07, 6.07); Calibrated: 4/24/2012;

Sensor-Surface: 4mm (Mechanical Surface Detection)

Electronics: DAE4 Sn665; Calibrated: 4/19/2012

Phantom: SAM Right; Type: QD000P40CD; Serial: 1686

Measurement SW: DASY52, Version 52.8 (3); SEMCAD X Version 14.6.7 (6848)

**Mode: WCDMA 850, Left Head, Tilt, Mid.ch**

**Area Scan (7x10x1):** Measurement grid: dx=15mm, dy=15mm

**Zoom Scan (5x5x7)/Cube 0:** Measurement grid: dx=8mm, dy=8mm, dz=5mm

Reference Value = 11.717 V/m; Power Drift = -0.06 dB

Peak SAR (extrapolated) = 0.151 W/kg

**SAR(1 g) = 0.122 W/kg**

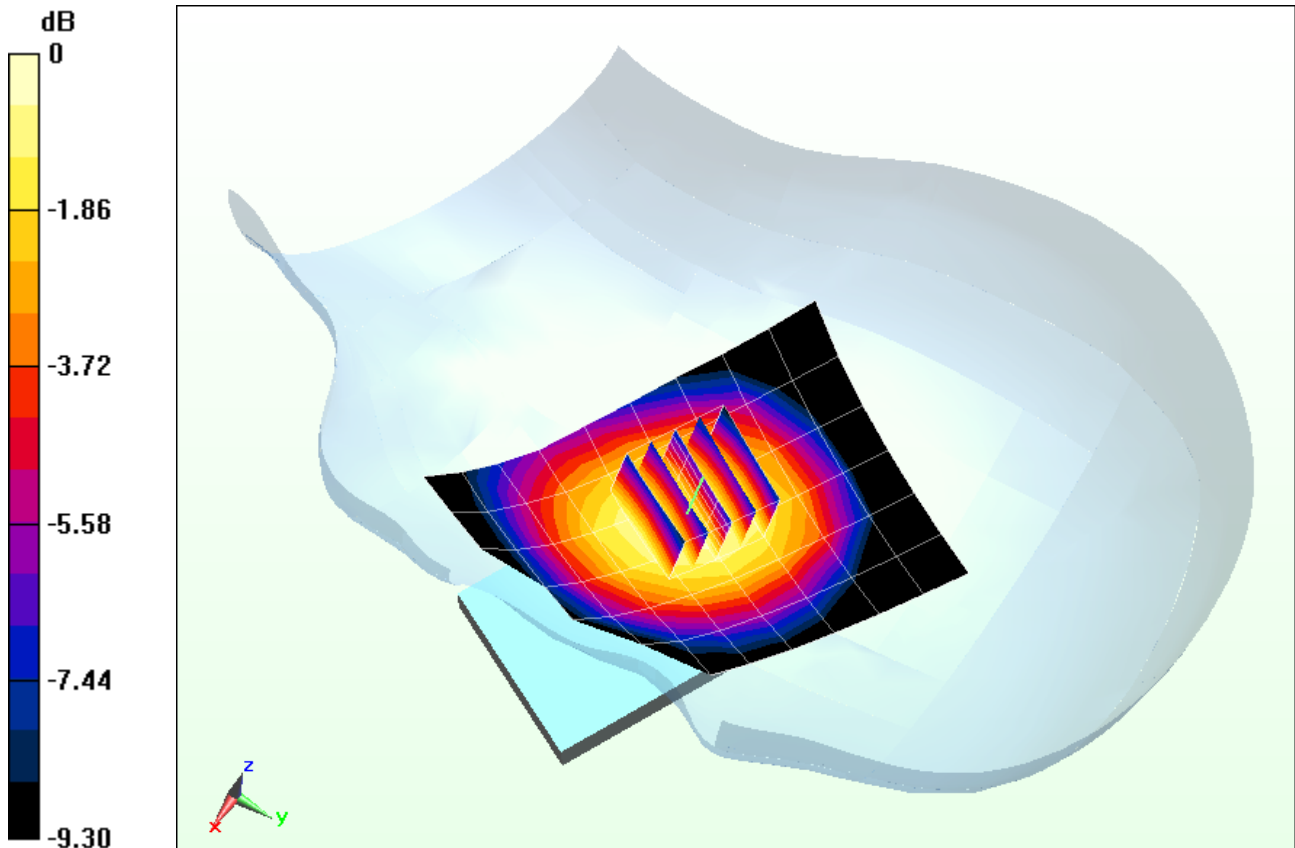

0 dB = 0.128 W/kg = -8.93 dBW/kg

# PCTEST ENGINEERING LABORATORY, INC.

**DUT: A3LGTS5301B; Type: Portable Handset; Serial: FJ-295-C**

Communication System: GSM1900; Frequency: 1880 MHz; Duty Cycle: 1:8.3

Medium: 1900 Head; Medium parameters used:

$f = 1880 \text{ MHz}$ ;  $\sigma = 1.432 \text{ mho/m}$ ;  $\epsilon_r = 40.01$ ;  $\rho = 1000 \text{ kg/m}^3$

Phantom section: Right Section

Test Date: 11-14-2012; Ambient Temp: 24.8°C; Tissue Temp: 23.4°C

Probe: ES3DV3 - SN3209; ConvF(5.15, 5.15, 5.15); Calibrated: 3/16/2012;

Sensor-Surface: 4mm (Mechanical Surface Detection)

Electronics: DAE4 Sn649; Calibrated: 2/20/2012

Phantom: SAM Sub Dasy B; Type: SAM 5.0; Serial: TP-1626

Measurement SW: DASY4, Version 4.7 (80); SEMCAD X Version 14.6.7 (6848)

**Mode: GSM 1900, Right Head, Cheek, Mid.ch**

**Area Scan (7x14x1):** Measurement grid: dx=15mm, dy=15mm

**Zoom Scan (5x5x7)/Cube 0:** Measurement grid: dx=8mm, dy=8mm, dz=5mm

Reference Value = 20.442 V/m; Power Drift = -0.01 dB

Peak SAR (extrapolated) = 1.01 W/kg

**SAR(1 g) = 0.598 W/kg; SAR(10 g) = 0.345 W/kg**

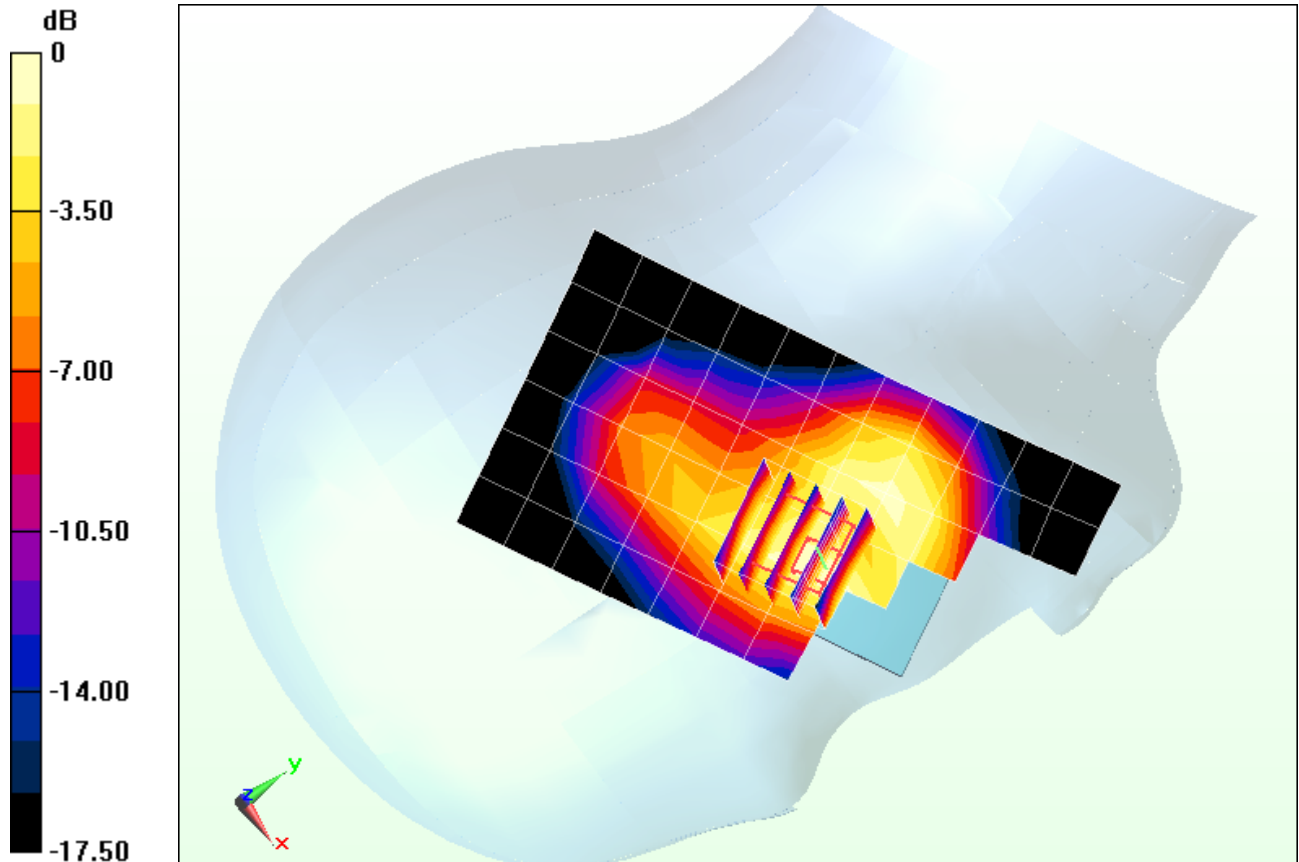

0 dB = 0.659 W/kg = -1.81 dBW/kg

# PCTEST ENGINEERING LABORATORY, INC.

**DUT: A3LGTS5301B; Type: Portable Handset; Serial: FJ-295-C**

Communication System: GSM1900; Frequency: 1880 MHz; Duty Cycle: 1:8.3

Medium: 1900 Head; Medium parameters used:

$f = 1880 \text{ MHz}$ ;  $\sigma = 1.432 \text{ mho/m}$ ;  $\epsilon_r = 40.01$ ;  $\rho = 1000 \text{ kg/m}^3$

Phantom section: Right Section

Test Date: 11-14-2012; Ambient Temp: 24.8°C; Tissue Temp: 23.4°C

Probe: ES3DV3 - SN3209; ConvF(5.15, 5.15, 5.15); Calibrated: 3/16/2012;

Sensor-Surface: 4mm (Mechanical Surface Detection)

Electronics: DAE4 Sn649; Calibrated: 2/20/2012

Phantom: SAM Sub Dasy B; Type: SAM 5.0; Serial: TP-1626

Measurement SW: DASY4, Version 4.7 (80);SEMCAD X Version 14.6.7 (6848)

**Mode: GSM 1900, Right Head, Tilt, Mid.ch**

**Area Scan (7x14x1):** Measurement grid: dx=15mm, dy=15mm

**Zoom Scan (5x5x7)/Cube 0:** Measurement grid: dx=8mm, dy=8mm, dz=5mm

Reference Value = 15.314 V/m; Power Drift = -0.03 dB

Peak SAR (extrapolated) = 0.500 W/kg

**SAR(1 g) = 0.305 W/kg; SAR(10 g) = 0.175 W/kg**

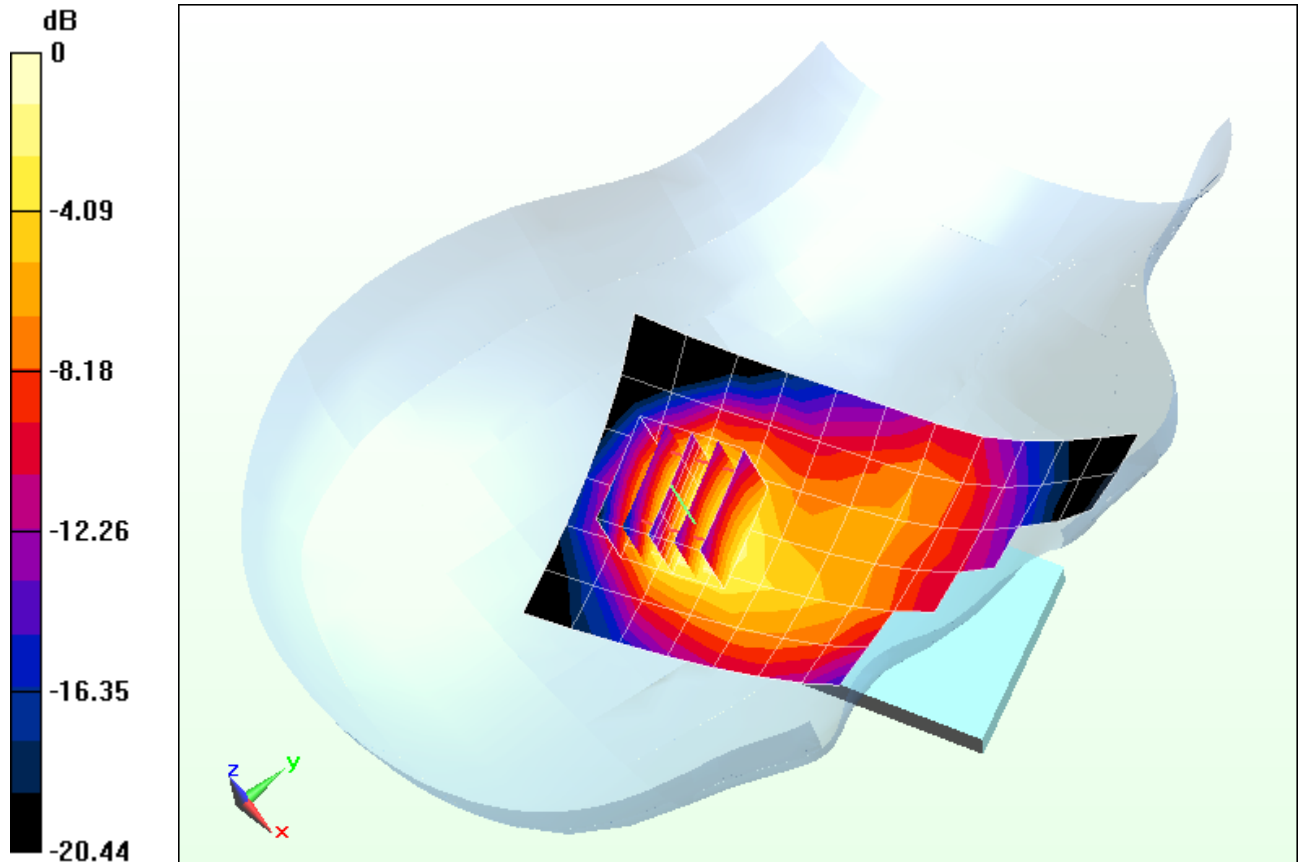

0 dB = 0.338 W/kg = -4.71 dBW/kg

# PCTEST ENGINEERING LABORATORY, INC.

**DUT: A3LGTS5301B; Type: Portable Handset; Serial: FJ-295-C**

Communication System: GSM1900; Frequency: 1850.2 MHz; Duty Cycle: 1:8.3

Medium: 1900 Head; Medium parameters used (interpolated):

$f = 1850.2 \text{ MHz}$ ;  $\sigma = 1.398 \text{ mho/m}$ ;  $\epsilon_r = 40.109$ ;  $\rho = 1000 \text{ kg/m}^3$

Phantom section: Left Section

Test Date: 11-14-2012; Ambient Temp: 24.8°C; Tissue Temp: 23.4°C

Probe: ES3DV3 - SN3209; ConvF(5.15, 5.15, 5.15); Calibrated: 3/16/2012;

Sensor-Surface: 4mm (Mechanical Surface Detection)

Electronics: DAE4 Sn649; Calibrated: 2/20/2012

Phantom: SAM Sub Dasy B; Type: SAM 5.0; Serial: TP-1626

Measurement SW: DASY4, Version 4.7 (80);SEMCAD X Version 14.6.7 (6848)

**Mode: GSM 1900, Left Head, Cheek, Low.ch**

**Area Scan (7x14x1):** Measurement grid: dx=15mm, dy=15mm

**Zoom Scan (5x5x7)/Cube 0:** Measurement grid: dx=8mm, dy=8mm, dz=5mm

Reference Value = 26.224 V/m; Power Drift = 0.15 dB

Peak SAR (extrapolated) = 1.54 W/kg

**SAR(1 g) = 0.910 W/kg; SAR(10 g) = 0.494 W/kg**

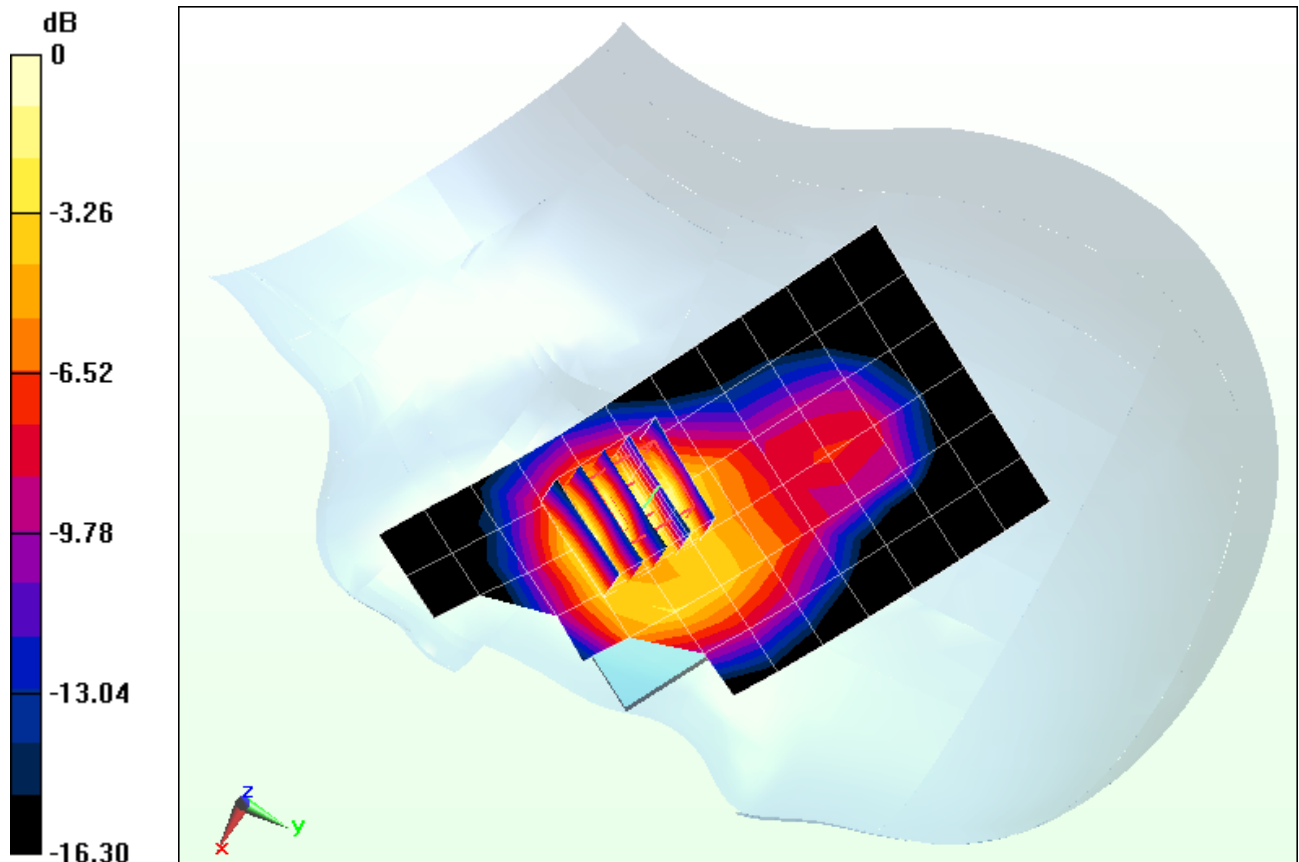

0 dB = 1.00 W/kg = 0.00 dBW/kg

# PCTEST ENGINEERING LABORATORY, INC.

**DUT: A3LGTS5301B; Type: Portable Handset; Serial: FJ-295-C**

Communication System: GSM1900; Frequency: 1880 MHz; Duty Cycle: 1:8.3

Medium: 1900 Head; Medium parameters used:

$f = 1880 \text{ MHz}$ ;  $\sigma = 1.432 \text{ mho/m}$ ;  $\epsilon_r = 40.01$ ;  $\rho = 1000 \text{ kg/m}^3$

Phantom section: Left Section

Test Date: 11-14-2012; Ambient Temp: 24.8°C; Tissue Temp: 23.4°C

Probe: ES3DV3 - SN3209; ConvF(5.15, 5.15, 5.15); Calibrated: 3/16/2012;

Sensor-Surface: 4mm (Mechanical Surface Detection)

Electronics: DAE4 Sn649; Calibrated: 2/20/2012

Phantom: SAM Sub Dasy B; Type: SAM 5.0; Serial: TP-1626

Measurement SW: DASY4, Version 4.7 (80);SEMCAD X Version 14.6.7 (6848)

**Mode: GSM 1900, Left Head, Tilt, Mid.ch**

**Area Scan (7x14x1):** Measurement grid: dx=15mm, dy=15mm

**Zoom Scan (5x5x7)/Cube 0:** Measurement grid: dx=8mm, dy=8mm, dz=5mm

Reference Value = 14.581 V/m; Power Drift = -0.03 dB

Peak SAR (extrapolated) = 0.436 W/kg

**SAR(1 g) = 0.269 W/kg; SAR(10 g) = 0.154 W/kg**

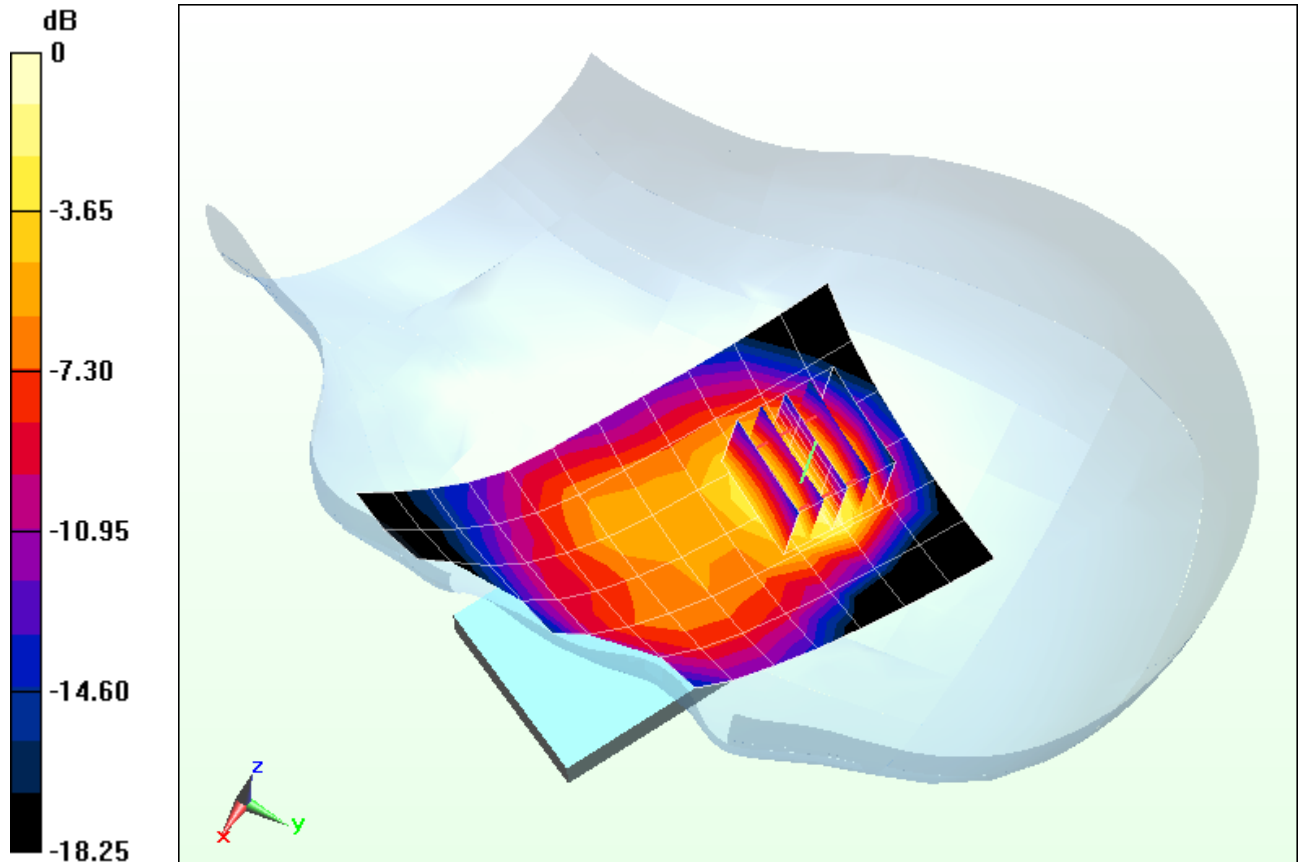

0 dB = 0.294 W/kg = -5.32 dBW/kg

# PCTEST ENGINEERING LABORATORY, INC.

**DUT: A3LGTS5301B; Type: Portable Handset; Serial: FJ-295-B**

Communication System: IEEE 802.11b; Frequency: 2412 MHz; Duty Cycle: 1:1  
Medium: 2450 Head; Medium parameters used (interpolated):  
 $f = 2412 \text{ MHz}$ ;  $\sigma = 1.723 \text{ mho/m}$ ;  $\epsilon_r = 39.404$ ;  $\rho = 1000 \text{ kg/m}^3$

Phantom section: Right Section

Test Date: 11-16-2012; Ambient Temp: 23.3°C; Tissue Temp: 23.0°C

Probe: ES3DV3 - SN3263; ConvF(4.45, 4.45, 4.45); Calibrated: 5/18/2012;  
Sensor-Surface: 3mm (Mechanical Surface Detection)

Electronics: DAE4 Sn1334; Calibrated: 5/7/2012

Phantom: SAM 5.0 front; Type: QD000P40CD; Serial: TP:-1648

Measurement SW: DASY52, Version 52.8 (3);SEMCAD X Version 14.6.7 (6848)

**Mode: IEEE 802.11b, Right Head, Cheek, Ch 01, 1 Mbps**

**Area Scan (8x17x1):** Measurement grid:  $dx=12\text{mm}$ ,  $dy=12\text{mm}$

**Zoom Scan (7x7x7)/Cube 0:** Measurement grid:  $dx=5\text{mm}$ ,  $dy=5\text{mm}$ ,  $dz=5\text{mm}$

Reference Value = 8.125 V/m; Power Drift = 0.12 dB

Peak SAR (extrapolated) = 0.220 W/kg

**SAR(1 g) = 0.112 W/kg**

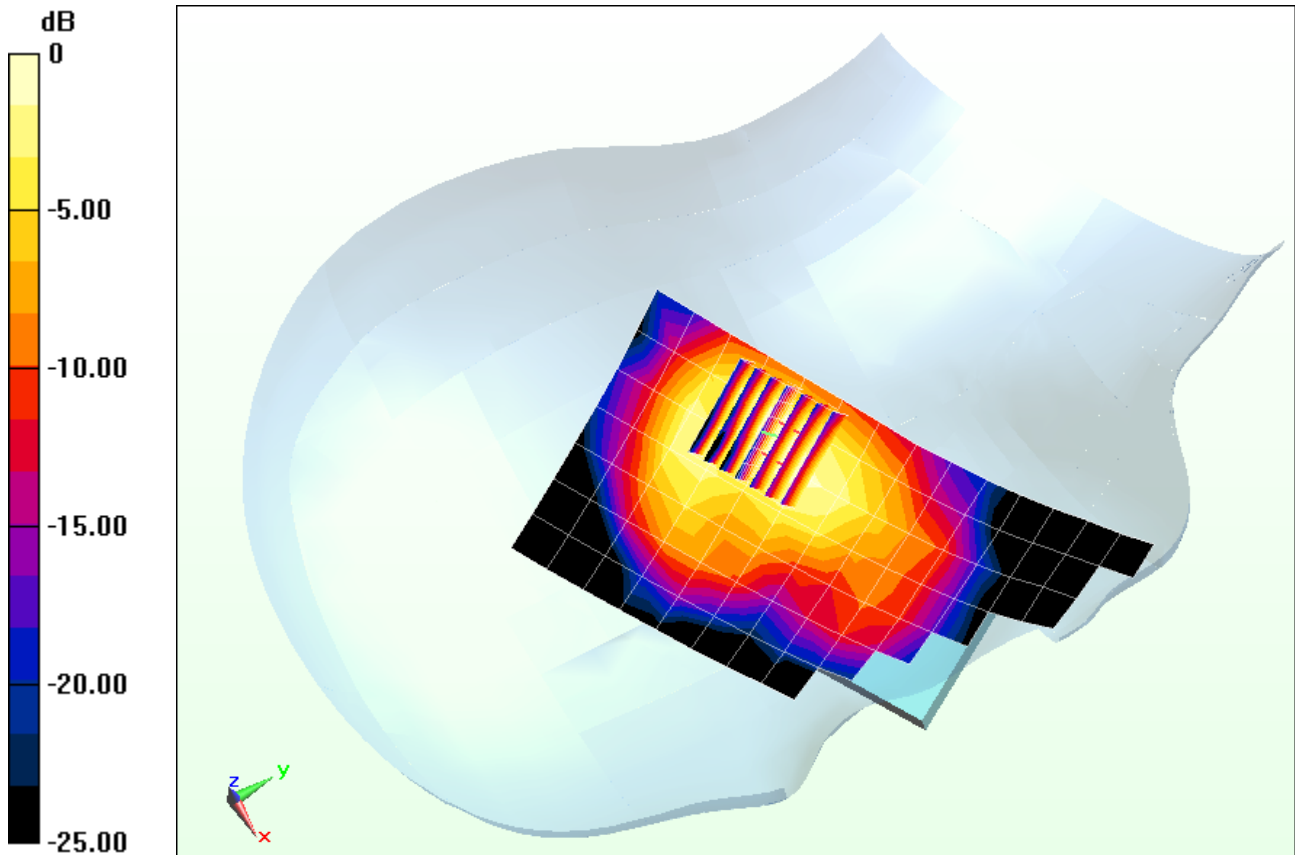

0 dB = 0.146 W/kg = -8.36 dBW/kg

# PCTEST ENGINEERING LABORATORY, INC.

**DUT: A3LGTS5301B; Type: Portable Handset; Serial: FJ-295-B**

Communication System: IEEE 802.11b; Frequency: 2412 MHz; Duty Cycle: 1:1  
Medium: 2450 Head; Medium parameters used (interpolated):  
 $f = 2412 \text{ MHz}$ ;  $\sigma = 1.723 \text{ mho/m}$ ;  $\epsilon_r = 39.404$ ;  $\rho = 1000 \text{ kg/m}^3$

Phantom section: Right Section

Test Date: 11-16-2012; Ambient Temp: 23.3°C; Tissue Temp: 23.0°C

Probe: ES3DV3 - SN3263; ConvF(4.45, 4.45, 4.45); Calibrated: 5/18/2012;

Sensor-Surface: 3mm (Mechanical Surface Detection)

Electronics: DAE4 Sn1334; Calibrated: 5/7/2012

Phantom: SAM 5.0 front; Type: QD000P40CD; Serial: TP:-1648

Measurement SW: DASY52, Version 52.8 (3); SEMCAD X Version 14.6.7 (6848)

**Mode: IEEE 802.11b, Right Head, Tilt, Ch 01, 1 Mbps**

**Area Scan (8x17x1):** Measurement grid: dx=12mm, dy=12mm

**Zoom Scan (7x7x7)/Cube 0:** Measurement grid: dx=5mm, dy=5mm, dz=5mm

Reference Value = 5.753 V/m; Power Drift = 0.16 dB

Peak SAR (extrapolated) = 0.138 W/kg

**SAR(1 g) = 0.062 W/kg**

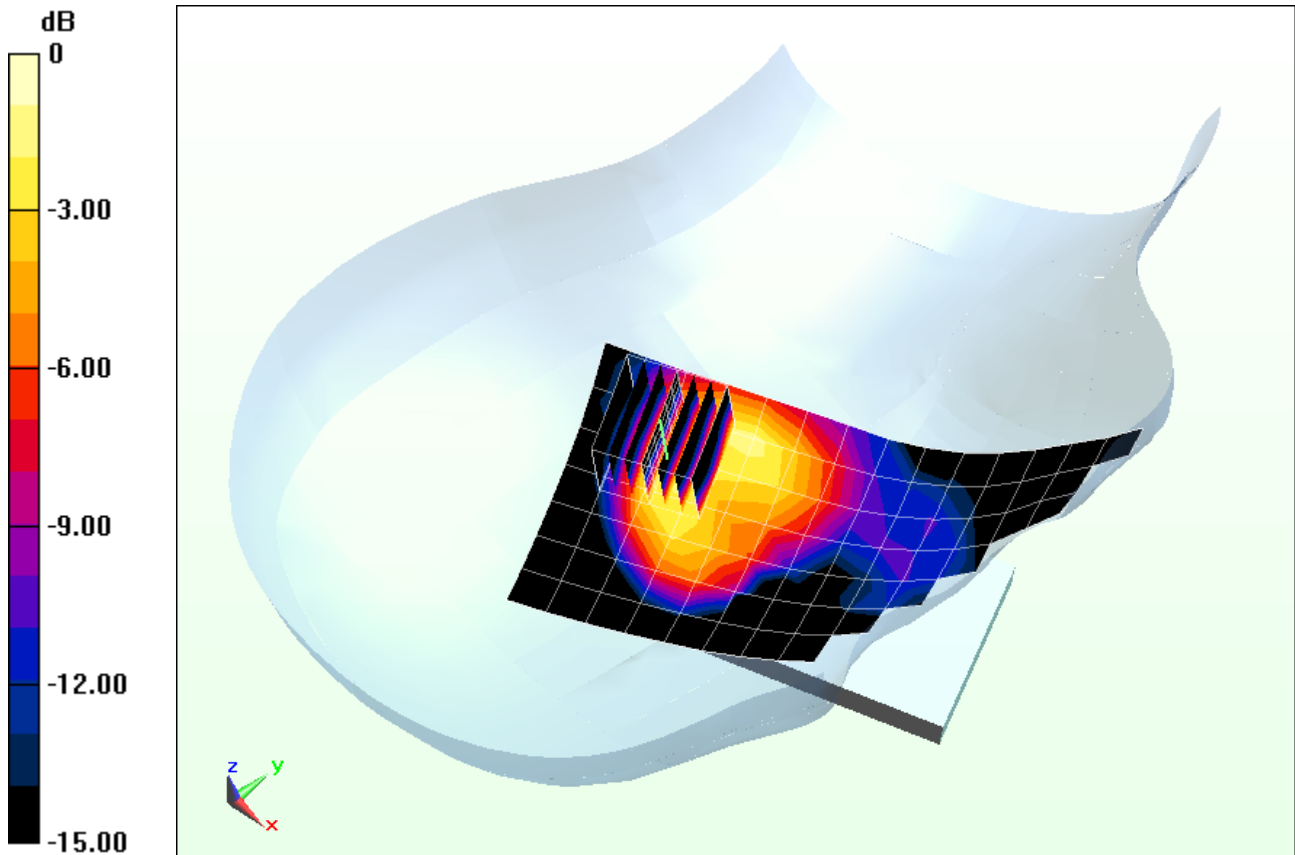

0 dB = 0.0817 W/kg = -10.88 dBW/kg

# PCTEST ENGINEERING LABORATORY, INC.

**DUT: A3LGTS5301B; Type: Portable Handset; Serial: FJ-295-B**

Communication System: IEEE 802.11b; Frequency: 2412 MHz; Duty Cycle: 1:1  
Medium: 2450 Head; Medium parameters used (interpolated):  
 $f = 2412 \text{ MHz}$ ;  $\sigma = 1.723 \text{ mho/m}$ ;  $\epsilon_r = 39.404$ ;  $\rho = 1000 \text{ kg/m}^3$

Phantom section: Left Section

Test Date: 11-16-2012; Ambient Temp: 23.3°C; Tissue Temp: 23.0°C

Probe: ES3DV3 - SN3263; ConvF(4.45, 4.45, 4.45); Calibrated: 5/18/2012;  
Sensor-Surface: 3mm (Mechanical Surface Detection)  
Electronics: DAE4 Sn1334; Calibrated: 5/7/2012

Phantom: SAM 5.0 front; Type: QD000P40CD; Serial: TP:-1648  
Measurement SW: DASY52, Version 52.8 (3); SEMCAD X Version 14.6.7 (6848)

**Mode: IEEE 802.11b, Left Head, Cheek, Ch 01, 1 Mbps**

**Area Scan (8x13x1):** Measurement grid:  $dx=12\text{mm}$ ,  $dy=12\text{mm}$

**Zoom Scan (7x7x7)/Cube 0:** Measurement grid:  $dx=5\text{mm}$ ,  $dy=5\text{mm}$ ,  $dz=5\text{mm}$

Reference Value = 13.828 V/m; Power Drift = 0.05 dB

Peak SAR (extrapolated) = 0.663 W/kg

**SAR(1 g) = 0.273 W/kg**

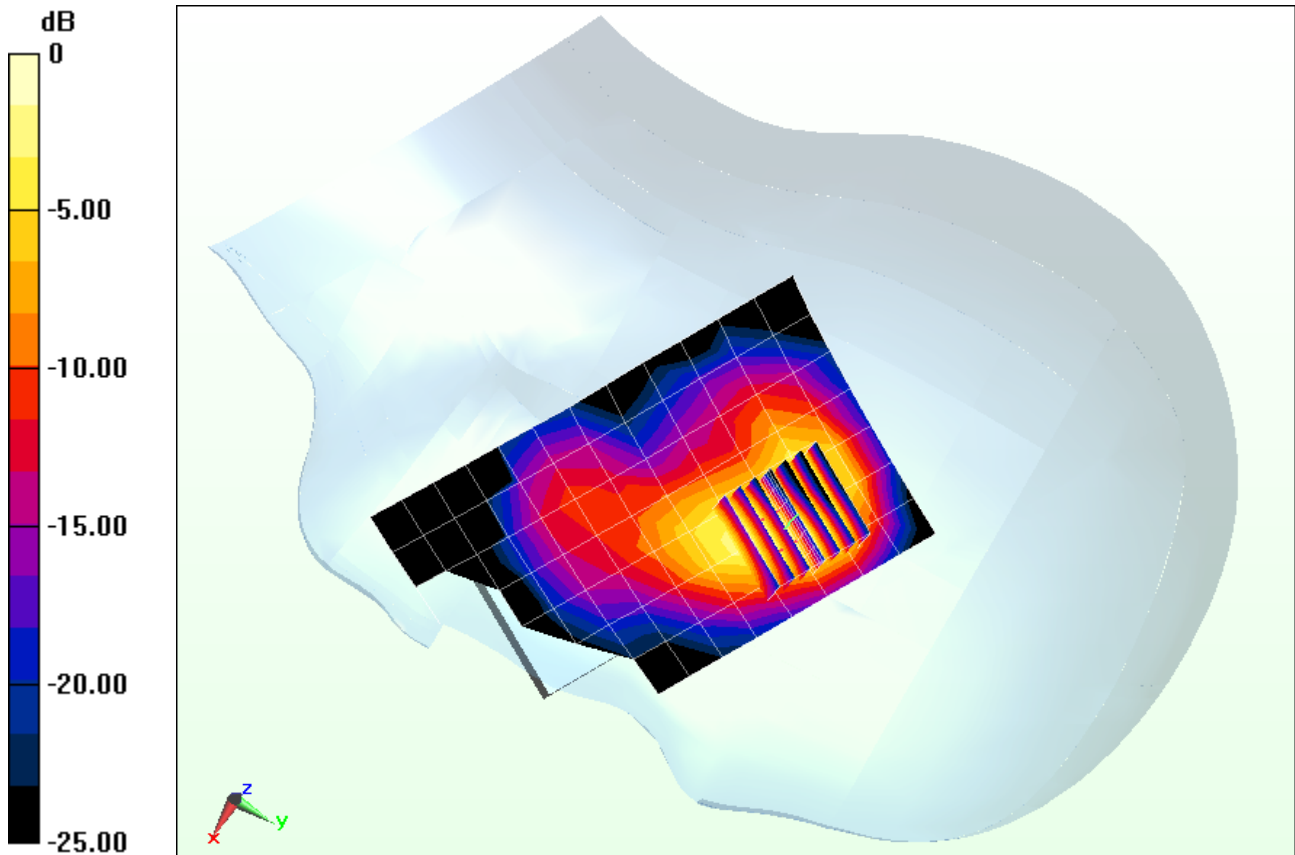

0 dB = 0.373 W/kg = -4.28 dBW/kg

# PCTEST ENGINEERING LABORATORY, INC.

**DUT: A3LGTS5301B; Type: Portable Handset; Serial: FJ-295-B**

Communication System: IEEE 802.11b; Frequency: 2412 MHz; Duty Cycle: 1:1  
Medium: 2450 Head; Medium parameters used (interpolated):  
 $f = 2412 \text{ MHz}$ ;  $\sigma = 1.723 \text{ mho/m}$ ;  $\epsilon_r = 39.404$ ;  $\rho = 1000 \text{ kg/m}^3$

Phantom section: Left Section

Test Date: 11-16-2012; Ambient Temp: 23.3°C; Tissue Temp: 23.0°C

Probe: ES3DV3 - SN3263; ConvF(4.45, 4.45, 4.45); Calibrated: 5/18/2012;  
Sensor-Surface: 3mm (Mechanical Surface Detection)  
Electronics: DAE4 Sn1334; Calibrated: 5/7/2012

Phantom: SAM 5.0 front; Type: QD000P40CD; Serial: TP:-1648

Measurement SW: DASY52, Version 52.8 (3); SEMCAD X Version 14.6.7 (6848)

**Mode: IEEE 802.11b, Left Head, Tilt, Ch 01, 1 Mbps**

**Area Scan (9x14x1):** Measurement grid: dx=12mm, dy=12mm

**Zoom Scan (7x7x7)/Cube 0:** Measurement grid: dx=5mm, dy=5mm, dz=5mm

Reference Value = 8.532 V/m; Power Drift = -0.10 dB

Peak SAR (extrapolated) = 0.299 W/kg

**SAR(1 g) = 0.121 W/kg**

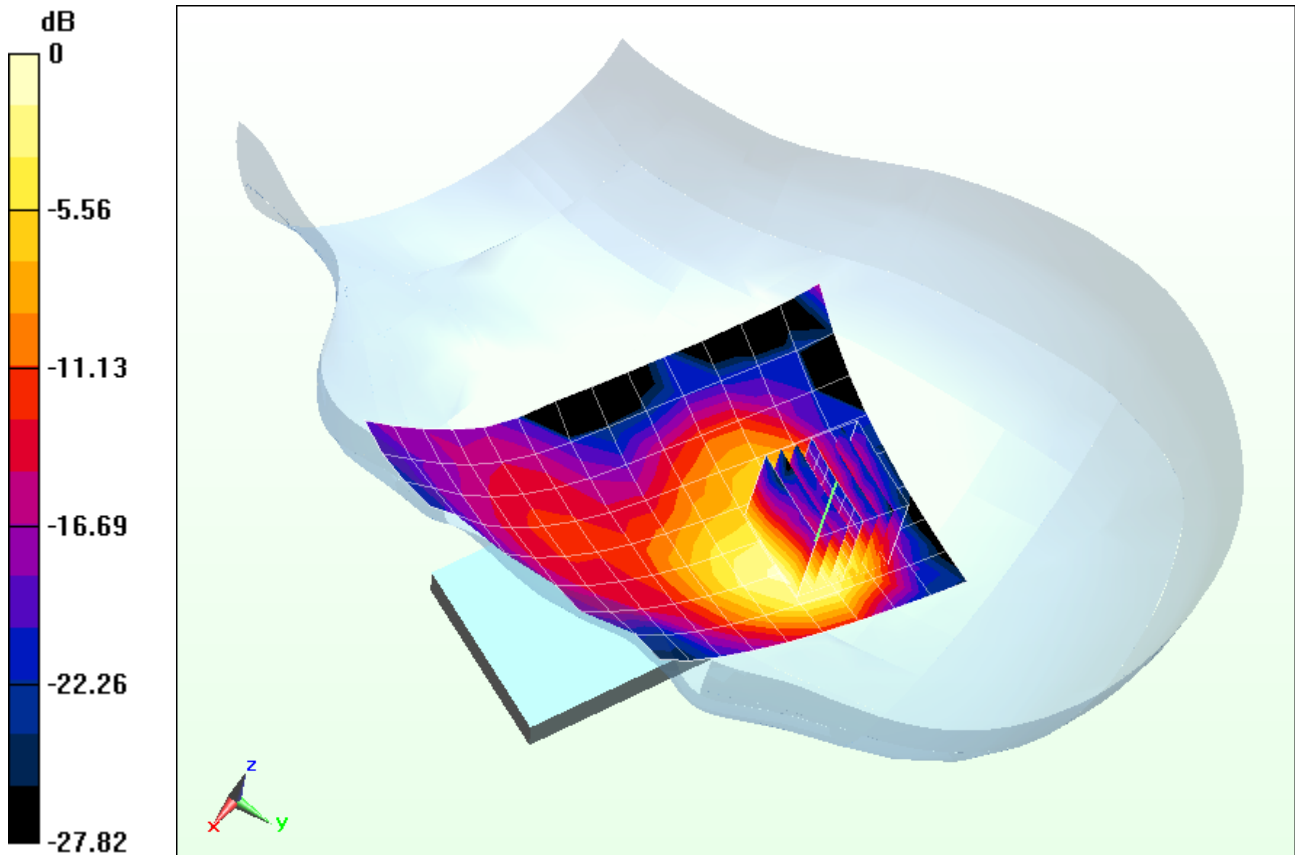

0 dB = 0.167 W/kg = -7.77 dBW/kg

# PCTEST ENGINEERING LABORATORY, INC.

**DUT: A3LGTS5301B; Type: Portable Handset; Serial: FJ-295-C**

Communication System: GSM850 GPRS; 2 Tx slots; Frequency: 836.6 MHz; Duty Cycle: 1:4.15

Medium: 835 Body; Medium parameters used (interpolated):

$f = 836.6 \text{ MHz}$ ;  $\sigma = 0.988 \text{ mho/m}$ ;  $\epsilon_r = 55.45$ ;  $\rho = 1000 \text{ kg/m}^3$

Phantom section: Flat Section; Space: 1.0 cm

Test Date: 11-15-2012; Ambient Temp: 23.9°C; Tissue Temp: 22.9°C

Probe: ES3DV3 - SN3209; ConvF(6.13, 6.13, 6.13); Calibrated: 3/16/2012;

Sensor-Surface: 4mm (Mechanical Surface Detection)

Electronics: DAE4 Sn649; Calibrated: 2/20/2012

Phantom: SAM with CRP; Type: SAM; Serial: TP1375

Measurement SW: DASY4, Version 4.7 (80);SEMCAD X Version 14.6.7 (6848)

**Mode: GPRS 850, Body SAR, Back side, Mid.ch, 2 Tx Slots**

**Area Scan (7x12x1):** Measurement grid: dx=15mm, dy=15mm

**Zoom Scan (5x5x7)/Cube 0:** Measurement grid: dx=8mm, dy=8mm, dz=5mm

Reference Value = 26.195 V/m; Power Drift = -0.03 dB

Peak SAR (extrapolated) = 0.844 W/kg

**SAR(1 g) = 0.638 W/kg; SAR(10 g) = 0.450 W/kg**

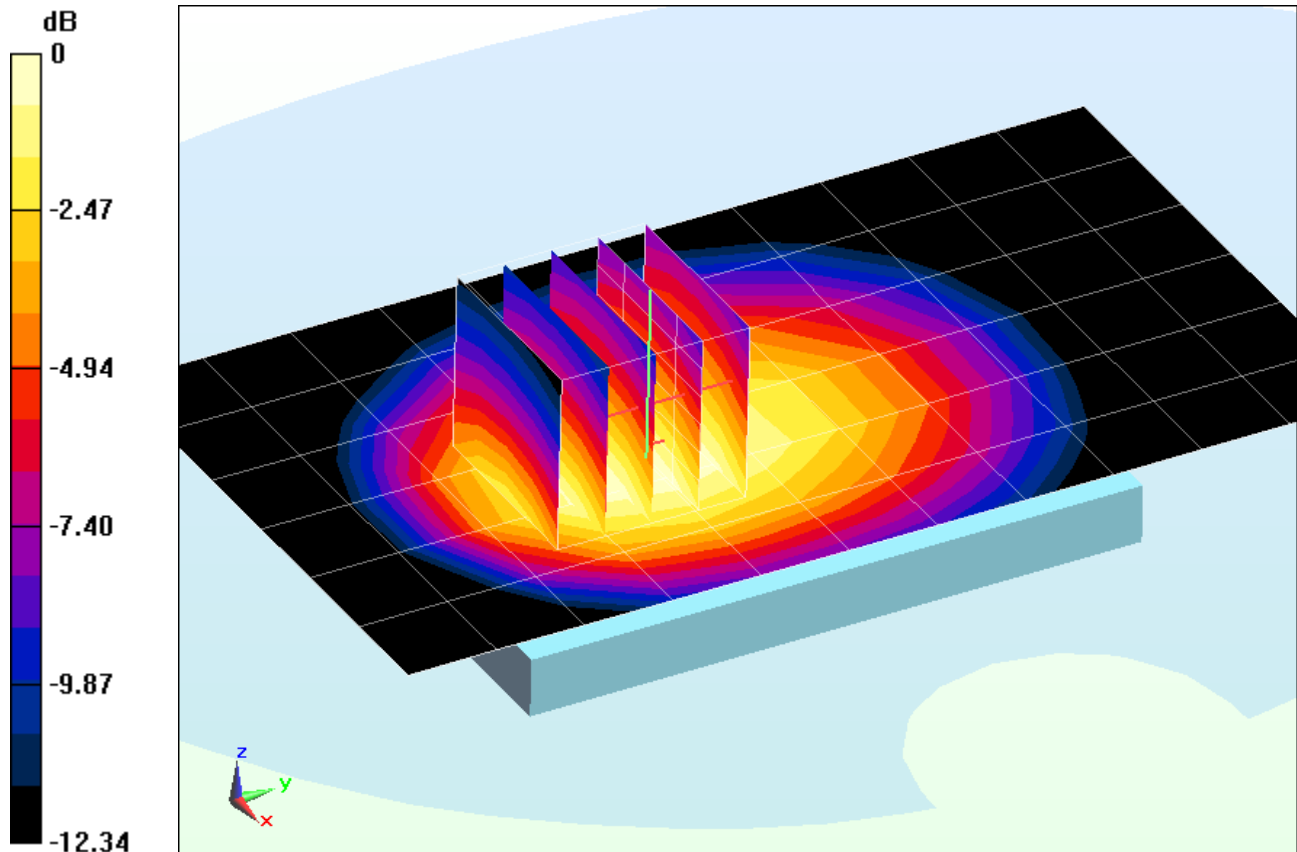

0 dB = 0.675 W/kg = -1.71 dBW/kg

# PCTEST ENGINEERING LABORATORY, INC.

**DUT: A3LGTS5301B; Type: Portable Handset; Serial: FJ-295-C**

Communication System: GSM 850 GPRS; 2 Tx slots; Frequency: 836.6 MHz; Duty Cycle: 1:4.15

Medium: 835 Body; Medium parameters used (interpolated):

$f = 836.6 \text{ MHz}$ ;  $\sigma = 0.988 \text{ mho/m}$ ;  $\epsilon_r = 55.45$ ;  $\rho = 1000 \text{ kg/m}^3$

Phantom section: Flat Section; Space: 1.0 cm

Test Date: 11-15-2012; Ambient Temp: 23.9°C; Tissue Temp: 22.9°C

Probe: ES3DV3 - SN3209; ConvF(6.13, 6.13, 6.13); Calibrated: 3/16/2012;

Sensor-Surface: 4mm (Mechanical Surface Detection)

Electronics: DAE4 Sn649; Calibrated: 2/20/2012

Phantom: SAM with CRP; Type: SAM; Serial: TP1375

Measurement SW: DAS4, Version 4.7 (80);SEMCAD X Version 14.6.7 (6848)

**Mode: GPRS 850, Body SAR, Front side, Mid.ch, 2 Tx Slots**

**Area Scan (7x12x1):** Measurement grid: dx=15mm, dy=15mm

**Zoom Scan (5x5x7)/Cube 0:** Measurement grid: dx=8mm, dy=8mm, dz=5mm

Reference Value = 22.099 V/m; Power Drift = -0.03 dB

Peak SAR (extrapolated) = 0.587 W/kg

**SAR(1 g) = 0.443 W/kg; SAR(10 g) = 0.311 W/kg**

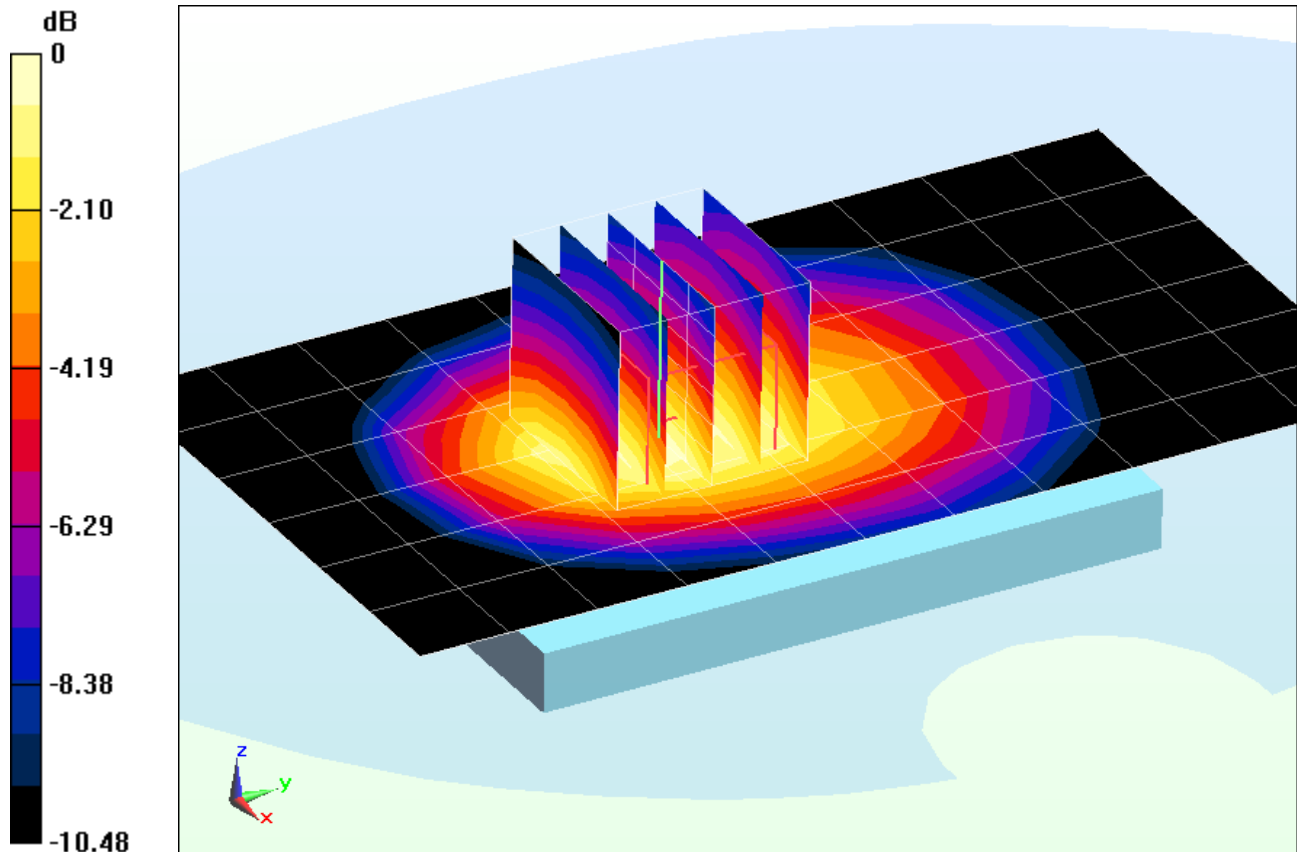

0 dB = 0.475 W/kg = -3.23 dBW/kg

# PCTEST ENGINEERING LABORATORY, INC.

**DUT: A3LGTS5301B; Type: Portable Handset; Serial: FJ-295-C**

Communication System: GSM 850 GPRS; 2 Tx slots; Frequency: 836.6 MHz; Duty Cycle: 1:4.15

Medium: 835 Body; Medium parameters used (interpolated):

$f = 836.6 \text{ MHz}$ ;  $\sigma = 0.988 \text{ mho/m}$ ;  $\epsilon_r = 55.45$ ;  $\rho = 1000 \text{ kg/m}^3$

Phantom section: Flat Section; Space: 1.0 cm

Test Date: 11-15-2012; Ambient Temp: 23.9°C; Tissue Temp: 22.9°C

Probe: ES3DV3 - SN3209; ConvF(6.13, 6.13, 6.13); Calibrated: 3/16/2012;

Sensor-Surface: 4mm (Mechanical Surface Detection)

Electronics: DAE4 Sn649; Calibrated: 2/20/2012

Phantom: SAM with CRP; Type: SAM; Serial: TP1375

Measurement SW: DASY4, Version 4.7 (80); SEMCAD X Version 14.6.7 (6848)

**Mode: GPRS 850, Body SAR, Bottom Edge, Mid.ch, 2 Tx Slots**

**Area Scan (9x7x1):** Measurement grid: dx=5mm, dy=15mm

**Zoom Scan (5x5x7)/Cube 0:** Measurement grid: dx=8mm, dy=8mm, dz=5mm

Reference Value = 9.430 V/m; Power Drift = -0.04 dB

Peak SAR (extrapolated) = 0.151 W/kg

**SAR(1 g) = 0.079 W/kg; SAR(10 g) = 0.046 W/kg**

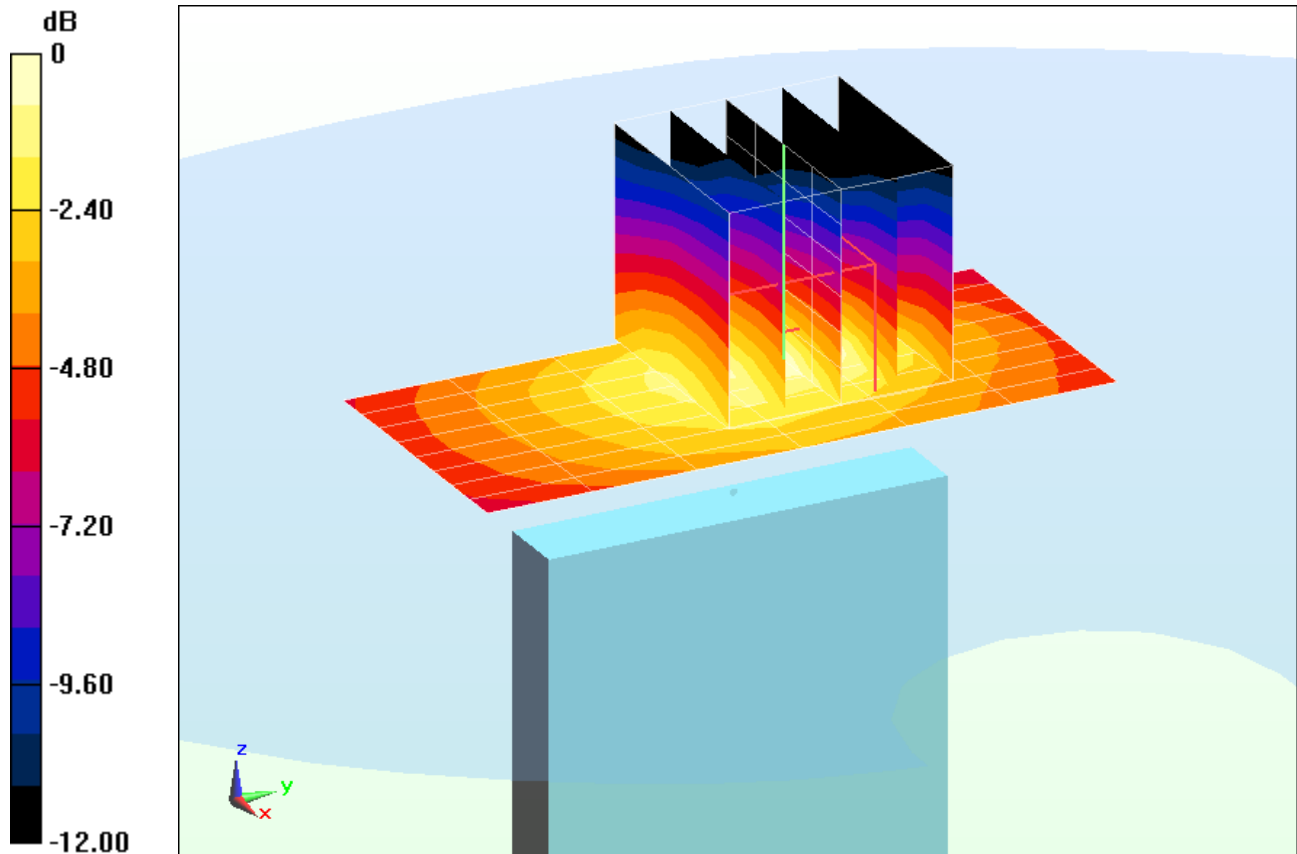

0 dB = 0.0884 W/kg = -10.54 dBW/kg

# PCTEST ENGINEERING LABORATORY, INC.

**DUT: A3LGTS5301B; Type: Portable Handset; Serial: FJ-295-C**

Communication System: GSM 850 GPRS; 2 Tx slots; Frequency: 836.6 MHz; Duty Cycle: 1:4.15

Medium: 835 Body; Medium parameters used (interpolated):

$f = 836.6 \text{ MHz}$ ;  $\sigma = 0.988 \text{ mho/m}$ ;  $\epsilon_r = 55.45$ ;  $\rho = 1000 \text{ kg/m}^3$

Phantom section: Flat Section; Space: 1.0 cm

Test Date: 11-15-2012; Ambient Temp: 23.9°C; Tissue Temp: 22.9°C

Probe: ES3DV3 - SN3209; ConvF(6.13, 6.13, 6.13); Calibrated: 3/16/2012;

Sensor-Surface: 4mm (Mechanical Surface Detection)

Electronics: DAE4 Sn649; Calibrated: 2/20/2012

Phantom: SAM with CRP; Type: SAM; Serial: TP1375

Measurement SW: DASY4, Version 4.7 (80); SEMCAD X Version 14.6.7 (6848)

**Mode: GPRS 850, Body SAR, Right Edge, Mid.ch, 2 Tx Slots**

**Area Scan (11x11x1):** Measurement grid: dx=5mm, dy=15mm

**Zoom Scan (5x5x7)/Cube 0:** Measurement grid: dx=8mm, dy=8mm, dz=5mm

Reference Value = 14.697 V/m; Power Drift = -0.08 dB

Peak SAR (extrapolated) = 0.264 W/kg

**SAR(1 g) = 0.197 W/kg; SAR(10 g) = 0.138 W/kg**

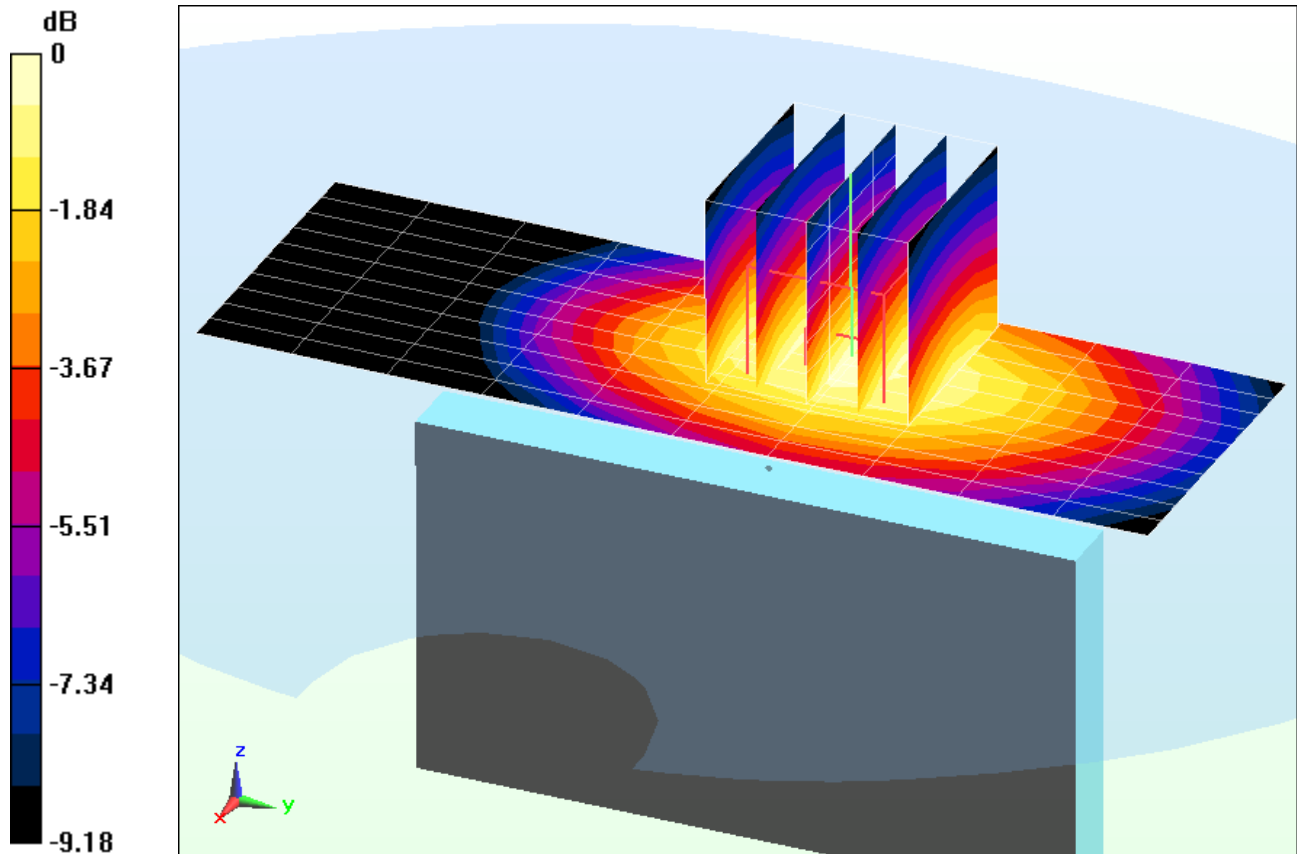

0 dB = 0.212 W/kg = -6.74 dBW/kg

# PCTEST ENGINEERING LABORATORY, INC.

**DUT: A3LGTS5301B; Type: Portable Handset; Serial: FJ-295-C**

Communication System: GSM 850 GPRS; 2 Tx slots; Frequency: 836.6 MHz; Duty Cycle: 1:4.15

Medium: 835 Body; Medium parameters used (interpolated):

$f = 836.6 \text{ MHz}$ ;  $\sigma = 0.988 \text{ mho/m}$ ;  $\epsilon_r = 55.45$ ;  $\rho = 1000 \text{ kg/m}^3$

Phantom section: Flat Section; Space: 1.0 cm

Test Date: 11-15-2012; Ambient Temp: 23.9°C; Tissue Temp: 22.9°C

Probe: ES3DV3 - SN3209; ConvF(6.13, 6.13, 6.13); Calibrated: 3/16/2012;

Sensor-Surface: 4mm (Mechanical Surface Detection)

Electronics: DAE4 Sn649; Calibrated: 2/20/2012

Phantom: SAM with CRP; Type: SAM; Serial: TP1375

Measurement SW: DASY4, Version 4.7 (80); SEMCAD X Version 14.6.7 (6848)

**Mode: GPRS 850, Body SAR, Left Edge, Mid.ch, 2 Tx Slots**

**Area Scan (9x13x1):** Measurement grid: dx=5mm, dy=15mm

**Zoom Scan (5x5x7)/Cube 0:** Measurement grid: dx=8mm, dy=8mm, dz=5mm

Reference Value = 16.015 V/m; Power Drift = -0.06 dB

Peak SAR (extrapolated) = 0.307 W/kg

**SAR(1 g) = 0.230 W/kg; SAR(10 g) = 0.163 W/kg**

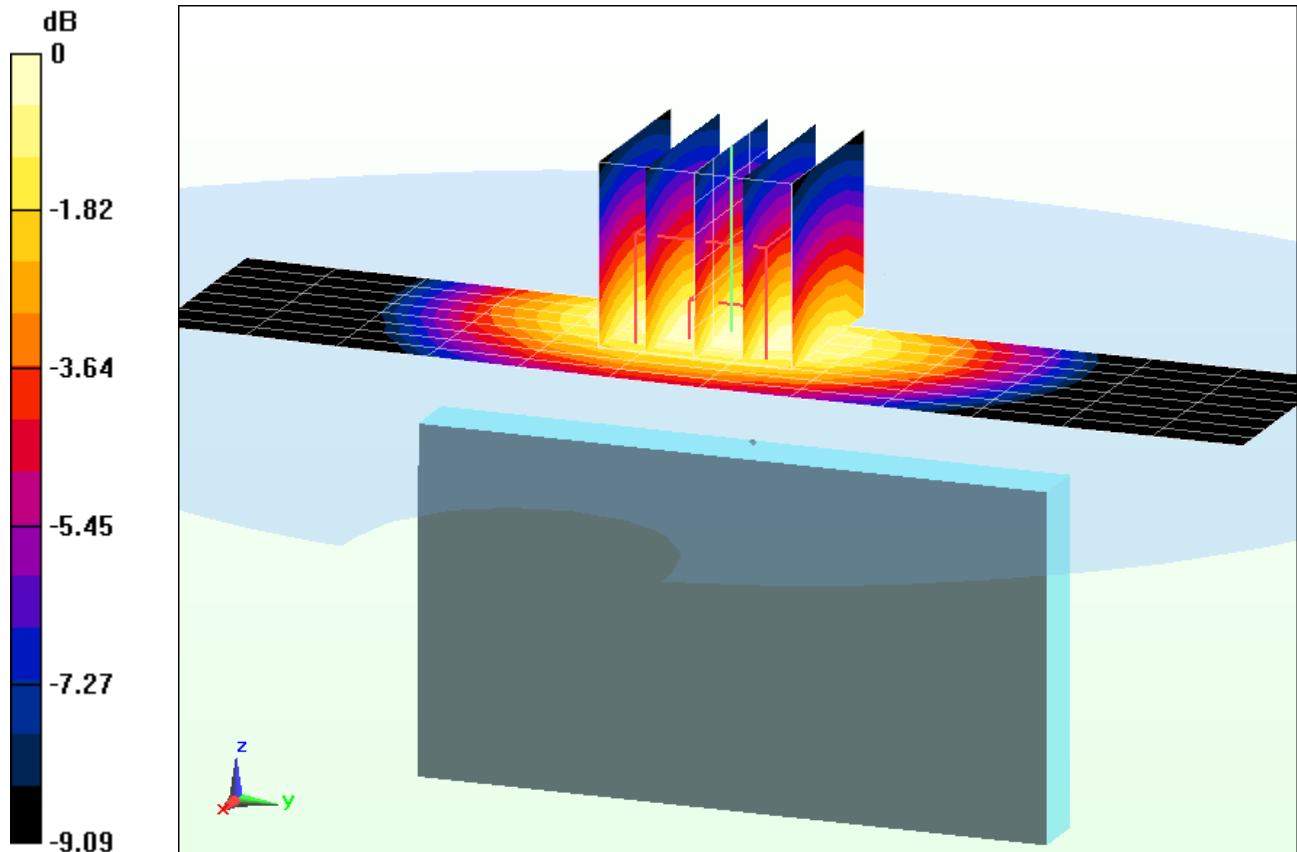

0 dB = 0.246 W/kg = -6.09 dBW/kg

# PCTEST ENGINEERING LABORATORY, INC.

**DUT: A3LGTS5301B; Type: Portable Handset; Serial: FJ-295-C**

Communication System: WCDMA850; Frequency: 836.6 MHz; Duty Cycle: 1:1

Medium: 835 Body; Medium parameters used (interpolated):

$f = 836.6 \text{ MHz}$ ;  $\sigma = 0.988 \text{ mho/m}$ ;  $\epsilon_r = 55.45$ ;  $\rho = 1000 \text{ kg/m}^3$

Phantom section: Flat Section; Space: 1.0 cm

Test Date: 11-15-2012; Ambient Temp: 23.9°C; Tissue Temp: 22.9°C

Probe: ES3DV3 - SN3209; ConvF(6.13, 6.13, 6.13); Calibrated: 3/16/2012;

Sensor-Surface: 4mm (Mechanical Surface Detection)

Electronics: DAE4 Sn649; Calibrated: 2/20/2012

Phantom: SAM with CRP; Type: SAM; Serial: TP1375

Measurement SW: DASY4, Version 4.7 (80);SEMCAD X Version 14.6.7 (6848)

**Mode: WCDMA 850, Body SAR, Back side, Mid.ch**

**Area Scan (7x12x1):** Measurement grid: dx=15mm, dy=15mm

**Zoom Scan (5x5x7)/Cube 0:** Measurement grid: dx=8mm, dy=8mm, dz=5mm

Reference Value = 20.737 V/m; Power Drift = -0.02 dB

Peak SAR (extrapolated) = 0.552 W/kg

**SAR(1 g) = 0.408 W/kg; SAR(10 g) = 0.285 W/kg**

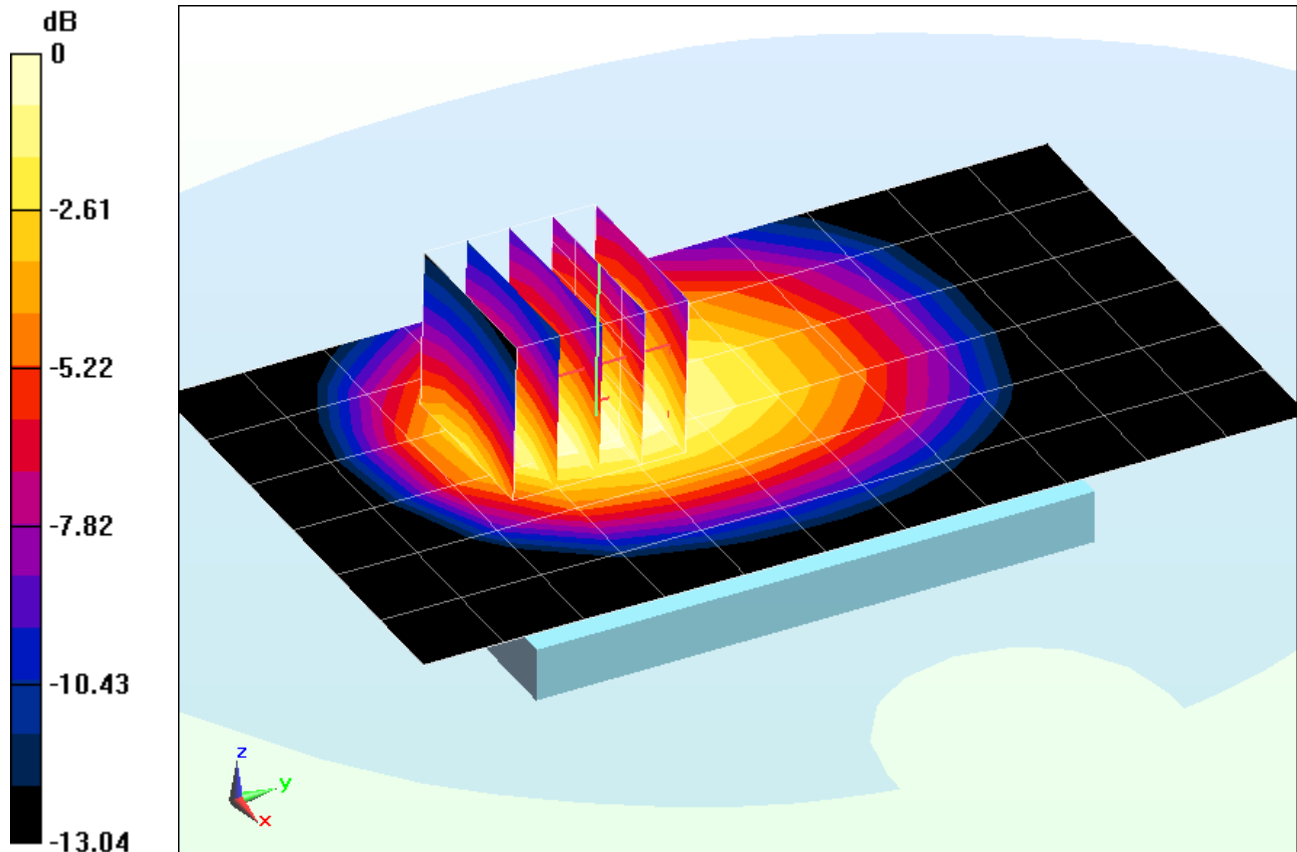

0 dB = 0.433 W/kg = -3.64 dBW/kg

# PCTEST ENGINEERING LABORATORY, INC.

**DUT: A3LGTS5301B; Type: Portable Handset; Serial: FJ-295-C**

Communication System: WCDMA850; Frequency: 836.6 MHz; Duty Cycle: 1:1  
Medium: 835 Body; Medium parameters used (interpolated):

$f = 836.6 \text{ MHz}$ ;  $\sigma = 0.988 \text{ mho/m}$ ;  $\epsilon_r = 55.45$ ;  $\rho = 1000 \text{ kg/m}^3$

Phantom section: Flat Section; Space: 1.0 cm

Test Date: 11-15-2012; Ambient Temp: 23.9°C; Tissue Temp: 22.9°C

Probe: ES3DV3 - SN3209; ConvF(6.13, 6.13, 6.13); Calibrated: 3/16/2012;  
Sensor-Surface: 4mm (Mechanical Surface Detection)

Electronics: DAE4 Sn649; Calibrated: 2/20/2012

Phantom: SAM with CRP; Type: SAM; Serial: TP1375

Measurement SW: DASY4, Version 4.7 (80);SEMCAD X Version 14.6.7 (6848)

**Mode: WCDMA 850, Body SAR, Front side, Mid.ch**

**Area Scan (7x12x1):** Measurement grid: dx=15mm, dy=15mm

**Zoom Scan (5x5x7)/Cube 0:** Measurement grid: dx=8mm, dy=8mm, dz=5mm

Reference Value = 16.757 V/m; Power Drift = -0.04 dB

Peak SAR (extrapolated) = 0.333 W/kg

**SAR(1 g) = 0.248 W/kg; SAR(10 g) = 0.174 W/kg**

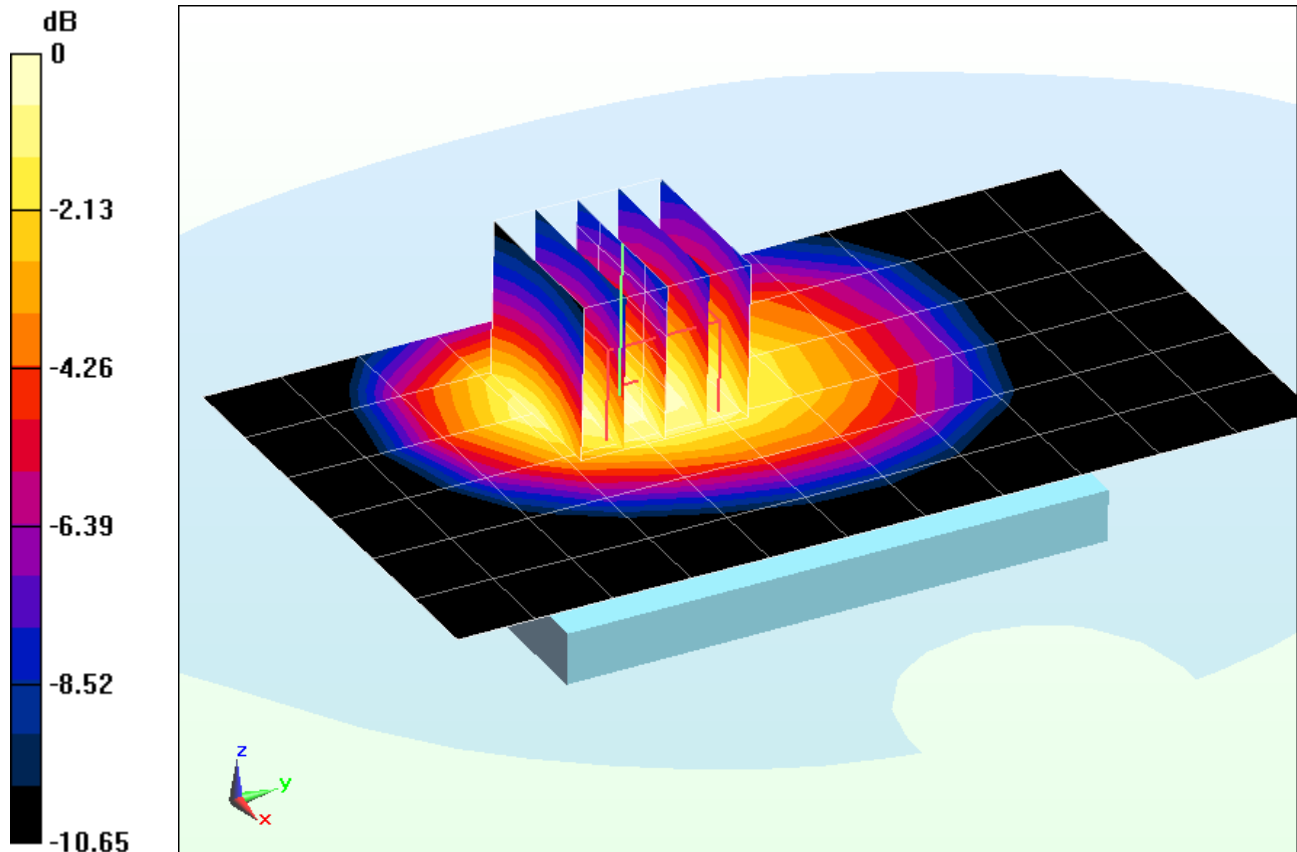

0 dB = 0.264 W/kg = -5.78 dBW/kg

# PCTEST ENGINEERING LABORATORY, INC.

**DUT: A3LGTS5301B; Type: Portable Handset; Serial: FJ-295-C**

Communication System: WCDMA850; Frequency: 836.6 MHz; Duty Cycle: 1:1

Medium: 835 Body; Medium parameters used (interpolated):

$f = 836.6 \text{ MHz}$ ;  $\sigma = 0.988 \text{ mho/m}$ ;  $\epsilon_r = 55.45$ ;  $\rho = 1000 \text{ kg/m}^3$

Phantom section: Flat Section; Space: 1.0 cm

Test Date: 11-15-2012; Ambient Temp: 23.9°C; Tissue Temp: 22.9°C

Probe: ES3DV3 - SN3209; ConvF(6.13, 6.13, 6.13); Calibrated: 3/16/2012;

Sensor-Surface: 4mm (Mechanical Surface Detection)

Electronics: DAE4 Sn649; Calibrated: 2/20/2012

Phantom: SAM with CRP; Type: SAM; Serial: TP1375

Measurement SW: DASY4, Version 4.7 (80); SEMCAD X Version 14.6.7 (6848)

**Mode: WCDMA 850, Body SAR, Bottom Edge, Mid.ch**

**Area Scan (11x7x1):** Measurement grid: dx=5mm, dy=15mm

**Zoom Scan (5x5x7)/Cube 0:** Measurement grid: dx=8mm, dy=8mm, dz=5mm

Reference Value = 6.346 V/m; Power Drift = 0.04 dB

Peak SAR (extrapolated) = 0.0710 W/kg

**SAR(1 g) = 0.038 W/kg; SAR(10 g) = 0.022 W/kg**

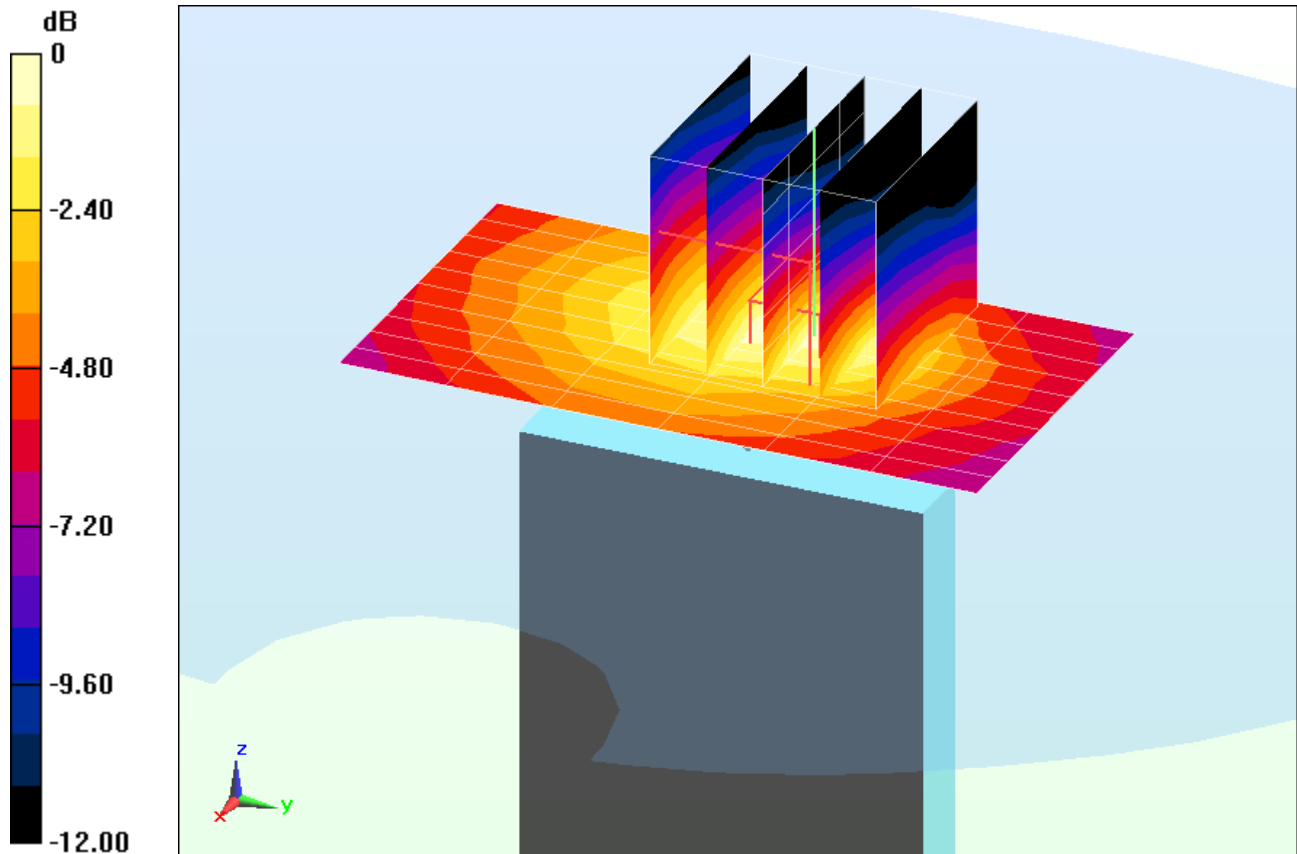

0 dB = 0.0424 W/kg = -13.73 dBW/kg

# PCTEST ENGINEERING LABORATORY, INC.

**DUT: A3LGTS5301B; Type: Portable Handset; Serial: FJ-295-C**

Communication System: WCDMA850; Frequency: 836.6 MHz; Duty Cycle: 1:1

Medium: 835 Body; Medium parameters used (interpolated):

$f = 836.6 \text{ MHz}$ ;  $\sigma = 0.988 \text{ mho/m}$ ;  $\epsilon_r = 55.45$ ;  $\rho = 1000 \text{ kg/m}^3$

Phantom section: Flat Section; Space: 1.0 cm

Test Date: 11-15-2012; Ambient Temp: 23.9°C; Tissue Temp: 22.9°C

Probe: ES3DV3 - SN3209; ConvF(6.13, 6.13, 6.13); Calibrated: 3/16/2012;

Sensor-Surface: 4mm (Mechanical Surface Detection)

Electronics: DAE4 Sn649; Calibrated: 2/20/2012

Phantom: SAM with CRP; Type: SAM; Serial: TP1375

Measurement SW: DASY4, Version 4.7 (80); SEMCAD X Version 14.6.7 (6848)

**Mode: WCDMA 850, Body SAR, Right Edge, Mid.ch**

**Area Scan (11x11x1):** Measurement grid: dx=5mm, dy=15mm

**Zoom Scan (5x5x7)/Cube 0:** Measurement grid: dx=8mm, dy=8mm, dz=5mm

Reference Value = 9.260 V/m; Power Drift = -0.08 dB

Peak SAR (extrapolated) = 0.101 W/kg

**SAR(1 g) = 0.075 W/kg; SAR(10 g) = 0.053 W/kg**

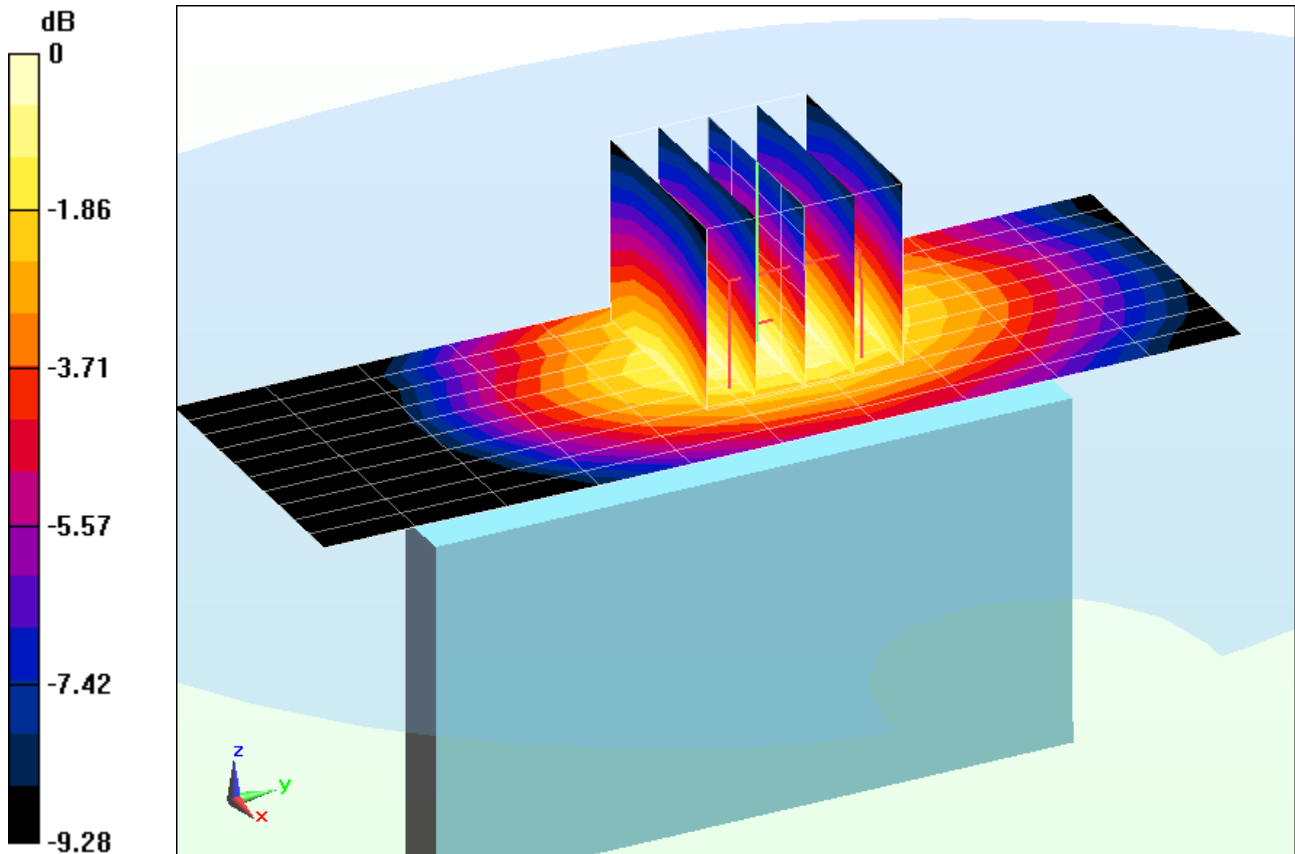

0 dB = 0.0806 W/kg = -10.94 dBW/kg

# PCTEST ENGINEERING LABORATORY, INC.

**DUT: A3LGTS5301B; Type: Portable Handset; Serial: FJ-295-C**

Communication System: WCDMA850; Frequency: 836.6 MHz; Duty Cycle: 1:1

Medium: 835 Body; Medium parameters used (interpolated):

$f = 836.6 \text{ MHz}$ ;  $\sigma = 0.988 \text{ mho/m}$ ;  $\epsilon_r = 55.45$ ;  $\rho = 1000 \text{ kg/m}^3$

Phantom section: Flat Section; Space: 1.0 cm

Test Date: 11-15-2012; Ambient Temp: 23.9°C; Tissue Temp: 22.9°C

Probe: ES3DV3 - SN3209; ConvF(6.13, 6.13, 6.13); Calibrated: 3/16/2012;

Sensor-Surface: 4mm (Mechanical Surface Detection)

Electronics: DAE4 Sn649; Calibrated: 2/20/2012

Phantom: SAM with CRP; Type: SAM; Serial: TP1375

Measurement SW: DASY4, Version 4.7 (80); SEMCAD X Version 14.6.7 (6848)

**Mode: WCDMA 850, Body SAR, Left Edge, Mid.ch**

**Area Scan (11x11x1):** Measurement grid: dx=5mm, dy=15mm

**Zoom Scan (5x5x7)/Cube 0:** Measurement grid: dx=8mm, dy=8mm, dz=5mm

Reference Value = 10.022 V/m; Power Drift = -0.06 dB

Peak SAR (extrapolated) = 0.160 W/kg

**SAR(1 g) = 0.120 W/kg; SAR(10 g) = 0.085 W/kg**

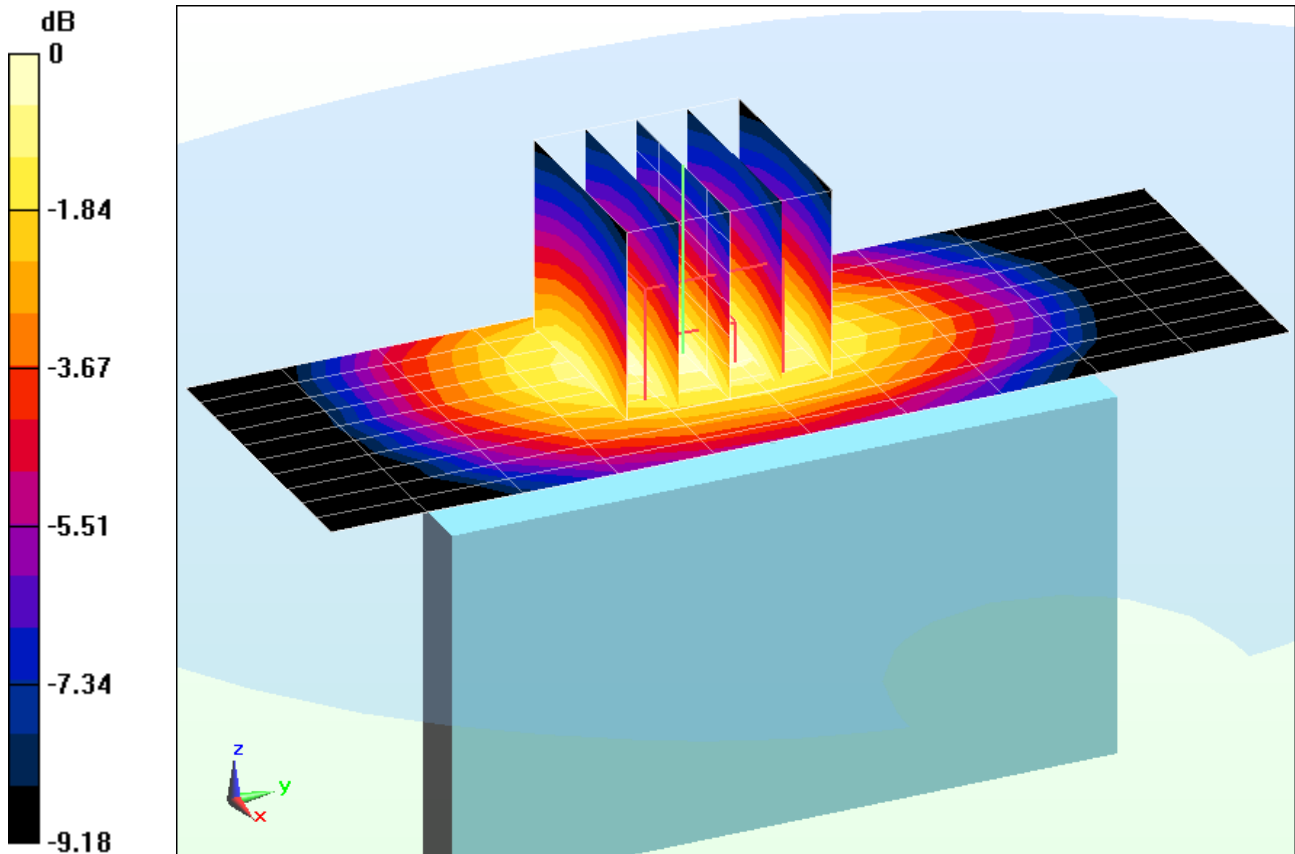

0 dB = 0.128 W/kg = -8.93 dBW/kg

# PCTEST ENGINEERING LABORATORY, INC.

**DUT: A3LGTS5301B; Type: Portable Handset; Serial: FJ-295-C**

Communication System: GSM GPRS; 2 Tx slots; Frequency: 1880 MHz; Duty Cycle: 1:4.15

Medium: 1900 Body; Medium parameters used:

$f = 1880 \text{ MHz}$ ;  $\sigma = 1.568 \text{ mho/m}$ ;  $\epsilon_r = 50.87$ ;  $\rho = 1000 \text{ kg/m}^3$

Phantom section: Flat Section; Space: 1.0 cm

Test Date: 11-14-2012; Ambient Temp: 23.5°C; Tissue Temp: 22.1°C

Probe: ES3DV3 - SN3288; ConvF(4.89, 4.89, 4.89); Calibrated: 9/20/2012;

Sensor-Surface: 4mm (Mechanical Surface Detection)

Electronics: DAE4 Sn1323; Calibrated: 9/19/2012

Phantom: SAM v5.0 front; Type: QD000P40CD; Serial: TP-1646

Measurement SW: DASY52, Version 52.8 (3); SEMCAD X Version 14.6.7 (6848)

**Mode: GPRS 1900, Body SAR, Back side, Mid.ch, 2 Tx Slots**

**Area Scan (7x10x1):** Measurement grid: dx=15mm, dy=15mm

**Zoom Scan (5x5x7)/Cube 0:** Measurement grid: dx=8mm, dy=8mm, dz=5mm

Reference Value = 15.518 V/m; Power Drift = 0.00 dB

Peak SAR (extrapolated) = 0.659 W/kg

**SAR(1 g) = 0.391 W/kg; SAR(10 g) = 0.223 W/kg**

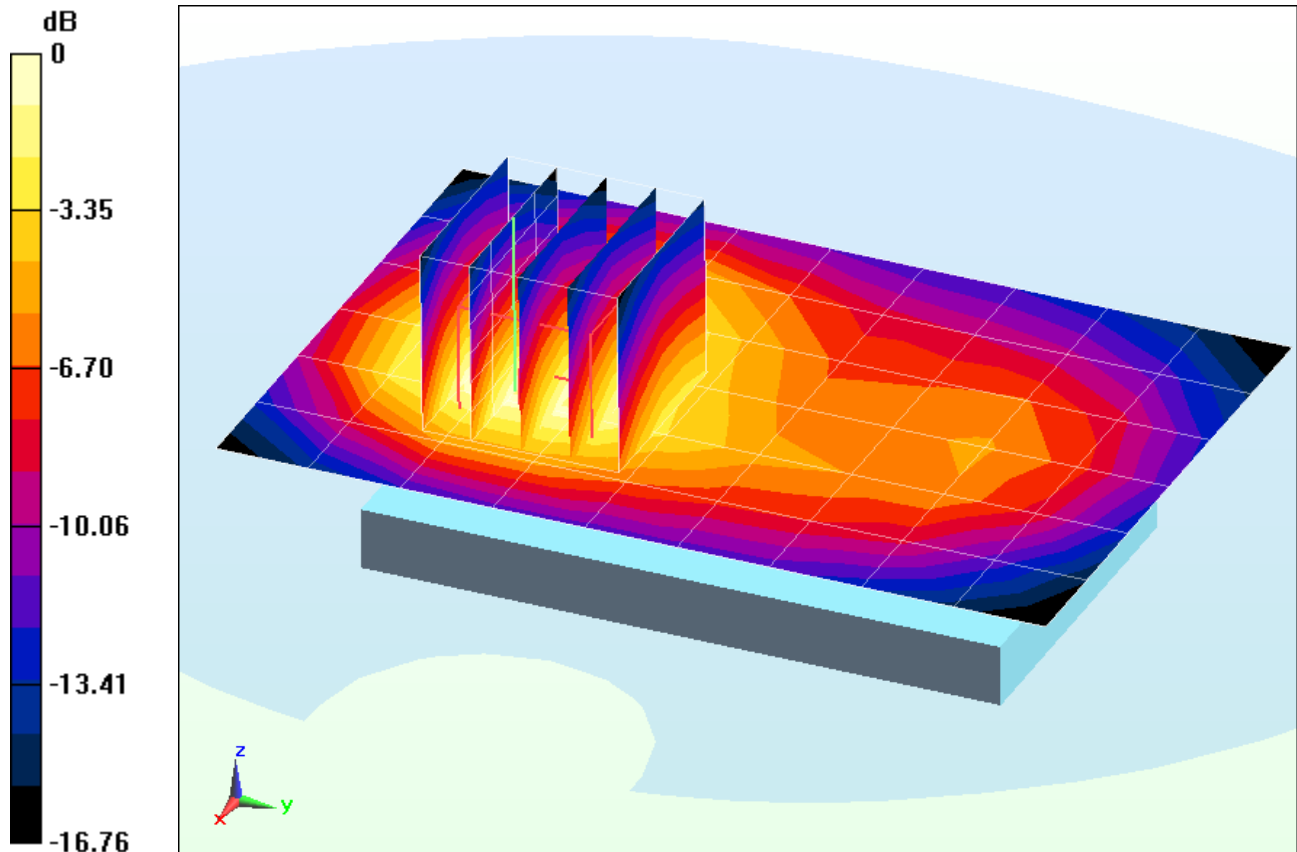

0 dB = 0.429 W/kg = -3.68 dBW/kg

# PCTEST ENGINEERING LABORATORY, INC.

**DUT: A3LGTS5301B; Type: Portable Handset; Serial: FJ-295-C**

Communication System: GSM GPRS; 2 Tx slots; Frequency: 1880 MHz; Duty Cycle: 1:4.15

Medium: 1900 Body; Medium parameters used:

$f = 1880 \text{ MHz}$ ;  $\sigma = 1.568 \text{ mho/m}$ ;  $\epsilon_r = 50.87$ ;  $\rho = 1000 \text{ kg/m}^3$

Phantom section: Flat Section; Space: 1.0 cm

Test Date: 11-14-2012; Ambient Temp: 23.5°C; Tissue Temp: 22.1°C

Probe: ES3DV3 - SN3288; ConvF(4.89, 4.89, 4.89); Calibrated: 9/20/2012;

Sensor-Surface: 4mm (Mechanical Surface Detection)

Electronics: DAE4 Sn1323; Calibrated: 9/19/2012

Phantom: SAM v5.0 front; Type: QD000P40CD; Serial: TP-1646

Measurement SW: DASY52, Version 52.8 (3); SEMCAD X Version 14.6.7 (6848)

**Mode: GPRS 1900, Body SAR, Front side, Mid.ch, 2 Tx Slots**

**Area Scan (7x10x1):** Measurement grid: dx=15mm, dy=15mm

**Zoom Scan (5x5x7)/Cube 0:** Measurement grid: dx=8mm, dy=8mm, dz=5mm

Reference Value = 15.951 V/m; Power Drift = -0.02 dB

Peak SAR (extrapolated) = 0.630 W/kg

**SAR(1 g) = 0.369 W/kg; SAR(10 g) = 0.212 W/kg**

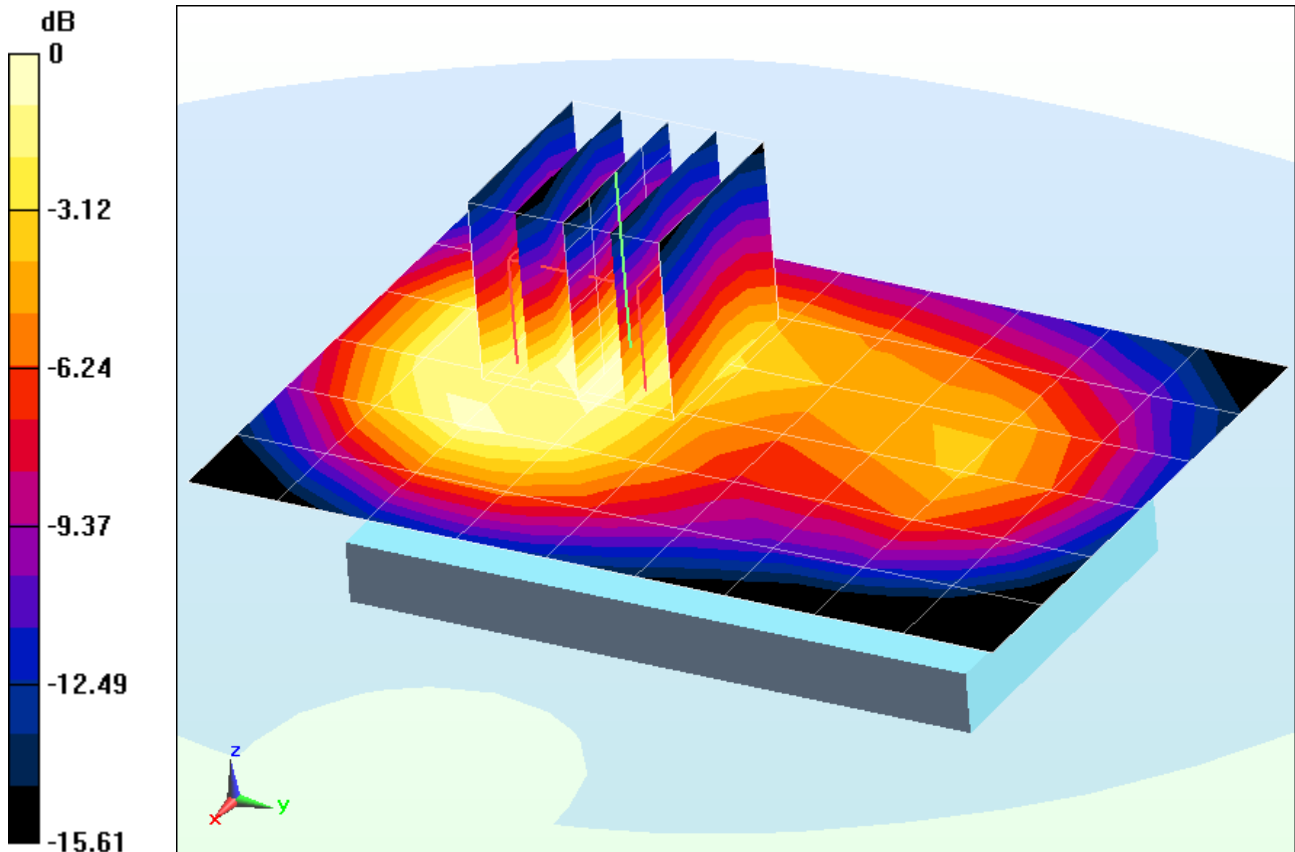

0 dB = 0.401 W/kg = -3.97 dBW/kg

# PCTEST ENGINEERING LABORATORY, INC.

**DUT: A3LGTS5301B; Type: Portable Handset; Serial: FJ-295-C**

Communication System: GSM GPRS; 2 Tx slots; Frequency: 1880 MHz; Duty Cycle: 1:4.15

Medium: 1900 Body; Medium parameters used:

$f = 1880 \text{ MHz}$ ;  $\sigma = 1.568 \text{ mho/m}$ ;  $\epsilon_r = 50.87$ ;  $\rho = 1000 \text{ kg/m}^3$

Phantom section: Flat Section; Space: 1.0 cm

Test Date: 11-14-2012; Ambient Temp: 23.5°C; Tissue Temp: 22.1°C

Probe: ES3DV3 - SN3288; ConvF(4.89, 4.89, 4.89); Calibrated: 9/20/2012;

Sensor-Surface: 4mm (Mechanical Surface Detection)

Electronics: DAE4 Sn1323; Calibrated: 9/19/2012

Phantom: SAM v5.0 front; Type: QD000P40CD; Serial: TP-1646

Measurement SW: DASY52, Version 52.8 (3); SEMCAD X Version 14.6.7 (6848)

**Mode: GPRS 1900, Body SAR, Bottom Edge, Mid.ch, 2 Tx Slots**

**Area Scan (9x7x1):** Measurement grid: dx=5mm, dy=15mm

**Zoom Scan (5x5x7)/Cube 0:** Measurement grid: dx=8mm, dy=8mm, dz=5mm

Reference Value = 13.738 V/m; Power Drift = 0.05 dB

Peak SAR (extrapolated) = 0.455 W/kg

**SAR(1 g) = 0.275 W/kg; SAR(10 g) = 0.151 W/kg**

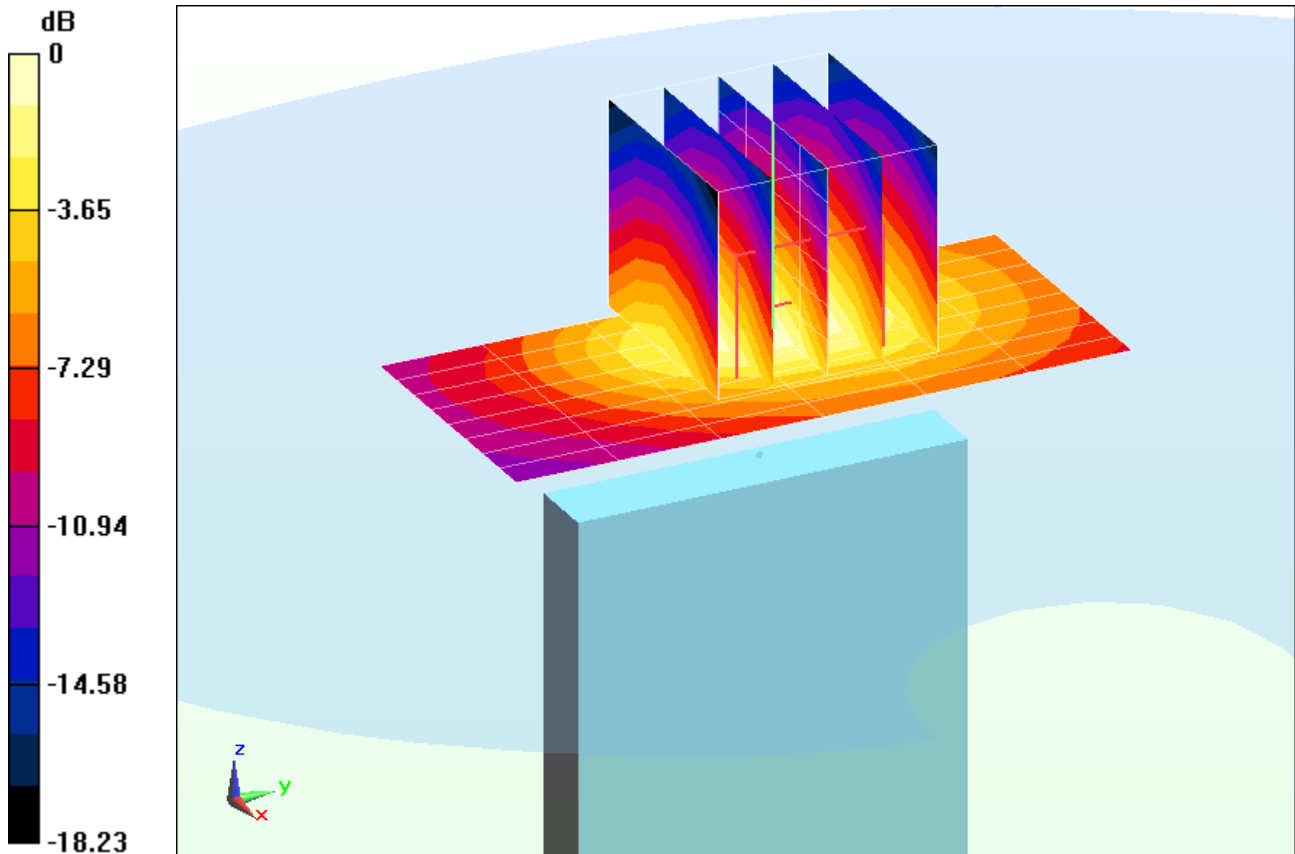

0 dB = 0.312 W/kg = -5.06 dBW/kg

# PCTEST ENGINEERING LABORATORY, INC.

**DUT: A3LGTS5301B; Type: Portable Handset; Serial: FJ-295-C**

Communication System: GSM GPRS; 2 Tx slots; Frequency: 1880 MHz; Duty Cycle: 1:4.15

Medium: 1900 Body; Medium parameters used:

$f = 1880 \text{ MHz}$ ;  $\sigma = 1.568 \text{ mho/m}$ ;  $\epsilon_r = 50.87$ ;  $\rho = 1000 \text{ kg/m}^3$

Phantom section: Flat Section; Space: 1.0 cm

Test Date: 11-14-2012; Ambient Temp: 23.5°C; Tissue Temp: 22.1°C

Probe: ES3DV3 - SN3288; ConvF(4.89, 4.89, 4.89); Calibrated: 9/20/2012;

Sensor-Surface: 4mm (Mechanical Surface Detection)

Electronics: DAE4 Sn1323; Calibrated: 9/19/2012

Phantom: SAM v5.0 front; Type: QD000P40CD; Serial: TP-1646

Measurement SW: DASY52, Version 52.8 (3); SEMCAD X Version 14.6.7 (6848)

**Mode: GPRS 1900, Body SAR, Right Edge, Mid.ch, 2 Tx Slots**

**Area Scan (10x10x1):** Measurement grid: dx=5mm, dy=15mm

**Zoom Scan (5x5x7)/Cube 0:** Measurement grid: dx=8mm, dy=8mm, dz=5mm

Reference Value = 7.826 V/m; Power Drift = 0.11 dB

Peak SAR (extrapolated) = 0.139 W/kg

**SAR(1 g) = 0.086 W/kg; SAR(10 g) = 0.050 W/kg**

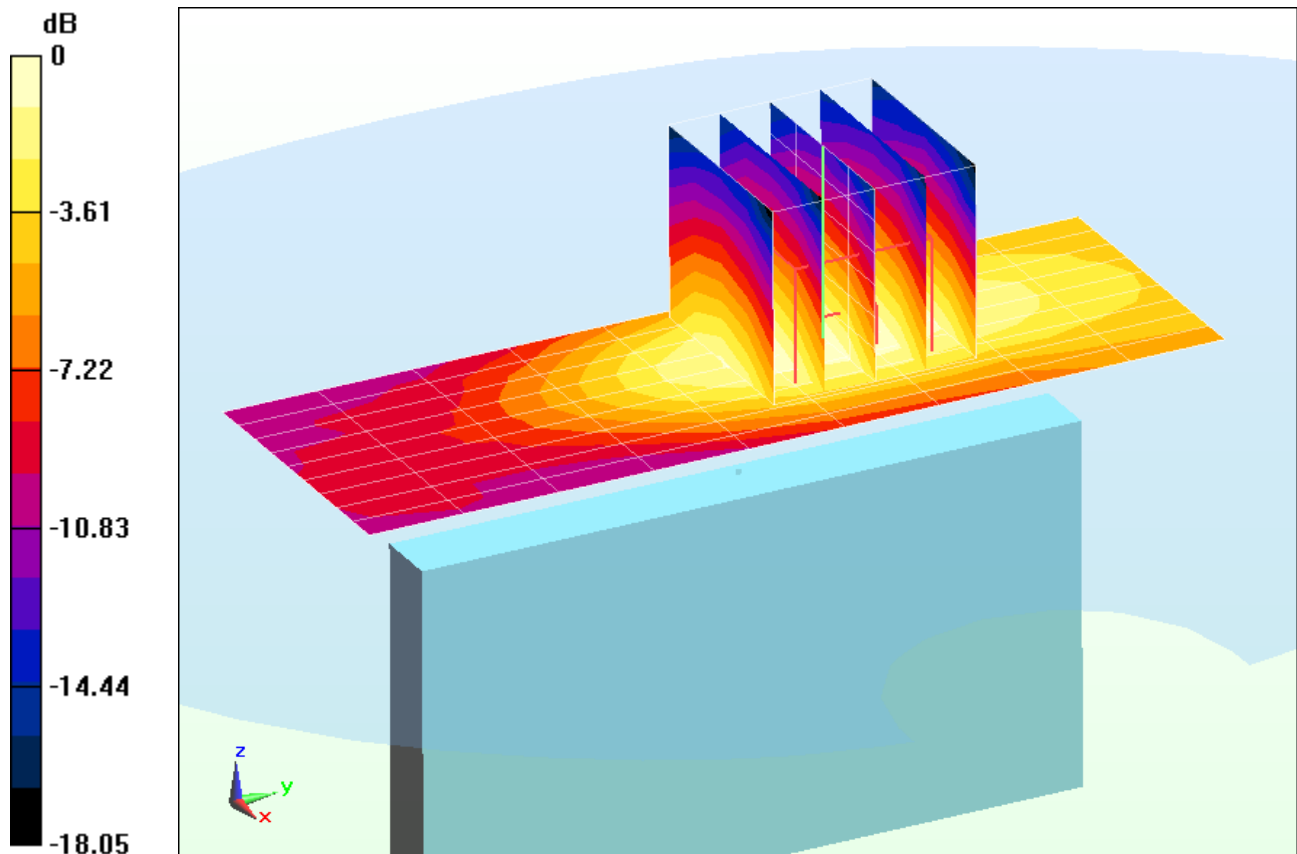

0 dB = 0.0942 W/kg = -10.26 dBW/kg

# PCTEST ENGINEERING LABORATORY, INC.

**DUT: A3LGTS5301B; Type: Portable Handset; Serial: FJ-295-C**

Communication System: GSM GPRS; 2 Tx slots; Frequency: 1880 MHz; Duty Cycle: 1:4.15

Medium: 1900 Body; Medium parameters used:

$f = 1880 \text{ MHz}$ ;  $\sigma = 1.568 \text{ mho/m}$ ;  $\epsilon_r = 50.87$ ;  $\rho = 1000 \text{ kg/m}^3$

Phantom section: Flat Section; Space: 1.0 cm

Test Date: 11-14-2012; Ambient Temp: 23.5°C; Tissue Temp: 22.1°C

Probe: ES3DV3 - SN3288; ConvF(4.89, 4.89, 4.89); Calibrated: 9/20/2012;

Sensor-Surface: 4mm (Mechanical Surface Detection)

Electronics: DAE4 Sn1323; Calibrated: 9/19/2012

Phantom: SAM v5.0 front; Type: QD000P40CD; Serial: TP-1646

Measurement SW: DASY52, Version 52.8 (3); SEMCAD X Version 14.6.7 (6848)

**Mode: GPRS 1900, Body SAR, Left Edge, Mid.ch, 2 Tx Slots**

**Area Scan (9x10x1):** Measurement grid: dx=5mm, dy=15mm

**Zoom Scan (5x5x7)/Cube 0:** Measurement grid: dx=8mm, dy=8mm, dz=5mm

Reference Value = 9.742 V/m; Power Drift = -0.02 dB

Peak SAR (extrapolated) = 0.207 W/kg

**SAR(1 g) = 0.130 W/kg; SAR(10 g) = 0.078 W/kg**

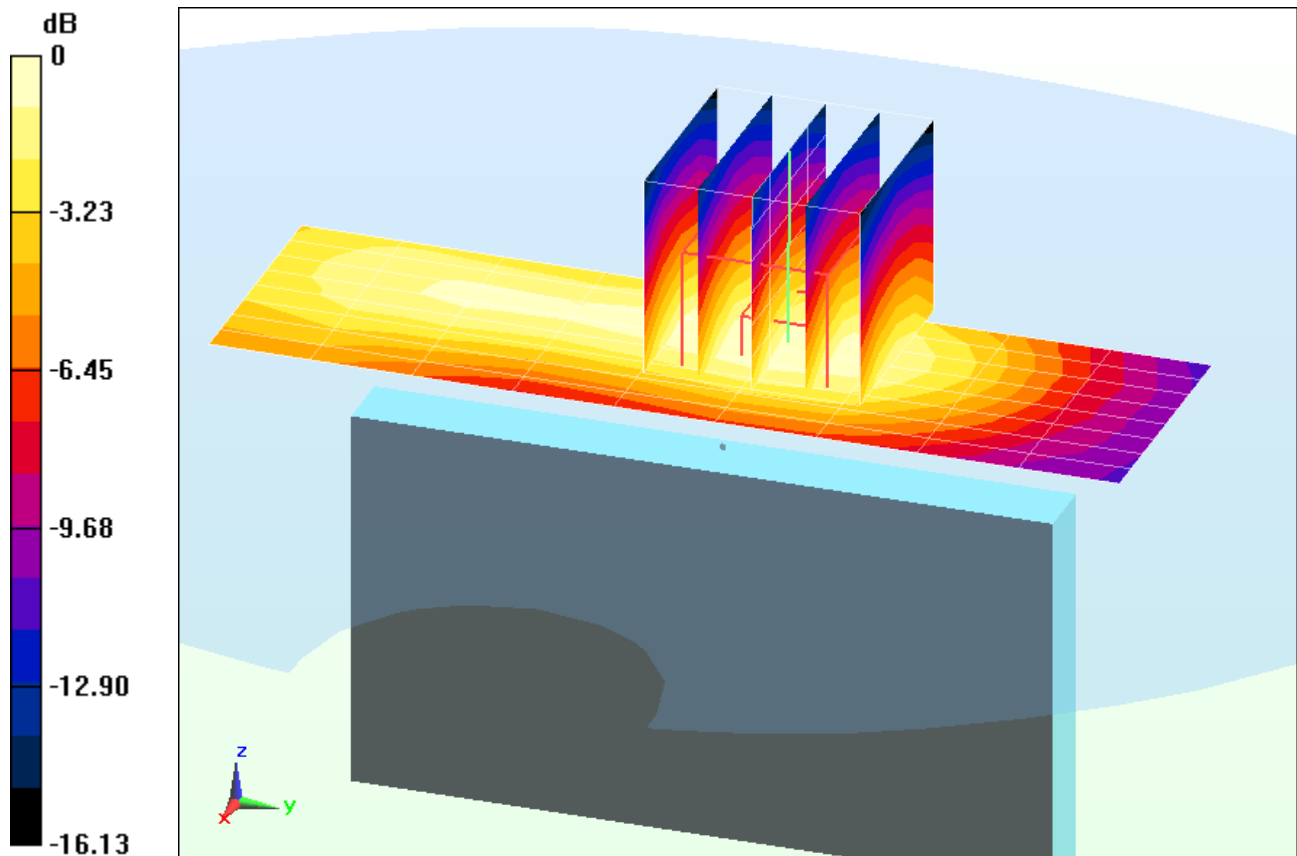

0 dB = 0.143 W/kg = -8.45 dBW/kg

# PCTEST ENGINEERING LABORATORY, INC.

**DUT: A3LGTS5301B; Type: Portable Handset; Serial: FJ-295-C**

Communication System: IEEE 802.11b; Frequency: 2412 MHz; Duty Cycle: 1:1  
Medium: 2450 Body; Medium parameters used (interpolated):  
 $f = 2412 \text{ MHz}$ ;  $\sigma = 1.987 \text{ mho/m}$ ;  $\epsilon_r = 51.472$ ;  $\rho = 1000 \text{ kg/m}^3$   
Phantom section: Flat Section; Space: 1.0 cm

Test Date: 11-15-2012; Ambient Temp: 23.3°C; Tissue Temp: 22.1°C

Probe: ES3DV3 - SN3258; ConvF(4.28, 4.28, 4.28); Calibrated: 2/21/2012;  
Sensor-Surface: 3mm (Mechanical Surface Detection)  
Electronics: DAE4 Sn1272; Calibrated: 1/18/2012  
Phantom: SAM Main; Type: SAM 4.0; Serial: TP-1114  
Measurement SW: DASY4, Version 4.7 (80);SEMCAD X Version 14.6.7 (6848)

**Mode: IEEE 802.11b, Body SAR, Ch 01, 1 Mbps, Back Side**

**Area Scan (9x13x1):** Measurement grid: dx=12mm, dy=12mm  
**Zoom Scan (7x7x7)/Cube 0:** Measurement grid: dx=5mm, dy=5mm, dz=5mm  
Reference Value = 8.277 V/m; Power Drift = 0.04 dB  
Peak SAR (extrapolated) = 0.230 W/kg  
**SAR(1 g) = 0.123 W/kg; SAR(10 g) = 0.067 W/kg**

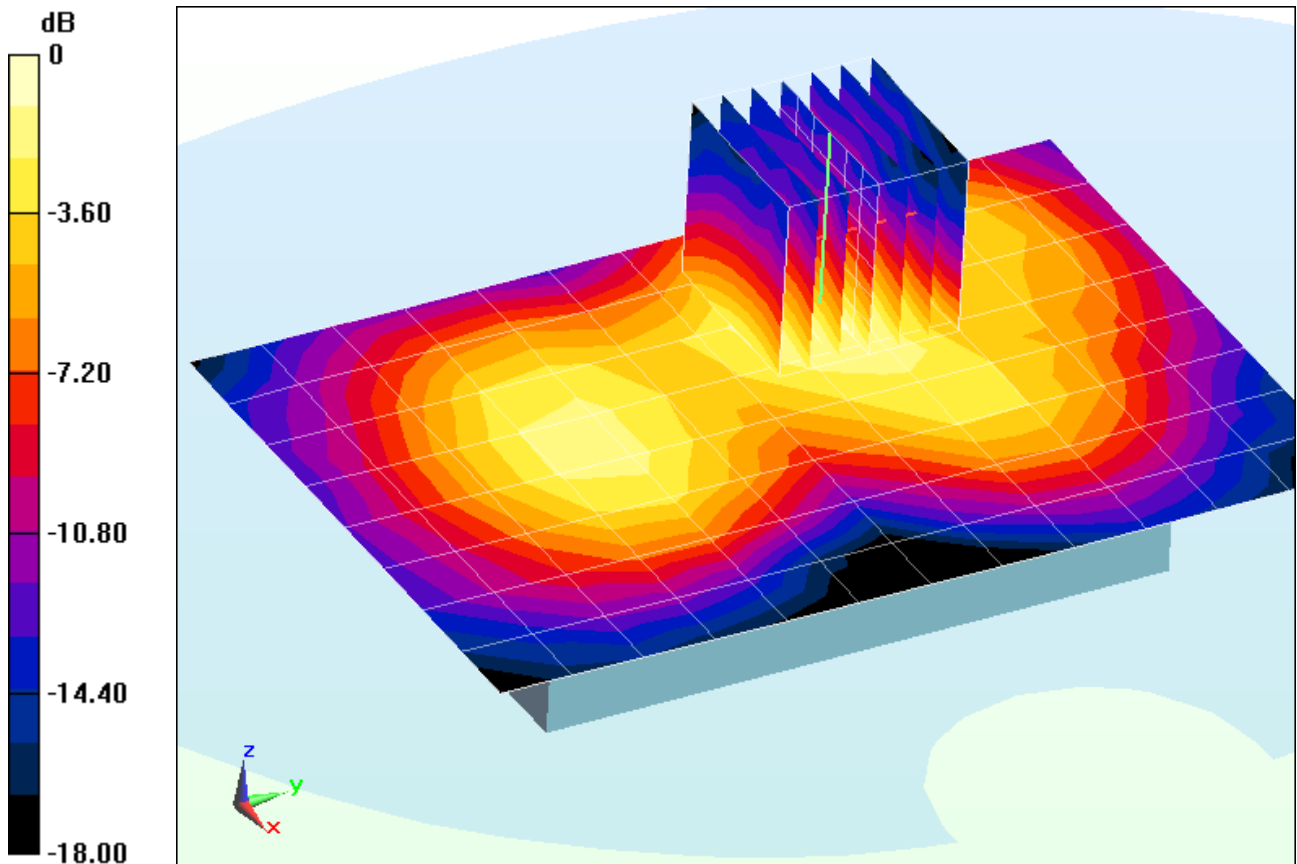

0 dB = 0.152 W/kg = -8.18 dBW/kg

# PCTEST ENGINEERING LABORATORY, INC.

**DUT: A3LGTS5301B; Type: Portable Handset; Serial: FJ-295-C**

Communication System: IEEE 802.11b; Frequency: 2412 MHz; Duty Cycle: 1:1  
Medium: 2450 Body; Medium parameters used (interpolated):  
 $f = 2412 \text{ MHz}$ ;  $\sigma = 1.987 \text{ mho/m}$ ;  $\epsilon_r = 51.472$ ;  $\rho = 1000 \text{ kg/m}^3$   
Phantom section: Flat Section; Space: 1.0 cm

Test Date: 11-15-2012; Ambient Temp: 23.3°C; Tissue Temp: 22.1°C

Probe: ES3DV3 - SN3258; ConvF(4.28, 4.28, 4.28); Calibrated: 2/21/2012;  
Sensor-Surface: 3mm (Mechanical Surface Detection)  
Electronics: DAE4 Sn1272; Calibrated: 1/18/2012  
Phantom: SAM Main; Type: SAM 4.0; Serial: TP-1114  
Measurement SW: DASY4, Version 4.7 (80);SEMCAD X Version 14.6.7 (6848)

**Mode: IEEE 802.11b, Body SAR, Ch 01, 1 Mbps, Front Side**

**Area Scan (9x13x1):** Measurement grid: dx=12mm, dy=12mm  
**Zoom Scan (7x7x7)/Cube 0:** Measurement grid: dx=5mm, dy=5mm, dz=5mm  
Reference Value = 8.214 V/m; Power Drift = -0.044 dB  
Peak SAR (extrapolated) = 0.246 W/kg  
**SAR(1 g) = 0.122 W/kg; SAR(10 g) = 0.064 W/kg**

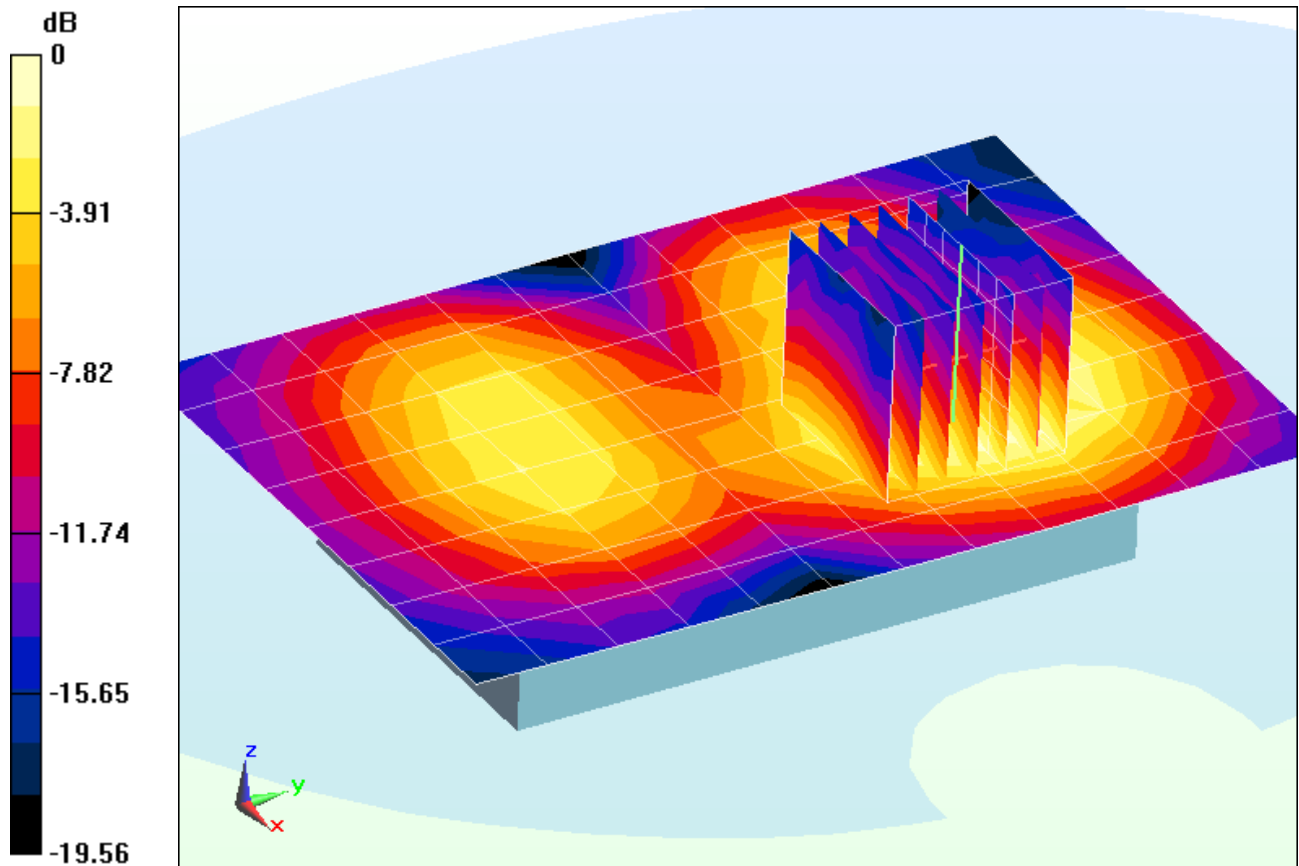

0 dB = 0.155 W/kg = -8.10 dBW/kg

# PCTEST ENGINEERING LABORATORY, INC.

**DUT: A3LGTS5301B; Type: Portable Handset; Serial: FJ-295-C**

Communication System: IEEE 802.11b; Frequency: 2412 MHz; Duty Cycle: 1:1  
Medium: 2450 Body; Medium parameters used (interpolated):  
 $f = 2412 \text{ MHz}$ ;  $\sigma = 1.987 \text{ mho/m}$ ;  $\epsilon_r = 51.472$ ;  $\rho = 1000 \text{ kg/m}^3$   
Phantom section: Flat Section; Space: 1.0 cm

Test Date: 11-15-2012; Ambient Temp: 23.3°C; Tissue Temp: 22.1°C

Probe: ES3DV3 - SN3258; ConvF(4.28, 4.28, 4.28); Calibrated: 2/21/2012;  
Sensor-Surface: 3mm (Mechanical Surface Detection)  
Electronics: DAE4 Sn1272; Calibrated: 1/18/2012  
Phantom: SAM Main; Type: SAM 4.0; Serial: TP-1114  
Measurement SW: DASY4, Version 4.7 (80);SEMCAD X Version 14.6.7 (6848)

**Mode: IEEE 802.11b, Body SAR, Ch 01, 1 Mbps, Top Edge**

**Area Scan (13x8x1):** Measurement grid: dx=5mm, dy=12mm  
**Zoom Scan (7x7x7)/Cube 0:** Measurement grid: dx=5mm, dy=5mm, dz=5mm  
Reference Value = 5.236 V/m; Power Drift = -0.032 dB  
Peak SAR (extrapolated) = 0.0960 W/kg  
**SAR(1 g) = 0.049 W/kg; SAR(10 g) = 0.027 W/kg**

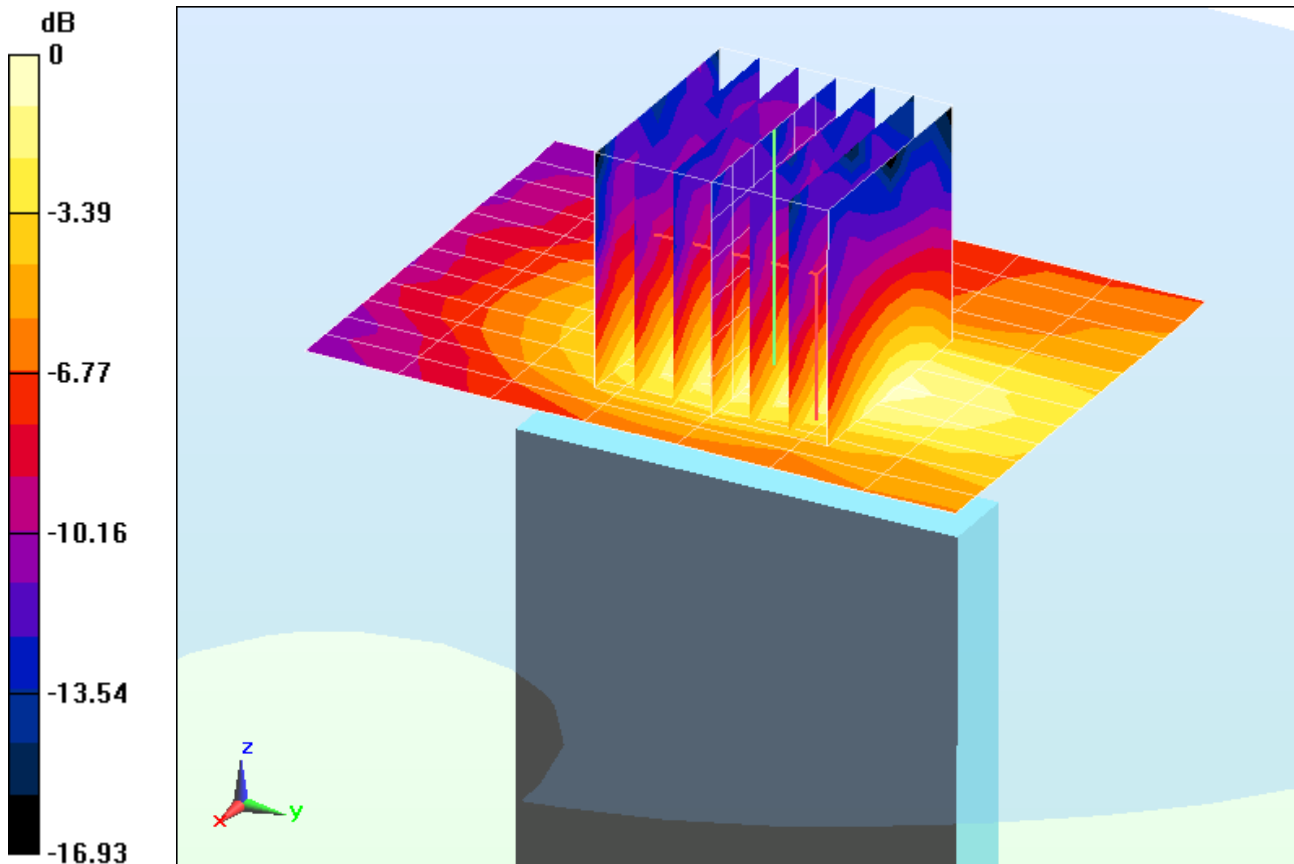

0 dB = 0.0610 W/kg = -12.15 dBW/kg

# PCTEST ENGINEERING LABORATORY, INC.

**DUT: A3LGTS5301B; Type: Portable Handset; Serial: FJ-295-C**

Communication System: IEEE 802.11b; Frequency: 2412 MHz; Duty Cycle: 1:1  
Medium: 2450 Body; Medium parameters used (interpolated):  
 $f = 2412 \text{ MHz}$ ;  $\sigma = 1.987 \text{ mho/m}$ ;  $\epsilon_r = 51.472$ ;  $\rho = 1000 \text{ kg/m}^3$   
Phantom section: Flat Section; Space: 1.0 cm

Test Date: 11-15-2012; Ambient Temp: 23.3°C; Tissue Temp: 22.1°C

Probe: ES3DV3 - SN3258; ConvF(4.28, 4.28, 4.28); Calibrated: 2/21/2012;  
Sensor-Surface: 3mm (Mechanical Surface Detection)  
Electronics: DAE4 Sn1272; Calibrated: 1/18/2012  
Phantom: SAM Main; Type: SAM 4.0; Serial: TP-1114  
Measurement SW: DASY4, Version 4.7 (80);SEMCAD X Version 14.6.7 (6848)

**Mode: IEEE 802.11b, Body SAR, Ch 01, 1 Mbps, Right Edge**

**Area Scan (9x14x1):** Measurement grid: dx=5mm, dy=12mm  
**Zoom Scan (7x7x7)/Cube 0:** Measurement grid: dx=5mm, dy=5mm, dz=5mm  
Reference Value = 9.065 V/m; Power Drift = -0.02 dB  
Peak SAR (extrapolated) = 0.321 W/kg  
**SAR(1 g) = 0.152 W/kg; SAR(10 g) = 0.077 W/kg**

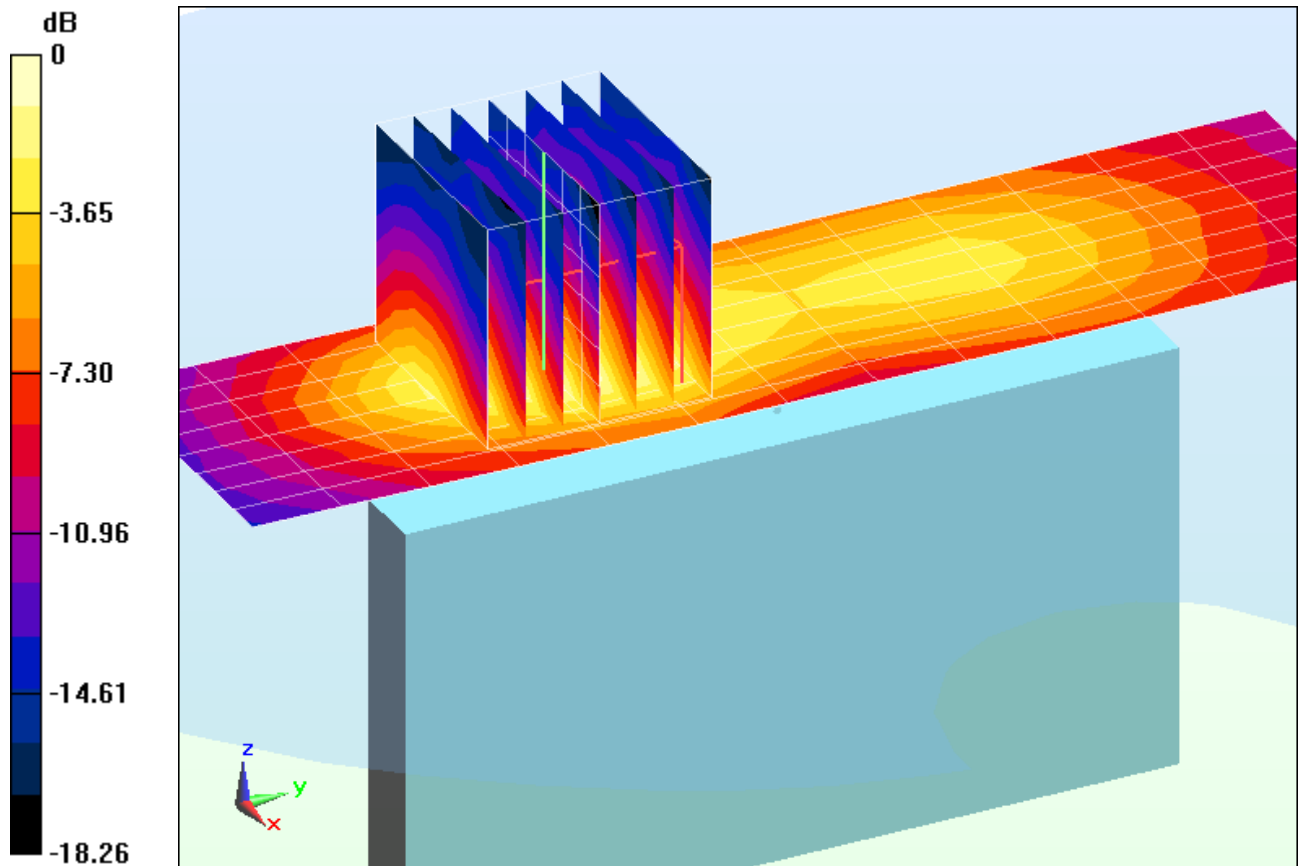

0 dB = 0.194 W/kg = -7.12 dBW/kg

## APPENDIX B: SYSTEM VERIFICATION

# PCTEST ENGINEERING LABORATORY, INC.

**DUT: SAR Dipole 835 MHz; Type: D835V2; Serial: 4d132**

Communication System: CW; Frequency: 835 MHz; Duty Cycle: 1:1

Medium: 835 Head; Medium parameters used:

$f = 835 \text{ MHz}$ ;  $\sigma = 0.913 \text{ mho/m}$ ;  $\epsilon_r = 42.19$ ;  $\rho = 1000 \text{ kg/m}^3$

Phantom section: Flat Section; Space: 1.5 cm

Test Date: 11-14-2012; Ambient Temp: 23.4°C; Tissue Temp: 21.7°C

Probe: ES3DV3 - SN3213; ConvF(6.07, 6.07, 6.07); Calibrated: 4/24/2012;

Sensor-Surface: 4mm (Mechanical Surface Detection)

Electronics: DAE4 Sn665; Calibrated: 4/19/2012

Phantom: SAM Right; Type: QD000P40CD; Serial: 1686

Measurement SW: DASY52, Version 52.8 (3);SEMCAD X Version 14.6.7 (6848)

## 835 MHz System Verification

**Area Scan (7x14x1):** Measurement grid: dx=15mm, dy=15mm

**Zoom Scan (5x5x7)/Cube 0:** Measurement grid: dx=8mm, dy=8mm, dz=5mm

Input Power = 20.0 dBm (100 mW)

Peak SAR (extrapolated) = 1.39 W/kg

**SAR(1 g) = 0.947 W/kg; SAR(10 g) = 0.617 W/kg**

Deviation = 0.21%

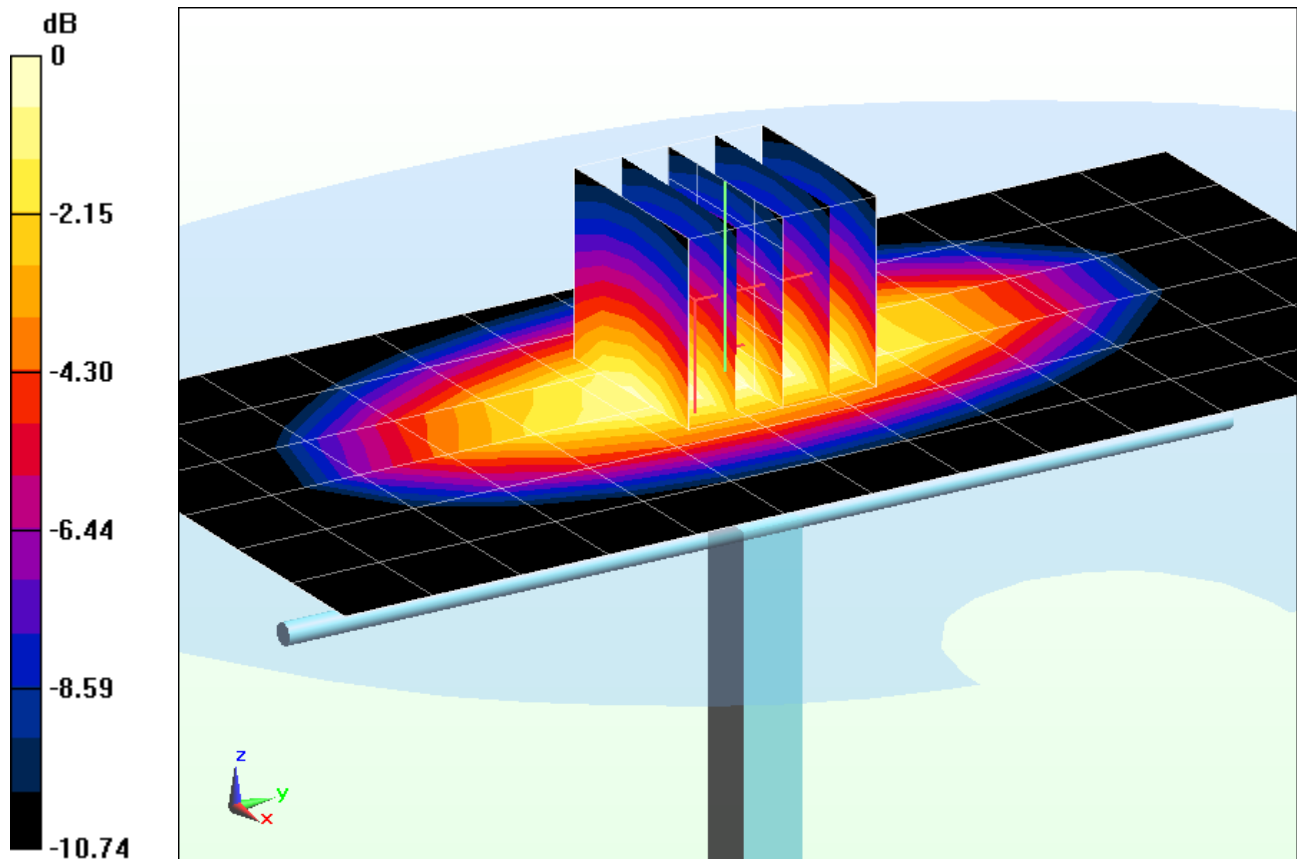

0 dB = 1.03 W/kg = 0.13 dBW/kg

# PCTEST ENGINEERING LABORATORY, INC.

**DUT: SAR Dipole 835 MHz; Type: D835V2; Serial: 4d132**

Communication System: CW; Frequency: 835 MHz; Duty Cycle: 1:1  
Medium: 835 Head; Medium parameters used:

$$f = 835 \text{ MHz}; \sigma = 0.913 \text{ mho/m}; \epsilon_r = 42.19; \rho = 1000 \text{ kg/m}^3$$

Phantom section: Flat Section; Space: 1.5 cm

Test Date: 11-14-2012; Ambient Temp: 23.4°C; Tissue Temp: 21.7°C

Probe: ES3DV3 - SN3213; ConvF(6.07, 6.07, 6.07); Calibrated: 4/24/2012;

Sensor-Surface: 4mm (Mechanical Surface Detection)

Electronics: DAE4 Sn665; Calibrated: 4/19/2012

Phantom: SAM Right; Type: QD000P40CD; Serial: 1686

Measurement SW: DASY52, Version 52.8 (3); SEMCAD X Version 14.6.7 (6848)

## 835 MHz System Verification

**Area Scan (7x14x1):** Measurement grid: dx=15mm, dy=15mm

**Zoom Scan (5x5x7)/Cube 0:** Measurement grid: dx=8mm, dy=8mm, dz=5mm

Input Power = 20.0 dBm (100 mW)

Peak SAR (extrapolated) = 1.39 W/kg

**SAR(1 g) = 0.947 W/kg; SAR(10 g) = 0.617 W/kg**

Deviation = 0.21%

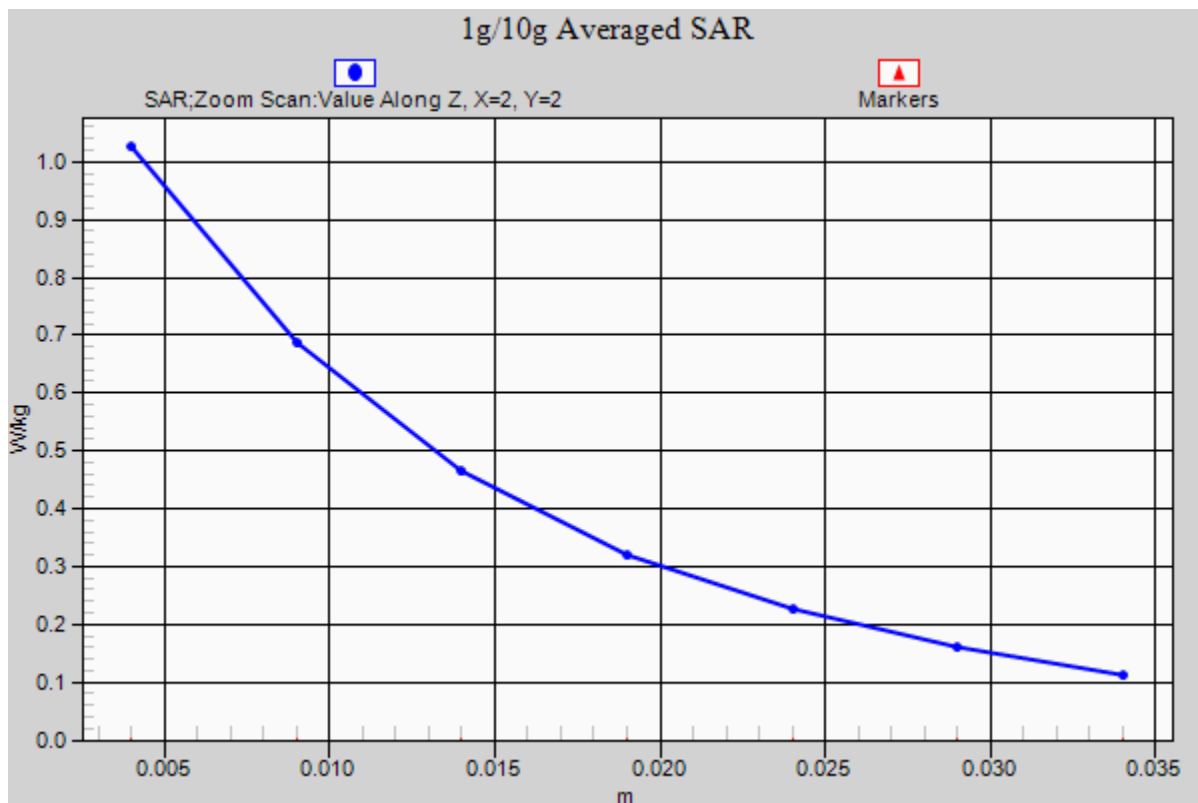

# PCTEST ENGINEERING LABORATORY, INC.

**DUT: SAR Dipole 1900 MHz; Type: D1900V2; Serial: 502**

Communication System: CW; Frequency: 1900 MHz; Duty Cycle: 1:1

Medium: 1900 Head; Medium parameters used (interpolated):

$f = 1900 \text{ MHz}$ ;  $\sigma = 1.455 \text{ mho/m}$ ;  $\epsilon_r = 39.937$ ;  $\rho = 1000 \text{ kg/m}^3$

Phantom section: Flat Section; Space: 1.0 cm

Test Date: 11-14-2012; Ambient Temp: 24.8°C; Tissue Temp: 23.4°C

Probe: ES3DV3 - SN3209; ConvF(5.15, 5.15, 5.15); Calibrated: 3/16/2012;

Sensor-Surface: 4mm (Mechanical Surface Detection)

Electronics: DAE4 Sn649; Calibrated: 2/20/2012

Phantom: SAM Sub Dasy B; Type: SAM 5.0; Serial: TP-1626

Measurement SW: DASY4, Version 4.7 (80);SEMCAD X Version 14.6.7 (6848)

## 1900MHz System Verification

**Area Scan (5x7x1):** Measurement grid: dx=15mm, dy=15mm

**Zoom Scan (5x5x7)/Cube 0:** Measurement grid: dx=8mm, dy=8mm, dz=5mm

Input Power = 20.0 dBm (100 mW)

Peak SAR (extrapolated) = 7.12 W/kg

**SAR(1 g) = 3.83 W/kg; SAR(10 g) = 2.01 W/kg**

Deviation = -2.30%

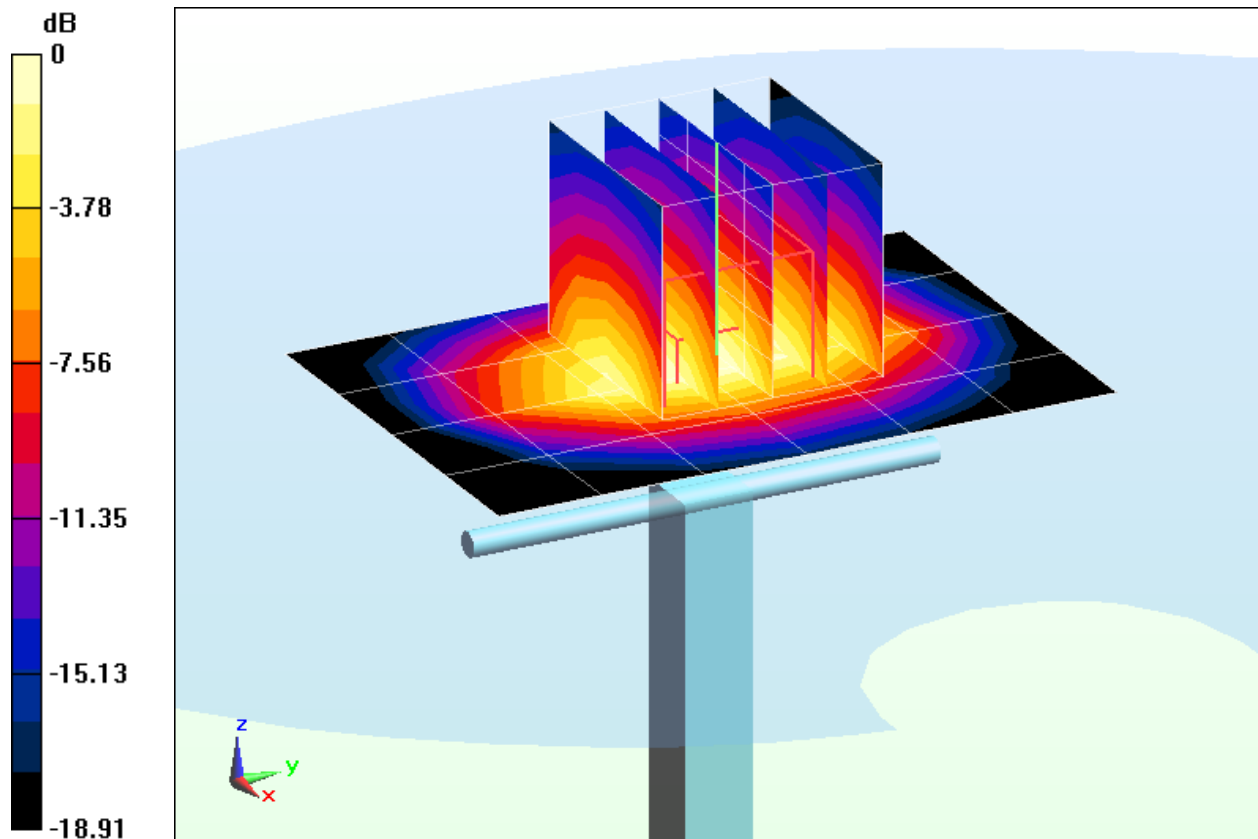

0 dB = 4.18 W/kg = 6.21 dBW/kg

# PCTEST ENGINEERING LABORATORY, INC.

**DUT: SAR Dipole 1900 MHz; Type: D1900V2; Serial: 502**

Communication System: CW; Frequency: 1900 MHz; Duty Cycle: 1:1

Medium: 1900 Head; Medium parameters used (interpolated):

$f = 1900 \text{ MHz}$ ;  $\sigma = 1.455 \text{ mho/m}$ ;  $\epsilon_r = 39.937$ ;  $\rho = 1000 \text{ kg/m}^3$

Phantom section: Flat Section; Space: 1.0 cm

Test Date: 11-14-2012; Ambient Temp: 24.8°C; Tissue Temp: 23.4°C

Probe: ES3DV3 - SN3209; ConvF(5.15, 5.15, 5.15); Calibrated: 3/16/2012;

Sensor-Surface: 4mm (Mechanical Surface Detection)

Electronics: DAE4 Sn649; Calibrated: 2/20/2012

Phantom: SAM Sub Dasy B; Type: SAM 5.0; Serial: TP-1626

Measurement SW: DASY4, Version 4.7 (80);SEMCAD X Version 14.6.7 (6848)

## 1900MHz System Verification

**Area Scan (5x7x1):** Measurement grid: dx=15mm, dy=15mm

**Zoom Scan (5x5x7)/Cube 0:** Measurement grid: dx=8mm, dy=8mm, dz=5mm

Input Power = 20.0 dBm (100 mW)

Peak SAR (extrapolated) = 7.12 W/kg

**SAR(1 g) = 3.83 W/kg; SAR(10 g) = 2.01 W/kg**

Deviation = -2.30%

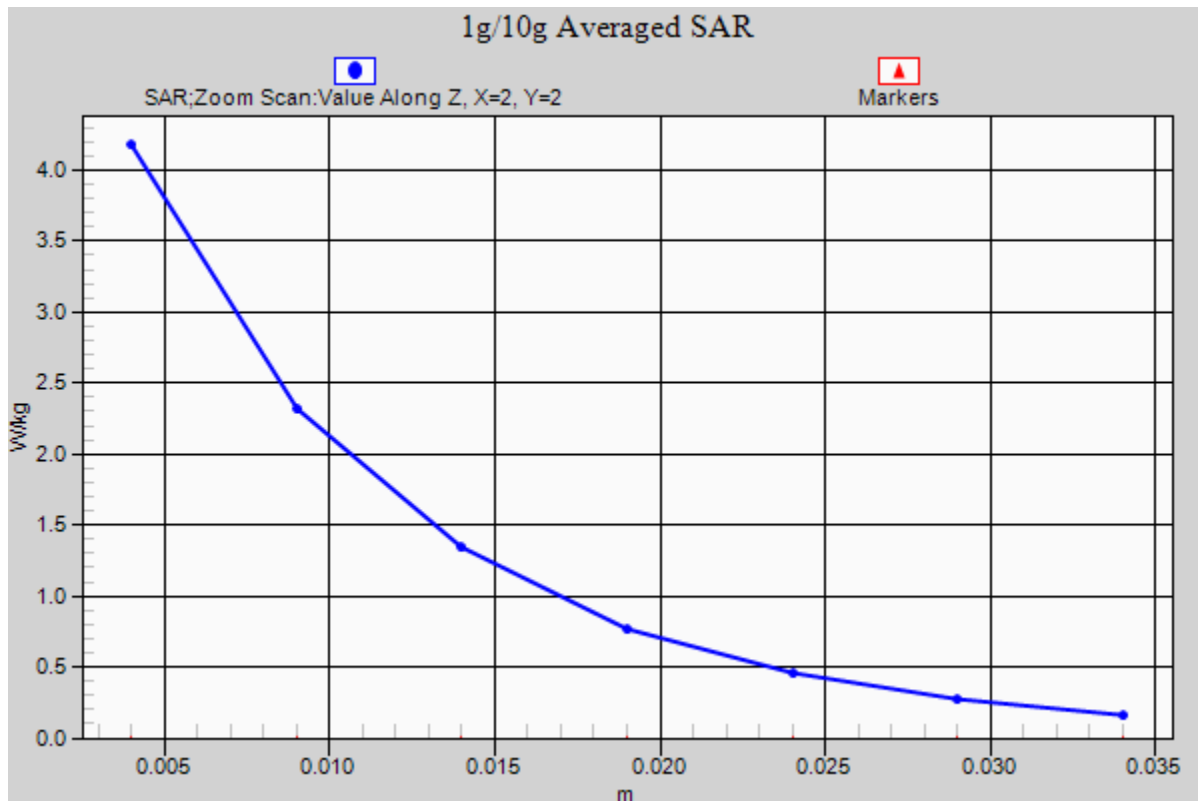

# PCTEST ENGINEERING LABORATORY, INC.

**DUT: Dipole 2450 MHz; Type: D2450V2; Serial: 882**

Communication System: CW; Frequency: 2450 MHz; Duty Cycle: 1:1

Medium: 2450 Head; Medium parameters used:

$f = 2450 \text{ MHz}$ ;  $\sigma = 1.764 \text{ mho/m}$ ;  $\epsilon_r = 39.28$ ;  $\rho = 1000 \text{ kg/m}^3$

Phantom section: Flat Section; Space: 1.0 cm

Test Date: 11-16-2012; Ambient Temp: 23.3°C; Tissue Temp: 23.0°C

Probe: ES3DV3 - SN3263; ConvF(4.45, 4.45, 4.45); Calibrated: 5/18/2012;

Sensor-Surface: 3mm (Mechanical Surface Detection)

Electronics: DAE4 Sn1334; Calibrated: 5/7/2012

Phantom: SAM 5.0 front; Type: QD000P40CD; Serial: TP:-1648

Measurement SW: DASY52, Version 52.8 (3);SEMCAD X Version 14.6.7 (6848)

## 2450 MHz System Verification

**Area Scan (8x9x1):** Measurement grid: dx=12mm, dy=12mm

**Zoom Scan (7x7x7)/Cube 0:** Measurement grid: dx=5mm, dy=5mm, dz=5mm

Input Power = 20.0 dBm (100 mW)

Peak SAR (extrapolated) = 10.4 W/kg

**SAR(1 g) = 4.99 W/kg; SAR(10 g) = 2.29 W/kg**

Deviation = -6.73%

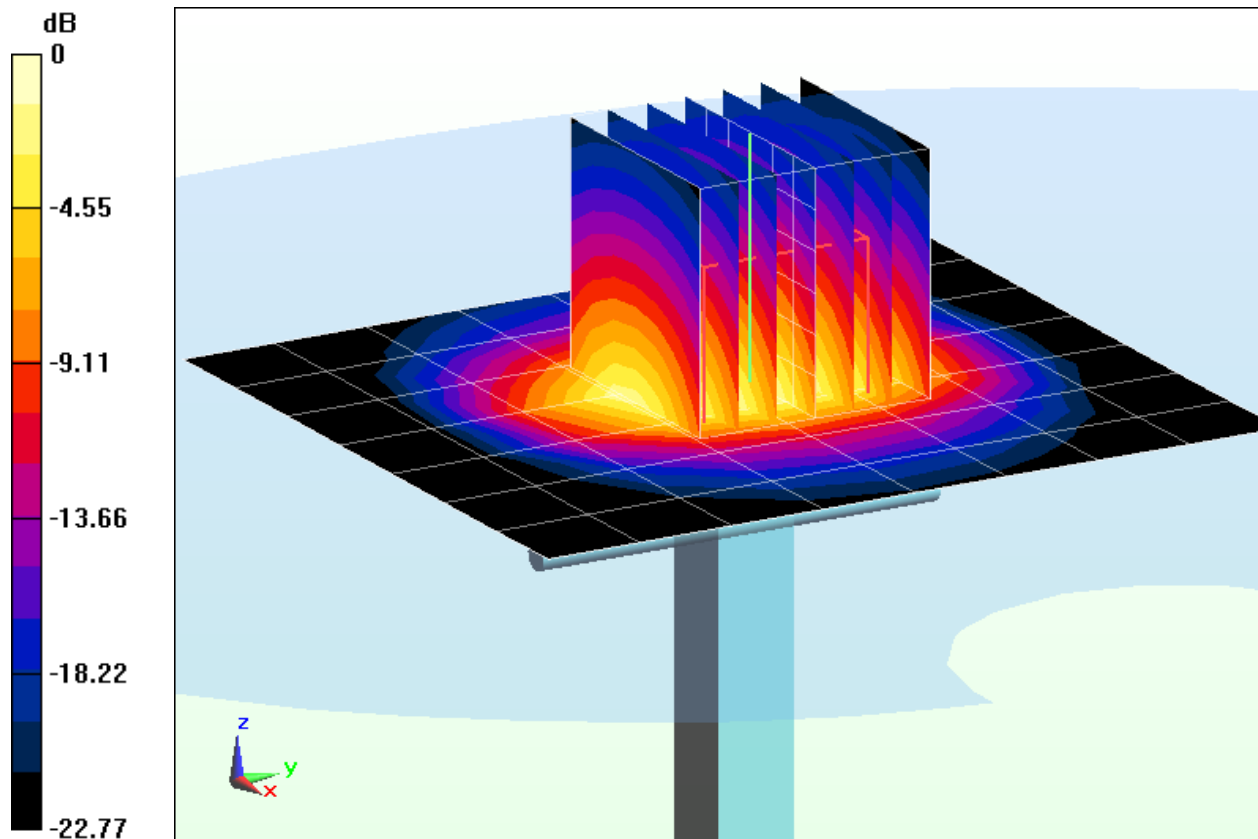

0 dB = 6.58 W/kg = 8.18 dBW/kg

# PCTEST ENGINEERING LABORATORY, INC.

**DUT: Dipole 2450 MHz; Type: D2450V2; Serial: 882**

Communication System: CW; Frequency: 2450 MHz; Duty Cycle: 1:1

Medium: 2450 Head; Medium parameters used:

$f = 2450 \text{ MHz}$ ;  $\sigma = 1.764 \text{ mho/m}$ ;  $\epsilon_r = 39.28$ ;  $\rho = 1000 \text{ kg/m}^3$

Phantom section: Flat Section; Space: 1.0 cm

Test Date: 11-15-2012; Ambient Temp: 23.3°C; Tissue Temp: 23.0°C

Probe: ES3DV3 - SN3263; ConvF(4.45, 4.45, 4.45); Calibrated: 5/18/2012;

Sensor-Surface: 3mm (Mechanical Surface Detection)

Electronics: DAE4 Sn1334; Calibrated: 5/7/2012

Phantom: SAM 5.0 front; Type: QD000P40CD; Serial: TP:-1648

Measurement SW: DASY52, Version 52.8 (3);SEMCAD X Version 14.6.7 (6848)

## 2450 MHz System Verification

**Area Scan (8x9x1):** Measurement grid: dx=12mm, dy=12mm

**Zoom Scan (7x7x7)/Cube 0:** Measurement grid: dx=5mm, dy=5mm, dz=5mm

Input Power = 20.0 dBm (100 mW)

Peak SAR (extrapolated) = 10.4 W/kg

**SAR(1 g) = 4.99 W/kg; SAR(10 g) = 2.29 W/kg**

Deviation = -6.73%

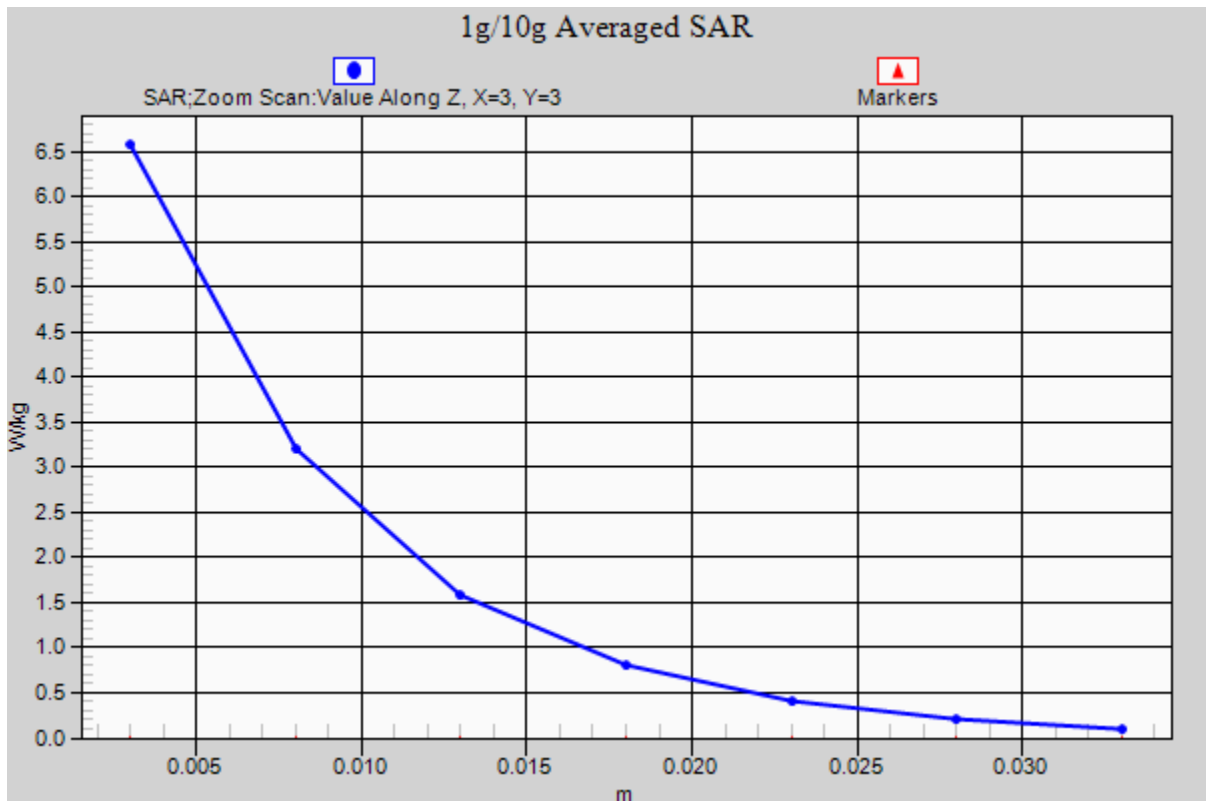

# PCTEST ENGINEERING LABORATORY, INC.

**DUT: Dipole 835 MHz; Type: D835V2; Serial: 4d026**

Communication System: CW; Frequency: 835 MHz; Duty Cycle: 1:1  
Medium: 835 Body; Medium parameters used:

$f = 835 \text{ MHz}$ ;  $\sigma = 0.986 \text{ mho/m}$ ;  $\epsilon_r = 55.48$ ;  $\rho = 1000 \text{ kg/m}^3$

Phantom section: Flat Section; Space: 1.5 cm

Test Date: 11-15-2012; Ambient Temp: 23.9°C; Tissue Temp: 22.9°C

Probe: ES3DV3 - SN3209; ConvF(6.13, 6.13, 6.13); Calibrated: 3/16/2012;

Sensor-Surface: 4mm (Mechanical Surface Detection)

Electronics: DAE4 Sn649; Calibrated: 2/20/2012

Phantom: SAM with CRP; Type: SAM; Serial: TP1375

Measurement SW: DASY4, Version 4.7 (80); SEMCAD X Version 14.6.7 (6848)

## 835MHz System Verification

**Area Scan (7x13x1):** Measurement grid:  $dx=15\text{mm}$ ,  $dy=15\text{mm}$

**Zoom Scan (5x5x7)/Cube 0:** Measurement grid:  $dx=8\text{mm}$ ,  $dy=8\text{mm}$ ,  $dz=5\text{mm}$

Input Power = 20.0 dBm (100 mW)

Peak SAR (extrapolated) = 1.37 W/kg

**SAR(1 g) = 0.984 W/kg; SAR(10 g) = 0.657 W/kg**

Deviation = 2.71%

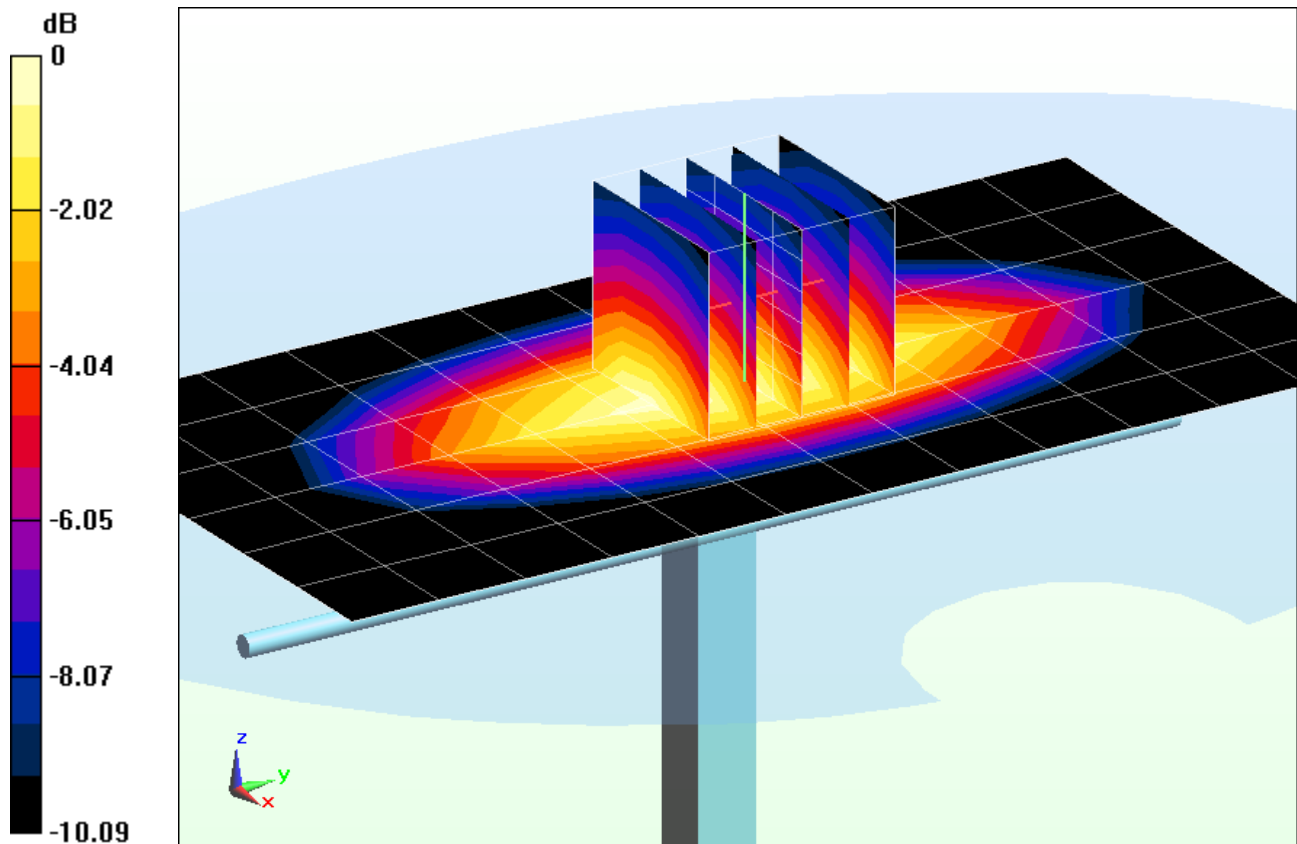

0 dB = 1.05 W/kg = 0.21 dBW/kg

# PCTEST ENGINEERING LABORATORY, INC.

**DUT: Dipole 835 MHz; Type: D835V2; Serial: 4d026**

Communication System: CW; Frequency: 835 MHz; Duty Cycle: 1:1

Medium: 835 Body; Medium parameters used:

$f = 835 \text{ MHz}$ ;  $\sigma = 0.986 \text{ mho/m}$ ;  $\epsilon_r = 55.48$ ;  $\rho = 1000 \text{ kg/m}^3$

Phantom section: Flat Section; Space: 1.5 cm

Test Date: 11-15-2012; Ambient Temp: 23.9°C; Tissue Temp: 22.9°C

Probe: ES3DV3 - SN3209; ConvF(6.13, 6.13, 6.13); Calibrated: 3/16/2012;

Sensor-Surface: 4mm (Mechanical Surface Detection)

Electronics: DAE4 Sn649; Calibrated: 2/20/2012

Phantom: SAM with CRP; Type: SAM; Serial: TP1375

Measurement SW: DASY4, Version 4.7 (80);SEMCAD X Version 14.6.7 (6848)

## 835MHz System Verification

**Area Scan (7x13x1):** Measurement grid: dx=15mm, dy=15mm

**Zoom Scan (5x5x7)/Cube 0:** Measurement grid: dx=8mm, dy=8mm, dz=5mm

Input Power = 20.0 dBm (100 mW)

Peak SAR (extrapolated) = 1.37 W/kg

**SAR(1 g) = 0.984 W/kg; SAR(10 g) = 0.657 W/kg**

Deviation = 2.71%

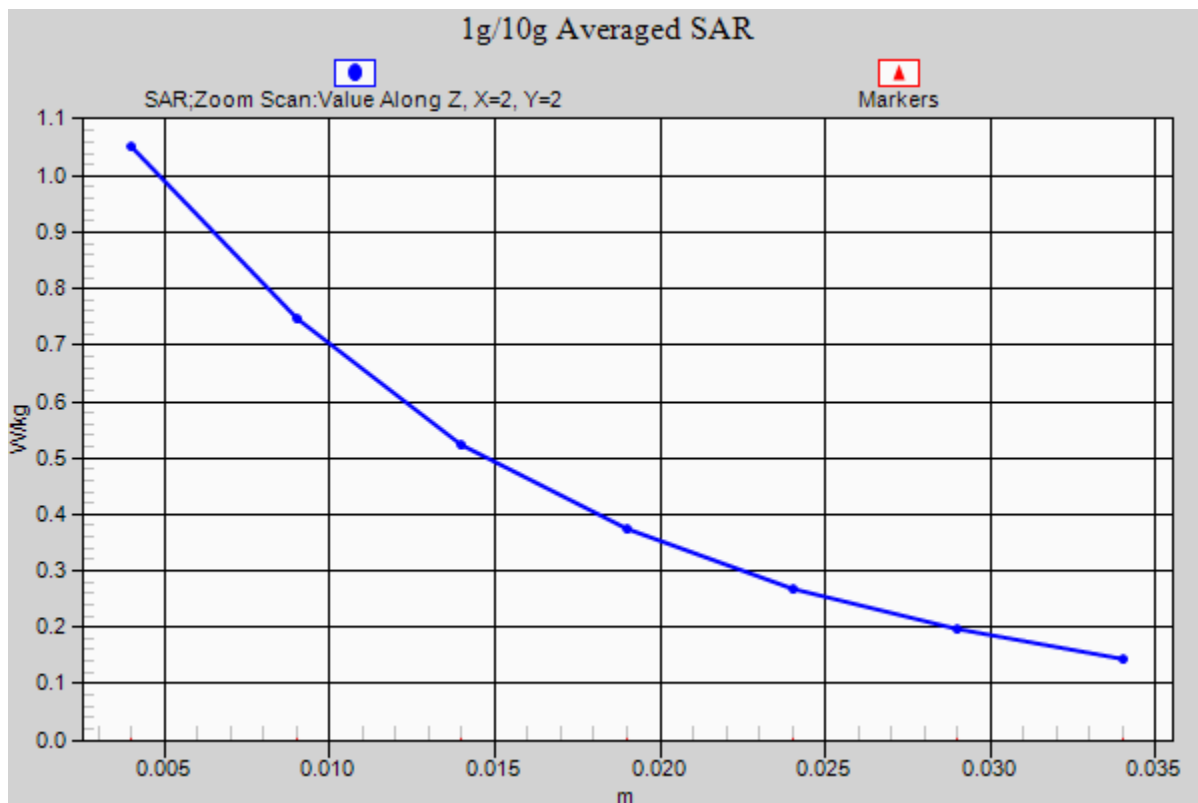

# PCTEST ENGINEERING LABORATORY, INC.

**DUT: SAR Dipole 1900 MHz; Type: D1900V2; Serial: 5d149**

Communication System: CW; Frequency: 1900 MHz; Duty Cycle: 1:1

Medium: 1900 Body; Medium parameters used (interpolated):

$f = 1900 \text{ MHz}$ ;  $\sigma = 1.578 \text{ mho/m}$ ;  $\epsilon_r = 50.777$ ;  $\rho = 1000 \text{ kg/m}^3$

Phantom section: Flat Section; Space: 1.0 cm

Test Date: 11-14-2012; Ambient Temp: 23.5°C; Tissue Temp: 22.1°C

Probe: ES3DV3 - SN3288; ConvF(4.89, 4.89, 4.89); Calibrated: 9/20/2012;

Sensor-Surface: 4mm (Mechanical Surface Detection)

Electronics: DAE4 Sn1323; Calibrated: 9/19/2012

Phantom: SAM v5.0 front; Type: QD000P40CD; Serial: TP-1646

Measurement SW: DASY52, Version 52.8 (3); SEMCAD X Version 14.6.7 (6848)

## 1900 MHz System Verification

**Area Scan (7x9x1):** Measurement grid: dx=15mm, dy=15mm

**Zoom Scan (5x5x7)/Cube 0:** Measurement grid: dx=8mm, dy=8mm, dz=5mm

Input Power = 20.0 dBm (100 mW)

Peak SAR (extrapolated) = 7.48 W/kg

**SAR(1 g) = 4.17 W/kg; SAR(10 g) = 2.17 W/kg**

Deviation = 6.11%

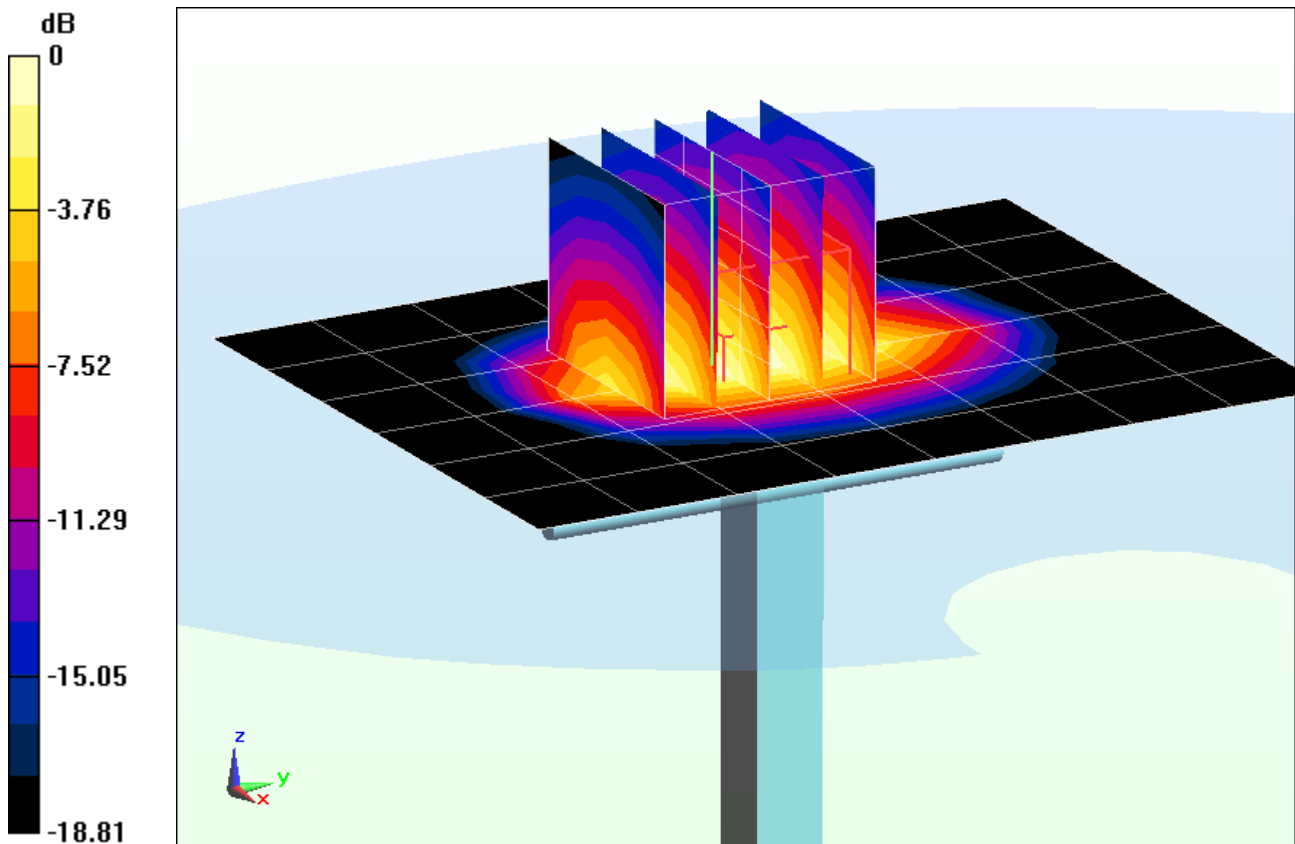

0 dB = 4.61 W/kg = 6.64 dBW/kg

# PCTEST ENGINEERING LABORATORY, INC.

**DUT: SAR Dipole 1900 MHz; Type: D1900V2; Serial: 5d149**

Communication System: CW; Frequency: 1900 MHz; Duty Cycle: 1:1

Medium: 1900 Body; Medium parameters used (interpolated):

$f = 1900 \text{ MHz}$ ;  $\sigma = 1.578 \text{ mho/m}$ ;  $\epsilon_r = 50.777$ ;  $\rho = 1000 \text{ kg/m}^3$

Phantom section: Flat Section; Space: 1.0 cm

Test Date: 11-14-2012; Ambient Temp: 23.5°C; Tissue Temp: 22.1°C

Probe: ES3DV3 - SN3288; ConvF(4.89, 4.89, 4.89); Calibrated: 9/20/2012;

Sensor-Surface: 4mm (Mechanical Surface Detection)

Electronics: DAE4 Sn1323; Calibrated: 9/19/2012

Phantom: SAM v5.0 front; Type: QD000P40CD; Serial: TP-1646

Measurement SW: DASY52, Version 52.8 (3); SEMCAD X Version 14.6.7 (6848)

## 1900 MHz System Verification

**Area Scan (7x9x1):** Measurement grid: dx=15mm, dy=15mm

**Zoom Scan (5x5x7)/Cube 0:** Measurement grid: dx=8mm, dy=8mm, dz=5mm

Input Power = 20.0 dBm (100 mW)

Peak SAR (extrapolated) = 7.48 W/kg

**SAR(1 g) = 4.17 W/kg; SAR(10 g) = 2.17 W/kg**

Deviation = 6.11%

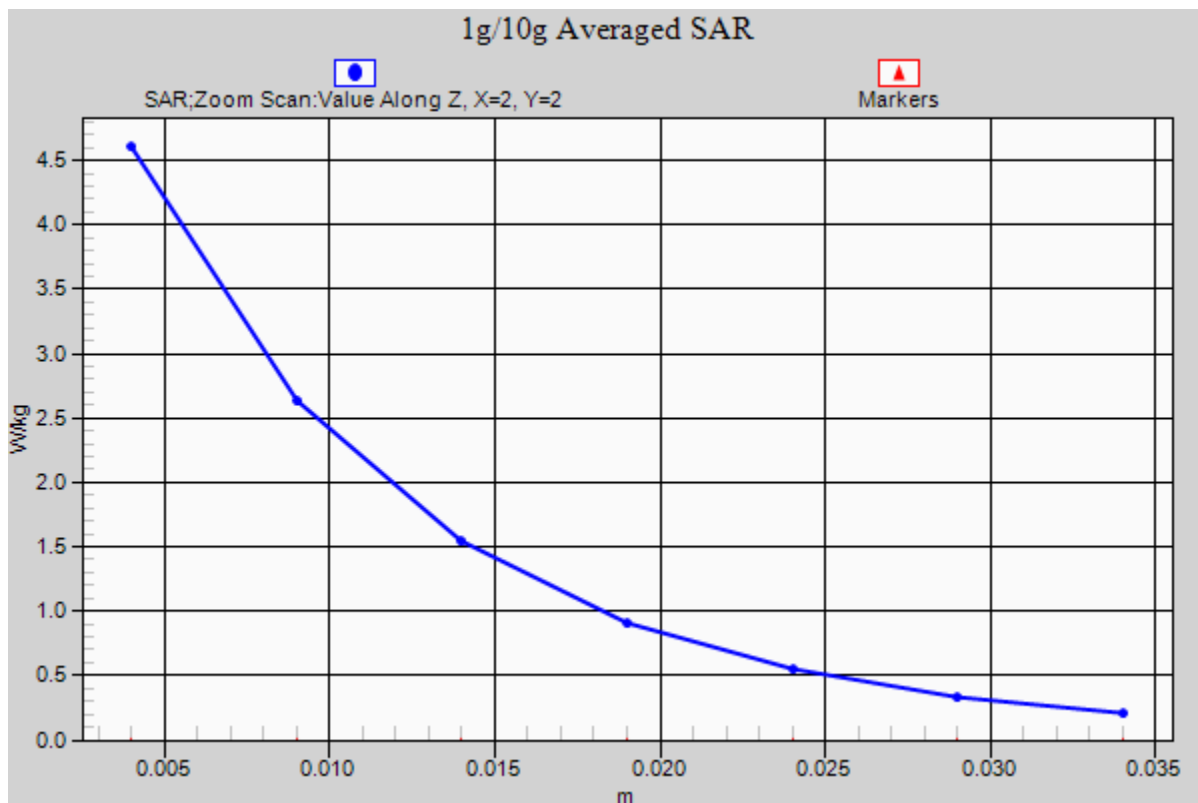

# PCTEST ENGINEERING LABORATORY, INC.

**DUT: SAR Dipole 2450 MHz; Type: D2450V2; Serial: 797**

Communication System: CW; Frequency: 2450 MHz; Duty Cycle: 1:1

Medium: 2450 Body; Medium parameters used:

$f = 2450 \text{ MHz}$ ;  $\sigma = 2.032 \text{ mho/m}$ ;  $\epsilon_r = 51.34$ ;  $\rho = 1000 \text{ kg/m}^3$

Phantom section: Flat Section; Space: 1.0 cm

Test Date: 11-15-2012; Ambient Temp: 23.3°C; Tissue Temp: 22.1°C

Probe: ES3DV3 - SN3258; ConvF(4.28, 4.28, 4.28); Calibrated: 2/21/2012;

Sensor-Surface: 3mm (Mechanical Surface Detection)

Electronics: DAE4 Sn1272; Calibrated: 1/18/2012

Phantom: SAM Main; Type: SAM 4.0; Serial: TP-1114

Measurement SW: DASY4, Version 4.7 (80); SEMCAD X Version 14.6.7 (6848)

## 2450MHz System Verification

**Area Scan (6x8x1):** Measurement grid:  $dx=12\text{mm}$ ,  $dy=12\text{mm}$

**Zoom Scan (7x7x7)/Cube 0:** Measurement grid:  $dx=5\text{mm}$ ,  $dy=5\text{mm}$ ,  $dz=5\text{mm}$

Input Power = 16.0 dBm (40 mW)

Peak SAR (extrapolated) = 4.43 W/kg

**SAR(1 g) = 2.07 W/kg; SAR(10 g) = 0.945 W/kg**

Deviation = 1.87%

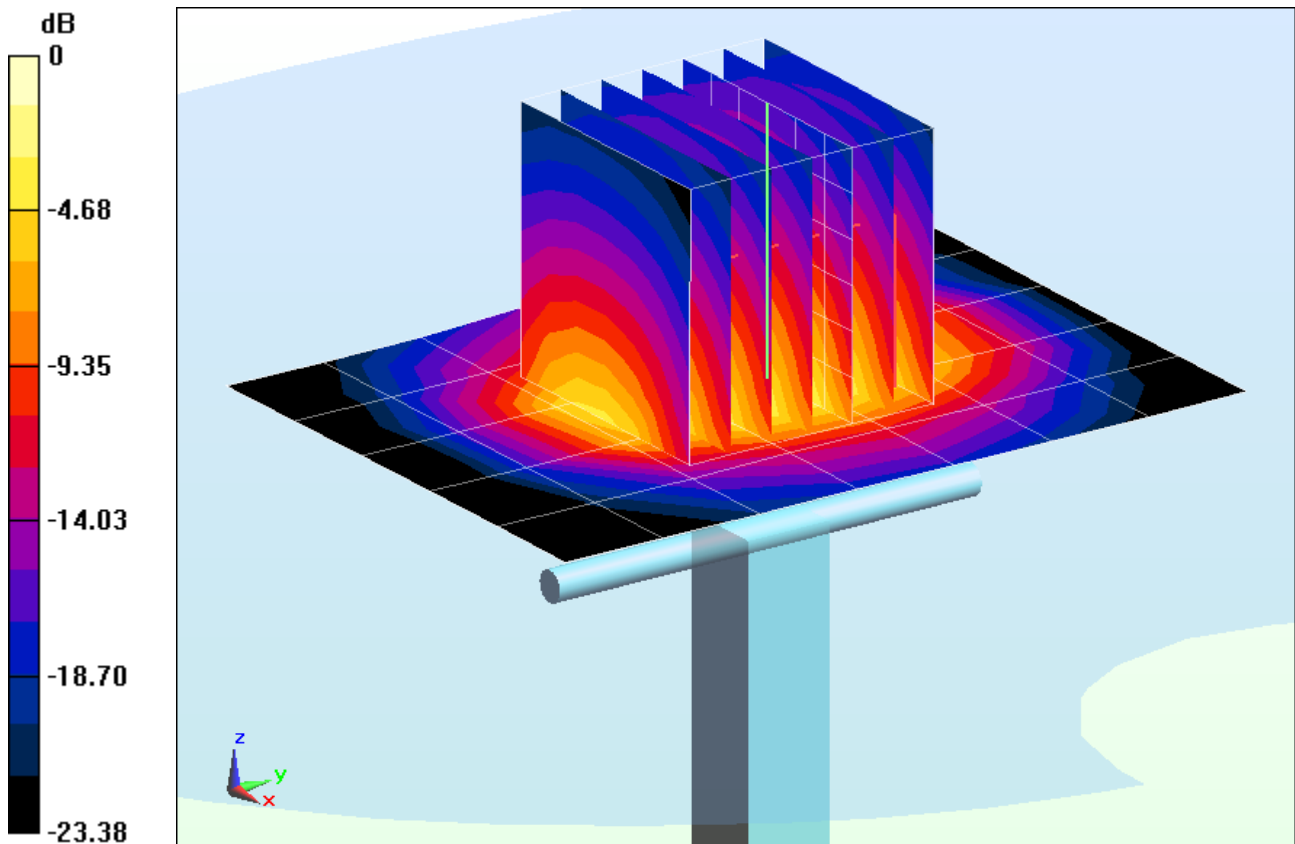

0 dB = 2.66 W/kg = 4.25 dBW/kg

# PCTEST ENGINEERING LABORATORY, INC.

**DUT: SAR Dipole 2450 MHz; Type: D2450V2; Serial: 797**

Communication System: CW; Frequency: 2450 MHz; Duty Cycle: 1:1

Medium: 2450 Body; Medium parameters used:

$f = 2450 \text{ MHz}$ ;  $\sigma = 2.032 \text{ mho/m}$ ;  $\epsilon_r = 51.34$ ;  $\rho = 1000 \text{ kg/m}^3$

Phantom section: Flat Section; Space: 1.0 cm

Test Date: 11-15-2012; Ambient Temp: 23.3°C; Tissue Temp: 22.1°C

Probe: ES3DV3 - SN3258; ConvF(4.28, 4.28, 4.28); Calibrated: 2/21/2012;

Sensor-Surface: 3mm (Mechanical Surface Detection)

Electronics: DAE4 Sn1272; Calibrated: 1/18/2012

Phantom: SAM Main; Type: SAM 4.0; Serial: TP-1114

Measurement SW: DASY4, Version 4.7 (80); SEMCAD X Version 14.6.7 (6848)

## 2450MHz System Verification

**Area Scan (6x8x1):** Measurement grid: dx=12mm, dy=12mm

**Zoom Scan (7x7x7)/Cube 0:** Measurement grid: dx=5mm, dy=5mm, dz=5mm

Input Power = 16.0 dBm (40 mW)

Peak SAR (extrapolated) = 4.43 W/kg

**SAR(1 g) = 2.07 W/kg; SAR(10 g) = 0.945 W/kg**

Deviation = 1.87%

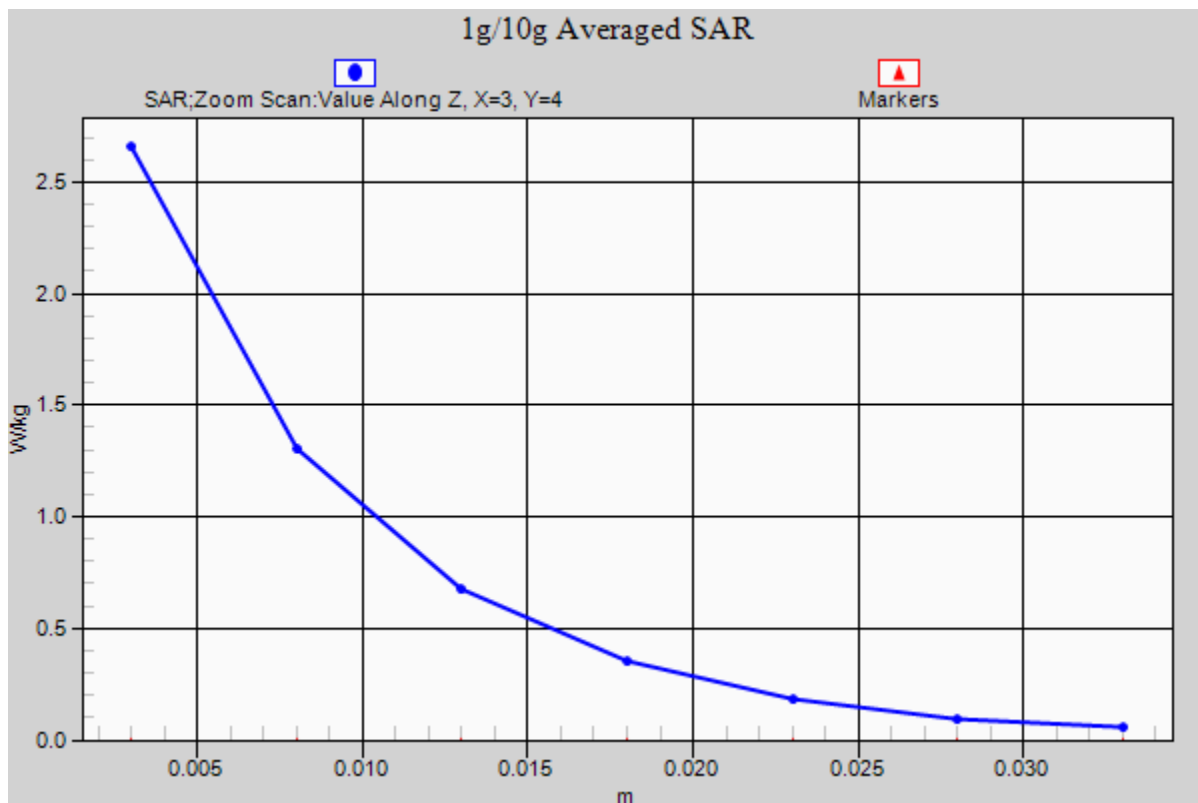

## APPENDIX C: PROBE CALIBRATION



Accredited by the Swiss Accreditation Service (SAS)  
The Swiss Accreditation Service is one of the signatories to the EA  
Multilateral Agreement for the recognition of calibration certificates

Accreditation No.: **SCS 108**

Client **PC Test**

Certificate No: **ES3-3213\_Apr12**

**CALIBRATION CERTIFICATE**

Object **ES3DV3 - SN:3213**

Calibration procedure(s) **QA CAL-01.v8, QA CAL-23.v4, QA CAL-25.v4  
Calibration procedure for dosimetric E-field probes**

Calibration date: **April 24, 2012**

This calibration certificate documents the traceability to national standards, which realize the physical units of measurements (SI).  
The measurements and the uncertainties with confidence probability are given on the following pages and are part of the certificate.

All calibrations have been conducted in the closed laboratory facility: environment temperature (22 ± 3)°C and humidity < 70%.

Calibration Equipment used (M&TE critical for calibration)

*✓ Kok 5/2/12*

Primary Standards	ID	Cal Date (Certificate No.)	Scheduled Calibration
Power meter E4419B	GB41293874	29-Mar-12 (No. 217-01508)	Apr-13
Power sensor E4412A	MY41498087	29-Mar-12 (No. 217-01508)	Apr-13
Reference 3 dB Attenuator	SN: S5054 (3c)	27-Mar-12 (No. 217-01531)	Apr-13
Reference 20 dB Attenuator	SN: S5086 (20b)	27-Mar-12 (No. 217-01529)	Apr-13
Reference 30 dB Attenuator	SN: S5129 (30b)	27-Mar-12 (No. 217-01532)	Apr-13
Reference Probe ES3DV2	SN: 3013	29-Dec-11 (No. ES3-3013_Dec11)	Dec-12
DAE4	SN: 660	10-Jan-12 (No. DAE4-660_Jan12)	Jan-13
Secondary Standards	ID	Check Date (in house)	Scheduled Check
RF generator HP 8648C	US3642U01700	4-Aug-99 (in house check Apr-11)	in house check: Apr-13
Network Analyzer HP 8753E	US37390585	18-Oct-01 (in house check Oct-11)	in house check: Oct-12

Calibrated by:	Name <b>Dimce Iliev</b>	Function <b>Laboratory Technician</b>	Signature <i>Dimce Iliev</i>
Approved by:	Name <b>Katja Pokovic</b>	Function <b>Technical Manager</b>	Signature <i>Katja Pokovic</i>
			Issued: April 25, 2012

This calibration certificate shall not be reproduced except in full without written approval of the laboratory.



Accredited by the Swiss Accreditation Service (SAS)

Accreditation No.: SCS 108

The Swiss Accreditation Service is one of the signatories to the EA  
Multilateral Agreement for the recognition of calibration certificates

### Glossary:

TSL	tissue simulating liquid
NORM <sub>x,y,z</sub>	sensitivity in free space
ConvF	sensitivity in TSL / NORM <sub>x,y,z</sub>
DCP	diode compression point
CF	crest factor (1/duty_cycle) of the RF signal
A, B, C	modulation dependent linearization parameters
Polarization $\varphi$	$\varphi$ rotation around probe axis
Polarization $\vartheta$	$\vartheta$ rotation around an axis that is in the plane normal to probe axis (at measurement center), i.e., $\vartheta = 0$ is normal to probe axis

### Calibration is Performed According to the Following Standards:

- IEEE Std 1528-2003, "IEEE Recommended Practice for Determining the Peak Spatial-Averaged Specific Absorption Rate (SAR) in the Human Head from Wireless Communications Devices: Measurement Techniques", December 2003
- IEC 62209-1, "Procedure to measure the Specific Absorption Rate (SAR) for hand-held devices used in close proximity to the ear (frequency range of 300 MHz to 3 GHz)", February 2005

### Methods Applied and Interpretation of Parameters:

- NORM<sub>x,y,z</sub>**: Assessed for E-field polarization  $\vartheta = 0$  ( $f \leq 900$  MHz in TEM-cell;  $f > 1800$  MHz: R22 waveguide). NORM<sub>x,y,z</sub> are only intermediate values, i.e., the uncertainties of NORM<sub>x,y,z</sub> does not affect the E<sup>2</sup>-field uncertainty inside TSL (see below ConvF).
- NORM(f)<sub>x,y,z</sub>** = NORM<sub>x,y,z</sub> \* frequency\_response (see Frequency Response Chart). This linearization is implemented in DASY4 software versions later than 4.2. The uncertainty of the frequency response is included in the stated uncertainty of ConvF.
- DCP<sub>x,y,z</sub>**: DCP are numerical linearization parameters assessed based on the data of power sweep with CW signal (no uncertainty required). DCP does not depend on frequency nor media.
- PAR**: PAR is the Peak to Average Ratio that is not calibrated but determined based on the signal characteristics
- A<sub>x,y,z</sub>; B<sub>x,y,z</sub>; C<sub>x,y,z</sub>; VR<sub>x,y,z</sub>; A, B, C** are numerical linearization parameters assessed based on the data of power sweep for specific modulation signal. The parameters do not depend on frequency nor media. VR is the maximum calibration range expressed in RMS voltage across the diode.
- ConvF and Boundary Effect Parameters**: Assessed in flat phantom using E-field (or Temperature Transfer Standard for  $f \leq 800$  MHz) and inside waveguide using analytical field distributions based on power measurements for  $f > 800$  MHz. The same setups are used for assessment of the parameters applied for boundary compensation (alpha, depth) of which typical uncertainty values are given. These parameters are used in DASY4 software to improve probe accuracy close to the boundary. The sensitivity in TSL corresponds to NORM<sub>x,y,z</sub> \* ConvF whereby the uncertainty corresponds to that given for ConvF. A frequency dependent ConvF is used in DASY version 4.4 and higher which allows extending the validity from  $\pm 50$  MHz to  $\pm 100$  MHz.
- Spherical isotropy (3D deviation from isotropy)**: in a field of low gradients realized using a flat phantom exposed by a patch antenna.
- Sensor Offset**: The sensor offset corresponds to the offset of virtual measurement center from the probe tip (on probe axis). No tolerance required.

# Probe ES3DV3

## SN:3213

Manufactured: October 14, 2008  
Calibrated: April 24, 2012

Calibrated for DASY/EASY Systems  
(Note: non-compatible with DASY2 system!)

# DASY/EASY - Parameters of Probe: ES3DV3 - SN:3213

## Basic Calibration Parameters

	Sensor X	Sensor Y	Sensor Z	Unc (k=2)
Norm ( $\mu\text{V}/(\text{V}/\text{m})^2$ ) <sup>A</sup>	1.48	1.36	1.33	± 10.1 %
DCP (mV) <sup>B</sup>	97.8	101.0	99.1	

## Modulation Calibration Parameters

UID	Communication System Name	PAR		A dB	B dB	C dB	VR mV	Unc <sup>E</sup> (k=2)
0	CW	0.00	X	0.00	0.00	1.00	125.2	±2.5 %
			Y	0.00	0.00	1.00	127.5	
			Z	0.00	0.00	1.00	169.0	

The reported uncertainty of measurement is stated as the standard uncertainty of measurement multiplied by the coverage factor k=2, which for a normal distribution corresponds to a coverage probability of approximately 95%.

<sup>A</sup> The uncertainties of NormX,Y,Z do not affect the E<sup>2</sup>-field uncertainty inside TSL (see Pages 5 and 6).

<sup>B</sup> Numerical linearization parameter: uncertainty not required.

<sup>E</sup> Uncertainty is determined using the max. deviation from linear response applying rectangular distribution and is expressed for the square of the field value.

## DASY/EASY - Parameters of Probe: ES3DV3 - SN:3213

### Calibration Parameter Determined in Head Tissue Simulating Media

f (MHz) <sup>C</sup>	Relative Permittivity <sup>F</sup>	Conductivity (S/m) <sup>F</sup>	ConvF X	ConvF Y	ConvF Z	Alpha	Depth (mm)	Unct. (k=2)
750	41.9	0.89	6.32	6.32	6.32	0.50	1.38	± 12.0 %
835	41.5	0.90	6.07	6.07	6.07	0.41	1.57	± 12.0 %
1640	40.3	1.29	5.36	5.36	5.36	0.64	1.24	± 12.0 %
1750	40.1	1.37	5.22	5.22	5.22	0.57	1.39	± 12.0 %
1900	40.0	1.40	5.02	5.02	5.02	0.63	1.32	± 12.0 %
2450	39.2	1.80	4.43	4.43	4.43	0.80	1.22	± 12.0 %
2600	39.0	1.96	4.26	4.26	4.26	0.72	1.36	± 12.0 %

<sup>C</sup> Frequency validity of ± 100 MHz only applies for DASY v4.4 and higher (see Page 2), else it is restricted to ± 50 MHz. The uncertainty is the RSS of the ConvF uncertainty at calibration frequency and the uncertainty for the indicated frequency band.

<sup>F</sup> At frequencies below 3 GHz, the validity of tissue parameters ( $\epsilon$  and  $\sigma$ ) can be relaxed to ± 10% if liquid compensation formula is applied to measured SAR values. At frequencies above 3 GHz, the validity of tissue parameters ( $\epsilon$  and  $\sigma$ ) is restricted to ± 5%. The uncertainty is the RSS of the ConvF uncertainty for indicated target tissue parameters.

## DASY/EASY - Parameters of Probe: ES3DV3 - SN:3213

### Calibration Parameter Determined in Body Tissue Simulating Media

f (MHz) <sup>C</sup>	Relative Permittivity <sup>F</sup>	Conductivity (S/m) <sup>F</sup>	ConvF X	ConvF Y	ConvF Z	Alpha	Depth (mm)	Unct. (k=2)
750	55.5	0.96	6.19	6.19	6.19	0.31	1.96	± 12.0 %
835	55.2	0.97	6.07	6.07	6.07	0.38	1.73	± 12.0 %
1640	53.8	1.40	5.13	5.13	5.13	0.35	2.07	± 12.0 %
1750	53.4	1.49	4.68	4.68	4.68	0.54	1.56	± 12.0 %
1900	53.3	1.52	4.50	4.50	4.50	0.69	1.37	± 12.0 %
2450	52.7	1.95	4.11	4.11	4.11	0.80	1.04	± 12.0 %
2600	52.5	2.16	3.91	3.91	3.91	0.63	0.92	± 12.0 %

<sup>C</sup> Frequency validity of ± 100 MHz only applies for DASY v4.4 and higher (see Page 2), else it is restricted to ± 50 MHz. The uncertainty is the RSS of the ConvF uncertainty at calibration frequency and the uncertainty for the indicated frequency band.

<sup>F</sup> At frequencies below 3 GHz, the validity of tissue parameters ( $\epsilon$  and  $\sigma$ ) can be relaxed to ± 10% if liquid compensation formula is applied to measured SAR values. At frequencies above 3 GHz, the validity of tissue parameters ( $\epsilon$  and  $\sigma$ ) is restricted to ± 5%. The uncertainty is the RSS of the ConvF uncertainty for indicated target tissue parameters.

# Frequency Response of E-Field

(TEM-Cell:ifi110 EXX, Waveguide: R22)

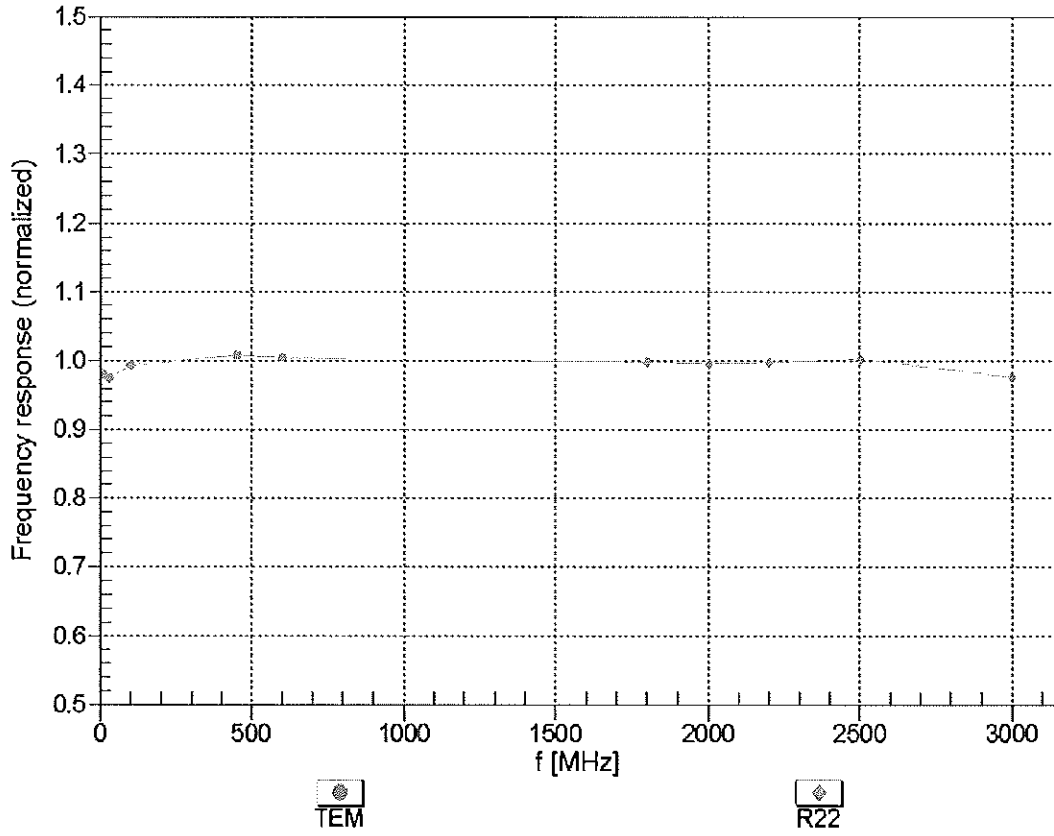

Uncertainty of Frequency Response of E-field:  $\pm 6.3\%$  (k=2)

### Receiving Pattern ( $\phi$ ), $\theta = 0^\circ$

f=600 MHz,TEM

f=1800 MHz,R22

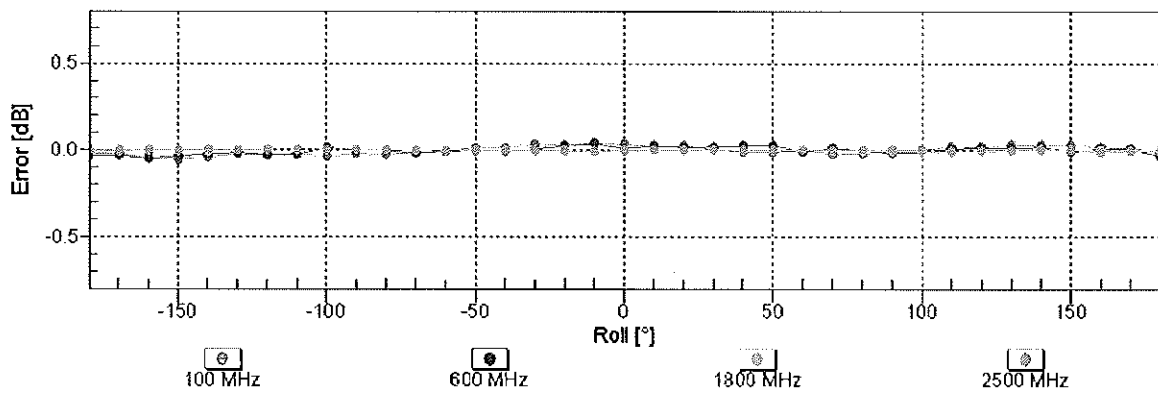
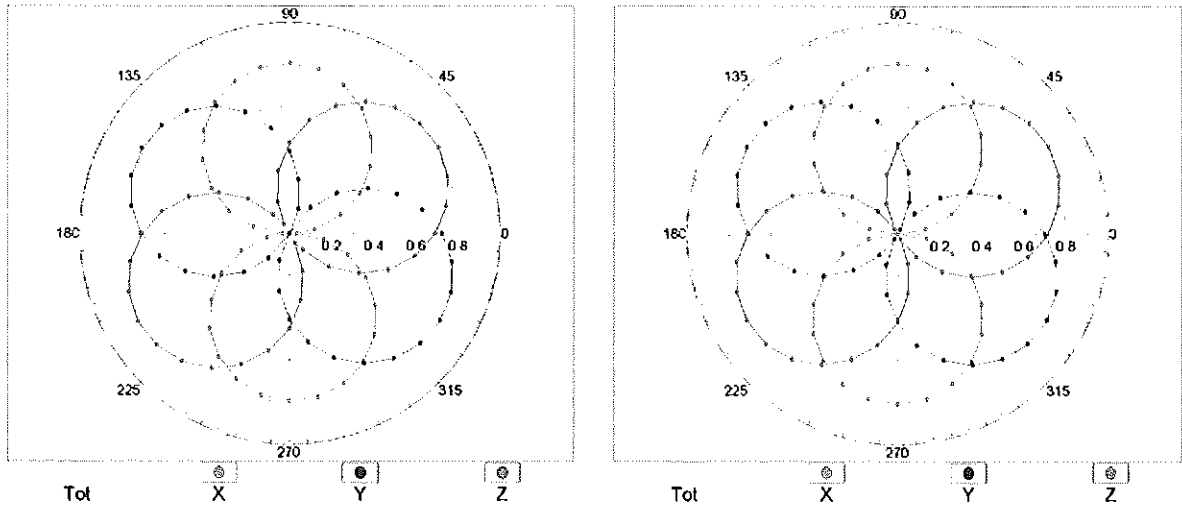

Uncertainty of Axial Isotropy Assessment:  $\pm 0.5\%$  (k=2)

### Dynamic Range $f(SAR_{head})$ (TEM cell , $f = 900$ MHz)

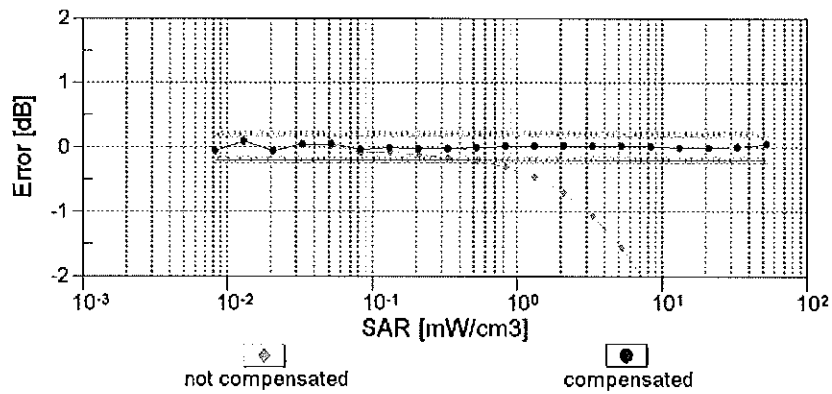
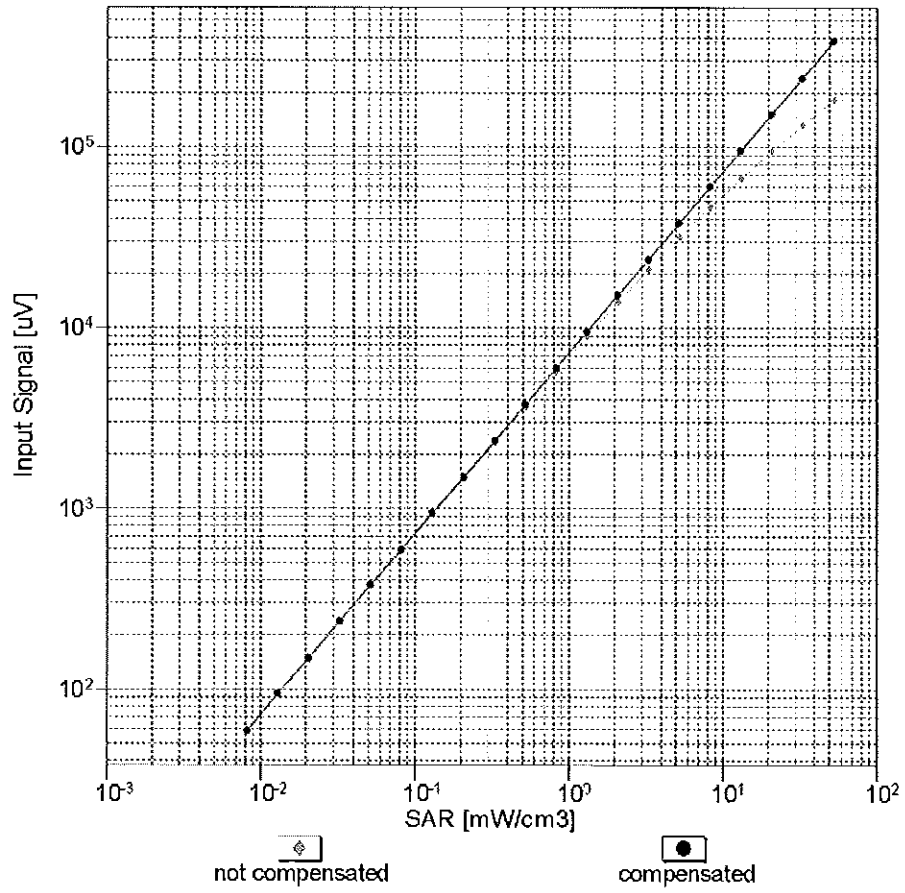

Uncertainty of Linearity Assessment:  $\pm 0.6\%$  ( $k=2$ )

# Conversion Factor Assessment

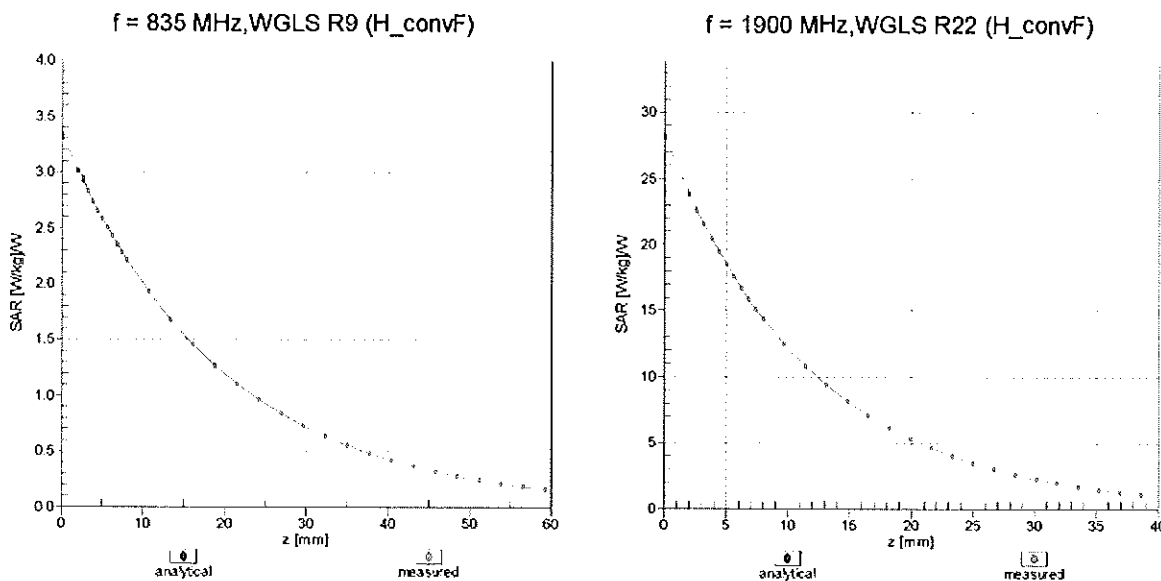

## Deviation from Isotropy in Liquid

Error ( $\phi, \theta$ ), f = 900 MHz

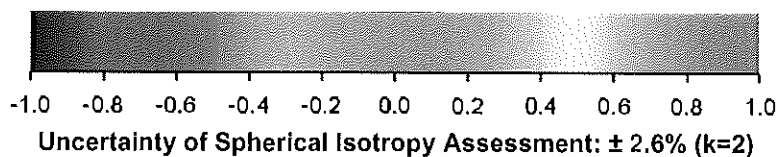
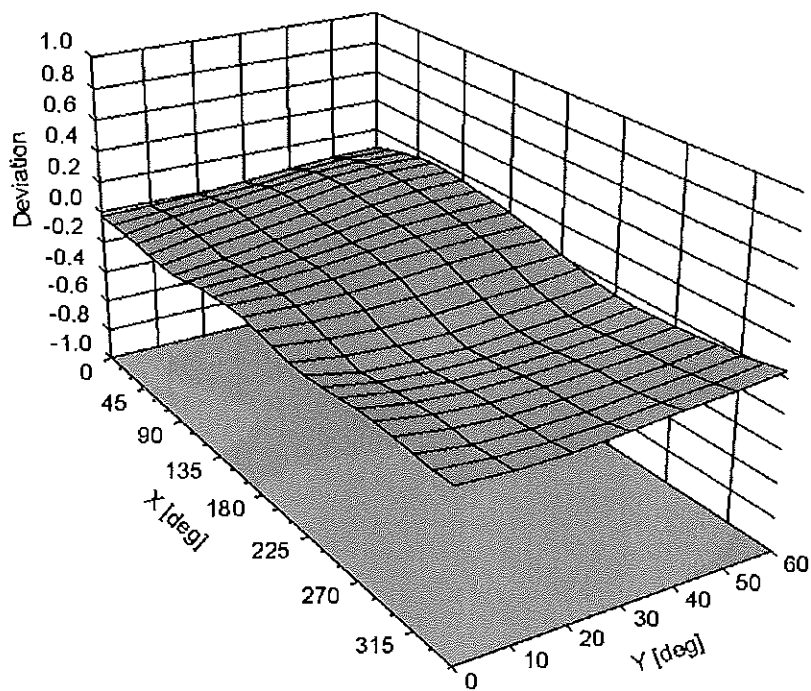

**DASY/EASY - Parameters of Probe: ES3DV3 - SN:3213****Other Probe Parameters**

Sensor Arrangement	Triangular
Connector Angle (°)	140.1
Mechanical Surface Detection Mode	enabled
Optical Surface Detection Mode	disabled
Probe Overall Length	337 mm
Probe Body Diameter	10 mm
Tip Length	10 mm
Tip Diameter	4 mm
Probe Tip to Sensor X Calibration Point	2 mm
Probe Tip to Sensor Y Calibration Point	2 mm
Probe Tip to Sensor Z Calibration Point	2 mm
Recommended Measurement Distance from Surface	3 mm

**Calibration Laboratory of  
Schmid & Partner  
Engineering AG**  
Zeughausstrasse 43, 8004 Zurich, Switzerland



**S** Schweizerischer Kalibrierdienst  
**S** Service suisse d'étalonnage  
**S** Servizio svizzero di taratura  
**S** Swiss Calibration Service

Accredited by the Swiss Accreditation Service (SAS)  
The Swiss Accreditation Service is one of the signatories to the EA  
Multilateral Agreement for the recognition of calibration certificates

Accreditation No.: **SCS 108**

Client **PC Test**

Certificate No: **ES3-3288\_Sep12**

## CALIBRATION CERTIFICATE

Object **ES3DV3 - SN:3288**

Calibration procedure(s) **QA CAL-01.v8, QA CAL-23.v4, QA CAL-25.v4  
Calibration procedure for dosimetric E-field probes**

Calibration date: **September 20, 2012**

This calibration certificate documents the traceability to national standards, which realize the physical units of measurements (SI).  
The measurements and the uncertainties with confidence probability are given on the following pages and are part of the certificate.

All calibrations have been conducted in the closed laboratory facility: environment temperature ( $22 \pm 3$ )°C and humidity < 70%.

Calibration Equipment used (M&TE critical for calibration)

Primary Standards	ID	Cal Date (Certificate No.)	Scheduled Calibration
Power meter E4419B	GB41293874	29-Mar-12 (No. 217-01508)	Apr-13
Power sensor E4412A	MY41498087	29-Mar-12 (No. 217-01508)	Apr-13
Reference 3 dB Attenuator	SN: S5054 (3c)	27-Mar-12 (No. 217-01531)	Apr-13
Reference 20 dB Attenuator	SN: S5086 (20b)	27-Mar-12 (No. 217-01529)	Apr-13
Reference 30 dB Attenuator	SN: S5129 (30b)	27-Mar-12 (No. 217-01532)	Apr-13
Reference Probe ES3DV2	SN: 3013	29-Dec-11 (No. ES3-3013_Dec11)	Dec-12
DAE4	SN: 660	20-Jun-12 (No. DAE4-660_Jun12)	Jun-13
Secondary Standards	ID	Check Date (in house)	Scheduled Check
RF generator HP 8648C	US3642U01700	4-Aug-99 (in house check Apr-11)	In house check: Apr-13
Network Analyzer HP 8753E	US37390585	18-Oct-01 (in house check Oct-11)	In house check: Oct-12

Calibrated by:	Name <b>Jeton Kastrati</b>	Function <b>Laboratory Technician</b>	Signature 
Approved by:	Name <b>Katja Pokovic</b>	Technical Manager	

Issued: September 20, 2012

This calibration certificate shall not be reproduced except in full without written approval of the laboratory.

*KOK  
10/2/12*



Accredited by the Swiss Accreditation Service (SAS)

Accreditation No.: **SCS 108**

The Swiss Accreditation Service is one of the signatories to the EA  
Multilateral Agreement for the recognition of calibration certificates

### Glossary:

TSL	tissue simulating liquid
NORM <sub>x,y,z</sub>	sensitivity in free space
ConvF	sensitivity in TSL / NORM <sub>x,y,z</sub>
DCP	diode compression point
CF	crest factor (1/duty_cycle) of the RF signal
A, B, C	modulation dependent linearization parameters
Polarization $\phi$	$\phi$ rotation around probe axis
Polarization $\vartheta$	$\vartheta$ rotation around an axis that is in the plane normal to probe axis (at measurement center), i.e., $\vartheta = 0$ is normal to probe axis

### Calibration is Performed According to the Following Standards:

- IEEE Std 1528-2003, "IEEE Recommended Practice for Determining the Peak Spatial-Averaged Specific Absorption Rate (SAR) in the Human Head from Wireless Communications Devices: Measurement Techniques", December 2003
- IEC 62209-1, "Procedure to measure the Specific Absorption Rate (SAR) for hand-held devices used in close proximity to the ear (frequency range of 300 MHz to 3 GHz)", February 2005

### Methods Applied and Interpretation of Parameters:

- NORM<sub>x,y,z</sub>**: Assessed for E-field polarization  $\vartheta = 0$  ( $f \leq 900$  MHz in TEM-cell;  $f > 1800$  MHz: R22 waveguide). NORM<sub>x,y,z</sub> are only intermediate values, i.e., the uncertainties of NORM<sub>x,y,z</sub> does not affect the E<sup>2</sup>-field uncertainty inside TSL (see below ConvF).
- NORM(f)<sub>x,y,z</sub>** = NORM<sub>x,y,z</sub> \* frequency\_response (see Frequency Response Chart). This linearization is implemented in DASY4 software versions later than 4.2. The uncertainty of the frequency response is included in the stated uncertainty of ConvF.
- DCP<sub>x,y,z</sub>**: DCP are numerical linearization parameters assessed based on the data of power sweep with CW signal (no uncertainty required). DCP does not depend on frequency nor media.
- PAR**: PAR is the Peak to Average Ratio that is not calibrated but determined based on the signal characteristics
- A<sub>x,y,z</sub>; B<sub>x,y,z</sub>; C<sub>x,y,z</sub>; VR<sub>x,y,z</sub>; A, B, C** are numerical linearization parameters assessed based on the data of power sweep for specific modulation signal. The parameters do not depend on frequency nor media. VR is the maximum calibration range expressed in RMS voltage across the diode.
- ConvF and Boundary Effect Parameters**: Assessed in flat phantom using E-field (or Temperature Transfer Standard for  $f \leq 800$  MHz) and inside waveguide using analytical field distributions based on power measurements for  $f > 800$  MHz. The same setups are used for assessment of the parameters applied for boundary compensation (alpha, depth) of which typical uncertainty values are given. These parameters are used in DASY4 software to improve probe accuracy close to the boundary. The sensitivity in TSL corresponds to NORM<sub>x,y,z</sub> \* ConvF whereby the uncertainty corresponds to that given for ConvF. A frequency dependent ConvF is used in DASY version 4.4 and higher which allows extending the validity from  $\pm 50$  MHz to  $\pm 100$  MHz.
- Spherical isotropy (3D deviation from isotropy)**: in a field of low gradients realized using a flat phantom exposed by a patch antenna.
- Sensor Offset**: The sensor offset corresponds to the offset of virtual measurement center from the probe tip (on probe axis). No tolerance required.

# Probe ES3DV3

## SN:3288

Manufactured: July 6, 2010  
Calibrated: September 20, 2012

Calibrated for DASY/EASY Systems  
(Note: non-compatible with DASY2 system!)

## DASY/EASY - Parameters of Probe: ES3DV3 - SN:3288

### Basic Calibration Parameters

	Sensor X	Sensor Y	Sensor Z	Unc (k=2)
Norm ( $\mu\text{V}/(\text{V}/\text{m})^2$ ) <sup>A</sup>	0.87	0.97	0.75	$\pm 10.1 \%$
DCP (mV) <sup>B</sup>	101.3	102.4	103.9	

### Modulation Calibration Parameters

UID	Communication System Name	PAR		A dB	B dB	C dB	VR mV	Unc <sup>E</sup> (k=2)
0	CW	0.00	X	0.00	0.00	1.00	168.6	$\pm 3.3 \%$
			Y	0.00	0.00	1.00	132.2	
			Z	0.00	0.00	1.00	156.8	

The reported uncertainty of measurement is stated as the standard uncertainty of measurement multiplied by the coverage factor  $k=2$ , which for a normal distribution corresponds to a coverage probability of approximately 95%.

<sup>A</sup> The uncertainties of NormX,Y,Z do not affect the  $E^2$ -field uncertainty inside TSL (see Pages 5 and 6).

<sup>B</sup> Numerical linearization parameter: uncertainty not required.

<sup>E</sup> Uncertainty is determined using the max. deviation from linear response applying rectangular distribution and is expressed for the square of the field value.

## DASY/EASY - Parameters of Probe: ES3DV3 - SN:3288

### Calibration Parameter Determined in Head Tissue Simulating Media

f (MHz) <sup>c</sup>	Relative Permittivity <sup>F</sup>	Conductivity (S/m) <sup>F</sup>	ConvF X	ConvF Y	ConvF Z	Alpha	Depth (mm)	Unct. (k=2)
750	41.9	0.89	6.67	6.67	6.67	0.80	1.14	± 12.0 %
835	41.5	0.90	6.41	6.41	6.41	0.76	1.18	± 12.0 %
1750	40.1	1.37	5.51	5.51	5.51	0.70	1.28	± 12.0 %
1900	40.0	1.40	5.28	5.28	5.28	0.80	1.22	± 12.0 %
2450	39.2	1.80	4.61	4.61	4.61	0.80	1.26	± 12.0 %
2600	39.0	1.96	4.45	4.45	4.45	0.80	1.31	± 12.0 %

<sup>c</sup> Frequency validity of ± 100 MHz only applies for DASY v4.4 and higher (see Page 2), else it is restricted to ± 50 MHz. The uncertainty is the RSS of the ConvF uncertainty at calibration frequency and the uncertainty for the indicated frequency band.

<sup>F</sup> At frequencies below 3 GHz, the validity of tissue parameters ( $\epsilon$  and  $\sigma$ ) can be relaxed to ± 10% if liquid compensation formula is applied to measured SAR values. At frequencies above 3 GHz, the validity of tissue parameters ( $\epsilon$  and  $\sigma$ ) is restricted to ± 5%. The uncertainty is the RSS of the ConvF uncertainty for indicated target tissue parameters.

## DASY/EASY - Parameters of Probe: ES3DV3 - SN:3288

### Calibration Parameter Determined in Body Tissue Simulating Media

f (MHz) <sup>C</sup>	Relative Permittivity <sup>F</sup>	Conductivity (S/m) <sup>F</sup>	ConvF X	ConvF Y	ConvF Z	Alpha	Depth (mm)	Unct. (k=2)
750	55.5	0.96	6.44	6.44	6.44	0.62	1.31	± 12.0 %
835	55.2	0.97	6.31	6.31	6.31	0.38	1.78	± 12.0 %
1750	53.4	1.49	5.18	5.18	5.18	0.64	1.43	± 12.0 %
1900	53.3	1.52	4.89	4.89	4.89	0.50	1.64	± 12.0 %
2450	52.7	1.95	4.35	4.35	4.35	0.74	1.23	± 12.0 %
2600	52.5	2.16	4.09	4.09	4.09	0.80	1.07	± 12.0 %

<sup>C</sup> Frequency validity of ± 100 MHz only applies for DASY v4.4 and higher (see Page 2), else it is restricted to ± 50 MHz. The uncertainty is the RSS of the ConvF uncertainty at calibration frequency and the uncertainty for the indicated frequency band.

<sup>F</sup> At frequencies below 3 GHz, the validity of tissue parameters ( $\epsilon$  and  $\sigma$ ) can be relaxed to ± 10% if liquid compensation formula is applied to measured SAR values. At frequencies above 3 GHz, the validity of tissue parameters ( $\epsilon$  and  $\sigma$ ) is restricted to ± 5%. The uncertainty is the RSS of the ConvF uncertainty for indicated target tissue parameters.

### Frequency Response of E-Field (TEM-Cell:ifi110 EXX, Waveguide: R22)

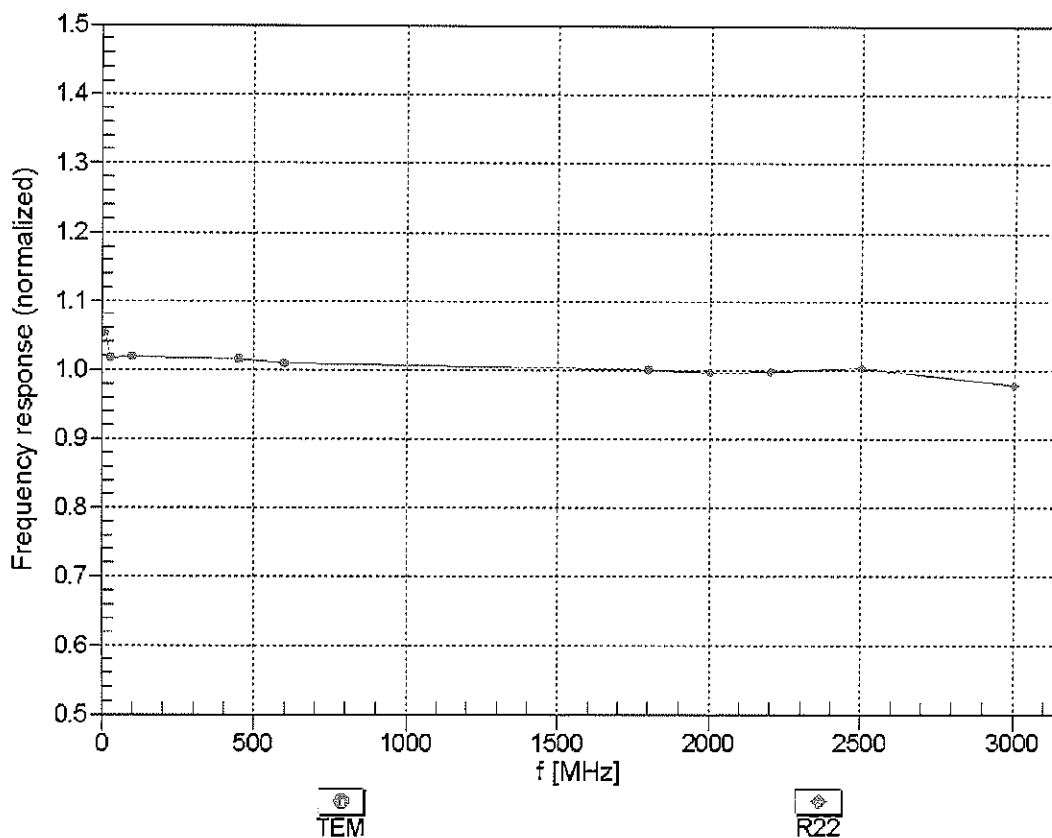

Uncertainty of Frequency Response of E-field:  $\pm 6.3\%$  (k=2)

### Receiving Pattern ( $\phi$ ), $\vartheta = 0^\circ$

f=600 MHz, TEM

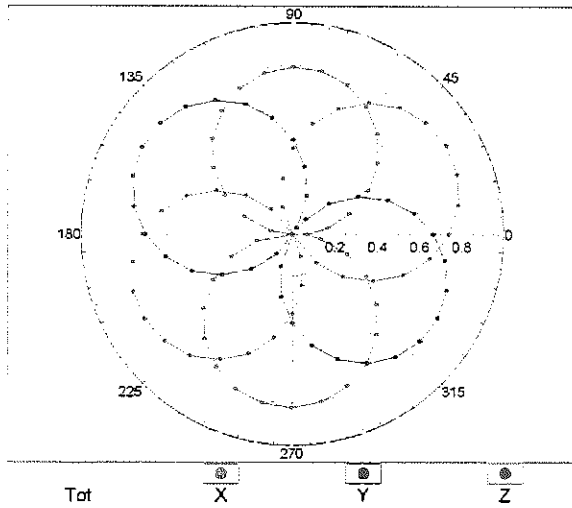

f=1800 MHz, R22

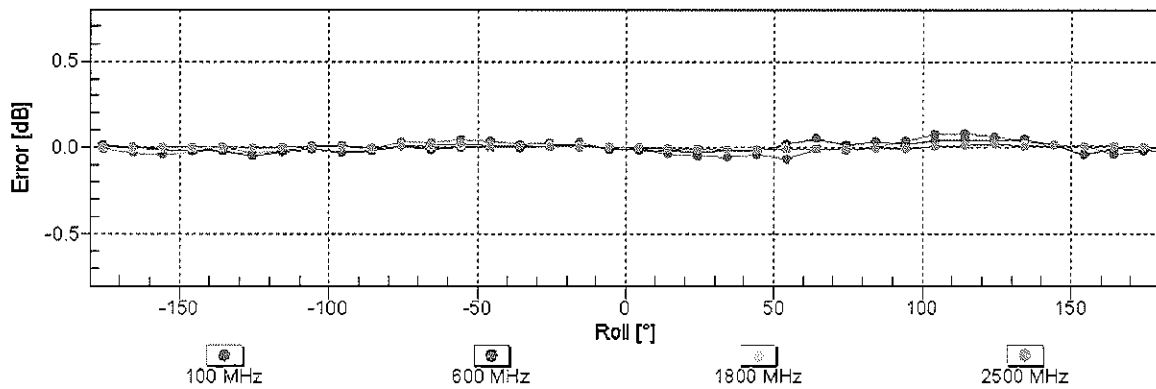
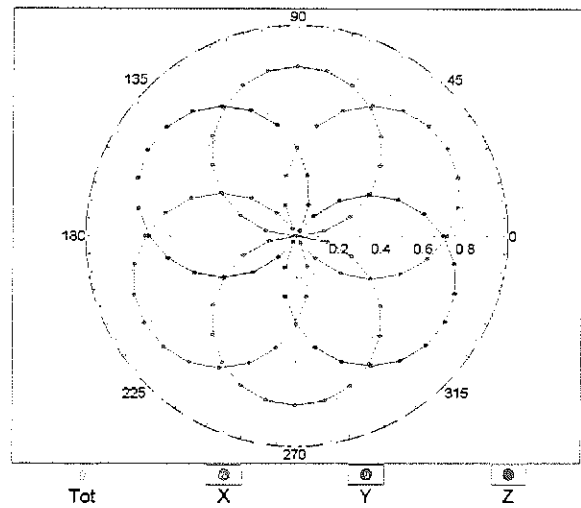

Uncertainty of Axial Isotropy Assessment:  $\pm 0.5\%$  (k=2)

### Dynamic Range $f(SAR_{head})$ (TEM cell , $f = 900$ MHz)

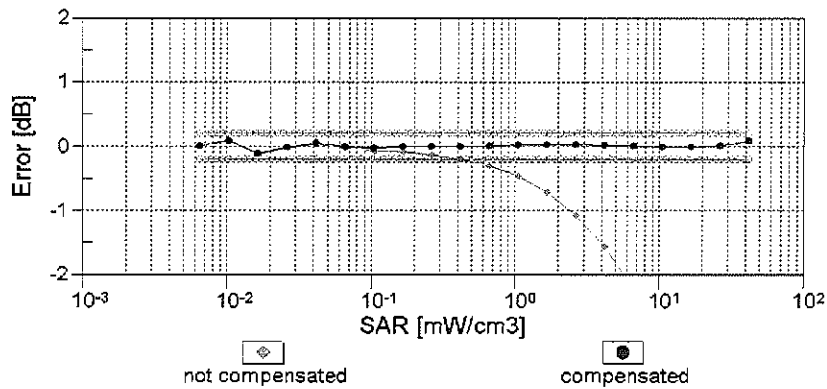
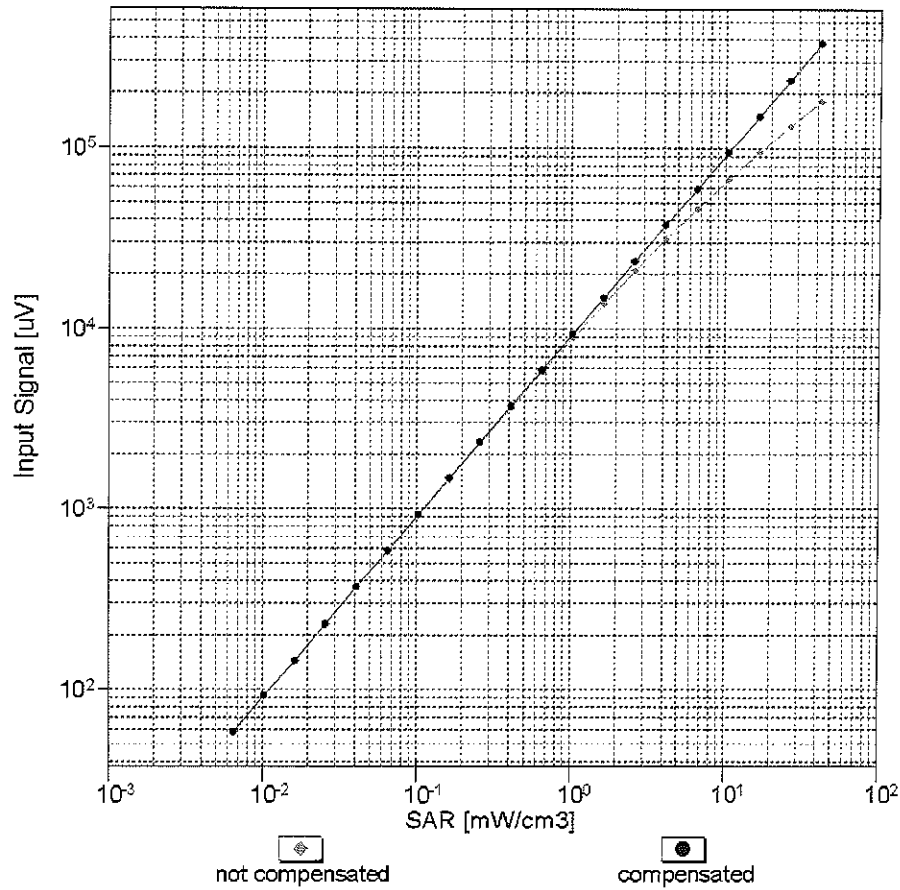

Uncertainty of Linearity Assessment:  $\pm 0.6\%$  ( $k=2$ )

# Conversion Factor Assessment

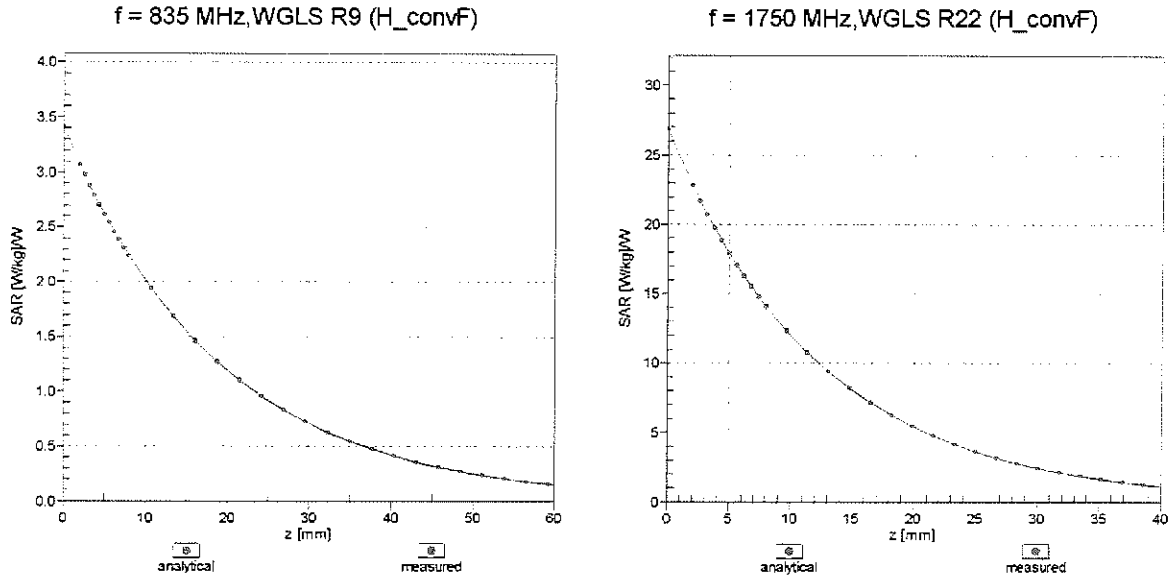

## Deviation from Isotropy in Liquid

Error ( $\phi, \theta$ ), f = 900 MHz

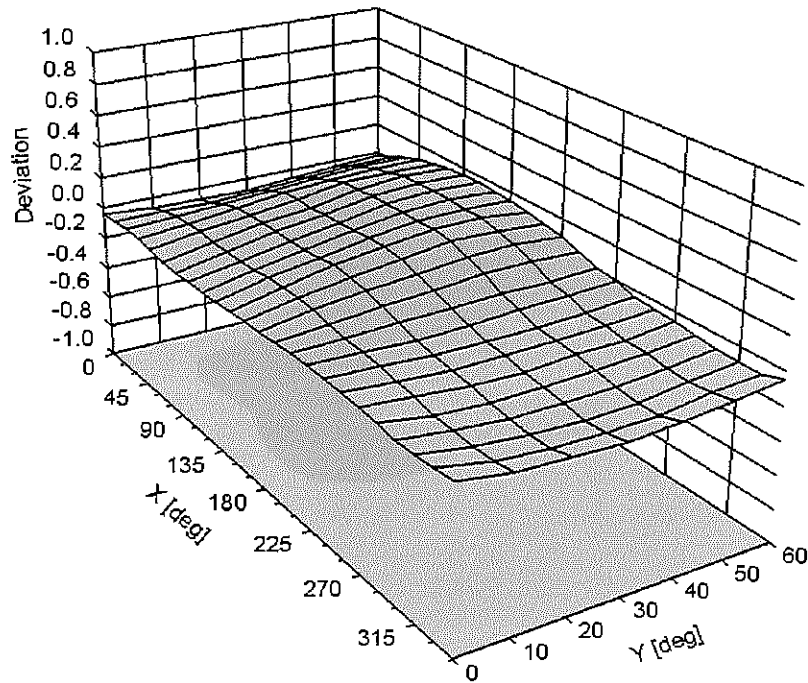

Uncertainty of Spherical Isotropy Assessment:  $\pm 2.6\%$  (k=2)

**DASY/EASY - Parameters of Probe: ES3DV3 - SN:3288****Other Probe Parameters**

Sensor Arrangement	Triangular
Connector Angle (°)	54.3
Mechanical Surface Detection Mode	enabled
Optical Surface Detection Mode	disabled
Probe Overall Length	337 mm
Probe Body Diameter	10 mm
Tip Length	10 mm
Tip Diameter	4 mm
Probe Tip to Sensor X Calibration Point	2 mm
Probe Tip to Sensor Y Calibration Point	2 mm
Probe Tip to Sensor Z Calibration Point	2 mm
Recommended Measurement Distance from Surface	3 mm



Accredited by the Swiss Accreditation Service (SAS)  
The Swiss Accreditation Service is one of the signatories to the EA  
Multilateral Agreement for the recognition of calibration certificates

Accreditation No.: **SCS 108**

Client **PC Test**

Certificate No: **ES3-3263\_May12**

**CALIBRATION CERTIFICATE**

Object **ES3DV3 - SN:3263**

Calibration procedure(s) **QA CAL-01.v8, QA CAL-12.v7, QA CAL-23.v4, QA CAL-25.v4  
Calibration procedure for dosimetric E-field probes**

Calibration date: **May 18, 2012**

*✓ Lok 6/5/12*

This calibration certificate documents the traceability to national standards, which realize the physical units of measurements (SI).  
The measurements and the uncertainties with confidence probability are given on the following pages and are part of the certificate.

All calibrations have been conducted in the closed laboratory facility: environment temperature (22 ± 3)°C and humidity < 70%.

Calibration Equipment used (M&TE critical for calibration)

Primary Standards	ID	Cal Date (Certificate No.)	Scheduled Calibration
Power meter E4419B	GB41293874	29-Mar-12 (No. 217-01508)	Apr-13
Power sensor E4412A	MY41498087	29-Mar-12 (No. 217-01508)	Apr-13
Reference 3 dB Attenuator	SN: S5054 (3c)	27-Mar-12 (No. 217-01531)	Apr-13
Reference 20 dB Attenuator	SN: S5086 (20b)	27-Mar-12 (No. 217-01529)	Apr-13
Reference 30 dB Attenuator	SN: S5129 (30b)	27-Mar-12 (No. 217-01532)	Apr-13
Reference Probe ES3DV2	SN: 3013	29-Dec-11 (No. ES3-3013_Dec11)	Dec-12
DAE4	SN: 660	10-Jan-12 (No. DAE4-660_Jan12)	Jan-13
Secondary Standards	ID	Check Date (in house)	Scheduled Check
RF generator HP 8648C	US3642U01700	4-Aug-99 (in house check Apr-11)	In house check: Apr-13
Network Analyzer HP 8753E	US37390585	18-Oct-01 (in house check Oct-11)	In house check: Oct-12

Calibrated by:	Name <b>Jeton Kastrali</b>	Function <b>Laboratory Technician</b>	Signature 
Approved by:	Name <b>Kalja Pokovic</b>	Function <b>Technical Manager</b>	Signature 
			Issued: May 21, 2012
This calibration certificate shall not be reproduced except in full without written approval of the laboratory.			



Accredited by the Swiss Accreditation Service (SAS)

Accreditation No.: SCS 108

The Swiss Accreditation Service is one of the signatories to the EA  
Multilateral Agreement for the recognition of calibration certificates

### Glossary:

TSL	tissue simulating liquid
NORM <sub>x,y,z</sub>	sensitivity in free space
ConvF	sensitivity in TSL / NORM <sub>x,y,z</sub>
DCP	diode compression point
CF	crest factor (1/duty_cycle) of the RF signal
A, B, C	modulation dependent linearization parameters
Polarization $\varphi$	$\varphi$ rotation around probe axis
Polarization $\vartheta$	$\vartheta$ rotation around an axis that is in the plane normal to probe axis (at measurement center), i.e., $\vartheta = 0$ is normal to probe axis

### Calibration is Performed According to the Following Standards:

- IEEE Std 1528-2003, "IEEE Recommended Practice for Determining the Peak Spatial-Averaged Specific Absorption Rate (SAR) in the Human Head from Wireless Communications Devices: Measurement Techniques", December 2003
- IEC 62209-1, "Procedure to measure the Specific Absorption Rate (SAR) for hand-held devices used in close proximity to the ear (frequency range of 300 MHz to 3 GHz)", February 2005

### Methods Applied and Interpretation of Parameters:

- NORM<sub>x,y,z</sub>**: Assessed for E-field polarization  $\vartheta = 0$  ( $f \leq 900$  MHz in TEM-cell;  $f > 1800$  MHz: R22 waveguide). NORM<sub>x,y,z</sub> are only intermediate values, i.e., the uncertainties of NORM<sub>x,y,z</sub> does not affect the E<sup>2</sup>-field uncertainty inside TSL (see below ConvF).
- NORM(f)<sub>x,y,z</sub>** = NORM<sub>x,y,z</sub> \* frequency\_response (see Frequency Response Chart). This linearization is implemented in DASY4 software versions later than 4.2. The uncertainty of the frequency response is included in the stated uncertainty of ConvF.
- DCP<sub>x,y,z</sub>**: DCP are numerical linearization parameters assessed based on the data of power sweep with CW signal (no uncertainty required). DCP does not depend on frequency nor media.
- PAR**: PAR is the Peak to Average Ratio that is not calibrated but determined based on the signal characteristics
- A<sub>x,y,z</sub>; B<sub>x,y,z</sub>; C<sub>x,y,z</sub>; VR<sub>x,y,z</sub>**: A, B, C are numerical linearization parameters assessed based on the data of power sweep for specific modulation signal. The parameters do not depend on frequency nor media. VR is the maximum calibration range expressed in RMS voltage across the diode.
- ConvF and Boundary Effect Parameters**: Assessed in flat phantom using E-field (or Temperature Transfer Standard for  $f \leq 800$  MHz) and inside waveguide using analytical field distributions based on power measurements for  $f > 800$  MHz. The same setups are used for assessment of the parameters applied for boundary compensation (alpha, depth) of which typical uncertainty values are given. These parameters are used in DASY4 software to improve probe accuracy close to the boundary. The sensitivity in TSL corresponds to NORM<sub>x,y,z</sub> \* ConvF whereby the uncertainty corresponds to that given for ConvF. A frequency dependent ConvF is used in DASY version 4.4 and higher which allows extending the validity from  $\pm 50$  MHz to  $\pm 100$  MHz.
- Spherical isotropy (3D deviation from isotropy)**: in a field of low gradients realized using a flat phantom exposed by a patch antenna.
- Sensor Offset**: The sensor offset corresponds to the offset of virtual measurement center from the probe tip (on probe axis). No tolerance required.

# Probe ES3DV3

## SN:3263

Manufactured: January 25, 2010  
Calibrated: May 18, 2012

Calibrated for DASY/EASY Systems  
(Note: non-compatible with DASY2 system!)

## DASY/EASY - Parameters of Probe: ES3DV3 - SN:3263

### Basic Calibration Parameters

	Sensor X	Sensor Y	Sensor Z	Unc (k=2)
Norm ( $\mu\text{V}/(\text{V}/\text{m})^2$ ) <sup>A</sup>	1.21	1.23	1.12	$\pm 10.1 \%$
DCP (mV) <sup>B</sup>	100.1	99.6	104.5	

### Modulation Calibration Parameters

UID	Communication System Name	PAR		A dB	B dB	C dB	VR mV	Unc <sup>E</sup> (k=2)
0	CW	0.00	X	0.00	0.00	1.00	153.9	$\pm 4.4 \%$
			Y	0.00	0.00	1.00	159.2	
			Z	0.00	0.00	1.00	150.3	

The reported uncertainty of measurement is stated as the standard uncertainty of measurement multiplied by the coverage factor k=2, which for a normal distribution corresponds to a coverage probability of approximately 95%.

<sup>A</sup> The uncertainties of NormX,Y,Z do not affect the E<sup>2</sup>-field uncertainty inside TSL (see Pages 5 and 6).

<sup>B</sup> Numerical linearization parameter: uncertainty not required.

<sup>E</sup> Uncertainty is determined using the max. deviation from linear response applying rectangular distribution and is expressed for the square of the field value.

## DASY/EASY - Parameters of Probe: ES3DV3 - SN:3263

### Calibration Parameter Determined in Head Tissue Simulating Media

f (MHz) <sup>C</sup>	Relative Permittivity <sup>F</sup>	Conductivity (S/m) <sup>F</sup>	ConvF X	ConvF Y	ConvF Z	Alpha	Depth (mm)	Unct. (k=2)
750	41.9	0.89	6.40	6.40	6.40	0.32	1.73	± 12.0 %
835	41.5	0.90	6.16	6.16	6.16	0.40	1.54	± 12.0 %
1640	40.3	1.29	5.46	5.46	5.46	0.53	1.37	± 12.0 %
1750	40.1	1.37	5.30	5.30	5.30	0.47	1.50	± 12.0 %
1900	40.0	1.40	5.09	5.09	5.09	0.55	1.35	± 12.0 %
2450	39.2	1.80	4.45	4.45	4.45	0.77	1.27	± 12.0 %
2600	39.0	1.96	4.34	4.34	4.34	0.76	1.34	± 12.0 %

<sup>C</sup> Frequency validity of ± 100 MHz only applies for DASY v4.4 and higher (see Page 2), else it is restricted to ± 50 MHz. The uncertainty is the RSS of the ConvF uncertainty at calibration frequency and the uncertainty for the indicated frequency band.

<sup>F</sup> At frequencies below 3 GHz, the validity of tissue parameters ( $\epsilon$  and  $\sigma$ ) can be relaxed to ± 10% if liquid compensation formula is applied to measured SAR values. At frequencies above 3 GHz, the validity of tissue parameters ( $\epsilon$  and  $\sigma$ ) is restricted to ± 5%. The uncertainty is the RSS of the ConvF uncertainty for indicated target tissue parameters.

## DASY/EASY - Parameters of Probe: ES3DV3 - SN:3263

### Calibration Parameter Determined in Body Tissue Simulating Media

f (MHz) <sup>C</sup>	Relative Permittivity <sup>F</sup>	Conductivity (S/m) <sup>F</sup>	ConvF X	ConvF Y	ConvF Z	Alpha	Depth (mm)	Unct. (k=2)
450	56.7	0.94	7.05	7.05	7.05	0.08	1.15	± 13.4 %
750	55.5	0.96	6.26	6.26	6.26	0.68	1.24	± 12.0 %
835	55.2	0.97	6.15	6.15	6.15	0.40	1.65	± 12.0 %
1640	53.8	1.40	5.33	5.33	5.33	0.74	1.27	± 12.0 %
1750	53.4	1.49	4.96	4.96	4.96	0.62	1.41	± 12.0 %
1900	53.3	1.52	4.76	4.76	4.76	0.54	1.48	± 12.0 %
2450	52.7	1.95	4.35	4.35	4.35	0.80	1.15	± 12.0 %
2600	52.5	2.16	4.16	4.16	4.16	0.80	1.00	± 12.0 %

<sup>C</sup> Frequency validity of ± 100 MHz only applies for DASY v4.4 and higher (see Page 2), else it is restricted to ± 50 MHz. The uncertainty is the RSS of the ConvF uncertainty at calibration frequency and the uncertainty for the indicated frequency band.

<sup>F</sup> At frequencies below 3 GHz, the validity of tissue parameters ( $\epsilon$  and  $\sigma$ ) can be relaxed to ± 10% if liquid compensation formula is applied to measured SAR values. At frequencies above 3 GHz, the validity of tissue parameters ( $\epsilon$  and  $\sigma$ ) is restricted to ± 5%. The uncertainty is the RSS of the ConvF uncertainty for indicated target tissue parameters.

# Frequency Response of E-Field

(TEM-Cell:ifi110 EXX, Waveguide: R22)

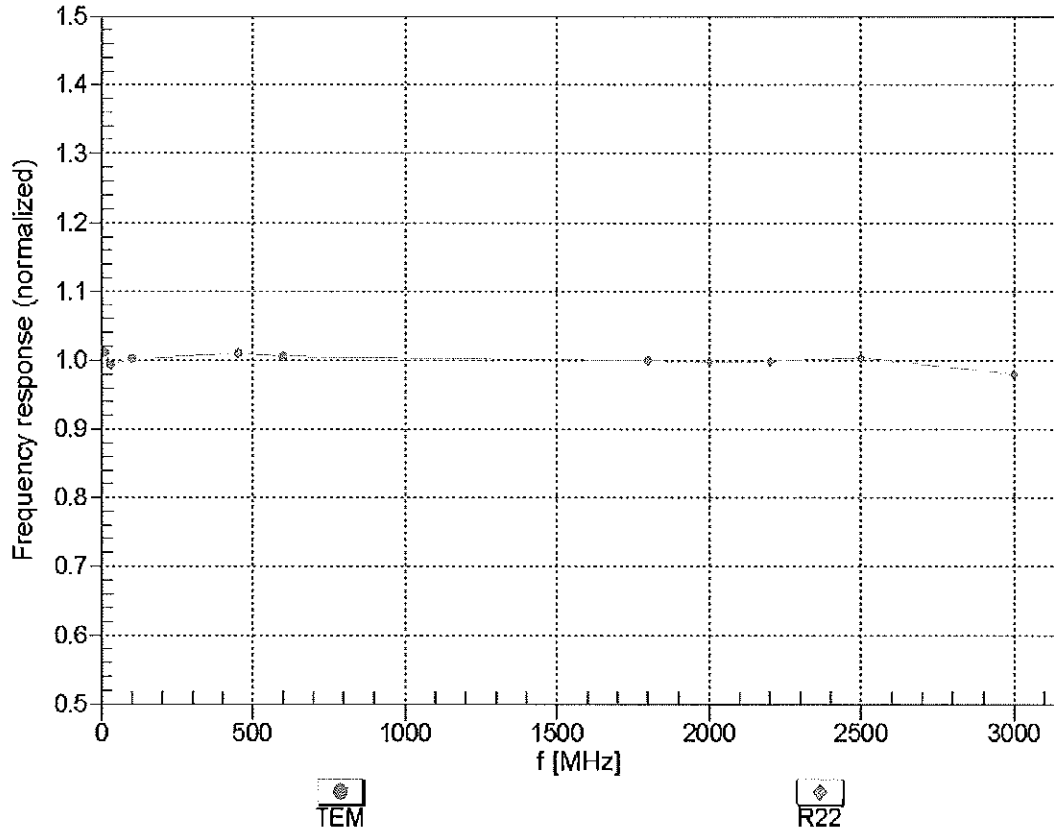

Uncertainty of Frequency Response of E-field:  $\pm 6.3\%$  (k=2)

### Receiving Pattern ( $\phi$ ), $\theta = 0^\circ$

f=600 MHz, TEM

f=1800 MHz, R22

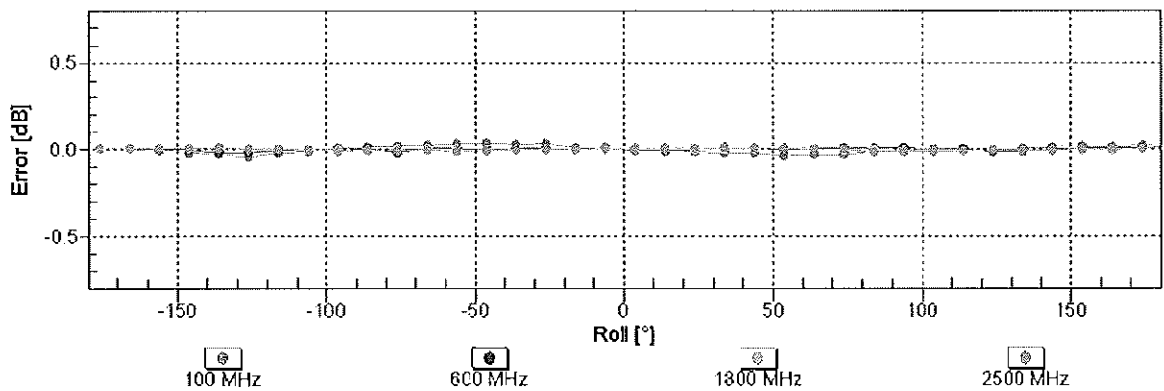
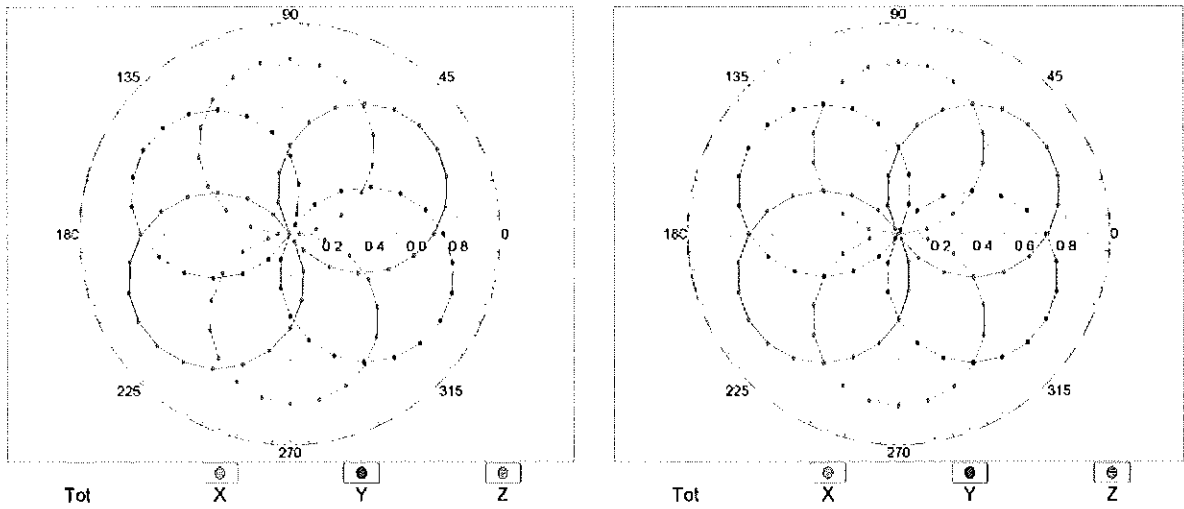

Uncertainty of Axial Isotropy Assessment:  $\pm 0.5\%$  (k=2)

## Dynamic Range $f(\text{SAR}_{\text{head}})$ (TEM cell , $f = 900 \text{ MHz}$ )

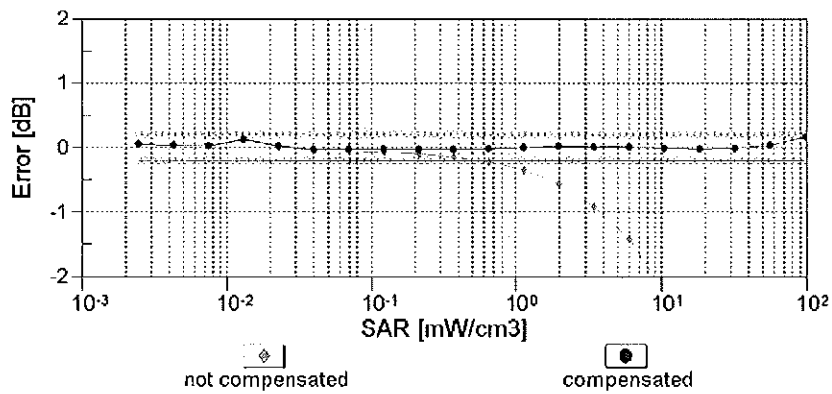
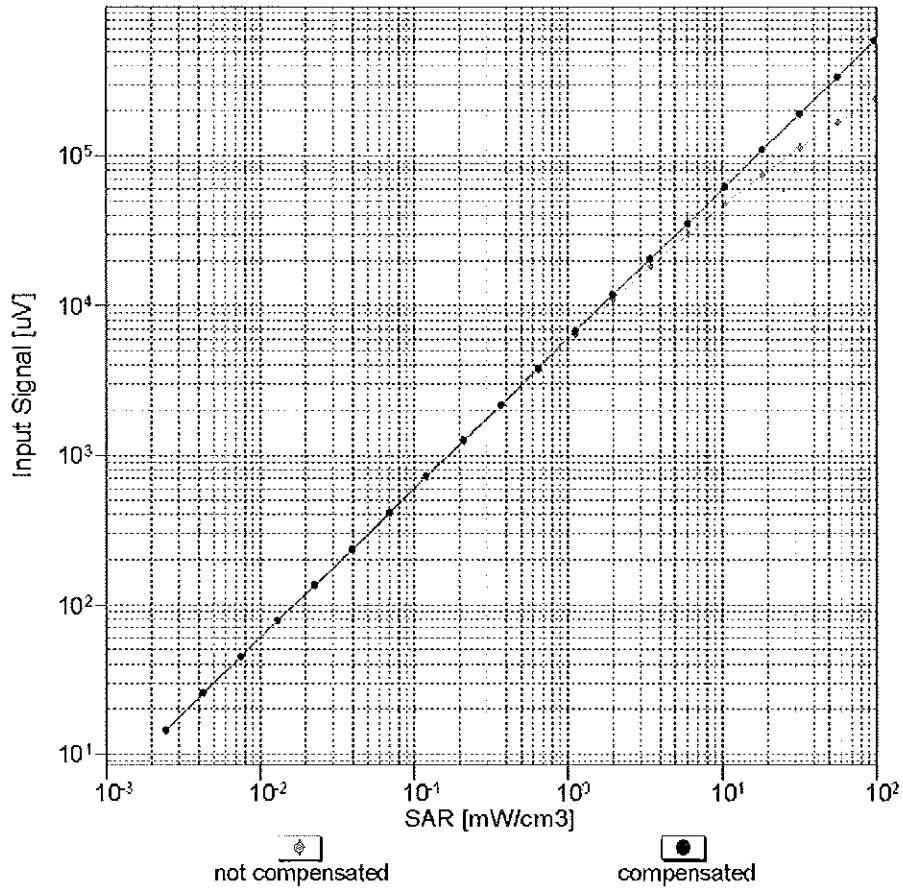

**Uncertainty of Linearity Assessment:  $\pm 0.6\%$  ( $k=2$ )**

# Conversion Factor Assessment

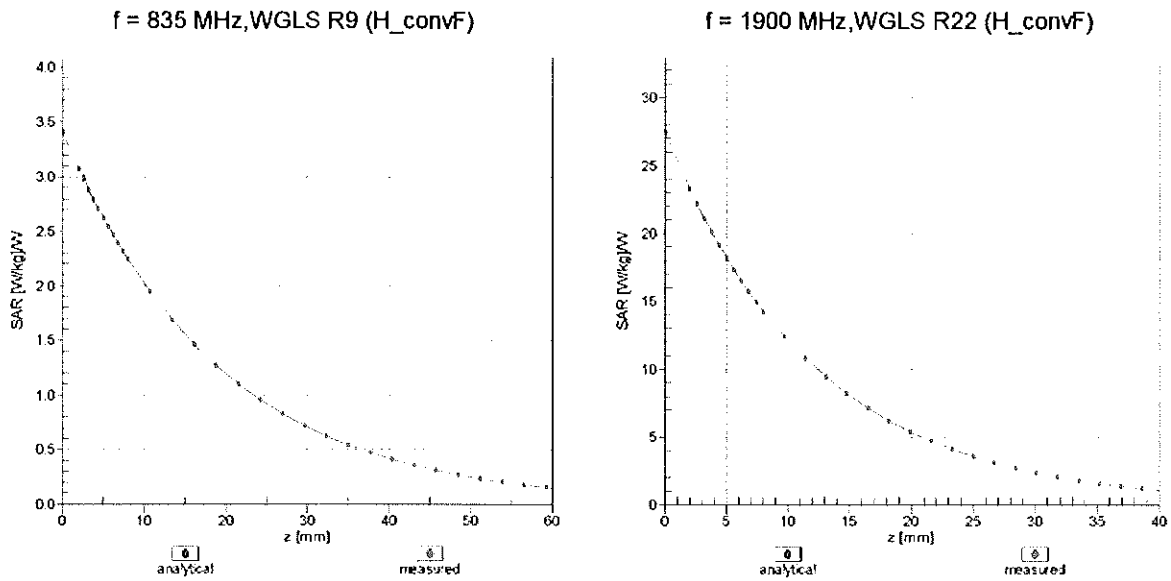

## Deviation from Isotropy in Liquid

Error ( $\phi, \theta$ ), f = 900 MHz

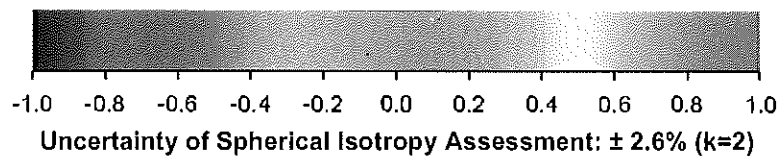
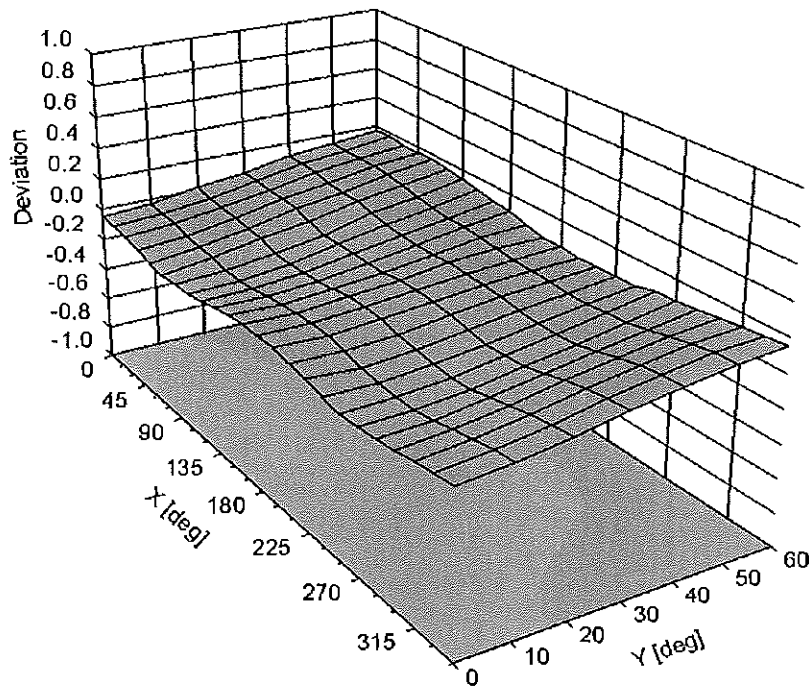

Uncertainty of Spherical Isotropy Assessment:  $\pm 2.6\%$  (k=2)

## DASY/EASY - Parameters of Probe: ES3DV3 - SN:3263

### Other Probe Parameters

Sensor Arrangement	Triangular
Connector Angle (°)	63.9
Mechanical Surface Detection Mode	enabled
Optical Surface Detection Mode	disabled
Probe Overall Length	337 mm
Probe Body Diameter	10 mm
Tip Length	10 mm
Tip Diameter	4 mm
Probe Tip to Sensor X Calibration Point	2 mm
Probe Tip to Sensor Y Calibration Point	2 mm
Probe Tip to Sensor Z Calibration Point	2 mm
Recommended Measurement Distance from Surface	3 mm



Accredited by the Swiss Accreditation Service (SAS)  
The Swiss Accreditation Service is one of the signatories to the EA  
Multilateral Agreement for the recognition of calibration certificates

Accreditation No.: **SCS 108**

Client **PC Test**

Certificate No: **ES3-3258\_Feb12**

## CALIBRATION CERTIFICATE

Object **ES3DV3 - SN:3258**

Calibration procedure(s) **QA CAL-01 vs. QA CAL-23 v1, QA CAL-25 v1  
Calibration procedure for doxumatic E-field probes**

Calibration date: **February 21, 2012**

This calibration certificate documents the traceability to national standards, which realize the physical units of measurements (SI).  
The measurements and the uncertainties with confidence probability are given on the following pages and are part of the certificate.

All calibrations have been conducted in the closed laboratory facility: environment temperature (22 ± 3)°C and humidity < 70%.

Calibration Equipment used (M&TE critical for calibration)

*KOK  
2/27/12*

Primary Standards	ID	Cal Date (Certificate No.)	Scheduled Calibration
Power meter E4419B	GB41293874	31-Mar-11 (No. 217-01372)	Apr-12
Power sensor E4412A	MY41498087	31-Mar-11 (No. 217-01372)	Apr-12
Reference 3 dB Attenuator	SN: S5054 (3c)	29-Mar-11 (No. 217-01369)	Apr-12
Reference 20 dB Attenuator	SN: S5086 (20b)	29-Mar-11 (No. 217-01367)	Apr-12
Reference 30 dB Attenuator	SN: S5129 (30b)	29-Mar-11 (No. 217-01370)	Apr-12
Reference Probe ES3DV2	SN: 3013	29-Dec-11 (No. ES3-3013_Dec11)	Dec-12
DAE4	SN: 654	3-May-11 (No. DAE4-654_May11)	May-12
Secondary Standards	ID	Check Date (in house)	Scheduled Check
RF generator HP 8648C	US3642U01700	4-Aug-99 (in house check Apr-11)	In house check: Apr-13
Network Analyzer HP 8753E	US37390585	18-Oct-01 (in house check Oct-11)	In house check: Oct-12

Calibrated by:	Name <b>Claudio Leubler</b>	Function <b>Laboratory Technician</b>	Signature 
Approved by:	Name <b>Katja Pokovic</b>	Function <b>Technical Manager</b>	Signature 
This calibration certificate shall not be reproduced except in full without written approval of the laboratory.			Issued: February 23, 2012



Accredited by the Swiss Accreditation Service (SAS)  
The Swiss Accreditation Service is one of the signatories to the EA  
Multilateral Agreement for the recognition of calibration certificates

Accreditation No.: SCS 108

### Glossary:

TSL	tissue simulating liquid
NORM <sub>x,y,z</sub>	sensitivity in free space
ConvF	sensitivity in TSL / NORM <sub>x,y,z</sub>
DCP	diode compression point
CF	crest factor (1/duty_cycle) of the RF signal
A, B, C	modulation dependent linearization parameters
Polarization $\varphi$	$\varphi$ rotation around probe axis
Polarization $\vartheta$	$\vartheta$ rotation around an axis that is in the plane normal to probe axis (at measurement center), i.e., $\vartheta = 0$ is normal to probe axis

### Calibration is Performed According to the Following Standards:

- IEEE Std 1528-2003, "IEEE Recommended Practice for Determining the Peak Spatial-Averaged Specific Absorption Rate (SAR) in the Human Head from Wireless Communications Devices: Measurement Techniques", December 2003
- IEC 62209-1, "Procedure to measure the Specific Absorption Rate (SAR) for hand-held devices used in close proximity to the ear (frequency range of 300 MHz to 3 GHz)", February 2005

### Methods Applied and Interpretation of Parameters:

- NORM<sub>x,y,z</sub>**: Assessed for E-field polarization  $\vartheta = 0$  ( $f \leq 900$  MHz in TEM-cell;  $f > 1800$  MHz: R22 waveguide). NORM<sub>x,y,z</sub> are only intermediate values, i.e., the uncertainties of NORM<sub>x,y,z</sub> does not affect the E<sup>2</sup>-field uncertainty inside TSL (see below ConvF).
- NORM(f)<sub>x,y,z</sub> = NORM<sub>x,y,z</sub> \* frequency\_response** (see Frequency Response Chart). This linearization is implemented in DASY4 software versions later than 4.2. The uncertainty of the frequency response is included in the stated uncertainty of ConvF.
- DCP<sub>x,y,z</sub>**: DCP are numerical linearization parameters assessed based on the data of power sweep with CW signal (no uncertainty required). DCP does not depend on frequency nor media.
- PAR**: PAR is the Peak to Average Ratio that is not calibrated but determined based on the signal characteristics
- A<sub>x,y,z</sub>; B<sub>x,y,z</sub>; C<sub>x,y,z</sub>; VR<sub>x,y,z</sub>; A, B, C** are numerical linearization parameters assessed based on the data of power sweep for specific modulation signal. The parameters do not depend on frequency nor media. VR is the maximum calibration range expressed in RMS voltage across the diode.
- ConvF and Boundary Effect Parameters**: Assessed in flat phantom using E-field (or Temperature Transfer Standard for  $f \leq 800$  MHz) and inside waveguide using analytical field distributions based on power measurements for  $f > 800$  MHz. The same setups are used for assessment of the parameters applied for boundary compensation (alpha, depth) of which typical uncertainty values are given. These parameters are used in DASY4 software to improve probe accuracy close to the boundary. The sensitivity in TSL corresponds to NORM<sub>x,y,z</sub> \* ConvF whereby the uncertainty corresponds to that given for ConvF. A frequency dependent ConvF is used in DASY version 4.4 and higher which allows extending the validity from  $\pm 50$  MHz to  $\pm 100$  MHz.
- Spherical isotropy (3D deviation from isotropy)**: in a field of low gradients realized using a flat phantom exposed by a patch antenna.
- Sensor Offset**: The sensor offset corresponds to the offset of virtual measurement center from the probe tip (on probe axis). No tolerance required.

# Probe ES3DV3

## SN:3258

Manufactured: January 25, 2010  
Calibrated: February 21, 2012

Calibrated for DASY/EASY Systems  
(Note: non-compatible with DASY2 system!)

## DASY/EASY - Parameters of Probe: ES3DV3 - SN:3258

### Basic Calibration Parameters

	Sensor X	Sensor Y	Sensor Z	Unc (k=2)
Norm ( $\mu\text{V}/(\text{V}/\text{m})^2$ ) <sup>A</sup>	1.29	1.18	1.23	± 10.1 %
DCP (mV) <sup>B</sup>	101.6	105.0	100.8	

### Modulation Calibration Parameters

UID	Communication System Name	PAR		A dB	B dB	C dB	VR mV	Unc <sup>E</sup> (k=2)
10000	CW	0.00	X	0.00	0.00	1.00	115.9	±3.0 %
			Y	0.00	0.00	1.00	107.9	
			Z	0.00	0.00	1.00	115.8	

The reported uncertainty of measurement is stated as the standard uncertainty of measurement multiplied by the coverage factor k=2, which for a normal distribution corresponds to a coverage probability of approximately 95%.

<sup>A</sup> The uncertainties of NormX,Y,Z do not affect the E<sup>2</sup>-field uncertainty inside TSL (see Pages 5 and 6).

<sup>B</sup> Numerical linearization parameter: uncertainty not required.

<sup>E</sup> Uncertainty is determined using the max. deviation from linear response applying rectangular distribution and is expressed for the square of the field value.

## DASY/EASY - Parameters of Probe: ES3DV3 - SN:3258

### Calibration Parameter Determined in Head Tissue Simulating Media

f (MHz) <sup>C</sup>	Relative Permittivity <sup>F</sup>	Conductivity (S/m) <sup>F</sup>	ConvF X	ConvF Y	ConvF Z	Alpha	Depth (mm)	Unct. (k=2)
750	41.9	0.89	6.26	6.26	6.26	0.43	1.49	± 12.0 %
835	41.5	0.90	6.01	6.01	6.01	0.45	1.48	± 12.0 %
1640	40.3	1.29	5.46	5.46	5.46	0.61	1.30	± 12.0 %
1750	40.1	1.37	5.30	5.30	5.30	0.67	1.30	± 12.0 %
1900	40.0	1.40	5.17	5.17	5.17	0.79	1.23	± 12.0 %
2450	39.2	1.80	4.46	4.46	4.46	0.67	1.40	± 12.0 %
2600	39.0	1.96	4.31	4.31	4.31	0.80	1.33	± 12.0 %

<sup>C</sup> Frequency validity of ± 100 MHz only applies for DASY v4.4 and higher (see Page 2), else it is restricted to ± 50 MHz. The uncertainty is the RSS of the ConvF uncertainty at calibration frequency and the uncertainty for the indicated frequency band.

<sup>F</sup> At frequencies below 3 GHz, the validity of tissue parameters ( $\epsilon$  and  $\sigma$ ) can be relaxed to ± 10% if liquid compensation formula is applied to measured SAR values. At frequencies above 3 GHz, the validity of tissue parameters ( $\epsilon$  and  $\sigma$ ) is restricted to ± 5%. The uncertainty is the RSS of the ConvF uncertainty for indicated target tissue parameters.

## DASY/EASY - Parameters of Probe: ES3DV3 - SN:3258

### Calibration Parameter Determined in Body Tissue Simulating Media

f (MHz) <sup>C</sup>	Relative Permittivity <sup>F</sup>	Conductivity (S/m) <sup>F</sup>	ConvF X	ConvF Y	ConvF Z	Alpha	Depth (mm)	Unct. (k=2)
750	55.5	0.96	6.21	6.21	6.21	0.80	1.13	± 12.0 %
835	55.2	0.97	6.06	6.06	6.06	0.50	1.46	± 12.0 %
1640	53.8	1.40	5.45	5.45	5.45	0.80	1.23	± 12.0 %
1750	53.4	1.49	4.99	4.99	4.99	0.60	1.48	± 12.0 %
1900	53.3	1.52	4.70	4.70	4.70	0.56	1.57	± 12.0 %
2450	52.7	1.95	4.28	4.28	4.28	0.80	1.08	± 12.0 %
2600	52.5	2.16	4.05	4.05	4.05	0.80	1.02	± 12.0 %

<sup>C</sup> Frequency validity of ± 100 MHz only applies for DASY v4.4 and higher (see Page 2), else it is restricted to ± 50 MHz. The uncertainty is the RSS of the ConvF uncertainty at calibration frequency and the uncertainty for the indicated frequency band.

<sup>F</sup> At frequencies below 3 GHz, the validity of tissue parameters ( $\epsilon$  and  $\sigma$ ) can be relaxed to ± 10% if liquid compensation formula is applied to measured SAR values. At frequencies above 3 GHz, the validity of tissue parameters ( $\epsilon$  and  $\sigma$ ) is restricted to ± 5%. The uncertainty is the RSS of the ConvF uncertainty for indicated target tissue parameters.

# Frequency Response of E-Field

(TEM-Cell:ifi110 EXX, Waveguide: R22)

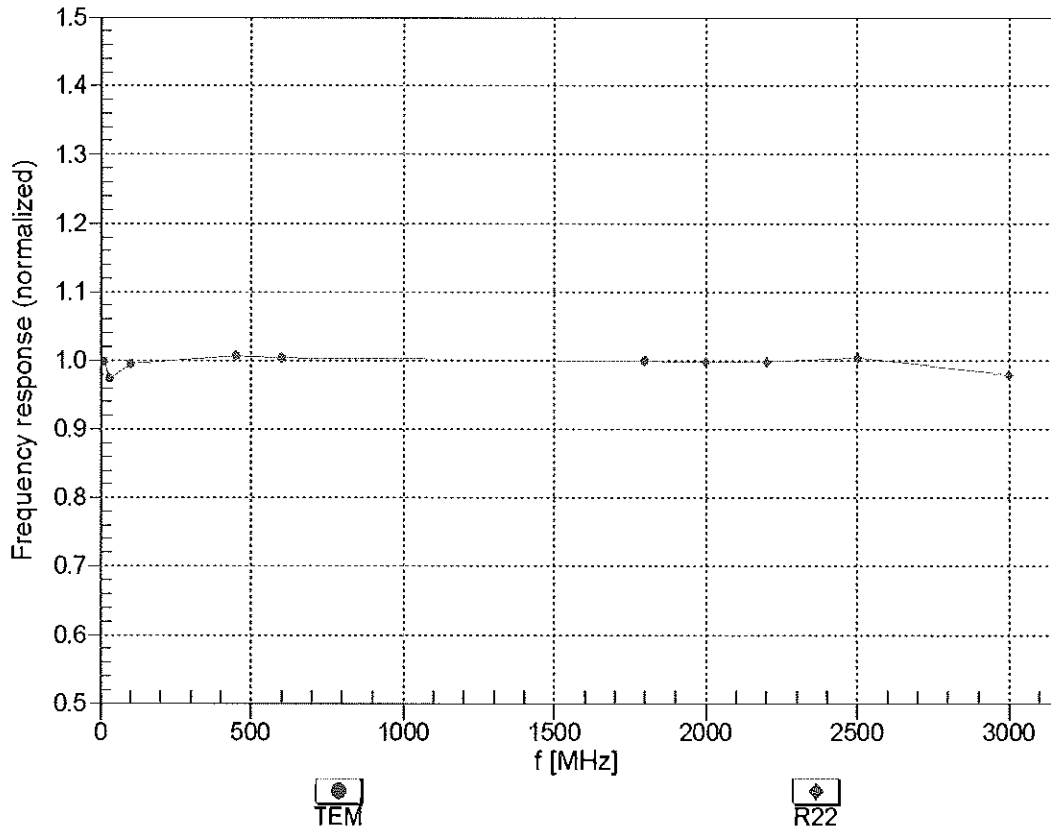

Uncertainty of Frequency Response of E-field:  $\pm 6.3\%$  (k=2)

### Receiving Pattern ( $\phi$ ), $\theta = 0^\circ$

f=600 MHz,TEM

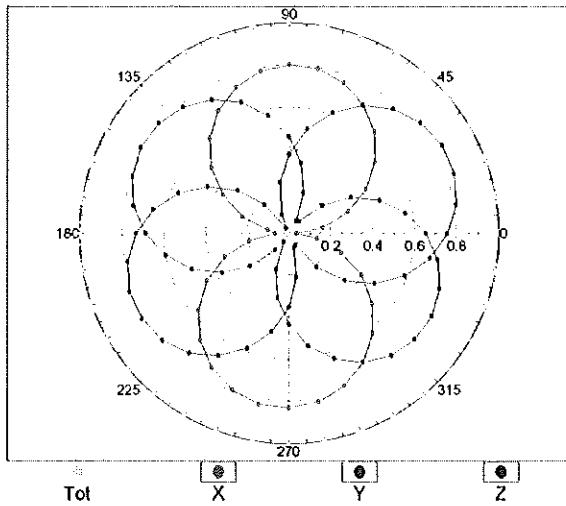

f=1800 MHz,R22

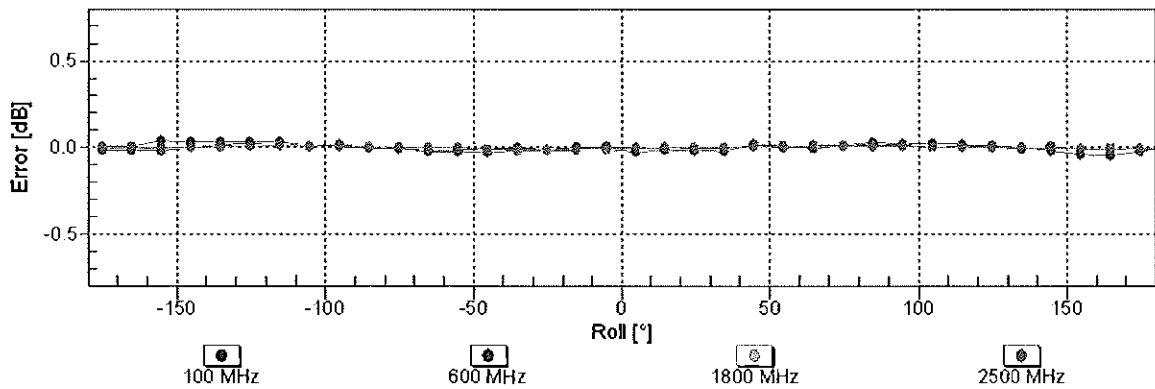
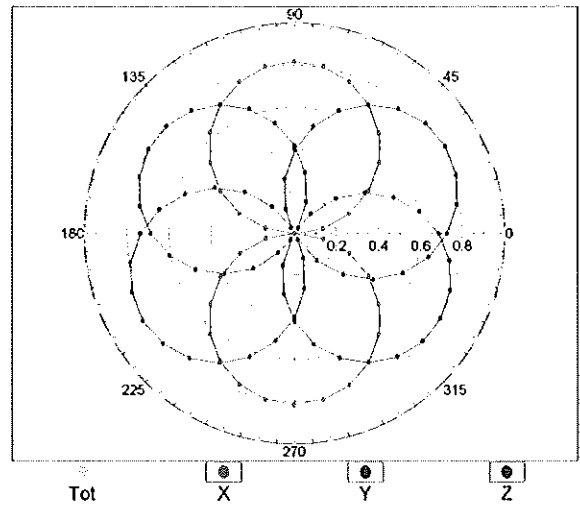

Uncertainty of Axial Isotropy Assessment:  $\pm 0.5\%$  ( $k=2$ )

## Dynamic Range $f(SAR_{head})$ (TEM cell , $f = 900$ MHz)

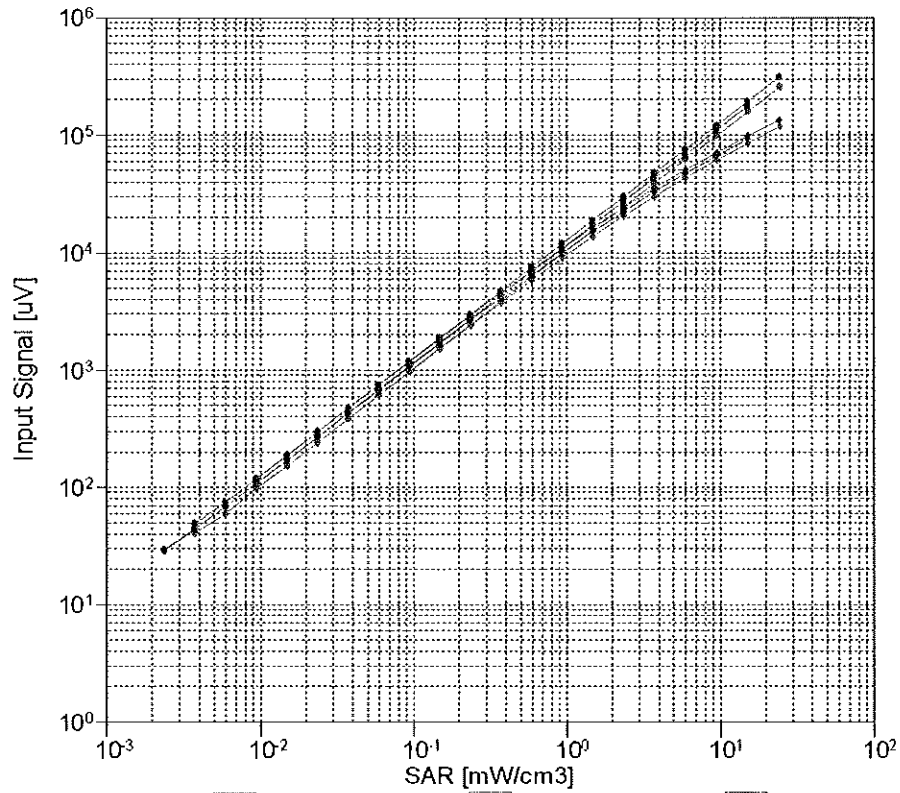

X compensated	X not compensated	Y compensated
Y not compensated	Z compensated	Z not compensated

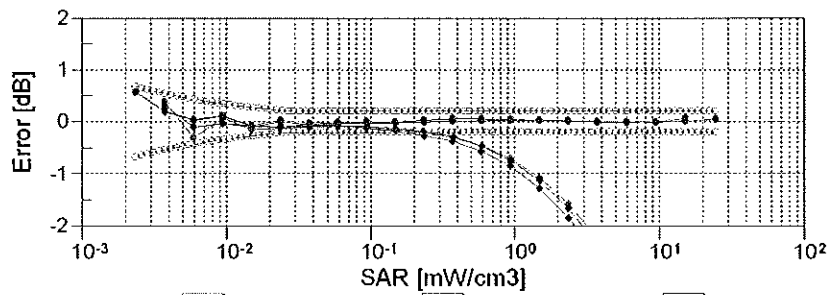

X compensated	X not compensated	Y compensated
Y not compensated	Z compensated	Z not compensated

**Uncertainty of Linearity Assessment:  $\pm 0.6\%$  ( $k=2$ )**

# Conversion Factor Assessment

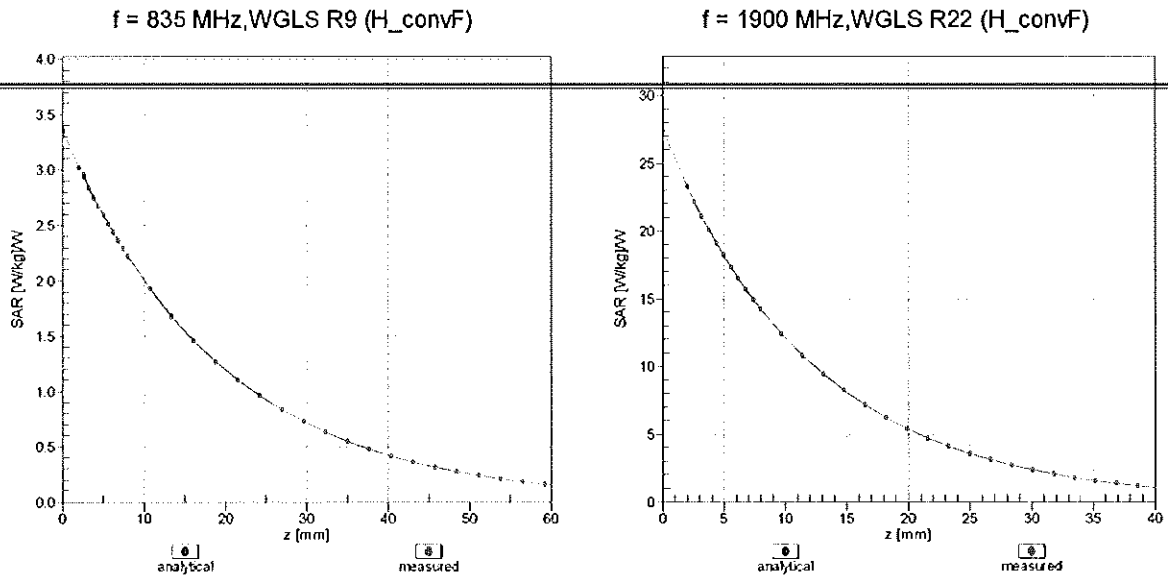

## Deviation from Isotropy in Liquid Error ( $\phi, \theta$ ), f = 900 MHz

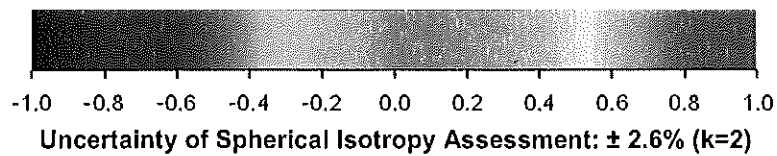
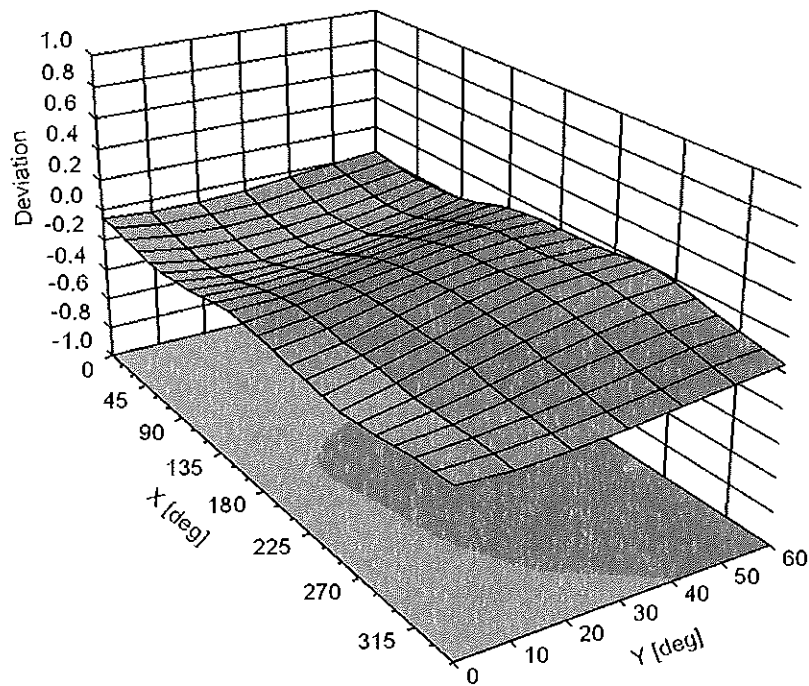

## DASY/EASY - Parameters of Probe: ES3DV3 - SN:3258

---

### Other Probe Parameters

Sensor Arrangement	Triangular
Connector Angle (°)	Not applicable
Mechanical Surface Detection Mode	enabled
Optical Surface Detection Mode	disabled
Probe Overall Length	337 mm
Probe Body Diameter	10 mm
Tip Length	10 mm
Tip Diameter	4 mm
Probe Tip to Sensor X Calibration Point	2 mm
Probe Tip to Sensor Y Calibration Point	2 mm
Probe Tip to Sensor Z Calibration Point	2 mm
Recommended Measurement Distance from Surface	3 mm



Accredited by the Swiss Accreditation Service (SAS)  
 The Swiss Accreditation Service is one of the signatories to the EA  
 Multilateral Agreement for the recognition of calibration certificates

Accreditation No.: **SCS 108**

Client **PC Test**

Certificate No.: **ES3-3209\_Mar12**

**CALIBRATION CERTIFICATE**

Object **ES3DV3 - SN:3209**

Calibration procedure(s) **QA CAL-01.v8, QA CAL-12.v7, QA CAL-23.v4, QA CAL-25.v4  
 Calibration procedure for dosimetric E-field probes**

Calibration date: **March 16, 2012**

*KOK  
 4/15/12*

This calibration certificate documents the traceability to national standards, which realize the physical units of measurements (SI).  
 The measurements and the uncertainties with confidence probability are given on the following pages and are part of the certificate.

All calibrations have been conducted in the closed laboratory facility: environment temperature (22 ± 3)°C and humidity < 70%.

Calibration Equipment used (M&TE critical for calibration)

Primary Standards	ID	Cal Date (Certificate No.)	Scheduled Calibration
Power meter E4419B	GB41293874	31-Mar-11 (No. 217-01372)	Apr-12
Power sensor E4412A	MY41498087	31-Mar-11 (No. 217-01372)	Apr-12
Reference 3 dB Attenuator	SN: S5054 (3c)	29-Mar-11 (No. 217-01369)	Apr-12
Reference 20 dB Attenuator	SN: S5086 (20b)	29-Mar-11 (No. 217-01367)	Apr-12
Reference 30 dB Attenuator	SN: S5129 (30b)	29-Mar-11 (No. 217-01370)	Apr-12
Reference Probe ES3DV2	SN: 3013	29-Dec-11 (No. ES3-3013_Dec11)	Dec-12
DAE4	SN: 654	3-May-11 (No. DAE4-654_May11)	May-12
Secondary Standards	ID	Check Date (in house)	Scheduled Check
RF generator HP 8648C	US3642U01700	4-Aug-99 (in house check Apr-11)	In house check: Apr-13
Network Analyzer HP 8753E	US37390585	18-Oct-01 (in house check Oct-11)	In house check: Oct-12

	Name	Function	Signature
Calibrated by:	Jeton Kastrati	Laboratory Technician	<i>[Signature]</i>
Approved by:	Katja Pokovic	Technical Manager	<i>[Signature]</i>

Issued: March 19, 2012

This calibration certificate shall not be reproduced except in full without written approval of the laboratory.



Accredited by the Swiss Accreditation Service (SAS)  
The Swiss Accreditation Service is one of the signatories to the EA  
Multilateral Agreement for the recognition of calibration certificates

Accreditation No.: **SCS 108**

**Glossary:**

TSL	tissue simulating liquid
NORM <sub>x,y,z</sub>	sensitivity in free space
ConvF	sensitivity in TSL / NORM <sub>x,y,z</sub>
DCP	diode compression point
CF	crest factor (1/duty_cycle) of the RF signal
A, B, C	modulation dependent linearization parameters
Polarization $\phi$	$\phi$ rotation around probe axis
Polarization $\vartheta$	$\vartheta$ rotation around an axis that is in the plane normal to probe axis (at measurement center), i.e., $\vartheta = 0$ is normal to probe axis

**Calibration is Performed According to the Following Standards:**

- a) IEEE Std 1528-2003, "IEEE Recommended Practice for Determining the Peak Spatial-Averaged Specific Absorption Rate (SAR) in the Human Head from Wireless Communications Devices: Measurement Techniques", December 2003
- b) IEC 62209-1, "Procedure to measure the Specific Absorption Rate (SAR) for hand-held devices used in close proximity to the ear (frequency range of 300 MHz to 3 GHz)", February 2005

**Methods Applied and Interpretation of Parameters:**

- **NORM<sub>x,y,z</sub>**: Assessed for E-field polarization  $\vartheta = 0$  ( $f \leq 900$  MHz in TEM-cell;  $f > 1800$  MHz: R22 waveguide). NORM<sub>x,y,z</sub> are only intermediate values, i.e., the uncertainties of NORM<sub>x,y,z</sub> does not affect the E<sup>2</sup>-field uncertainty inside TSL (see below ConvF).
- **NORM(f)<sub>x,y,z</sub>** = NORM<sub>x,y,z</sub> \* frequency\_response (see Frequency Response Chart). This linearization is implemented in DASY4 software versions later than 4.2. The uncertainty of the frequency response is included in the stated uncertainty of ConvF.
- **DCP<sub>x,y,z</sub>**: DCP are numerical linearization parameters assessed based on the data of power sweep with CW signal (no uncertainty required). DCP does not depend on frequency nor media.
- **PAR**: PAR is the Peak to Average Ratio that is not calibrated but determined based on the signal characteristics
- **A<sub>x,y,z</sub>; B<sub>x,y,z</sub>; C<sub>x,y,z</sub>; VR<sub>x,y,z</sub>; A, B, C** are numerical linearization parameters assessed based on the data of power sweep for specific modulation signal. The parameters do not depend on frequency nor media. VR is the maximum calibration range expressed in RMS voltage across the diode.
- **ConvF and Boundary Effect Parameters**: Assessed in flat phantom using E-field (or Temperature Transfer Standard for  $f \leq 800$  MHz) and inside waveguide using analytical field distributions based on power measurements for  $f > 800$  MHz. The same setups are used for assessment of the parameters applied for boundary compensation (alpha, depth) of which typical uncertainty values are given. These parameters are used in DASY4 software to improve probe accuracy close to the boundary. The sensitivity in TSL corresponds to NORM<sub>x,y,z</sub> \* ConvF whereby the uncertainty corresponds to that given for ConvF. A frequency dependent ConvF is used in DASY version 4.4 and higher which allows extending the validity from  $\pm 50$  MHz to  $\pm 100$  MHz.
- **Spherical isotropy (3D deviation from isotropy)**: in a field of low gradients realized using a flat phantom exposed by a patch antenna.
- **Sensor Offset**: The sensor offset corresponds to the offset of virtual measurement center from the probe tip (on probe axis). No tolerance required.

# Probe ES3DV3

## SN:3209

Manufactured: October 14, 2008  
Calibrated: March 16, 2012

Calibrated for DASY/EASY Systems  
(Note: non-compatible with DASY2 system!)

# DASY/EASY - Parameters of Probe: ES3DV3 - SN:3209

## Basic Calibration Parameters

	Sensor X	Sensor Y	Sensor Z	Unc (k=2)
Norm ( $\mu\text{V}/(\text{V}/\text{m})^2$ ) <sup>A</sup>	1.36	1.34	1.15	± 10.1 %
DCP (mV) <sup>B</sup>	98.2	97.4	98.7	

## Modulation Calibration Parameters

UID	Communication System Name	PAR		A dB	B dB	C dB	VR mV	Unc <sup>E</sup> (k=2)
10000	CW	0.00	X	0.00	0.00	1.00	119.2	±3.5 %
			Y	0.00	0.00	1.00	89.3	
			Z	0.00	0.00	1.00	111.5	

The reported uncertainty of measurement is stated as the standard uncertainty of measurement multiplied by the coverage factor k=2, which for a normal distribution corresponds to a coverage probability of approximately 95%.

<sup>A</sup> The uncertainties of NormX,Y,Z do not affect the E<sup>2</sup>-field uncertainty inside TSL (see Pages 5 and 6).

<sup>B</sup> Numerical linearization parameter: uncertainty not required.

<sup>E</sup> Uncertainty is determined using the max. deviation from linear response applying rectangular distribution and is expressed for the square of the field value.

## DASY/EASY - Parameters of Probe: ES3DV3 - SN:3209

### Calibration Parameter Determined in Head Tissue Simulating Media

f (MHz) <sup>c</sup>	Relative Permittivity <sup>F</sup>	Conductivity (S/m) <sup>F</sup>	ConvF X	ConvF Y	ConvF Z	Alpha	Depth (mm)	Uct. (k=2)
750	41.9	0.89	6.47	6.47	6.47	0.37	1.61	± 12.0 %
835	41.5	0.90	6.22	6.22	6.22	0.24	2.24	± 12.0 %
1640	40.3	1.29	5.38	5.38	5.38	0.41	1.56	± 12.0 %
1750	40.1	1.37	5.26	5.26	5.26	0.41	1.60	± 12.0 %
1900	40.0	1.40	5.15	5.15	5.15	0.80	1.16	± 12.0 %
2450	39.2	1.80	4.46	4.46	4.46	0.64	1.39	± 12.0 %
2600	39.0	1.96	4.30	4.30	4.30	0.69	1.42	± 12.0 %

<sup>c</sup> Frequency validity of ± 100 MHz only applies for DASY v4.4 and higher (see Page 2), else it is restricted to ± 50 MHz. The uncertainty is the RSS of the ConvF uncertainty at calibration frequency and the uncertainty for the indicated frequency band.

<sup>F</sup> At frequencies below 3 GHz, the validity of tissue parameters ( $\epsilon$  and  $\sigma$ ) can be relaxed to ± 10% if liquid compensation formula is applied to measured SAR values. At frequencies above 3 GHz, the validity of tissue parameters ( $\epsilon$  and  $\sigma$ ) is restricted to ± 5%. The uncertainty is the RSS of the ConvF uncertainty for indicated target tissue parameters.

## DASY/EASY - Parameters of Probe: ES3DV3 - SN:3209

### Calibration Parameter Determined in Body Tissue Simulating Media

f (MHz) <sup>C</sup>	Relative Permittivity <sup>F</sup>	Conductivity (S/m) <sup>F</sup>	ConvF X	ConvF Y	ConvF Z	Alpha	Depth (mm)	Unct. (k=2)
450	56.7	0.94	7.11	7.11	7.11	0.07	1.00	± 13.4 %
750	55.5	0.96	6.23	6.23	6.23	0.54	1.40	± 12.0 %
835	55.2	0.97	6.13	6.13	6.13	0.24	2.27	± 12.0 %
1640	53.8	1.40	5.21	5.21	5.21	0.72	1.29	± 12.0 %
1750	53.4	1.49	4.83	4.83	4.83	0.59	1.44	± 12.0 %
1900	53.3	1.52	4.63	4.63	4.63	0.57	1.50	± 12.0 %
2450	52.7	1.95	4.23	4.23	4.23	0.80	1.00	± 12.0 %
2600	52.5	2.16	4.02	4.02	4.02	0.62	0.90	± 12.0 %

<sup>C</sup> Frequency validity of ± 100 MHz only applies for DASY v4.4 and higher (see Page 2), else it is restricted to ± 50 MHz. The uncertainty is the RSS of the ConvF uncertainty at calibration frequency and the uncertainty for the indicated frequency band.

<sup>F</sup> At frequencies below 3 GHz, the validity of tissue parameters ( $\epsilon$  and  $\sigma$ ) can be relaxed to ± 10% if liquid compensation formula is applied to measured SAR values. At frequencies above 3 GHz, the validity of tissue parameters ( $\epsilon$  and  $\sigma$ ) is restricted to ± 5%. The uncertainty is the RSS of the ConvF uncertainty for indicated target tissue parameters.

# Frequency Response of E-Field

(TEM-Cell:ifi110 EXX, Waveguide: R22)

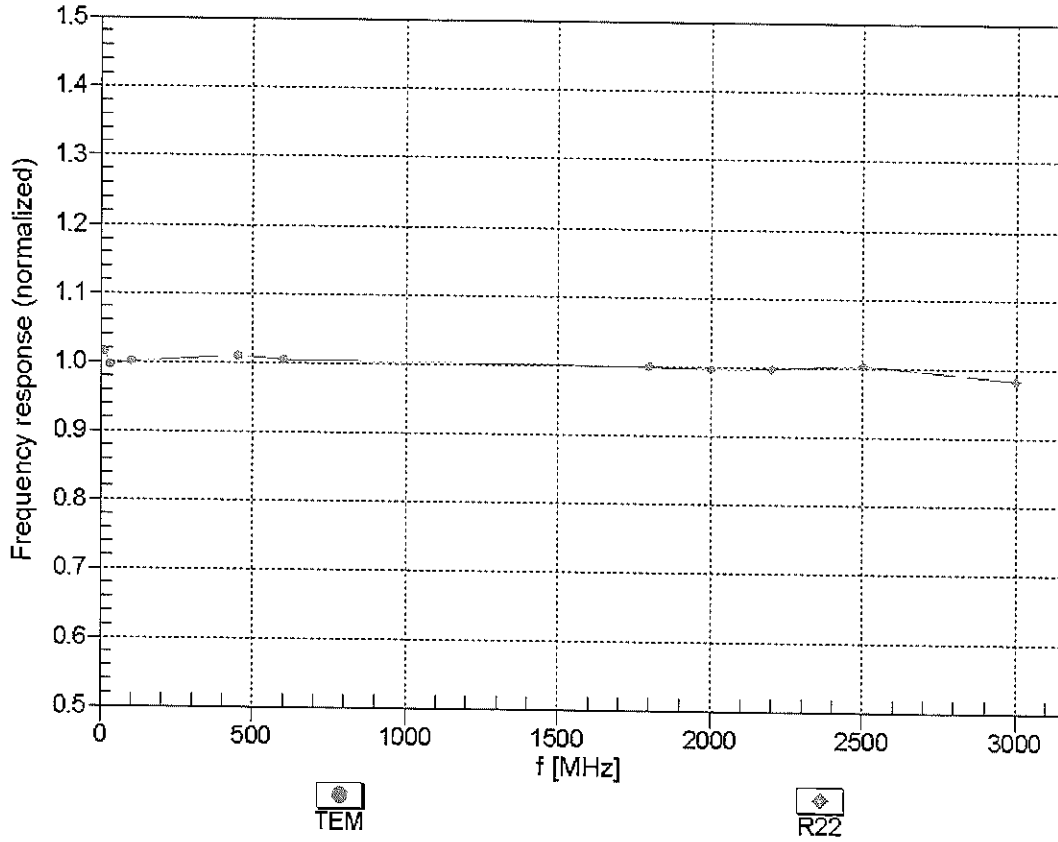

Uncertainty of Frequency Response of E-field:  $\pm 6.3\%$  ( $k=2$ )

## Receiving Pattern ( $\phi$ ), $\theta = 0^\circ$

f=600 MHz, TEM

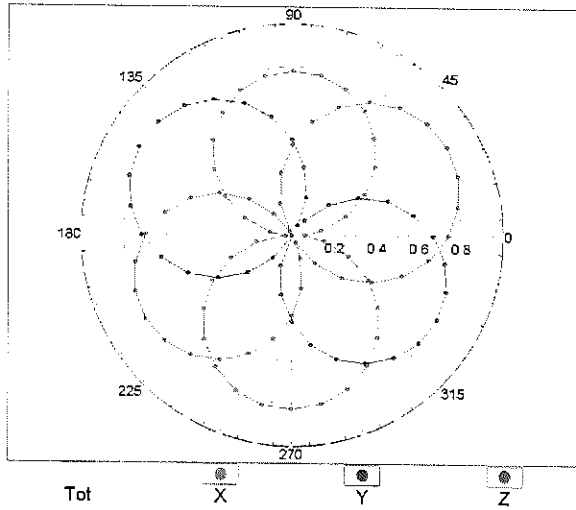

f=1800 MHz, R22

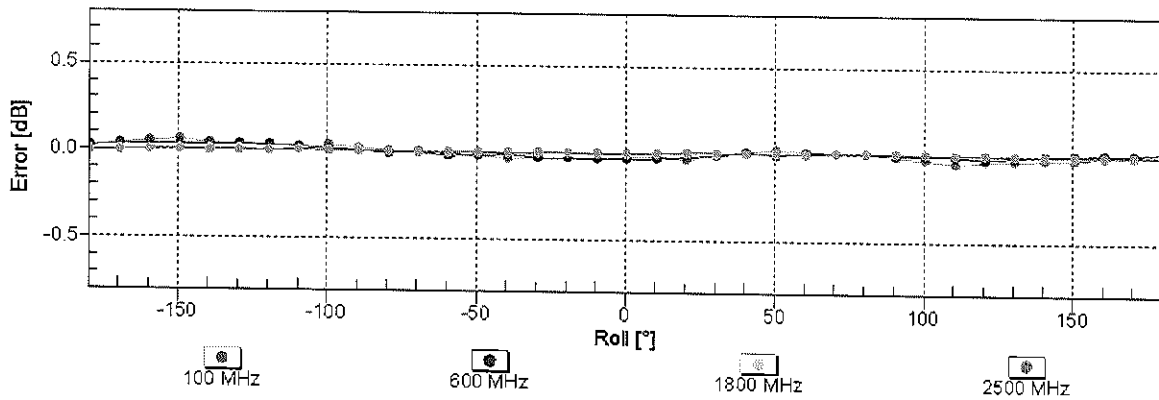
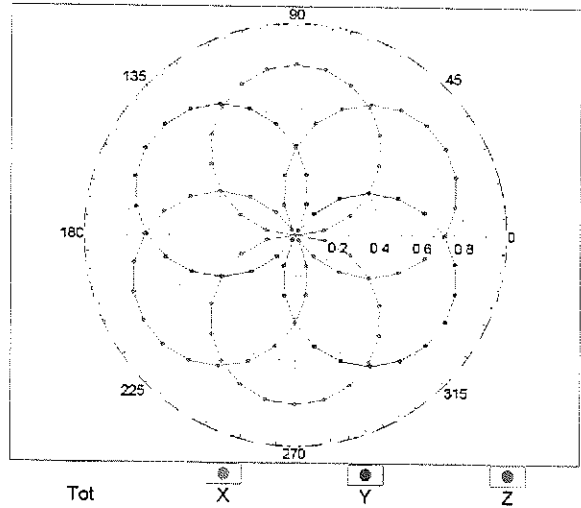

Uncertainty of Axial Isotropy Assessment:  $\pm 0.5\%$  (k=2)

## Dynamic Range f(SAR<sub>head</sub>) (TEM cell , f = 900 MHz)

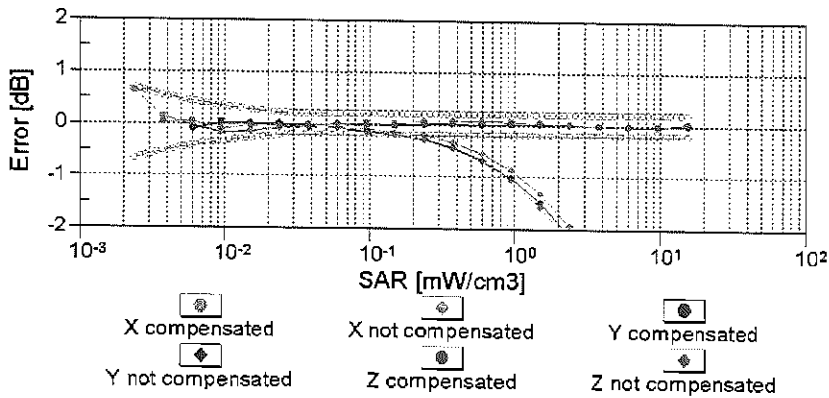
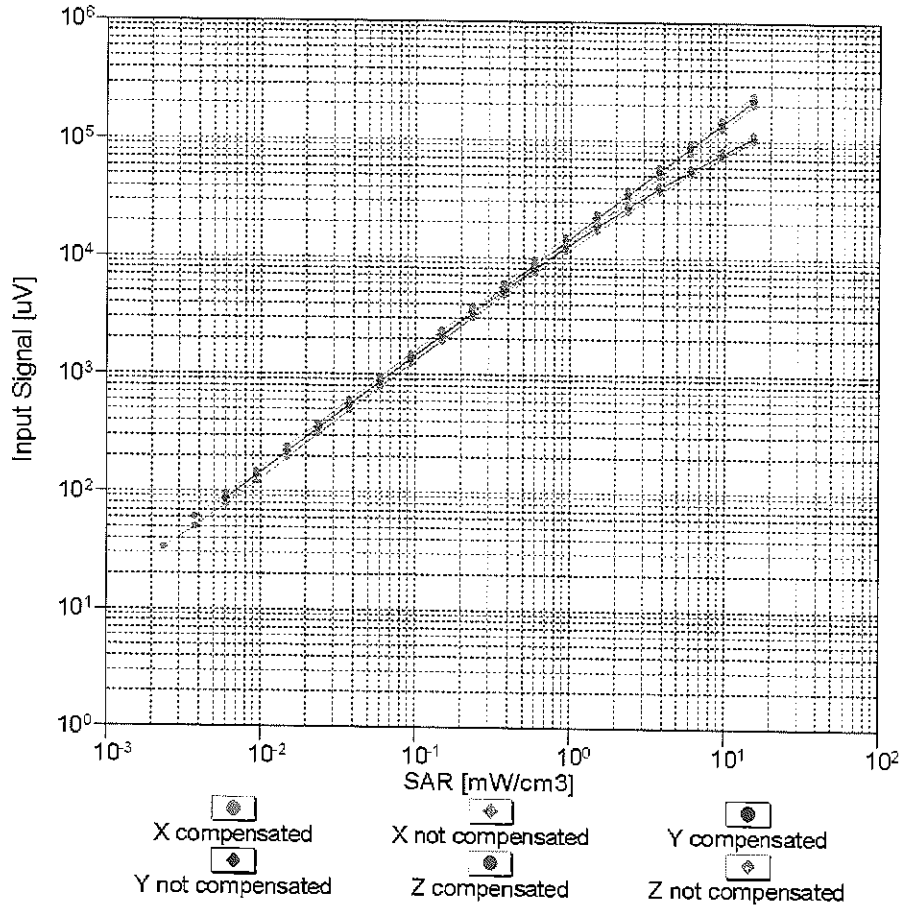

**Uncertainty of Linearity Assessment: ± 0.6% (k=2)**

# Conversion Factor Assessment

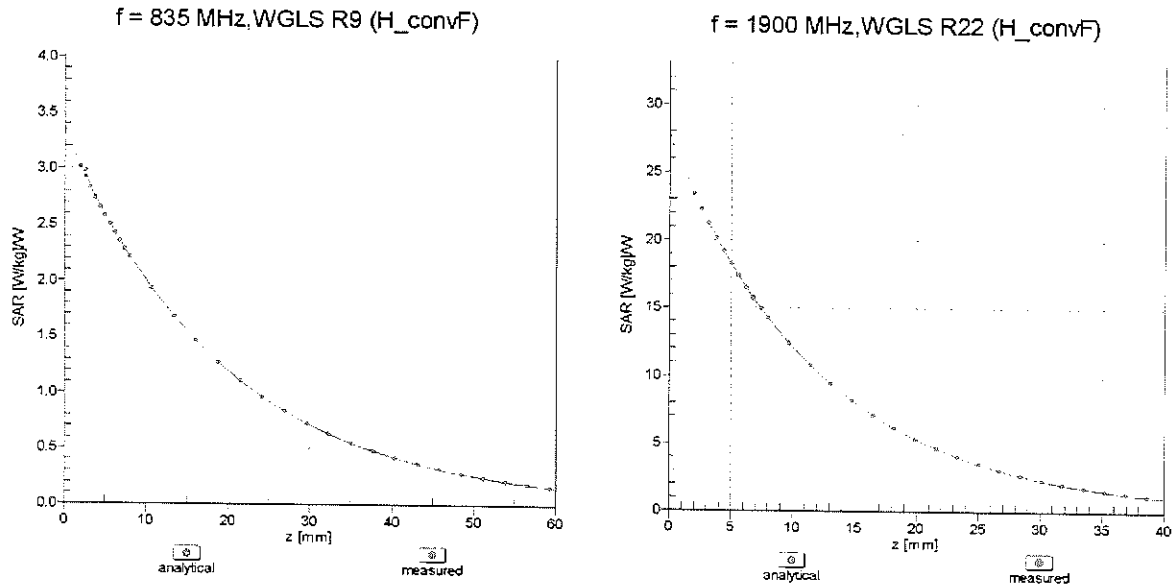

## Deviation from Isotropy in Liquid Error ( $\phi$ , $\theta$ ), f = 900 MHz

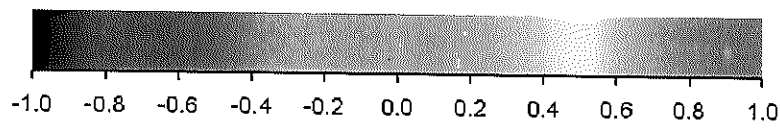
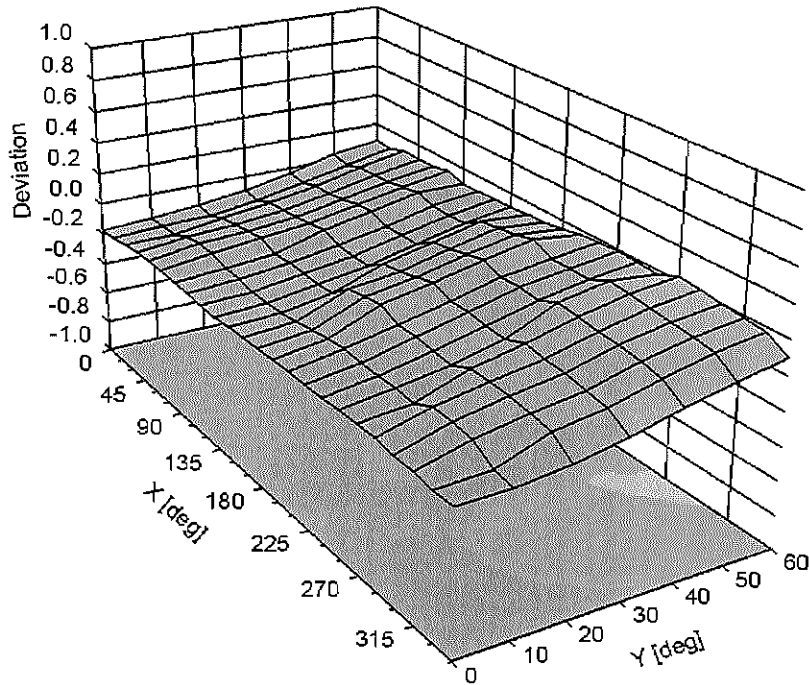

Uncertainty of Spherical Isotropy Assessment:  $\pm 2.6\%$  (k=2)

**DASY/EASY - Parameters of Probe: ES3DV3 - SN:3209****Other Probe Parameters**

Sensor Arrangement	Triangular
Connector Angle (°)	Not applicable
Mechanical Surface Detection Mode	enabled
Optical Surface Detection Mode	disabled
Probe Overall Length	337 mm
Probe Body Diameter	10 mm
Tip Length	10 mm
Tip Diameter	4 mm
Probe Tip to Sensor X Calibration Point	2 mm
Probe Tip to Sensor Y Calibration Point	2 mm
Probe Tip to Sensor Z Calibration Point	2 mm
Recommended Measurement Distance from Surface	3 mm



Accredited by the Swiss Accreditation Service (SAS)

Accreditation No.: **SCS 108**

The Swiss Accreditation Service is one of the signatories to the EA  
Multilateral Agreement for the recognition of calibration certificates

Client **PC Test**

Certificate No: **D2450V2-797\_Jan12**

## CALIBRATION CERTIFICATE

Object **D2450V2 - SN: 797**

Calibration procedure(s) **QA CAL-05 v8  
Calibration procedure for dipole validation kits above 700 MHz**

Calibration date: **January 24, 2012**

*✓ Kok  
2/6/2012*

This calibration certificate documents the traceability to national standards, which realize the physical units of measurements (SI).  
The measurements and the uncertainties with confidence probability are given on the following pages and are part of the certificate.

All calibrations have been conducted in the closed laboratory facility: environment temperature (22 ± 3)°C and humidity < 70%.

Calibration Equipment used (M&TE critical for calibration)

Primary Standards	ID #	Cal Date (Certificate No.)	Scheduled Calibration
Power meter EPM-442A	GB37480704	05-Oct-11 (No. 217-01451)	Oct-12
Power sensor HP 8481A	US37292783	05-Oct-11 (No. 217-01451)	Oct-12
Reference 20 dB Attenuator	SN: 5086 (20g)	29-Mar-11 (No. 217-01368)	Apr-12
Type-N mismatch combination	SN: 5047.2 / 06327	29-Mar-11 (No. 217-01371)	Apr-12
Reference Probe ES3DV3	SN: 3205	30-Dec-11 (No. ES3-3205_Dec11)	Dec-12
DAE4	SN: 601	04-Jul-11 (No. DAE4-601_Jul11)	Jul-12
Secondary Standards	ID #	Check Date (in house)	Scheduled Check
Power sensor HP 8481A	MY41092317	18-Oct-02 (in house check Oct-11)	In house check: Oct-13
RF generator R&S SMT-06	100005	04-Aug-99 (in house check Oct-11)	In house check: Oct-13
Network Analyzer HP 8753E	US37390585 S4206	18-Oct-01 (in house check Oct-11)	In house check: Oct-12

Calibrated by:	Name <b>Israe El-Naouq</b>	Function <b>Laboratory Technician</b>	Signature <i>Israe El-Naouq</i>
Approved by:	Name <b>Katja Pokovic</b>	Function <b>Technical Manager</b>	Signature <i>Katja Pokovic</i>

Issued: January 24, 2012

This calibration certificate shall not be reproduced except in full without written approval of the laboratory.



The Swiss Accreditation Service is one of the signatories to the EA  
Multilateral Agreement for the recognition of calibration certificates

### Glossary:

TSL	tissue simulating liquid
ConvF	sensitivity in TSL / NORM x,y,z
N/A	not applicable or not measured

### Calibration is Performed According to the Following Standards:

- IEEE Std 1528-2003, "IEEE Recommended Practice for Determining the Peak Spatial-Averaged Specific Absorption Rate (SAR) in the Human Head from Wireless Communications Devices: Measurement Techniques", December 2003
- IEC 62209-1, "Procedure to measure the Specific Absorption Rate (SAR) for hand-held devices used in close proximity to the ear (frequency range of 300 MHz to 3 GHz)", February 2005
- Federal Communications Commission Office of Engineering & Technology (FCC OET), "Evaluating Compliance with FCC Guidelines for Human Exposure to Radiofrequency Electromagnetic Fields; Additional Information for Evaluating Compliance of Mobile and Portable Devices with FCC Limits for Human Exposure to Radiofrequency Emissions", Supplement C (Edition 01-01) to Bulletin 65

### Additional Documentation:

- DASY4/5 System Handbook

### Methods Applied and Interpretation of Parameters:

- Measurement Conditions:** Further details are available from the Validation Report at the end of the certificate. All figures stated in the certificate are valid at the frequency indicated.
- Antenna Parameters with TSL:** The dipole is mounted with the spacer to position its feed point exactly below the center marking of the flat phantom section, with the arms oriented parallel to the body axis.
- Feed Point Impedance and Return Loss:** These parameters are measured with the dipole positioned under the liquid filled phantom. The impedance stated is transformed from the measurement at the SMA connector to the feed point. The Return Loss ensures low reflected power. No uncertainty required.
- Electrical Delay:** One-way delay between the SMA connector and the antenna feed point. No uncertainty required.
- SAR measured:** SAR measured at the stated antenna input power.
- SAR normalized:** SAR as measured, normalized to an input power of 1 W at the antenna connector.
- SAR for nominal TSL parameters:** The measured TSL parameters are used to calculate the nominal SAR result.

## Measurement Conditions

DASY system configuration, as far as not given on page 1.

DASY Version	DASY5	V52.8.0
Extrapolation	Advanced Extrapolation	
Phantom	Modular Flat Phantom	
Distance Dipole Center - TSL	10 mm	with Spacer
Zoom Scan Resolution	dx, dy, dz = 5 mm	
Frequency	2450 MHz ± 1 MHz	

## Head TSL parameters

The following parameters and calculations were applied.

	Temperature	Permittivity	Conductivity
Nominal Head TSL parameters	22.0 °C	39.2	1.80 mho/m
Measured Head TSL parameters	(22.0 ± 0.2) °C	39.2 ± 6 %	1.85 mho/m ± 6 %
Head TSL temperature change during test	< 0.5 °C	----	----

## SAR result with Head TSL

SAR averaged over 1 cm <sup>3</sup> (1 g) of Head TSL	Condition	
SAR measured	250 mW input power	13.2 mW / g
SAR for nominal Head TSL parameters	normalized to 1W	52.1 mW / g ± 17.0 % (k=2)

SAR averaged over 10 cm <sup>3</sup> (10 g) of Head TSL	condition	
SAR measured	250 mW input power	6.12 mW / g
SAR for nominal Head TSL parameters	normalized to 1W	24.3 mW / g ± 16.5 % (k=2)

## Body TSL parameters

The following parameters and calculations were applied.

	Temperature	Permittivity	Conductivity
Nominal Body TSL parameters	22.0 °C	52.7	1.95 mho/m
Measured Body TSL parameters	(22.0 ± 0.2) °C	50.6 ± 6 %	2.01 mho/m ± 6 %
Body TSL temperature change during test	< 0.5 °C	----	----

## SAR result with Body TSL

SAR averaged over 1 cm <sup>3</sup> (1 g) of Body TSL	Condition	
SAR measured	250 mW input power	13.0 mW / g
SAR for nominal Body TSL parameters	normalized to 1W	50.8 mW / g ± 17.0 % (k=2)

SAR averaged over 10 cm <sup>3</sup> (10 g) of Body TSL	condition	
SAR measured	250 mW input power	6.01 mW / g
SAR for nominal Body TSL parameters	normalized to 1W	23.7 mW / g ± 16.5 % (k=2)

## Appendix

### Antenna Parameters with Head TSL

Impedance, transformed to feed point	54.0 $\Omega$ + 4.7 j $\Omega$
Return Loss	- 24.6 dB

### Antenna Parameters with Body TSL

Impedance, transformed to feed point	50.1 $\Omega$ + 5.4 j $\Omega$
Return Loss	- 25.3 dB

### General Antenna Parameters and Design

Electrical Delay (one direction)	1.151 ns
----------------------------------	----------

After long term use with 100W radiated power, only a slight warming of the dipole near the feedpoint can be measured.

The dipole is made of standard semirigid coaxial cable. The center conductor of the feeding line is directly connected to the second arm of the dipole. The antenna is therefore short-circuited for DC-signals. On some of the dipoles, small end caps are added to the dipole arms in order to improve matching when loaded according to the position as explained in the "Measurement Conditions" paragraph. The SAR data are not affected by this change. The overall dipole length is still according to the Standard.

No excessive force must be applied to the dipole arms, because they might bend or the soldered connections near the feedpoint may be damaged.

### Additional EUT Data

Manufactured by	SPEAG
Manufactured on	January 24, 2006

## DASY5 Validation Report for Head TSL

Date: 24.01.2012

Test Laboratory: SPEAG, Zurich, Switzerland

**DUT: Dipole 2450 MHz; Type: D2450V2; Serial: D2450V2 - SN: 797**

---

Communication System: CW; Frequency: 2450 MHz

Medium parameters used:  $f = 2450$  MHz;  $\sigma = 1.85$  mho/m;  $\epsilon_r = 39.2$ ;  $\rho = 1000$  kg/m<sup>3</sup>

Phantom section: Flat Section

Measurement Standard: DASY5 (IEEE/IEC/ANSI C63.19-2007)

DASY52 Configuration:

- Probe: ES3DV3 - SN3205; ConvF(4.45, 4.45, 4.45); Calibrated: 30.12.2011
- Sensor-Surface: 3mm (Mechanical Surface Detection)
- Electronics: DAE4 Sn601; Calibrated: 04.07.2011
- Phantom: Flat Phantom 5.0 (front); Type: QD000P50AA; Serial: 1001
- DASY52 52.8.0(692); SEMCAD X 14.6.4(4989)

### Dipole Calibration for Head Tissue/Pin=250 mW, d=10mm/Zoom Scan (7x7x7)/Cube 0:

Measurement grid: dx=5mm, dy=5mm, dz=5mm

Reference Value = 99.248 V/m; Power Drift = 0.06 dB

Peak SAR (extrapolated) = 27.3550

**SAR(1 g) = 13.2 mW/g; SAR(10 g) = 6.12 mW/g**

Maximum value of SAR (measured) = 17.017 mW/g

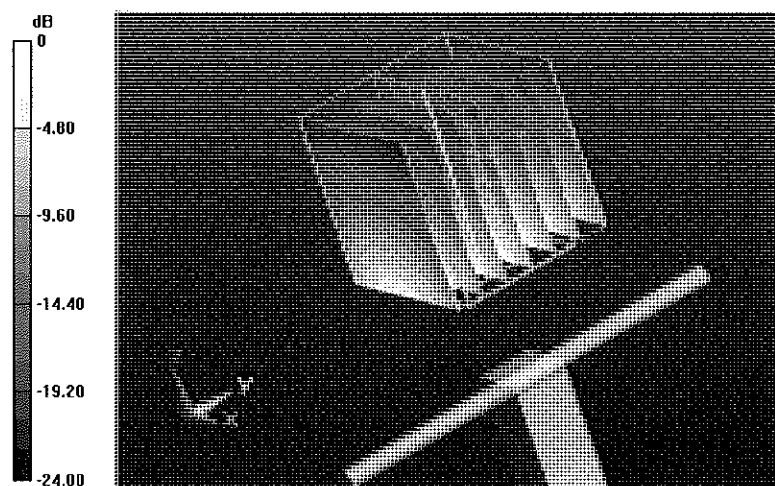

0 dB = 17.020mW/g = 24.62 dB mW/g

# Impedance Measurement Plot for Head TSL

24 Jan 2012 11:11:23

[CH1] S11 1 U FS 4:53.992 n 4:6563 n 382.40 pH 2 450.000 000 MHz

\*  
De1  
CA  
Avg  
16  
H1d

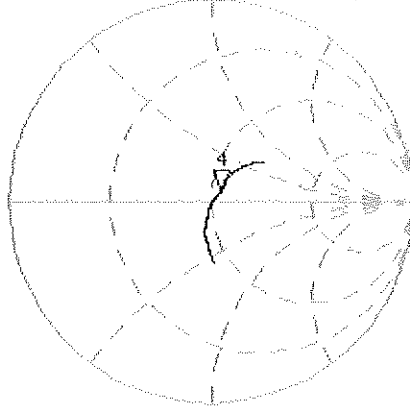

CH2 S11 LOG 5 dB/REF -20 dB 4:-24.593 dB 2 450.000 000 MHz

CA  
Avg  
16  
H1d

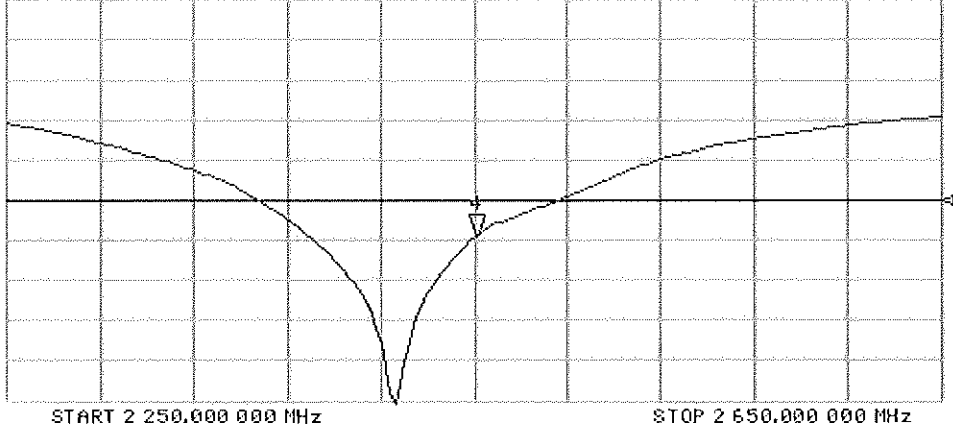

## DASY5 Validation Report for Body TSL

Date: 23.01.2012

Test Laboratory: SPEAG, Zurich, Switzerland

**DUT: Dipole 2450 MHz; Type: D2450V2; Serial: D2450V2 - SN: 797**

---

Communication System: CW; Frequency: 2450 MHz

Medium parameters used:  $f = 2450$  MHz;  $\sigma = 2.01$  mho/m;  $\epsilon_r = 50.6$ ;  $\rho = 1000$  kg/m<sup>3</sup>

Phantom section: Flat Section

Measurement Standard: DASY5 (IEEE/IEC/ANSI C63.19-2007)

DASY52 Configuration:

- Probe: ES3DV3 - SN3205; ConvF(4.26, 4.26, 4.26); Calibrated: 30.12.2011
- Sensor-Surface: 3mm (Mechanical Surface Detection)
- Electronics: DAE4 Sn601; Calibrated: 04.07.2011
- Phantom: Flat Phantom 5.0 (back); Type: QD000P50AA; Serial: 1002
- DASY52 52.8.0(692); SEMCAD X 14.6.4(4989)

### Dipole Calibration for Body Tissue/Pin=250 mW, d=10mm/Zoom Scan (7x7x7)/Cube 0:

Measurement grid: dx=5mm, dy=5mm, dz=5mm

Reference Value = 95.727 V/m; Power Drift = -0.03 dB

Peak SAR (extrapolated) = 26.9680

**SAR(1 g) = 13 mW/g; SAR(10 g) = 6.01 mW/g**

Maximum value of SAR (measured) = 17.222 mW/g

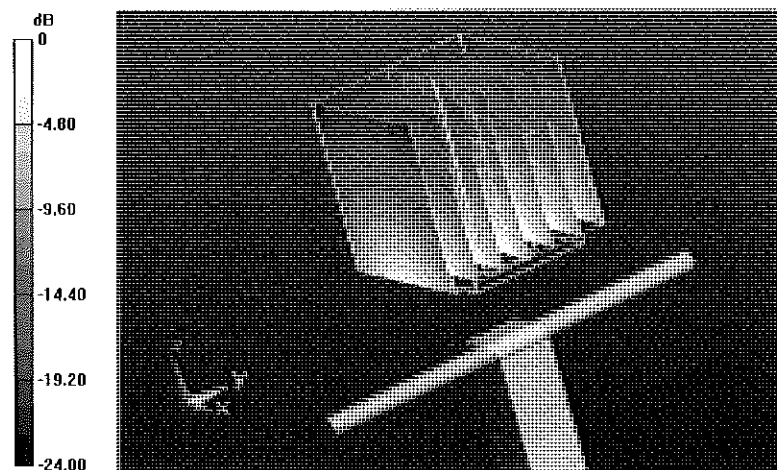

0 dB = 17.220mW/g = 24.72 dB mW/g

# Impedance Measurement Plot for Body TSL

23 Jan 2012 11:15:12

[G03] S11 1 U FS 3: 50.423 A 5.4316 A 352.05  $\mu$ H 2 450.000 000 MHz

\*  
De1  
CA

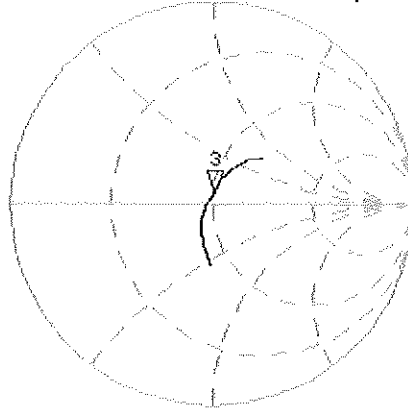

Avg  
16

H1d

CH2 S11 LOG 5 dB/REF -20 dB 3:-25.315 dB 2 450.000 000 MHz

CA

Avg  
16

H1d

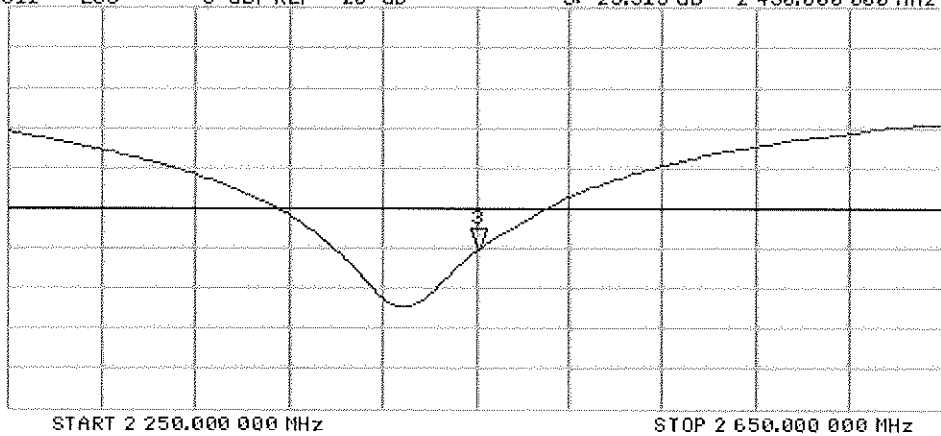



Accredited by the Swiss Accreditation Service (SAS)  
The Swiss Accreditation Service is one of the signatories to the EA  
Multilateral Agreement for the recognition of calibration certificates

Accreditation No.: **SCS 108**

Client **PC Test**

Certificate No: **D2450V2-882\_Feb12**

**CALIBRATION CERTIFICATE**

Object **D2450V2 - SN: 882**

Calibration procedure(s) **QA CAL-05.v8  
Calibration procedure for dipole validation kits above 700 MHz**

Calibration date: **February 07, 2012**

*OK  
4/6/12*

This calibration certificate documents the traceability to national standards, which realize the physical units of measurements (SI).  
The measurements and the uncertainties with confidence probability are given on the following pages and are part of the certificate.

All calibrations have been conducted in the closed laboratory facility: environment temperature (22 ± 3)°C and humidity < 70%.

Calibration Equipment used (M&TE critical for calibration)

Primary Standards	ID #	Cal Date (Certificate No.)	Scheduled Calibration
Power meter EPM-442A	GB37480704	05-Oct-11 (No. 217-01451)	Oct-12
Power sensor HP 8481A	US37292783	05-Oct-11 (No. 217-01451)	Oct-12
Reference 20 dB Attenuator	SN: 5086 (20g)	29-Mar-11 (No. 217-01368)	Apr-12
Type-N mismatch combination	SN: 5047.2 / 06327	29-Mar-11 (No. 217-01371)	Apr-12
Reference Probe ES3DV3	SN: 3205	30-Dec-11 (No. ES3-3205_Dec11)	Dec-12
DAE4	SN: 601	04-Jul-11 (No. DAE4-601_Jul11)	Jul-12
Secondary Standards	ID #	Check Date (in house)	Scheduled Check
Power sensor HP 8481A	MY41092317	18-Oct-02 (in house check Oct-11)	In house check: Oct-13
RF generator R&S SMT-06	100005	04-Aug-99 (in house check Oct-11)	In house check: Oct-13
Network Analyzer HP 8753E	US37390585 S4206	18-Oct-01 (in house check Oct-11)	In house check: Oct-12

Calibrated by: **Israe El-Naouq** (Name) / **Laboratory Technician** (Function) / *Israe El-Naouq* (Signature)

Approved by: **Katja Pokovic** (Name) / **Technical Manager** (Function) / *Katja Pokovic* (Signature)

Issued: February 15, 2012

This calibration certificate shall not be reproduced except in full without written approval of the laboratory.



Accredited by the Swiss Accreditation Service (SAS)  
The Swiss Accreditation Service is one of the signatories to the EA  
Multilateral Agreement for the recognition of calibration certificates

Accreditation No.: **SCS 108**

**Glossary:**

TSL	tissue simulating liquid
ConvF	sensitivity in TSL / NORM x,y,z
N/A	not applicable or not measured

**Calibration is Performed According to the Following Standards:**

- a) IEEE Std 1528-2003, "IEEE Recommended Practice for Determining the Peak Spatial-Averaged Specific Absorption Rate (SAR) in the Human Head from Wireless Communications Devices: Measurement Techniques", December 2003
- b) IEC 62209-1, "Procedure to measure the Specific Absorption Rate (SAR) for hand-held devices used in close proximity to the ear (frequency range of 300 MHz to 3 GHz)", February 2005
- c) Federal Communications Commission Office of Engineering & Technology (FCC OET), "Evaluating Compliance with FCC Guidelines for Human Exposure to Radiofrequency Electromagnetic Fields; Additional Information for Evaluating Compliance of Mobile and Portable Devices with FCC Limits for Human Exposure to Radiofrequency Emissions", Supplement C (Edition 01-01) to Bulletin 65

**Additional Documentation:**

- d) DASY4/5 System Handbook

**Methods Applied and Interpretation of Parameters:**

- *Measurement Conditions:* Further details are available from the Validation Report at the end of the certificate. All figures stated in the certificate are valid at the frequency indicated.
- *Antenna Parameters with TSL:* The dipole is mounted with the spacer to position its feed point exactly below the center marking of the flat phantom section, with the arms oriented parallel to the body axis.
- *Feed Point Impedance and Return Loss:* These parameters are measured with the dipole positioned under the liquid filled phantom. The impedance stated is transformed from the measurement at the SMA connector to the feed point. The Return Loss ensures low reflected power. No uncertainty required.
- *Electrical Delay:* One-way delay between the SMA connector and the antenna feed point. No uncertainty required.
- *SAR measured:* SAR measured at the stated antenna input power.
- *SAR normalized:* SAR as measured, normalized to an input power of 1 W at the antenna connector.
- *SAR for nominal TSL parameters:* The measured TSL parameters are used to calculate the nominal SAR result.

## Measurement Conditions

DASY system configuration, as far as not given on page 1.

<b>DASY Version</b>	DASY5	V52.8.0
<b>Extrapolation</b>	Advanced Extrapolation	
<b>Phantom</b>	Modular Flat Phantom	
<b>Distance Dipole Center - TSL</b>	10 mm	with Spacer
<b>Zoom Scan Resolution</b>	dx, dy, dz = 5 mm	
<b>Frequency</b>	2450 MHz $\pm$ 1 MHz	

## Head TSL parameters

The following parameters and calculations were applied.

	Temperature	Permittivity	Conductivity
<b>Nominal Head TSL parameters</b>	22.0 °C	39.2	1.80 mho/m
<b>Measured Head TSL parameters</b>	(22.0 $\pm$ 0.2) °C	38.9 $\pm$ 6 %	1.86 mho/m $\pm$ 6 %
<b>Head TSL temperature change during test</b>	< 0.5 °C	----	----

## SAR result with Head TSL

<b>SAR averaged over 1 cm<sup>3</sup> (1 g) of Head TSL</b>	Condition	
SAR measured	250 mW input power	13.6 mW / g
SAR for nominal Head TSL parameters	normalized to 1W	<b>53.5 mW / g <math>\pm</math> 17.0 % (k=2)</b>

<b>SAR averaged over 10 cm<sup>3</sup> (10 g) of Head TSL</b>	condition	
SAR measured	250 mW input power	6.27 mW / g
SAR for nominal Head TSL parameters	normalized to 1W	<b>24.8 mW / g <math>\pm</math> 16.5 % (k=2)</b>

## Body TSL parameters

The following parameters and calculations were applied.

	Temperature	Permittivity	Conductivity
<b>Nominal Body TSL parameters</b>	22.0 °C	52.7	1.95 mho/m
<b>Measured Body TSL parameters</b>	(22.0 $\pm$ 0.2) °C	52.3 $\pm$ 6 %	2.02 mho/m $\pm$ 6 %
<b>Body TSL temperature change during test</b>	< 0.5 °C	----	----

## SAR result with Body TSL

<b>SAR averaged over 1 cm<sup>3</sup> (1 g) of Body TSL</b>	Condition	
SAR measured	250 mW input power	12.8 mW / g
SAR for nominal Body TSL parameters	normalized to 1W	<b>50.3 mW / g <math>\pm</math> 17.0 % (k=2)</b>

<b>SAR averaged over 10 cm<sup>3</sup> (10 g) of Body TSL</b>	condition	
SAR measured	250 mW input power	5.94 mW / g
SAR for nominal Body TSL parameters	normalized to 1W	<b>23.5 mW / g <math>\pm</math> 16.5 % (k=2)</b>

## Appendix

### Antenna Parameters with Head TSL

Impedance, transformed to feed point	$53.7 \Omega + 1.1 j\Omega$
Return Loss	- 28.6 dB

### Antenna Parameters with Body TSL

Impedance, transformed to feed point	$51.0 \Omega + 3.2 j\Omega$
Return Loss	- 29.7 dB

### General Antenna Parameters and Design

Electrical Delay (one direction)	1.156 ns
----------------------------------	----------

After long term use with 100W radiated power, only a slight warming of the dipole near the feedpoint can be measured.

The dipole is made of standard semirigid coaxial cable. The center conductor of the feeding line is directly connected to the second arm of the dipole. The antenna is therefore short-circuited for DC-signals. On some of the dipoles, small end caps are added to the dipole arms in order to improve matching when loaded according to the position as explained in the "Measurement Conditions" paragraph. The SAR data are not affected by this change. The overall dipole length is still according to the Standard.

No excessive force must be applied to the dipole arms, because they might bend or the soldered connections near the feedpoint may be damaged.

### Additional EUT Data

Manufactured by	SPEAG
Manufactured on	October 06, 2011

## DASY5 Validation Report for Head TSL

Date: 07.02.2012

Test Laboratory: SPEAG, Zurich, Switzerland

**DUT: Dipole 2450 MHz; Type: D2450V2; Serial: D2450V2 - SN: 882**

Communication System: CW; Frequency: 2450 MHz

Medium parameters used:  $f = 2450$  MHz;  $\sigma = 1.86$  mho/m;  $\epsilon_r = 38.9$ ;  $\rho = 1000$  kg/m<sup>3</sup>

Phantom section: Flat Section

Measurement Standard: DASY5 (IEEE/IEC/ANSI C63.19-2007)

DASY52 Configuration:

- Probe: ES3DV3 - SN3205; ConvF(4.45, 4.45, 4.45); Calibrated: 30.12.2011
- Sensor-Surface: 3mm (Mechanical Surface Detection)
- Electronics: DAE4 Sn601; Calibrated: 04.07.2011
- Phantom: Flat Phantom 5.0 (front); Type: QD000P50AA; Serial: 1001
- DASY52 52.8.0(692); SEMCAD X 14.6.4(4989)

### Dipole Calibration for Head Tissue/Pin=250 mW, d=10mm/Zoom Scan (7x7x7)/Cube 0:

Measurement grid: dx=5mm, dy=5mm, dz=5mm

Reference Value = 100.8 V/m; Power Drift = 0.05 dB

Peak SAR (extrapolated) = 28.3920

**SAR(1 g) = 13.6 mW/g; SAR(10 g) = 6.27 mW/g**

Maximum value of SAR (measured) = 17.598 mW/g

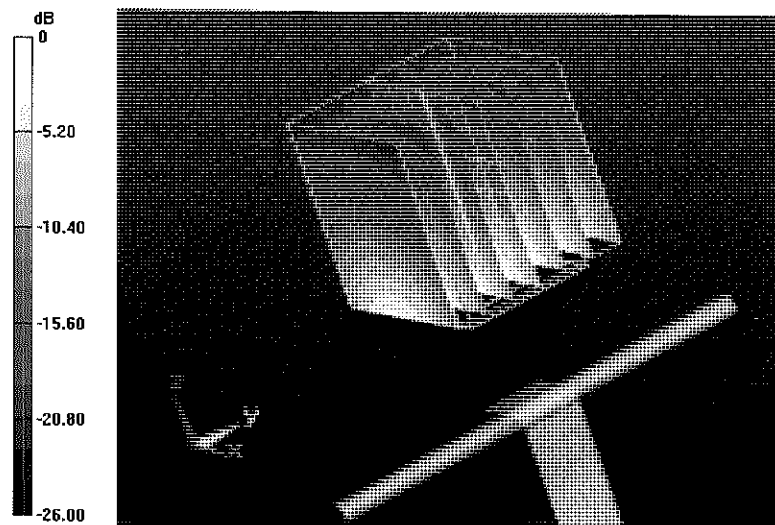

0 dB = 17.600mW/g = 24.91 dB mW/g

# Impedance Measurement Plot for Head TSL

7 Feb 2012 11:30:04

CH1 S11 1 U FS 2: 53.674  $\Omega$  1.0918  $\Omega$  70.924  $\mu\text{H}$  2 450.000 000 MHz

\*  
De1

Ca

Avg  
15

H1 d

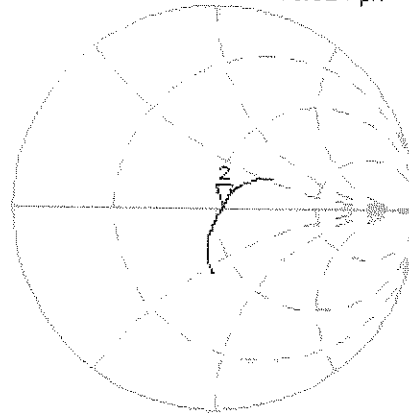

CH2 S11 LOG 5 dB/REF -20 dB 2:-28.637 dB 2 450.000 000 MHz

Ca

Avg  
15

H1 d

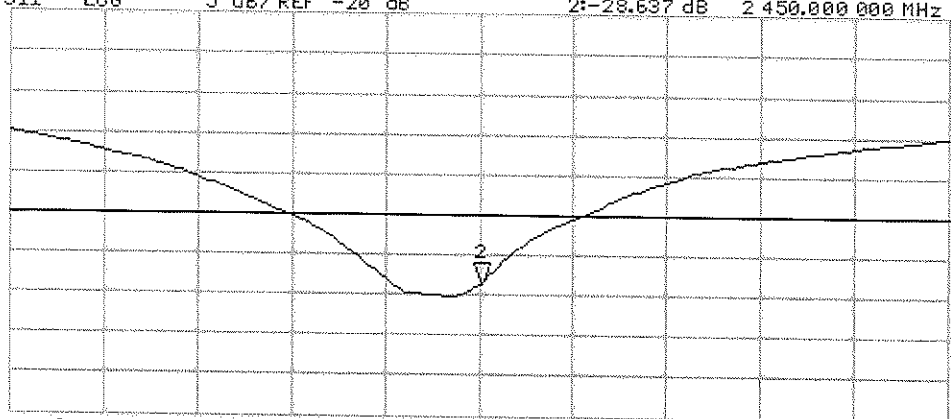

START 2 250.000 000 MHz

STOP 2 650.000 000 MHz

# DASY5 Validation Report for Body TSL

Date: 07.02.2012

Test Laboratory: SPEAG, Zurich, Switzerland

**DUT: Dipole 2450 MHz; Type: D2450V2; Serial: D2450V2 - SN: 882**

Communication System: CW; Frequency: 2450 MHz

Medium parameters used:  $f = 2450$  MHz;  $\sigma = 2.02$  mho/m;  $\epsilon_r = 52.3$ ;  $\rho = 1000$  kg/m<sup>3</sup>

Phantom section: Flat Section

Measurement Standard: DASY5 (IEEE/IEC/ANSI C63.19-2007)

DASY52 Configuration:

- Probe: ES3DV3 - SN3205; ConvF(4.26, 4.26, 4.26); Calibrated: 30.12.2011
- Sensor-Surface: 3mm (Mechanical Surface Detection)
- Electronics: DAE4 Sn601; Calibrated: 04.07.2011
- Phantom: Flat Phantom 5.0 (back); Type: QD000P50AA; Serial: 1002
- DASY52 52.8.0(692); SEMCAD X 14.6.4(4989)

## Dipole Calibration for Body Tissue/Pin=250 mW, d=10mm/Zoom Scan (7x7x7)/Cube 0:

Measurement grid: dx=5mm, dy=5mm, dz=5mm

Reference Value = 94.959 V/m; Power Drift = 0.0036 dB

Peak SAR (extrapolated) = 26.2610

**SAR(1 g) = 12.8 mW/g; SAR(10 g) = 5.94 mW/g**

Maximum value of SAR (measured) = 16.899 mW/g

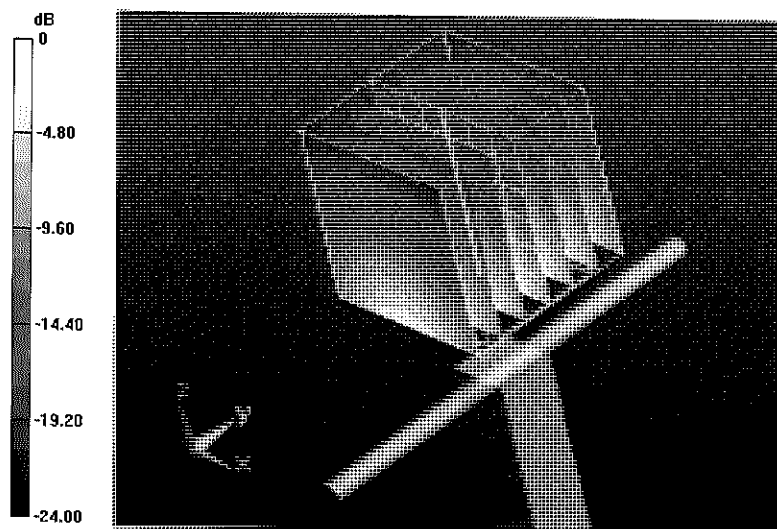

0 dB = 16.900mW/g = 24.56 dB mW/g

# Impedance Measurement Plot for Body TSL

7 Feb 2012 11:28:39

CH1 S11 1 U FS 2: 50.982  $\Omega$  3.1689  $\Omega$  205.79  $\mu\text{H}$  2 450.000 000 MHz

\*  
De1  
Ca  
Avg  
15  
H1 d

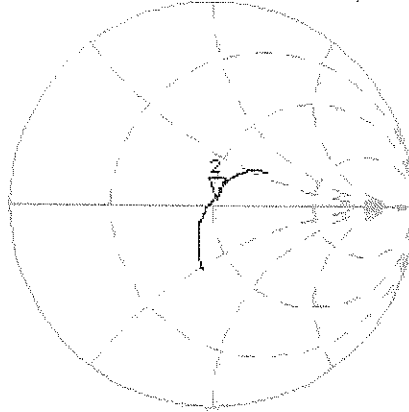

CH2 S11 LOG 5 dB/REF -20 dB 2: -29.682 dB 2 450.000 000 MHz

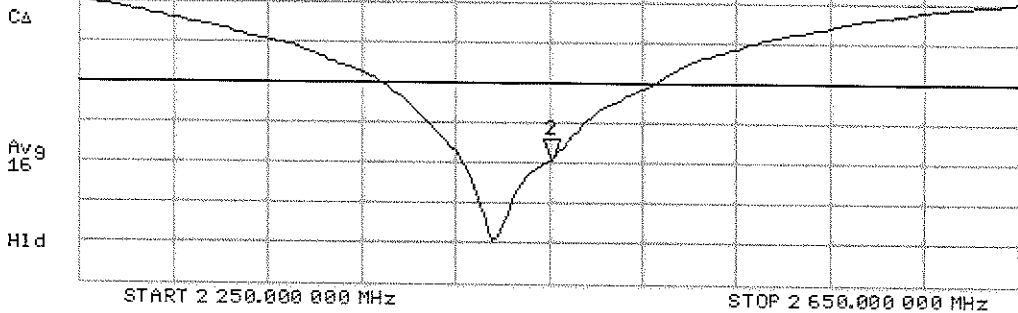



Accredited by the Swiss Accreditation Service (SAS)

Accreditation No.: **SCS 108**

The Swiss Accreditation Service is one of the signatories to the EA  
Multilateral Agreement for the recognition of calibration certificates

Client **PC Test**

Certificate No: **D1900V2-502\_Feb12**

## CALIBRATION CERTIFICATE

Object **D1900V2 - SN: 502**

Calibration procedure(s) **QA CAL-05.v8  
Calibration procedure for dipole validation kits above 700 MHz**

Calibration date: **February 22, 2012**

*KOK  
2/27/12*

This calibration certificate documents the traceability to national standards, which realize the physical units of measurements (SI).  
The measurements and the uncertainties with confidence probability are given on the following pages and are part of the certificate.

All calibrations have been conducted in the closed laboratory facility: environment temperature (22 ± 3)°C and humidity < 70%.

Calibration Equipment used (M&TE critical for calibration)

Primary Standards	ID #	Cal Date (Certificate No.)	Scheduled Calibration
Power meter EPM-442A	GB37480704	05-Oct-11 (No. 217-01451)	Oct-12
Power sensor HP 8481A	US37292783	05-Oct-11 (No. 217-01451)	Oct-12
Reference 20 dB Attenuator	SN: 5086 (20g)	29-Mar-11 (No. 217-01368)	Apr-12
Type-N mismatch combination	SN: 5047.2 / 06327	29-Mar-11 (No. 217-01371)	Apr-12
Reference Probe ES3DV3	SN: 3205	30-Dec-11 (No. ES3-3205_Dec11)	Dec-12
DAE4	SN: 601	04-Jul-11 (No. DAE4-601_Jul11)	Jul-12
Secondary Standards	ID #	Check Date (in house)	Scheduled Check
Power sensor HP 8481A	MY41092317	18-Oct-02 (in house check Oct-11)	In house check: Oct-13
RF generator R&S SMT-06	100005	04-Aug-99 (in house check Oct-11)	In house check: Oct-13
Network Analyzer HP 8753E	US37390585 S4206	18-Oct-01 (in house check Oct-11)	In house check: Oct-12

Calibrated by:	Name <b>Israe El-Naouq</b>	Function <b>Laboratory Technician</b>	Signature 
Approved by:	Name <b>Katja Pokovic</b>	Function <b>Technical Manager</b>	

Issued: February 22, 2012

This calibration certificate shall not be reproduced except in full without written approval of the laboratory.



Accredited by the Swiss Accreditation Service (SAS)

Accreditation No.: **SCS 108**

The Swiss Accreditation Service is one of the signatories to the EA  
Multilateral Agreement for the recognition of calibration certificates

### Glossary:

TSL	tissue simulating liquid
ConvF	sensitivity in TSL / NORM x,y,z
N/A	not applicable or not measured

### Calibration is Performed According to the Following Standards:

- IEEE Std 1528-2003, "IEEE Recommended Practice for Determining the Peak Spatial-Averaged Specific Absorption Rate (SAR) in the Human Head from Wireless Communications Devices: Measurement Techniques", December 2003
- IEC 62209-1, "Procedure to measure the Specific Absorption Rate (SAR) for hand-held devices used in close proximity to the ear (frequency range of 300 MHz to 3 GHz)", February 2005
- Federal Communications Commission Office of Engineering & Technology (FCC OET), "Evaluating Compliance with FCC Guidelines for Human Exposure to Radiofrequency Electromagnetic Fields; Additional Information for Evaluating Compliance of Mobile and Portable Devices with FCC Limits for Human Exposure to Radiofrequency Emissions", Supplement C (Edition 01-01) to Bulletin 65

### Additional Documentation:

- DASY4/5 System Handbook

### Methods Applied and Interpretation of Parameters:

- Measurement Conditions:** Further details are available from the Validation Report at the end of the certificate. All figures stated in the certificate are valid at the frequency indicated.
- Antenna Parameters with TSL:** The dipole is mounted with the spacer to position its feed point exactly below the center marking of the flat phantom section, with the arms oriented parallel to the body axis.
- Feed Point Impedance and Return Loss:** These parameters are measured with the dipole positioned under the liquid filled phantom. The impedance stated is transformed from the measurement at the SMA connector to the feed point. The Return Loss ensures low reflected power. No uncertainty required.
- Electrical Delay:** One-way delay between the SMA connector and the antenna feed point. No uncertainty required.
- SAR measured:** SAR measured at the stated antenna input power.
- SAR normalized:** SAR as measured, normalized to an input power of 1 W at the antenna connector.
- SAR for nominal TSL parameters:** The measured TSL parameters are used to calculate the nominal SAR result.

## Measurement Conditions

DASY system configuration, as far as not given on page 1.

DASY Version	DASY5	V52.8.0
Extrapolation	Advanced Extrapolation	
Phantom	Modular Flat Phantom	
Distance Dipole Center - TSL	10 mm	with Spacer
Zoom Scan Resolution	dx, dy, dz = 5 mm	
Frequency	1900 MHz $\pm$ 1 MHz	

## Head TSL parameters

The following parameters and calculations were applied.

	Temperature	Permittivity	Conductivity
Nominal Head TSL parameters	22.0 °C	40.0	1.40 mho/m
Measured Head TSL parameters	(22.0 $\pm$ 0.2) °C	40.4 $\pm$ 6 %	1.40 mho/m $\pm$ 6 %
Head TSL temperature change during test	< 0.5 °C	----	----

## SAR result with Head TSL

SAR averaged over 1 cm <sup>3</sup> (1 g) of Head TSL	Condition	
SAR measured	250 mW input power	9.79 mW / g
SAR for nominal Head TSL parameters	normalized to 1W	<b>39.2 mW / g <math>\pm</math> 17.0 % (k=2)</b>

SAR averaged over 10 cm <sup>3</sup> (10 g) of Head TSL	condition	
SAR measured	250 mW input power	5.17 mW / g
SAR for nominal Head TSL parameters	normalized to 1W	<b>20.7 mW / g <math>\pm</math> 16.5 % (k=2)</b>

## Body TSL parameters

The following parameters and calculations were applied.

	Temperature	Permittivity	Conductivity
Nominal Body TSL parameters	22.0 °C	53.3	1.52 mho/m
Measured Body TSL parameters	(22.0 $\pm$ 0.2) °C	53.0 $\pm$ 6 %	1.56 mho/m $\pm$ 6 %
Body TSL temperature change during test	< 0.5 °C	----	----

## SAR result with Body TSL

SAR averaged over 1 cm <sup>3</sup> (1 g) of Body TSL	Condition	
SAR measured	250 mW input power	9.88 mW / g
SAR for nominal Body TSL parameters	normalized to 1W	<b>38.9 mW / g <math>\pm</math> 17.0 % (k=2)</b>

SAR averaged over 10 cm <sup>3</sup> (10 g) of Body TSL	condition	
SAR measured	250 mW input power	5.17 mW / g
SAR for nominal Body TSL parameters	normalized to 1W	<b>20.5 mW / g <math>\pm</math> 16.5 % (k=2)</b>

## Appendix

### Antenna Parameters with Head TSL

Impedance, transformed to feed point	51.7 $\Omega$ + 7.2 j $\Omega$
Return Loss	- 22.8 dB

### Antenna Parameters with Body TSL

Impedance, transformed to feed point	47.2 $\Omega$ + 7.6 j $\Omega$
Return Loss	- 21.6 dB

### General Antenna Parameters and Design

Electrical Delay (one direction)	1.206 ns
----------------------------------	----------

After long term use with 100W radiated power, only a slight warming of the dipole near the feedpoint can be measured.

The dipole is made of standard semirigid coaxial cable. The center conductor of the feeding line is directly connected to the second arm of the dipole. The antenna is therefore short-circuited for DC-signals. On some of the dipoles, small end caps are added to the dipole arms in order to improve matching when loaded according to the position as explained in the "Measurement Conditions" paragraph. The SAR data are not affected by this change. The overall dipole length is still according to the Standard.

No excessive force must be applied to the dipole arms, because they might bend or the soldered connections near the feedpoint may be damaged.

### Additional EUT Data

Manufactured by	SPEAG
Manufactured on	November 14, 1998

## DASY5 Validation Report for Head TSL

Date: 22.02.2012

Test Laboratory: SPEAG, Zurich, Switzerland

**DUT: Dipole 1900 MHz; Type: D1900V2; Serial: D1900V2 - SN: 502**

---

Communication System: CW; Frequency: 1900 MHz

Medium parameters used:  $f = 1900$  MHz;  $\sigma = 1.4$  mho/m;  $\epsilon_r = 40.4$ ;  $\rho = 1000$  kg/m<sup>3</sup>

Phantom section: Flat Section

Measurement Standard: DASY5 (IEEE/IEC/ANSI C63.19-2007)

DASY52 Configuration:

- Probe: ES3DV3 - SN3205; ConvF(5.01, 5.01, 5.01); Calibrated: 30.12.2011
- Sensor-Surface: 3mm (Mechanical Surface Detection)
- Electronics: DAE4 Sn601; Calibrated: 04.07.2011
- Phantom: Flat Phantom 5.0 (front); Type: QD000P50AA; Serial: 1001
- DASY52 52.8.0(692); SEMCAD X 14.6.4(4989)

### Dipole Calibration for Head Tissue/Pin=250 mW, d=10mm/Zoom Scan (7x7x7)/Cube 0:

Measurement grid: dx=5mm, dy=5mm, dz=5mm

Reference Value = 96.315 V/m; Power Drift = 0.03 dB

Peak SAR (extrapolated) = 17.4000

**SAR(1 g) = 9.79 mW/g; SAR(10 g) = 5.17 mW/g**

Maximum value of SAR (measured) = 12.015 mW/g

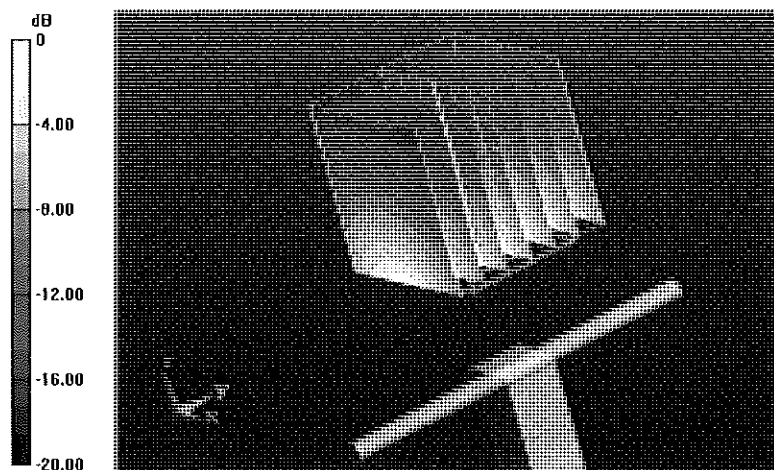

0 dB = 12.020mW/g = 21.60 dB mW/g

# Impedance Measurement Plot for Head TSL

22 Feb 2012 09:44:49

CH1 S11 1 U FS 2: 51.697  $\Omega$  7.1936  $\Omega$  601.74  $\mu$ H 1 900.000 000 MHz

\*  
De1  
Cor  
Avg  
9  
H1d

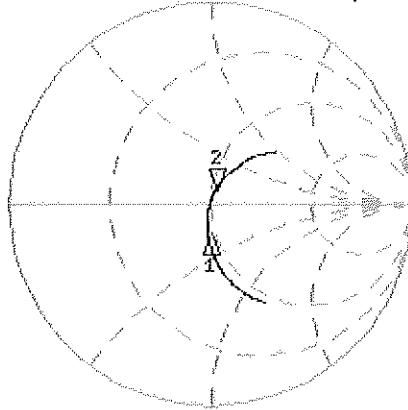

CH1 Markers  
1: 46.764  $\Omega$   
-14.023  $\Omega$   
1.80000 GHz

CH2 S11 LOG 5 dB/REF -20 dB 2:-22.806 dB 1 900.000 000 MHz

Cor  
Avg  
9  
H1d

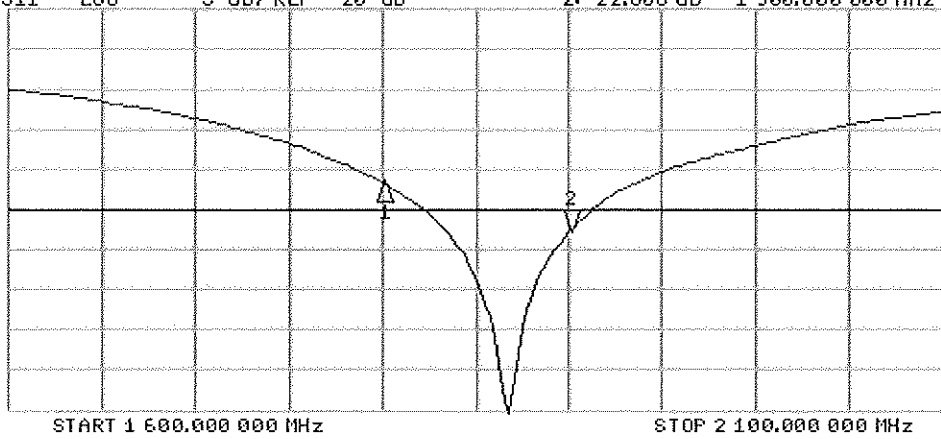

CH2 Markers  
1:-16.642 dB  
1.80000 GHz

## DASY5 Validation Report for Body TSL

Date: 22.02.2012

Test Laboratory: SPEAG, Zurich, Switzerland

**DUT: Dipole 1900 MHz; Type: D1900V2; Serial: D1900V2 - SN: 502**

---

Communication System: CW; Frequency: 1900 MHz

Medium parameters used:  $f = 1900$  MHz;  $\sigma = 1.56$  mho/m;  $\epsilon_r = 53$ ;  $\rho = 1000$  kg/m<sup>3</sup>

Phantom section: Flat Section

Measurement Standard: DASY5 (IEEE/IEC/ANSI C63.19-2007)

DASY52 Configuration:

- Probe: ES3DV3 - SN3205; ConvF(4.62, 4.62, 4.62); Calibrated: 30.12.2011
- Sensor-Surface: 3mm (Mechanical Surface Detection)
- Electronics: DAE4 Sn601; Calibrated: 04.07.2011
- Phantom: Flat Phantom 5.0 (back); Type: QD000P50AA; Serial: 1002
- DASY52 52.8.0(692); SEMCAD X 14.6.4(4989)

### Dipole Calibration for Body Tissue/Pin=250 mW, d=10mm/Zoom Scan (7x7x7)/Cube 0:

Measurement grid: dx=5mm, dy=5mm, dz=5mm

Reference Value = 93.607 V/m; Power Drift = 0.0093 dB

Peak SAR (extrapolated) = 17.4260

**SAR(1 g) = 9.88 mW/g; SAR(10 g) = 5.17 mW/g**

Maximum value of SAR (measured) = 12.532 mW/g

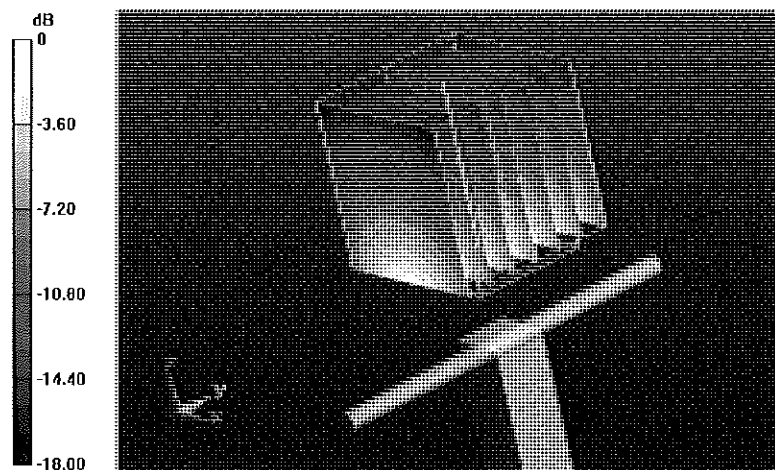

0 dB = 12.530mW/g = 21.96 dB mW/g

# Impedance Measurement Plot for Body TSL

22 Feb 2012 09:44:23

[CH1] S11 1 U FS 2: 47.184  $\Omega$  2: 6.133  $\Omega$  -637.73  $\mu$ H 1 900.000 000 MHz

\*  
Del  
Cor  
Avg  
16  
H1d

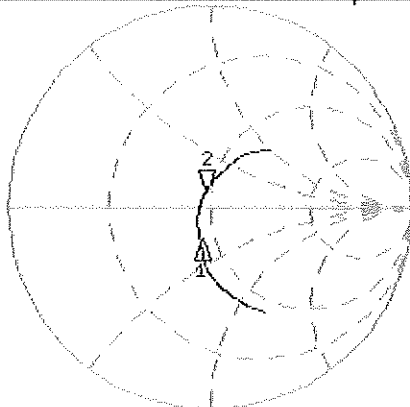

CH1 Markers  
1: 43.225  $\Omega$   
-14.492  $\Omega$   
1.80000 GHz

CH2 S11 LOG 5 dB/REF -20 dB 2: -21.590 dB 1 900.000 000 MHz

Cor  
Avg  
16  
H1d

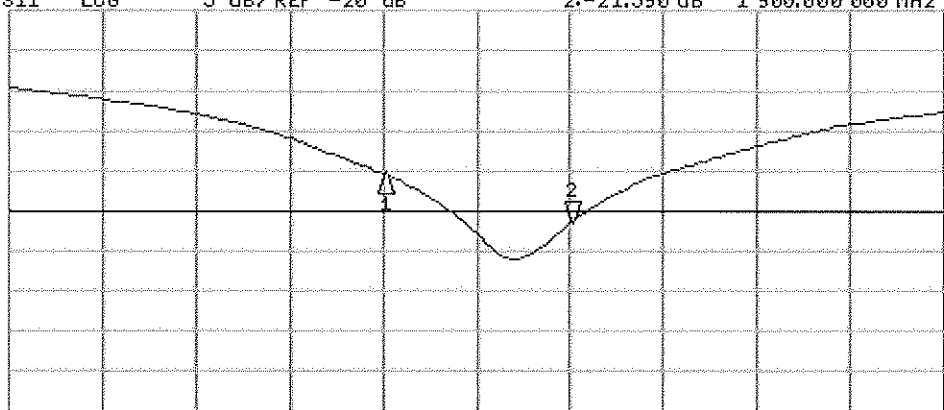

CH2 Markers  
1: -15.413 dB  
1.80000 GHz

START 1 600.000 000 MHz

STOP 2 100.000 000 MHz



Accredited by the Swiss Accreditation Service (SAS)  
The Swiss Accreditation Service is one of the signatories to the EA  
Multilateral Agreement for the recognition of calibration certificates

Accreditation No.: **SCS 108**

Client **PC Test**

Certificate No: **D1900V2-5d149\_Feb12**

**CALIBRATION CERTIFICATE**

Object **D1900V2 - SN: 5d149**

Calibration procedure(s) **QA CAL-05.v8  
Calibration procedure for dipole validation kits above 700 MHz**

Calibration date: **February 22, 2012**

*✓ KOK  
4/11/12*

This calibration certificate documents the traceability to national standards, which realize the physical units of measurements (SI).  
The measurements and the uncertainties with confidence probability are given on the following pages and are part of the certificate.

All calibrations have been conducted in the closed laboratory facility: environment temperature (22 ± 3)°C and humidity < 70%.

Calibration Equipment used (M&TE critical for calibration)

Primary Standards	ID #	Cal Date (Certificate No.)	Scheduled Calibration
Power meter EPM-442A	GB37480704	05-Oct-11 (No. 217-01451)	Oct-12
Power sensor HP 8481A	US37292783	05-Oct-11 (No. 217-01451)	Oct-12
Reference 20 dB Attenuator	SN: 5086 (20g)	29-Mar-11 (No. 217-01368)	Apr-12
Type-N mismatch combination	SN: 5047.2 / 06327	29-Mar-11 (No. 217-01371)	Apr-12
Reference Probe ES3DV3	SN: 3205	30-Dec-11 (No. ES3-3205_Dec11)	Dec-12
DAE4	SN: 601	04-Jul-11 (No. DAE4-601_Jul11)	Jul-12
Secondary Standards	ID #	Check Date (in house)	Scheduled Check
Power sensor HP 8481A	MY41092317	18-Oct-02 (in house check Oct-11)	In house check: Oct-13
RF generator R&S SMT-06	100005	04-Aug-99 (in house check Oct-11)	In house check: Oct-13
Network Analyzer HP 8753E	US37390585 S4206	18-Oct-01 (in house check Oct-11)	In house check: Oct-12

Calibrated by: **Name** **Function** **Signature**  
**Israe El-Naouq** **Laboratory Technician** *Israe El-Naouq*

Approved by: **Name** **Technical Manager**  
**Katja Pokovic** *Katja Pokovic*

Issued: February 23, 2012

This calibration certificate shall not be reproduced except in full without written approval of the laboratory.



Accredited by the Swiss Accreditation Service (SAS)

The Swiss Accreditation Service is one of the signatories to the EA Multilateral Agreement for the recognition of calibration certificates

Accreditation No.: **SCS 108**

### Glossary:

TSL	tissue simulating liquid
ConvF	sensitivity in TSL / NORM x,y,z
N/A	not applicable or not measured

### Calibration is Performed According to the Following Standards:

- IEEE Std 1528-2003, "IEEE Recommended Practice for Determining the Peak Spatial-Averaged Specific Absorption Rate (SAR) in the Human Head from Wireless Communications Devices: Measurement Techniques", December 2003
- IEC 62209-1, "Procedure to measure the Specific Absorption Rate (SAR) for hand-held devices used in close proximity to the ear (frequency range of 300 MHz to 3 GHz)", February 2005
- Federal Communications Commission Office of Engineering & Technology (FCC OET), "Evaluating Compliance with FCC Guidelines for Human Exposure to Radiofrequency Electromagnetic Fields; Additional Information for Evaluating Compliance of Mobile and Portable Devices with FCC Limits for Human Exposure to Radiofrequency Emissions", Supplement C (Edition 01-01) to Bulletin 65

### Additional Documentation:

- DASY4/5 System Handbook

### Methods Applied and Interpretation of Parameters:

- Measurement Conditions:** Further details are available from the Validation Report at the end of the certificate. All figures stated in the certificate are valid at the frequency indicated.
- Antenna Parameters with TSL:** The dipole is mounted with the spacer to position its feed point exactly below the center marking of the flat phantom section, with the arms oriented parallel to the body axis.
- Feed Point Impedance and Return Loss:** These parameters are measured with the dipole positioned under the liquid filled phantom. The impedance stated is transformed from the measurement at the SMA connector to the feed point. The Return Loss ensures low reflected power. No uncertainty required.
- Electrical Delay:** One-way delay between the SMA connector and the antenna feed point. No uncertainty required.
- SAR measured:** SAR measured at the stated antenna input power.
- SAR normalized:** SAR as measured, normalized to an input power of 1 W at the antenna connector.
- SAR for nominal TSL parameters:** The measured TSL parameters are used to calculate the nominal SAR result.

## Measurement Conditions

DASY system configuration, as far as not given on page 1.

<b>DASY Version</b>	DASY5	V52.8.0
<b>Extrapolation</b>	Advanced Extrapolation	
<b>Phantom</b>	Modular Flat Phantom	
<b>Distance Dipole Center - TSL</b>	10 mm	with Spacer
<b>Zoom Scan Resolution</b>	dx, dy, dz = 5 mm	
<b>Frequency</b>	1900 MHz $\pm$ 1 MHz	

## Head TSL parameters

The following parameters and calculations were applied.

	Temperature	Permittivity	Conductivity
<b>Nominal Head TSL parameters</b>	22.0 °C	40.0	1.40 mho/m
<b>Measured Head TSL parameters</b>	(22.0 $\pm$ 0.2) °C	40.4 $\pm$ 6 %	1.40 mho/m $\pm$ 6 %
<b>Head TSL temperature change during test</b>	< 0.5 °C	----	----

## SAR result with Head TSL

<b>SAR averaged over 1 cm<sup>3</sup> (1 g) of Head TSL</b>	Condition	
SAR measured	250 mW input power	9.80 mW / g
SAR for nominal Head TSL parameters	normalized to 1W	<b>39.3 mW / g <math>\pm</math> 17.0 % (k=2)</b>

<b>SAR averaged over 10 cm<sup>3</sup> (10 g) of Head TSL</b>	condition	
SAR measured	250 mW input power	5.18 mW / g
SAR for nominal Head TSL parameters	normalized to 1W	<b>20.7 mW / g <math>\pm</math> 16.5 % (k=2)</b>

## Body TSL parameters

The following parameters and calculations were applied.

	Temperature	Permittivity	Conductivity
<b>Nominal Body TSL parameters</b>	22.0 °C	53.3	1.52 mho/m
<b>Measured Body TSL parameters</b>	(22.0 $\pm$ 0.2) °C	53.0 $\pm$ 6 %	1.56 mho/m $\pm$ 6 %
<b>Body TSL temperature change during test</b>	< 0.5 °C	----	----

## SAR result with Body TSL

<b>SAR averaged over 1 cm<sup>3</sup> (1 g) of Body TSL</b>	Condition	
SAR measured	250 mW input power	9.99 mW / g
SAR for nominal Body TSL parameters	normalized to 1W	<b>39.3 mW / g <math>\pm</math> 17.0 % (k=2)</b>

<b>SAR averaged over 10 cm<sup>3</sup> (10 g) of Body TSL</b>	condition	
SAR measured	250 mW input power	5.23 mW / g
SAR for nominal Body TSL parameters	normalized to 1W	<b>20.7 mW / g <math>\pm</math> 16.5 % (k=2)</b>

## Appendix

### Antenna Parameters with Head TSL

Impedance, transformed to feed point	52.4 $\Omega$ + 5.5 j $\Omega$
Return Loss	- 24.6 dB

### Antenna Parameters with Body TSL

Impedance, transformed to feed point	48.0 $\Omega$ + 6.7 j $\Omega$
Return Loss	- 23.0 dB

### General Antenna Parameters and Design

Electrical Delay (one direction)	1.199 ns
----------------------------------	----------

After long term use with 100W radiated power, only a slight warming of the dipole near the feedpoint can be measured.

The dipole is made of standard semirigid coaxial cable. The center conductor of the feeding line is directly connected to the second arm of the dipole. The antenna is therefore short-circuited for DC-signals. On some of the dipoles, small end caps are added to the dipole arms in order to improve matching when loaded according to the position as explained in the "Measurement Conditions" paragraph. The SAR data are not affected by this change. The overall dipole length is still according to the Standard.

No excessive force must be applied to the dipole arms, because they might bend or the soldered connections near the feedpoint may be damaged.

### Additional EUT Data

Manufactured by	SPEAG
Manufactured on	March 11, 2011

## DASY5 Validation Report for Head TSL

Date: 22.02.2012

Test Laboratory: SPEAG, Zurich, Switzerland

**DUT: Dipole 1900 MHz; Type: D1900V2; Serial: D1900V2 - SN: 5d149**

Communication System: CW; Frequency: 1900 MHz

Medium parameters used:  $f = 1900$  MHz;  $\sigma = 1.4$  mho/m;  $\epsilon_r = 40.4$ ;  $\rho = 1000$  kg/m<sup>3</sup>

Phantom section: Flat Section

Measurement Standard: DASY5 (IEEE/IEC/ANSI C63.19-2007)

DASY52 Configuration:

- Probe: ES3DV3 - SN3205; ConvF(5.01, 5.01, 5.01); Calibrated: 30.12.2011
- Sensor-Surface: 3mm (Mechanical Surface Detection)
- Electronics: DAE4 Sn601; Calibrated: 04.07.2011
- Phantom: Flat Phantom 5.0 (front); Type: QD000P50AA; Serial: 1001
- DASY52 52.8.0(692); SEMCAD X 14.6.4(4989)

### Dipole Calibration for Head Tissue/Pin=250 mW, d=10mm/Zoom Scan (7x7x7)/Cube 0:

Measurement grid: dx=5mm, dy=5mm, dz=5mm

Reference Value = 96.685 V/m; Power Drift = 0.04 dB

Peak SAR (extrapolated) = 17.4710

**SAR(1 g) = 9.8 mW/g; SAR(10 g) = 5.18 mW/g**

Maximum value of SAR (measured) = 12.114 mW/g

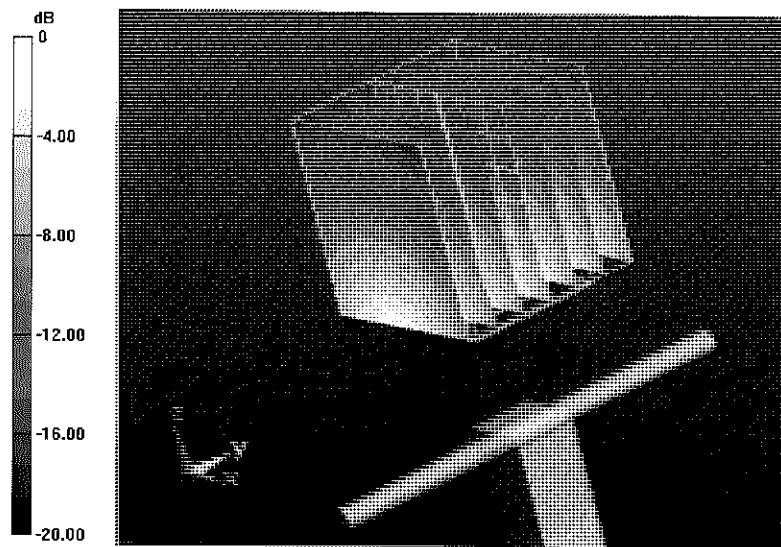

0 dB = 12.110mW/g = 21.66 dB mW/g

# Impedance Measurement Plot for Head TSL

22 Feb 2012 09:56:56

CH1 S11 1 U FS 2: 52.387  $\Omega$  5.5059  $\Omega$  461.20  $\mu\text{H}$  1 900.000 000 MHz

\*  
De1  
Cor  
Avg  
16  
H1d

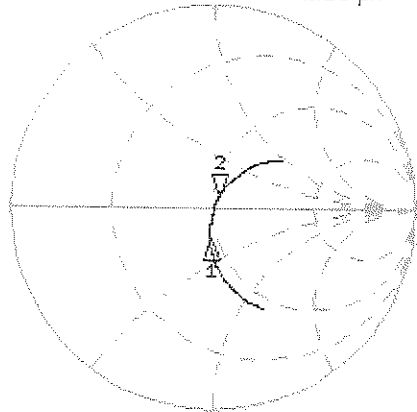

CH1 Markers  
1: 46.287  $\Omega$   
-15.180  $\Omega$   
1.80000 GHz

CH2 S11 LOG 5 dB/REF -20 dB 2: -24.647 dB 1 900.000 000 MHz

Cor  
Avg  
15  
H1d

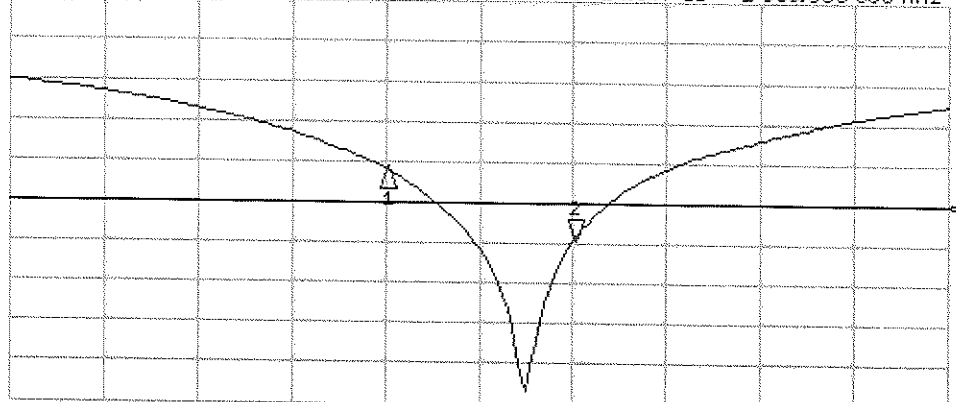

CH2 Markers  
1: -15.901 dB  
1.80000 GHz

START 1 600.000 000 MHz STOP 2 100.000 000 MHz

# DASY5 Validation Report for Body TSL

Date: 06.02.2012

Test Laboratory: SPEAG, Zurich, Switzerland

**DUT: Dipole 1900 MHz; Type: D1900V2; Serial: D1900V2 - SN: 5d149**

Communication System: CW; Frequency: 1900 MHz

Medium parameters used:  $f = 1900$  MHz;  $\sigma = 1.56$  mho/m;  $\epsilon_r = 53$ ;  $\rho = 1000$  kg/m<sup>3</sup>

Phantom section: Flat Section

Measurement Standard: DASY5 (IEEE/IEC/ANSI C63.19-2007)

DASY52 Configuration:

- Probe: ES3DV3 - SN3205; ConvF(4.62, 4.62, 4.62); Calibrated: 30.12.2011
- Sensor-Surface: 3mm (Mechanical Surface Detection)
- Electronics: DAE4 Sn601; Calibrated: 04.07.2011
- Phantom: Flat Phantom 5.0 (back); Type: QD000P50AA; Serial: 1002
- DASY52 52.8.0(692); SEMCAD X 14.6.4(4989)

## Dipole Calibration for Body Tissue/Pin=250 mW, d=10mm/Zoom Scan (7x7x7)/Cube 0:

Measurement grid: dx=5mm, dy=5mm, dz=5mm

Reference Value = 94.047 V/m; Power Drift = 0.0017 dB

Peak SAR (extrapolated) = 18.1310

**SAR(1 g) = 9.99 mW/g; SAR(10 g) = 5.23 mW/g**

Maximum value of SAR (measured) = 12.672 mW/g

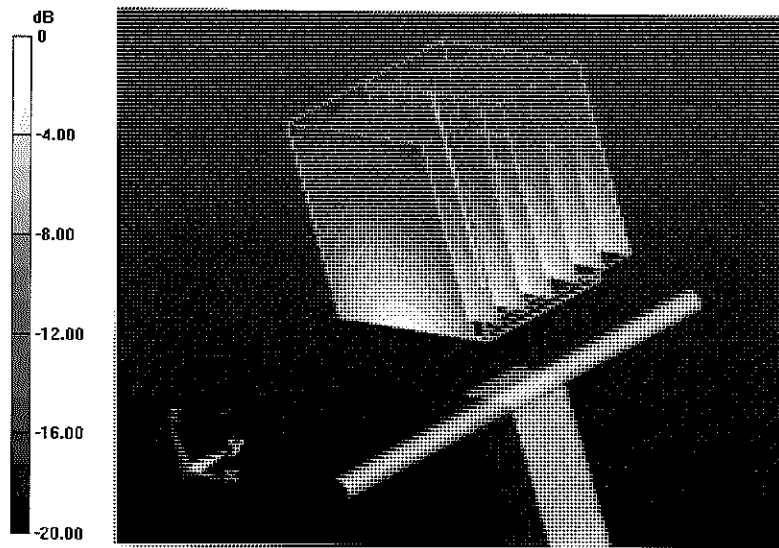

0 dB = 12.670mW/g = 22.06 dB mW/g

# Impedance Measurement Plot for Body TSL

6 Feb 2012 12:15:29

CH1 S11 1 U FS 4: 47.961  $\Omega$  6.8680  $\Omega$  558.55 pF 1 900.000 000 MHz

\*  
De1

Ca

Avg  
15

H1d

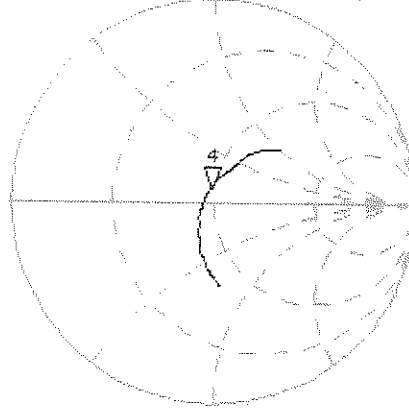

CH2 S11 LOG 5 dB/REF -20 dB 4:-22.971 dB 1 900.000 000 MHz

Ca

Avg  
15

H1d

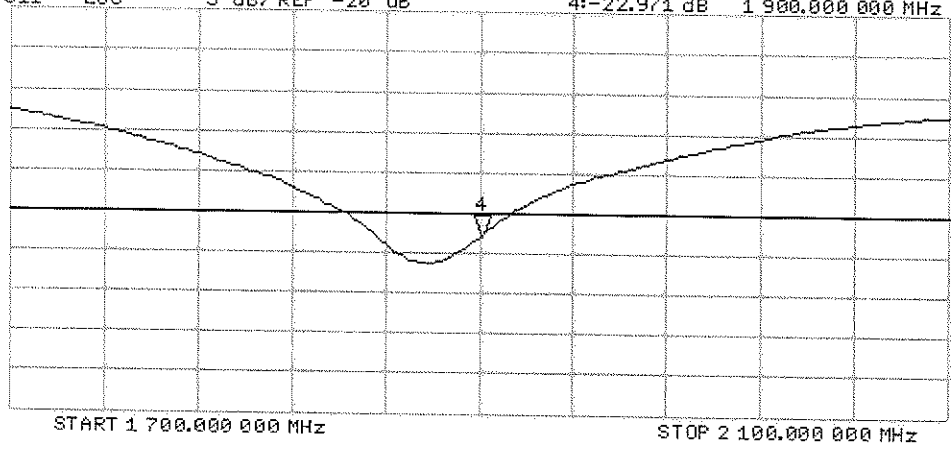

**Calibration Laboratory of  
Schmid & Partner  
Engineering AG**  
Zeughausstrasse 43, 8004 Zurich, Switzerland



**S** Schweizerischer Kalibrierdienst  
**C** Service suisse d'étalonnage  
**S** Servizio svizzero di taratura  
**S** Swiss Calibration Service

Accredited by the Swiss Accreditation Service (SAS)  
The Swiss Accreditation Service is one of the signatories to the EA  
Multilateral Agreement for the recognition of calibration certificates

Accreditation No.: **SCS 108**

Client **PC Test**

Certificate No: **D835V2-4d026\_Aug12**

## CALIBRATION CERTIFICATE

Object **D835V2 - SN: 4d026**

Calibration procedure(s) **QA CAL-05.v8  
Calibration procedure for dipole validation kits above 700 MHz**

Calibration date: **August 23, 2012**

*1/10K  
9/17/12*

This calibration certificate documents the traceability to national standards, which realize the physical units of measurements (SI).  
The measurements and the uncertainties with confidence probability are given on the following pages and are part of the certificate.

All calibrations have been conducted in the closed laboratory facility: environment temperature (22 ± 3)°C and humidity < 70%.

Calibration Equipment used (M&TE critical for calibration)

Primary Standards	ID #	Cal Date (Certificate No.)	Scheduled Calibration
Power meter EPM-442A	GB37480704	05-Oct-11 (No. 217-01451)	Oct-12
Power sensor HP 8481A	US37292783	05-Oct-11 (No. 217-01451)	Oct-12
Reference 20 dB Attenuator	SN: 5058 (20k)	27-Mar-12 (No. 217-01530)	Apr-13
Type-N mismatch combination	SN: 5047.2 / 06327	27-Mar-12 (No. 217-01533)	Apr-13
Reference Probe ES3DV3	SN: 3205	30-Dec-11 (No. ES3-3205_Dec11)	Dec-12
DAE4	SN: 601	27-Jun-12 (No. DAE4-601_Jun12)	Jun-13
Secondary Standards	ID #	Check Date (in house)	Scheduled Check
Power sensor HP 8481A	MY41092317	18-Oct-02 (in house check Oct-11)	In house check: Oct-13
RF generator R&S SMT-06	100005	04-Aug-99 (in house check Oct-11)	In house check: Oct-13
Network Analyzer HP 8753E	US37390585 S4206	18-Oct-01 (in house check Oct-11)	In house check: Oct-12

Calibrated by: **Israe El-Naouq**      Name: **Israe El-Naouq**      Function: **Laboratory Technician**

Approved by: **Katja Pokovic**      Name: **Katja Pokovic**      Function: **Technical Manager**

Signature  
*Israe El-Naouq*  
*Katja Pokovic*

Issued: August 23, 2012

This calibration certificate shall not be reproduced except in full without written approval of the laboratory.

**Calibration Laboratory of  
Schmid & Partner  
Engineering AG**  
Zeughausstrasse 43, 8004 Zurich, Switzerland



**S** Schweizerischer Kalibrierdienst  
**C** Service suisse d'étalonnage  
**S** Servizio svizzero di taratura  
**S** Swiss Calibration Service

Accredited by the Swiss Accreditation Service (SAS)  
The Swiss Accreditation Service is one of the signatories to the EA  
Multilateral Agreement for the recognition of calibration certificates

Accreditation No.: **SCS 108**

### Glossary:

TSL	tissue simulating liquid
ConvF	sensitivity in TSL / NORM x,y,z
N/A	not applicable or not measured

### Calibration is Performed According to the Following Standards:

- IEEE Std 1528-2003, "IEEE Recommended Practice for Determining the Peak Spatial-Averaged Specific Absorption Rate (SAR) in the Human Head from Wireless Communications Devices: Measurement Techniques", December 2003
- IEC 62209-1, "Procedure to measure the Specific Absorption Rate (SAR) for hand-held devices used in close proximity to the ear (frequency range of 300 MHz to 3 GHz)", February 2005
- Federal Communications Commission Office of Engineering & Technology (FCC OET), "Evaluating Compliance with FCC Guidelines for Human Exposure to Radiofrequency Electromagnetic Fields; Additional Information for Evaluating Compliance of Mobile and Portable Devices with FCC Limits for Human Exposure to Radiofrequency Emissions", Supplement C (Edition 01-01) to Bulletin 65

### Additional Documentation:

- DASY4/5 System Handbook

### Methods Applied and Interpretation of Parameters:

- Measurement Conditions:** Further details are available from the Validation Report at the end of the certificate. All figures stated in the certificate are valid at the frequency indicated.
- Antenna Parameters with TSL:** The dipole is mounted with the spacer to position its feed point exactly below the center marking of the flat phantom section, with the arms oriented parallel to the body axis.
- Feed Point Impedance and Return Loss:** These parameters are measured with the dipole positioned under the liquid filled phantom. The impedance stated is transformed from the measurement at the SMA connector to the feed point. The Return Loss ensures low reflected power. No uncertainty required.
- Electrical Delay:** One-way delay between the SMA connector and the antenna feed point. No uncertainty required.
- SAR measured:** SAR measured at the stated antenna input power.
- SAR normalized:** SAR as measured, normalized to an input power of 1 W at the antenna connector.
- SAR for nominal TSL parameters:** The measured TSL parameters are used to calculate the nominal SAR result.

The reported uncertainty of measurement is stated as the standard uncertainty of measurement multiplied by the coverage factor  $k=2$ , which for a normal distribution corresponds to a coverage probability of approximately 95%.

## Measurement Conditions

DASY system configuration, as far as not given on page 1.

DASY Version	DASY5	V52.8.2
Extrapolation	Advanced Extrapolation	
Phantom	Modular Flat Phantom	
Distance Dipole Center - TSL	15 mm	with Spacer
Zoom Scan Resolution	dx, dy, dz = 5 mm	
Frequency	835 MHz $\pm$ 1 MHz	

## Head TSL parameters

The following parameters and calculations were applied.

	Temperature	Permittivity	Conductivity
Nominal Head TSL parameters	22.0 °C	41.5	0.90 mho/m
Measured Head TSL parameters	(22.0 $\pm$ 0.2) °C	41.3 $\pm$ 6 %	0.90 mho/m $\pm$ 6 %
Head TSL temperature change during test	< 0.5 °C	---	---

## SAR result with Head TSL

SAR averaged over 1 cm <sup>3</sup> (1 g) of Head TSL	Condition	
SAR measured	250 mW input power	2.35 mW / g
SAR for nominal Head TSL parameters	normalized to 1W	<b>9.39 mW / g <math>\pm</math> 17.0 % (k=2)</b>

SAR averaged over 10 cm <sup>3</sup> (10 g) of Head TSL	condition	
SAR measured	250 mW input power	1.53 mW / g
SAR for nominal Head TSL parameters	normalized to 1W	<b>6.12 mW / g <math>\pm</math> 16.5 % (k=2)</b>

## Body TSL parameters

The following parameters and calculations were applied.

	Temperature	Permittivity	Conductivity
Nominal Body TSL parameters	22.0 °C	55.2	0.97 mho/m
Measured Body TSL parameters	(22.0 $\pm$ 0.2) °C	53.2 $\pm$ 6 %	1.00 mho/m $\pm$ 6 %
Body TSL temperature change during test	< 0.5 °C	---	---

## SAR result with Body TSL

SAR averaged over 1 cm <sup>3</sup> (1 g) of Body TSL	Condition	
SAR measured	250 mW input power	2.47 mW / g
SAR for nominal Body TSL parameters	normalized to 1W	<b>9.58 mW / g <math>\pm</math> 17.0 % (k=2)</b>

SAR averaged over 10 cm <sup>3</sup> (10 g) of Body TSL	condition	
SAR measured	250 mW input power	1.62 mW / g
SAR for nominal Body TSL parameters	normalized to 1W	<b>6.33 mW / g <math>\pm</math> 16.5 % (k=2)</b>

## Appendix

### Antenna Parameters with Head TSL

Impedance, transformed to feed point	53.7 $\Omega$ - 3.4 j $\Omega$
Return Loss	- 26.4 dB

### Antenna Parameters with Body TSL

Impedance, transformed to feed point	49.6 $\Omega$ - 4.8 j $\Omega$
Return Loss	- 26.4 dB

### General Antenna Parameters and Design

Electrical Delay (one direction)	1.389 ns
----------------------------------	----------

After long term use with 100W radiated power, only a slight warming of the dipole near the feedpoint can be measured.

The dipole is made of standard semirigid coaxial cable. The center conductor of the feeding line is directly connected to the second arm of the dipole. The antenna is therefore short-circuited for DC-signals. On some of the dipoles, small end caps are added to the dipole arms in order to improve matching when loaded according to the position as explained in the "Measurement Conditions" paragraph. The SAR data are not affected by this change. The overall dipole length is still according to the Standard.

No excessive force must be applied to the dipole arms, because they might bend or the soldered connections near the feedpoint may be damaged.

### Additional EUT Data

Manufactured by	SPEAG
Manufactured on	December 17, 2004

## DASY5 Validation Report for Head TSL

Date: 23.08.2012

Test Laboratory: SPEAG, Zurich, Switzerland

**DUT: Dipole 835 MHz; Type: D835V2; Serial: D835V2 - SN: 4d026**

Communication System: CW; Frequency: 835 MHz

Medium parameters used:  $f = 835$  MHz;  $\sigma = 0.9$  mho/m;  $\epsilon_r = 41.3$ ;  $\rho = 1000$  kg/m<sup>3</sup>

Phantom section: Flat Section

Measurement Standard: DASY5 (IEEE/IEC/ANSI C63.19-2007)

DASY52 Configuration:

- Probe: ES3DV3 - SN3205; ConvF(6.07, 6.07, 6.07); Calibrated: 30.12.2011;
- Sensor-Surface: 3mm (Mechanical Surface Detection)
- Electronics: DAE4 Sn601; Calibrated: 27.06.2012
- Phantom: Flat Phantom 4.9L; Type: QD000P49AA; Serial: 1001
- DASY52 52.8.2(969); SEMCAD X 14.6.6(6824)

### Dipole Calibration for Head Tissue/Pin=250 mW, d=15mm 2/Zoom Scan (7x7x7)/Cube 0:

Measurement grid: dx=5mm, dy=5mm, dz=5mm

Reference Value = 56.824 V/m; Power Drift = 0.01 dB

Peak SAR (extrapolated) = 3.482 mW/g

**SAR(1 g) = 2.35 mW/g; SAR(10 g) = 1.53 mW/g**

Maximum value of SAR (measured) = 2.72 W/kg

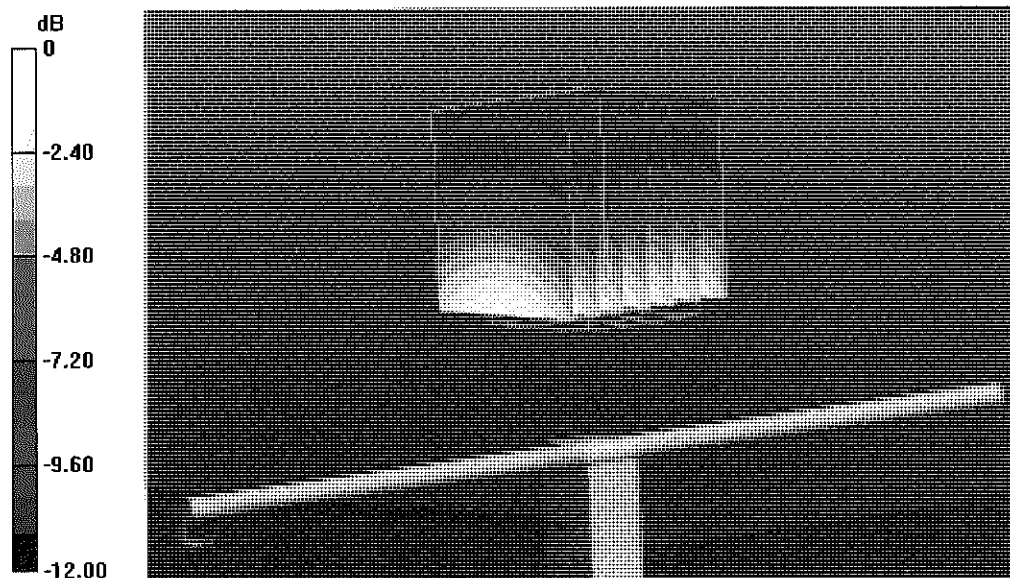

0 dB = 2.72 W/kg = 8.69 dB W/kg

# Impedance Measurement Plot for Head TSL

23 Aug 2012 12:19:04

CH1 S11 1 U FS

1: 53.662  $\Delta$  -3.3516  $\Delta$  56.870 pF 835.000 000 MHz

\*

De1

Cor

Avg  
15

H1d

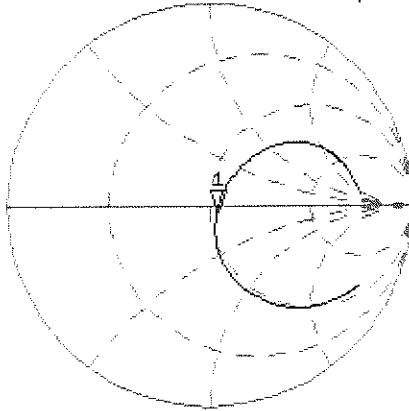

CH2 S11 LOG 5 dB/REF -20 dB 1:-25.390 dB 835.000 000 MHz

Cor

Avg  
15

H1d

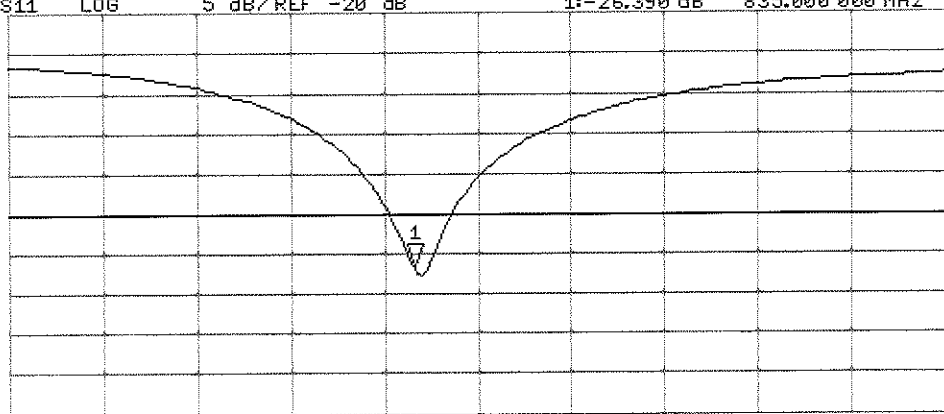

START 635.000 000 MHz

STOP 1 100.000 000 MHz

## DASY5 Validation Report for Body TSL

Date: 23.08.2012

Test Laboratory: SPEAG, Zurich, Switzerland

**DUT: Dipole 835 MHz; Type: D835V2; Serial: D835V2 - SN: 4d026**

Communication System: CW; Frequency: 835 MHz

Medium parameters used:  $f = 835$  MHz;  $\sigma = 1$  mho/m;  $\epsilon_r = 53.2$ ;  $\rho = 1000$  kg/m<sup>3</sup>

Phantom section: Flat Section

Measurement Standard: DASY5 (IEEE/IEC/ANSI C63.19-2007)

DASY52 Configuration:

- Probe: ES3DV3 - SN3205; ConvF(6.02, 6.02, 6.02); Calibrated: 30.12.2011;
- Sensor-Surface: 3mm (Mechanical Surface Detection)
- Electronics: DAE4 Sn601; Calibrated: 27.06.2012
- Phantom: Flat Phantom 4.9L; Type: QD000P49AA; Serial: 1001
- DASY52 52.8.2(969); SEMCAD X 14.6.6(6824)

### Dipole Calibration for Body Tissue/Pin=250 mW, d=15mm/Zoom Scan (7x7x7)/Cube 0:

Measurement grid: dx=5mm, dy=5mm, dz=5mm

Reference Value = 55.339 V/m; Power Drift = 0.04 dB

Peak SAR (extrapolated) = 3.592 mW/g

**SAR(1 g) = 2.47 mW/g; SAR(10 g) = 1.62 mW/g**

Maximum value of SAR (measured) = 2.87 W/kg

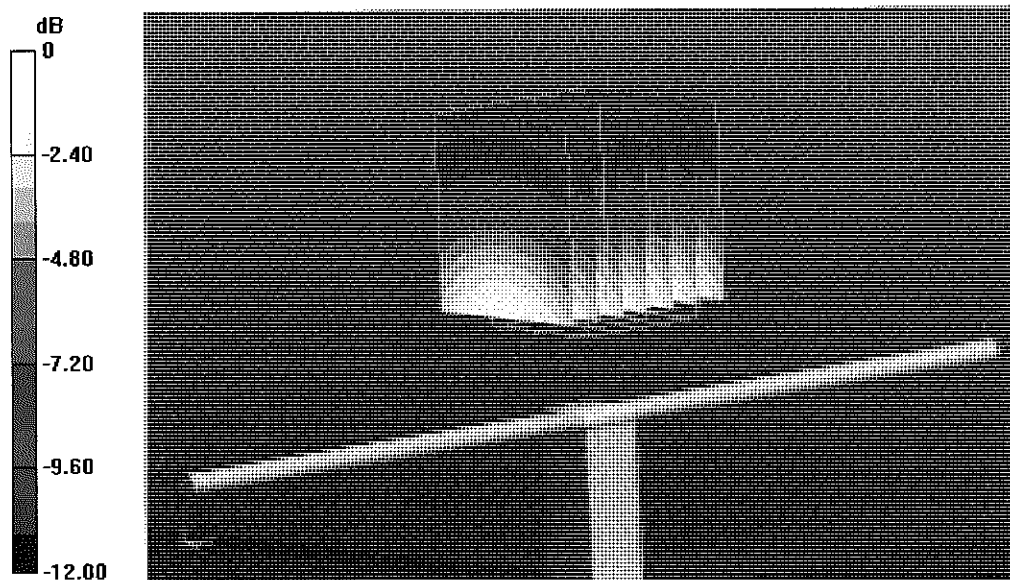

# Impedance Measurement Plot for Body TSL

23 Aug 2012 10:54:42

[CH1] S11 1 U FS

1: 49.557  $\angle$  -4.7500  $\angle$  40.127 pF

835.000 000 MHz

\*  
Del  
Cor

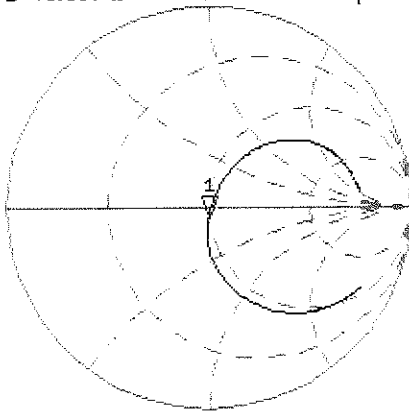

Avg  
16

H1d

CH2 S11 LOG 5 dB/REF -20 dB 1:-26.405 dB 835.000 000 MHz

Cor

Avg  
16

H1d

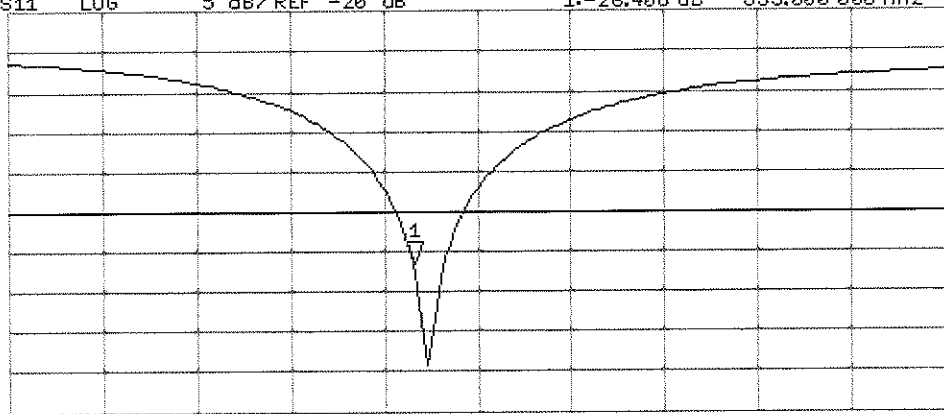

START 635.000 000 MHz

STOP 1 100.000 000 MHz



Accredited by the Swiss Accreditation Service (SAS)  
The Swiss Accreditation Service is one of the signatories to the EA  
Multilateral Agreement for the recognition of calibration certificates

Accreditation No.: **SCS 108**

Client **PC Test**

Certificate No: **D835V2-4d132\_Feb12**

**CALIBRATION CERTIFICATE**

Object **D835V2 - SN: 4d132**

Calibration procedure(s) **QA CAL-05.v8  
Calibration procedure for dipole validation kits above 700 MHz**

Calibration date: **February 03, 2012**

*✓ FOK  
5/14/12*

This calibration certificate documents the traceability to national standards, which realize the physical units of measurements (SI).  
The measurements and the uncertainties with confidence probability are given on the following pages and are part of the certificate.

All calibrations have been conducted in the closed laboratory facility: environment temperature (22 ± 3)°C and humidity < 70%.

Calibration Equipment used (M&TE critical for calibration)

Primary Standards	ID #	Cal Date (Certificate No.)	Scheduled Calibration
Power meter EPM-442A	GB37480704	05-Oct-11 (No. 217-01451)	Oct-12
Power sensor HP 8481A	US37292783	05-Oct-11 (No. 217-01451)	Oct-12
Reference 20 dB Attenuator	SN: 5086 (20g)	29-Mar-11 (No. 217-01368)	Apr-12
Type-N mismatch combination	SN: 5047.2 / 06327	29-Mar-11 (No. 217-01371)	Apr-12
Reference Probe ES3DV3	SN: 3205	30-Dec-11 (No. ES3-3205_Dec11)	Dec-12
DAE4	SN: 601	04-Jul-11 (No. DAE4-601_Jul11)	Jul-12
Secondary Standards	ID #	Check Date (in house)	Scheduled Check
Power sensor HP 8481A	MY41092317	18-Oct-02 (in house check Oct-11)	In house check: Oct-13
RF generator R&S SMT-06	100005	04-Aug-99 (in house check Oct-11)	In house check: Oct-13
Network Analyzer HP 8753E	US37390585 S4206	18-Oct-01 (in house check Oct-11)	In house check: Oct-12

Calibrated by:	Name <b>Israe El-Naouq</b>	Function <b>Laboratory Technician</b>	Signature <i>Israe El-Naouq</i>
Approved by:	<b>Katja Pokovic</b>	<b>Technical Manager</b>	<i>Katja Pokovic</i>

Issued: February 3, 2012

This calibration certificate shall not be reproduced except in full without written approval of the laboratory.



Accredited by the Swiss Accreditation Service (SAS)  
The Swiss Accreditation Service is one of the signatories to the EA  
Multilateral Agreement for the recognition of calibration certificates

Accreditation No.: **SCS 108**

### Glossary:

TSL	tissue simulating liquid
ConvF	sensitivity in TSL / NORM x,y,z
N/A	not applicable or not measured

### Calibration is Performed According to the Following Standards:

- IEEE Std 1528-2003, "IEEE Recommended Practice for Determining the Peak Spatial-Averaged Specific Absorption Rate (SAR) in the Human Head from Wireless Communications Devices: Measurement Techniques", December 2003
- IEC 62209-1, "Procedure to measure the Specific Absorption Rate (SAR) for hand-held devices used in close proximity to the ear (frequency range of 300 MHz to 3 GHz)", February 2005
- Federal Communications Commission Office of Engineering & Technology (FCC OET), "Evaluating Compliance with FCC Guidelines for Human Exposure to Radiofrequency Electromagnetic Fields; Additional Information for Evaluating Compliance of Mobile and Portable Devices with FCC Limits for Human Exposure to Radiofrequency Emissions", Supplement C (Edition 01-01) to Bulletin 65

### Additional Documentation:

- DASY4/5 System Handbook

### Methods Applied and Interpretation of Parameters:

- Measurement Conditions:** Further details are available from the Validation Report at the end of the certificate. All figures stated in the certificate are valid at the frequency indicated.
- Antenna Parameters with TSL:** The dipole is mounted with the spacer to position its feed point exactly below the center marking of the flat phantom section, with the arms oriented parallel to the body axis.
- Feed Point Impedance and Return Loss:** These parameters are measured with the dipole positioned under the liquid filled phantom. The impedance stated is transformed from the measurement at the SMA connector to the feed point. The Return Loss ensures low reflected power. No uncertainty required.
- Electrical Delay:** One-way delay between the SMA connector and the antenna feed point. No uncertainty required.
- SAR measured:** SAR measured at the stated antenna input power.
- SAR normalized:** SAR as measured, normalized to an input power of 1 W at the antenna connector.
- SAR for nominal TSL parameters:** The measured TSL parameters are used to calculate the nominal SAR result.

## Measurement Conditions

DASY system configuration, as far as not given on page 1.

DASY Version	DASY5	V52.8.0
Extrapolation	Advanced Extrapolation	
Phantom	Modular Flat Phantom	
Distance Dipole Center - TSL	15 mm	with Spacer
Zoom Scan Resolution	dx, dy, dz = 5 mm	
Frequency	835 MHz $\pm$ 1 MHz	

## Head TSL parameters

The following parameters and calculations were applied.

	Temperature	Permittivity	Conductivity
Nominal Head TSL parameters	22.0 °C	41.5	0.90 mho/m
Measured Head TSL parameters	(22.0 $\pm$ 0.2) °C	41.8 $\pm$ 6 %	0.89 mho/m $\pm$ 6 %
Head TSL temperature change during test	< 0.5 °C	----	----

## SAR result with Head TSL

SAR averaged over 1 cm <sup>3</sup> (1 g) of Head TSL	Condition	
SAR measured	250 mW input power	2.34 mW / g
SAR for nominal Head TSL parameters	normalized to 1W	<b>9.45 mW / g <math>\pm</math> 17.0 % (k=2)</b>

SAR averaged over 10 cm <sup>3</sup> (10 g) of Head TSL	condition	
SAR measured	250 mW input power	1.53 mW / g
SAR for nominal Head TSL parameters	normalized to 1W	<b>6.17 mW / g <math>\pm</math> 16.5 % (k=2)</b>

## Body TSL parameters

The following parameters and calculations were applied.

	Temperature	Permittivity	Conductivity
Nominal Body TSL parameters	22.0 °C	55.2	0.97 mho/m
Measured Body TSL parameters	(22.0 $\pm$ 0.2) °C	53.3 $\pm$ 6 %	0.98 mho/m $\pm$ 6 %
Body TSL temperature change during test	< 0.5 °C	----	----

## SAR result with Body TSL

SAR averaged over 1 cm <sup>3</sup> (1 g) of Body TSL	Condition	
SAR measured	250 mW input power	2.39 mW / g
SAR for nominal Body TSL parameters	normalized to 1W	<b>9.41 mW / g <math>\pm</math> 17.0 % (k=2)</b>

SAR averaged over 10 cm <sup>3</sup> (10 g) of Body TSL	condition	
SAR measured	250 mW input power	1.57 mW / g
SAR for nominal Body TSL parameters	normalized to 1W	<b>6.21 mW / g <math>\pm</math> 16.5 % (k=2)</b>

## Appendix

### Antenna Parameters with Head TSL

Impedance, transformed to feed point	52.7 $\Omega$ - 2.3 j $\Omega$
Return Loss	- 29.2 dB

### Antenna Parameters with Body TSL

Impedance, transformed to feed point	48.9 $\Omega$ - 3.5 j $\Omega$
Return Loss	- 28.7 dB

### General Antenna Parameters and Design

Electrical Delay (one direction)	1.392 ns
----------------------------------	----------

After long term use with 100W radiated power, only a slight warming of the dipole near the feedpoint can be measured.

The dipole is made of standard semirigid coaxial cable. The center conductor of the feeding line is directly connected to the second arm of the dipole. The antenna is therefore short-circuited for DC-signals. On some of the dipoles, small end caps are added to the dipole arms in order to improve matching when loaded according to the position as explained in the "Measurement Conditions" paragraph. The SAR data are not affected by this change. The overall dipole length is still according to the Standard.

No excessive force must be applied to the dipole arms, because they might bend or the soldered connections near the feedpoint may be damaged.

### Additional EUT Data

Manufactured by	SPEAG
Manufactured on	July 22, 2011

## DASY5 Validation Report for Head TSL

Date: 03.02.2012

Test Laboratory: SPEAG, Zurich, Switzerland

**DUT: Dipole 835 MHz; Type: D835V2; Serial: D835V2 - SN: 4d132**

Communication System: CW; Frequency: 835 MHz

Medium parameters used:  $f = 835$  MHz;  $\sigma = 0.89$  mho/m;  $\epsilon_r = 41.8$ ;  $\rho = 1000$  kg/m<sup>3</sup>

Phantom section: Flat Section

Measurement Standard: DASY5 (IEEE/IEC/ANSI C63.19-2007)

DASY52 Configuration:

- Prohe: ES3DV3 - SN3205; ConvF(6.07, 6.07, 6.07); Calibrated: 30.12.2011
- Sensor-Surface: 3mm (Mechanical Surface Detection)
- Electronics: DAE4 Sn601; Calibrated: 04.07.2011
- Phantom: Flat Phantom 4.9L; Type: QD000P49AA; Serial: 1001
- DASY52 52.8.0(692); SEMCAD X 14.6.4(4989)

### **Dipole Calibration for Head Tissue/Pin=250 mW, d=15mm/Zoom Scan (7x7x7)/Cube 0:**

Measurement grid: dx=5mm, dy=5mm, dz=5mm

Reference Value = 56.867 V/m; Power Drift = 0.05 dB

Peak SAR (extrapolated) = 3.4300

**SAR(1 g) = 2.34 mW/g; SAR(10 g) = 1.53 mW/g**

Maximum value of SAR (measured) = 2.701 mW/g

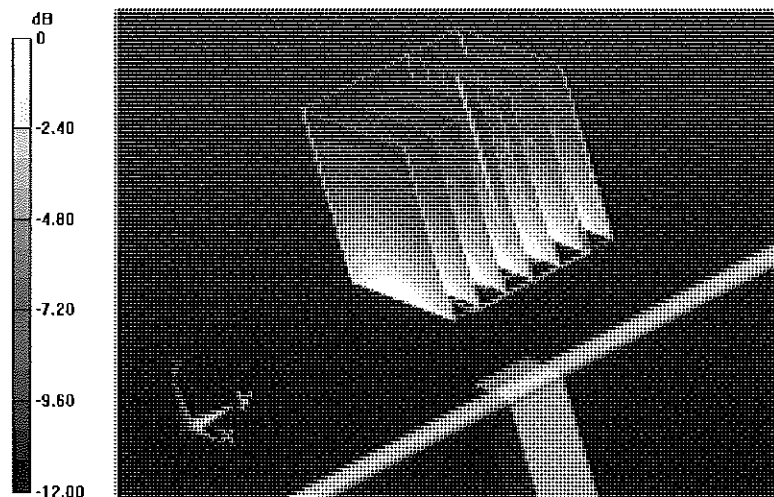

0 dB = 2.700mW/g = 8.63 dB mW/g

# Impedance Measurement Plot for Head TSL

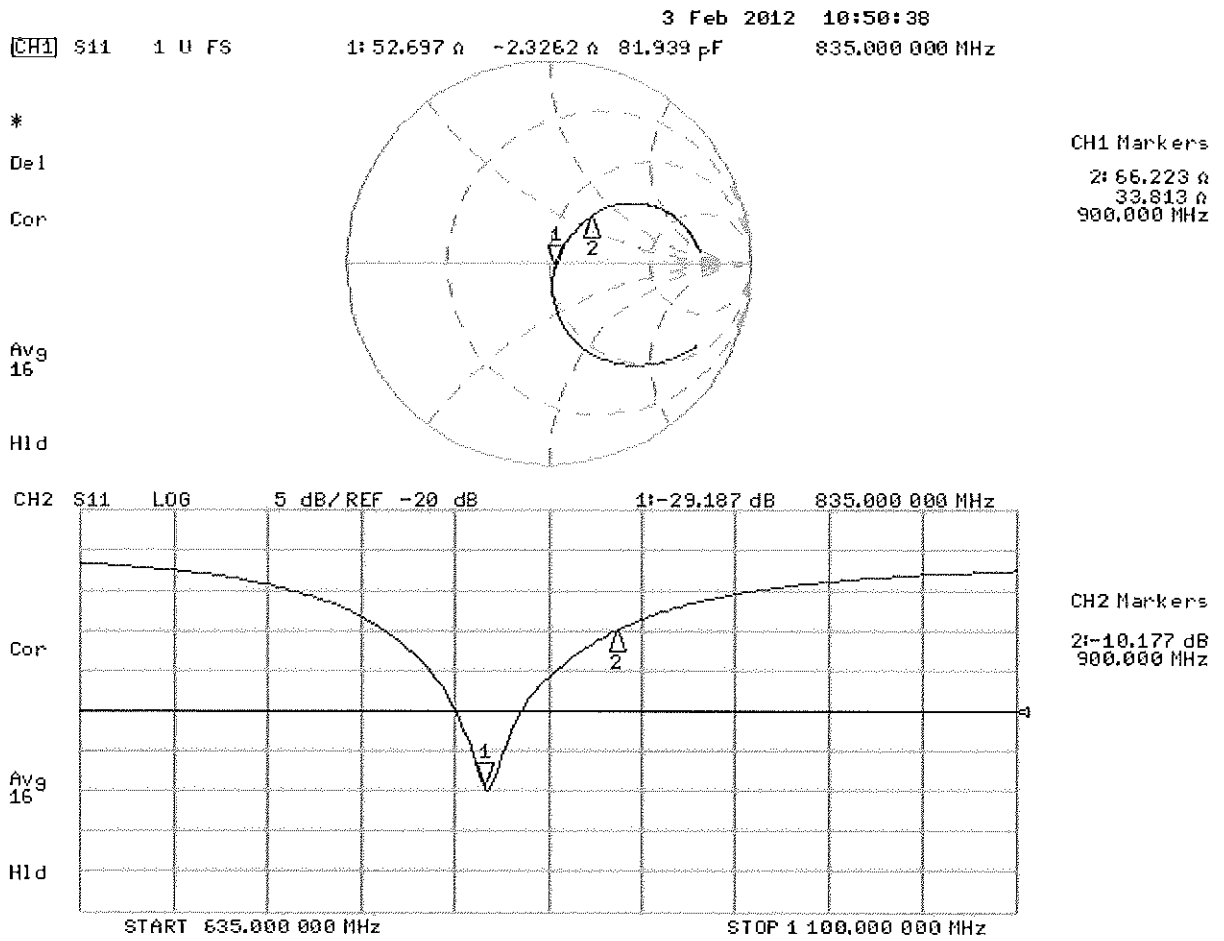

## DASY5 Validation Report for Body TSL

Date: 02.02.2012

Test Laboratory: SPEAG, Zurich, Switzerland

**DUT: Dipole 835 MHz; Type: D835V2; Serial: D835V2 - SN: 4d132**

Communication System: CW; Frequency: 835 MHz

Medium parameters used:  $f = 835$  MHz;  $\sigma = 0.98$  mho/m;  $\epsilon_r = 53.3$ ;  $\rho = 1000$  kg/m<sup>3</sup>

Phantom section: Flat Section

Measurement Standard: DASY5 (IEEE/IEC/ANSI C63.19-2007)

DASY52 Configuration:

- Probe: ES3DV3 - SN3205; ConvF(6.02, 6.02, 6.02); Calibrated: 30.12.2011
- Sensor-Surface: 3mm (Mechanical Surface Detection)
- Electronics: DAE4 Sn601; Calibrated: 04.07.2011
- Phantom: Flat Phantom 4.9L; Type: QD000P49AA; Serial: 1001
- DASY52 52.8.0(692); SEMCAD X 14.6.4(4989)

### Dipole Calibration for Body Tissue/Pin=250 mW, d=15mm/Zoom Scan (7x7x7)/Cube 0:

Measurement grid: dx=5mm, dy=5mm, dz=5mm

Reference Value = 55.137 V/m; Power Drift = 0.01 dB

Peak SAR (extrapolated) = 3.4770

**SAR(1 g) = 2.39 mW/g; SAR(10 g) = 1.57 mW/g**

Maximum value of SAR (measured) = 2.781 mW/g

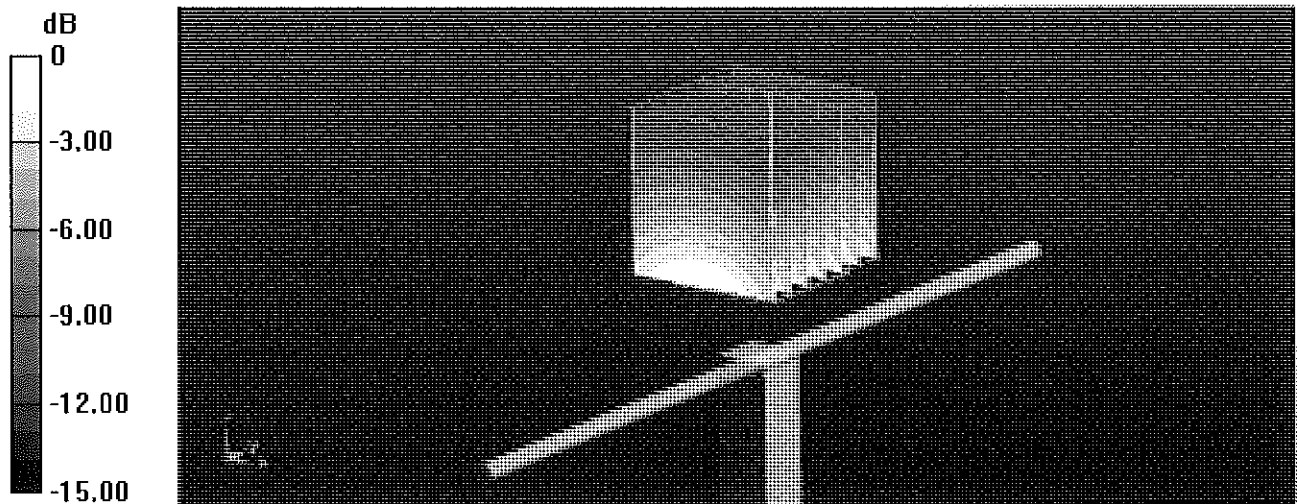

0 dB = 2.780mW/g = 8.88 dB mW/g

# Impedance Measurement Plot for Body TSL

2 Feb 2012 17:18:48

[CH1] S11 1 U FS 1: 48.902  $\Omega$  -3.4570  $\Omega$  55.135 pF 835.000 000 MHz

\*  
De1  
Cor  
Avg  
16  
HI d

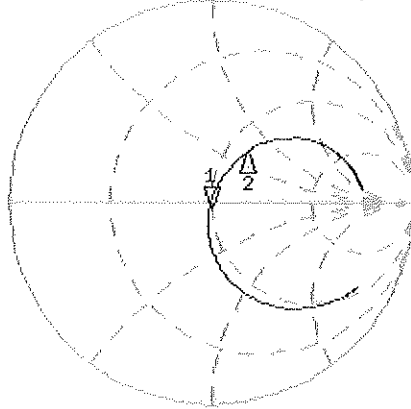

CH1 Markers  
2: 61.023  $\Omega$   
32.770  $\Omega$   
900.000 MHz

CH2 S11 LOG 5 dB/REF -20 dB 1:-28.730 dB 835.000 000 MHz

Cor  
Avg  
16  
HI d

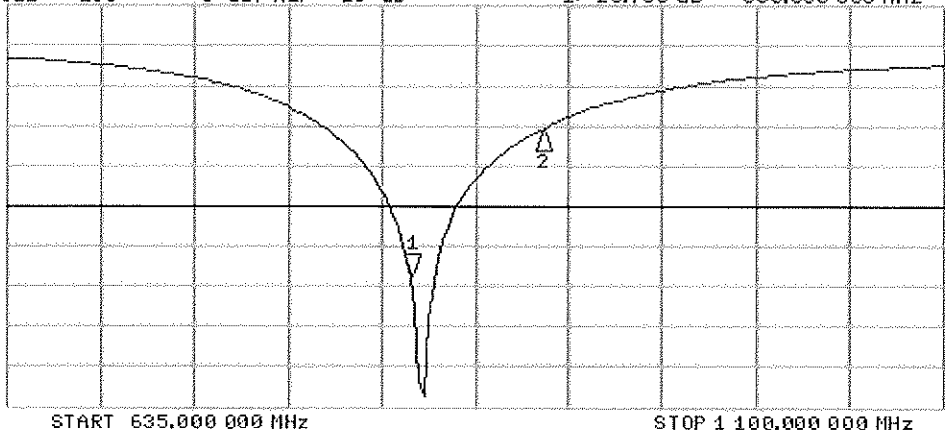

CH2 Markers  
2:-10.497 dB  
900.000 MHz