

08. The schematic and Placement cZ; H! D+' &\$

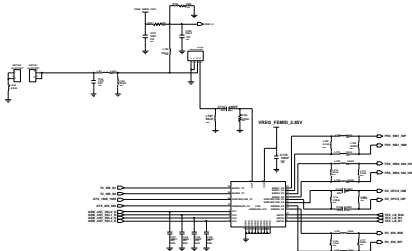

REF	DESCRIPTION	QTY	UNIT
1
2
3
4
5
6
7
8
9
10
11
12
13
14
15
16
17
18
19
20
21
22
23
24
25
26
27
28
29
30
31
32
33
34
35
36
37
38
39
40
41
42
43
44
45
46
47
48
49
50
51
52
53
54
55
56
57
58
59
60
61
62
63
64
65
66
67
68
69
70
71
72
73
74
75
76
77
78
79
80
81
82
83
84
85
86
87
88
89
90
91
92
93
94
95
96
97
98
99
100

SWITCH(MAIN)

AGPS

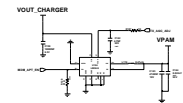
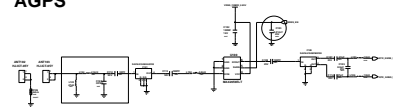

SMPS for VPAM



Shield CAN

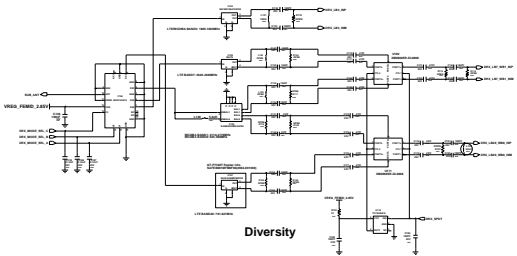

REF	DESCRIPTION	QTY	UNIT
1
2
3
4
5
6
7
8
9
10
11
12
13
14
15
16
17
18
19
20
21
22
23
24
25
26
27
28
29
30
31
32
33
34
35
36
37
38
39
40
41
42
43
44
45
46
47
48
49
50
51
52
53
54
55
56
57
58
59
60
61
62
63
64
65
66
67
68
69
70
71
72
73
74
75
76
77
78
79
80
81
82
83
84
85
86
87
88
89
90
91
92
93
94
95
96
97
98
99
100

Diversity

SWITCHABLE ANT

SUB ANT

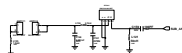

GRIP SENSOR

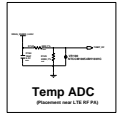
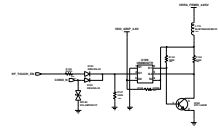
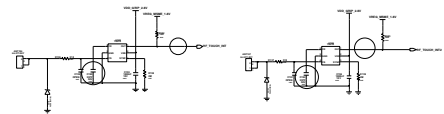

Temp ADC

WARNING: CONFIDENTIAL
 PROPRIETARY AND UNCLASSIFIED
 INFORMATION

2G/3G

WCDMA BAND1
 Tx: 1920-1980MHz Rx: 2110-2170MHz
WCDMA BAND8
 Tx: 880-915MHz Rx: 925-960MHz

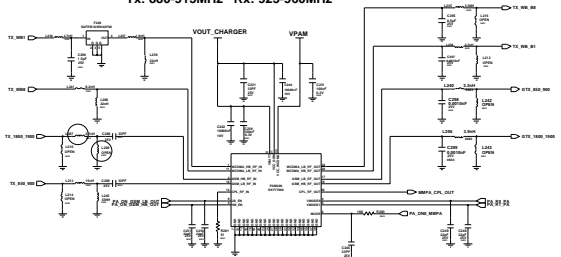

LTE B3

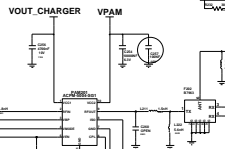

	VMODE	VSP	Gain
High Gain	0	0	27
Mid Gain	1	0	21
Low Gain	1	1	12

LTE/WCDMA BAND3
 Tx: 1710-1785MHz Rx: 1805-1880MHz

LTE B7

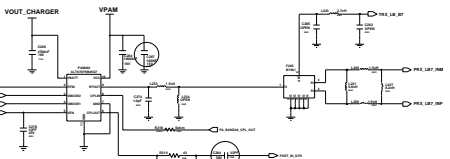

	VMODE	VSP	Gain
High Gain	0	0	27.5
Mid Gain	1	0	17
Low Gain	1	1	11

LTE BAND7
 Tx: 2500-2570MHz Rx: 2620-2690MHz

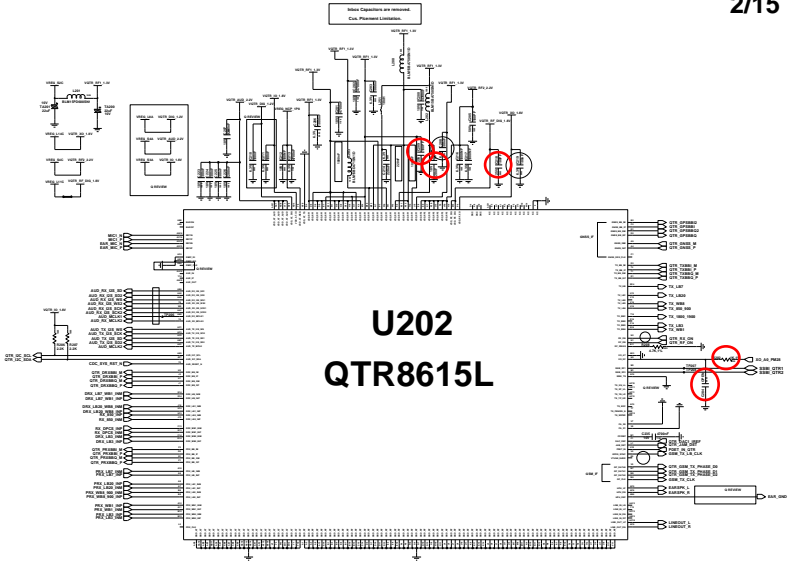

U202
QTR8615L

LTE B20

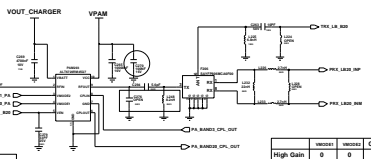

	VMODE	VSP	Gain
High Gain	0	0	26.5
Mid Gain	1	0	20
Low Gain	1	1	13

LTE BAND20
 Tx: 832-862MHz Rx: 791-821MHz

<GT-P7320T Replace Info.>
 1. C276: 1pF, C263: 98pF
 2. L248: 10nH, L225: 4.7nH
 3. PAM203: AWT6625A
 4. F207: SAFEB88M1F00(2904-001668)
 5. F206: SAYFP836MCA0F00(2910-000068)
 6. F107: SAFEB881MFM0F00(2904-001669)

CONFIDENTIAL

UCP400-2 APQ8060-1-AA

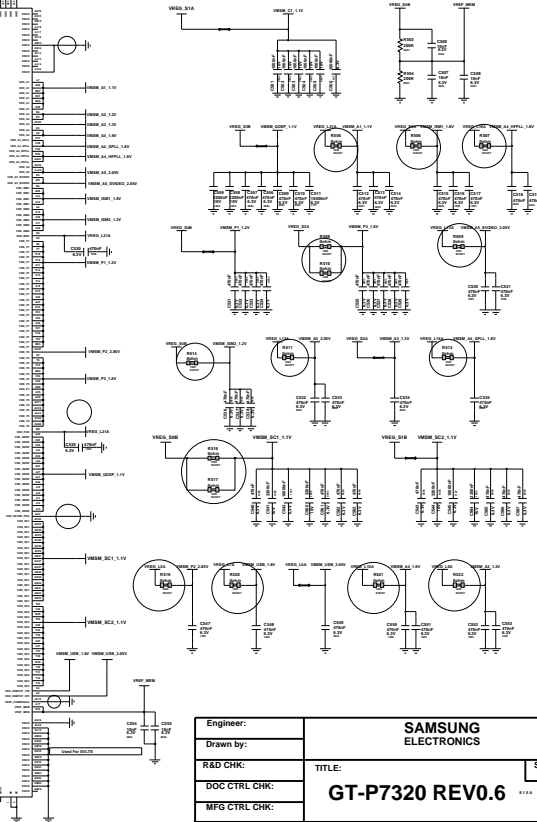

Engineer:	SAMSUNG ELECTRONICS		
Drawn by:			
R&D CHK:	TITLE:	Size: 2	
DOC CTRL CHK:	GT-P7320 REV0.6		
MFG CTRL CHK:			
QA CHK:	REV:	Drawing Number:	Page:

MDM9200 PART

UCP600 MDM9200

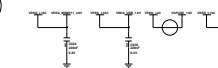
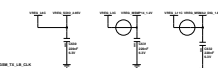
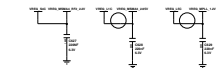
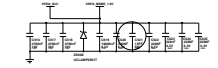
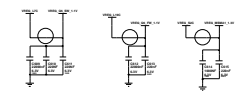
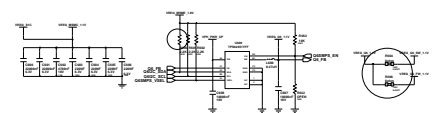
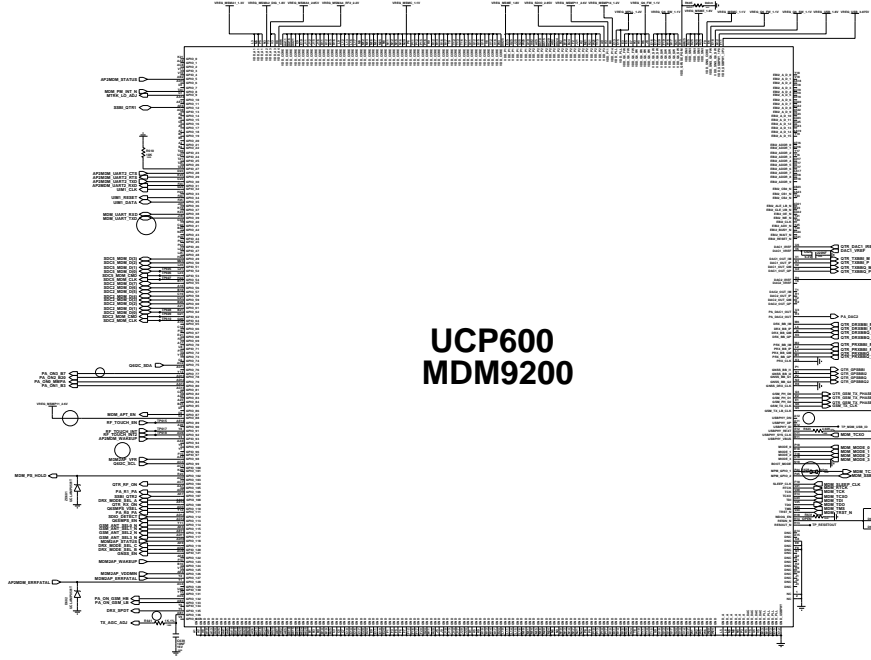

<MODE_SELECT>

Engineer:	SAMSUNG ELECTRONICS	
Drawn by:		
REV'CHK:	TITLE:	Size:
DDC CTRL CHK:	GT-P7320 REV0.6	
WPS ENGR CHK:	REV:	Page:

PM8901 PART

**H/W Ver.
 GT-P7320 REV0.5/7320T REV0.4**

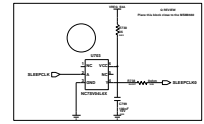
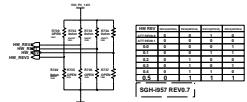
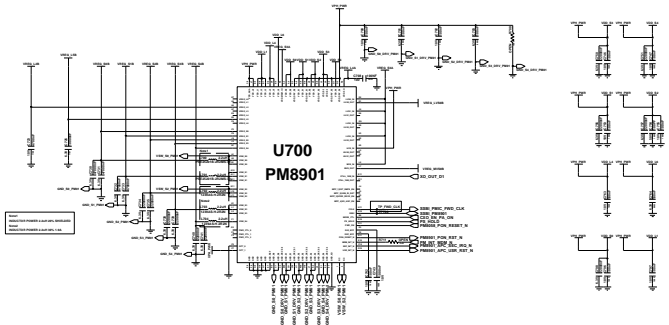

PM8058 PART

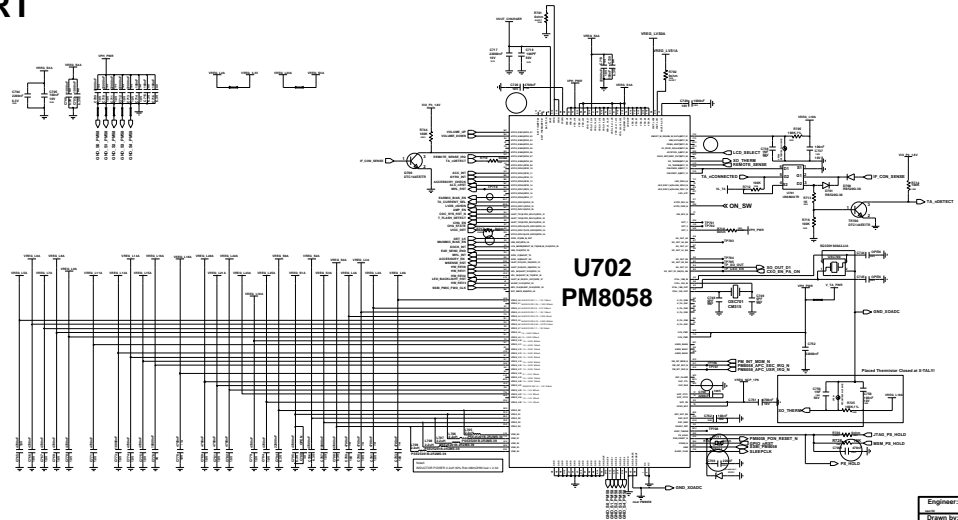

Engineer:	SAMSUNG ELECTRONICS	
Drawn By:	TITLE:	Size:
REV CHK:	GT-P7320 REV0.6
DOC CTRL CHK:		
MFG ENGR CHK:		

CP PMIC & CHARGER PART

<PMIC for MDM9200>

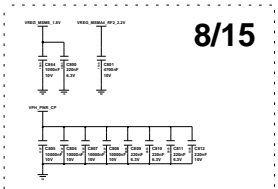
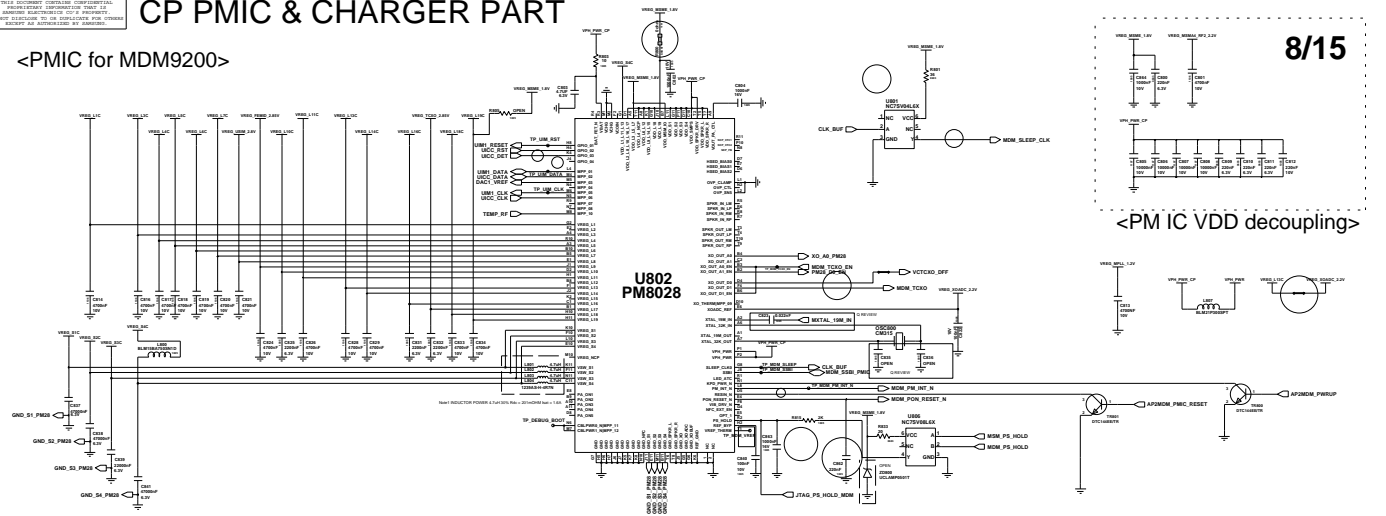

<PM IC VDD decoupling>

8/15

<SWITCHING CHARGING BLOCK>

<EXT_JIG_POWER_CONTROL>

<TCXO for MDM9200>

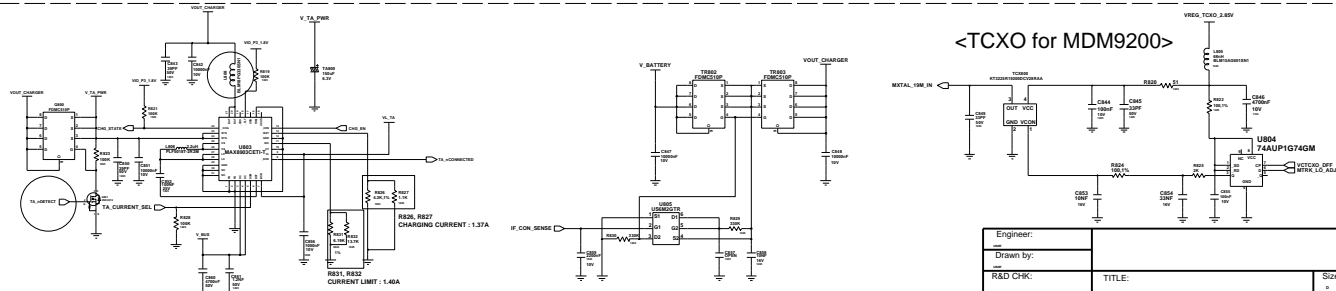

Engineer:		
Drawn by:		
R&D CHK:	TITLE:	Size:
DOC CTRL CHK:	GT-P7320 REV0.6	
MFG CTRL CHK:		
QA CHK:	REV: 0.0	Page: 3 / 3
Changed by:	Drawing Number:	
Date Changed:		
Time:		

AUDIO PART

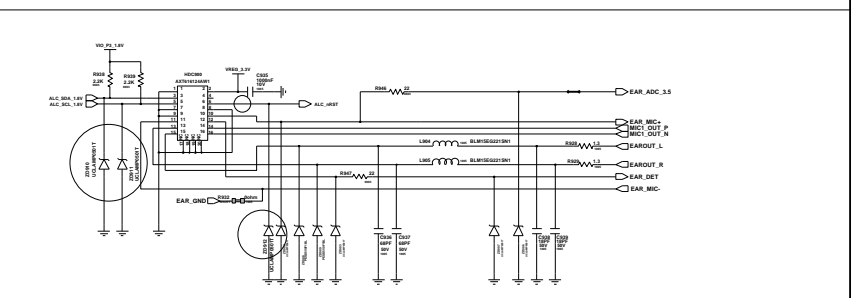
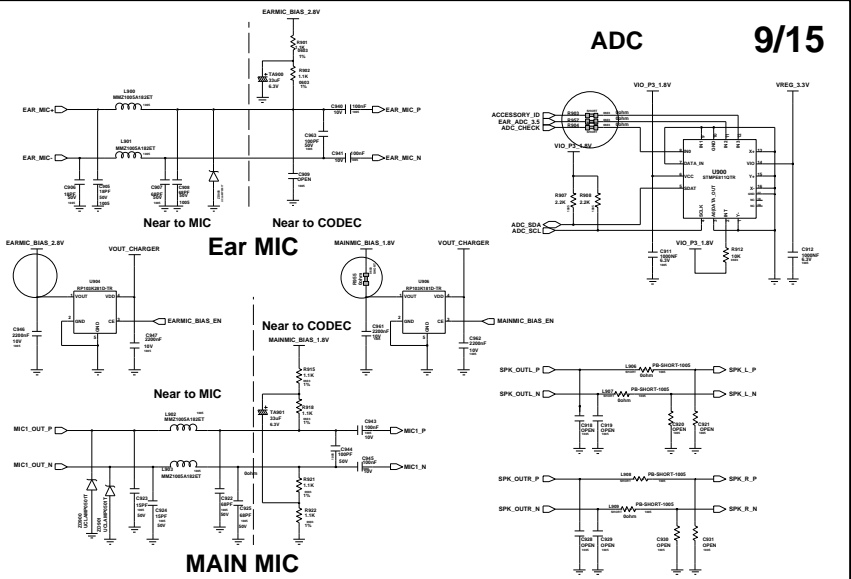
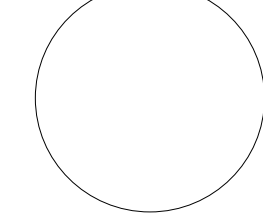
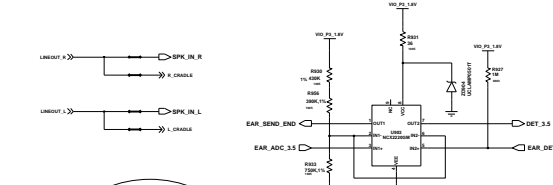
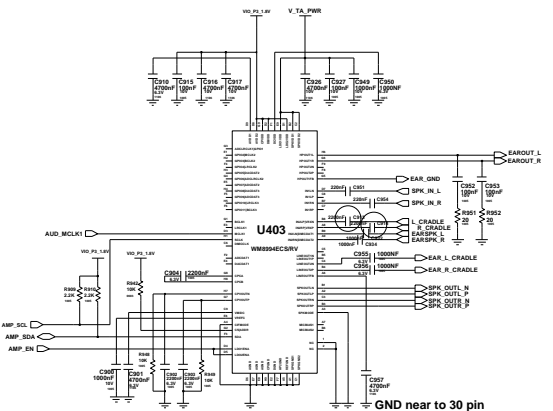

Engineer	
Checked by	
Approved by	
Part No.	GT-P7320 REV0.6
Rev. Chg.	
Issued	

SAMSUNG CONFIDENTIAL
 THIS DOCUMENT CONTAINS CONFIDENTIAL
 AND PROPRIETARY INFORMATION. IT IS NOT TO BE
 REPRODUCED OR TRANSMITTED IN ANY FORM OR
 BY ANY MEANS, ELECTRONIC OR MECHANICAL,
 INCLUDING PHOTOCOPYING, RECORDING, OR BY
 ANY INFORMATION STORAGE AND RETRIEVAL
 SYSTEMS, WITHOUT PERMISSION IN WRITING
 FROM SAMSUNG ELECTRONICS CO., LTD.

TSP PART

12/15

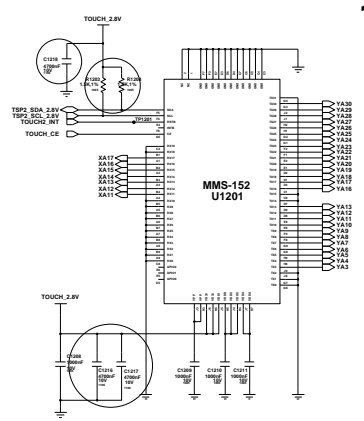
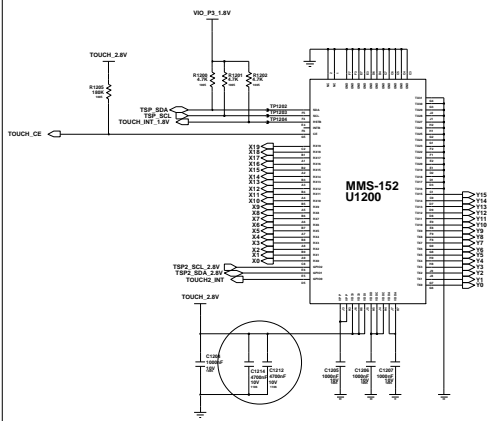
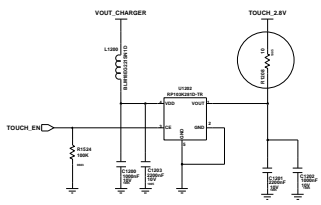

<TOCH SENSOR IC>

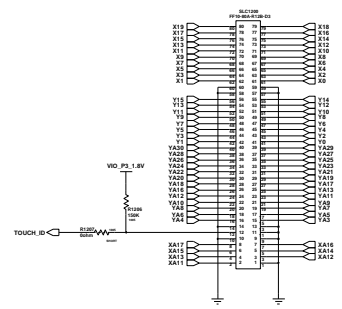

<80Pin TOUCH Con.>

Engineer	TSP Part
Design by	DATE
Check by	REV
Approved by	GT-P7320 REV0.6
Part No.	DATE
Design No.	ISSUE NO.

MHL & SWITCH PART

<MHL>

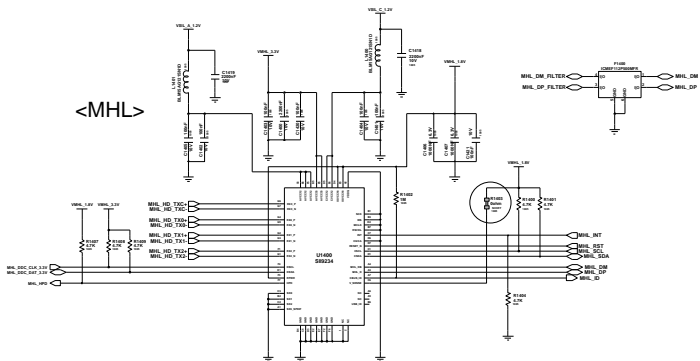

<PCB JTAG>

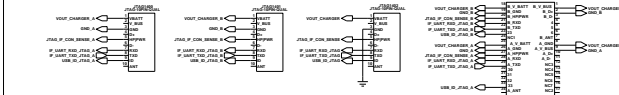

<AP & CP J-TAG >

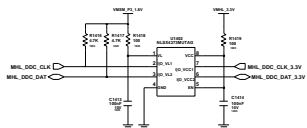
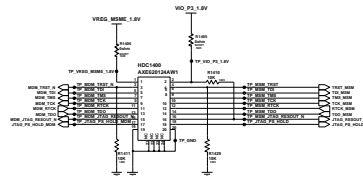

<USB OTG EN>



<UART SWITCH>

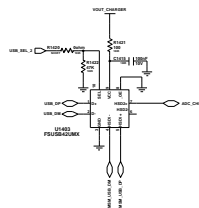
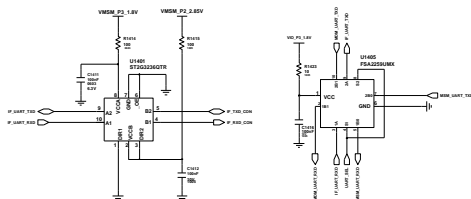

<USB_SWITCH>

Engineer:	SAMSUNG ELECTRONICS		
Drawn by:			
R&D CHK:	TITLE:	Size:	
DOC CTRL CHK:	GT-P7320 REV0.6		
MFG CTRL CHK:	REV:	Drawing Number:	Page:
QA CHK:			10

SENSOR & KEY & MOTOR PART

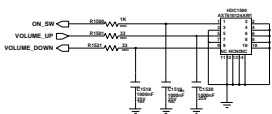

<POWER & VOLUME KEY>

REAL KEY MAP

VOL_UP	VOL_DOWN
MRCL	MRCL

KEYPCB MAP

VOL_UP	VOL_DOWN
MRCL	MRCL
VOLUME_ON_C1208 to V15	

