



SAMSUNG ELECTRONICS Co., Ltd.,  
Regulatory Compliance Group  
129, Samsung-ro  
Yeongtong-gu, Suwon city,  
Gyeonggi-Do, Korea 443-742

## FCC CFR47 PART 22 & 24 SUBPART CERTIFICATION REPORT

**Model Tested** : **GT-I8552**  
**FCC ID (Requested)** : **A3LGTI8552**  
**Report No** : **FK-039-R1**  
**Job No** : **FK-039**  
**Date issued** : **Feb 20, 2013**

- Abstract -

All measurement reported herein accordance with FCC Rules, 47CFR Part2,  
Part22, Part24.

**Prepared By**

---

HK LEE – Test Engineer

**Authorized By**

---

WT JANG – Technical Manager



# TABLE OF CONTENT

<b>MEASUREMENT REPORT</b>	<b>Page</b>
<b>1. FCC CERTIFICATION INFORMATION .....</b>	<b>3</b>
1.1. §2.1033 General Information .....	3
<b>2. INTRODUCTION .....</b>	<b>4</b>
2.1. General .....	4
<b>3. MEASURING INSTRUMENT CALIBRATION .....</b>	<b>5</b>
<b>4. TEST EQUIPMENT LIST .....</b>	<b>6</b>
<b>5. DESCRIPTION OF TESTS .....</b>	<b>7</b>
5.1. Effective Radiated Power / Equivalent Isotropic Radiated Power .....	7
5.2. Radiated Spurious & Harmonic Emission .....	8
5.3. Peak-Average Ratio .....	9
5.4. Occupied Bandwidth .....	10
5.5. Spurious and Harmonic Emission at Antenna Terminal .....	10
5.5.1. Occupied Bandwidth Emission Limits .....	10
5.5.2. Conducted Spurious Emission .....	12
5.6. Frequency Stability / Temperature Variation .....	13
<b>6. TEST DATA .....</b>	<b>14</b>
6.1. Effective Radiated Power (E.R.P.) .....	14
6.2. Equivalent Isotropic Radiated Power (E.I.R.P.) .....	15
6.3. GSM850 Radiated Spurious & Harmonic measurement .....	16
6.4. GSM1900 Radiated Spurious & Harmonic measurement .....	17
6.5. Frequency Stability .....	18
6.5.1. GSM850 Frequency Stability Table .....	18
6.5.2. GSM850 Frequency Stability Graph .....	19
6.5.3. GSM1900 Frequency Stability Table .....	21
6.5.4. GSM1900 Frequency Stability Graph .....	22
<b>7. CONCLUSION .....</b>	<b>24</b>
<b>8. TEST PLOTS .....</b>	<b>25</b>



# MEASUREMENT REPORT

## 1. FCC Certification Information

The following information is in accordance with FCC Rules, 47CFR Part2, Subpart J, Sections 2.1033 – 2.1055.

### 1.1. §2.1033 General Information

- Applicant Name : SAMSUNG ELECTRONICS CO., LTD.
- Address : 129, Samsung-ro, Yeongtong-gu, Suwon City, Gyeonggi-Do, Korea 443-742
- FCC ID : A3LGTI8552
- Model : GT-I8552
- Quantity : Quantity production is planned
- Emission Designators : 248KGXW(GSM850)  
248KGXW(GSM1900)
- Tx Freq. Range : 824.2 - 848.8MHz (GSM850)  
1850.2MHz - 1909.8MHz (GSM1900)
- Rx Freq. Range : 869.2 - 893.8 MHz (GSM850)  
1930.2MHz - 1989.8MHz (GSM1900)
- Max. Power Rating : 0.085 W ERP GSM850 (19.27 dBm)  
0.849 W EIRP GSM1900 (29.29 dBm)
- FCC Classification(s) : PCS Licensed Portable Tx Held to Ear (PCE)
- Equipment (EUT) Type : Portable Handset
- Device Capabilities : 850/1900 GSM/GPRS Phone with Bluetooth, EDGE Rx only and WLAN
- Frequency Tolerance :  $\pm 0.00025\%$  (2.5ppm)
- FCC Rule Part(s) : §24(E), §22(H), §2.
- Dates of Test : February 8-9, 2013
- Place of Test : SAMSUNG Lab,
- Test Report S/N : FK-039-R1

## 2. INTRODUCTION

### 2.1. General

These measurement tests were conducted at **SAMSUNG ELECTRONICS CO., LTD(SUWON)** facility located at 129, Samsung-ro, Yeongtong-gu, Suwon City, Gyeonggi-Do, Korea 443-742. The site has 1 Fully-anechoic chamber and measurement facility.

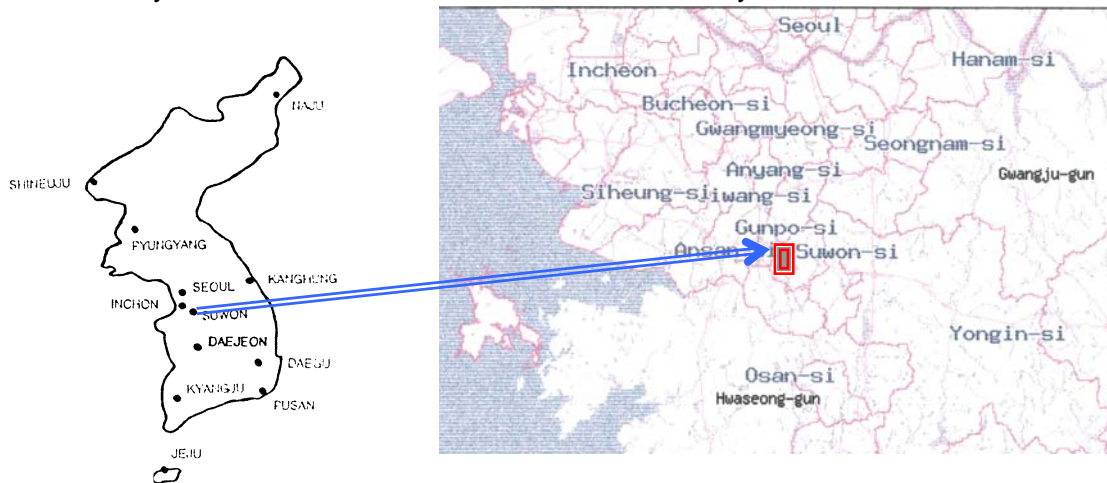

**Figure1. Map of the Suwon City area.**

### **Measurement Procedure**

The radiated and spurious measurements were made Fully-anechoic chamber at a 3-meter test range (see Figure2). The equipment under testing was placed on the rotating device at the same height and a distance of 3-meters from the receive antenna. The rotating device which can rotate horizontal axis was mounted on the turn unit to facilitate rotation around a vertical axis. The measurement was made for each horizontal/vertical position combination with receive antenna horizontally polarized. This measurement was repeated with receive antenna vertically polarized. The substitution antenna will replace the EUT antenna at the same position and in vertical polarization. The frequency of the signal generator shall be set to the frequencies that were measured on the EUT. The signal generator, output level, shall be adjusted until an equal or a known related level to what was measured from the EUT is obtained in the spectrum analyzer. This level was recorded. For readings above 1 GHz, the above procedure is repeated using horn antennas and the difference between the gain of the horn and an isotropic antenna is taken into consideration.



**Figure2. Photograph of 3m Fully-Anechoic Chamber**

### **3. MEASURING INSTRUMENT CALIBRATION**

The measuring equipments, which were utilized in performing the tests documented herein, have been calibrated in accordance with the manufacturer's recommendations for utilizing calibration equipment, which is traceable to recognized national standards.

– End of page –



#### 4. TEST EQUIPMENT LIST

Name Of Equipment	Model	Serial No.	Cal. Date	Due Date
Spectrum Analyzer	ESI26	836119/010	2012-10-18	2013-10-18
	E4440A(3Hz~26.5GHz)	MY46187454	2012-03-14	2013-03-14
	E4440A(3Hz~26.5GHz)	MY41000236	2012-04-26	2013-04-26
Signal Generator	SMR20	835197/030	2012-11-23	2013-11-23
Network Analyzer	8753E	JP38160590	2012-06-19	2013-06-19
Pre-Amplifier	8449B	3008A00691	2012-11-23	2013-11-23
Communication test set	E5515C	MY47510060	2012-03-05	2013-03-05
	E5515C	GB42360886	2012-08-20	2013-08-20
Controller	CO2000	CO2000/424	Not Required	Not Required
Turn Unit	CT0800	CT0800/057	Not Required	Not Required
Rotating Device	DE3600-RH-PR	DE3600-RH-PR/050	Not Required	Not Required
Antenna Master	MA4000	MA4000/204	Not Required	Not Required
Horn Antenna	HF906	100134	2012-08-13	2014-08-13
	BBHA9120	9120D-637	2011-09-14	2013-09-14
Dipole Antenna	UHA 9105	9105-2412	2011-09-09	2013-09-09
	UHA 9105	9105-2413	2012-07-20	2014-07-20
Receive Antenna	HL040	353255/019	2011-09-05	2013-09-05
Power Supply	E3640A	MY40003594	2012-06-19	2013-06-19
	E3640A	MY40003595	2012-05-16	2013-05-16
	E3632A	MY40022438	2012-03-02	2013-03-02
Divider	11636B	58456	2012-04-03	2013-04-03
	11636B	51942	2012-07-11	2013-07-11
	11636B	58459	2012-04-03	2013-04-03
	11636B	56918	2012-09-24	2013-09-24
High Pass Filter	WHK/3.0/18G-10SS	492	2012-04-09	2013-04-09
	WHK/3.5/18G-10SS	4	2012-04-09	2013-04-09
Environmental Chamber	SH-241	92000548	2012-11-07	2013-11-07
	SH-241	92000549	2012-11-07	2013-11-07
Shielded Fully Anechoic Chamber	CHAMBER	ANT0001	Not Required	Not Required

## 5. DESCRIPTION OF TESTS

### 5.1. Effective Radiated Power / Equivalent Isotropic Radiated Power

#### Test Set-up for the ERP/EIRP TEST

Effective Radiated Power Output and Equivalent Isotropic Radiated Power output Measurements by Substitution Method according to ANSI/TIA/EIA-603-C-2004

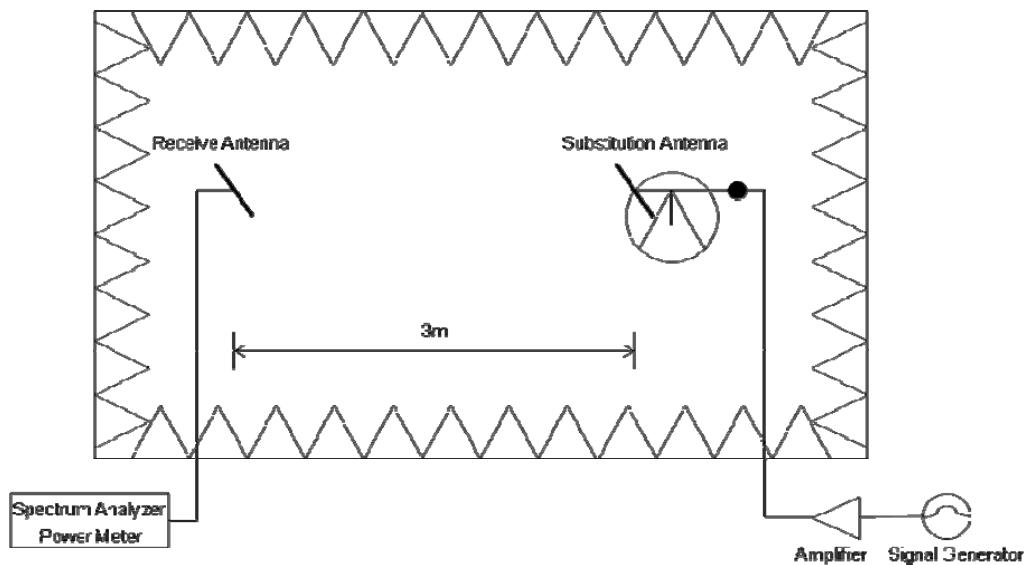

**Figure 3. Diagram of ERP/EIRP test Set-up**

The EUT was placed on the rotating device at 3-meters from the receive antenna and tested in 3 orthogonal planes. The turn unit and rotating device were adjusted for the highest reading on the receive spectrum analyzer. For GSM signals, an average detector is used, with RBW=VBW=3MHz, SPAN=10MHz. A half-wave dipole and Horn antenna were substituted in place of the EUT. This dipole antenna was driven by a signal generator and the level of the signal generator was adjusted to obtain the same receive spectrum analyzer reading. The conducted power at the terminals of dipole is measured. The ERP and EIRP are recorded. For readings above 1GHz, the above procedure is repeated using horn antennas and the difference between the gain of the horn and an isotropic or dipole antenna is taken into consideration.

## 5.2. Radiated Spurious & Harmonic Emission

### Test Set-up for the Radiated Emission TEST

Radiated Spurious Emission Measurements by Substitution Method according to ANSI/TIA/EIA-603-C-2004

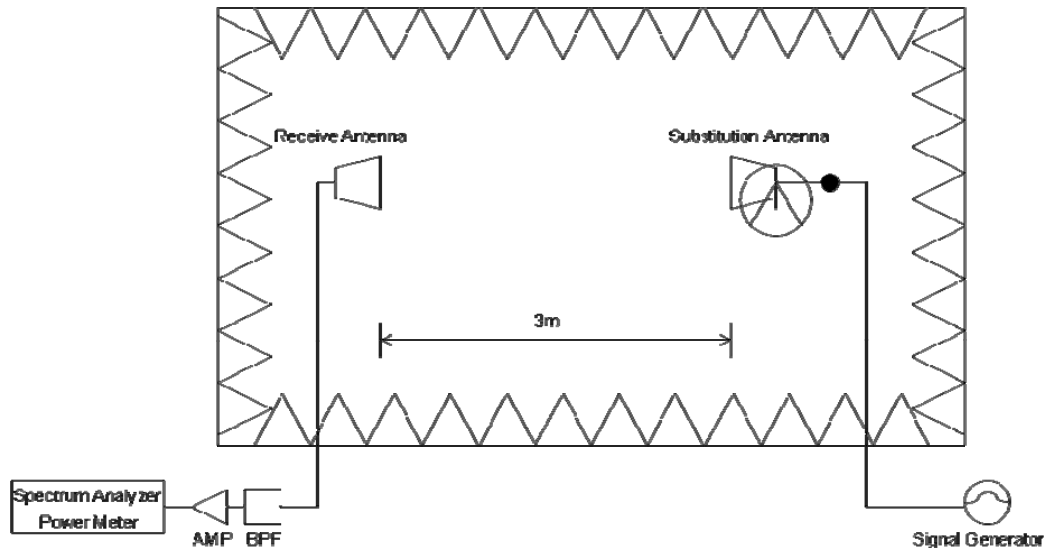

**Figure 4. Diagram of Radiated Spurious & Harmonic test Set-up**

The EUT was placed on the rotating device at 3-meters from the receive antenna and tested in 3 orthogonal planes. The turn unit and rotating device were adjusted for the highest reading on the receive spectrum analyzer. The Spectrum was investigated from 30MHz to the 10<sup>th</sup> Harmonic of the fundamental. A peak detector is used, with RBW=VBW=1MHz. The value that could be measured was only reported. A half-wave dipole was substituted in place of the EUT. This dipole antenna was driven by a signal generator and the level of the signal generator was adjusted to obtain the same receive spectrum analyzer reading. This spurious level is recorded. For readings above 1GHz, the above procedure is repeated using horn antennas and the difference between the gain of the horn and an isotropic or dipole antenna is taken into consideration.

## SAMPLE CALCULATION

### Example: Channel 661, Second Harmonic(3760.00MHz)

The receive analyzer reading at 3meters with the EUT on the turntable was  $-81.0\text{dBm}$ . The gain of the substituted antenna is  $8.1\text{dBi}$ . The signal generator connected to the substituted antenna terminals is adjusted to produce a reading of  $-81.0\text{dBm}$  of the receive analyzer. The loss of the cable between the signal generator and the terminal of the substituted antenna is  $2.0\text{dB}$  at  $3760.00\text{MHz}$ . So  $6.1\text{dB}$  is added to the signal generator reading of  $-30.9\text{dBm}$  yielding  $-24.8\text{dBm}$ . The fundamental EIRP was  $25.5\text{dBm}$  so this harmonic was  $25.5\text{dBm} - (-24.8) = 50.3\text{dBc}$ .

### 5.3. Peak-Average Ratio

A peak to average ratio measurement is performed at the conducted port of the EUT. An average and a peak trace are used on a spectrum analyzer to determine the largest deviation between the average and the peak power of the EUT in a given bandwidth.

#### ※ RF Conduction Test set-up

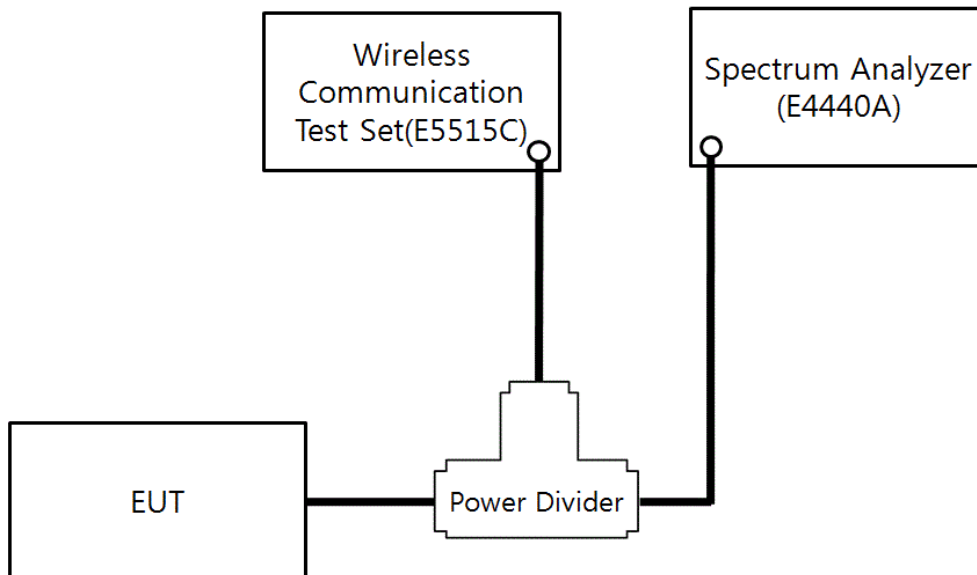

## 5.4.Occupied Bandwidth

### **Test Procedure**

The occupied bandwidth, that is the frequency bandwidth such that, below its lower and above its upper frequency limits, the mean powers radiated are each equal to 0.5 percent of the total mean power radiated by a given emission shall be measured. The span of the analyzer shall be set to capture all products of the modulation process, including the emission skirts. The resolution and video bandwidth shall be set to as close to 1 percent of the selected span as is possible without being below 1 percent. Video averaging is not permitted. The trace data points are recovered and are directly summed in linear terms. The recovered amplitude data points, beginning at the lowest frequency, are placed in a running sum until 0.5 percent of the total is reached and that frequency recorded. The process is repeated for the highest frequency data points. These frequency data points are recorded. The span between the two recorded frequencies is the occupied bandwidth. These measurements were performed on Agilent E4440A Spectrum Analyzer, and use analyzer's bandwidth measurement function.

## 5.5. Spurious and Harmonic Emission at Antenna Terminal

### 5.5.1. Occupied Bandwidth Emission Limits

#### **Part 24**

- (a) On any frequency outside a licensee's frequency block, the power of any emission shall be attenuated below the transmitter power (P) by at least  $43 + 10 \log(P)$  dB.
- (b) Compliance with these provisions is based on the use of measurement instrumentation employing a resolution bandwidth of 1 MHz or greater. However, in the 1MHz bands immediately outside and adjacent to the frequency block a resolution bandwidth of at least one percent of the emission bandwidth of the fundamental emission of the transmitter may be employed. The emission bandwidth is defined as the width of the signal between two points, one below the carrier center frequency and one above the carrier center frequency, outside of which all emission are attenuated at least 26 dB below the transmitter power.
- (c) When measuring the emission limits, the nominal carrier frequency shall be adjusted as close to the licensee's frequency block edges, both upper and lower, as the design permits.

#### **Part 22**

- (a) Out of band emissions. The power of any emission outside of the authorized operating frequency ranges must be attenuated below the transmitting power (P) by a factor of at least  $43 + 10 \log(P)$  dB.
- (b) Compliance with these rules is based on the use of measurement instrumentation employing a resolution bandwidth of 100 kHz or greater. In the 1 MHz bands immediately outside and adjacent to the frequency block a resolution band-width of at least one percent of the emission bandwidth of the



fundamental emission of the transmitter may be employed. A narrower resolution band-width is permitted in all cases to improve measurement accuracy provided the measured power is integrated over the full required measurement band-width (i.e. 100 kHz or 1 percent of emission bandwidth, as specified). The emission bandwidth is defined as the width of the signal between two points, one below the carrier center frequency and one above the carrier center frequency, outside of which all emissions are attenuated at least 26 dB below the transmitter power.

<b>BLOCK</b>	<b>Freq. Range (MHz) Transmitter (Tx)</b>	<b>Freq. Range (MHz) Receiver (Rx)</b>
A	1850 – 1865	1930 – 1945
B	1870 – 1885	1950 – 1965
C	1895 – 1910	1975 – 1990
D	1865 – 1870	1945 – 1950
E	1885 – 1890	1965 – 1970
F	1890 – 1895	1970 – 1975

**Table 1. Broadband PCS Service Frequency Blocks**

<b>BLOCK</b>	<b>Freq. Range (MHz) Transmitter (Tx)</b>	<b>Freq. Range (MHz) Receiver (Rx)</b>
A* Low + A	824 ~ 835	869 ~ 880
B	835 ~ 845	880 ~ 890
A* High	845 ~ 846.5	890 ~ 891.5
B*	846.5 ~ 849	891.5 ~ 894

**Table 2. Cellular Service Frequency Blocks**

## 5.5.2. Conducted Spurious Emission

### **Minimum standard:**

On any frequency outside a license frequency block, the power of any emission shall be attenuated below the transmitter power(P) by at least  $43+10\log(P)$ dB. Limit equivalent to -13dBm, calculation shown below.

$$43 + 10\log(0.085 \text{ W}) = 32.29 \text{ dB}$$
$$19.27 \text{ dBm} - 32.29 \text{ dB} = -13 \text{ dBm}$$

Compliance with the out-of-band emissions requirement is based on test being performed with an analyzer resolution bandwidth of 1MHz. However in the 1MHz band immediately outside and adjacent to the frequency block a resolution bandwidth of at least 1% of the fundamental emissions bandwidth may be employed.

Example)  
In case of GSM :  $0.01 * 273\text{KHz} = 2.73\text{KHz}$

A Resolution BW of 3KHz was used for measurement at the band edges.

### **Test Procedure:**

The EUT is setup to maximum output power at its lowest channel. The Resolution BW of the analyzer is set to 1% of the emission bandwidth to show compliance with the -13dBm limit, in the 1MHz bands immediately outside and adjacent to the edge of the frequency block. The measurements are repeated for the EUT's highest channel. For the Out-of-Band measurements 1MHz RBW is used to scan from 10MHz to 10GHz. (GSM1900 Mode : 10MHz to 20GHz). A display line is placed at -13dBm to show compliance. The high, lowest and a middle channel are tested for out of band measurements.

Plots are shown herein.

## 5.6. Frequency Stability / Temperature Variation

The frequency stability of the transmitter is measured by:

- a.) Temperature: The temperature is carried from -30°C to +50°C using an environmental chamber.
- b.) Primary Supply Voltage: The primary supply voltage is varied from 85% to 115% of the voltage normally at the input to the device or at the power supply terminals if cables are not normally supplied.

Specification - The frequency stability shall be sufficient to ensure that the fundamental emission stays within the authorized frequency block. The frequency stability of the transmitter shall be maintained within  $\pm 0.00025$  ( $\pm 2.5$ ppm) of the center frequency.

Time Period and Procedure:

1. The carrier frequency of the transmitter and the individual oscillators is measured at room temperature (25°C to 27°C to provide a reference).
2. The equipment is subjected to an overnight "soak" at -30°C without any power applied.
3. After the overnight "soak" at -30°C (Usually 14~16 hours), the equipment is turned on in a "standby" condition for one minute before applying power to the transmitter. Measurement of the carrier frequency of the transmitter and the individual oscillators is made within a three minutes interval after applying to the transmitter.
4. Frequency measurements are made at 10°C interval up to room temperature. At least a period of one or one half-hour is provided to allow stabilization of the equipment at each temperature level.
5. Again the carrier frequency of the transmitter and the individual oscillators is measured at room temperature to begin measurement of the upper temperature levels.
6. Frequency measurements are at 10 intervals starting at -30°C up to +50°C allowing at least two hours at each temperature for stabilization. In all measurements the frequency is measured within three minutes after re-applying power to the transmitter.
7. The artificial load is mounted external to the temperature chamber.

NOTE : The EUT is tested down to the battery endpoint.



## 6. TEST DATA

### 6.1. Effective Radiated Power (E.R.P.)

Supply Voltage : 3.7VDC

Modulation : GSM850

#### ■ Result

Frequency [MHz]	Tested level [dBm]	Substitute Level [dBm]	Antenna Gain [dBd]	POL [H/V]	ERP [dBm]	ERP [W]	Battery
824.20	-17.07	20.22	-1.95	H	18.27	0.067	Standard
836.60	-18.37	20.47	-1.72	H	18.75	0.075	Standard
848.80	-19.40	20.85	-1.58	H	19.27	0.085	Standard

NOTE : Standard batteries are the only battery options for this phone

- All modes of operation were investigated, and the worst-case results were reported.

**Radiated measurements at 3 meters by Substitution Method**



## 6.2. Equivalent Isotropic Radiated Power (E.I.R.P.)

Supply Voltage : 3.7VDC

Modulation : PCS 1900

### ■ Result

Frequency [MHz]	Tested level [dBm]	Substitute Level [dBm]	Antenna Gain [dBi]	POL [H/V]	EIRP [dBm]	EIRP [W]	Battery
1850.20	-21.36	18.02	10.16	V	28.18	0.658	Standard
1880.00	-20.93	19.13	10.16	V	29.29	0.849	Standard
1909.80	-21.04	18.76	10.16	V	28.92	0.780	Standard

NOTE : Standard batteries are the only battery options for this phone

- All modes of operation were investigated, and the worst-case results were reported.

### **Radiated measurements at 3 meters by Substitution Method**

### 6.3. GSM850 Radiated Spurious & Harmonic measurement

Operating Frequency : 824.20 MHz(Low), 836.60MHz(Middle), 848.80MHz(High)

Measured Output Power : 19.27 dBm = 0.085 W

Modulation Signal : GSM850

Limit :  $43 + 10\log_{10}(P) = 32.29$  dBc

Result(dBc) = Output Power(ERP, dBm) - Spurious Emission Level(dBm)

#### ■ Result

Channel	Frequency [MHz]	Level @ Antenna Terminals (dBm)	Substitute Antenna Gain [dBd]	Spurious Emission Level [dBm]	Result [dBc]	POL [H/V]
128	1648.40	-55.31	9.40	-45.91	65.18	H
	2472.60	-56.47	10.60	-45.87	65.14	H
	3296.80	-55.59	12.00	-43.59	62.86	H
	4121.00	-	-	-	-	-
	4945.20	-	-	-	-	-
	5769.40	-	-	-	-	-
190	1673.20	-50.51	9.40	-41.11	60.38	H
	2509.80	-56.90	10.60	-46.30	65.57	V
	3346.40	-55.50	12.00	-43.50	62.77	V
	4183.00	-	-	-	-	-
	5019.60	-	-	-	-	-
	5856.20	-	-	-	-	-
251	1697.60	-46.94	9.40	-37.54	56.81	H
	2546.40	-56.68	10.60	-46.08	65.35	V
	3395.20	-55.20	12.00	-43.20	62.47	H
	4244.00	-	-	-	-	-
	5092.80	-	-	-	-	-
	5941.60	-	-	-	-	-

#### NOTE :

1. "-" Indicates the spurious emission could not be detected due to noise limitations or ambient.
2. The spectrum is measured from 30MHz to the 10<sup>th</sup> harmonic and all modes of operation are investigated, and the worst-case results are reported.

#### Radiated Spurious Emission measurements at 3 meters by Substitution Method

## 6.4. GSM1900 Radiated Spurious & Harmonic measurement

Operating Frequency : 1850.2 MHz(Low), 1880.00 MHz(Middle), 1909.80 MHz(High)

Measured Output Power : 29.29 dBm = 0.849 W

Modulation Signal : GSM1900

Limit :  $43 + 10\log_{10}(P) = 42.29$  dBc

### Result

Channel	Frequency [MHz]	Level @ Antenna Terminals (dBm)	Substitute Antenna Gain [dBi]	Spurious Emission Level [dBm]	Result [dBc]	POL [H/V]
512	3700.40	-50.68	12.60	-38.08	67.37	V
	5550.60	-46.15	12.50	-33.65	62.94	H
	7400.80	-42.69	11.50	-31.19	60.48	V
	9251.00	-	-	-	-	-
	11101.20	-	-	-	-	-
	12951.40	-	-	-	-	-
661	3760.00	-50.70	12.60	-38.10	67.39	H
	5640.00	-47.59	12.50	-35.09	64.38	H
	7520.00	-41.87	11.50	-30.37	59.66	V
	9400.00	-	-	-	-	-
	11280.00	-	-	-	-	-
	13160.00	-	-	-	-	-
810	3819.60	-49.52	12.60	-36.92	66.21	V
	5729.40	-46.78	12.50	-34.28	63.57	V
	7639.20	-43.06	11.50	-31.56	60.85	V
	9549.00	-	-	-	-	-
	11458.80	-	-	-	-	-
	13368.60	-	-	-	-	-

#### NOTE :

1. "-" Indicates the spurious emission could not be detected due to noise limitations or ambient.
2. The spectrum is measured from 30MHz to the 10<sup>th</sup> harmonic and all modes of operation are investigated, and the worst-case results are reported.

#### Radiated Spurious Emission measurements at 3 meters by Substitution Method

## 6.5. Frequency Stability

### 6.5.1. GSM850 Frequency Stability Table

Operating Frequency : 836,600,000 Hz

Channel : 190

Reference Voltage : 3.7VDC

Deviation Limit :  $\pm 0.00025$  % or 2.5ppm

Voltage [%]	Power [VDC]	Temp. [°C]	Frequency Error [Hz]	Frequency [Hz]	Deviation [%]	ppm
100%	3.70	+20(Ref)	17.60	836,600,018	0.000002	0.021
100%		-30	12.60	836,600,013	0.000002	0.015
100%		-20	-40.70	836,599,959	-0.000005	-0.049
100%		-10	8.10	836,600,008	0.000001	0.010
100%		0	-14.40	836,599,986	-0.000002	-0.017
100%		+10	28.90	836,600,029	0.000003	0.035
100%		+20	17.60	836,600,018	0.000002	0.021
100%		+30	-18.20	836,599,982	-0.000002	-0.022
100%		+40	-43.80	836,599,956	-0.000005	-0.052
100%		+50	-39.10	836,599,961	-0.000005	-0.047
115%	4.26	+20	2.50	836,600,003	0.000000	0.003
Batt.Endpoint	3.35	+20	35.50	836,600,036	0.000004	0.042

**Note :** The temperature is varied from -30 °C to +50 °C using an environmental chamber.

The EUT is tested down to the battery end point.

### 6.5.2. GSM850 Frequency Stability Graph

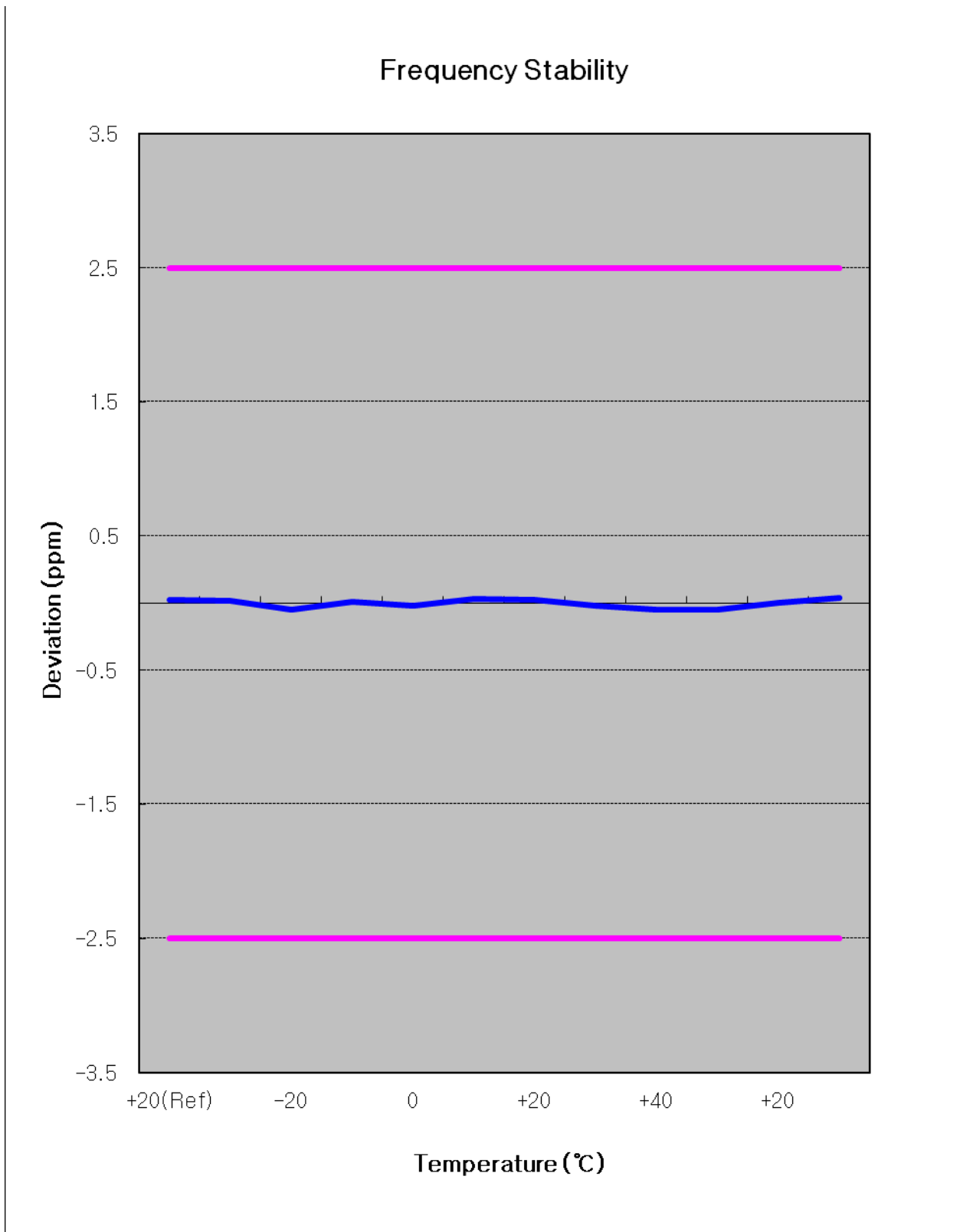

**Zoom IN**

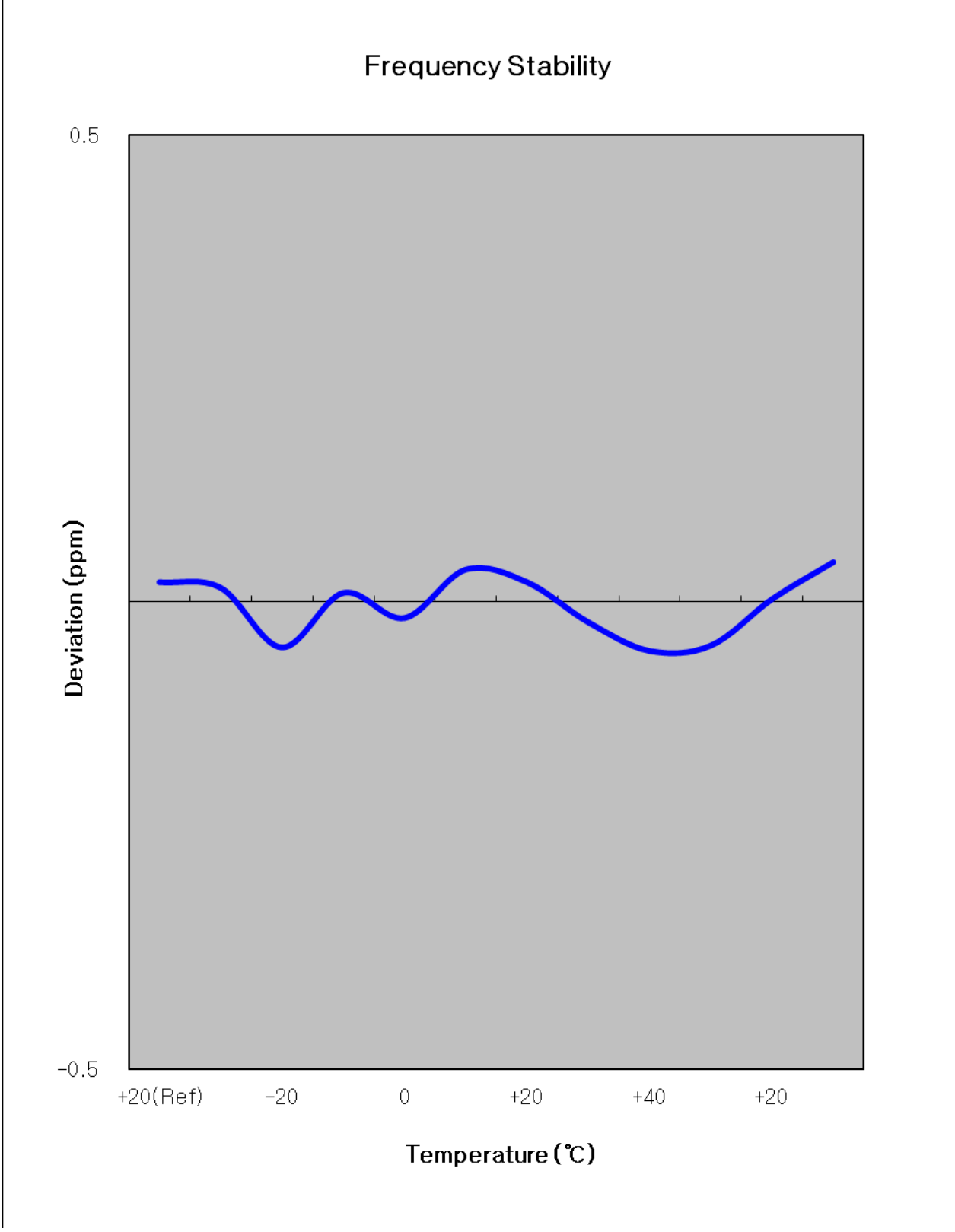

### 6.5.3. GSM1900 Frequency Stability Table

Operating Frequency : 1,880,000,000 Hz

Channel : 661

Reference Voltage : 3.7VDC

Deviation Limit :  $\pm 0.00025$  % or 2.5ppm

Voltage [%]	Power [VDC]	Temp. [°C]	Frequency Error [Hz]	Frequency [Hz]	Deviation [%]	ppm
100%	3.70	+20(Ref)	31.00	1,880,000,031	0.000002	0.016
100%		-30	24.50	1,880,000,025	0.000001	0.013
100%		-20	-3.60	1,879,999,996	0.000000	-0.002
100%		-10	28.40	1,880,000,028	0.000002	0.015
100%		0	-27.10	1,879,999,973	-0.000001	-0.014
100%		+10	25.20	1,880,000,025	0.000001	0.013
100%		+20	31.00	1,880,000,031	0.000002	0.016
100%		+30	-18.40	1,879,999,982	-0.000001	-0.010
100%		+40	11.70	1,880,000,012	0.000001	0.006
100%		+50	44.20	1,880,000,044	0.000002	0.024
115%		4.26	+20	-6.80	1,879,999,993	0.000000
Batt.Endpoint	3.35	+20	-34.20	1,879,999,966	-0.000002	-0.018

Note : The temperature is varied from -30 °C to +50 °C using an environmental chamber.

The EUT is tested down to the battery end point.

### 6.5.4. GSM1900 Frequency Stability Graph

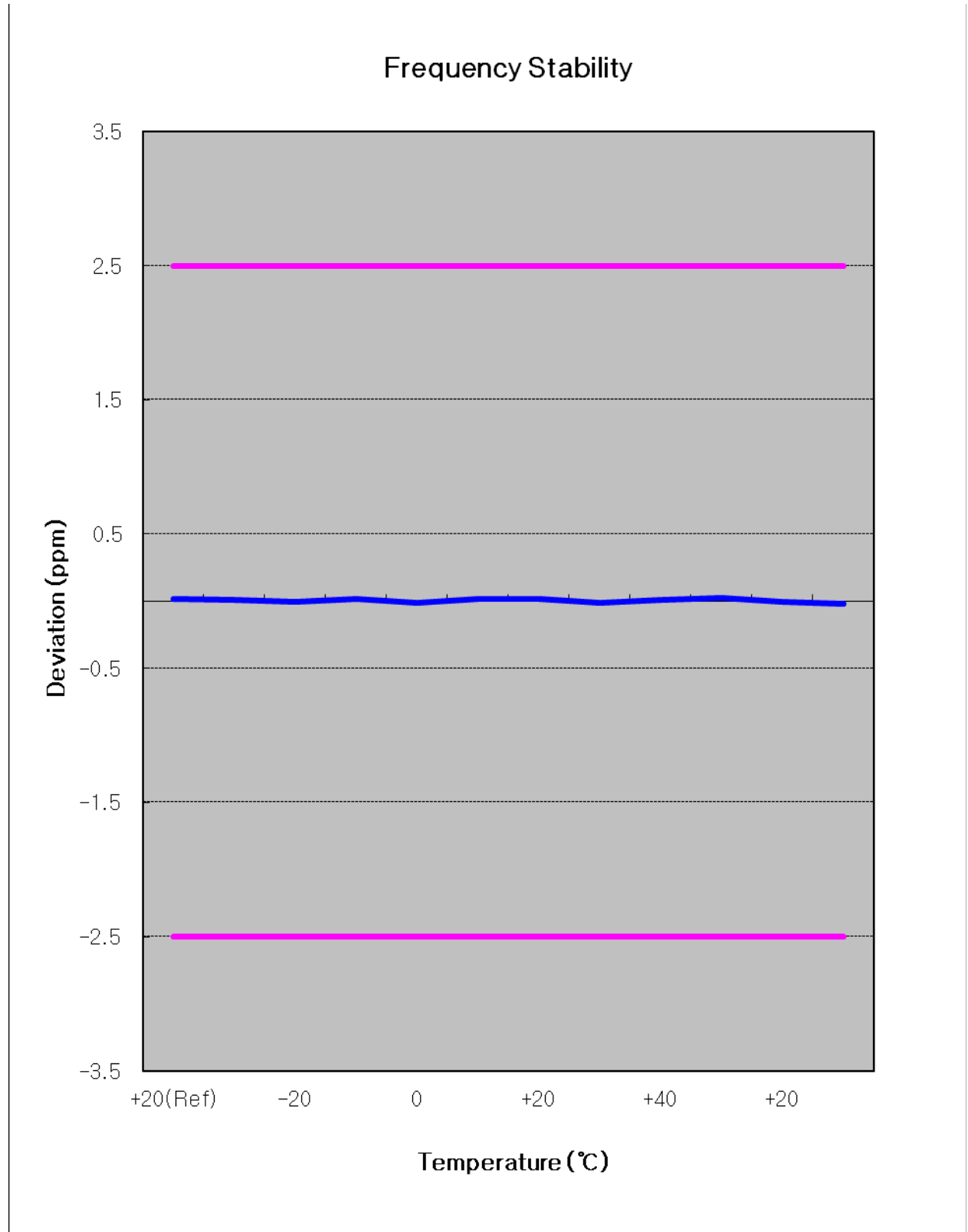

**Zoom IN**

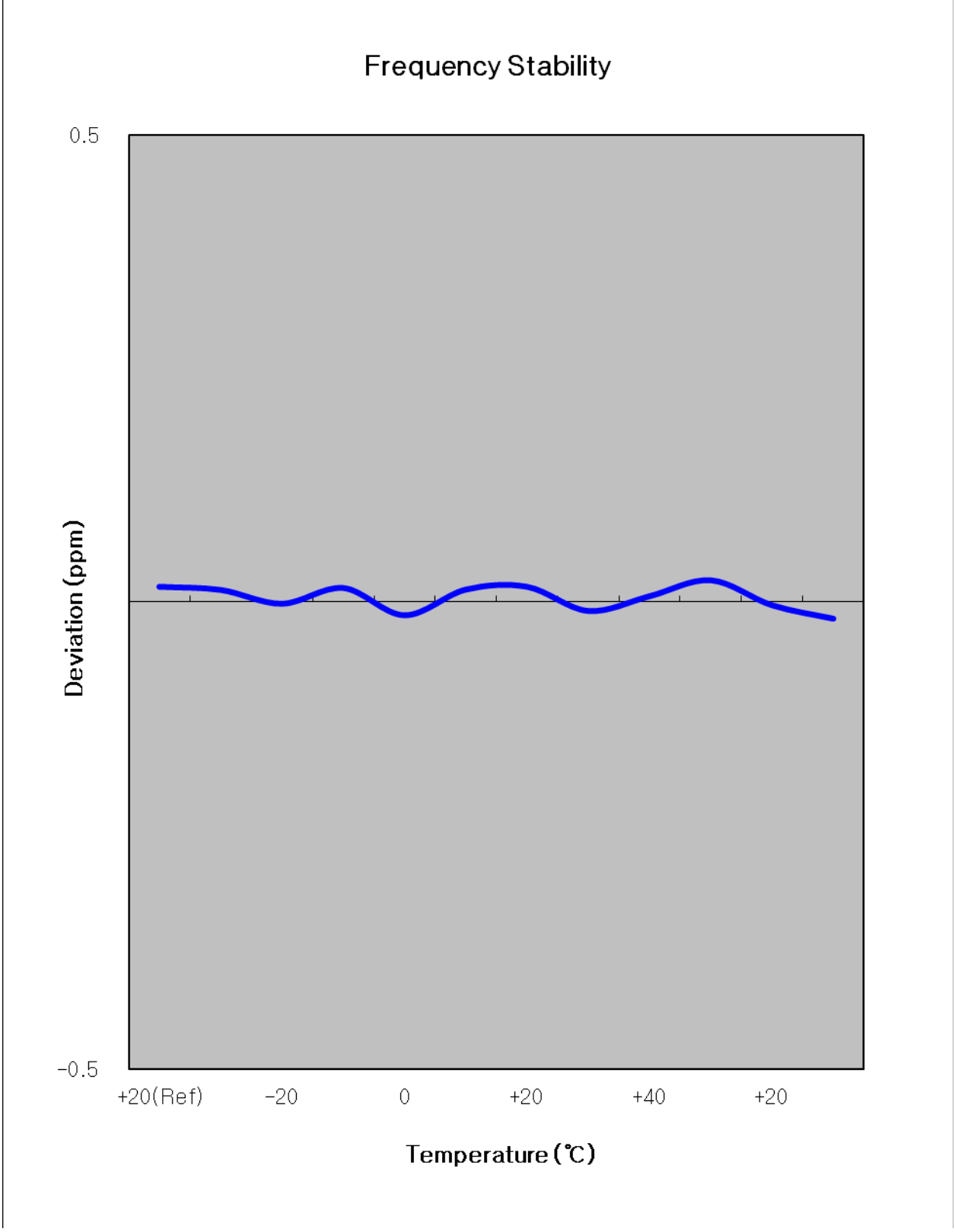



## **7. CONCLUSION**

The data collected shows that the SAMSUNG Portable Handset  
FCC ID : A3LGTI8552 complies with all the requirements of Parts 2,22,24 of the FCC Rules.

## 8. TEST PLOTS

※ All frequencies are measured Ref. offset at every 1GHz, and tested plots are worst offset among them.

1. Spectrum Offset(dB) = Cable loss(dB) + Power divider(dB)
2. Ref Offset at 1880 MHz = 7.29dBm

Agilent

R T

<b>Ch Freq</b> 824.2 MHz	<b>Trig</b> Free								
Occupied Bandwidth <span style="border: 1px solid black; display: inline-block; width: 100px; height: 15px;"></span>									
FCC ID:A3LGTI8552 0BW Ch.128 Ref 33 dBm Atten 40 dB									
Center 824.200 MHz	Span 1 MHz								
#Res BW 3 kHz	#VBW 3 kHz #Sweep 1 s (601 pts)								
<table style="width: 100%; border-collapse: collapse;"> <tr> <td style="width: 50%;"><b>Occupied Bandwidth</b></td> <td style="width: 50%;"><b>Occ BW % Pwr</b> 99.00 %</td> </tr> <tr> <td style="text-align: center;">244.8926 kHz</td> <td style="text-align: center;"><b>x dB</b> -26.00 dB</td> </tr> <tr> <td><b>Transmit Freq Error</b></td> <td>-466.137 Hz</td> </tr> <tr> <td><b>x dB Bandwidth</b></td> <td>311.036 kHz</td> </tr> </table>		<b>Occupied Bandwidth</b>	<b>Occ BW % Pwr</b> 99.00 %	244.8926 kHz	<b>x dB</b> -26.00 dB	<b>Transmit Freq Error</b>	-466.137 Hz	<b>x dB Bandwidth</b>	311.036 kHz
<b>Occupied Bandwidth</b>	<b>Occ BW % Pwr</b> 99.00 %								
244.8926 kHz	<b>x dB</b> -26.00 dB								
<b>Transmit Freq Error</b>	-466.137 Hz								
<b>x dB Bandwidth</b>	311.036 kHz								

<b>Center Freq</b> 824.200000 MHz
<b>Start Freq</b> 823.700000 MHz
<b>Stop Freq</b> 824.700000 MHz
<b>CF Step</b> 100.000000 kHz Auto Man
<b>Freq Offset</b> 0.00000000 Hz
<b>Signal Track</b> On Off

Neg.Trig Delay unavailable in Swept Mode, zero delay used.

Agilent

R T

<b>Ch Freq</b> 836.6 MHz	<b>Trig</b> Free								
Occupied Bandwidth <span style="border: 1px solid black; display: inline-block; width: 100px; height: 15px;"></span>									
FCC ID:A3LGTI8552 0BW Ch.190 Ref 33 dBm Atten 40 dB									
Center 836.600 MHz	Span 1 MHz								
#Res BW 3 kHz	#VBW 3 kHz #Sweep 1 s (601 pts)								
<table style="width: 100%; border-collapse: collapse;"> <tr> <td style="width: 50%;"><b>Occupied Bandwidth</b></td> <td style="width: 50%;"><b>Occ BW % Pwr</b> 99.00 %</td> </tr> <tr> <td style="text-align: center;">244.5822 kHz</td> <td style="text-align: center;"><b>x dB</b> -26.00 dB</td> </tr> <tr> <td><b>Transmit Freq Error</b></td> <td>1.910 kHz</td> </tr> <tr> <td><b>x dB Bandwidth</b></td> <td>315.103 kHz</td> </tr> </table>		<b>Occupied Bandwidth</b>	<b>Occ BW % Pwr</b> 99.00 %	244.5822 kHz	<b>x dB</b> -26.00 dB	<b>Transmit Freq Error</b>	1.910 kHz	<b>x dB Bandwidth</b>	315.103 kHz
<b>Occupied Bandwidth</b>	<b>Occ BW % Pwr</b> 99.00 %								
244.5822 kHz	<b>x dB</b> -26.00 dB								
<b>Transmit Freq Error</b>	1.910 kHz								
<b>x dB Bandwidth</b>	315.103 kHz								

<b>Center Freq</b> 836.600000 MHz
<b>Start Freq</b> 836.100000 MHz
<b>Stop Freq</b> 837.100000 MHz
<b>CF Step</b> 100.000000 kHz Auto Man
<b>Freq Offset</b> 0.00000000 Hz
<b>Signal Track</b> On Off

Neg.Trig Delay unavailable in Swept Mode, zero delay used.

<b>Ch Freq</b> 848.8 MHz <span style="float: right;"><b>Trig</b> Free</span>		<b>Freq/Channel</b>	
Occupied Bandwidth <span style="float: right;">[ ] [ ]</span>		<b>Center Freq</b> 848.800000 MHz	
FCC ID:A3LGTI8552 0BW Ch.251 Ref 33 dBm      Atten 40 dB		<b>Start Freq</b> 848.300000 MHz	
		<b>Stop Freq</b> 849.300000 MHz	
Center 848.800 MHz <span style="float: right;">Span 1 MHz</span> #Res BW 3 kHz      #VBW 3 kHz      #Sweep 1 s (601 pts)		<b>CF Step</b> 100.000000 kHz Auto      Man	
<b>Occupied Bandwidth</b> <span style="float: right;"><b>Occ BW % Pwr</b> 99.00 %</span> <span style="float: right;"><b>x dB</b> -26.00 dB</span>		<b>Freq Offset</b> 0.00000000 Hz	
<b>Transmit Freq Error</b> 1.857 kHz		<b>Signal Track</b> On      Off	
<b>x dB Bandwidth</b> 311.887 kHz			
<b>Neg.Trig Delay unavailable in Swept Mode, zero delay used.</b>			

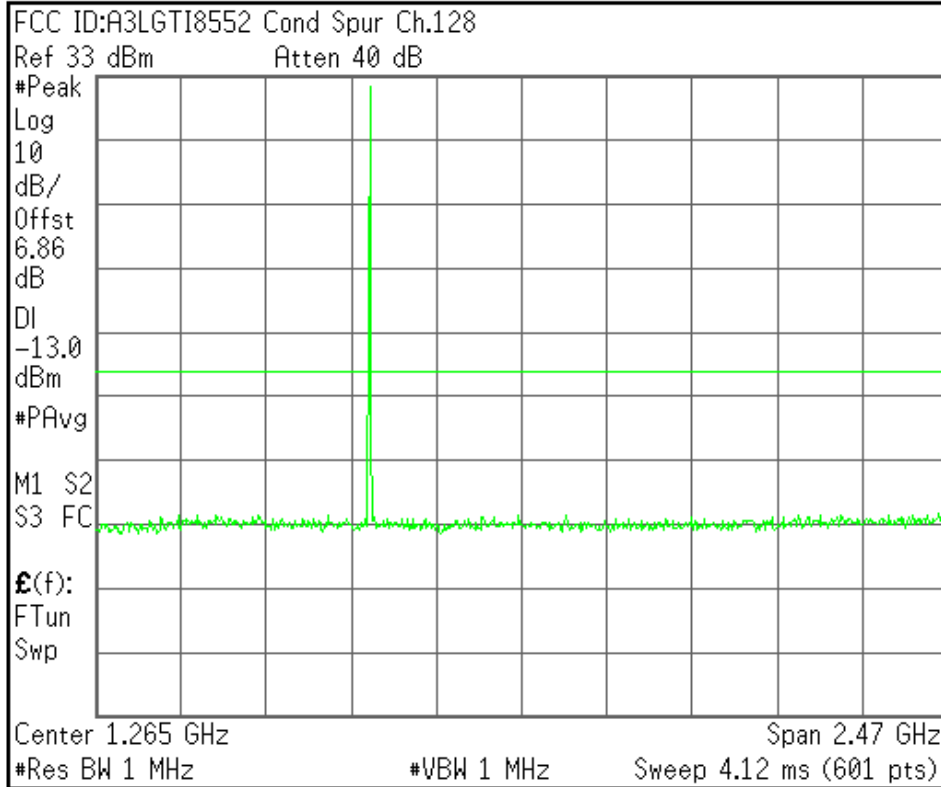

Freq/Channel	
Center Freq	1.26500000 GHz
Start Freq	30.0000000 MHz
Stop Freq	2.50000000 GHz
CF Step	247.000000 MHz Auto Man
Freq Offset	0.00000000 Hz
Signal Track	On Off

File Operation Status, C:\TEMP.GIF file saved

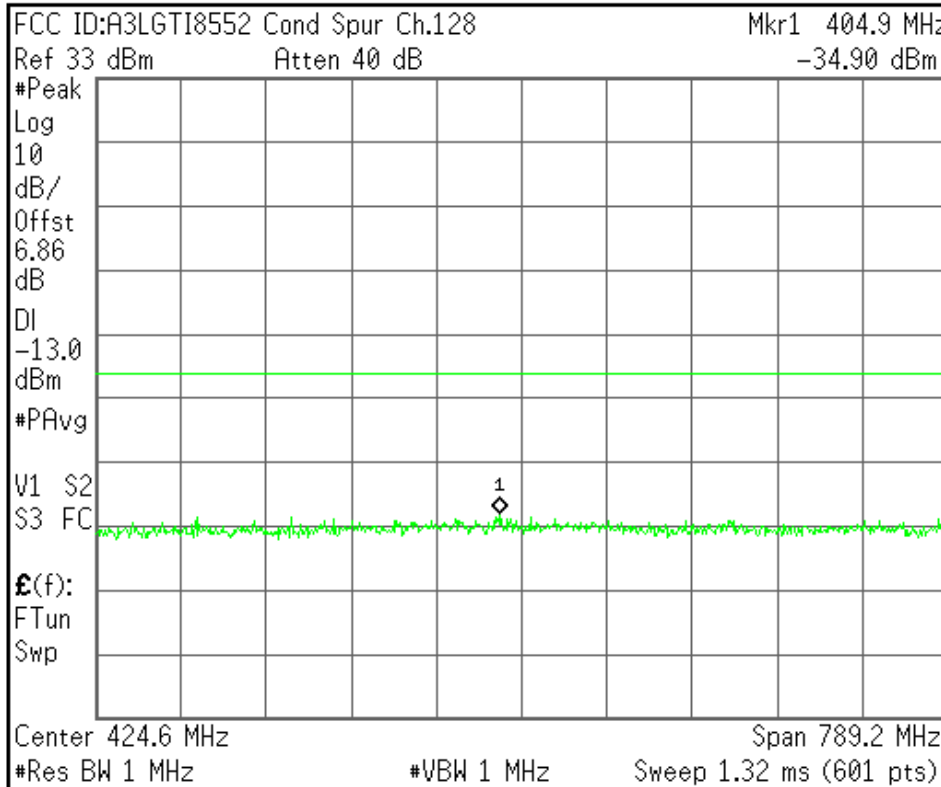

Freq/Channel	
Center Freq	424.600000 MHz
Start Freq	30.0000000 MHz
Stop Freq	819.200000 MHz
CF Step	78.9200000 MHz Auto Man
Freq Offset	0.00000000 Hz
Signal Track	On Off

File Operation Status, C:\TEMP.GIF file saved

Agilent

R T

Freq/Channel

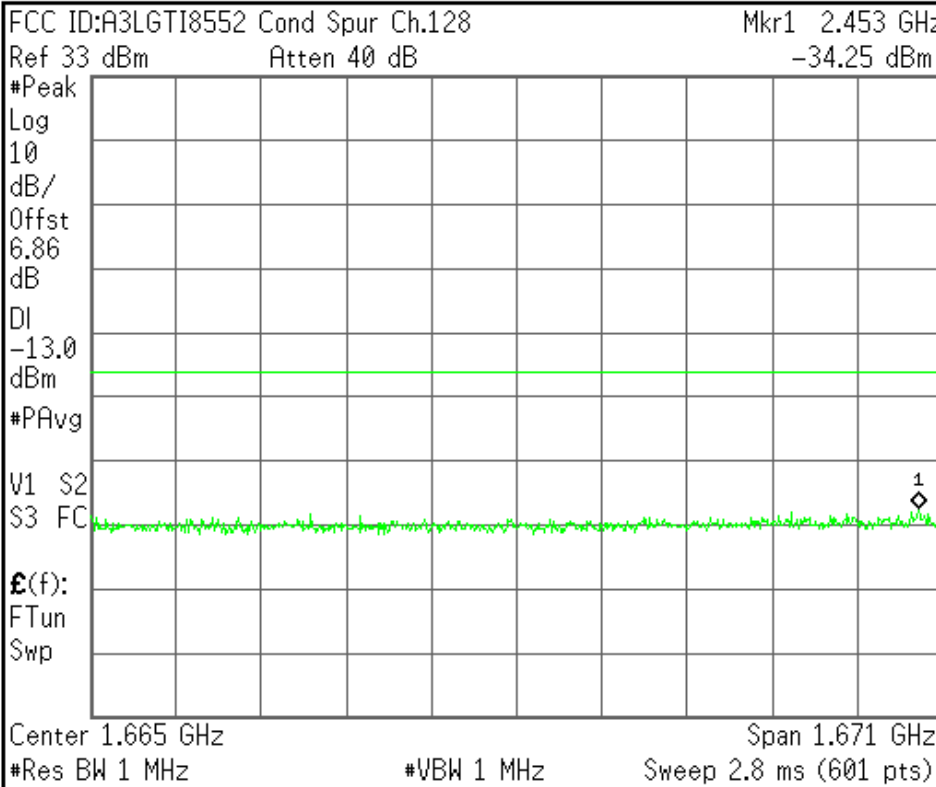

<b>Center Freq</b> 1.66460000 GHz
<b>Start Freq</b> 829.200000 MHz
<b>Stop Freq</b> 2.50000000 GHz
<b>CF Step</b> 167.080000 MHz Auto Man
<b>Freq Offset</b> 0.00000000 Hz
<b>Signal Track</b> On Off

File Operation Status, C:\TEMP.GIF file saved

Agilent

R T

Freq/Channel

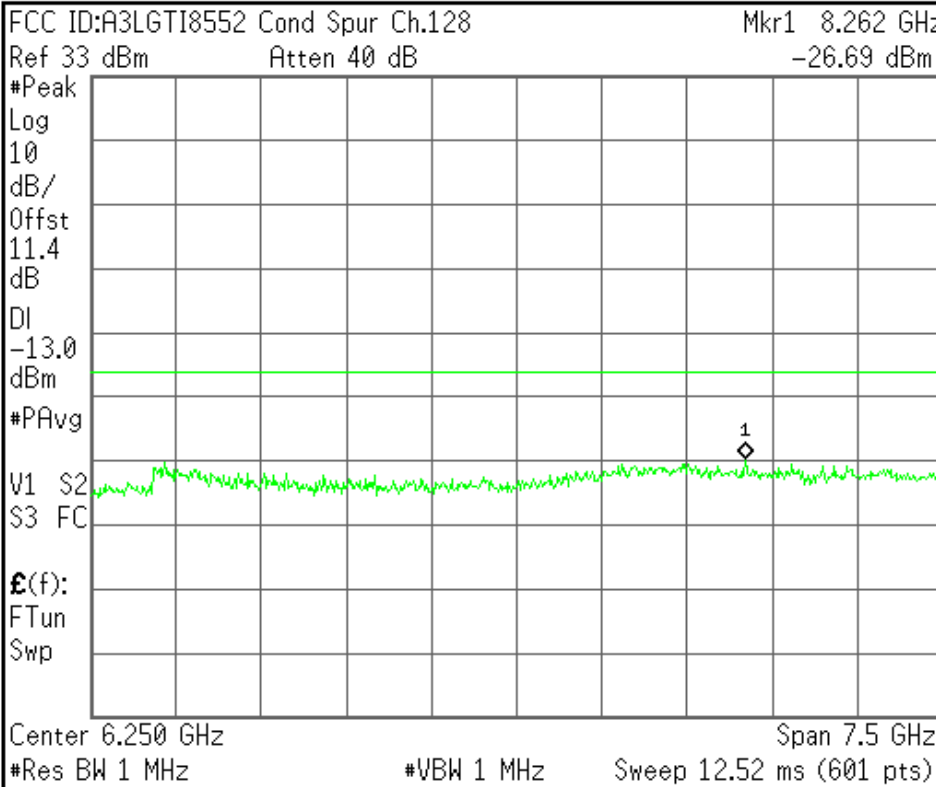

<b>Center Freq</b> 6.25000000 GHz
<b>Start Freq</b> 2.50000000 GHz
<b>Stop Freq</b> 10.00000000 GHz
<b>CF Step</b> 750.000000 MHz Auto Man
<b>Freq Offset</b> 0.00000000 Hz
<b>Signal Track</b> On Off

File Operation Status, C:\TEMP.GIF file saved

Agilent

R T

Freq/Channel

FCC ID:A3LGTI8552 Cond Spur Ch.190

Ref 33 dBm

Atten 40 dB

#Peak

Log

10

dB/

Offst

6.86

dB

DI

-13.0

dBm

#PAvg

M1 S2

S3 FC

£(f):

FTun

Swp

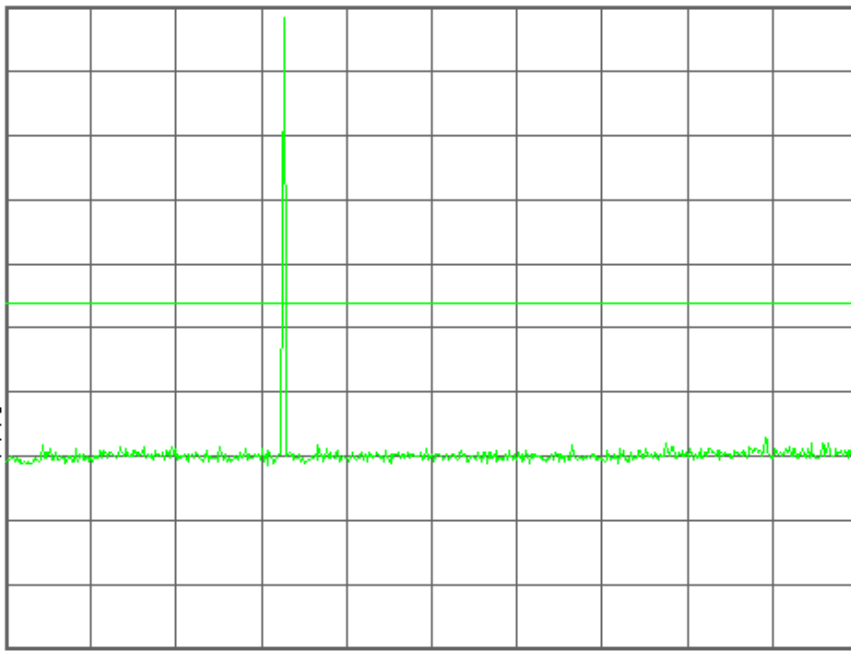

Center 1.265 GHz

Span 2.47 GHz

#Res BW 1 MHz

#VBW 1 MHz

Sweep 4.12 ms (601 pts)

Center Freq  
1.26500000 GHz

Start Freq  
30.0000000 MHz

Stop Freq  
2.50000000 GHz

CF Step  
247.000000 MHz  
Auto Man

Freq Offset  
0.00000000 Hz

Signal Track  
On Off

File Operation Status, C:\TEMP.GIF file saved

Agilent

R T

Freq/Channel

FCC ID:A3LGTI8552 Cond Spur Ch.190

Mkr1 396.1 MHz

Ref 33 dBm

Atten 40 dB

-34.71 dBm

#Peak

Log

10

dB/

Offst

6.86

dB

DI

-13.0

dBm

#PAvg

M1 S2

S3 FC

£(f):

FTun

Swp

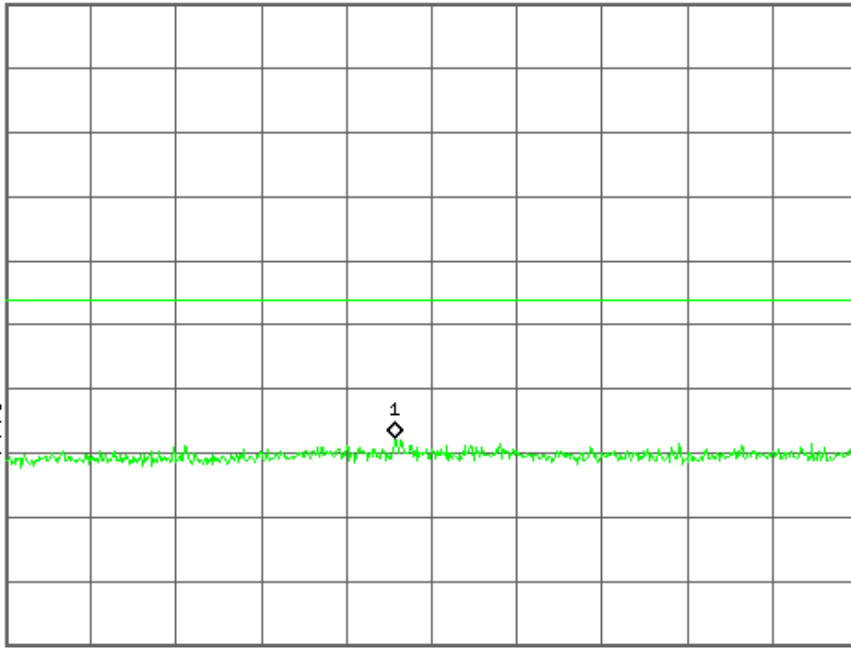

Center 430.8 MHz

Span 801.6 MHz

#Res BW 1 MHz

#VBW 1 MHz

Sweep 1.36 ms (601 pts)

Center Freq  
430.800000 MHz

Start Freq  
30.0000000 MHz

Stop Freq  
831.600000 MHz

CF Step  
80.1600000 MHz  
Auto Man

Freq Offset  
0.00000000 Hz

Signal Track  
On Off

File Operation Status, C:\TEMP.GIF file saved

Agilent

R T

Freq/Channel

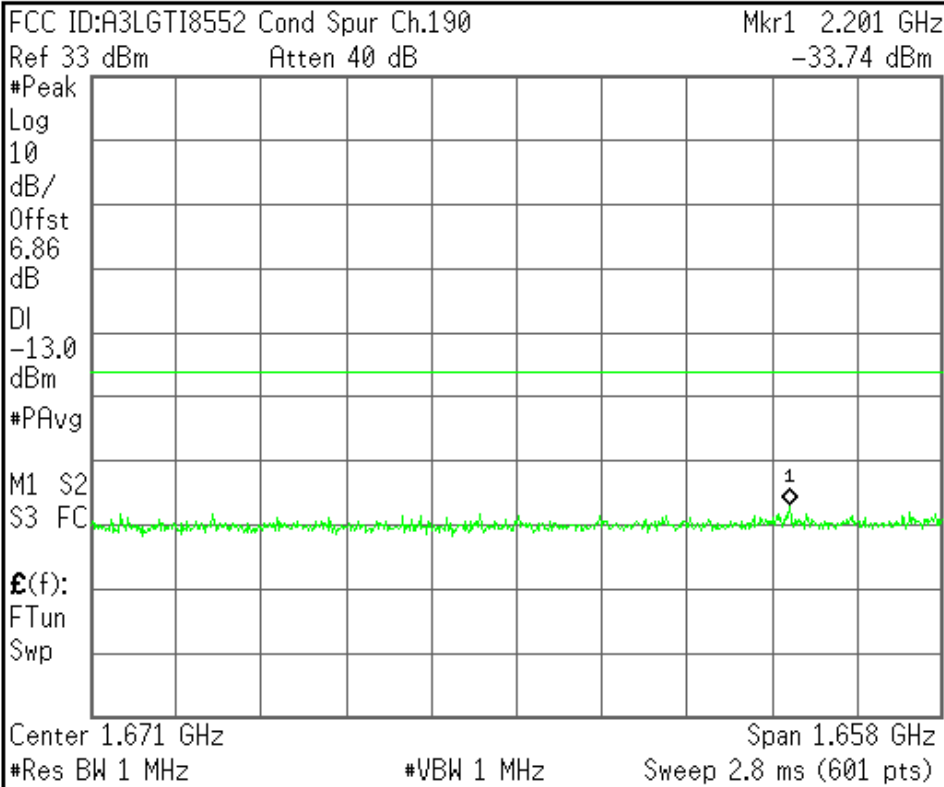

<b>Center Freq</b> 1.67080000 GHz
<b>Start Freq</b> 841.600000 MHz
<b>Stop Freq</b> 2.50000000 GHz
<b>CF Step</b> 165.840000 MHz Auto Man
<b>Freq Offset</b> 0.00000000 Hz
<b>Signal Track</b> On Off

File Operation Status, C:\TEMP.GIF file saved

Agilent

R T

Freq/Channel

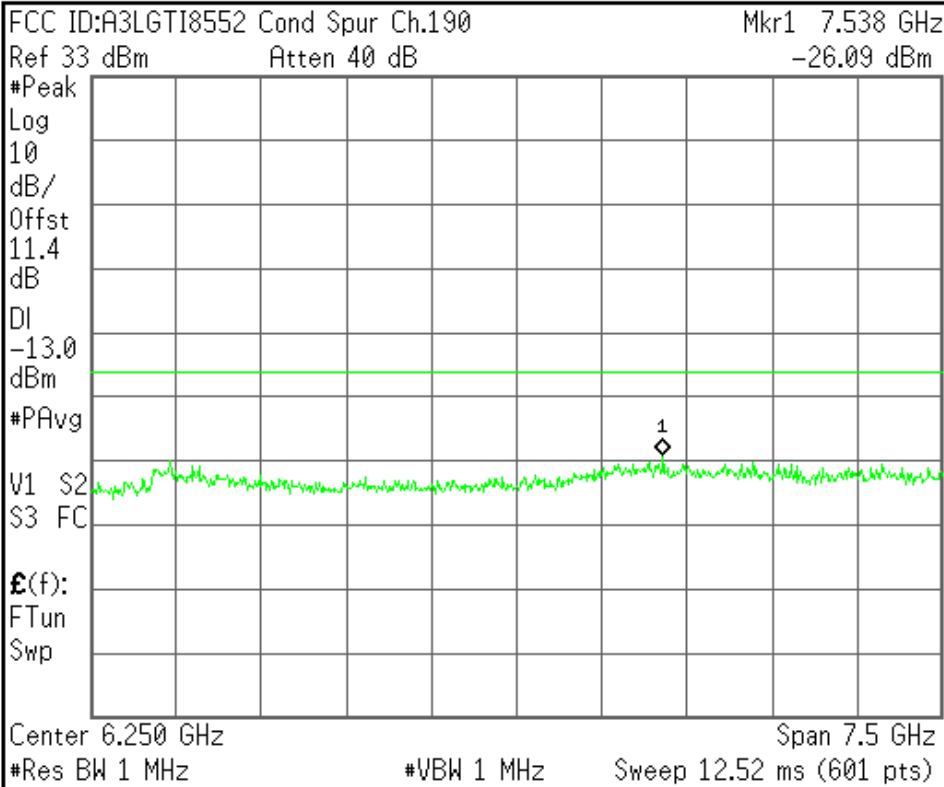

<b>Center Freq</b> 6.25000000 GHz
<b>Start Freq</b> 2.50000000 GHz
<b>Stop Freq</b> 10.00000000 GHz
<b>CF Step</b> 750.000000 MHz Auto Man
<b>Freq Offset</b> 0.00000000 Hz
<b>Signal Track</b> On Off

File Operation Status, C:\TEMP.GIF file saved

Agilent

R T

Freq/Channel

FCC ID:A3LGTI8552 Cond Spur Ch.251

Ref 33 dBm Atten 40 dB

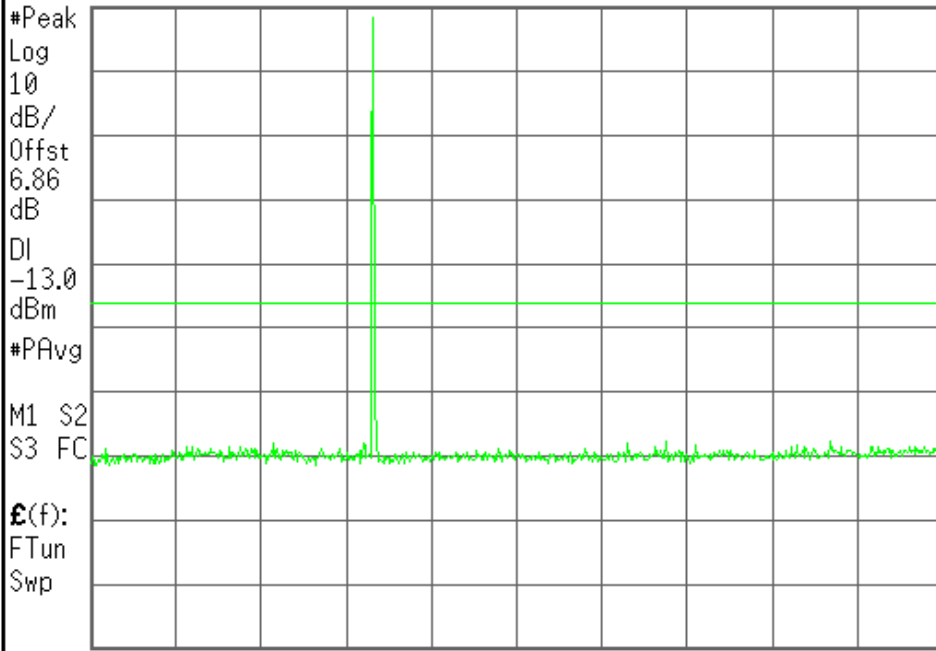

Center 1.265 GHz Span 2.47 GHz  
#Res BW 1 MHz #VBW 1 MHz Sweep 4.12 ms (601 pts)

Center Freq  
1.26500000 GHz

Start Freq  
30.0000000 MHz

Stop Freq  
2.50000000 GHz

CF Step  
247.000000 MHz  
Auto Man

Freq Offset  
0.00000000 Hz

Signal Track  
On Off

File Operation Status, C:\TEMP.GIF file saved

Agilent

R T

Freq/Channel

FCC ID:A3LGTI8552 Cond Spur Ch.251

Mkr1 377.2 MHz

Ref 33 dBm Atten 40 dB

-35.22 dBm

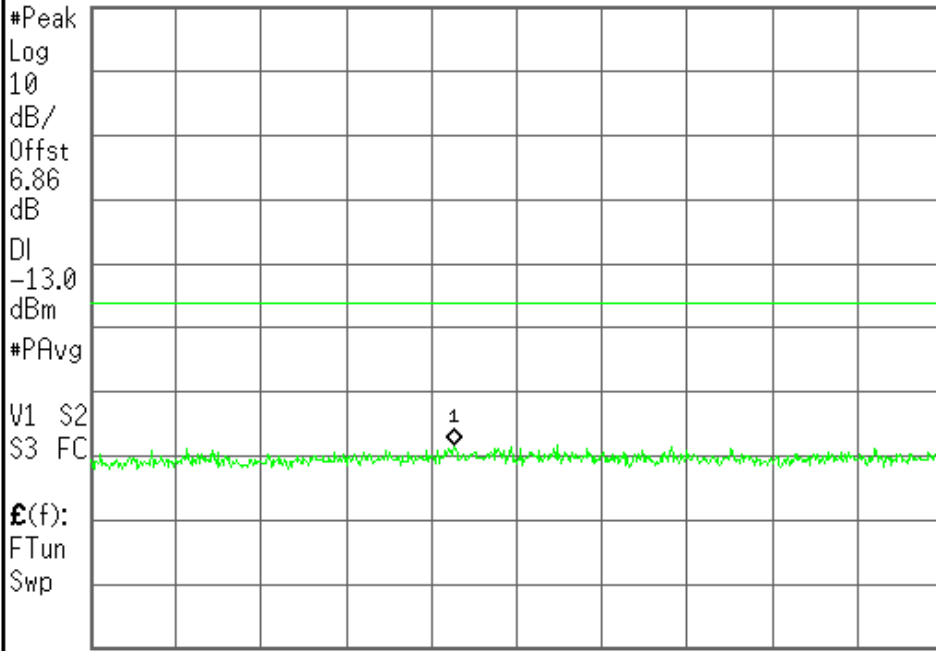

Center 436.9 MHz Span 813.8 MHz  
#Res BW 1 MHz #VBW 1 MHz Sweep 1.36 ms (601 pts)

Center Freq  
436.900000 MHz

Start Freq  
30.0000000 MHz

Stop Freq  
843.800000 MHz

CF Step  
81.3800000 MHz  
Auto Man

Freq Offset  
0.00000000 Hz

Signal Track  
On Off

File Operation Status, C:\TEMP.GIF file saved

Agilent

R T

Freq/Channel

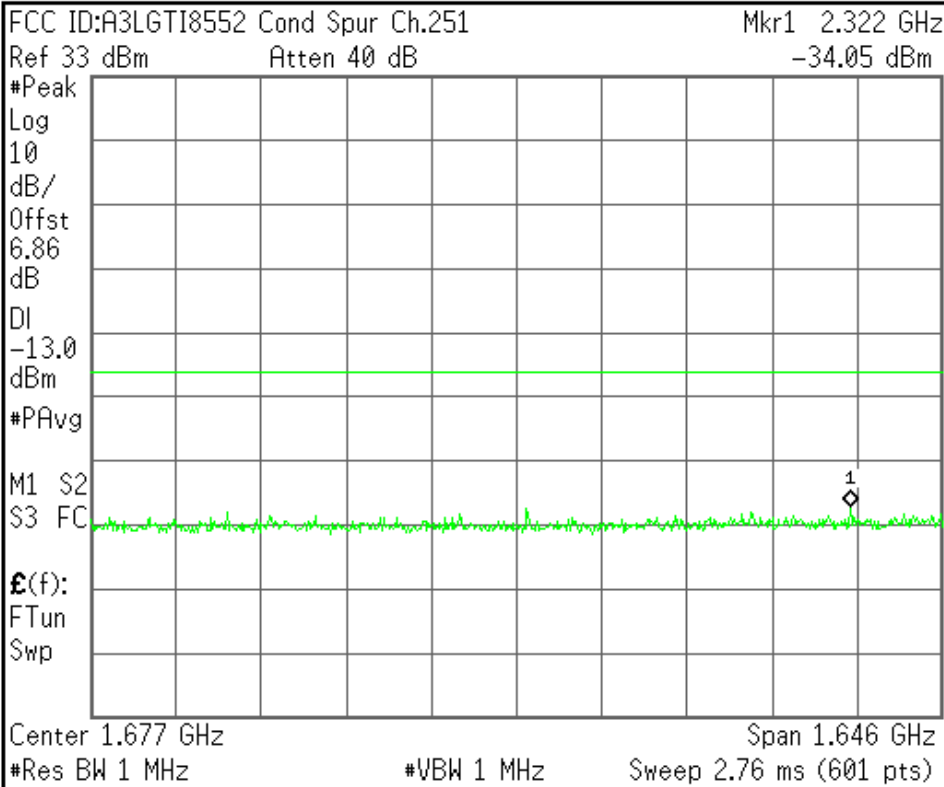

<b>Center Freq</b> 1.67690000 GHz
<b>Start Freq</b> 853.800000 MHz
<b>Stop Freq</b> 2.50000000 GHz
<b>CF Step</b> 164.620000 MHz Auto Man
<b>Freq Offset</b> 0.00000000 Hz
<b>Signal Track</b> On Off

File Operation Status, C:\TEMP.GIF file saved

Agilent

R T

Freq/Channel

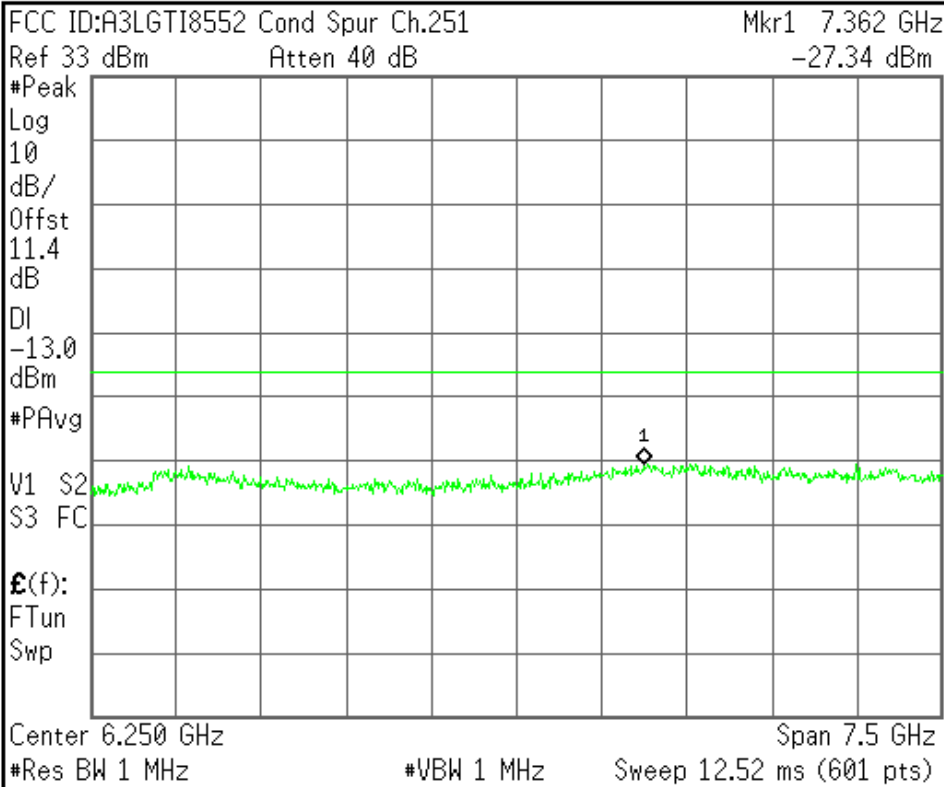

<b>Center Freq</b> 6.25000000 GHz
<b>Start Freq</b> 2.50000000 GHz
<b>Stop Freq</b> 10.00000000 GHz
<b>CF Step</b> 750.000000 MHz Auto Man
<b>Freq Offset</b> 0.00000000 Hz
<b>Signal Track</b> On Off

File Operation Status, C:\TEMP.GIF file saved

Agilent

R T

Freq/Channel

FCC ID:A3LGTI8552 Band Edge Ch.128

Ref 33 dBm Atten 40 dB

#Avg  
Log  
10  
dB/  
Offst  
6.86  
dB  
DI  
-13.0  
dBm  
#PAvg  
M1 S2  
S3 FC  
E(f):  
f>50k  
Swp

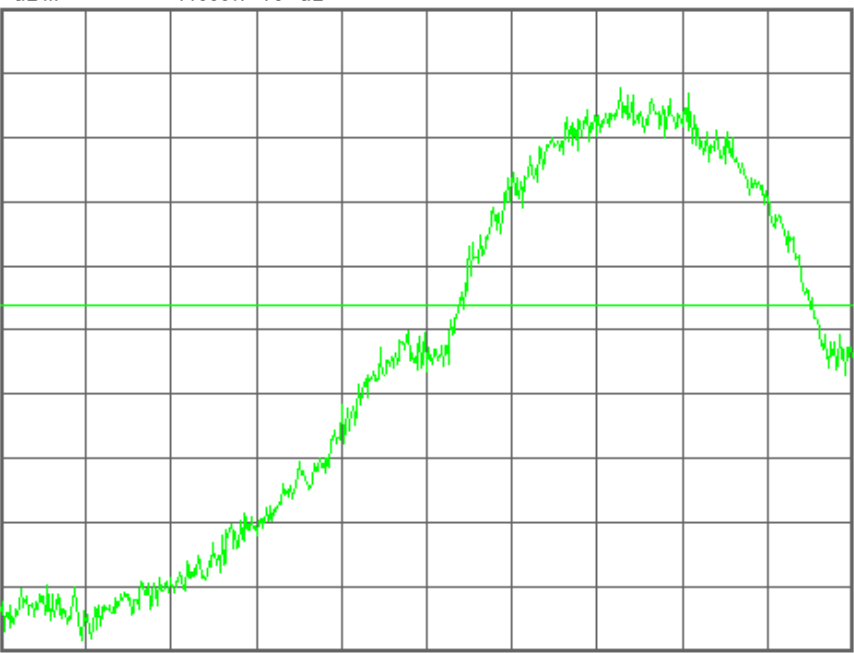

Center 824.000 0 MHz Span 810 kHz  
#Res BW 3 kHz #VBW 3 kHz Sweep 343.2 ms (601 pts)

Center Freq  
824.000000 MHz

Start Freq  
823.595000 MHz

Stop Freq  
824.405000 MHz

CF Step  
81.0000000 kHz  
Auto Man

Freq Offset  
0.00000000 Hz

Signal Track  
On Off

Neg.Trig Delay unavailable in Swept Mode, zero delay used.

Agilent

R T

Freq/Channel

FCC ID:A3LGTI8552 Band Edge Ch.128

Mkr1 823.974 6 MHz

Ref 33 dBm Atten 40 dB

-17.46 dBm

#Avg  
Log  
10  
dB/  
Offst  
6.86  
dB  
DI  
-13.0  
dBm  
#PAvg  
M1 S2  
S3 FC  
E(f):  
f>50k  
Swp

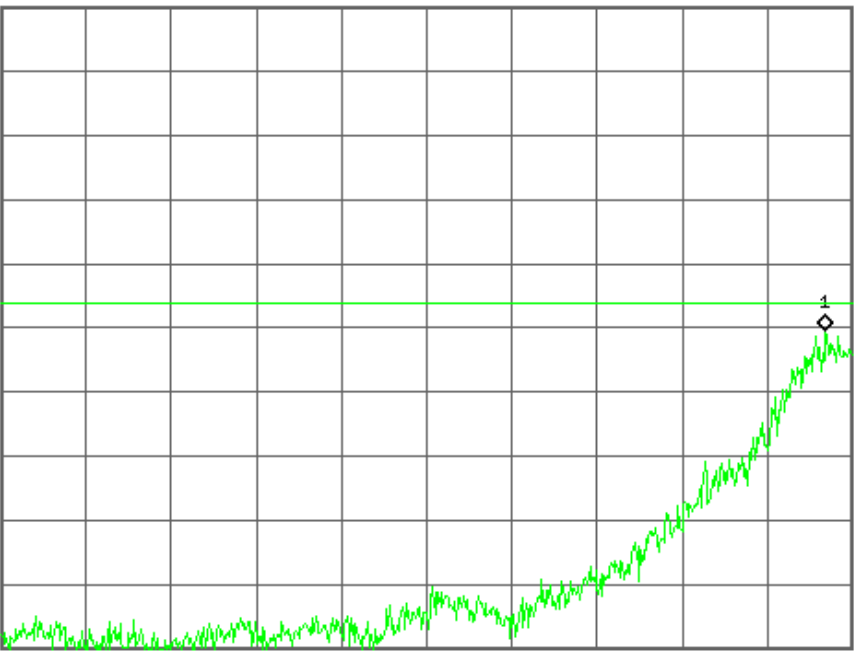

Center 823.595 0 MHz Span 810 kHz  
#Res BW 3 kHz #VBW 3 kHz Sweep 343.2 ms (601 pts)

Center Freq  
823.595000 MHz

Start Freq  
823.190000 MHz

Stop Freq  
824.000000 MHz

CF Step  
81.0000000 kHz  
Auto Man

Freq Offset  
0.00000000 Hz

Signal Track  
On Off

File Operation Status, C:\TEMP.GIF file saved

Agilent

R T

Freq/Channel

FCC ID:A3LGTI8552 Band Edge Ch.251

Ref 33 dBm Atten 40 dB

#Avg

Log

10

dB/

Offst

6.86

dB

DI

-13.0

dBm

#PAvg

M1 S2

S3 FC

$\mathcal{E}(f)$ :

f>50k

Swp

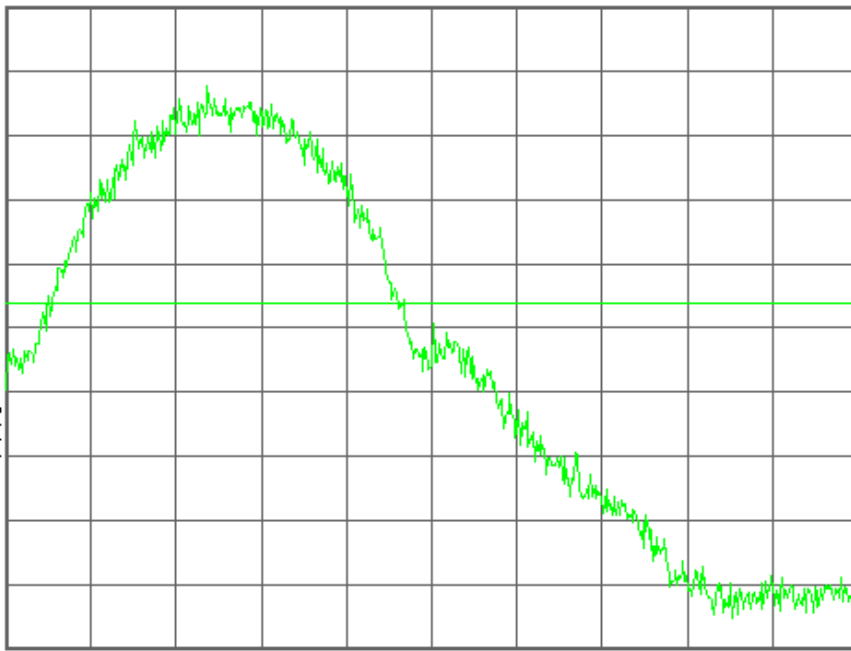

Center 849.000 0 MHz

Span 810 kHz

#Res BW 3 kHz

#VBW 3 kHz

Sweep 343.2 ms (601 pts)

Center Freq  
849.000000 MHz

Start Freq  
848.595000 MHz

Stop Freq  
849.405000 MHz

CF Step  
81.0000000 kHz  
Auto Man

Freq Offset  
0.00000000 Hz

Signal Track  
On Off

Neg.Trig Delay unavailable in Swept Mode, zero delay used.

Agilent

R T

Freq/Channel

FCC ID:A3LGTI8552 Band Edge Ch.251

Mkr1 849.018 7 MHz

Ref 33 dBm Atten 40 dB

-17.79 dBm

#Avg

Log

10

dB/

Offst

6.86

dB

DI

-13.0

dBm

#PAvg

M1 S2

S3 FC

$\mathcal{E}(f)$ :

f>50k

Swp

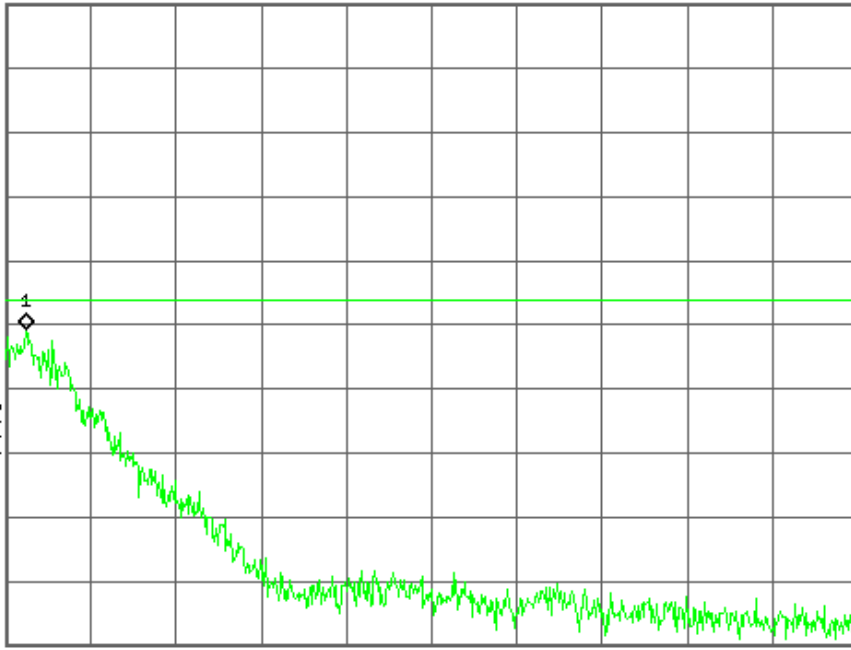

Center 849.405 0 MHz

Span 810 kHz

#Res BW 3 kHz

#VBW 3 kHz

Sweep 343.2 ms (601 pts)

Center Freq  
849.405000 MHz

Start Freq  
849.000000 MHz

Stop Freq  
849.810000 MHz

CF Step  
81.0000000 kHz  
Auto Man

Freq Offset  
0.00000000 Hz

Signal Track  
On Off

File Operation Status, C:\TEMP.GIF file saved

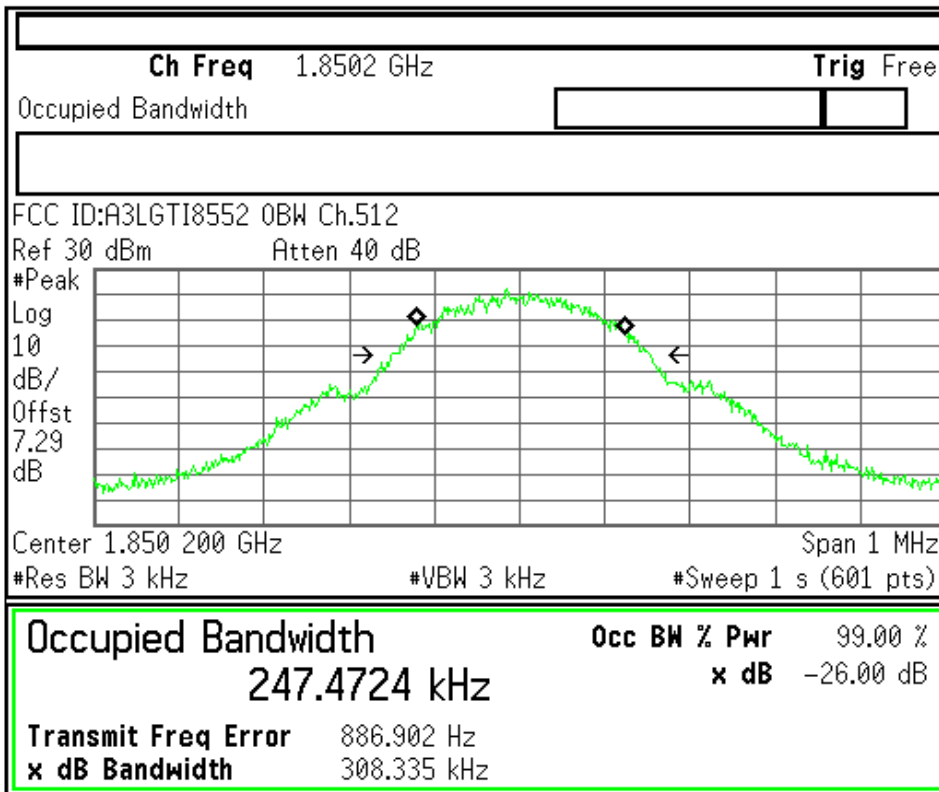

<b>Freq/Channel</b>
<b>Center Freq</b> 1.85020000 GHz
<b>Start Freq</b> 1.84970000 GHz
<b>Stop Freq</b> 1.85070000 GHz
<b>CF Step</b> 100.000000 kHz Auto Man
<b>Freq Offset</b> 0.00000000 Hz
<b>Signal Track</b> On Off

File Operation Status, C:\TEMP.GIF file saved

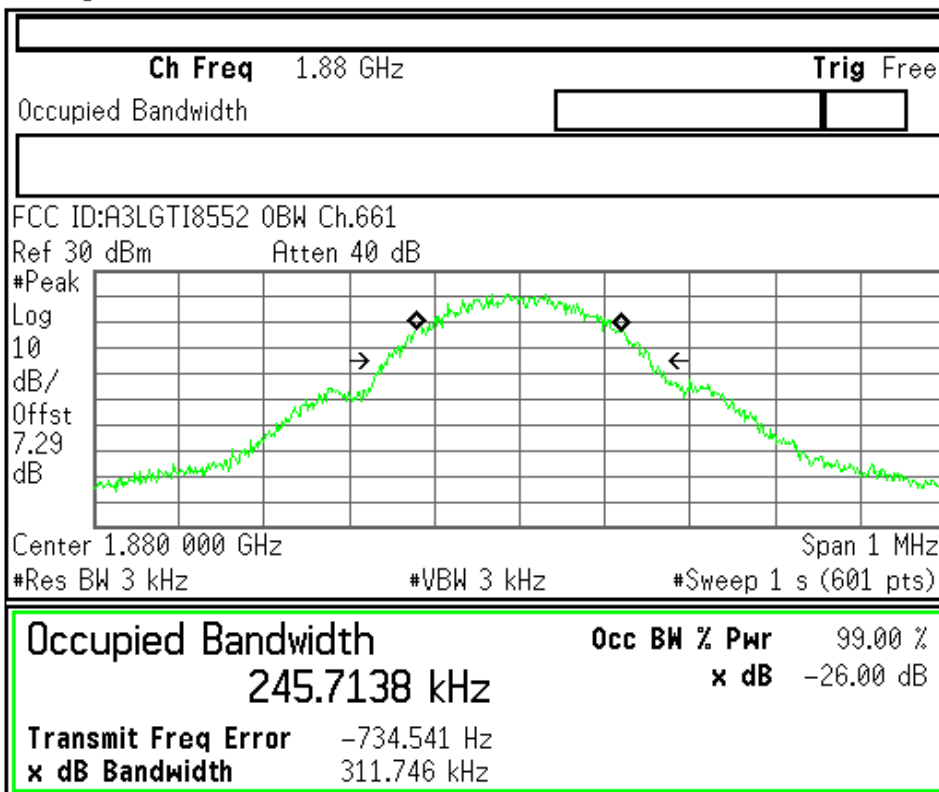

<b>Freq/Channel</b>
<b>Center Freq</b> 1.88000000 GHz
<b>Start Freq</b> 1.87950000 GHz
<b>Stop Freq</b> 1.88050000 GHz
<b>CF Step</b> 100.000000 kHz Auto Man
<b>Freq Offset</b> 0.00000000 Hz
<b>Signal Track</b> On Off

File Operation Status, C:\TEMP.GIF file saved

<b>Ch Freq</b> 1.9098 GHz <b>Trig</b> Free		<b>Freq/Channel</b>	
Occupied Bandwidth		<b>Center Freq</b> 1.90980000 GHz	
FCC ID:A3LGTI8552 0BW Ch.810 Ref 30 dBm Atten 40 dB		<b>Start Freq</b> 1.90930000 GHz	
		<b>Stop Freq</b> 1.91030000 GHz	
Center 1.909 800 GHz Span 1 MHz #Res BW 3 kHz #VBW 3 kHz #Sweep 1 s (601 pts)		<b>CF Step</b> 100.000000 kHz Auto Man	
<b>Occupied Bandwidth</b>		<b>Freq Offset</b> 0.00000000 Hz	
247.6337 kHz		<b>Signal Track</b> On Off	
<b>Transmit Freq Error</b> -726.739 Hz		Occ BW % Pwr 99.00 %	
<b>x dB Bandwidth</b> 312.650 kHz		x dB -26.00 dB	
File Operation Status, C:\TEMP.GIF file saved			

Agilent

R T

Freq/Channel

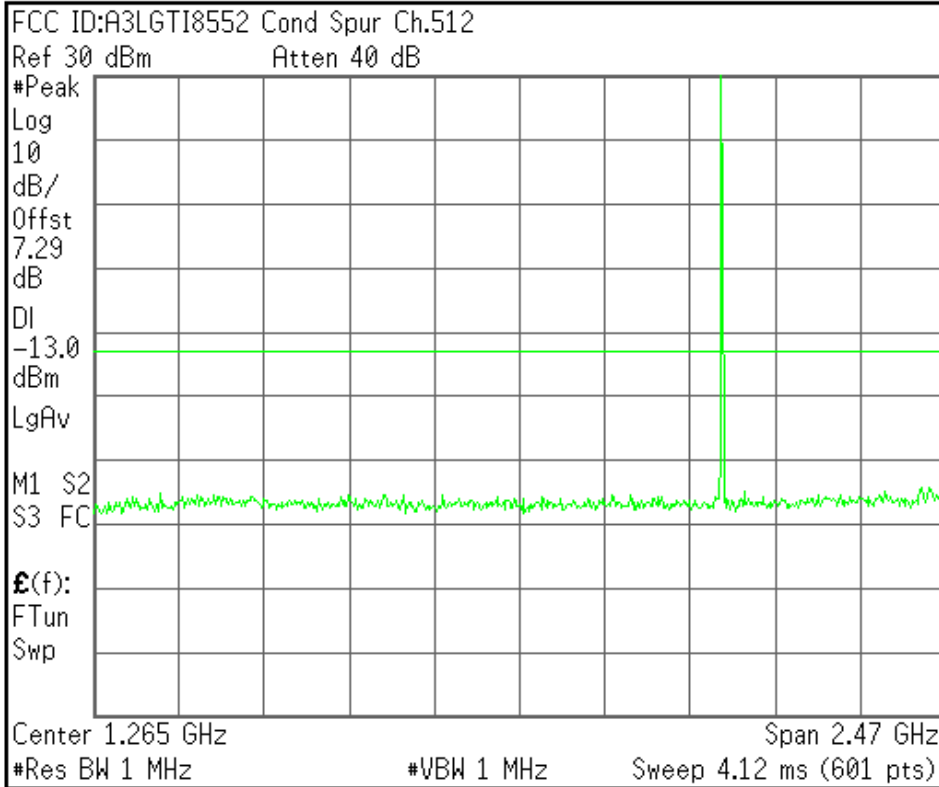

<b>Center Freq</b>	1.26500000 GHz
<b>Start Freq</b>	30.0000000 MHz
<b>Stop Freq</b>	2.50000000 GHz
<b>CF Step</b>	247.000000 MHz Auto Man
<b>Freq Offset</b>	0.00000000 Hz
<b>Signal Track</b>	On Off

Copyright 2000-2006 Agilent Technologies

Agilent

R T

Freq/Channel

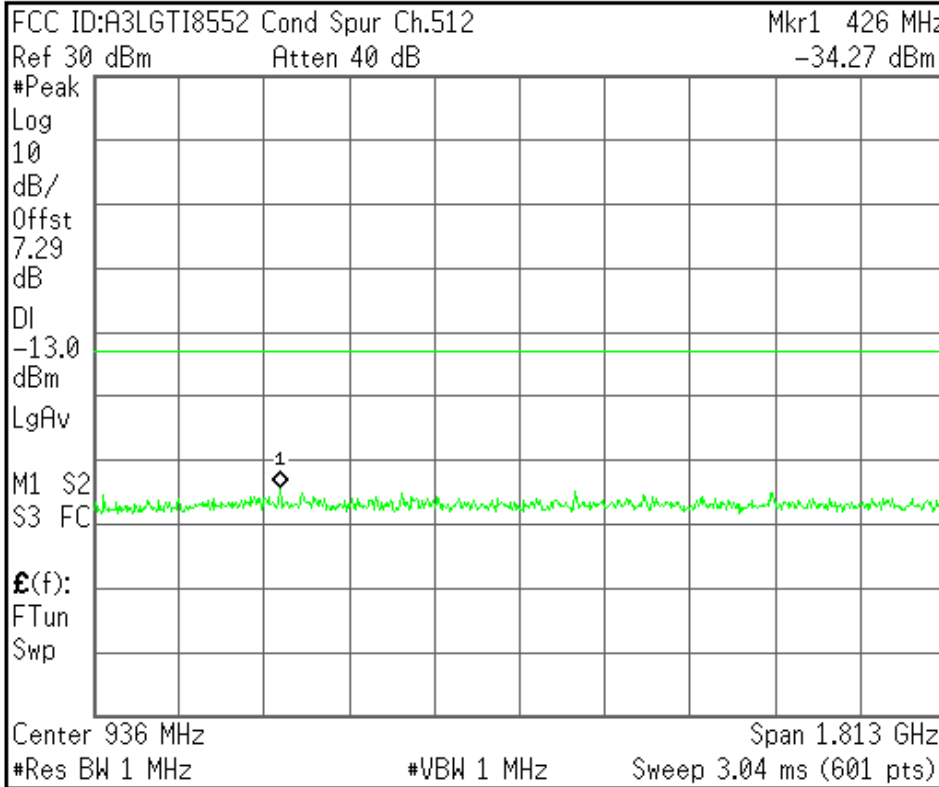

<b>Center Freq</b>	936.350000 MHz
<b>Start Freq</b>	30.0000000 MHz
<b>Stop Freq</b>	1.84270000 GHz
<b>CF Step</b>	181.270000 MHz Auto Man
<b>Freq Offset</b>	0.00000000 Hz
<b>Signal Track</b>	On Off

File Operation Status, C:\TEMP.GIF file saved

Agilent

R T

Freq/Channel

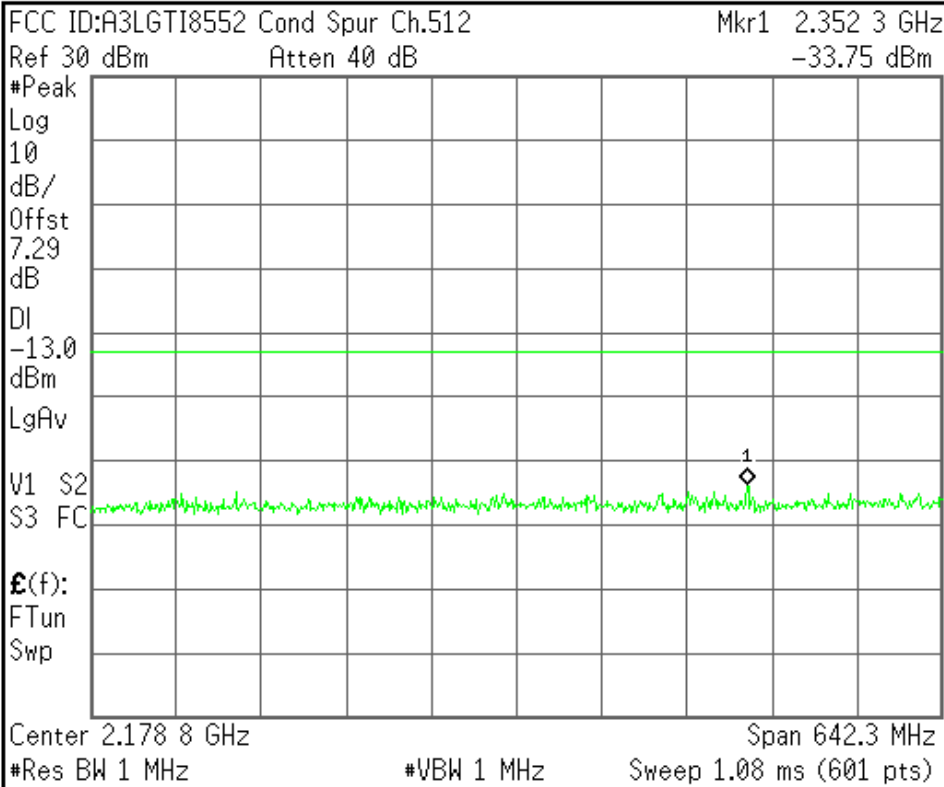

<b>Center Freq</b>	2.17885000 GHz
<b>Start Freq</b>	1.85770000 GHz
<b>Stop Freq</b>	2.50000000 GHz
<b>CF Step</b>	64.2300000 MHz Auto Man
<b>Freq Offset</b>	0.00000000 Hz
<b>Signal Track</b>	On Off

File Operation Status, C:\TEMP.GIF file saved

Agilent

R T

Freq/Channel

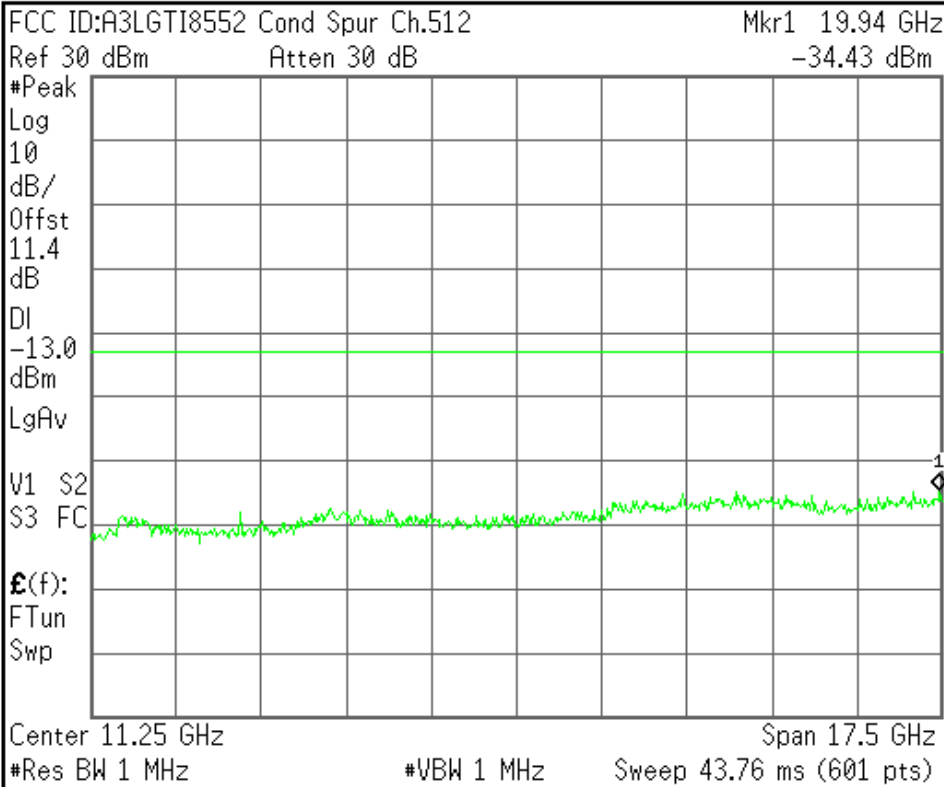

<b>Center Freq</b>	11.2500000 GHz
<b>Start Freq</b>	2.50000000 GHz
<b>Stop Freq</b>	20.0000000 GHz
<b>CF Step</b>	1.75000000 GHz Auto Man
<b>Freq Offset</b>	0.00000000 Hz
<b>Signal Track</b>	On Off

File Operation Status, C:\TEMP.GIF file saved

Agilent

R T

Freq/Channel

FCC ID:A3LGTI8552 Cond Spur Ch.661

Ref 30 dBm Atten 40 dB

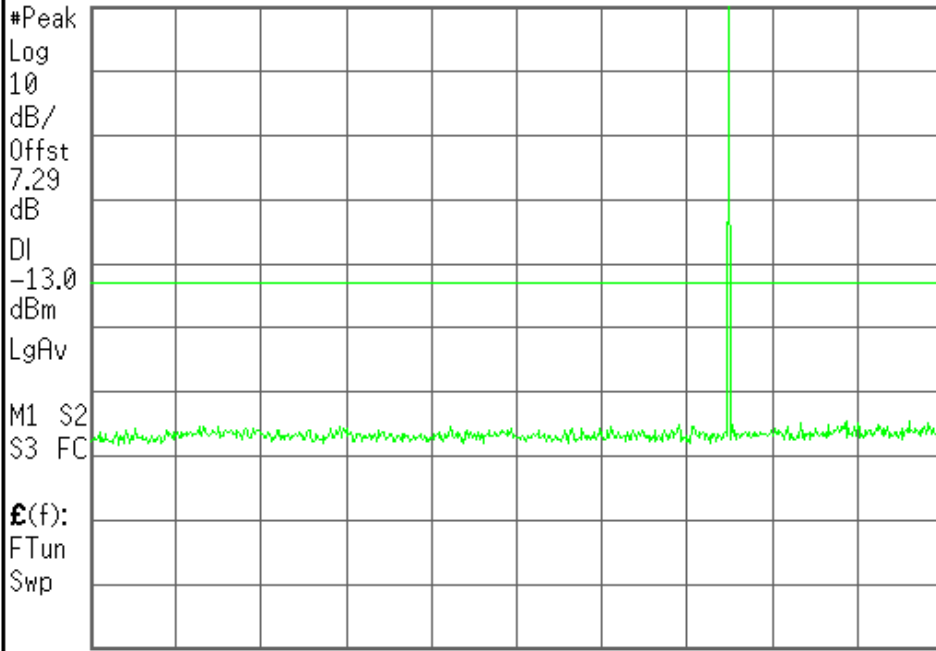

Center Freq  
1.26500000 GHz

Start Freq  
30.0000000 MHz

Stop Freq  
2.50000000 GHz

CF Step  
247.000000 MHz  
Auto Man

Freq Offset  
0.00000000 Hz

Signal Track  
On Off

Center 1.265 GHz Span 2.47 GHz  
#Res BW 1 MHz #VBW 1 MHz Sweep 4.12 ms (601 pts)

File Operation Status, C:\TEMP.GIF file saved

Agilent

R T

Freq/Channel

FCC ID:A3LGTI8552 Cond Spur Ch.661

Ref 30 dBm Atten 40 dB

Mkr1 749 MHz

-35.05 dBm

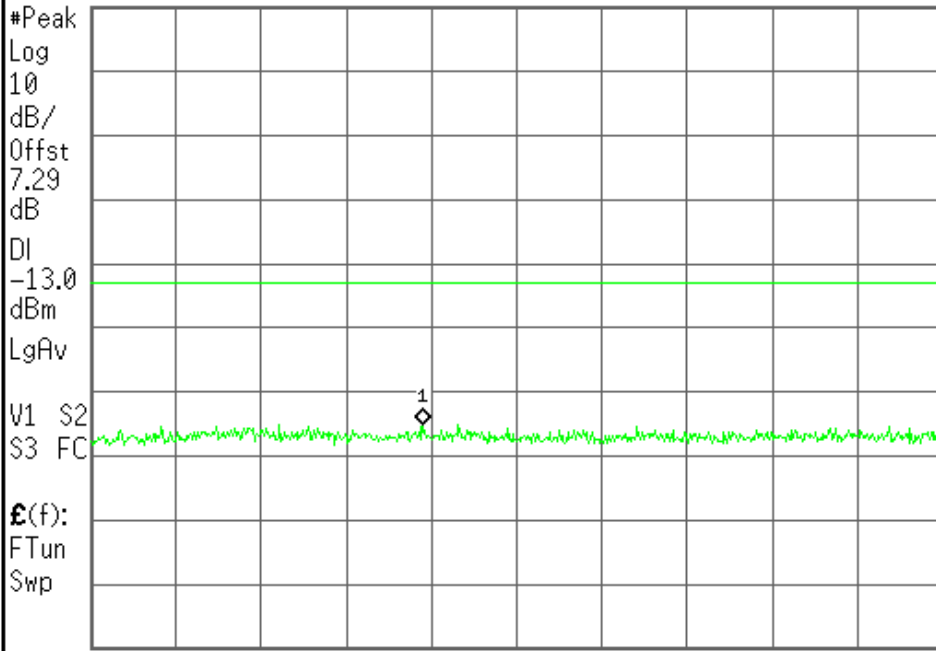

Center Freq  
951.250000 MHz

Start Freq  
30.0000000 MHz

Stop Freq  
1.87250000 GHz

CF Step  
184.250000 MHz  
Auto Man

Freq Offset  
0.00000000 Hz

Signal Track  
On Off

Center 951 MHz Span 1.843 GHz  
#Res BW 1 MHz #VBW 1 MHz Sweep 3.08 ms (601 pts)

File Operation Status, C:\TEMP.GIF file saved

Agilent

R T

Freq/Channel

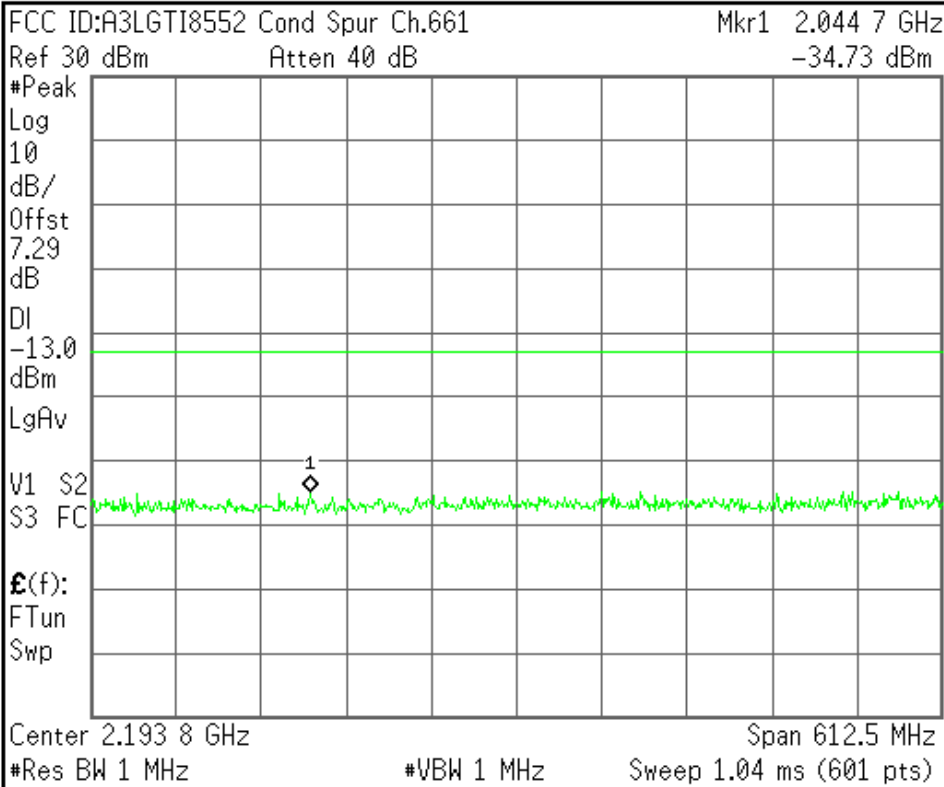

<b>Center Freq</b> 2.19375000 GHz
<b>Start Freq</b> 1.88750000 GHz
<b>Stop Freq</b> 2.50000000 GHz
<b>CF Step</b> Auto Man 61.2500000 MHz
<b>Freq Offset</b> 0.00000000 Hz
<b>Signal Track</b> On Off

File Operation Status, C:\TEMP.GIF file saved

Agilent

R T

Freq/Channel

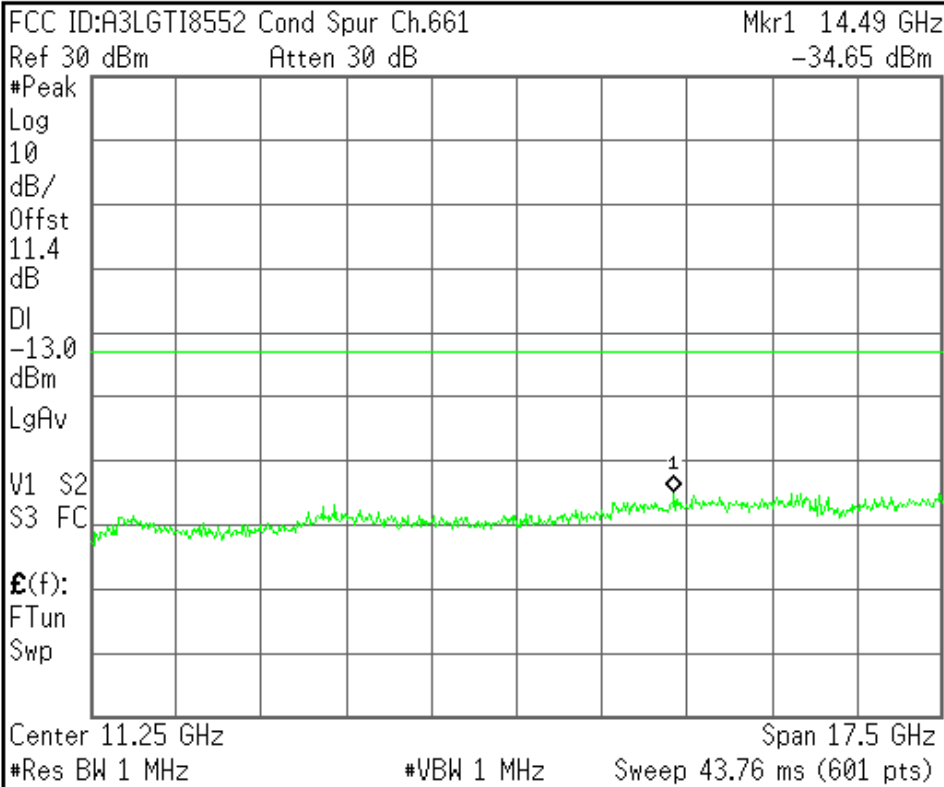

<b>Center Freq</b> 11.2500000 GHz
<b>Start Freq</b> 2.50000000 GHz
<b>Stop Freq</b> 20.0000000 GHz
<b>CF Step</b> Auto Man 1.75000000 GHz
<b>Freq Offset</b> 0.00000000 Hz
<b>Signal Track</b> On Off

File Operation Status, C:\TEMP.GIF file saved

Agilent

R T

Freq/Channel

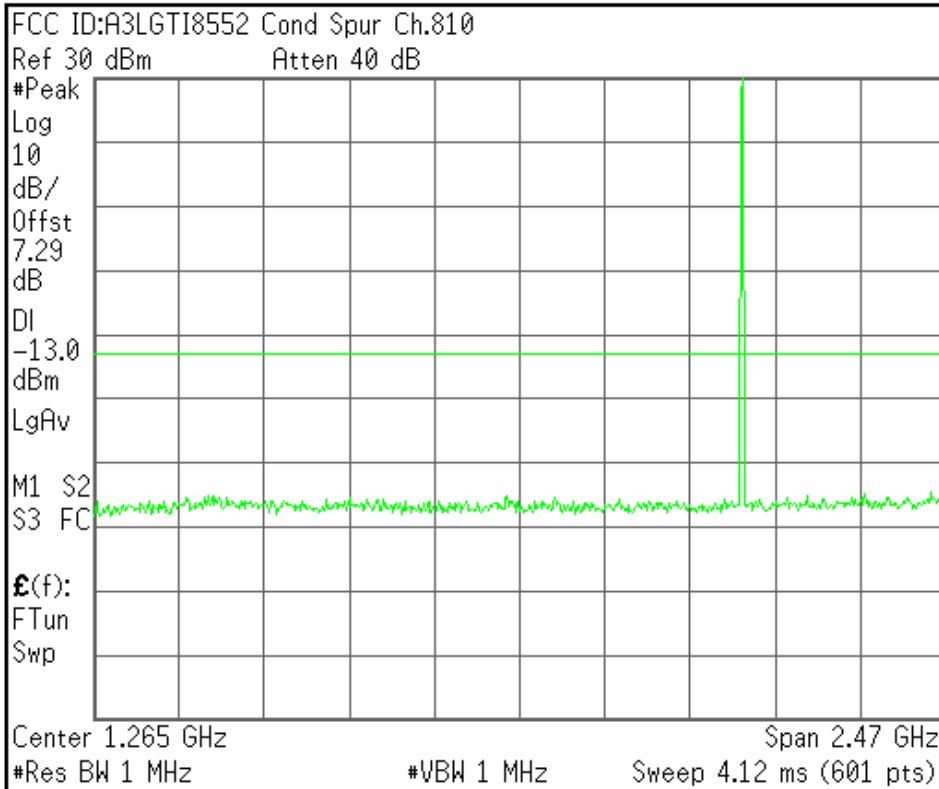

<b>Center Freq</b> 1.26500000 GHz
<b>Start Freq</b> 30.0000000 MHz
<b>Stop Freq</b> 2.50000000 GHz
<b>CF Step</b> 247.000000 MHz Auto Man
<b>Freq Offset</b> 0.00000000 Hz
<b>Signal Track</b> On Off

File Operation Status, C:\TEMP.GIF file saved

Agilent

R T

Freq/Channel

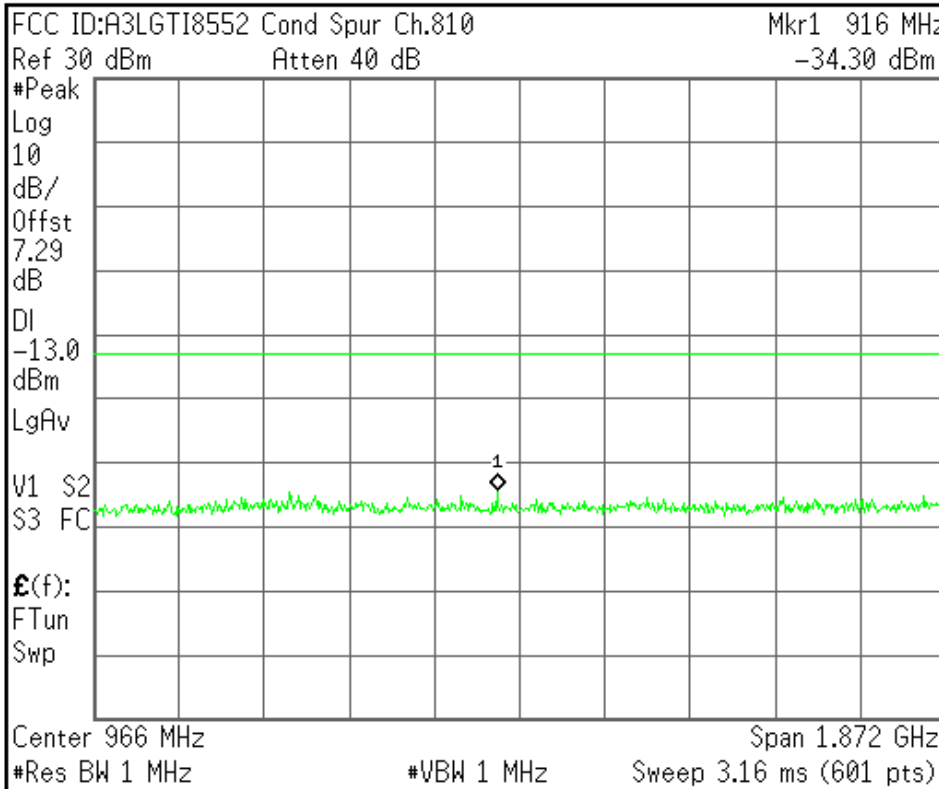

<b>Center Freq</b> 966.150000 MHz
<b>Start Freq</b> 30.0000000 MHz
<b>Stop Freq</b> 1.90230000 GHz
<b>CF Step</b> 187.230000 MHz Auto Man
<b>Freq Offset</b> 0.00000000 Hz
<b>Signal Track</b> On Off

File Operation Status, C:\TEMP.GIF file saved

Agilent

R T

Freq/Channel

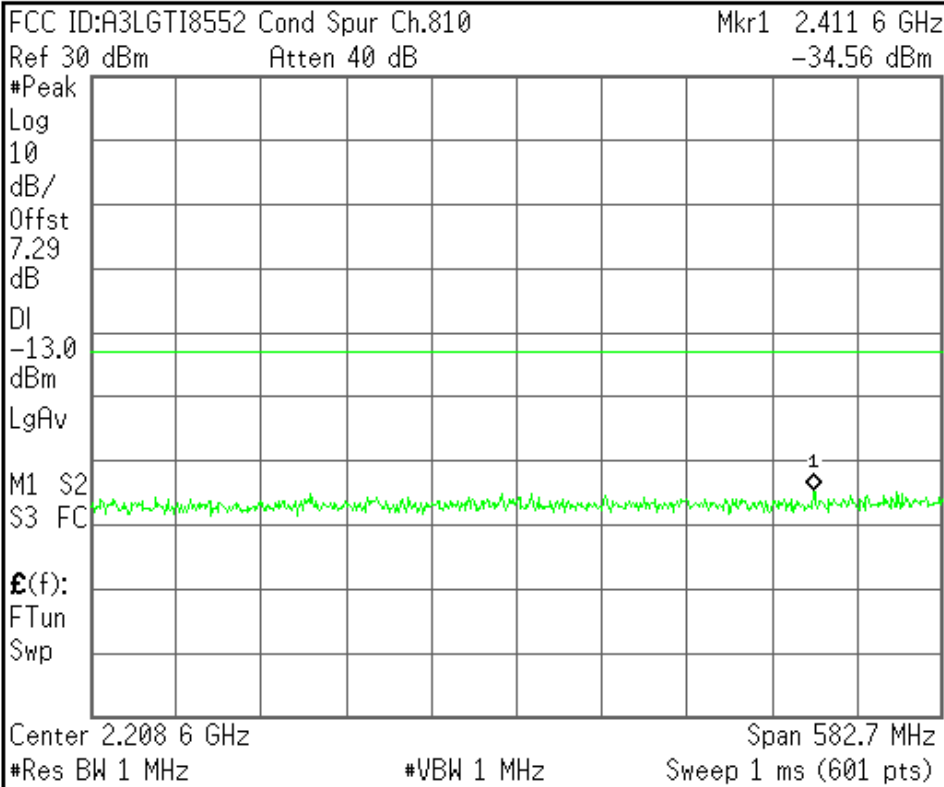

<b>Center Freq</b>	2.20865000 GHz
<b>Start Freq</b>	1.91730000 GHz
<b>Stop Freq</b>	2.50000000 GHz
<b>CF Step</b>	58.2700000 MHz Auto Man
<b>Freq Offset</b>	0.00000000 Hz
<b>Signal Track</b>	On Off

File Operation Status, C:\TEMP.GIF file saved

Agilent

R T

Freq/Channel

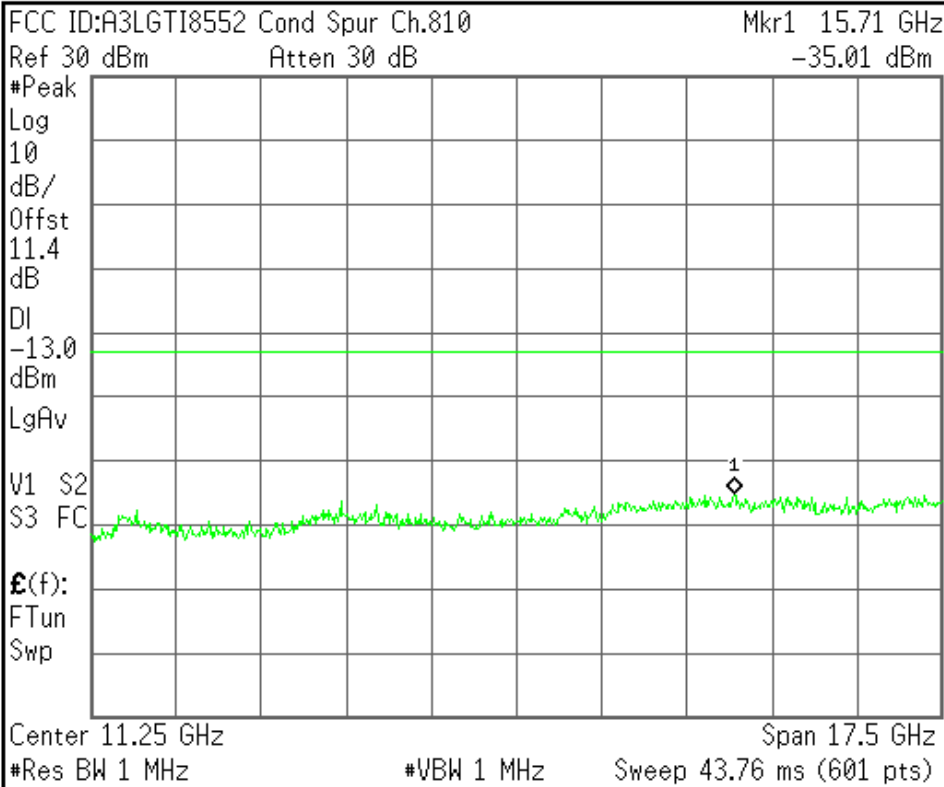

<b>Center Freq</b>	11.2500000 GHz
<b>Start Freq</b>	2.50000000 GHz
<b>Stop Freq</b>	20.0000000 GHz
<b>CF Step</b>	1.75000000 GHz Auto Man
<b>Freq Offset</b>	0.00000000 Hz
<b>Signal Track</b>	On Off

File Operation Status, C:\TEMP.GIF file saved

Agilent

R T

Freq/Channel

FCC ID:A3LGTI8552 Band Edge Ch.512

Ref 30 dBm Atten 40 dB

#Avg  
Log  
10  
dB/  
Offst  
7.29  
dB  
DI  
-13.0  
dBm  
PAvg  
M1 S2  
S3 FC  
E(f):  
f>50k  
Swp

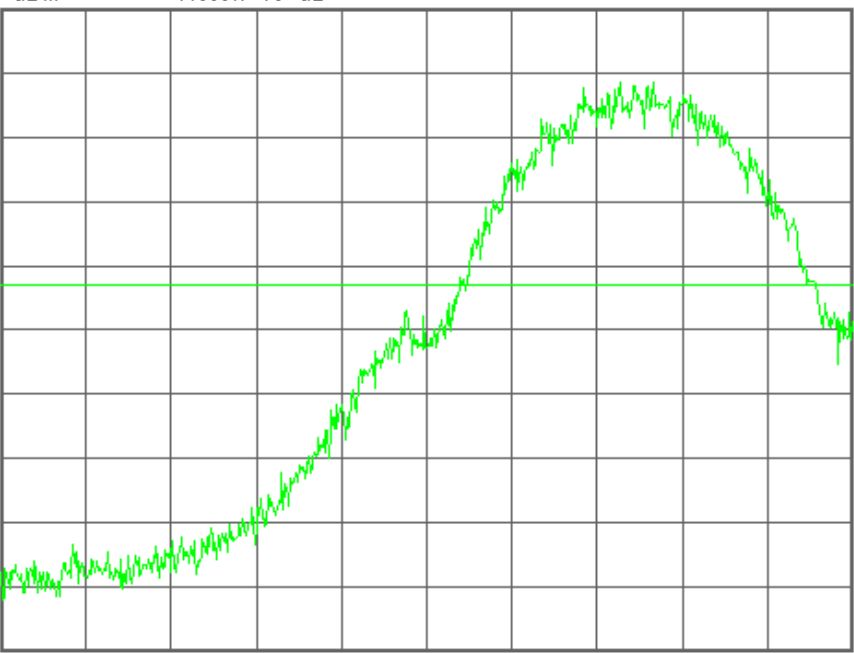

Center 1.850 000 0 GHz

Span 810 kHz

#Res BW 3 kHz

#VBW 3 kHz

Sweep 343.2 ms (601 pts)

Center Freq  
1.85000000 GHz

Start Freq  
1.84959500 GHz

Stop Freq  
1.85040500 GHz

CF Step  
81.0000000 kHz  
Auto Man

Freq Offset  
0.00000000 Hz

Signal Track  
On Off

File Operation Status, C:\TEMP.GIF file saved

Agilent

R T

Freq/Channel

FCC ID:A3LGTI8552 Band Edge Ch.512

Mkr1 1.849 974 6 GHz

Ref 30 dBm Atten 40 dB

-19.13 dBm

#Avg  
Log  
10  
dB/  
Offst  
7.29  
dB  
DI  
-13.0  
dBm  
PAvg  
M1 S2  
S3 FC  
E(f):  
f>50k  
Swp

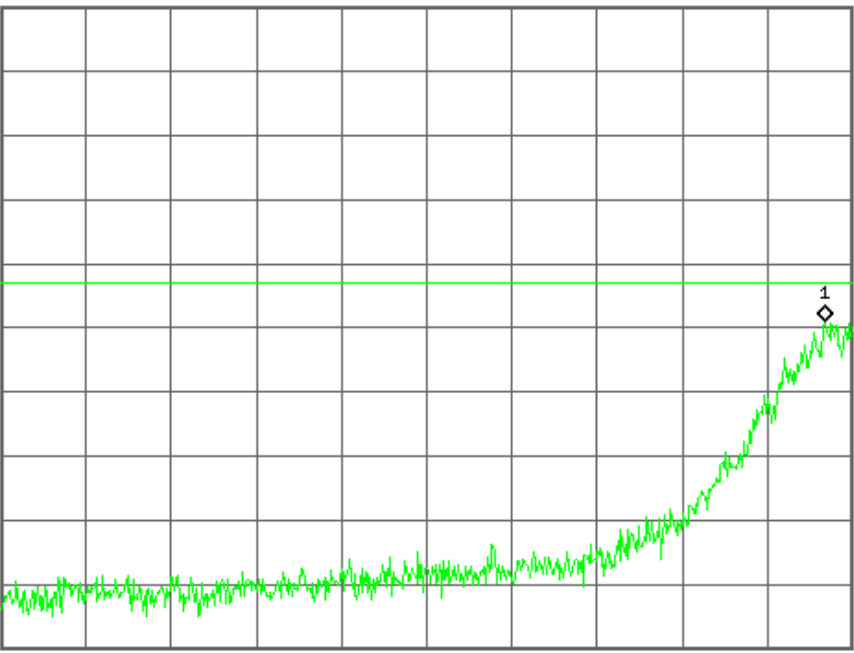

Center 1.849 595 0 GHz

Span 810 kHz

#Res BW 3 kHz

#VBW 3 kHz

Sweep 343.2 ms (601 pts)

Center Freq  
1.84959500 GHz

Start Freq  
1.84919000 GHz

Stop Freq  
1.85000000 GHz

CF Step  
81.0000000 kHz  
Auto Man

Freq Offset  
0.00000000 Hz

Signal Track  
On Off

File Operation Status, C:\TEMP.GIF file saved

Agilent

R T

Freq/Channel

FCC ID:A3LGTI8552 Band Edge Ch.810

Ref 30 dBm Atten 40 dB

#Avg

Log

10

dB/

Offst

7.29

dB

DI

-13.0

dBm

PAvg

M1 S2

S3 FC

$\mathcal{E}(f)$ :

f>50k

Swp

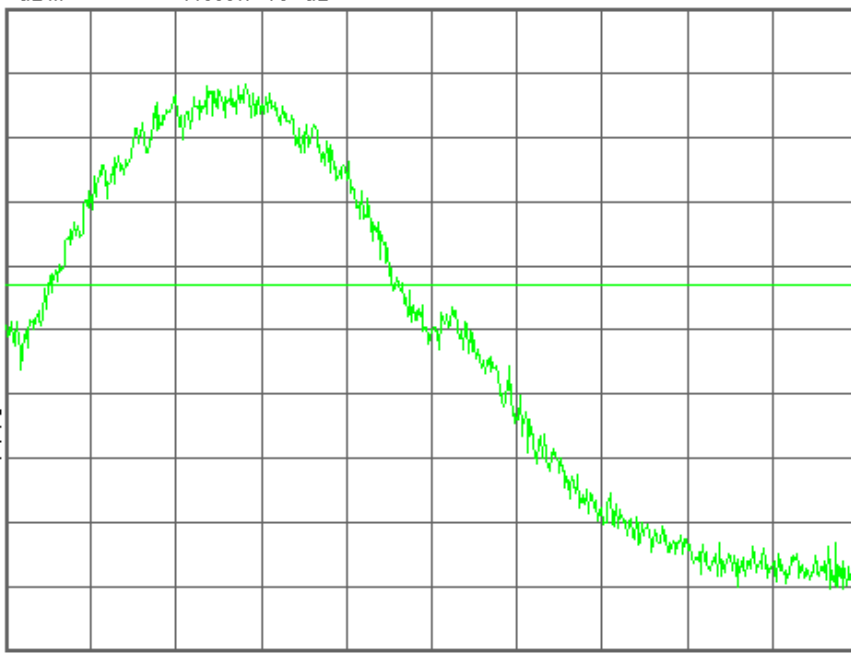

Center 1.910 000 0 GHz

Span 810 kHz

#Res BW 3 kHz

#VBW 3 kHz

Sweep 343.2 ms (601 pts)

Center Freq  
1.91000000 GHz

Start Freq  
1.90959500 GHz

Stop Freq  
1.91040500 GHz

CF Step  
81.0000000 kHz  
Auto Man

Freq Offset  
0.00000000 Hz

Signal Track  
On Off

File Operation Status, C:\TEMP.GIF file saved

Agilent

R T

Freq/Channel

FCC ID:A3LGTI8552 Band Edge Ch.810

Mkr1 1.910 021 8 GHz

Ref 30 dBm Atten 40 dB

-17.55 dBm

#Avg

Log

10

dB/

Offst

7.29

dB

DI

-13.0

dBm

PAvg

M1 S2

S3 FC

$\mathcal{E}(f)$ :

f>50k

Swp

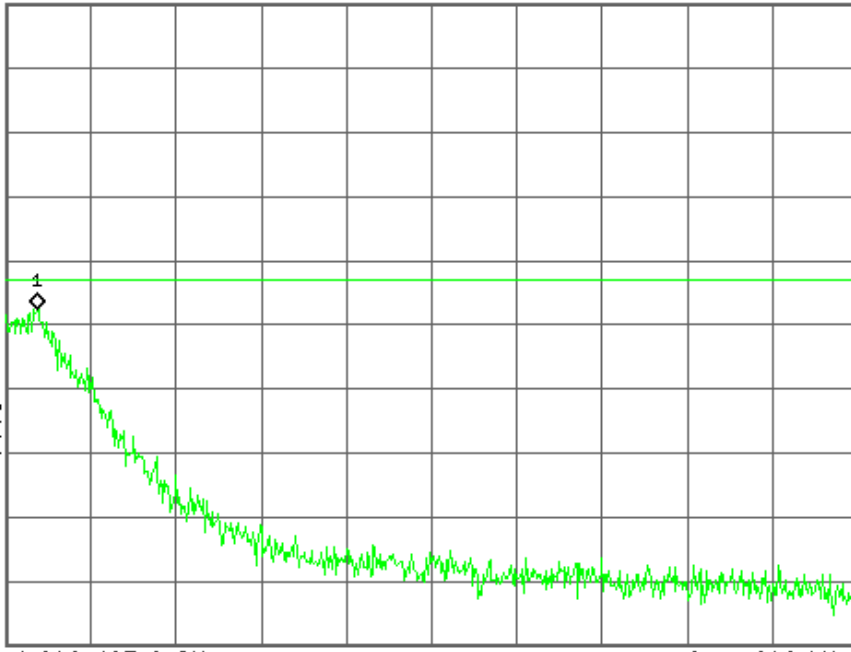

Center 1.910 405 0 GHz

Span 810 kHz

#Res BW 3 kHz

#VBW 3 kHz

Sweep 343.2 ms (601 pts)

Center Freq  
1.91040500 GHz

Start Freq  
1.91000000 GHz

Stop Freq  
1.91081000 GHz

CF Step  
81.0000000 kHz  
Auto Man

Freq Offset  
0.00000000 Hz

Signal Track  
On Off

File Operation Status, C:\TEMP.GIF file saved

Agilent

R T

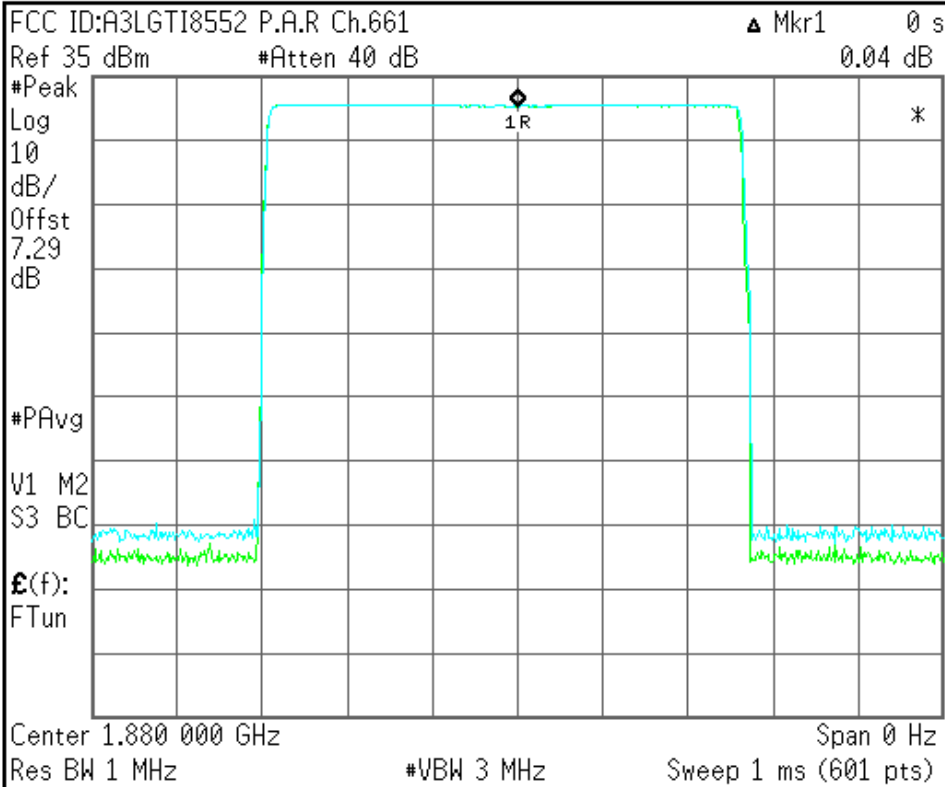

<b>Freq/Channel</b>
<b>Center Freq</b> 1.88000000 GHz
<b>Start Freq</b> 1.88000000 GHz
<b>Stop Freq</b> 1.88000000 GHz
<b>CF Step</b> 1.00000000 MHz Auto Man
<b>Freq Offset</b> 0.00000000 Hz
<b>Signal Track</b> On Off

File Operation Status, C:\TEMP.GIF file saved